

2015 **SUPER DUTY** Owner's Manual



fordowner.com



ford.ca

2015 **SUPER DUTY** Owner's Manual



November 2014  
Third Printing  
Owner's Manual  
Super Duty  
Litho in U.S.A.



FC3J19A321 AB



The information contained in this publication was correct at the time of going to print. In the interest of continuous development, we reserve the right to change specifications, design or equipment at any time without notice or obligation. No part of this publication may be reproduced, transmitted, stored in a retrieval system or translated into any language in any form by any means without our written permission. Errors and omissions excepted.

© Ford Motor Company 2014

All rights reserved.

Part Number: 20141017192716



# Table of Contents

---

## Introduction

About This Manual.....	7
Symbols Glossary.....	7
Data Recording.....	9
California Proposition 65.....	11
Perchlorate.....	11
Ford Credit.....	11
Replacement Parts Recommendation.....	12
Special Notices.....	12
Mobile Communications Equipment.....	13
Export Unique Options.....	14

## Child Safety

General Information.....	15
Installing Child Seats.....	16
Booster Seats.....	24
Child Seat Positioning.....	26
Child Safety Locks.....	27

## Safety Belts

Principle of Operation.....	28
Fastening the Safety Belts.....	29
Safety Belt Height Adjustment.....	32
Safety Belt Warning Lamp and Indicator Chime.....	32
Safety Belt Minder.....	33
Child Restraint and Safety Belt Maintenance.....	35

## Supplementary Restraints System

Principle of Operation.....	36
Driver and Passenger Airbags.....	37
Side Airbags.....	43
Safety Canopy™.....	44
Crash Sensors and Airbag Indicator.....	45
Airbag Disposal.....	46

## Keys and Remote Controls

General Information on Radio Frequencies.....	47
Remote Control.....	47
Replacing a Lost Key or Remote Control.....	50

## MyKey™

Principle of Operation.....	51
Creating a MyKey.....	51
Clearing All MyKeys.....	53
Checking MyKey System Status.....	53
Using MyKey With Remote Start Systems.....	55
MyKey Troubleshooting.....	55

## Locks

Locking and Unlocking.....	56
Keyless Entry.....	57

## Security

Passive Anti-Theft System.....	60
Anti-Theft Alarm.....	61

## Steering Wheel

Adjusting the Steering Wheel.....	62
Audio Control.....	62
Voice Control.....	63
Cruise Control.....	63
Information Display Control.....	63
Heated Steering Wheel.....	64

## Pedals

Adjusting the Pedals.....	65
---------------------------	----

## Wipers and Washers

Windshield Wipers.....	66
Windshield Washers.....	66

# Table of Contents

---

## Lighting

Lighting Control.....	67
Autolamps.....	67
Instrument Lighting Dimmer.....	68
Daytime Running Lamps.....	68
Front Fog Lamps.....	69
Direction Indicators.....	69
Interior Lamps.....	69

## Windows and Mirrors

Power Windows.....	71
Global Opening.....	72
Exterior Mirrors.....	72
Interior Mirror.....	74
Sun Visors.....	75
Moonroof.....	75

## Instrument Cluster

Gauges.....	77
Warning Lamps and Indicators.....	79
Audible Warnings and Indicators.....	82

## Information Displays

General Information.....	84
Information Messages.....	95

## Climate Control

Manual Climate Control.....	106
Automatic Climate Control.....	107
Hints on Controlling the Interior Climate.....	109
Heated Windows and Mirrors.....	111
Remote Start.....	112

## Seats

Sitting in the Correct Position.....	113
Head Restraints.....	113
Manual Seats.....	115
Power Seats.....	116

Memory Function.....	116
Rear Seats.....	117
Heated Seats.....	119
Climate Controlled Seats.....	121
Front Seat Armrest.....	122
Rear Seat Armrest.....	123

## Universal Garage Door Opener

Universal Garage Door Opener.....	124
-----------------------------------	-----

## Auxiliary Power Points

Auxiliary Power Points.....	132
-----------------------------	-----

## Storage Compartments

Center Console.....	134
Overhead Console.....	134

## Starting and Stopping the Engine

General Information.....	135
Ignition Switch.....	135
Starting a Gasoline Engine.....	136
Engine Block Heater.....	137

## Fuel and Refueling

Safety Precautions.....	139
Fuel Quality.....	140
Running Out of Fuel.....	141
Refueling.....	141
Fuel Consumption.....	143
Emission Control System.....	144

## Transmission

Automatic Transmission.....	147
Power Take-Off.....	152

## Four-Wheel Drive

Using Four-Wheel Drive.....	153
-----------------------------	-----

# Table of Contents

---

## Rear Axle

Limited Slip Differential.....	162
Electronic Locking Differential.....	162

## Brakes

General Information.....	164
Hints on Driving With Anti-Lock Brakes.....	164
Parking Brake.....	165
Hill Start Assist.....	165

## Traction Control

Principle of Operation.....	167
Using Traction Control.....	167

## Stability Control

Principle of Operation.....	169
Using Stability Control.....	169

## Terrain Response

Principle of Operation.....	172
Using Hill Descent Control.....	172

## Parking Aids

Parking Aid.....	174
Rear View Camera.....	175

## Cruise Control

Principle of Operation.....	178
Using Cruise Control.....	178

## Driving Aids

Steering.....	179
---------------	-----

## Load Carrying

Load Limit.....	180
Tailgate.....	187

## Towing

Towing a Trailer.....	191
Trailer Sway Control.....	192
Recommended Towing Weights.....	192
Essential Towing Checks.....	195
Towing Points.....	203
Transporting the Vehicle.....	204
Towing the Vehicle on Four Wheels.....	205

## Driving Hints

Breaking-In.....	207
Economical Driving.....	207
Driving Through Water.....	208
Floor Mats.....	208
Snowplowing.....	209

## Roadside Emergencies

Roadside Assistance.....	212
Hazard Warning Flashers.....	213
Fuel Shutoff.....	213
Jump Starting the Vehicle.....	214
Post-Crash Alert System.....	216

## Customer Assistance

Getting the Services You Need.....	217
In California (U.S. Only).....	218
The Better Business Bureau (BBB) Auto Line Program (U.S. Only).....	219
Utilizing the Mediation/Arbitration Program (Canada Only).....	219
Getting Assistance Outside the U.S. and Canada.....	220
Ordering Additional Owner's Literature.....	221
Reporting Safety Defects (U.S. Only).....	221
Reporting Safety Defects (Canada Only).....	222

## Fuses

Fuse Specification Chart.....	223
-------------------------------	-----

# Table of Contents

Changing a Fuse.....	231	Vehicle Storage.....	260
<b>Maintenance</b>		<b>Wheels and Tires</b>	
General Information.....	232	General Information.....	263
Opening and Closing the Hood.....	232	Tire Care.....	265
Under Hood Overview - 6.2L.....	233	Using Snow Chains.....	282
Under Hood Overview - 6.8L.....	234	Tire Pressure Monitoring System.....	283
Engine Oil Dipstick.....	235	Changing a Road Wheel.....	288
Engine Oil Check.....	235	Technical Specifications.....	299
Engine Coolant Check.....	236		
Automatic Transmission Fluid Check.....	240	<b>Capacities and Specific- ations</b>	
Transfer Case Fluid Check.....	242	Engine Specifications.....	301
Brake Fluid Check.....	243	Motorcraft Parts.....	302
Power Steering Fluid Check.....	243	Vehicle Identification Number.....	303
Washer Fluid Check.....	243	Vehicle Certification Label.....	303
Fuel Filter.....	243	Transmission Code Designation.....	304
Changing the 12V Battery.....	244	Technical Specifications.....	305
Checking the Wiper Blades.....	246		
Changing the Wiper Blades.....	246	<b>Audio System</b>	
Adjusting the Headlamps.....	246	General Information.....	310
Removing a Headlamp.....	248	Audio Unit - Vehicles With: AM/FM.....	311
Changing a Bulb.....	249	Audio Unit - Vehicles With: AM/FM/CD/ SYNC.....	312
Bulb Specification Chart.....	251	Audio Unit - Vehicles With: Sony AM/FM/ CD.....	315
Changing the Engine Air Filter.....	253	Digital Radio.....	316
		Satellite Radio.....	318
<b>Vehicle Care</b>		Audio Input Jack.....	321
General Information.....	255	USB Port.....	321
Cleaning Products.....	255	Media Hub.....	322
Cleaning the Exterior.....	255		
Waxing.....	256	<b>SYNC™</b>	
Cleaning the Engine.....	256	General Information.....	323
Cleaning the Windows and Wiper Blades.....	257	Using Voice Recognition.....	325
Cleaning the Interior.....	257	Using SYNC™ With Your Phone.....	327
Cleaning the Instrument Panel and Instrument Cluster Lens.....	257	SYNC™ Applications and Services.....	338
Cleaning Leather Seats.....	258	Using SYNC™ With Your Media Player.....	345
Repairing Minor Paint Damage.....	259	SYNC™ Troubleshooting.....	353
Cleaning the Alloy Wheels.....	260		

# Table of Contents

---

## **MyFord Touch™**

General Information.....	362
Settings.....	369
Entertainment.....	379
Phone.....	396
Information.....	402
Climate.....	411
Navigation.....	414
MyFord Touch™ Troubleshooting.....	422

## **Accessories**

Accessories.....	429
Auxiliary Switches.....	430

## **Appendices**

End User License Agreement.....	433
---------------------------------	-----

## **Extended Service Plan (ESP)**

Extended Service Plan (ESP).....	455
----------------------------------	-----

## **Scheduled Maintenance**

General Maintenance Information.....	457
Normal Scheduled Maintenance.....	460
Special Operating Conditions Scheduled Maintenance.....	461
Scheduled Maintenance Record.....	466





# Introduction

## ABOUT THIS MANUAL

Thank you for choosing Ford. We recommend that you take some time to get to know your vehicle by reading this manual. The more that you know about it, the greater the safety and pleasure you will get from driving it.

### WARNING



Driving while distracted can result in loss of vehicle control, crash and injury. We strongly recommend that you use extreme caution when using any device that may take your focus off the road. Your primary responsibility is the safe operation of your vehicle. We recommend against the use of any handheld device while driving and encourage the use of voice-operated systems when possible. Make sure you are aware of all applicable local laws that may affect the use of electronic devices while driving.

**Note:** This manual describes product features and options available throughout the range of available models, sometimes even before they are generally available. It may describe options not fitted to your vehicle.

**Note:** Some of the illustrations in this manual may show features as used in different models, so may appear different to you on your vehicle. However, the essential information in the illustrations is always correct.

**Note:** Always use and operate your vehicle in line with all applicable laws and regulations.

**Note:** Pass on this manual when selling your vehicle. It is an integral part of the vehicle.

**Note:** Either Ford Motor Company or an authorized Ford dealer may have originally sold this incomplete vehicle to a vehicle modifier who upfitted it. As a result, some of the options and features on this vehicle may differ from what we describe in this manual.

This manual may qualify the location of a component as left-hand side or right-hand side. The side is determined when facing forward in the seat.

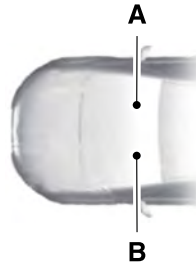

E154903

- A Right-hand side
- B Left-hand side

## Protecting the Environment

You must play your part in protecting the environment. Correct vehicle usage and the authorized disposal of waste, cleaning and lubrication materials are significant steps toward this aim.

## SYMBOLS GLOSSARY

These are some of the symbols you may see on your vehicle.



Safety alert



See Owner's Manual

# Introduction

---



Air conditioning system



Anti-lock braking system



Avoid smoking, flames or sparks



Battery



Battery acid



Brake fluid - non petroleum based



Brake system



Cabin air filter



Check fuel cap



Child safety door lock or unlock



Child seat lower anchor



Child seat tether anchor



Cruise control



Do not open when hot



Engine air filter



Engine coolant



Engine coolant temperature



Engine oil



Explosive gas



Fan warning



Fasten safety belt



Front airbag



Front fog lamps



Fuel pump reset



Fuse compartment



Hazard warning flashers



Heated rear window



Heated windshield



Interior luggage compartment release

# Introduction



Jack



Keep out of reach of children



Lighting control



Low tire pressure warning



Maintain correct fluid level



Note operating instructions



Panic alarm



Parking aid



Parking brake



Power steering fluid



Power windows front/rear



Power window lockout



Service engine soon



Side airbag



Shield the eyes



Stability control



Windshield wash and wipe

## DATA RECORDING

### Service Data Recording

Service data recorders in your vehicle are capable of collecting and storing diagnostic information about your vehicle. This potentially includes information about the performance or status of various systems and modules in the vehicle, such as engine, throttle, steering or brake systems. In order to properly diagnose and service your vehicle, Ford Motor Company, Ford of Canada, and service and repair facilities may access or share among them vehicle diagnostic information received through a direct connection to your vehicle when diagnosing or servicing your vehicle. Additionally, when your vehicle is in for service or repair, Ford Motor Company, Ford of Canada, and service and repair facilities may access or share among them data for vehicle improvement purposes. For U.S. only (if equipped), if you choose to use the SYNC Vehicle Health Report, you consent that certain diagnostic information may also be accessed electronically by Ford Motor Company and Ford authorized service facilities, and that the diagnostic information may be used for any purpose. See **SYNC™** (page 323).

# Introduction

---

## Event Data Recording

This vehicle is equipped with an event data recorder. The main purpose of an event data recorder is to record, in certain crash or near crash-like situations, such as an airbag deployment or hitting a road obstacle; this data will assist in understanding how a vehicle's systems performed. The event data recorder is designed to record data related to vehicle dynamics and safety systems for a short period of time, typically 30 seconds or less.

The event data recorder in this vehicle is designed to record such data as:

- How various systems in your vehicle were operating;
- Whether or not the driver and passenger safety belts were buckled/fastened;
- How far (if at all) the driver was depressing the accelerator and/or the brake pedal; and
- How fast the vehicle was traveling; and
- Where the driver was positioning the steering wheel.

This data can help provide a better understanding of the circumstances in which crashes and injuries occur.

**Note:** *Event data recorder data is recorded by your vehicle only if a non-trivial crash situation occurs; no data is recorded by the event data recorder under normal driving conditions and no personal data or information (e.g., name, gender, age, and crash location) is recorded (see limitations regarding 911 Assist and Traffic, directions and Information privacy below). However, parties, such as law enforcement, could combine the event data recorder data with the type of personally identifying data routinely acquired during a crash investigation.*

**To read data recorded by an event data recorder, special equipment is required, and access to the vehicle or the event data recorder is needed. In addition to the vehicle manufacturer, other parties, such as law enforcement, that have such special equipment, can read the information if they have access to the vehicle or the event data recorder. Ford Motor Company and Ford of Canada do not access event data recorder information without obtaining consent, unless pursuant to court order or where required by law enforcement, other government authorities or other third parties acting with lawful authority. Other parties may seek to access the information independently of Ford Motor Company and Ford of Canada.**

# Introduction

**Note:** *Including to the extent that any law pertaining to Event Data Recorders applies to SYNC or its features, please note the following: Once 911 Assist (if equipped) is enabled (set ON), 911 Assist may, through any paired and connected cell phone, disclose to emergency services that the vehicle has been in a crash involving the deployment of an airbag or, in certain vehicles, the activation of the fuel pump shut-off. Certain versions or updates to 911 Assist may also be capable of being used to electronically or verbally provide to 911 operators the vehicle location (such as latitude and longitude), and/or other details about the vehicle or crash or personal information about the occupants to assist 911 operators to provide the most appropriate emergency services. If you do not want to disclose this information, do not activate the 911 Assist feature. See SYNC™ (page 323).*

**Additionally, when you connect to Traffic, Directions and Information (if equipped, U.S. only), the service uses GPS technology and advanced vehicle sensors to collect the vehicle's current location, travel direction, and speed ("vehicle travel information"), only to help provide you with the directions, traffic reports, or business searches that you request. If you do not want Ford or its vendors to receive this information, do not activate the service. For more information, see Traffic, Directions and Information, Terms and Conditions. See SYNC™ (page 323).**

## CALIFORNIA PROPOSITION 65

### WARNING



Some constituents of engine exhaust, certain vehicle components, certain fluids contained in vehicles and certain products of component wear contain or emit chemicals known to the State of California to cause cancer and birth defects or other reproductive harm.

## PERCHLORATE

Certain components in your vehicle such as airbag modules, safety belt pretensioners and remote control batteries may contain perchlorate material. Special handling may apply for service or vehicle end of life disposal. For more information visit:

Web Address
<a href="http://www.dtsc.ca.gov/hazardouswaste/perchlorate">www.dtsc.ca.gov/hazardouswaste/perchlorate</a>

## FORD CREDIT

### (U.S. Only)

Ford Credit offers a full range of financing and lease plans to help you acquire your vehicle. If you have financed or leased your vehicle through Ford Credit, thank you for your business.

For your convenience we offer a number of ways to contact us, as well as to help manage your account.

Phone: 1-800-727-7000

For more information regarding Ford Credit, as well as to access Account Manager, please go to [www.fordcredit.com](http://www.fordcredit.com).

# Introduction

---

## REPLACEMENT PARTS RECOMMENDATION

Your vehicle has been built to the highest standards using quality parts. We recommend that you demand the use of genuine Ford and Motorcraft parts whenever your vehicle requires scheduled maintenance or repair. You can clearly identify genuine Ford and Motorcraft parts by looking for the Ford, FoMoCo or Motorcraft branding on the parts or their packaging.

## Scheduled Maintenance and Mechanical Repairs

One of the best ways for you to make sure that your vehicle provides years of service is to have it maintained in line with our recommendations using parts that conform to the specifications detailed in this Owner's Manual. Genuine Ford and Motorcraft parts meet or exceed these specifications.

## Collision Repairs

We hope that you never experience a collision, but accidents do happen. Genuine Ford replacement collision parts meet our stringent requirements for fit, finish, structural integrity, corrosion protection and dent resistance. During vehicle development we validate these parts deliver the intended level of protection as a whole system. A great way to know for sure you are getting this level of protection is to use genuine Ford replacement collision parts.

## Warranty on Replacement Parts

Genuine Ford and Motorcraft replacement parts are the only replacement parts that benefit from a Ford Warranty. Damage caused to your vehicle as a result of the failure of non-Ford parts may not be covered by the Ford Warranty. For additional information, refer to the terms and conditions of the Ford Warranty.

## SPECIAL NOTICES

### New Vehicle Limited Warranty

For a detailed description of what is covered and what is not covered by your vehicle's New Vehicle Limited Warranty, refer to the Warranty Manual that is provided to you along with your Owner's Manual.

### Special Instructions

For your added safety, your vehicle is fitted with sophisticated electronic controls.

#### WARNINGS



You risk death or serious injury to yourself and others if you do not follow the instruction highlighted by the warning symbol. Failure to follow the specific warnings and instructions could result in personal injury.



Front seat mounted rear-facing child or infant seats should **NEVER** be placed in front of an active passenger airbag.

---

## On-board Diagnostics (OBD-II)

Your vehicle's On-board Diagnostics (OBD-II) system has a data port for diagnostics, repair and reprogramming services with diagnostic scan tools. Installing a non-Ford-approved aftermarket OBD plug-in device that uses the port during normal driving, for example

# Introduction

---

remote insurance company monitoring, remote vehicle diagnostics, telematics or engine reprogramming, may cause interference or damage to vehicle systems. We do not recommend or endorse the use of any non-Ford-approved aftermarket OBD plug-in devices. The vehicle Warranty may not cover damage caused by any non-Ford-approved aftermarket OBD plug-in device.

## Using your Vehicle With a Snowplow

More information and guidelines for using your vehicle with a snowplow in this Owner's Manual. See **Snowplowing** (page 209).

## Using your Vehicle as an Ambulance

If your light truck is equipped with the Ford Ambulance Preparation Package, it may be utilized as an ambulance. Ford urges ambulance manufacturers to follow the recommendations of the Ford Incomplete Vehicle Manual, Ford Truck Body Builder's Layout Book and the Qualified Vehicle Modifiers (QVM) Guidelines as well as pertinent supplements. For additional information, please contact the Truck Body Builders Advisory Service at <http://www.fleet.ford.com/truckbbas/> and then by selecting Contact Us or by phone at 1-877-840-4338.

Use of your Ford light truck as an ambulance, without the Ford Ambulance Preparation Package voids the Ford New Vehicle Limited Warranty and may void the emissions warranties. In addition, ambulance usage without the preparation package could cause high underbody temperatures, overpressurized fuel and a risk of spraying fuel which could lead to fires.

If your vehicle is equipped with the Ford Ambulance Preparation Package, it will be indicated on the Safety Compliance Certification Label. The label is located on the driver's side door pillar or on the rear edge of the driver's door. You can determine whether the ambulance manufacturer followed Ford's recommendations by directly contacting that manufacturer. Ford Ambulance Preparation Package is only available on certain Diesel engine equipped vehicles.

## Using your Vehicle as a Stationary Power Source

Information and guidelines for operating a vehicle equipped with an aftermarket power take-off system can be found in this Owner's Manual. See **Power Take-Off** (page 152).

## MOBILE COMMUNICATIONS EQUIPMENT

Using mobile communications equipment is becoming increasingly important in the conduct of business and personal affairs. However, you must not compromise your own or others' safety when using such equipment. Mobile communications can enhance personal safety and security when appropriately used, particularly in emergency situations. Safety must be paramount when using mobile communications equipment to avoid negating these benefits. Mobile communication equipment includes, but is not limited to, cellular phones, pagers, portable email devices, text messaging devices and portable two-way radios.



# Introduction

---

## WARNING



Driving while distracted can result in loss of vehicle control, crash and injury. We strongly recommend that you use extreme caution when using any device that may take your focus off the road. Your primary responsibility is the safe operation of your vehicle. We recommend against the use of any hand-held device while driving and encourage the use of voice-operated systems when possible. Make sure you are aware of all applicable local laws that may affect the use of electronic devices while driving.

---

## EXPORT UNIQUE OPTIONS

For your particular global region, your vehicle may be equipped with features and options that are different from the features and options that are described in this Owner's Manual. A market unique supplement may be supplied that complements this book. By referring to the market unique supplement, if provided, you can properly identify those features, recommendations and specifications that are unique to your vehicle. This Owner's Manual is written primarily for the U.S. and Canadian Markets. Features or equipment listed as standard may be different on units built for Export. **Refer to this Owner's Manual for all other required information and warnings.**

# Child Safety

---

## GENERAL INFORMATION

See the following sections for directions on how to properly use safety restraints for children.

### WARNINGS



Always make sure your child is secured properly in a device that is appropriate for their height, age and weight. Child safety restraints must be bought separately from your vehicle. Failure to follow these instructions and guidelines may result in an increased risk of serious injury or death to your child.



All children are shaped differently. The recommendations for safety restraints are based on probable child height, age and weight thresholds from National Highway Traffic Safety Administration and other safety organizations, or are the minimum

### WARNINGS

requirements of law. Ford recommends checking with a NHTSA Certified Child Passenger Safety Technician (CPST) and consult your pediatrician to make sure your child seat is appropriate for your child, and is compatible with and properly installed in your vehicle. To locate a child seat fitting station and CPST, contact the NHTSA toll free at 1-888-327-4236 or go to <http://www.nhtsa.dot.gov>. In Canada, check with your local St. John Ambulance office for referral to a CPST or for further information, contact your provincial ministry of transportation, locate your local St. John Ambulance office by searching for St. John Ambulance on the internet, or Transport Canada at 1-800-333-0371 (<http://www.tc.gc.ca>). Failure to properly restrain children in safety seats made especially for their height, age, and weight may result in an increased risk of serious injury or death to your child.

---

# Child Safety

## Recommendations for Safety Restraints for Children

Child	Child size, height, weight, or age	Recommended restraint type
Infants or toddlers	Children weighing 40 lb (18 kg) or less (generally age four or younger).	Use a child safety seat (sometimes called an infant carrier, convertible seat, or toddler seat).
Small children	Children who have outgrown or no longer properly fit in a child safety seat (generally children who are less than 4 ft. 9 in. (1.45 m) tall, are greater than age four and less than age 12, and between 40 lb (18 kg) and 80 lb (36 kg) and upward to 100 lb (45 kg) if recommended by your child restraint manufacturer).	Use a belt-positioning booster seat.
Larger children	Children who have outgrown or no longer properly fit in a belt-positioning booster seat (generally children who are at least 4 ft. 9 in. (1.45 m) tall or greater than 80 lb (36 kg) or 100 lb (45 kg) if recommended by child restraint manufacturer).	Use a vehicle safety belt having the lap belt snug and low across the hips, shoulder belt centered across the shoulder and chest, and seat back upright.

- You are required by law to properly use safety seats for infants and toddlers in the United States and Canada.
- Many states and provinces require that small children use approved booster seats until they reach age eight, a height of 4 feet 9 inches (1.45 meters) tall, or 80 pounds (36 kilograms). Check your local and state or provincial laws for specific requirements about the safety of children in your vehicle.
- When possible, always properly restrain children 12 years of age and under in a rear seating position of your vehicle. Accident statistics suggest that children are safer when properly restrained in the rear seating positions than in a front seating position.

## INSTALLING CHILD SEATS

### Child Seats



E142594

# Child Safety

Use a child safety seat (sometimes called an infant carrier, convertible seat, or toddler seat) for infants, toddlers, or children weighing 40 pounds (18 kilograms) or less (generally age four or younger).

## Using Lap and Shoulder Belts

### WARNINGS



Airbags can kill or injure a child in a child seat. Never place a rear-facing child seat in front of an active airbag.

If you must use a forward-facing child seat in the front seat, move the seat upon which the child seat is installed all the way back.



Airbags can kill or injure a child in a child seat. Children 12 and under should be properly restrained in the rear seat whenever possible.



Depending on where you secure a child restraint, and depending on the child restraint design, you may block access to certain safety belt buckle assemblies and LATCH lower anchors, rendering those features potentially unusable. To avoid risk of injury, occupants should only use seating positions where they are able to be properly restrained.

When installing a child safety seat with combination lap and shoulder belts:

- Use the correct safety belt buckle for that seating position.
- Insert the belt tongue into the proper buckle until you hear a snap and feel it latch. Make sure the tongue is securely fastened in the buckle.
- Keep the buckle release button pointing up and away from the safety seat, with the tongue between the child seat and the release button, to prevent accidental unbuckling.

- Place the vehicle seat upon which the child seat will be installed in the upright position.
- This vehicle does not require the use of a locking clip.

Perform the following steps when installing the child seat with combination lap and shoulder belts:

**Note:** *Although the child seat illustrated is a forward facing child seat, the steps are the same for installing a rear facing child seat.*



E142528

1. Position the child safety seat in a seat with a combination lap and shoulder belt.



E142529

2. Pull down on the shoulder belt and then grasp the shoulder belt and lap belt together.

# Child Safety



E142530

3. While holding the shoulder and lap belt portions together, route the tongue through the child seat according to the child seat manufacturer's instructions. Be sure the belt webbing is not twisted.



E142875

5. To put the retractor in the automatic locking mode, grasp the shoulder portion of the belt and pull downward until all of the belt is pulled out.
6. Allow the belt to retract to remove slack. The belt will click as it retracts to indicate it is in the automatic locking mode.
7. Try to pull the belt out of the retractor to make sure the retractor is in the automatic locking mode (you should not be able to pull more belt out). If the retractor is not locked, unbuckle the belt and repeat Steps 5 and 6.

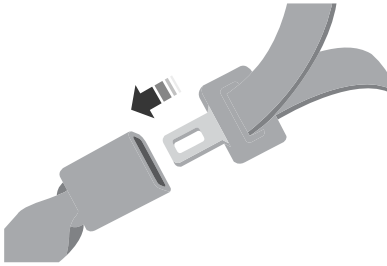

E142531

4. Insert the belt tongue into the proper buckle (the buckle closest to the direction the tongue is coming from) for that seating position until you hear a snap and feel the latch engage. Make sure the tongue is latched securely by pulling on it.



E142533

8. Remove remaining slack from the belt. Force the seat down with extra weight, for example, by pressing down or kneeling on the child restraint while pulling up on the shoulder belt in order to force slack from the belt. This is necessary to remove the remaining slack that will exist once the extra

# Child Safety

weight of the child is added to the child restraint. It also helps to achieve the proper snugness of the child seat to your vehicle. Sometimes, a slight lean toward the buckle will help to remove remaining slack from the belt.

9. Attach the tether strap (if the child seat is equipped).

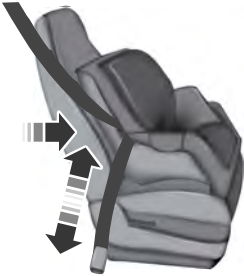

E142534

10. Before placing the child in the seat, forcibly move the seat forward and back to make sure the seat is securely held in place.

To check this, grab the seat at the belt path and attempt to move it side to side and forward and back. There should be no more than 1 inch (2.5 centimeters) of movement for proper installation.

Ford recommends checking with a NHTSA Certified Child Passenger Safety Technician to make certain the child restraint is properly installed. In Canada, check with your local St. John Ambulance office for referral to a Certified Passenger Seat Technician.

## Using Cinch Tongue Lap and Shoulder Belts (All Front Center, Super Cab and Crew Cab Rear Center Positions)

### WARNINGS



Airbags can kill or injure a child in a child seat. If you must use a forward-facing child seat in the front seat, move seat upon which the child seat is installed all the way back.



Rear facing child seats should never be placed in front of an active airbag.



Always use both lap and shoulder safety belt in the Regular Cab center seating position if applicable.

The belt webbing below the tongue is the lap portion of the combination lap and shoulder belt, and the belt webbing above the tongue is the shoulder belt portion of the combination lap and shoulder belt.



E142528

1. Position the child safety seat in the front center seat.

# Child Safety



E162708

2. Slide the tongue up the webbing.



E142530

3. While holding both shoulder and lap portions next to the tongue, route the tongue and webbing through the child seat according to the child seat manufacturer's instructions. Be sure that the belt webbing is not twisted.

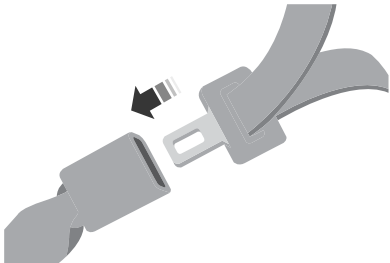

E142531

4. Insert the belt tongue into the proper buckle (the buckle closest to the direction the tongue is coming from) for that seating position until you hear a snap and feel the latch engage. Make sure the tongue is latched securely by pulling on it.



E142533

5. While pushing down with your knee on the child seat pull up on the shoulder belt portion to tighten the lap belt portion of the combination lap and shoulder belt.
6. Allow the safety belt to retract and remove any slack in the belt to securely tighten the child safety seat in the vehicle.
7. Attach the tether strap (if the child seat is equipped).

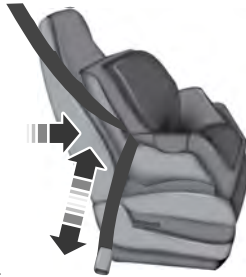

E142534

# Child Safety

- Before placing the child in the seat, forcibly move the seat forward and back to make sure the seat is securely held in place. To check this, grab the seat at the belt path and attempt to move it side to side and forward and back. There should be no more than 1 inch (2.5 centimeters) of movement for proper installation.
- Check from time to time to be sure that there is no slack in the lap and shoulder belt. The shoulder belt must be snug to keep the lap belt tight during a crash.

Ford recommends checking with a NHTSA Certified Child Passenger Safety Technician to make certain the child restraint is properly installed. In Canada, check with your local St. John Ambulance office for referral to a Child Passenger Safety Technician.

## Using Lower Anchors and Tethers for Children (LATCH)

The LATCH system is composed of three vehicle anchor points: two lower anchors located where the vehicle seatback and seat cushion meet (called the seat bight) and one top tether anchor located behind that seating position. Your vehicle is not equipped with the lower anchor points in the seat bight. For this vehicle, use the vehicle safety belt and upper tether to secure a child seat.

## Using Tether Straps

Many forward-facing child safety seats include a tether strap which extends from the back of the child safety seat and hooks to an anchoring point called the top tether anchor. Tether straps are available as an accessory for many older safety seats. Contact the manufacturer of your child seat for information about ordering a tether strap, or to obtain a longer tether strap if the tether strap on your safety seat does not reach the appropriate top tether anchor in the vehicle.

The passenger seats of your vehicle may be equipped with built-in tether strap anchors located behind the seats as described below.

The tether anchors in your vehicle may be straps on the seat back or an anchor bracket mounted to the body shell on the back panel.

The SuperCab rear seat has three straps behind the top of the seatback that function as both routing loops for the tether straps and anchor loops.

The tether strap anchors in your vehicle are in the following positions (shown from top view):

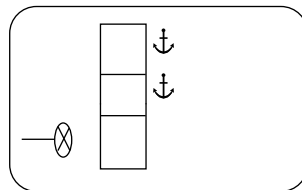
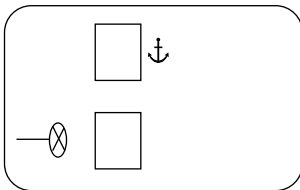

E162709



# Child Safety

## F-Series Regular Cab

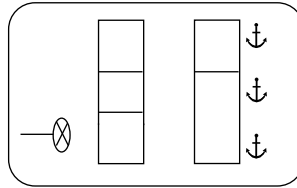
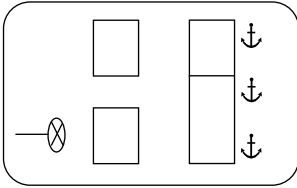

E162710

## F-Series SuperCab

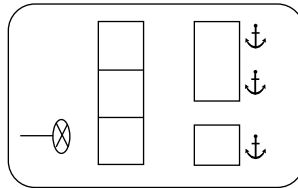
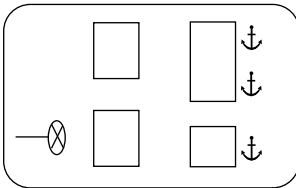

E162711

## F-Series Crew Cab

Attach the tether strap only to the appropriate tether anchor as shown. The tether strap may not work properly if attached somewhere other than the correct tether anchor.

Once the child safety seat has been installed using the safety belt, you can attach the top tether strap.

### Tether Strap Attachment

1. Route the child safety seat tether strap over the back of the seat.

**Note:** For vehicles with adjustable head restraints, route the tether strap under the head restraint and between the head restraint posts, otherwise route the tether strap over the top of the seat back. If the top of the safety seat hits the head restraint, raise the head restraint to let the child seat fit further rearward.

2. Locate the correct anchor for the selected seating position.
3. You may need to pull the seatback forward to access the tether anchors. Make sure the seat is locked in the upright position before installing the child seat.

# Child Safety



E162712

4. Remove the tether cover.
5. Clip the tether strap to the anchor as shown.



E162713

Front seats (Regular Cab) and Rear seats (Crew Cab)

If the tether strap is clipped incorrectly, the child safety seat may not be retained properly in the event of a crash.

6. Tighten the child safety seat tether strap according to the manufacturer's instructions.

If the safety seat is not anchored properly, the risk of a child being injured in a crash greatly increases.

If your child restraint system is equipped with a tether strap, and the child restraint manufacturer recommends its use, Ford also recommends its use.

## Tether Strap Attachment (Rear SuperCab Only)

There are three loops of webbing just above the back of the rear seat (along the bottom edge of the rear window) in the SuperCab. Use these loops as both routing loops and anchor loops for up to three child safety seat tether straps.

You can secure these straps below the back of the seat with rubber bands. To access, reach below the back of the seat and pull the tether loop out of the rubber band securing it.

Many tether straps cannot be tightened if the tether strap is hooked to the loop directly behind the child seat. To provide a tight tether strap:

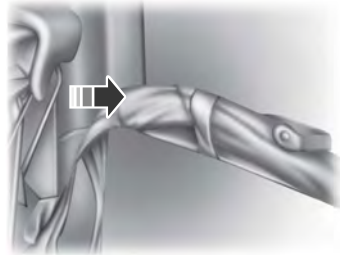

E162714

1. Route the tether strap through the loop directly behind the child seat.



E162715

# Child Safety

2. Attach the strap hook onto the loop behind an adjacent seating position.



E162716

3. Install the child safety seat tightly using the vehicle belts. Follow the instructions in this chapter.
4. Tighten the tether strap according to the child seat manufacturer's instructions.

You can use a single loop to route and anchor more than one child seat. For example, use the center loop as a routing loop for a child safety seat in the center rear seat and as an anchoring loop for child seats installed in the outboard rear seats.

## BOOSTER SEATS

### WARNING



Never place, or allow a child to place, the shoulder belt under a child's arm or behind the back because it reduces the protection for the upper part of the body and may increase the risk of injury or death in a crash.

Use a belt-positioning booster seat for children who have outgrown or no longer properly fit in a child safety seat (generally children who are less than 4 feet 9 inches (1.45 meters) tall, are greater than age four (4) and less than age twelve (12), and between 40 pounds (18 kilograms) and

80 pounds (36 kilograms) and upward to 100 pounds (45 kilograms) if recommended by your child restraint manufacturer). Many state and provincial laws require that children use approved booster seats until they reach age eight, a height of 4 feet 9 inches (1.45 meters) tall, or 80 pounds (36 kilograms).

Booster seats should be used until you can answer YES to ALL of these questions when seated without a booster seat:

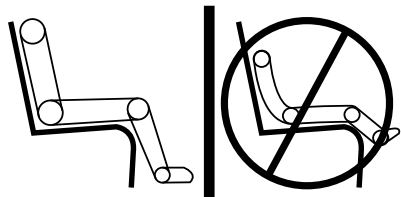

E142595

- Can the child sit all the way back against their vehicle seat back with knees bent comfortably at the edge of the seat cushion?
- Can the child sit without slouching?
- Does the lap belt rest low across the hips?
- Is the shoulder belt centered on the shoulder and chest?
- Can the child stay seated like this for the whole trip?

Always use booster seats in conjunction with your vehicle lap and shoulder belt.

# Child Safety

## Types of Booster Seats



E68924

- Backless booster seats

If your backless booster seat has a removable shield, remove the shield. If a vehicle seating position has a low seat back or no head restraint, a backless booster seat may place your child's head (as measured at the tops of the ears) above the top of the seat. In this case, move the backless booster to another seating position with a higher seat back or head restraint and lap and shoulder belts, or consider using a high back booster seat.



E70710

- High back booster seats

If, with a backless booster seat, you cannot find a seating position that adequately supports your child's head, a high back booster seat would be a better choice.

Children and booster seats vary in size and shape. Choose a booster that keeps the lap belt low and snug across the hips, never up across the stomach, and lets you adjust the shoulder belt to cross the chest and rest snugly near the center of the shoulder. The following drawings compare the ideal fit (center) to a shoulder belt uncomfortably close to the neck and a shoulder belt that could slip off the shoulder. The drawings also show how the lap belt should be low and snug across the child's hips.



E142596



# Child Safety



E142597

If the booster seat slides on the vehicle seat upon which it is being used, placing a rubberized mesh sold as shelf or carpet liner under the booster seat may improve this condition. Do not introduce any item thicker than this under the booster seat. Check with the booster seat manufacturer's instructions.

## CHILD SEAT POSITIONING

### WARNINGS



Airbags can kill or injure a child in a child seat. Never place a rear-facing child seat in front of an active airbag.

If you must use a forward-facing child seat in the front seat, move the vehicle seat upon which the child seat is installed all the way back. When possible, all children age 12 and under should be properly restrained in a rear seating position. If all children cannot be seated and restrained properly in a rear seating position, properly restrain the largest child in the front seat.



Always carefully follow the instructions and warnings provided by the manufacturer of any child restraint to determine if the restraint device is appropriate for your child's size, height, weight, or age. Follow the child restraint manufacturer's instructions and warnings provided for installation and use in conjunction with the instructions and

### WARNINGS

warnings provided by your vehicle manufacturer. A safety seat that is improperly installed or utilized, is inappropriate for your child's height, age, or weight or does not properly fit the child may increase the risk of serious injury or death.



Never let a passenger hold a child on his or her lap while your vehicle is moving. The passenger cannot protect the child from injury in a crash, which may result in serious injury or death.



Never use pillows, books, or towels to boost a child. They can slide around and increase the likelihood of injury or death in a crash.



Always restrain an unoccupied child seat or booster seat. These objects may become projectiles in a crash or sudden stop, which may increase the risk of serious injury.



Never place, or allow a child to place, the shoulder belt under a child's arm or behind the back because it reduces the protection for the upper part of the body and may increase the risk of injury or death in a crash.



To avoid risk of injury, do not leave children or pets unattended in your vehicle.

# Child Safety

## Recommendations for attaching child safety restraints for children

Restraint Type	Combined child and seat weight	Use any attachment method as indicated below by X				
		LATCH (lower anchors and top tether anchor)	LATCH (lower anchors only)	Safety belt and top tether anchor	Safety belt and LATCH (lower anchors and top tether anchor)	Safety belt only
Rear facing child seat	Up to 65 lb (29 kg)					X
Rear facing child seat	Over 65 lb (29 kg)					X
Forward facing child seat	Up to 65 lb (29 kg)			X		
Forward facing child seat	Over 65 lb (29 kg)			X		

**Note:** The child seat must rest tightly against the vehicle seat upon which it is installed. It may be necessary to lift or remove the head restraint. See **Head Restraints** (page 113).

## CHILD SAFETY LOCKS

When these locks are set, the rear doors cannot be opened from the inside.



E162719

The childproof locks are located on the rear edge of each rear door. You must set the lock separately for each door.

Move the lock control up or down to engage or disengage the childproof lock.

# Safety Belts

## PRINCIPLE OF OPERATION

### WARNINGS



Always drive and ride with the seat backrest upright and the lap belt snug and low across the hips.



To reduce the risk of injury, make sure children sit where they can be properly restrained.



Never let a passenger hold a child on his or her lap while your vehicle is moving. The passenger cannot protect the child from injury in a crash which may result in serious injury or death.



All occupants of the vehicle, including the driver, should always properly wear their safety belts, even when an airbag supplemental restraint system is provided. Failure to properly wear your safety belt could seriously increase the risk of injury or death.



It is extremely dangerous to ride in a cargo area, inside or outside of a vehicle. In a crash, people riding in these areas are more likely to be seriously injured or killed. Do not allow people to ride in any area of your vehicle that is not equipped with seats and safety belts. Be sure everyone in your vehicle is in a seat and using a safety belt properly.



In a rollover crash, an unbelted person is significantly more likely to die than a person wearing a safety belt.



Each seating position in your vehicle has a specific safety belt assembly which is made up of one buckle and one tongue that are designed to be used as a pair. 1) Use the shoulder belt on the outside shoulder only. Never wear the shoulder belt under the arm. 2) Never swing the safety belt around your neck over the inside shoulder. 3) Never use a single belt for more than one person.

### WARNINGS



When possible, all children 12 years old and under should be properly restrained in a rear seating position. Failure to follow this could seriously increase the risk of injury or death.



Safety belts and seats can become hot in a vehicle that has been closed up in sunny weather; they could burn a small child. Check seat covers and buckles before you place a child anywhere near them.



Front and rear seat occupants, including pregnant women, should wear safety belts for optimum protection in an accident.

All seating positions in this vehicle have lap and shoulder safety belts. All occupants of the vehicle should always properly wear their safety belts, even when an airbag supplemental restraint system is provided.

The safety belt system consists of:

- Lap and shoulder safety belts.
- Shoulder safety belt with automatic locking mode, (except driver safety belt).
- Height adjuster at the front outboard seating positions.
- Safety belt pretensioner at the front outboard seating positions.



- Safety belt warning light and chime.



- Crash sensors and monitoring system with readiness indicator.

# Safety Belts

The safety belt pretensioners at the front seating positions are designed to tighten the safety belts when activated. In frontal and near-frontal crashes, side crashes and rollovers, the safety belt pretensioners may be activated alone or, if the crash is of sufficient severity, together with the front airbags.

## FASTENING THE SAFETY BELTS

The front outboard and rear safety restraints in the vehicle are combination lap and shoulder belts.



E142587

1. Insert the belt tongue into the proper buckle (the buckle closest to the direction the tongue is coming from) until you hear a snap and feel it latch. Make sure the tongue is securely fastened in the buckle.

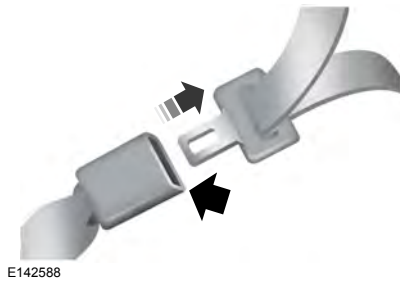

E142588

2. To unfasten, press the release button and remove the tongue from the buckle.

## Using the Safety Belt with Cinch Tongue (Front Center and Rear Center Seats Only)

The cinch tongue will slide up and down the belt webbing when the belt is stowed or while putting safety belts on. When the lap and shoulder safety belt is buckled, the cinch tongue will allow the lap portion to be shortened, but pinches the webbing to keep the lap portion from getting longer. The cinch tongue is designed to slip during a crash, so always wear the shoulder belt properly and do not allow any slack in either the lap or shoulder portions.

Before you can reach and latch a lap and shoulder belt having a cinch tongue into the buckle, you may have to lengthen the lap belt portion of it.



E162708

1. To lengthen the lap belt, pull some webbing out of the shoulder belt retractor.
2. While holding the webbing below the tongue, grasp the tip (metal portion) of the tongue so that it is parallel to the webbing and slide the tongue upward.
3. Provide enough lap belt length so that the tongue can reach the buckle.



# Safety Belts

## Fastening the Cinch Tongue

### WARNING



The lap belt should fit snugly and as low as possible around the hips, not across the waist.

1. Pull the lap and shoulder belt from the retractor so that the shoulder belt portion of the safety belt crosses your shoulder and chest.
2. Be sure the belt is not twisted. If the belt is twisted, remove the twist.
3. Insert the belt tongue into the proper buckle for your seating position until you hear a snap and feel it latch.
4. Make sure the tongue is securely fastened to the buckle by pulling on the tongue.

While you are fastened in the safety belt, the lap and shoulder belt with a cinch tongue adjusts to your movement. However, if you brake hard, turn hard, or if your vehicle receives an impact of 5.0 mph (8 km/h) or more, the safety belt will become locked and help reduce your forward movement.

## Using Safety Belts During Pregnancy

### WARNING



Always ride and drive with your seatback upright and the safety belt properly fastened. The lap portion of the safety belt should fit snug and be positioned low across the hips. The shoulder portion of the safety belt should be positioned across the chest. Pregnant women should also follow this practice. See the following figure.

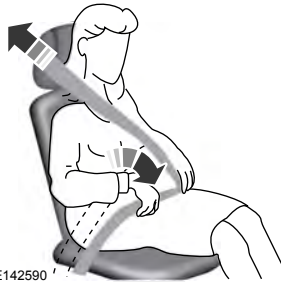

Pregnant women should always wear their safety belt. Position the lap belt portion of a combination lap and shoulder belt low across the hips below the belly and worn as tight as comfort will allow. Position the shoulder belt to cross the middle of the shoulder and the center of the chest.

## Safety Belt Locking Modes

### WARNINGS



After any vehicle crash, the safety belt system at all passenger seating positions must be checked by an authorized dealer to verify that the automatic locking retractor feature for child seats is still functioning properly. In addition, all safety belts should be checked for proper function.



The belt and retractor must be replaced if the safety belt assembly automatic locking retractor feature or any other safety belt function is not operating properly when checked by an authorized dealer. Failure to replace the belt and retractor assembly could increase the risk of injury in crashes.

# Safety Belts

All safety restraints in the vehicle are combination lap and shoulder belts. The driver safety belt has the first type of locking mode. The front outboard passenger and rear outboard seat safety belts have both types of locking modes described as follows:

## Vehicle Sensitive Mode

This is the normal retractor mode, which allows free shoulder belt length adjustment to your movements and locking in response to vehicle movement. For example, if the driver brakes suddenly or turns a corner sharply, or the vehicle receives an impact of about 5 mph (8 km/h) or more, the combination safety belts will lock to help reduce forward movement of the driver and passengers.

In addition, the retractor is designed to lock if the webbing is pulled out too quickly. If this occurs, let the belt retract slightly and pull webbing out again in a slow and controlled manner.

## Automatic Locking Mode

In this mode, the shoulder belt is automatically pre-locked. The belt will still retract to remove any slack in the shoulder belt. The automatic locking mode is not available on the driver safety belt.

## When to Use the Automatic Locking Mode

Use this mode any time a child safety seat, except a booster, is installed in passenger front or rear seating positions. You should properly restrain children 12 years old and under in a rear seating position whenever possible. See **Child Safety** (page 15).

## How to Use the Automatic Locking Mode



E142591

1. Buckle the combination lap and shoulder belt.
2. Grasp the shoulder portion and pull downward until the entire belt is pulled out.
3. Allow the belt to retract. As the belt retracts, you will hear a clicking sound. This indicates the safety belt is now in the automatic locking mode.

## How to Disengage the Automatic Locking Mode

Unbuckle the combination lap and shoulder belt and allow it to retract completely to disengage the automatic locking mode and activate the vehicle sensitive (emergency) locking mode.

## Safety Belt Extension Assembly

### WARNING



Do not use extensions to change the fit of the shoulder belt across the torso.

If the safety belt is too short when fully extended, you can obtain a safety belt extension assembly from an authorized dealer.

# Safety Belts

Use only extensions manufactured by the same supplier as the safety belt. Manufacturer identification is on a label located either at the end of the webbing or on the retractor behind the trim. Also, use the safety belt extension only if the safety belt is too short for you when fully extended.

## SAFETY BELT HEIGHT ADJUSTMENT

### WARNING



Position the safety belt height adjuster so that the belt rests across the middle of your shoulder. Failure to adjust the safety belt properly could reduce the effectiveness of the safety belt and increase the risk of injury in a crash.

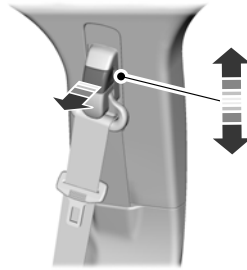

E145664

Adjust the height of the shoulder belt so the belt rests across the middle of your shoulder.

To adjust the shoulder belt height:

1. Pull the button and slide the height adjuster up or down.
2. Release the button and pull down on the height adjuster to make sure it is locked in place.

## SAFETY BELT WARNING LAMP AND INDICATOR CHIME



This lamp illuminates and an audible warning will sound if the driver's safety belt has not been fastened when the vehicle's ignition is turned on.

# Safety Belts

## Conditions of operation

<b>If...</b>	<b>Then...</b>
The driver's safety belt is not buckled before the ignition switch is turned to the on position...	The safety belt warning light illuminates 1-2 minutes and the warning chime sounds 4-8 seconds.
The driver's safety belt is buckled while the indicator light is illuminated and the warning chime is sounding...	The safety belt warning light and warning chime turn off.
The driver's safety belt is buckled before the ignition switch is turned to the on position...	The safety belt warning light and indicator chime remain off.

## SAFETY BELT MINDER

### Belt-Minder™

This feature supplements the safety belt warning function. It provides additional reminders by intermittently sounding a chime and illuminating the safety belt warning light when the driver's seat is occupied and the safety belt is unbuckled.

# Safety Belts

If...	Then...
The driver's safety belt is buckled before the ignition switch is turned to the on position or less than 1-2 minutes have elapsed since the ignition switch has been turned to on...	The Belt-Minder feature will not activate.
The driver's safety belt is not buckled when the vehicle has reached at least 6 mph (9.7 km/h) and 1-2 minutes have elapsed since the ignition switch has been turned to on...	The Belt-Minder feature is activated - the safety belt warning light illuminates and the warning chime sounds for six seconds every 25 seconds, repeating for about five minutes or until the safety belts are buckled.
The driver's safety belt becomes unbuckled for about one minute while the vehicle is traveling at least 6 mph (9.7 km/h) and more than 1-2 minutes have elapsed since the ignition switch has been turned to on...	The Belt-Minder feature is activated - the safety belt warning light illuminates and the warning chime sounds for six seconds every 25 seconds, repeating for about five minutes or until the safety belts are buckled.

## Deactivating and Activating the Belt-Minder Feature (Driver Only)

### WARNING



While the system allows you to deactivate it, this system is designed to improve your chances of being safely belted and surviving an accident. We recommend you leave the system activated for yourself and others who may use the vehicle. To reduce the risk of injury, do not deactivate or activate the system while driving the vehicle.

**Note:** *If you are using MyKey, you cannot disable the Belt-Minder. Also, if the Belt-Minder has been previously disabled, it will be re-enabled during the use of MyKey. See **MyKey™** (page 51).*

Read Steps 1 - 4 thoroughly before proceeding with the programming procedure.

Deactivate or activate the system by performing the following procedure:

Before following the procedure, make sure that:

- The parking brake is set.
  - The transmission is in park (P).
  - The ignition is off.
  - All vehicle doors are closed.
  - The driver's safety belt is unbuckled.
1. Turn the ignition on. Do not start the engine.
  2. Wait until the safety belt warning light turns off (about one minute). Step 3 must be completed within 30 seconds after the safety belt warning light turns off.
  3. Buckle then unbuckle the safety belt three times at a moderate speed, ending with the safety belt in the unbuckled state. After Step 3, the safety belt warning light will turn on.

# Safety Belts

---

4. While the safety belt warning light is on, buckle then unbuckle the safety belt. After Step 4, the safety belt warning light will flash for confirmation.
  - This will disable the feature if it is currently enabled.
  - This will enable the feature if it is currently disabled.

## CHILD RESTRAINT AND SAFETY BELT MAINTENANCE

Inspect the vehicle safety belts and child safety seat systems periodically to make sure they work properly and are not damaged. Inspect the vehicle and child seat safety belts to make sure there are no nicks, tears or cuts. Replace if necessary. All vehicle safety belt assemblies, including retractors, buckles, front safety belt buckle assemblies, buckle support assemblies (slide bar-if equipped), shoulder belt height adjusters (if equipped), shoulder belt guide on seat back (if equipped), child safety seat LATCH and tether anchors, and attaching hardware, should be inspected after a crash. Read the child restraint manufacturer's instructions for additional inspection and maintenance information specific to the child restraint.

Ford Motor Company recommends that all safety belt assemblies in use in vehicles involved in a crash be replaced. However, if the crash was minor and an authorized dealer finds that the belts do not show damage and continue to operate properly, they do not need to be replaced. Safety belt assemblies not in use during a crash should also be inspected and replaced if either damage or improper operation is noted.

Properly care for safety belts. See **Vehicle Care** (page 255).

# Supplementary Restraints System

---

## PRINCIPLE OF OPERATION

### WARNINGS

 Airbags do not inflate slowly or gently, and the risk of injury from a deploying airbag is the greatest close to the trim covering the airbag module.

 All occupants of your vehicle, including the driver, should always properly wear their safety belts, even when an airbag supplemental restraint system is provided. Failure to properly wear your safety belt could seriously increase the risk of injury or death.

 Always transport children 12 years old and under in the back seat and always properly use appropriate child restraints. Failure to follow this could seriously increase the risk of injury or death.

 Never place your arm over the airbag module as a deploying airbag can result in serious arm fractures or other injuries.

 Airbags can kill or injure a child in a child seat. Never place a rear-facing child seat in front of an active airbag. If you must use a forward-facing child seat in the front seat, move the seat upon which the child seat is installed all the way back.

 Do not attempt to service, repair, or modify the airbag supplemental restraint systems or its fuses as you could be seriously injured or killed. Contact your authorized dealer as soon as possible.

 Several airbag system components get hot after inflation. To avoid risk of injury, do not touch them after inflation.

 If the airbag has deployed, the airbag will not function again and must be replaced immediately. If the airbag is not replaced, the unrepaired area will increase the risk of injury in a crash.

---

The airbags are a supplemental restraint system and are designed to work with the safety belts to help protect the driver and right front passenger from certain upper body injuries. Airbags do not inflate slowly; there is a risk of injury from a deploying airbag.

**Note:** *You will hear a loud bang and see a cloud of harmless powdery residue if an airbag deploys. This is normal.*

The airbags inflate and deflate rapidly upon activation. After airbag deployment, it is normal to notice a smoke-like, powdery residue or smell the burnt propellant. This may consist of cornstarch, talcum powder (to lubricate the bag) or sodium compounds (for example, baking soda) that result from the combustion process that inflates the airbag. Small amounts of sodium hydroxide may be present which may irritate the skin and eyes, but none of the residue is toxic.

While the system is designed to help reduce serious injuries, contact with a deploying airbag may also cause abrasions or swelling. Temporary hearing loss is also a possibility as a result of the noise associated with a deploying airbag. Because airbags must inflate rapidly and with considerable force, there is the risk of death or serious injuries such as fractures, facial and eye injuries or internal injuries, particularly to occupants who are not properly restrained or are otherwise out of position at the time of airbag deployment. Thus, it is extremely important that occupants be properly restrained as far away from the airbag module as possible while maintaining vehicle control.

Routine maintenance of the airbags is not required.

# Supplementary Restraints System

## DRIVER AND PASSENGER AIRBAGS

### WARNINGS



Never place your arm or any objects over an airbag module. Placing your arm over a deploying airbag can result in serious arm fractures or other injuries. Objects placed on or over the airbag inflation area may cause those objects to be propelled by the airbag into your face and torso causing serious injury.



Airbags can kill or injure a child in a child seat. Never place a rear-facing child seat in front of an active airbag. If you must use a forward-facing child seat in the front seat, move the seat upon which the child seat is installed all the way back.

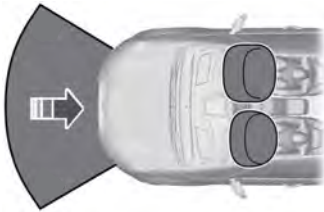

E151127

The driver and front passenger airbags will deploy during significant frontal and near frontal crashes.

The driver and passenger front airbag system consists of:

- Driver and passenger airbag modules.



• Crash sensors and monitoring system with readiness indicator. See **Crash Sensors and Airbag Indicator** (page 45).

## Driver and Front Passenger Seating Adjustment

### WARNING



National Highway Traffic Safety Administration (NHTSA) recommends a minimum distance of at least 10 in (25 cm) between a passenger's chest and the driver airbag module.

To correctly position yourself away from the airbag:

- Move your seat to the rear as far as you can while still reaching the pedals comfortably.
- Recline the seat slightly (one or two degrees) from the upright position.

After all passengers have correctly adjusted their seats and put on safety belts, it is very important that they continue to sit correctly. A correctly seated passenger sits upright, leans against the seat backrest, and in the center of the seat cushion, with their feet comfortably extended on the floor. Sitting incorrectly can increase the chance of injury in a crash event. For example, if a passenger slouches, lies down, turns sideways, sits forward, leans forward or sideways, or puts one or both feet up, the chance of injury during a crash is greatly increased.

## Passenger Airbag On and Off Switch (If Equipped)

### WARNINGS





Even with Advanced Restraints Systems, children who are 12 years and under should be correctly restrained in a rear seating position. Failure to follow this can increase the risk of serious injury or death in a crash.



# Supplementary Restraints System

## WARNINGS

 The front passenger airbag is not designed to offer protection to a passenger in the center seating position.

 An airbag ON and OFF switch may be installed in this vehicle. Before driving, always look at the face of the switch to be sure the switch is in the correct position in accordance with these instructions and warnings. Failure to put the switch in a correct position can increase the risk of serious injury or death in a crash.

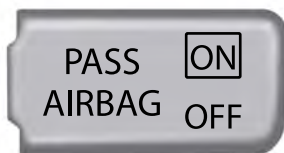

E162720

### High-series vehicles (if equipped)

The front passenger airbag on and off switch has indicators that will illuminate, indicating that the front passenger frontal airbag is either on or off. The indicator lamp is located by the radio.

**Note:** *The passenger airbag status indicator OFF and ON lamps will illuminate for a short period of time when the ignition is first turned on to confirm it is functional.*

Switch position	Passenger airbag status indicator	Passenger airbag
Off	OFF: Lit	Disabled
	ON: Unlit	
On	OFF: Unlit	Enabled
	ON: Lit	

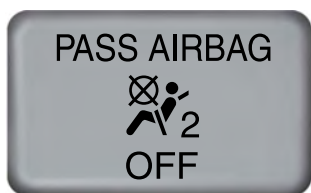

E162721

### Low-series vehicles (if equipped)

The front passenger airbag on and off switch has an indicator that will illuminate and stay lit to remind you that the front passenger frontal airbag is off. The indicator lamp is located by the radio.

**Note:** *The indicator lamp will illuminate for a short period of time when the ignition is first turned on to confirm it is functional.*

### Turning the Passenger Airbag Off

#### WARNINGS

 If the light fails to illuminate when the passenger airbag switch is off and the ignition is on, have the passenger airbag switch serviced at your authorized dealer immediately.

 In order to avoid inadvertent activation of the switch, always remove the ignition key from the passenger airbag on and off switch.

# Supplementary Restraints System

## WARNINGS



An infant in a rear-facing seat faces a high risk of serious or fatal injuries from a deploying passenger airbag. Rear facing infant seats should never be placed in the front seats, unless the passenger airbag is turned off.

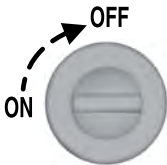

E162722

### PASSENGER AIRBAG

1. Insert the ignition key, turn the switch to OFF and hold in OFF while removing the key.
2. When the ignition is turned on, the pass airbag off light illuminates briefly, momentarily shuts off and then turns back on. This indicates that the passenger airbag is deactivated.

### Turning the Passenger Airbag Back On

## WARNINGS



The safety belts for the driver and right front passenger seating positions have been specifically designed to function together with the airbags in certain types of crashes. When you turn off your airbag, you not only lose the protection of the airbag, you also may reduce the effectiveness of your safety belt system, which was designed to work with the airbag. If you are not a passenger who meets the requirements stated in the National Highway Traffic Safety Administration or Transport Canada deactivation criteria turning off the airbag can increase the risk of serious injury or death in a crash.

## WARNINGS



If your vehicle has rear seats, always transport children who are 12 years and under in the rear seat. Always use safety belts and child restraints correctly. Do not place a child in a rear facing infant seat in the front seat unless your vehicle is equipped with an airbag on and off switch and the passenger airbag is turned off. This is because the back of the infant seat is too close to the inflating airbag and the risk of a fatal injury to the infant when the airbag inflates is substantial.



If the pass airbag off light is illuminated when the passenger airbag switch is on and the ignition is on, have the passenger airbag switch serviced at your authorized dealer immediately.

The passenger airbag remains off until you turn it back on.

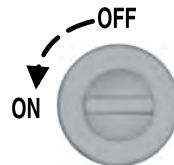

E162723

### PASSENGER AIRBAG

1. Insert the ignition key and turn the switch to ON.
2. The pass airbag off light will briefly illuminate when the ignition is turned to on. This indicates that the passenger airbag is operational.

The passenger side airbag should always be on (the pass airbag off light should not be illuminated) unless the passenger meets the requirements stated either in Category 1, 2 or 3 of the National Highway Traffic Safety Administration or Transport Canada deactivation criteria which follows.

# Supplementary Restraints System

The vast majority of drivers and passengers are much safer with an airbag than without. To do their job and reduce the risk of life threatening injuries, airbags must open with great force, and this force can pose a potentially deadly risk in some situations, particularly when a front seat passenger is not using the safety belt correctly. The most effective way to reduce the risk of unnecessary airbag injuries without reducing the overall safety of your vehicle is to make sure all passengers are correctly restrained in the vehicle, especially in the front seat. This provides the protection of safety belts and permits the airbags to provide the additional protection they were designed to provide. If you choose to deactivate your airbag, you are losing the very significant risk reducing benefits of the airbag and you are also reducing the effectiveness of the safety belts, because safety belts in modern vehicles are designed to work as a safety system with the airbags.

## National Highway Traffic Safety Administration Deactivation Criteria (Excluding Canada)

### WARNING



This vehicle has special energy management safety belts for the driver and right front passenger. These particular belts are specifically designed to work with airbags to help reduce the risk of injury in a crash. The energy management safety belt is designed to give or release additional belt webbing in some accidents to reduce concentration of force on a passenger's chest and reduce the risk of certain bone fractures and injuries to underlying organs. In a crash, if the airbag is turned off, this energy management safety belt might permit the passenger wearing the safety belt to move forward enough to incur a serious or fatal injury. The more severe the crash, and the heavier the passenger, the greater the risk is. Be sure the airbag is turned on for any passenger who does not qualify under the National Highway Traffic Safety Administration deactivation criteria.

1. **Infant.** An infant (less than 1 year old) must ride in the front seat because:

- The vehicle has no rear seat.
- The vehicle has a rear seat too small to accommodate a rear-facing infant seat.
- The infant has a medical condition which, according to the infant's physician, makes it necessary for the infant to ride in the front so that the driver can constantly monitor the child's condition.

2. **Child age 1 to 12.** A child age 1 to 12 must ride in the front seat because:

# Supplementary Restraints System

- The vehicle has no rear seat.
- Although children ages 1 to 12 ride in the rear seat(s) whenever possible, children ages 1 to 12 sometimes must ride in the front because no space is available in the rear seat(s) of the vehicle.
- The child has a medical condition which, according to the child's physician, makes it necessary for the child to ride in the front seat so that the driver can constantly monitor the child's condition.

**3. Medical condition.** A passenger has a medical condition which, according to his or her physician:

- Causes the passenger airbag to pose a special risk for the passenger.
- Makes the potential harm from the passenger airbag in a crash greater than the potential harm from turning off the airbag and allowing the passenger, even if belted, to hit the dashboard or windshield in a crash.

## Transport Canada Deactivation Criteria (Canada Only)

### WARNING



This vehicle has special energy management safety belts for the driver and right front passenger. These particular belts are specifically designed to work with airbags to help reduce the risk of injury in a crash. The energy management safety belt is designed to give or release additional belt webbing in some accidents to reduce concentration of force on a passenger's chest and reduce the risk of certain bone fractures and injuries to underlying organs. In a crash, if the airbag is turned off, this energy management safety belt might permit the passenger wearing the safety belt to move forward enough to incur a serious or fatal injury. The more severe the crash, and the heavier the passenger, the greater the risk is. Be sure the airbag is turned on for any passenger who does not qualify under the National Highway Traffic Safety Administration deactivation criteria.

**1. Infant:** An infant (less than 1 year old) must ride in the front seat because:

- My vehicle has no rear seat.
- The rear seat in my vehicle cannot accommodate a rear-facing infant seat.
- The infant has a medical condition which, according to the infant's physician, makes it necessary for the infant to ride in the front seat so that the driver can monitor the infant's condition.

**2. Child age 12 or under:** A child age 12 or under must ride in the front seat because:

# Supplementary Restraints System

- My vehicle has no rear seat.
- Although children age 12 and under ride in the rear seat whenever possible, children age 12 and under have no option but to sometimes ride in the front seat because rear seat space is insufficient.
- The child has a medical condition that, according to the child's physician, makes it necessary for the child to ride in the front seat so that the driver can monitor the child's condition.

3. **Medical condition:** A passenger has a medical condition that, according to his or her physician:

- Poses a special risk for the passenger if the airbag deploys.
- Makes the potential harm from the passenger airbag deployment greater than the potential harm from turning off the airbag and experiencing a crash without the protection offered by the airbag.

## Driver and Front Passenger Seating Adjustment

### WARNING



The National Highway Traffic Safety Administration recommends a minimum distance of at least 10 inches (25 centimeters) between a passenger's chest and the driver airbag module.

To correctly position yourself away from the airbag:

- Move your seat to the rear as far as you can while still reaching the pedals comfortably.
- Recline the seat slightly (one or two degrees) from the upright position.

After all passengers have correctly adjusted their seats and put on safety belts, it is very important that they continue to sit correctly. A correctly seated passenger sits upright, leans against the seat backrest, and in the center of the seat cushion, with their feet comfortably extended on the floor. Sitting incorrectly can increase the chance of injury in a crash event. For example, if a passenger slouches, lies down, turns sideways, sits forward, leans forward or sideways, or puts one or both feet up, the chance of injury during a crash is greatly increased.

## Children and Airbags

### WARNING



Airbags can kill or injure a child in a child seat. Never place a rear-facing child seat in front of an active airbag. If you must use a forward-facing child seat in the front seat, move the seat upon which the child seat is installed all the way back.



E142846

Children must always be correctly restrained. Accident statistics suggest that children are safer when correctly restrained in the rear seating positions than in the front seating position. Failure to follow these instructions may increase the risk of injury in a crash.

# Supplementary Restraints System

If two adults and a child occupy a Regular Cab, correctly restrain the child in the center front unless doing so would interfere with driving your vehicle. This provides lap and shoulder belt protection for all passengers, and airbag protection for the adults. A child or infant correctly restrained in the center front seat should not incur risk of serious injury from the airbags.

## SIDE AIRBAGS

### WARNINGS



Do not place objects or mount equipment on or near the airbag cover, on the side of the seatbacks (of the front seats), or in front seat areas that may come into contact with a deploying airbag. Failure to follow these instructions may increase the risk of personal injury in the event of a crash.



Do not use accessory seat covers. The use of accessory seat covers may prevent the deployment of the side airbags and increase the risk of injury in an accident.



Do not lean your head on the door. The side airbag could injure you as it deploys from the side of the seatback.



Do not attempt to service, repair, or modify the airbag, its fuses or the seat cover on a seat containing an airbag as you could be seriously injured or killed. Contact your authorized dealer as soon as possible.



If the side airbag has deployed, the airbag will not function again. The side airbag system (including the seat) must be inspected and serviced by an authorized dealer. If the airbag is not replaced, the unrepaired area will increase the risk of injury in a crash.

The side airbags are located on the outboard side of the seatbacks of the front seats. In certain sideways crashes, the airbag on the side affected by the crash will be inflated. The airbag was designed to inflate between the door panel and occupant to further enhance the protection provided occupants in side impact crashes.



E152533

The system consists of the following:

- A label or embossed side panel indicating that side airbags are found on your vehicle.
- Side airbags located inside the seatback of the driver and front passenger seats.



• Crash sensors and monitoring system with readiness indicator. See **Crash Sensors and Airbag Indicator** (page 45).

The design and development of the side airbag system included recommended testing procedures that were developed by a group of automotive safety experts known as the Side Airbag Technical Working Group. These recommended testing procedures help reduce the risk of injuries related to the deployment of side airbags.

# Supplementary Restraints System

## SAFETY CANOPY™

### WARNINGS

 Do not place objects or mount equipment on or near the headliner at the siderail that may come into contact with a deploying curtain airbag. Failure to follow these instructions may increase the risk of personal injury in the event of a crash.

 Do not lean your head on the door. The curtain airbag could injure you as it deploys from the headliner.

 Do not attempt to service, repair, or modify the curtain airbags, its fuses, the A, B, or C pillar trim, or the headliner on a vehicle containing curtain airbags as you could be seriously injured or killed. Contact your authorized dealer as soon as possible.

 All occupants of your vehicle including the driver should always wear their safety belts even when an airbag supplemental restraint system and curtain airbag is provided. Failure to properly wear your safety belt could seriously increase the risk of injury or death.

 To reduce risk of injury, do not obstruct or place objects in the deployment path of the curtain airbag.

 If the curtain airbags have deployed, the curtain airbags will not function again. The curtain airbags (including the A, B and C pillar trim and headliner) must be inspected and serviced by an authorized dealer. If the curtain airbag is not replaced, the unrepaired area will increase the risk of injury in a crash.

The Safety Canopy will deploy during significant side crashes or when a certain likelihood of a rollover event is detected by the rollover sensor. The Safety Canopy is mounted to the roof side-rail sheet metal, behind the headliner, above each row of seats. In certain sideways crashes or rollover events, the Safety Canopy will be activated, regardless of which seats are occupied. The Safety Canopy is designed to inflate between the side window area and occupants to further enhance protection provided in side impact crashes and rollover events.

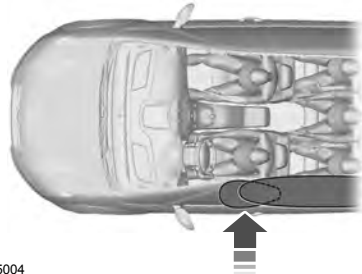

E75004

The system consists of the following:

- Safety canopy curtain airbags located above the trim panels over the front and rear side windows identified by a label or wording on the headliner or roof-pillar trim.
- A flexible headliner which opens above the side doors to allow air curtain deployment



- The crash sensors and monitoring system have a readiness indicator. See **Crash Sensors and Airbag Indicator** (page 45).

# Supplementary Restraints System

Children 12 years old and under should always be properly restrained in the rear seats. The Safety Canopy will not interfere with children restrained using a properly installed child or booster seat because it is designed to inflate downward from the headliner above the doors along the side window opening.

The design and development of the Safety Canopy included recommended testing procedures that were developed by a group of automotive safety experts known as the Side Airbag Technical Working Group. These recommended testing procedures help reduce the risk of injuries related to the deployment of side airbags (including the Safety Canopy).

## CRASH SENSORS AND AIRBAG INDICATOR

### WARNING



Modifying or adding equipment to the front end of the vehicle (including frame, bumper, front end body structure and tow hooks) may affect the performance of the airbag system, increasing the risk of injury. Do not modify the front end of the vehicle.

Your vehicle has a collection of crash and occupant sensors which provide information to the restraints control module which deploys (activates) the front safety belt pretensioners, driver airbag, passenger airbag, seat mounted side airbags, and the Safety Canopy®. Based on the type of crash (frontal impact, side impact or rollover), the restraints control module will deploy the appropriate safety devices.

The restraints control module also monitors the readiness of the above safety devices plus the crash and occupant sensors. The readiness of the safety system is indicated by a warning indicator light in the instrument cluster or by a backup tone if the warning light is not working. See **Instrument Cluster** (page 77). Routine maintenance of the airbag is not required.

A difficulty with the system is indicated by one or more of the following:



The readiness light will not illuminate immediately after the ignition is turned on.

- The readiness light will either flash or stay lit.
- A series of five beeps will be heard. The tone pattern will repeat periodically until the problem, the light or both are repaired.

If any of these things happen, even intermittently, have the supplemental restraint system serviced at an authorized dealer immediately. Unless serviced, the system may not function properly in the event of a crash.



# Supplementary Restraints System

---

The fact that the safety belt pretensioners or front airbags did not activate for both front seat occupants in a crash does not mean that something is wrong with the system. Rather, it means the restraints control module determined the accident conditions (crash severity, belt usage) were not appropriate to activate these safety devices.

- The design of the front airbags is to activate only in frontal and near-frontal crashes (not rollovers, side impacts or rear impacts) unless the crash causes sufficient frontal deceleration.
- The design of the safety belt pretensioners is to activate in frontal, near-frontal and side crashes, and in rollovers.
- The design of the side airbags is to inflate in certain side impact crashes. Side airbags may activate in other types of crashes if the vehicle experiences sufficient sideways motion or deformation.
- The design of the Safety Canopy is to inflate in certain side impact crashes or rollover events. The Safety Canopy may activate in other types of crashes if the vehicle experiences sufficient sideways motion or deformation, or a certain likelihood of rollover.

## AIRBAG DISPOSAL

Contact your authorized dealer as soon as possible. Airbags must be disposed of by qualified personnel.

# Keys and Remote Controls

## GENERAL INFORMATION ON RADIO FREQUENCIES

This device complies with Part 15 of the FCC Rules and with Industry Canada license-exempt RSS standard(s). Operation is subject to the following two conditions: (1) This device may not cause harmful interference, and (2) This device must accept any interference received, including interference that may cause undesired operation.

**Note:** Changes or modifications not expressly approved by the party responsible for compliance could void the user's authority to operate the equipment. The term **IC** before the radio certification number only signifies that Industry Canada technical specifications were met.

The typical operating range for your transmitter is approximately 33 feet (10 meters). Vehicles with the remote start feature will have a greater range. One of the following could cause a decrease in operating range:

- weather conditions
- nearby radio towers
- structures around the vehicle
- other vehicles parked next to your vehicle

The radio frequency used by your remote control can also be used by other short distance radio transmissions, for example amateur radios, medical equipment, wireless headphones, remote controls and alarm systems. If the frequencies are jammed, you will not be able to use your remote control. You can lock and unlock the doors with the key.

**Note:** Make sure to lock your vehicle before leaving it unattended.

**Note:** If you are in range, the remote control will operate if you press any button unintentionally.

**Note:** The remote control contains sensitive electrical components. Exposure to moisture or impact may cause permanent damage.

## REMOTE CONTROL

### Integrated Keyhead Transmitters (If Equipped)



E163046

Use the key blade to start your vehicle and unlock or lock the driver door from outside your vehicle. The transmitter portion functions as the remote control.



E163047

**Note:** Your vehicle's keys came with a security label that provides important vehicle key cut information. Keep the label in a safe place for future reference.

### Replacing the Battery

**Note:** Refer to local regulations when disposing of transmitter batteries.

**Note:** Do not wipe off any grease on the battery terminals or on the back surface of the circuit board.

**Note:** Replacing the battery will not delete the transmitter from the vehicle. The transmitter should operate normally.

# Keys and Remote Controls

The remote control uses one coin-type three-volt lithium battery CR2032 or equivalent.

## Integrated Keyhead Transmitter

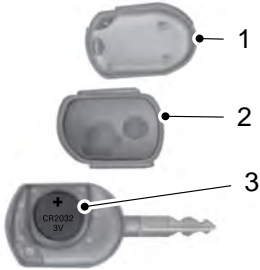

E163048

1. Twist a thin coin in the slot of the transmitter near the key ring to remove the battery cover.
2. Carefully peel up the rubber gasket from the transmitter. It may come off with the battery cover.
3. Remove the old battery
4. Insert the new battery. Refer to the instructions inside the transmitter for the correct orientation of the battery. Press the battery down to make sure it is fully in the housing.
5. Reinstall the rubber gasket.
6. Snap the battery cover back onto the transmitter.

## Memory Feature (If Equipped)

You can use the remote control to recall memory settings for the driver seat, power mirrors and power foot pedals.

Press the unlock button on the remote control to recall the memory positions. If you enable the easy-entry and exit feature, the seat will move to the easy-entry position. The seat will move to the driver memory position when you put the key in the ignition.

## Programming to the Transmitter

1. With the ignition on, move the memory features to the desired positions using the associated controls.



E162734

2. Press and hold memory button **1** on the driver door. A tone will sound after about two seconds. Continue to hold until you hear a second tone.
3. Press the lock button on the remote control within three seconds. A single tone sounds.

Repeat this procedure with button **2** and a second remote control if desired.

## Deactivating from the Transmitter

1. Press and hold the desired memory button for five seconds. A tone will sound after about two seconds. Continue to hold until you hear a second tone.
2. Press the unlock button on the remote control within three seconds.

Repeat this procedure for each additional transmitter if desired.

## Car Finder



Press the button twice within three seconds. The horn will sound and the turn signals will flash. We recommend you use this method to locate your vehicle, rather than using the panic alarm.

# Keys and Remote Controls

## Sounding a Panic Alarm

**Note:** The panic alarm will only operate when the ignition is off.



Press the button to activate the alarm. Press the button again or turn the ignition on to deactivate it.

## Remote Start (If Equipped)

### WARNING



To avoid exhaust fumes, do not use remote start if your vehicle is parked indoors or areas that are not well ventilated.

**Note:** Do not use remote start if your vehicle is low on fuel.



The remote start button is on the transmitter.

This feature allows you to start your vehicle from outside the vehicle. The transmitter has an extended operating range.

Vehicles with automatic climate control can be set to operate when you remote start the vehicle. See **Climate Control** (page 106). A manual climate control system will run at the setting it was set to when you switch the vehicle off.

Many states and provinces have restrictions for the use of remote start. Check your local and state or provincial laws for specific requirements regarding remote start systems.

The remote start system will not work if:

- the ignition is on
- the alarm system is triggered
- you disable the feature
- the hood is open
- the transmission is not in **P**

- the vehicle battery voltage is too low
- the service engine soon indicator is on.

## Remote Starting the Vehicle

**Note:** You must press each button within three seconds of each other. Your vehicle will not remote start and the horn will not sound if you do not follow this sequence.

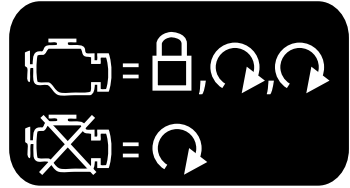

E138626

The label on your transmitter details the starting procedure.

To remote start your vehicle:

1. Press the lock button to lock all the doors.
2. Press the remote start button twice. The exterior lamps will flash twice.

The horn will sound if the system fails to start.

**Note:** If you remote start your vehicle with an integrated keyhead transmitter, you must switch the ignition on before driving your vehicle. If you remote start your vehicle with an intelligent access transmitter, you must press the **START/STOP** button on the instrument panel once while applying the brake pedal before driving your vehicle.

The power windows will not work during the remote start and the radio will not turn on automatically.

The parking lamps will remain on and the vehicle will run for 5, 10, or 15 minutes, depending on the setting.

# Keys and Remote Controls

---

## ***Extending the Vehicle Run Time***

Repeat Steps 1 and 2 with the vehicle still running to extend the run time for another remote start duration. If the duration is set to last 10 minutes, the duration will extend by another 10 minutes. For example, if the vehicle had been running from the first remote start for five minutes, the vehicle will continue to run now for a total of 20 minutes.

Wait at least five seconds before remote starting after a vehicle shutdown.

## ***Turning the Vehicle Off After Remote Starting***



Press the button once. The parking lamps will turn off.

You may have to be closer to the vehicle than when starting due to ground reflection and the added noise of the running vehicle.

You can disable or enable the remote start system through the information display. See (page 84).

## **REPLACING A LOST KEY OR REMOTE CONTROL**

Replacement keys or remote controls can be purchased from an authorized dealer. Authorized dealers can program remote controls for your vehicle. See **Passive Anti-Theft System** (page 60).

To re-program the passive anti-theft system see an authorized dealer.

## PRINCIPLE OF OPERATION

MyKey allows you to program keys with restricted driving modes to promote good driving habits. All but one of the keys programmed to the vehicle can be activated with these restricted modes.

Any keys that have not been programmed are referred to as administrator keys or admin keys. They can be used to:

- create a MyKey
- program configurable MyKey settings
- clear all MyKey features.

When you have programmed a MyKey, you can access the following information using the information display:

- How many admin keys and MyKeys are programmed to your vehicle.
- The total distance your vehicle has traveled using a MyKey.

**Note:** All MyKeys are programmed to the same settings. You cannot program them individually.

## Non-configurable Settings

The following settings cannot be changed by an admin key user:

- Belt-Minder. You cannot disable this feature. The audio system will mute when the front seat occupants' safety belts are not fastened. **Note:** If your vehicle is equipped with AM/FM radio only, then the radio will not mute.
- Early low fuel. The low fuel warning is activated earlier, giving the MyKey user more time to refuel.
- Driver assist features, if equipped on your vehicle, are forced on: parking aid, blind spot information system (BLIS) with cross traffic alert, lane departure warning and forward collision warning system.

## Configurable Settings

With an admin key, you can configure certain MyKey settings when you first create a MyKey and before you recycle the key or restart the vehicle. You can also change the settings afterward with an admin key:

- A vehicle speed limit can be set. Warnings will be shown in the display followed by an audible tone when your vehicle reaches the set speed. You cannot override the set speed by fully depressing the accelerator pedal or by setting cruise control.
- Vehicle speed minders of 45, 55 or 65 mph (75, 90 or 105 km/h). Once you select a speed, it will be shown in the display, followed by an audible tone when the preselected vehicle speed is exceeded.
- Audio system maximum volume of 45%. A message will be shown in the display when you attempt to exceed the limited volume. Also, the speed-sensitive or compensated automatic volume control will be disabled. **Note:** If your vehicle is equipped with AM/FM radio only, then the radio volume will not be limited.
- Always on setting. When this is selected, you will not be able to turn off AdvanceTrac (if your vehicle is equipped with this feature).

## CREATING A MYKEY

Use the information display to create a MyKey. There are two types of information displays, and their controls and messaging vary. To determine which type of display you have, you will need to reference another chapter. See (page 84).

**If You Have a Type 1 Information Display:**

1. Insert the key you want to program into the ignition.
2. Switch the ignition on.
3. Access the main menu on the information display controls. Press **SETUP** using the information display buttons until **PRESS RESET TO CREATE MYKEY** is displayed.
4. Press and release the **RESET** button. You will see **HOLD RESET TO CONFIRM MYKEY** in the display.
5. Press and hold the **RESET** button for two seconds until you see the message **MARK THIS AS RESTRICTED** in the display. Wait until you see **KEY RESTRICTED AT NEXT START** in the display.

### If You Have a Type 2 Information Display:

1. Insert the key you want to program into the ignition.
2. Switch the ignition on.
3. Access the main menu on the information display controls, and select **SETTINGS**, then **MYKEY** by pressing **OK** or the **>** button.
4. Press **OK** or the **>** button to select **CREATE A MYKEY**.
5. When prompted, hold the **OK** button until you see **KEY RESTRICTED AT NEXT START** in the display. The key will be restricted at the next start.

MyKey is successfully created. Make sure you label it so you can distinguish it from the admin keys.

You can also program configurable settings for the key(s). Refer to **Programming/Changing Configurable Settings**.

### Programming/Changing Configurable Settings

Use the information display to program or change your configurable MyKey settings. There are two types of information displays, and their controls and messaging vary. To determine which type of display you have, you will need to reference another chapter. See (page 84).

#### If You Have a Type 1 Information Display:

1. Switch the ignition on using an admin key.
2. Access the main menu on the information display controls, and press **SETUP** until **RESET FOR MYKEY SETTINGS** displays.
3. Press and release the **RESET** button to display MyKey setup menus.
4. Press the **SETUP** button to enter your choice. Once you make a selection, the next configurable setting will be displayed.
5. Repeat Steps 3 and 4 until you are done changing the configurable settings.

#### If You Have a Type 2 Information Display:

1. Switch the ignition on using an admin key.
2. Access the main menu on the information display controls, and select **SETTINGS**, then **MYKEY** by pressing **OK** or the **>** button.
3. Use the arrow buttons to get to a configurable feature.
4. Press **OK** or **>** to make a selection.

**Note:** You can clear or change your MyKey settings at any time during the same key cycle as you created the MyKey. Once you have switched the engine off, however, you will need an admin key to change or clear your MyKey settings.

## CLEARING ALL MYKEYS

You can clear all MyKeys within the same key cycle as you created the MyKey. If you switch your ignition off, however, you will need to use an admin key to clear your MyKeys.

**Note:** When you clear your MyKeys, you remove all restrictions and return all MyKeys to their original admin key status at once.

To clear all MyKeys of all MyKey settings, use the information display. There are two types of information displays, and their controls and messaging vary. To determine which type of display you have, you will need to reference another chapter. See (page 84).

### If You Have a Type 1 Information Display:

**To find information on a programmed MyKey(s), press the left arrow button to access the main menu and scroll to:**

Message	Description
Settings	Press the <b>OK</b> button.
MyKey	Press the <b>OK</b> button.

**Select one of the following:**

1. Press **SETUP** until **PRESS RESET TO CLEAR MYKEY** displays.
2. Press and release the **RESET** button. The display will show **HOLD RESET TO CONFIRM CLEAR**.
3. Press and hold the **RESET** button for two seconds until **ALL MYKEYS CLEARED** displays.

### If You Have a Type 2 Information Display:

1. Access the main menu and select **SETTINGS**, then **MYKEY**.
2. Scroll to **CLEAR ALL** and press the **OK** button.
3. Hold the **OK** button until **ALL MYKEYS CLEARED** displays.

## CHECKING MYKEY SYSTEM STATUS

You can find information on programmed MyKey(s) using the information display control on the steering wheel. See **Information Displays** (page 84).



# MyKey™

<b>Message</b>	<b>Description</b>
MyKey Dist.	Tracks the distance when drivers use a MyKey. The only way to delete the accumulated distance is by using an admin key to clear your MyKey. If the distance does not accumulate as expected, then the intended user is not using the MyKey, or an admin key user recently cleared and then recreated a MyKey.
{0} MyKeys	Indicates the number of MyKeys programed to your vehicle. Use this feature to detect how many MyKeys you have for your vehicle and determine when a MyKey has been deleted.
{0} Admin Keys	Indicates how many admin keys are programed to your vehicle. Use this feature to determine how many unrestricted keys you have for your vehicle, and detect if an additional MyKey has been programed.

## USING MYKEY WITH REMOTE START SYSTEMS

MyKey is not compatible with non

Ford-approved, aftermarket remote start systems. If you choose to install a remote start system, see an authorized dealer for a Ford-approved remote start system.

## MYKEY TROUBLESHOOTING

Condition	Potential causes
I cannot create a MyKey.	<ul style="list-style-type: none"> <li>· The key used to start the vehicle does not have admin privileges.</li> <li>· The key used to start the vehicle is the only admin key. There always has to be at least one admin key.</li> <li>· SecuriLock passive anti-theft system is disabled or in unlimited mode.</li> </ul>
I cannot program the configurable settings.	<ul style="list-style-type: none"> <li>· The key in the ignition does not have admin privileges.</li> <li>· There are no keys programmed to the vehicle. See <b>Creating a MyKey</b> (page 51).</li> </ul>
I cannot clear the MyKeys.	<ul style="list-style-type: none"> <li>· The key used to start the vehicle does not have admin privileges.</li> <li>· No MyKeys are created. See <b>Creating a MyKey</b> (page 51).</li> </ul>
I lost the only admin key.	<ul style="list-style-type: none"> <li>· Purchase a new key from your authorized dealer.</li> </ul>
I lost a key.	<ul style="list-style-type: none"> <li>· Program a spare key. See <b>Passive Anti-Theft System</b> (page 60).</li> </ul>
MyKey distances do not accumulate.	<ul style="list-style-type: none"> <li>· The MyKey user is not using the MyKey.</li> <li>· An admin key holder cleared the MyKeys and created new MyKeys.</li> <li>· The key system has been reset.</li> </ul>

# Locks

## LOCKING AND UNLOCKING

You can use the power door lock control or the remote control to lock and unlock your vehicle.

### Power Door Locks (If Equipped)

The power door lock control is on the driver and front passenger door panels.



E163049

- A Unlock
- B Lock

### Remote Control (If Equipped)

#### Unlocking the Doors (Two-Stage Unlock)



Press the button to unlock the driver door.

Press the button again within three seconds to unlock all doors. The turn signals will flash.

Press and hold both the lock and unlock buttons on the remote control for four seconds to disable or enable two-stage unlocking. Disabling two-stage unlocking allows all vehicle doors to unlock with one press of the button. The turn signals will flash twice to indicate a change to the unlocking mode. The unlocking mode applies to the remote control and keyless entry keypad.

### Locking the Doors



Press the button to lock all the doors. The turn signals will illuminate.

Press the button again within three seconds to confirm that all the doors are closed. The doors will lock again, the horn will sound and the turn signals will illuminate if all the doors are closed.

### Mislock

If any door is open or if the hood is open on vehicles with an anti-theft alarm or remote start, the horn will sound twice and the lamps will not flash.

### Smart Unlocks (If Equipped)

This feature helps to prevent you from locking yourself out of your vehicle if your key is still in the ignition.

When you open the driver door and lock your vehicle with the power door lock control, all the doors will lock then unlock if your key is still in the ignition.

You can still lock your vehicle with the key in the ignition by:

- using the manual lock on the door
- locking the driver door with a key
- using the keyless entry keypad
- using the lock button on the remote control

### Autolock and Autounlock (If Equipped)

The autolock feature will lock all the doors when:

- all doors are closed, and
- the ignition is on, and
- you shift into any gear putting your vehicle in motion, and
- your vehicle attains a speed greater than 12 mph (20 km/h).

# Locks

The autolock feature will unlock all the doors when:

- autolock has locked the doors
- you stop the vehicle and switch the ignition off or to accessory mode, and
- you open the driver door within 10 minutes.

**Note:** *The doors will not autounlock if you have electronically locked them before opening the driver door.*

## Enabling or Disabling

You can enable or disable these features in the information display or your authorized dealer can do it for you. See (page 84).

**Note:** *You can enable or disable the autolock and autounlock features independently of each other.*

## Illuminated Entry

The interior lamps and select exterior lamps will illuminate when you unlock the doors with the remote entry system.

The illuminated entry system will turn off the lights if:

- the ignition is on
- you press the remote control lock button, or
- after 25 seconds of illumination.

The dome lamp will not turn on if the control is set to the off position.

The lights will not turn off if:

- you turn them on with the dimmer control, or
- any door is open.

## Battery Saver

The battery saver turns off the interior lamps 30 minutes after you switch the ignition off if a door is open and the dome lamp switch is on. It turns off the interior lamps after 10 minutes if the dome lamp switch is off.

## KEYLESS ENTRY (If Equipped)

### SECURICODE™ KEYLESS ENTRY KEYPAD

The keypad is located near the driver window.

**Note:** *If you enter your entry code too fast on the keypad, the unlock function may not work. Re-enter your entry code more slowly.*



E163050

You can use the keypad to lock or unlock the doors without using a key.

You can operate the keypad with the factory-set 5-digit entry code. The code is located on the owner's wallet card in the glove box and is available from an authorized dealer. You can also create up to five of your own 5-digit personal entry codes.

### Programming a Personal Entry Code

To create your own personal entry code:

1. Enter the factory-set code.
2. Press **1•2** on the keypad within five seconds.

# Locks

3. Enter your personal 5-digit code. You must enter each number within five seconds of each other.
4. Press **1-2** on the keypad to save personal code 1.

The doors will lock then unlock to confirm that programming was successful.

To program additional personal entry codes, repeat Steps 1-3, then for Step 4:

- press **3-4** to save personal code 2
- press **5-6** to save personal code 3
- press **7-8** to save personal code 4
- press **9-0** to save personal code 5.

You may also program a personal entry code through the MyFord Touch system.

## Tips:

- Do not set a code that uses five of the same number.
- Do not use five numbers in sequential order.
- The factory-set code will work even if you have set your own personal code.

## Recalling Memory Positions (If Equipped)

The programmed entry codes will recall driver memory positions as follows:

- Entry code 1 will recall driver 1 memory positions.
- Entry code 2 will recall driver 2 memory positions.

**Note:** *Personal entry codes 3, 4 and 5 will not recall memory positions.*

## Erasing a Personal Code

1. Enter the factory-set 5-digit code.
2. Press and release **1-2** on the keypad within five seconds.
3. Press and hold **1-2** for two seconds. You must do this within five seconds of completing Step 2.

All personal codes will erase and only the factory-set 5-digit code will work.

## Anti-Scan Feature

The keypad will go into an anti-scan mode if you enter the wrong code seven times (35 consecutive button presses). This mode disables the keypad for one minute and the keypad lamp will flash.

The anti-scan feature will turn off after:

- one minute of keypad inactivity
- pressing the unlock button on the remote control
- switching the ignition on.

## Unlocking and Locking the Doors

### To Unlock the Driver Door

Enter the factory-set 5-digit code or your personal code. You must press each number within five seconds of each other. The interior lamps will illuminate.

**Note:** *All doors will unlock if you disable the two-stage unlocking mode. See **Locking and Unlocking** (page 56).*

### To Unlock All Doors

Enter the factory-set code or your personal code, then press **3-4** within five seconds.

### To Lock All Doors

Press and hold **7-8** and **9-0** at the same time (with the driver door closed). You do not need to enter the keypad code first.

## Displaying the Factory Set Code

**Note:** *You will need to have two programmed passive anti-theft keys for this procedure.*

To display the factory-set code in the information display:

1. Insert a key into the ignition and switch the ignition on for a few seconds.

# Locks

---

2. Switch the ignition off and remove the key.
3. Insert the second key into the ignition and switch the ignition on.

The factory-set code will display for a few seconds.

**Note:** *The code may not display until after any other warning messages first display.*

# Security

---

## **PASSIVE ANTI-THEFT SYSTEM** (If Equipped)

**Note:** *The system is not compatible with non-Ford aftermarket remote start systems. Use of these systems may result in vehicle starting problems and a loss of security protection.*

**Note:** *Metallic objects, electronic devices or a second coded key on the same key chain may cause vehicle starting problems if they are too close to the key when starting the engine. Prevent these objects from touching the coded key while starting the engine. Switch the ignition off, move all objects on the key chain away from the coded key and restart the engine if a problem occurs.*

**Note:** *Do not leave a duplicate coded key in the vehicle. Always take your keys and lock all doors when leaving the vehicle.*

### **SecuriLock™**

The system is an engine immobilization system. It helps prevent the engine from starting unless you use a coded key programmed to your vehicle. Using the wrong key may prevent the engine from starting. A message may appear in the information display.

If you are unable to start the engine with a correctly coded key, the system has malfunctioned. A message may appear in the information display.

### **Automatic Arming**

The system arms immediately after you switch the ignition off.

### **Automatic Disarming**

Switching the ignition on with a coded key disarms the system.

### **Replacement Keys**

**Note:** *Your vehicle may have two integrated keyhead transmitters.*

The integrated keyhead transmitter functions as a programmed ignition key. It operates all the locks, starts the vehicle and acts as a remote control.

If your programmed transmitters or standard SecuriLock coded keys are lost or stolen and you do not have an extra coded key, you will need to have your vehicle towed to an authorized dealer. You need to erase the key codes from your vehicle and program new coded keys.

Store an extra programmed key away from your vehicle in a safe place to help prevent any inconveniences. See an authorized dealer to purchase additional spare or replacement keys.

### **Programming a Spare Key**

**Note:** *You can program a maximum of eight coded keys to your vehicle. Only four of these can be integrated keyhead transmitters.*

You can program your own integrated keyhead transmitter or standard SecuriLock coded keys to your vehicle. This procedure will program both the engine immobilizer keycode and the remote entry portion of the remote control to your vehicle.

Only use integrated keyhead transmitters or standard SecuriLock keys.

You must have two previously programmed coded keys and the new unprogrammed key readily accessible. See an authorized dealer to have the spare key programmed if two previously programmed coded keys are not available.

Read and understand the entire procedure before you begin.

# Security

---

1. Insert the first previously programmed coded key into the ignition.
2. Switch the ignition from off to on. Keep the ignition on for at least three seconds, but no more than 10 seconds.
3. Switch the ignition off and remove the first coded key from the ignition.
4. After three seconds but within 10 seconds of switching the ignition off, insert the second previously coded key into the ignition.
5. Switch the ignition from off to on. Keep the ignition on for at least three seconds, but no more than 10 seconds.
6. Switch the ignition off and remove the second previously programmed coded key from the ignition.
7. After three seconds but within 10 seconds of switching the ignition off and removing the previously programmed coded key, insert the new unprogrammed key into the ignition.
8. Switch the ignition from off to on. Keep the ignition on for at least six seconds until you hear the door locks cycle.
9. Remove the newly programmed coded key from the ignition.

The key will start the engine if programming is successful. You can operate the remote entry system if the new key is an integrated keyhead transmitter.

If programming was not successful, wait 20 seconds and repeat Steps 1 through 8. If you are still unsuccessful, take your vehicle to an authorized dealer.

## **ANTI-THEFT ALARM** (If Equipped)

The system warns you of an unauthorized entry to your vehicle. It triggers if any door or the hood opens without using the key, remote control or keyless entry keypad.

The direction indicators flash and the horn sounds if the system triggers while the alarm is armed.

Take all remote controls to an authorized dealer if there is any potential alarm problem with your vehicle.

### **Arming the Alarm**

The alarm is ready to arm when there is not a key in the ignition. Electronically lock the vehicle to arm the alarm.

The direction indicators flash once after you lock the vehicle. This indicates the alarm is in the pre-armed mode. It will fully arm in 20 seconds.

### **Disarming the Alarm**

Disarm the alarm by any of the following actions:

- Press the power door unlock button within the 20-second pre-armed mode.
- Unlock the doors with the remote control or keyless entry keypad.
- Switch the ignition on or start the vehicle.
- Use a key in the driver door to unlock the vehicle, then switch the ignition on within 12 seconds.

**Note:** *Pressing the panic button on the remote control will stop the horn and signal indicators, but will not disarm the system.*



# Steering Wheel

## ADJUSTING THE STEERING WHEEL

### WARNING

 Do not adjust the steering wheel when your vehicle is moving.

**Note:** Make sure that you are sitting in the correct position. See **Sitting in the Correct Position** (page 113).



E183047

1. Unlock the steering column.
2. Adjust the steering wheel to the desired position.



E183049

3. Lock the steering column.

## AUDIO CONTROL (If Equipped)

You can operate the following functions with the control:

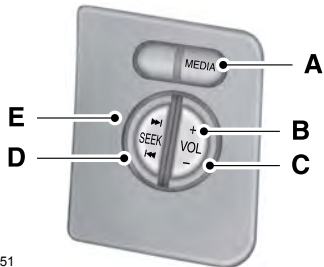

E163051

- A Media
- B Volume up
- C Volume down
- D Seek down or previous
- E Seek up or next

# Steering Wheel

## Media

Press repeatedly to scroll through available audio modes.

## Seek, Next or Previous

Press the seek button to:

- tune the radio to the next or previous stored preset
- play the next or the previous track.

Press and hold the seek button to:

- tune the radio to the next station up or down the frequency band
- seek through a track.

## VOICE CONTROL (If Equipped)



E163052

- A Voice recognition
- B Phone mode

See **SYNC™** (page 323). See **MyFord Touch™** (page 362).

## CRUISE CONTROL (If Equipped)



E163053

See **Cruise Control** (page 178).

## INFORMATION DISPLAY CONTROL

### Type 1



E163054

# Steering Wheel

---

## Type 2



E163055

See **Information Displays** (page 84).

## **HEATED STEERING WHEEL (if Equipped)**

See **MyFord Touch™** (page 362).

# Pedals

## ADJUSTING THE PEDALS (If

Equipped)

### WARNING



Never use the controls while your feet are on the accelerator and brake pedals and the vehicle is moving.

You can find the control on the left side of the steering column. Press and hold the appropriate side of the control to move the pedals.

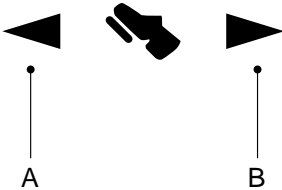

E162916

A. Farther

B. Closer

You can save and recall the pedal positions with the memory feature. See **Memory Function** (page 116).

**Note:** *Adjust the pedals only when your vehicle is in **P** (Park).*

# Wipers and Washers

## WINDSHIELD WIPERS

**Note:** Fully defrost the windshield before switching on the windshield wipers.

**Note:** Make sure the windshield wipers are switched off before entering a car wash.

**Note:** Clean the windshield and wiper blades if they begin to leave streaks or smears. If that does not resolve the issue, install new wiper blades.

**Note:** Do not operate the wipers on a dry windshield. This may scratch the glass, damage the wiper blades or cause the wiper motor to burn out. Always use the windshield washers before wiping a dry windshield.

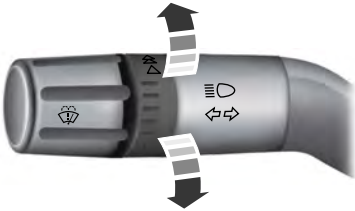

E171242

Rotate the end of the control:

- away from you to increase the wiper speed
- toward you to decrease the wiper speed.

## Speed dependent wipers

When your vehicle speed increases, the interval between wipes decreases.

## WINDSHIELD WASHERS

**Note:** Do not operate the wipers on a dry windshield. This may scratch the glass, damage the wiper blades or cause the wiper motor to burn out. Always use the windshield washer before wiping a dry windshield.

**Note:** Do not operate the washers when the washer reservoir is empty. This may cause the washer pump to overheat.

Press the end of the stalk to activate the washer.

- A brief press causes a single wipe without washer fluid.
- A quick press and hold causes the wipers to swipe three times with washer fluid.
- A long press and hold will activate the wipers and washer fluid for up to 10 seconds.

A wipe will occur a few seconds after washing to clear any remaining washer fluid. This feature can be turned on and off in the information display.



E171243

# Lighting

## LIGHTING CONTROL



E163267

- Rotate the headlamp control clockwise to the first position to turn on the parking lamps, instrument panel lamps, license plate lamps and tail lamps.
- Rotate clockwise to the second position to also turn on the headlamps.

## High Beams

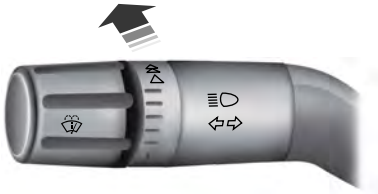

E167827

Push the lever toward the instrument panel to switch the high beams on.

Push the lever toward the instrument panel again or pull the lever towards you to switch the high beams off.

## Headlamp Flasher

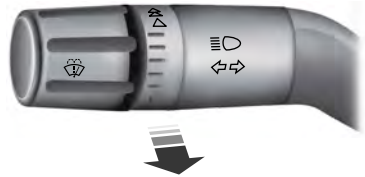

E163268

Pull the lever toward you to flash the headlamps and release the lever to switch the headlamps off.

## AUTOLAMPS (if Equipped)



E163269

The autolamp system provides light sensitive automatic on-off control of the exterior lights normally controlled by the headlamp control.

- To turn autolamps on, rotate the control to the fourth position.
- To turn autolamps off, rotate the control to the first, second, or third position.

# Lighting

**Note:** If the vehicle is equipped with autolamps, it will have the headlamps on with windshield wipers feature. If the windshield wipers are turned on, the exterior lamps will turn on with the headlamp control in the autolamp position.

The autolamp system also keeps the lights on for a predetermined amount of time after the ignition switch is turned off. You can change the amount of time the lamps stay on by using the programming procedure that follows:

## Autolamps - Programmable Exit Delay

Programmable exit delay allows the length of the autolamp exit delay to be changed.

To program the auto lamp exit time delay:

1. Start with the ignition in the off position and the headlamp control in the autolamp position.
2. Turn the headlamp control to off.
3. Turn the ignition switch to on and then back to off.
4. Turn the headlamp control to the autolamp position. The headlamps will turn on.
5. Wait the desired amount of time for the exit delay you want (up to three minutes), then turn the headlamps off.

## INSTRUMENT LIGHTING DIMMER



E163270

Use to adjust the brightness of the instrument panel and all applicable lit components in the vehicle during headlamp and parking lamp operation.

- Tap the top or bottom of the control to brighten/dim all interior lit components incrementally, or
- Press and hold at the first position the top or bottom of the control until the desired lighting level is reached.
- Press and hold the top of the control to the full on position to activate the “dome on” feature. This will turn on the interior courtesy lights. The lights will remain on until the bottom of the control is pressed.

## DAYTIME RUNNING LAMPS (if

Equipped)

### WARNING



Always remember to switch your headlamps on in low light situations or during inclement weather. The system does not activate the tail lamps and may not provide adequate lighting during these conditions. Failure to activate your headlamps under these conditions may result in a collision.

# Lighting

The system switches the headlamps on with a reduced output in daylight conditions.

To switch the system on:

1. Switch the ignition on.
2. Switch the lighting control to the off, or parking lamp position.
3. Disengage the parking brake.
4. Make sure the transmission selector lever is not in position P.

## FRONT FOG LAMPS (If Equipped)



The headlamp control also operates the fog lamps. The fog lamps can be turned on only when the headlamp control is in the parking lamp (second) position, headlamps on (third) position, or autolamp (fourth) position, and the high beams are not turned on.

Pull headlamp control towards you to turn fog lamps on. The fog lamp indicator light will illuminate.

## DIRECTION INDICATORS



E163272

The turn signal lever does not mechanically lock in the upward or downward position when activated. The turn signal control activation and cancellation is electronic.

- To operate the left turn signal, push the lever down until it stops and release.
- To operate the right turn signal, push the lever up until it stops and release.
- To manually cancel turn signal operation, push the lever again in either direction.

## Lane Change

To indicate a left or right lane change:

- Push the lever up/down to the first stop position and release. The turn signals will flash three times and stop.
- Push the lever up/down to the first stop position and hold. The turn signals will flash for as long as the lever is held in this position.

## INTERIOR LAMPS

### Front Map Lamps (If equipped)

The map lamps are located on the overhead console. Press the controls on either side of each map lamp to turn on the lamps. The map lamps also light when:



# Lighting

---

- any door is opened.
- the instrument panel dimmer switch is pressed up until the courtesy lamps come on.
- any of the remote entry controls are pressed and the ignition is off.



E163273

## Rear Dome and Map Lamps



E163274

Your vehicle may have map lamps within the rear dome lamp. Press the switches on either side of the dome lamp to turn the lamps on.

# Windows and Mirrors

## POWER WINDOWS (If Equipped)

### WARNINGS

 Do not leave children unattended in your vehicle and do not let them play with the power windows. They may seriously injure themselves.

 When closing the power windows, you should verify they are free of obstructions and make sure that children and pets are not in the proximity of the window openings.

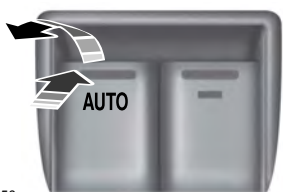

E163056

**Note:** You may hear a pulsing noise when just one of the windows is open. Lower the opposite window slightly to reduce this noise.

Press the switch to open the window.

Lift the switch to close the window.

### One-Touch Up or Down (If Equipped)

Press or lift the switch fully and release it. Press or lift it again to stop the window.

**Note:** The window may disable for up to five minutes if you cycle it up and down repeatedly. This helps prevent damage to the motor. Normal operation will resume once the motor cools.

### Restoring the One-Touch Up Function

You may lose the one-touch function if the vehicle battery is low.

**Note:** Perform one-touch up re-calibration with the door closed. Calibrating with the door open will cause the window to continuously bounce back.

To reset the function after the battery recharges:

1. Pull the switch all the way up.
2. Hold the switch until the glass stops and continue to hold for two seconds.
3. Press the switch down and operate the window to the full down position. One-touch up will now be functional.

### Bounce-Back (If Equipped)

The window will stop automatically while closing. It will reverse some distance if there is an obstacle in the way.

### Overriding the Bounce-Back Feature

#### WARNING

 When you override the bounce-back feature, the window will not reverse if it detects an obstacle. Take care when closing the windows to avoid personal injury or damage to your vehicle.

Pull up the window switch and hold within two seconds of the window reaching the bounce-back position. The window will travel up with no bounce-back protection. The window will stop if you release the switch before the window closes fully.

# Windows and Mirrors

## Window Lock (If Equipped)

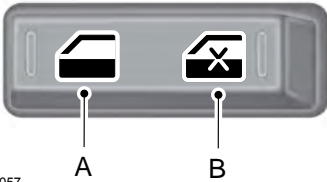

E163057

- A Unlock
- B Lock

Press the control to lock or unlock the rear window controls.

## Power Sliding Back Window (If Equipped)

### WARNINGS



When operating the power sliding back window, you must make sure all rear seat occupants and cargo are not in the proximity of the back window.



Do not leave children unattended in your vehicle and do not let them play with the power sliding back window. They may seriously injure themselves.



E163058

The control is on the overhead console.

Press and hold the control to open the window. Pull and hold the control to close the window.

## Accessory Delay (If Equipped)

You can use the window switches for several minutes after you switch the ignition off or until you open either front door.

## GLOBAL OPENING (If Equipped)

You can use the remote control to operate the windows with the ignition off.

**Note:** To operate this feature, accessory delay must not be active.

## Opening the Windows

You can only open the windows for a short time after you unlock your vehicle with the remote control. After you unlock your vehicle, press and hold the remote control unlock button to open the windows. Release the button once movement starts. Press the lock or unlock button to stop movement.

## EXTERIOR MIRRORS

### Power Exterior Mirrors (If Equipped)

#### WARNING



Do not adjust the mirrors when your vehicle is moving.

# Windows and Mirrors

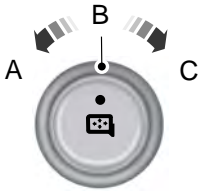

E163059

- A Left-hand mirror
- B Off
- C Right-hand mirror

To adjust a mirror:

1. Rotate the control to select the mirror you want to adjust.
2. Adjust the position of the mirror.
3. Return the control to the center position to lock mirrors in place.

## Fold-Away Exterior Mirrors

For tight parking conditions, you can push the mirror toward the door window glass. Before driving, make sure that you fully engage the mirror in its support when returning it to its original position.

## Power-Folding Mirrors (If Equipped)



E163060

1. Rotate the control so the dots line up.
2. Pull the control back to fold the mirrors in or out.

**Note:** If you repeatedly fold and unfold the mirrors several times within one minute, the system may disable to protect the motors from overheating. It will reset to normal function automatically within three to five minutes.

You can also fold a mirror manually by pushing it toward the door window glass. After you manually adjust the mirror, you will need to reset it.

To reset the power-folding mirror system and return it to its normal function:

- Fold the mirror manually by pushing it toward the door window glass.
- Use the power-fold control to fold and unfold the mirror two or three times. The mirror will make a sound as it resets.

## Heated Exterior Mirrors (If Equipped)

See **Heated Windows and Mirrors** (page 111).

## Memory Mirrors (If Equipped)

You can save and recall the mirror positions through the memory function. See **Memory Function** (page 116).

## Clearance Lamps (If Equipped)

The lower, outer part of the mirror housings light when you switch the headlamps or parking lamps on.

# Windows and Mirrors

## Telescoping Mirrors (If Equipped)

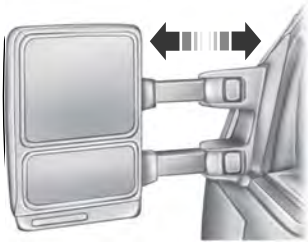

E163061

This feature lets you extend the mirror about 3 inches (75 millimeters). It is useful when towing a trailer. You can manually pull out or push in the mirrors to the desired position.

## PowerScope™ Power Telescoping Mirrors (If Equipped)

This feature lets you position both mirrors in or out at the same time. The control is on the door trim panel.

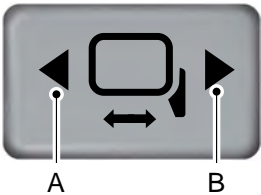

E163062

- A Telescope Out
- B Telescope In

To adjust the mirrors:

- Press and hold the control.
- When you position the mirrors in or out, the motors will run as long as you hold the control. The running motors allow you to make adjustments as needed.
- After positioning the mirrors, return the control to the center position to help protect the motors from overheating.

## INTERIOR MIRROR

### WARNING



Do not adjust the mirror when your vehicle is moving.

**Note:** Do not clean the housing or glass of any mirror with harsh abrasives, fuel or other petroleum or ammonia-based cleaning products.

You can adjust the interior mirror to your preference. Some mirrors also have a second pivot point. This lets you move the mirror head up or down and from side to side.

Pull the tab below the mirror toward you to reduce glare at night.

## Auto-Dimming Mirror (If Equipped)

**Note:** Do not block the sensors on the front and back of the mirror. Mirror performance may be affected. A rear center passenger or raised rear center head restraint may also block light from reaching the sensor.

The mirror will dim automatically to reduce glare when bright lights are detected from behind your vehicle. It will automatically return to normal reflection when you select reverse gear to make sure you have a clear view when backing up.

# Windows and Mirrors

## SUN VISORS

### Slide-on-rod (If Equipped)

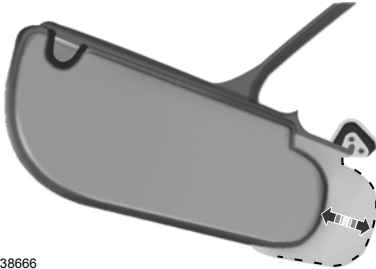

E138666

Rotate the sun visor toward the side window and extend it rearward for extra shade.

### Illuminated Vanity Mirror (If Equipped)

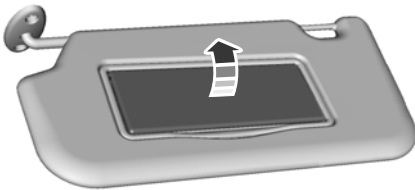

E162197

Lift the cover to switch the lamp on.

## MOONROOF (If Equipped)

### WARNINGS



Do not let children play with the moonroof or leave them unattended in the vehicle. They may seriously hurt themselves.

### WARNINGS



When closing the moonroof, you should verify that it is free of obstructions and make sure that children and pets are not in the proximity of the roof opening.

You can manually open or close the sliding shade when the moonroof is closed. Pull the shade toward the front of your vehicle to close it.

The moonroof controls are located on the overhead console and have a one-touch open and close feature. To stop it during one-touch operation, press the control a second time.

### Opening and Closing the Moonroof



E163063

Press and release the **SLIDE** control to open the moonroof. The moonroof will stop short of the fully opened position.

**Note:** *This position helps to reduce wind noise or rumbling which may happen with the moonroof fully open. Press and release the control again to fully open the moonroof.*

Pull and release the **SLIDE** control to close the moonroof.

# Windows and Mirrors

---

## **Bounce-Back**

The moonroof will stop automatically while closing. It will reverse some distance if there is an obstacle in the way.

Pull and hold the **SLIDE** control within two seconds of a bounce-back event to override this function. While bounce-back is active, the closing force increases for each of the next three times that you close the moonroof.

## **Venting the Moonroof**

Press and release the **TILT** control to vent the moonroof. Pull and hold the **TILT** control to close the moonroof.

# Instrument Cluster

## GAUGES

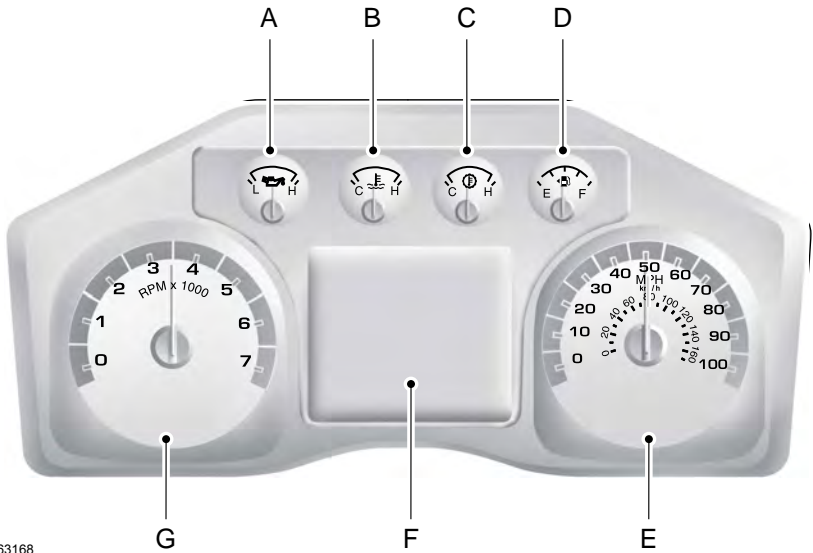

- A Engine oil pressure gauge
- B Engine coolant temperature gauge
- C Transmission fluid temperature gauge
- D Fuel gauge
- E Speedometer
- F Information display See (page 84).
- G Tachometer



# Instrument Cluster

## Engine Oil Pressure Gauge

Indicates engine oil pressure. The needle should stay in the normal operating range (between L and H). If the needle falls below the normal range, stop the vehicle, turn off the engine and check the engine oil level. Add oil if needed. If the oil level is correct, have your vehicle checked by your authorized dealer.

## Engine Coolant Temperature Gauge

### WARNING



Never remove the coolant reservoir cap while the engine is running or hot.

Indicates engine coolant temperature. At normal operating temperature, the level indicator will be in the normal range. If the engine coolant temperature exceeds the normal range, stop the vehicle as soon as safely possible, switch off the engine and let the engine cool.

## Transmission Fluid Temperature Gauge

Indicates transmission fluid temperature. At normal operating temperature, the level indicator will be in the normal range. If the transmission fluid temperature exceeds the normal range, stop the vehicle as soon as safely possible and verify the airflow is not restricted such as snow or debris blocking airflow through the grill. Also, higher than normal operating temperature can be caused by special operation conditions (i.e. snowplowing, towing or off-road use). Refer to Special operating conditions in the scheduled maintenance information for instructions. Operating the

transmission for extended periods of time with the gauge in the higher than normal area may cause internal transmission damage. Altering the severity of the driving conditions is recommended to lower the transmission temperature into the normal range. If the gauge continues to show high temperatures, see your authorized dealer.

## Fuel Gauge

**Note:** *The fuel gauge may vary slightly when your vehicle is moving or on a gradient.*

Switch the ignition on. The fuel gauge will indicate approximately how much fuel is left in the fuel tank. The arrow adjacent to the fuel pump symbol indicates on which side of your vehicle the fuel filler door is located.

The needle should move toward F when you refuel your vehicle. If the needle points to E after adding fuel, this indicates your vehicle needs service soon.

After refueling some variability in needle position is normal:

- It may take a short time for the needle to reach F after leaving the gas station. This is normal and depends upon the slope of pavement at the gas station.
- The fuel amount dispensed into the tank is a little less or more than the gauge indicated. This is normal and depends upon the slope of pavement at the gas station.
- If the gas station nozzle shuts off before the tank is full, try a different gas pump nozzle.

## Low Fuel Reminder

A low fuel reminder triggers when the fuel gauge needle is at 1/16th.

# Instrument Cluster

## Variations:

Driving type (fuel economy conditions)	Fuel gauge position	Distance-to-empty
Highway driving	1/16th	35 miles to 80 miles (56 km to 129 km)
Severe duty driving (trailer towing, extended idle)	1/16th	35 miles (56km)

## Information Display

### Odometer

Located in the bottom of the information display Registers the accumulated distance your vehicle has traveled.

### Trip Computer

See (page 84).

### Vehicle Settings and Personalization

See (page 84).

## WARNING LAMPS AND INDICATORS

The following warning lamps and indicators will alert you to a vehicle condition that may become serious. Some lamps will illuminate when you start your vehicle to make sure they work. If any lamps remain on after starting your vehicle, refer to the respective system warning lamp for further information.

**Note:** *Some warning indicators appear in the information display and function the same as a warning lamp but do not display when you start your vehicle.*

## Anti-Lock Braking System



If it illuminates when you are driving, this indicates a malfunction. You will continue to have the normal braking system (without ABS) unless the brake system warning lamp is also illuminated. Have the system checked by your authorized dealer.

## Battery



If it illuminates while driving, it indicates a malfunction. Switch off all unnecessary electrical equipment and have the system checked by your authorized dealer immediately.

## Brake System



Illuminates when you engage the parking brake with the ignition on.

If it illuminates when you are driving, check that the parking brake is not engaged. If the parking brake is not engaged, this indicates low brake fluid level or a brake system malfunction. Have the system checked immediately by your authorized dealer.

# Instrument Cluster

## WARNING



Driving your vehicle with the warning lamp on is dangerous. A significant decrease in braking performance may occur. It will take you longer to stop your vehicle. Have your vehicle checked by your authorized dealer immediately. Driving extended distances with the parking brake engaged can cause brake failure and the risk of personal injury.

## Check Fuel Cap (If Equipped)



Illuminates when the fuel cap may not be properly installed. Continued driving with this light on may cause the Service engine soon warning indicator to come on.

## Cruise Control (If Equipped)



Illuminates when you switch this feature on. See **Using Cruise Control** (page 178).

## Direction Indicator



Illuminates when the left or right turn signal or the hazard warning flasher is turned on. If the indicators stay on or flash faster, check for a burned out bulb.

## Door Ajar



Displays when the ignition is on and any door is not completely closed.

## Electronic Locking Differential



Illuminates when using the electronic locking differential.

## Engine Coolant Temperature



Illuminates when the engine coolant temperature is high. Stop the vehicle as soon as possible, switch off the engine and let cool.

## Engine Oil



If it illuminates with the engine running or when you are driving, this indicates a malfunction. Stop your vehicle as soon as it is safe to do so and switch the engine off. Check the engine oil level. See **Engine Oil Check** (page 235).

**Note:** Do not resume your journey if it illuminates despite the level being correct. Have the system checked by your authorized dealer immediately.

## Fasten Safety Belt



It will illuminate and a chime will sound to remind you to fasten your safety belt.

## Front Airbag



If it fails to illuminate when you start your vehicle, continues to flash or remains on, it indicates a malfunction. Have the system checked by your authorized dealer.

## High Beam



Illuminates when you switch the high beam headlamps on. It will flash when you use the headlamp flasher.

## Hill Descent (If Equipped)



Illuminates when hill descent is switched on.

# Instrument Cluster

## Low Fuel Level



Illuminates when the fuel level is low or the fuel tank is nearly empty. Refuel as soon as possible.

## Low Tire Pressure Warning



Illuminates when your tire pressure is low. If the lamp remains on with the engine running or when driving, check your tire pressure as soon as possible.

It will also illuminate momentarily when you switch the ignition on to confirm the lamp is functional. If it does not illuminate when you switch the ignition on, or begins to flash at any time, have the system checked by your authorized dealer.

## Powertrain Malfunction/Reduced Power/Electronic Throttle Control



Illuminates when a powertrain or an AWD fault has been detected. Contact your authorized dealer as soon as possible.

## Service Engine Soon



If the service engine soon indicator light stays illuminated after the engine is started, it indicates that the On-Board Diagnostics (OBD-II) system has detected a malfunction of the vehicle emissions control system. Refer to On-Board Diagnostics (OBD-II) in the Fuel and Refueling chapter for more information about having your vehicle serviced. See **Emission Control System** (page 144).

If the light is blinking, engine misfire is occurring which could damage your catalytic converter. Drive in a moderate fashion (avoid heavy acceleration and deceleration) and have your vehicle serviced immediately.

## WARNING



Under engine misfire conditions, excessive exhaust temperatures could damage the catalytic converter, the fuel system, interior floor coverings or other vehicle components, possibly causing a fire. Have an authorized dealer service your vehicle immediately.

The service engine soon indicator light illuminates when the ignition is first turned on prior to engine start to check the bulb and to indicate whether the vehicle is ready for Inspection/Maintenance (I/M) testing.

Normally, the service engine soon light will stay on until the engine is cranked, then turn itself off if no malfunctions are present. However, if after 15 seconds the service engine soon light blinks eight times, it means that the vehicle is not ready for I/M testing. See **Emission Control System** (page 144).

## Stability Control



Illuminates when the system is active. If it remains illuminated or does not illuminate when you switch the ignition on, this indicates a malfunction. During a malfunction the system will switch off. Have the system checked by your authorized dealer immediately. See **Using Stability Control** (page 169).

# Instrument Cluster

## Stability Control Off



Illuminates when you switch the system off. It will go out when you switch the system back on or when you switch the ignition off. See **Using Stability Control** (page 169).

## Transmission Tow/Haul (If Equipped)



Illuminates when the tow/haul feature has been activated. If the light flashes steadily, have the system serviced immediately, damage to the transmission could occur.

## 4X2 (If Equipped)



Illuminates momentarily when two-wheel drive high is selected. If the light fails to display when the ignition is turned on, or remains on, have the system serviced immediately by your authorized dealer.

## 4X4 LOW (If Equipped)



Illuminates when four-wheel drive low is engaged. If the light fails to display when the ignition is turned on, or remains on, have the system serviced immediately by your authorized dealer.

## 4X4 HIGH (If Equipped)



Illuminates when four-wheel drive high is engaged. If the light fails to display when the ignition is turned on, or remains on, have the system serviced immediately by your authorized dealer.

## Diesel Warning Lights

If your vehicle is equipped with a diesel engine, it has some unique warning lights; refer to your diesel supplement for detailed information on their function.

### Diesel engine brake



For more information see your diesel supplement.

### Diesel exhaust fluid



For more information see your diesel supplement.

### Glow plug pre-heat



For more information see your diesel supplement.

### Water in fuel



For more information see your diesel supplement.

## AUDIBLE WARNINGS AND INDICATORS

### Headlamps On Warning Chime

Sounds when you remove the key from the ignition and open the driver's door and you have left the headlamps or parking lamps on.

### Key in Ignition Warning Chime

Sounds when you open the driver's door and you have left the key in the ignition with it in the off or accessory position.

# Instrument Cluster

---

## **Parking Brake On Warning Chime**

Sounds when you have left the parking brake on and drive your vehicle. If the warning chime remains on after you have released the parking brake, have the system checked by your authorized dealer immediately.

# Information Displays

## GENERAL INFORMATION

### WARNING



Driving while distracted can result in loss of vehicle control, crash and injury. We strongly recommend that you use extreme caution when using any device that may take your focus off the road. Your primary responsibility is the safe operation of your vehicle. We recommend against the use of any hand-held device while driving and encourage the use of voice-operated systems when possible. Make sure you are aware of all applicable local laws that may affect the use of electronic devices while driving.

You can control various systems on your vehicle using the information display controls on the steering wheel. The information display provides the corresponding information.

## Information Display Controls (Type 1)



E163177

- Press the INFO button to scroll through trip, outside temperature, fuel usage, trailer gain and MyKey® information.
- Press the SETUP button to scroll through various vehicle feature settings.
- Press the RESET button to choose settings, reset information and confirm messages.

### Info

Press the INFO button repeatedly to cycle through the following features:

**Note:** *Some options may appear slightly different or not at all if the items are optional.*

# Information Displays

INFO
TRIP A/B
XXX° (if equipped)
MYKEY MILES (km) (if programmed)
XXX MILES (km) TO E
XX.X AVG MPG (L/100km)
MPG (L/km)
TIMER
TBC GAIN (if equipped)
EXHAUST FILTER (diesel only)

## TRIP A/B

Registers the distance of individual journeys. Press and release the INFO button until TRIP A/B appears in the display (this represents the trip mode). Press and hold the RESET button to reset.

## XXX° (outside air temperature)

This displays the outside temperature.

## MYKEY MILES (km)

For more information, See **Principle of Operation** (page 51).

## XXX MILES (km) TO E

This displays an estimate of approximately how far you can drive with the fuel remaining in your tank under normal driving conditions. Remember to turn the ignition off when refueling to allow this feature to detect the correct amount of added fuel.

The system calculates the distance to empty by using a running average fuel economy, which uses your recent driving history of 500 miles (800 km).

This value is not the same as the average fuel economy display. The running average fuel economy resets to a factory default value if the battery is disconnected.

## XX.X AVG MPG (L/100km)

Average fuel economy displays your average fuel economy in miles per gallon or liters/100 km.

## MPG (L/km)

Displays the instantaneous fuel economy as a bar graph. Your vehicle must be moving to calculate instantaneous fuel economy. You cannot reset the instantaneous fuel economy.

## TIMER

Displays the trip elapsed drive time. Press and release RESET to pause the timer. Press and hold RESET to reset the timer.

## TBC GAIN

Displays the level of trailer brake gain or if the trailer is not connected.



# Information Displays

## EXHAUST FILTER

For more information, refer to the Diesel supplement.

## System check and vehicle feature customization

Press the SETUP button repeatedly to cycle the information display through the following features:

**Note:** Some options may appear slightly different or not at all if the items are optional.

**Note:** When returning to the SETUP menu and you selected a non-English language, HOLD RESET FOR ENGLISH will display to change back to English. Press and hold the RESET button to change back to English.

SETUP		
RESET FOR SYSTEM CHECK	press the RESET button	OIL LIFE
		EXHAUST FLUID LEVEL (Diesel only)
		ENGINE HOURS
		ENGINE IDLE HOURS
		CHARGING SYSTEM
		DOOR
		BRAKE SYSTEM
		TBC GAIN = XX.X
		FUEL LEVEL
		MYKEY DISTANCE

SETUP (cont'd)		
RESET FOR SYSTEM CHECK	press the RESET button	MYKEY(S) PROGRAMMED
		ADMIN KEYS PROGRAMMED
OIL LIFE		
UNITS	press the RESET button	English or Metric
AUTOLAMP (SEC)		0 to 180 seconds
AUTOLOCK		On or Off
AUTOUNLOCK		On or Off
COURTESY WIPE		On or Off

# Information Displays

SETUP (cont'd)		
REMOTE WINDOW OPEN		On or Off
CREATE MYKEY / MYKEY SETUP / CLEAR MYKEY		
RESET FOR REMOTE START	press the RESET button	On or Off
		5, 10, 15 minutes
TBC MODE		Electric or EOH
TBC EFFORT		LOW, MED or HIGH
TRAILER SWAY		On or Off
LANGUAGE = ENGLISH / SPANISH / FRENCH		English / Spanish / French

## PRESS RESET FOR SYSTEM CHECK

The information display will begin to cycle through the vehicle systems and provide a status of the item if needed.

**Note:** *Some systems show a message only if a condition is present*

## OIL LIFE

Displays the remaining oil life. An oil change is required whenever indicated by the information display and according to the recommended maintenance schedule. USE ONLY RECOMMENDED ENGINE OILS.

To reset the oil monitoring system to 100% after each oil change, perform the following:

1. Press and release the SETUP button to display OIL LIFE XXX% HOLD RESET = NEW.
2. Press and hold the RESET button for two seconds and release to reset the oil life to 100%.

**Note:** *To change oil life 100% value (if equipped with this feature) to another value, proceed to Step 3.*

3. Once OIL LIFE SET TO XXX% is displayed, release and press the RESET button to change the Oil Life Start Value. Each release and press will reduce the value by 10%.

## UNITS

Displays the current units English or Metric

## AUTOLAMP (SEC)

This feature keeps your headlights on for up to three minutes after the ignition is switched off.

## AUTOLOCK

This feature automatically locks all vehicle doors when the vehicle is shifted into any gear, putting the vehicle in motion.

## AUTOUNLOCK

This feature automatically unlocks all vehicle doors when the driver's door is opened within 10 minutes of the ignition being turned off.

# Information Displays

## COURTESY WIPE

This feature allows for an extra swipe of the wipers after a wipe/wash cycle.

## CREATE MYKEY / MYKEY SETUP / CLEAR MYKEY

For more information, See **Creating a MyKey** (page 51).

## RESET FOR REMOTE START (if equipped)

## REAR PARK AID

This feature sounds a warning tone to warn the driver of obstacles near the rear bumper, and functions only when R (Reverse) gear is selected.

## TBC MODE (if equipped)

Allows you to choose the trailer brake mode.

## TBC EFFORT (if equipped)

Allows you to choose the level of initial braking.

## TRAILER SWAY (if equipped)

This feature uses the electronic stability control to mitigate trailer sway.

## LANGUAGE = ENGLISH / SPANISH / FRENCH

Allows you to choose which language the message center will display in.

Waiting four seconds or pressing the RESET button cycles the message center through each of the language choices.

Press the RESET button to set the language choice.

## Information Display Controls (Type 2) (If Equipped)



E163178

- Press the up and down arrow buttons to scroll through and highlight the options within a menu.
- Press the right arrow button to enter a sub-menu.
- Press the left arrow button to exit a menu.
- Press the OK button to choose and confirm a setting/messages.

## Main menu

You can access the menus using the information display control.



Gauge Mode

# Information Displays



Trip A / B



Fuel Economy



Truck Apps (If Equipped)



Settings



Information

## Display Mode



Use the arrow buttons to choose between the following gauge options.

Gauge Mode		
Gauges Detail	Engine Oil Temperature (Diesel only)	
	Transmission Temperature	
	Compass	The compass orientation can be changed between fixed north or rotating north. To change the modes, press OK when the compass display is shown. Use the right arrow to choose the mode. Press and hold OK to set the mode.
	Exhaust Filter (diesel only). Refer to your diesel supplement for more information.	
	Blank	

## Trip A / B



Use the arrow buttons to choose between the following trip options.

# Information Displays

<b>Trip A / B</b>
Trip time
Trip distance
Fuel used
Avg MPG (L/100km)
Odometer

Press OK to pause the Trip A or B screen, press again to un-pause.

Press and hold OK to reset the currently displayed trip information.

### **Trip time**

This shows the elapsed trip time. The timer will stop when your vehicle is turned off and will restart when your vehicle is restarted.

### **Trip distance**

Registers the mileage of individual journeys.

### **Fuel used**

Shows the amount of fuel used for a given trip.

### **Average MPG**

Shows the average distance traveled per unit of fuel used for a given trip.

### **Fuel Economy**



Use the arrow buttons to choose the desired fuel economy display.

<b>Fuel Economy</b>	
Fuel Econ.	Instant MPG (L/100km)
	Miles (kilometers) to Empty
	AVG MPG (L/100km)
Fuel Hist.	5, 10, 30 Minutes or Last 5 Resets

### **Instant MPG**

Shows your instantaneous fuel usage.

### **Miles to empty**

Shows the approximate distance your vehicle can travel before running out of fuel.

### **Average MPG**

Shows the average fuel usage based on time. Press and hold OK to reset this value.

# Information Displays

## Fuel Hist.

Shows fuel usage as a bar graph based on time. The graph is updated each minute with the fuel economy that was achieved during the prior 5, 10, 30 minutes of driving.

## Truck Apps



In this mode, off-road information depicted with graphics and trailer towing application options are available.

**Note:** Some items are optional and may not appear.

Truck Apps			
Off Road	Pitch and bank angle (in degrees)		
	Steering angle (in degrees)		
	Differential lock/unlock		
	Energy flow		
	Press OK for Info	ELD (Electronic Locking Differential)	
		Hill Descent Control	
4X4 System			
Traction Control			
	AdvanceTrac + RSC		
Trailer	Active trailer name or default trailer		
	Accumulated trailer distance		
	Trailer gain and output		
	Trailer Disconnected		
	Press OK for options	Options	
		Change Active Trailer	
		Adding a new trailer	
		Connection Checklist (if equipped)	Conventional, Fifth Wheel or Gooseneck
		Delete Trailer	
	Information Screen	Tow / Haul or Trailer Brake Controller	

# Information Displays

Truck Apps (cont'd)		
Trailer (cont'd)	Press OK for options	Rename Trailer
		Reset Trailer Mileage / Kilometers (if equipped)

## Trailer disconnected

Disregard this status if your vehicle is not equipped with a factory installed trailer brake controller. This message may appear when an aftermarket TBC is used even when the trailer is connected.

## Change Active Trailer

When this is highlighted, press the right arrow key to change the currently selected trailer. Use the up and down arrows to select a trailer and press the OK button to choose the highlighted trailer.

## Adding a new trailer

Use the up/down arrows to highlight New Trailer and press the right arrow key to enter the New Trailer input screen. Use the up/down arrow keys to choose alpha, numeric and symbol characters and then press the right arrow to move the character space over. Continue adding characters as needed. Press the left arrow to go back and change a previously selected character. When finished with the new trailer name, press OK to accept the new trailer name.

## Connection Checklist

Use the up/down arrows to highlight one of these choices and press OK to display the connection checklist. Follow the on-screen instructions to go through the connections list.

## Delete Trailer

Use the up/down arrows to highlight the trailer you want to delete and press OK to delete. Follow the on-screen prompts to exit or confirm delete.

## Rename Trailer

Use the up/down buttons to highlight a trailer and press OK to select it. Use the up/down arrow buttons to change the characters as needed. When done, press OK to accept the change.

## Reset Trailer Mileage / Kilometers

Use the up/down buttons to select a trailer, then press and hold OK to reset the trailer mileage (kilometers).

## Settings



Use the arrow buttons to configure different driver setting choices.

**Note:** Some items are optional and may not appear.

## Information Displays

<b>Settings</b>			
Driver Assist	Rear Park Aid	On or Off	
	Rear Video Camera	Camera Delay	On or Off
	Trailer Brake	Mode	Electric or Elect. Over Hydraulic
		Effort	Light, Medium or Heavy
Trailer Sway Control	On or Off		
Vehicle	Autolamp Delay	Off or XXX seconds	
	DTE Calculation (distance to empty)	Normal	
		Towing	
	Easy Entry/Exit	On or Off	
	Locks	Autolock	On or Off
		Autounlock	On or Off
		Unlocking	One Stage or Two Stage
	Maintenance	Coolant (if equipped)	Hold OK if Coolant Changed
Fuel Filter (diesel only)		Hold OK if Fuel Filter Changed	

<b>Settings (cont'd)</b>			
Vehicle (cont'd)	Menu Control	Standard or Memory On	
	Oil Life Reset	Set to XXX% (Hold OK to Reset)	
	Remote Start	Duration	5, 10 or 15 minutes
		System	Enable or Disable
	Windows	Remote Open	On or Off
	Wiper Control	Courtesy Wipe - On or Off	



# Information Displays

Settings (cont'd)		
MyKey	Create MyKey	Hold OK to Create MyKey
	AdvanceTrac	Always On or Selectable
	MAX Speed	80 MPH (130 km/h) or Off
	Speed Warning	45, 55 or 65 MPH (75, 90 or 105 km/h), Off
	Volume Limiter	On or Off
	Clear MyKey	Hold OK to Clear MyKey
Language	English, Français, Español	
Units	Distance	English
		Metric
	Temperature	Fahrenheit (°F)
		Celsius (°C)

## Information



In this mode, you can view different vehicle system information and perform a system check.

Information	
MyKey	Admin Keys (Number of admin keys)
	MyKeys (Number of MyKeys programmed)
	MyKey Miles (km) (Distance traveled using a programmed MyKey)
System Check	Some items will only display during a system check if a problem has been detected. If an issue exists on one of the monitored systems, the number of warnings that need immediate attention will display in red and the number of informational warnings will display in amber. Use the up/down arrow buttons to scroll through the list; press the right arrow button to display specific information on the highlighted warning

# Information Displays

## Compass/Transmission indicator display (if equipped)

The compass heading will display in the upper right corner of the information display; the transmission gear indicator displays in the right side of the information display when using the SelectShift Automatic™ transmission feature. These displays will not be shown in all screen modes. For example: when programming certain vehicle features or in certain information menus.

## INFORMATION MESSAGES

**Note:** *Depending on your vehicle options and instrument cluster type, not all of the messages will display or be available. Additionally, the information display may abbreviate or shorten certain messages.*

Press the RESET button for Type 1 displays or the OK button for Type 2 displays to acknowledge and remove some messages from the information display. The information display will automatically remove other messages after a short time.

You need to confirm certain messages before you can access the menus.

## AdvanceTrac™

Message	Action
SERVICE ADVAN- CETRAC	The system detects a condition that requires service. Have the system checked by an authorized dealer.
ADVANCETRAC OFF	The driver has disabled the stability control system. See <b>Using Stability Control</b> (page 169).
TRACTION CONTROL OFF	The driver has disabled the traction control system. See <b>Using Traction Control</b> (page 167).

## Alarm

Message	Action
TO STOP ALARM START VEHICLE	An unauthorized entry has triggered the alarm. See <b>Anti-Theft Alarm</b> (page 61).
SECURITY SYSTEM FAULT	The security system has detected a fault. Have the system checked by an authorized dealer.

# Information Displays

## Diesel Messages

### WARNING



When the CLEANING EXHAUST FILTER message appears in the information display, do not park near flammable materials, vapors or structures until filter cleaning is complete.

Message	Action
CHECK COOLANT ADDITIVE	The coolant additive needs checking. Refer to your diesel supplement for more information.
CLEANING EXHAUST FILTER	Your vehicle has entered the cleaning mode. Various engine actions will raise the exhaust temperature in the Diesel Particulate Filter system to burn off the particles (exhaust soot). After the vehicle burns the particles off the exhaust temperature will return to normal levels. This message is NORMAL. Refer to your diesel supplement for more information.
EXHAUST OVER-LOADED DRIVE TO CLEAN EXHAUST AT LIMIT DRIVE TO CLEAN NOW	<p>The diesel particulate filter is full of particles (exhaust soot) and you are not operating the vehicle in a manner that allows normal cleaning. One of these messages will stay on until the exhaust filter cleaning has begun, at which time the CLEANING EXHAUST FILTER message displays. We recommend you drive the vehicle above 30 mph (48 km/h) until the CLEANING EXHAUST FILTER message turns off. Refer to your diesel supplement for more information.</p> <p>The diesel particulate filter will continue to fill with particles (exhaust soot) if you ignore this message. The service engine soon light will illuminate and engine power may be limited, if cleaning is not permitted. Dealer service will then be required to restore your vehicle to full-power operation.</p>
STOP SAFELY NOW	Your vehicle exhaust system temperature exceeds intended operating range. If this warning occurs, a chime will sound, followed by reduced engine power. The engine will shut down when your vehicle speed is below 3 mph (5 km/h). Stop the vehicle as soon as safely possible. Have the system checked by an authorized dealer.
ENGINE OIL DILUTED	The diluted engine oil needs to be changed. Refer to your diesel supplement for more information.

## Information Displays

<b>Message</b>	<b>Action</b>
ENGINE TURNS OFF IN 1 SECOND	The powertrain control module will intentionally turn the engine off due to your vehicle being in the final second of a countdown. The diesel engine shutdown is a (regulatory) requirement, which may be required of a particular diesel vehicle for sale in states requiring this feature. Refer to your diesel supplement for more information..
ENGINE TURNS OFF IN XX SECONDS	The powertrain control module will intentionally turn the engine off due to your vehicle being in the final 30 seconds of a countdown. The diesel engine shutdown for extended idling is an optional feature. Refer to your diesel supplement for more information.
ENGINE TURNED OFF	Appears after the 30 second countdown. Refer to your diesel supplement for more information.
ENGINE WARMING PLEASE WAIT	In extremely cold weather, typically below $-15^{\circ}\text{F}$ ( $-26^{\circ}\text{C}$ ) and if the engine block heater is not utilized, your engine will not respond to accelerator pedal movement for 30 seconds. This restriction allows your engine to circulate the oil properly in order to avoid engine damage. Refer to your diesel supplement for more information.
EXHAUST FILTER DRIVE COMPLETE	Your diesel particulate filter is clean. Refer to your diesel supplement for more information.
EXHAUST FILTER CLEANED	Your diesel particulate filter is clean. Refer to your diesel supplement for more information.
EXHAUST CLEAN STOPPED	The manual operator commanded regeneration process has stopped. Refer to your diesel supplement for more information.
EXHAUST FLUID RANGE XXX MI	The distance you can travel before depleting the remaining diesel exhaust fluid. Refer to your diesel supplement for more information.
IN XX MILES, SPEED LIMITED TO XX MPH EXHAUST FLUID EMPTY	Your diesel exhaust fluid is nearing empty. Your vehicle's top speed will become limited in the displayed distance. You must replenish the diesel exhaust fluid to resume normal operation of your vehicle. Refer to your diesel supplement for more information.
SPEED LIMITED TO XX MPH UPON RESTART EXHAUST FLUID EMPTY	Your remaining diesel exhaust fluid has depleted. Your speed will be limited upon restart. You must replenish the diesel exhaust fluid to resume normal operation of your vehicle. Refer to your diesel supplement for more information.

## Information Displays

Message	Action
SPEED LIMITED TO XX MPH EXHAUST FLUID EMPTY	The diesel exhaust fluid is empty. You must replenish the diesel exhaust fluid to resume normal operation of your vehicle. Refer to your diesel supplement for more information.
ENGINE IDLED SOON EXHAUST FLUID EMPTY	The selective catalytic reduction system detects low exhaust fluid. The engine will eventually enter into an idle only mode. You must replenish the diesel exhaust fluid to resume normal operation of your vehicle. Refer to your diesel supplement for more information.
ENGINE IDLED - SEE OWNER'S MANUAL EXHAUST FLUID EMPTY	A problem exists with the selective catalytic reduction system. The vehicle will enter into an idle-only mode. If the exhaust fluid is empty, you must replenish the diesel exhaust fluid to resume normal operation of your vehicle. Refer to your diesel supplement for more information.
IN XX MILES, SPEED LIMITED TO 50 MPH EXHAUST FLUID SYSTEM FAULT	The selective catalytic reduction system detects a fault. The vehicle's top speed will become limited in the displayed distance starting at 50 miles (80 km) and count down from this point. Refer to your diesel supplement for more information. Have the system checked by an authorized dealer.
SPEED LIMITED TO 50 MPH UPON RESTART EXHAUST FLUID SYSTEM FAULT	The selective catalytic reduction system detects a fault. The vehicle's top speed will become limited upon restarting. Refer to your diesel supplement for more information. Have the system checked by an authorized dealer.
SPEED LIMITED TO 50 MPH EXHAUST FLUID SYSTEM FAULT	The selective catalytic reduction system detects a fault. The vehicle's top speed is limited. Refer to your diesel supplement for more information. Have the system checked by an authorized dealer.
ENGINE IDLED SOON EXHAUST FLUID SYSTEM FAULT SEE MANUAL	The selective catalytic reduction system detects a fault. The engine will enter into an idle only mode. Refer to your diesel supplement for more information. Have the system checked by an authorized dealer.
ENGINE IDLED - SEE OWNER'S MANUAL EXHAUST FLUID SYSTEM FAULT	The selective catalytic reduction system detects a fault. The engine will eventually enter into an idle-only mode. Press OK to override the idle mode. Refer to your diesel supplement for more information. Have the system checked by an authorized dealer.
FUEL FILTER CHANGE REQUIRED	A fuel filter change is required. See <b>Normal Scheduled Maintenance</b> (page 460).

## Information Displays

Message	Action
EXHAUST OVER LIMIT SERVICE NOW	You must have your vehicle serviced by an authorized dealer if approximately two hours after the EXHAUST OVERLOADED DRIVE TO CLEAN message has displayed and you have not driven your vehicle above 30 mph (48 km/h) for at least 20 minutes to clean the diesel particulate filter. Refer to your diesel supplement for more information. You are responsible for assuring that you operate your vehicle in a manner that allows diesel particulate filter cleaning to occur. Ignoring the EXHAUST OVER LIMIT SERVICE NOW warning message could lead to reduced drivability and customer expense, including damage to the diesel particulate filter. Your new vehicle warranty may not cover this damage.
WATER IN FUEL DRAIN FILTER SEE MANUAL	The water separator has reached a predetermined capacity and needs draining. Refer to your diesel supplement for more information.
LOW FUEL PRESSURE	A low fuel pressure condition has occurred due to cold, low fuel level or fuel filters need to be changed. Refer to your diesel supplement for more information.

### Doors and Locks

Message	Action
X Door Ajar	The door listed is not completely closed.

### Drivetrain

Message	Action
LOCKING DIFFERENTIAL ENGAGED	The electronic locking differential is engaged.
ELD ENGAGED	
LOCKING DIFFERENTIAL DISENGAGED	The electronic locking differential is disengaged.
ELD DISENGAGED	
TO ENGAGE LOCKING DIFFERENTIAL SLOW TO XX MPH/KM/H	The electronic locking differential requests a certain speed requirement to engage.

## Information Displays

Message	Action
TO ENGAGE ELD SLOW TO XX MPH/KM/H	
TO ENGAGE LOCKING DIFFERENTIAL RELEASE ACCELERATOR PEDAL	The electronic locking differential request the release of the accelerator pedal in order to engage.
TO ENGAGE ELD RELEASE PEDAL	
SLOW VEHICLE TO XX KM/H FOR ELD	The electronic locking differential requests a certain speed requirement to engage.
SLOW VEHICLE TO XX MPH FOR ELD	The electronic locking differential requests a certain speed requirement to engage.
CHECK LOCKING DIFFERENTIAL	An electronic locking differential system fault is present. See <b>Using Four-Wheel Drive</b> (page 153).
SHIFT TO PARK	A reminder to shift into park.

## Engine

Message	Action
TRANSPORT MODE CONTACT DEALER	Your vehicle is set to transport mode. The transport mode disables certain vehicle functions to prevent battery discharge.
POWER REDUCED TO LOWER ENGINE TEMP	The engine has reduced power in order to help reduce high coolant temperature See <b>Engine Coolant Check</b> (page 236).

## Fuel

Message	Action
FUEL LEVEL LOW	An early reminder of a low fuel condition.
CHECK FUEL CAP	The fuel cap may not be properly closed.

# Information Displays

## Key

Message	Action
COULD NOT PROGRAM INTEGRATED KEY	You have attempted to program a fifth integrated key. See <b>Replacing a Lost Key or Remote Control</b> (page 50).
TO DRIVE: TURN KEY TO ON	The factory equipped remote start is active. Turn your key to on to drive.

## Maintenance

Message	Action
ENGINE OIL CHANGE SOON	The engine oil life is nearing its end. See <b>Engine Oil Check</b> (page 235).
OIL CHANGE REQUIRED	The oil life left reaches 0%. See <b>Engine Oil Check</b> (page 235).
BRAKE FLUID LEVEL LOW	The brake fluid level is low and the brake system needs inspection immediately. See <b>Brake Fluid Check</b> (page 243).
CHECK BRAKE SYSTEM	The brake system needs servicing. If the warning stays on or continues to come on, have the system checked by an authorized dealer as soon as possible.

## MyKey®

Message	Action
MYKEY ACTIVE DRIVE SAFELY	MyKey is active.
ADVANCETRAC ALWAYS ON - MYKEY SETTING	A MyKey is in use and you cannot turn off the electronic stability control.
VEHICLE NEAR TOP SPEED	A MyKey is in use, the MyKey speed limit is on and your vehicle speed is approaching 80 mph (130 km/h).
VEHICLE AT TOP SPEED - MYKEY SETTING	A MyKey is in use, the MyKey speed limit is on and your vehicle speed is 80 mph (130 km/h).
SPEED LIMITED TO 80 MPH	When starting your vehicle and MyKey is in use and the MyKey speed limit is on.
SPEED LIMITED TO 130 KM/H	When starting your vehicle and MyKey is in use and the MyKey speed limit is on.



## Information Displays

Message	Action
CHECK SPEED DRIVE SAFELY	A MyKey is in use, the optional setting is on and your vehicle exceeds a preselected speed.
BUCKLE UP TO UNMUTE AUDIO	A MyKey is in use and Belt-Minder® is active.
MYKEY COULD NOT PROGRAM	An attempt failed to program a spare key using two existing MyKeys.

### Park Aid

Message	Action
CHECK REAR PARK AID	The transmission is in <b>R</b> (Reverse) and the park aid is disabled.
REAR PARK AID OFF	The rear park aid is disabled.
REAR PARK AID ON	The rear park aid is enabled.

### Park Brake

Message	Action
PARK BRAKE ENGAGED	The parking brake is set and your vehicle is in motion.

### Power Steering

Message	Action
SERVICE POWER STEERING	The power steering system has detected a condition that requires service. Have the system checked by an authorized dealer.
SERVICE POWER STEERING NOW	The power steering system has detected a condition within the power steering system that requires service immediately. Have the system checked by an authorized dealer.
POWER STEERING ASSIST FAULT	The power steering system has disabled power steering assist due to a system error. Have the system checked by an authorized dealer.

# Information Displays

## Off Road

Message	Action
HILL DESCENT CONTROL OFF	The driver has disabled hill descent control mode.
FOR HILL DESCENT REDUCE SPEED	You have not met the vehicle speed requirement for entry into off-road mode.
FOR HILL DESCENT SELECT GEAR	The driver is able to select a transmission gear for hill descent mode.
HILL DESCENT - DRIVER RESUME CONTROL	Hill descent control mode is no longer active and the driver must resume control.
HILL DESCENT CONTROL FAULT	A hill descent system fault is present.
HILL DESCENT CONTROL OFF SYSTEM COOLING	The hill descent system is cooling due to overuse.
HILL DESCENT CONTROL READY	Hill descent control is active.

## Tire Pressure Monitoring System

Message	Action
LOW TIRE PRESSURE	One or more tires on your vehicle have low tire pressure. See <b>Tire Pressure Monitoring System</b> (page 283).
TIRE PRESSURE MONITOR FAULT	The tire pressure monitoring system is malfunctioning. If the warning stays on or continues to come on, have the system checked by an authorized dealer. See <b>Tire Pressure Monitoring System</b> (page 283).
TIRE PRESSURE SENSOR FAULT	A tire pressure sensor is malfunctioning, or your spare tire is in use. For more information on how the system operates under these conditions, see <b>Tire Pressure Monitoring System</b> (page 283). If the warning stays on or continues to come on, have the system checked by an authorized dealer as soon as possible.

## Information Displays

### Trailer

Message	Action
TRAILER BRAKE GAIN: XX.X [OUTPUT]	The current gain setting for the trailer brake.
TRAILER BRAKE GAIN: XX.X NO TRAILER	The current gain setting for the trailer brake when a trailer is not connected.
TRAILER BRAKE MODULE FAULT	Accompanied by a single chime, in response to faults sensed by the TBC. See <b>Trailer Sway Control</b> (page 192).
TRAILER CONNECTED	A correct trailer connection (a trailer with electric trailer brakes) is sensed during a given ignition cycle.
TRAILER DISCONNECTED	A trailer connection becomes disconnected, either intentionally or unintentionally, and has been sensed during a given ignition cycle. Disregard this status if your vehicle is not equipped with a factory installed trailer brake controller. This message may appear when an aftermarket TBC is used even when the trailer is connected.
TRAILER SWAY REDUCE SPEED	Your trailer sway control has detected trailer sway so you need to reduce your speed.
WIRING FAULT ON TRAILER	Faults with your vehicle wiring and trailer wiring or brake system. See <b>Towing a Trailer</b> (page 191).

### 4WD

Message	Action
CHECK 4X4	A fault is present in your 4X4 system. See <b>Using Four-Wheel Drive</b> (page 153).
4X4 SHIFT IN PROGRESS	Your 4X4 system is making a shift.
FOR 4X4 LOW APPLY BRAKE	You need to apply the brake in order to shift into 4X4 LOW.
FOR 4X4 LOW SHIFT TO N	When your vehicle is at a stop and you need to shift into Neutral before you select 4X4 LOW.
FOR 4X4 LOW SLOW TO 3 MPH	When your vehicle is moving and you need to reduce your speed to select 4X4 LOW.

## Information Displays

---

<b>Message</b>	<b>Action</b>
TO EXIT 4X4 LOW APPLY BRAKE	You select 2WD and need to apply the brakes in order to exit 4X4 LOW.
TO EXIT 4X4 LOW SHIFT TO N	You select 2WD while your vehicle is at a stop in 4X4 LOW and you need to shift into Neutral.
TO EXIT 4X4 LOW SLOW TO 3 MPH	You select 2WD while your vehicle is operating in 4X4 LOW and you need to reduce your speed.
SHIFT DELAYED PULL FORWARD	May display when shifting to or from 4X4 LOW.

# Climate Control

## MANUAL CLIMATE CONTROL

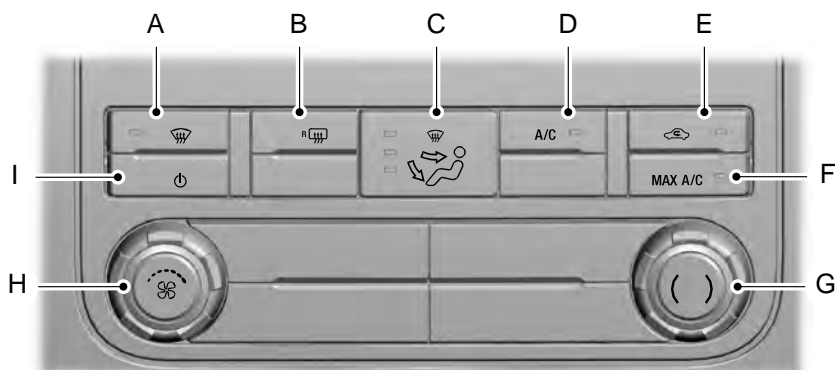

E163163

- A **Defrost:** Press the button to distribute air to the windshield vents and de-mister. Air distribution to instrument panel and footwell vents turn off. You can use this setting to defog and clear the windshield of a thin covering of ice.
- B **Rear defrost and heated mirrors:** Turns the heated mirrors off and on as well as the heated rear window, if your vehicle has that feature. See **Heated Windows and Mirrors** (page 111).
- C **Air distribution control:** Press these buttons to turn airflow from the windshield, instrument panel, or footwell vents on or off. The system can distribute air through any combination of these vents.
- D **A/C:** Press the button to turn air conditioning compressor on or off. Use air conditioning with recirculated air to improve cooling performance and efficiency.  
**Note:** In certain conditions, the air conditioning compressor may continue to operate even after you switch off the air conditioning with the **A/C** button.
- E **Recirculated air:** Press the button to switch between outside air and recirculated air. When recirculated air is selected, the air currently in the passenger compartment recirculates. This may reduce the time needed to cool the interior (when used with **A/C**) and may also reduce unwanted odors from entering your vehicle.  
**Note:** Recirculated air may turn off automatically (or be prevented from turning on) in all airflow modes except **MAX A/C** to reduce risk of fogging.

# Climate Control

- F **MAX A/C:** Turn the temperature control dial all the way past the full cool position to maximize cooling. Recirculated air flows through the instrument panel vents, air conditioning automatically turns on, the fan automatically adjusts to the highest speed and the temperature dial returns to the full cool position.
- G **Temperature control:** Controls the temperature of the airflow in your vehicle. Adjust to select the desired temperature.
- H **Fan speed control:** Controls the volume of air circulated in your vehicle. Adjust to select the desired fan speed.
- I **Power:** Press the button to turn the system on and off. Switching off the climate control system prevents outside air from entering the vehicle.

## AUTOMATIC CLIMATE CONTROL

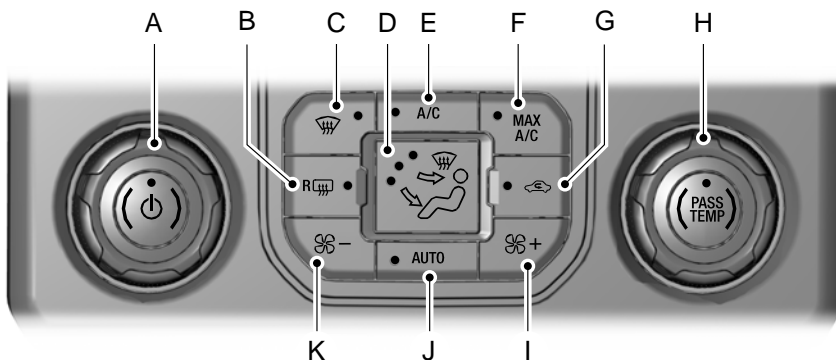

E163164

- A **Power and Driver temperature control:** Press the button to turn the system on and off. Switching off the climate control system prevents outside air from entering the vehicle. Turn to increase or decrease the air temperature for the driver side of the vehicle. This control also adjusts the passenger side temperature when not in dual zone mode.
- B **Heated rear window:** Turns the heated rear window on and off. See **Heated Windows and Mirrors** (page 111).

# Climate Control

---

- C **Defrost:** Press the button to distribute air to the windshield vents and de-mister. Air distribution to instrument panel and footwell vents turn off. You can use this setting to defog and clear the windshield of a thin covering of ice.
- D **Air distribution control:** Press these buttons to turn airflow from the windshield, instrument panel, or footwell vents on or off. The system can distribute air through any combination of these vents.
- E **A/C:** Press the button to turn air conditioning compressor on or off. Use air conditioning with recirculated air to improve cooling performance and efficiency.  
**Note:** In certain conditions, the air conditioning compressor may continue to operate even after you switch off the air conditioning with the **A/C** button.
- F **MAX A/C:** Press the button to maximize cooling. Recirculated air flows through the instrument panel vents, air conditioning automatically turns on, and the fan automatically adjusts to the highest speed.
- G **Recirculated air:** Press the button to switch between outside air and recirculated air. When you select recirculated air, the air currently in the passenger compartment recirculates. This may reduce the time needed to cool the interior (when used with **A/C**) and may reduce unwanted odors from entering your vehicle.  
**Note:** Recirculated air may turn off automatically (or be prevented from turning on) in all airflow modes except **MAX A/C** to reduce risk of fogging. Recirculated air may also turn on and off automatically in **Panel** or **Panel and Floor** airflow modes during hot weather in order to improve cooling efficiency.
- H **PASSTEMP:** Turn to increase or decrease the air temperature on the passenger side of the vehicle. This turns on dual zone mode.
- I **Fan speed control +:** Press to increase the volume of air circulated in your vehicle.
- J **AUTO:** Press the button to turn on automatic operation. Select the desired temperature using the temperature control. The system adjusts fan speed, air distribution, air conditioning operation, and selects outside air or recirculated air to heat or cool the vehicle in order to maintain the desired temperature. You can also use the **AUTO** button to turn off dual zone operation by pressing and holding the button for more than two seconds.
- K **Fan speed control -:** Press to decrease the volume of air circulated in your vehicle.

# Climate Control

## HINTS ON CONTROLLING THE INTERIOR CLIMATE

### General Hints

**Note:** Prolonged use of recirculated air may cause the windows to fog up.

**Note:** You may feel a small amount of air from the footwell air vents regardless of the air distribution setting.

**Note:** To reduce humidity build-up inside your vehicle, do not drive with the system switched off or with recirculated air always switched on.

**Note:** Do not place objects under the front seats as this may interfere with the airflow to the rear seats.

**Note:** Remove any snow, ice or leaves from the air intake area at the base of the windshield.

**Note:** To improve the time to reach comfort in hot weather, drive with the windows slightly open for 2-3 minutes after start-up or until your vehicle airs out.

### Manual Climate Control

**Note:** To reduce fogging of the windshield during humid weather, adjust the air distribution control to the windshield air vents position.

### Automatic Climate Control

**Note:** Adjusting the settings when your vehicle interior is extremely hot or cold is not necessary. The system automatically adjusts to heat or cool the cabin to your selected temperature as quickly as possible. For the system to function efficiently, the instrument panel and side air vents should be fully open.

**Note:** If you select **AUTO** during cold outside temperatures, the system directs airflow to the windshield and side window vents. In addition, the fan may run at a slower speed until the engine warms up.

**Note:** If you select **AUTO** during hot outside temperatures, or when the inside of the vehicle is hot, the system automatically uses recirculated air to maximize interior cooling. When the interior reaches the selected temperature, the system automatically switches to using outside air.

## Heating the Interior Quickly

	Vehicle with manual climate control	Vehicle with automatic climate control
1	Adjust the fan speed to the highest speed setting.	Press the <b>AUTO</b> button.
2	Adjust the temperature control to the highest setting.	Adjust the temperature control to the desired setting.
3	Select the footwell air vents using the air distribution buttons.	



# Climate Control

## Recommended Settings for Heating

	Vehicle with manual climate control	Vehicle with automatic climate control
1	Adjust the fan speed to the center setting.	Press the <b>AUTO</b> button.
2	Adjust the temperature control to the midway point of the hot settings.	Adjust the temperature control to the desired setting. Use 72°F (22°C) as a starting point, then adjust the setting as necessary.
3	Select the footwell air vents using the air distribution buttons.	

## Cooling the Interior Quickly

	Vehicle with manual climate control	Vehicle with automatic climate control
1	Press the <b>MAX A/C</b> button.	Press the <b>MAX A/C</b> button.
2	Drive with the windows open for 2-3 minutes.	

## Recommended Settings for Cooling

	Vehicle with manual climate control	Vehicle with automatic climate control
1	Adjust the fan speed to the center setting.	Press the <b>AUTO</b> button.
2	Adjust the temperature control to the midway point of the cold settings.	Adjust the temperature control to the desired setting. Use 72°F (22°C) as a starting point, then adjust the setting as necessary.
3	Select the instrument panel air vents using the air distribution buttons.	

# Climate Control

## Side Window Defogging in Cold Weather

	Vehicle With Manual Climate Control	Vehicle With Automatic Climate Control
1	Select the instrument panel and footwell air vents positions through the air distribution control.	Press the defrost button.
2	Press the <b>A/C</b> button.	Adjust the temperature control to the desired setting. Use 72°F (22°C) as a starting point, then adjust the setting as necessary.
3	Adjust the temperature control to the desired setting.	Direct the instrument panel side air vents toward the side windows.
4	Adjust the fan speed to the highest setting.	Close the instrument panel center vents.
5	Direct the instrument panel side air vents toward the side windows.	
6	Close the instrument panel center vents.	

## HEATED WINDOWS AND MIRRORS

### Heated Rear Window (If Equipped)

**Note:** The engine must be running to use this feature.

**Note:** If your vehicle is equipped with a sliding rear window, the feature still operates when you open the window.

Press the button to clear the rear window of thin ice and fog. Press the button again within 10 minutes to switch it off. It switches off automatically after 10 minutes, or when you switch the ignition off.

**Do not use razor blades or other sharp objects to clean the inside of the rear window or to remove decals from the inside of the rear window. This may cause damage to the heated grid lines. Your warranty does not cover this damage.**

### Heated Exterior Mirror (If Equipped)

**Note:** Do not remove ice from the mirrors with a scraper or attempt to readjust the mirror glass that has frozen in place. These actions could cause damage to the glass and mirrors.

**Note:** Do not clean the housing or glass of any mirror with harsh abrasives, fuel or other petroleum-based cleaning products.

The heated mirrors remove ice, mist and fog when you switch on the heated rear window.

# Climate Control

---

## REMOTE START (If Equipped)

The remote start feature allows you to pre-condition the interior of your vehicle. The climate control system works to achieve comfort according to your previous settings.

**Note:** *You cannot adjust the system during remote start operation.*

Turn the ignition on to return the system to its previous settings. You can now make adjustments normally, but you need to turn certain vehicle-dependent features back on, such as:

- Heated seats.
- Cooled seats.
- Heated steering wheel.
- Heated mirrors.
- Heated rear window.

You can adjust the default remote start settings using the information display controls. See **Information Displays** (page 84).

## Automatic Settings

In hot weather, the system is set to 72°F (22°C). The cooled seats are set to high (if available, and selected to AUTO in the information display).

In moderate weather, the system either heats or cools (based on previous settings). The rear defroster, heated mirrors and heated seats do not automatically turn on.

In cold weather, the system is set to 72°F (22°C). The heated seats are set to high (if available, and selected to AUTO in the information display). The rear defroster and heated mirrors automatically turn on.

# Seats

## SITTING IN THE CORRECT POSITION

### WARNINGS



Sitting improperly, out of position or with the seatback reclined too far can take weight off the seat cushion and affect the decision of the passenger sensing system, resulting in serious injury or death in the event of a crash. Always sit upright against your seat back, with your feet on the floor.



Do not recline the seatback as this can cause the occupant to slide under the safety belt, resulting in serious injury in the event of a crash.



Do not place objects higher than the seatback to reduce the risk of serious injury in the event of a crash or during heavy braking.

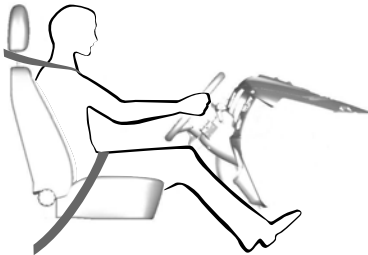

E68595

When you use them properly, the seat, head restraint, safety belt and airbags will provide optimum protection in the event of a crash.

We recommend that you follow these guidelines:

- Sit in an upright position with the base of your spine as far back as possible.
- Do not recline the seatback more than 30 degrees.
- Adjust the head restraint so that the top of it is level with the top of your head and as far forward as possible. Make sure that you remain comfortable.
- Keep sufficient distance between yourself and the steering wheel. We recommend a minimum of 10 in (25 cm) between your breastbone and the airbag cover.
- Hold the steering wheel with your arms slightly bent.
- Bend your legs slightly so that you can press the pedals fully.
- Position the shoulder strap of the safety belt over the center of your shoulder and position the lap strap tightly across your hips.

Make sure that your driving position is comfortable and that you can maintain full control of your vehicle.

## HEAD RESTRAINTS

### WARNINGS



Fully adjust the head restraint before you sit in or operate your vehicle. This will help minimize the risk of neck injury in the event of a crash. Do not adjust the head restraint when your vehicle is moving.



The head restraint is a safety device. Whenever possible it should be installed and properly adjusted when the seat is occupied. An improperly adjusted head restraint may not adequately protect an occupant during an impact from the rear.

# Seats

## WARNINGS



Install the head restraint properly to help minimize the risk of neck injury in the event of a crash.

**Note:** Adjust the seat back to an upright driving position before adjusting the head restraint. Adjust the head restraint so that the top of it is level with the top of your head and as far forward as possible. Make sure that you remain comfortable. If you are extremely tall, adjust the head restraint to its highest position.

### Front Seat Head Restraint

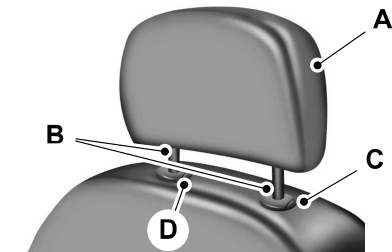

E138642

The head restraints consist of:

- A An energy absorbing head restraint.
- B Two steel stems.
- C Guide sleeve adjust and release button.
- D Guide sleeve unlock and remove button.

### Adjusting the Head Restraint

#### Raising the Head Restraint

Pull the head restraint up.

#### Lowering the Head Restraint

1. Press and hold button C.
2. Push the head restraint down.

#### Removing the Head Restraint

1. Press and hold buttons C and D.
2. Pull the head restraint up.

#### Installing the Head Restraint

Align the steel stems into the guide sleeves and push the head restraint down until it locks.

#### Front Row Center, Outboard (Crew Cab), and Rear Seat Center (Crew Cab) Head Restraints

**Note:** The SuperCab has rear outboard head restraints that are not removable and are bolted to the back wall.

Your vehicle may be equipped with head restraints that are non-adjustable. The non-adjustable head restraints consist of:

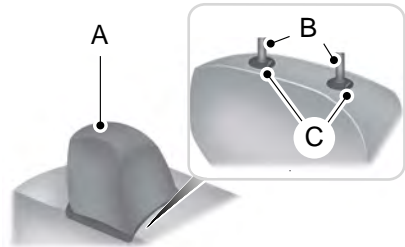

E162872

- A An energy absorbing head restraint.
- B Two steel stems.
- C Guide sleeve unlock and remove button.

# Seats

## Removing the Head Restraint

1. Press and hold buttons C.
2. Pull up the head restraint.

## Installing the Head Restraint

Align the steel stems into the guide sleeves and push the head restraint down until it locks.

## Tilting Head Restraints (If Equipped)

The front head restraints tilt for extra comfort. To tilt the head restraint, do the following:



E144727

1. Adjust the seat back to an upright driving or riding position.
2. Pivot the head restraint forward toward your head to the desired position.

After the head restraint reaches the forward-most tilt position, pivot it forward again to release it to the rearward, un-tilted position.

**Note:** Do not attempt to force the head restraint backward after it is tilted. Instead, continue tilting it forward until the head restraint releases to the upright position.

## MANUAL SEATS

### WARNING



Do not adjust the driver's seat or seat back when your vehicle is moving.

## Moving the Seat Backward and Forward



E162727

## Recline Adjustment



E162728

# Seats

## Manual Lumbar (If Equipped)

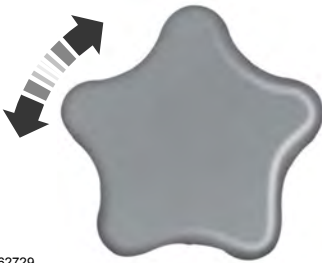

E162729

The lumbar support control is located on the outboard side of the seat. Turn the control to adjust your support.

## Power Recline (If Equipped)



E162731

Move the switch to recline the seatback forward or rearward.

## POWER SEATS (If Equipped)

### WARNINGS



Do not adjust the driver seat or seatback while your vehicle is moving. Adjusting your seatback while the vehicle is in motion may cause loss of control of the vehicle.



Do not place cargo or any objects behind the seatback before returning it to the original position.

## Power Lumbar (If Equipped)

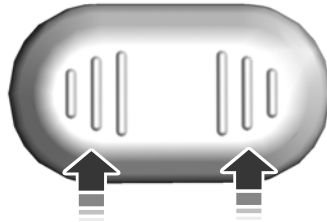

E164101

The control is located on the outboard side of the seat. Press the forward or rearward side of the control for more or less support.

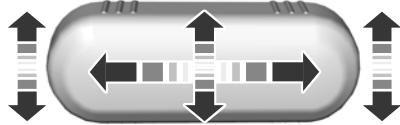

E181777

The control is located on the outboard side of the seat. Move the switch in the direction of the arrow to raise or lower the seat cushion or to move the seat forward, backward, up or down.

## MEMORY FUNCTION (If Equipped)

### WARNINGS



Before activating the seat memory, make sure that the area immediately surrounding the seat is clear of obstructions and that all occupants are clear of moving parts.



Do not use the memory function when your vehicle is moving.

# Seats

This feature will automatically recall the position of the driver seat, power mirrors, and adjustable pedals. The memory control is located on the driver door.



E162734

To program position 1:

1. Move the memory features to the desired positions using the associated controls.
2. Press and hold button 1 for at least two seconds. A tone will sound confirming that a memory position has been set.

To program position 2, repeat the previous procedure using button 2.

You can program the memory feature to a remote entry transmitter. See **Keys and Remote Controls** (page 47).

You can recall a programmed memory position:

- In any gearshift position if the ignition is not on.
- Only in park (P) or neutral (N) if the ignition is on.

You can recall the memory positions when you press your remote entry transmitter unlock control (if you programmed a memory position to the transmitter) or, when you enter a valid personal entry code that is programmed to a memory position. The mirror moves to the programmed position and the seat moves to the easy entry position. The seat will move to the final position when the key is in the ignition (if you enable the easy entry feature).

## **Easy Entry and Exit Feature (If Equipped)**

If you enable the easy entry and exit feature, it automatically moves the driver seat rearward 2 inches (5 centimeters) when you put the transmission in park (P) and remove the key from the ignition.

If the seat is less than 2 inches (5 centimeters) from the rear of the seat track, the seat travel will be less than 2 inches (5 centimeters) rearward.

The driver seat will return to the previous position when you put the key in the ignition.

You can enable or disable this feature through the information display. See **Information Displays** (page 84).

## **REAR SEATS**

### **Folding Up the Rear Seats (SuperCab)**



# Seats



E162737

1. Pull the control to release the seat cushion.
2. Rotate the seat cushion up until it locks into the vertical storage position.

## Returning the Seat to the Seating Position

### WARNING



Make sure that cargo or any objects are not trapped underneath the seat cushion before returning the seat cushion to its original position, and that the seat cushion locks into place. Failure to do so may prevent the seat from operating properly in the event of a crash, which could increase the risk of serious injury.

1. Pull the control on the side of the seat to release the seat cushion from the storage position.
2. Push the seat cushion down until it locks into the horizontal position.

## Folding the Rear Seat Back (Crew Cab)

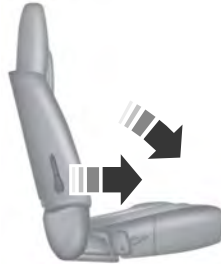

E162738

1. Pull forward on the control to fold down the seatback.
2. Pull down on the handle and lift up on the seatback to return it to the original position.

## Folding up the Rear Seat Cushion

1. Pull the control to release the seat cushion.
2. Rotate the seat cushion up until it locks into the vertical storage position.

## Returning the Seat to the Seating Position

### WARNING



Make sure that cargo or any objects are not trapped underneath the seat cushion before returning the seat cushion to its original position, and that the seat cushion locks into place. Failure to do so may prevent the seat from operating properly in the event of a crash, which could increase the risk of serious injury.

1. Pull the control on the side of the seat to release the seat cushion from the storage position.
2. Push the seat cushion down until it locks into the horizontal position.

# Seats

## Rear Under Seat Storage (Crew Cab) (If Equipped)

The rear seat has storage space located under the seat cushion.

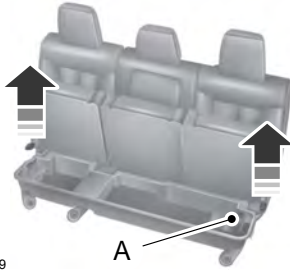

E162739

Lift up the lever and flip up the seat cushion to access the storage space and the power point (A).

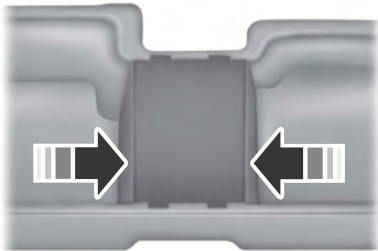

E162740

To remove the storage space divider, squeeze the sides and lift it from the storage tub.



E162741

Use your vehicle key to lock the storage space.

## HEATED SEATS (If Equipped)

### WARNING



People who are unable to feel pain to their skin because of advanced age, chronic illness, diabetes, spinal cord injury, medication, alcohol use, exhaustion or other physical conditions, must exercise care when using the heated seat. The heated seat may cause burns even at low temperatures, especially if used for long periods of time. Do not place anything on the seat that insulates against heat, such as a blanket or cushion. This may cause the heated seat to overheat. Do not puncture the seat with pins, needles or other pointed objects. This may damage the heating element which may cause the heated seat to overheat. An overheated seat may cause serious personal injury.

Do not do the following:

- Place heavy objects on the seat.
- Operate the heated seat if water or any other liquid is spilled on the seat. Allow the seat to dry thoroughly.
- Operate the heated seats unless the engine is running. Doing so can cause the battery to lose charge.

# Seats



E146322

To operate the heated seats, touch the heated seat symbol on the touchscreen to cycle through the various heat settings and off. Warmer settings are indicated by more indicator lights.

## Rear Heated Seats (If Equipped)

### WARNING



Persons who are unable to feel pain to the skin because of advanced age, chronic illness, diabetes, spinal cord injury, medication, alcohol use, exhaustion, or other physical conditions, must exercise care when using the seat heater. The seat heater may cause burns even at low temperatures, especially if used for long periods of time. Do not place anything on the seat that insulates against heat, such as a blanket or cushion, because this may cause the seat heater to overheat. Do not puncture the seat with pins, needles, or other pointed objects because this may damage the heating element which may cause the seat heater to overheat. An overheated seat may cause serious personal injury.

**Note:** Do not do the following:

- Place heavy objects on the seat.
- Operate the seat heater if water or any other liquid is spilled on the seat. Allow the seat to dry thoroughly.

The rear seat heat controls are located on the rear door armrest.

To operate the heated seats:

- Push the indicated side of the control for maximum heat.
- Push again to deactivate.



E162742

- Push the indicated side of the control for minimum heat.
- Push again to deactivate.



E162743

The heated seat module resets at every ignition run cycle. While the ignition is in the on position, activate the high or low heated seat switch to enable heating mode. When activated, they will turn off automatically when the engine is turned off.

The indicator light will illuminate when the heated seats have been activated.

# Seats

## CLIMATE CONTROLLED SEATS

### Heated Seats (If Equipped)

#### WARNING



People who are unable to feel pain to their skin because of advanced age, chronic illness, diabetes, spinal cord injury, medication, alcohol use, exhaustion or other physical conditions, must exercise care when using the heated seat. The heated seat may cause burns even at low temperatures, especially if used for long periods of time. Do not place anything on the seat that insulates against heat, such as a blanket or cushion. This may cause the heated seat to overheat. Do not puncture the seat with pins, needles or other pointed objects. This may damage the heating element which may cause the heated seat to overheat. An overheated seat may cause serious personal injury.

Do not do the following:

- Place heavy objects on the seat.
- Operate the heated seat if water or any other liquid is spilled on the seat. Allow the seat to dry thoroughly.
- Operate the heated seats unless the engine is running. Doing so can cause the battery to lose charge.



E146322

To operate the heated seats, touch the heated seat symbol on the touchscreen to cycle through the various heat settings and off. Warmer settings are indicated by more indicator lights.

### Cooled Seats (If Equipped)

The cooled seats will only function when the engine is running.



E146309

To operate the cooled seats, press the cooled seat symbol to cycle through the various cooling settings and off. Cooler settings are indicated by more indicator lights.

If the engine falls below 350 RPM while the cooled seats are on, the feature will turn itself off. You will need to reactivate it.

### Heated and Cooled Seats Air Filter Replacement (If Equipped)

The heated and cooled seat system includes air filters. You must replace them periodically.

The filter is located under each front seat. Access the filter from the second row foot-well area. Move the front seats all the way to the full front and full up positions to ease access.

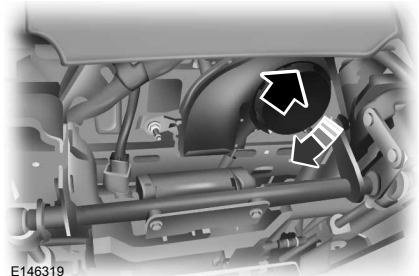

E146319

# Seats

To remove a filter:

1. Turn the vehicle off.
2. Push up on the outside rigid edge of the filter until the tabs are released, then remove the filter.

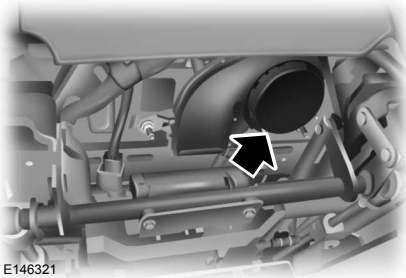

To install a filter:

1. First, position the filter in its housing making sure that the far forward end is all the way up in the housing.
2. Push in on the center of the outside edge of the filter and rotate clockwise into the housing until it clips into position.

## FRONT SEAT ARMREST



Press the button on the right-hand side of the seat and pull the seatback down to release the armrest. You can also gain access to the cupholders and seatback storage bin.



Pull up on the tab to open the storage bin

Lift up on the seatback to return it to the upright position.



If your vehicle has an under-seat storage compartment in the seat cushion, lift the latch to open the lid of the compartment. You cannot open the lid when the armrest is down.

# Seats

---



E162748

The under-seat storage compartment has a programmable lock. Use the ignition key to program the lock to the compartment. You can power or charge electronics using the under-seat storage compartment auxiliary power point. See **Auxiliary Power Points** (page 132).

## **REAR SEAT ARMREST** (If Equipped)



E162744

Fold the armrest down to use it.

# Universal Garage Door Opener (If Equipped)

The appearance of your vehicle's universal garage door opener varies according to your option package. Before programming, make sure you identify which transmitter you have by comparing it to the graphics below:



E164776

## Car2U Home Automation System



E142657

## HomeLink

**Note:** Programming these two types of universal garage door openers are different, and they have different instructions. Identify your package and refer to the instructions listed in this chapter.

## CAR2U® Home Automation System (If Equipped)

### WARNINGS



Make sure that the garage door and security device are free from obstruction when you are programming. Do not program the system with the vehicle in the garage.

### WARNINGS



Do not use the system with any garage door opener that does not have the safety stop and reverse feature as required by U.S. Federal Safety Standards (this includes any garage door opener manufactured before April 1, 1982).

**Note:** Before you begin the programming process, park your vehicle in front of the garage door opener motor or other device you want to program.

**Note:** Make sure you keep the original remote control transmitter for use in other vehicles as well as for future system programming.

**Note:** We recommend that, upon the sale or lease termination of your vehicle, you erase the programmed function buttons for security reasons. See **Erasing the Function Button Codes** later in this section.

**Note:** Programming the system to a community gate will require a unique set of instructions depending on the gate system model. Contact the help line at 1-866-572-2728 for further information.

**Note:** If you accidentally enter the program mode by pressing and releasing the outer two buttons or all three buttons simultaneously, do not press any button until the module times out after a few seconds and resets to normal mode. When the module has timed out, all three LED lamps will flash rapidly for a few seconds then turn off. Any settings should remain as previously set.

The universal garage door opener replaces the common hand-held garage door opener with a three-button transmitter, integrated into the driver's sun visor.

# Universal Garage Door Opener (If Equipped)

The system includes two primary features, a garage door opener and a platform for remote activation of devices within the home. This functionality allows you to program garage door openers as well as security devices and home lighting systems.

You can find additional system information online at [www.learcar2U.com](http://www.learcar2U.com) or by calling the toll-free help line on 1-866-572-2728.



E164776

## Rolling Code Programming

**Note:** If you do not follow the time-sensitive instructions, the device will time out and you will have to repeat the complete procedure.

**Note:** It may be helpful to have another person assist you in programming the transmitter.

1. Switch the ignition on.
2. Press and hold the outer two buttons for 1–2 seconds, then release.

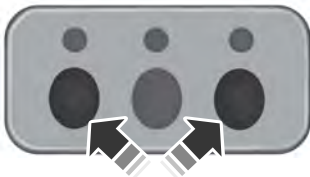

E164777

**Note:** You may need a ladder to reach the unit and you may need to remove the cover or lamp lens.

**Note:** If you cannot locate the learn button, see the Owner's Manual for your garage door opener or call the toll-free help line at 1-866-572-2728.

3. Press the learn button on the garage door opener motor.



E142659

**Note:** You will have 10–30 seconds to complete the following steps.

4. Return to your car.
5. Press and hold the function button you would like to use to control the garage door. You may need to hold the button from 5–20 seconds, during which time the selected button LED lamp will flash slowly.



E164776

6. When the garage door moves, release the button **within one second**. The LED lamp will flash rapidly until programming is complete.
7. Press and release the button again. The garage door should move, confirming that programming is successful. If your garage door does not operate, repeat the previous steps.

The LED lamp above the selected button will illuminate to confirm that the system is responding to the button command.



# Universal Garage Door Opener (If Equipped)

To program another rolling code device, repeat Steps 1 through 6, substituting a different function button in Step 5.

## Fixed Code Programming

**Note:** *It may be helpful to have another person assist you in programming the transmitter.*

To program units with fixed code DIP switches, you will need the garage door hand-held transmitter, paper and a pen or pencil.

1. Switch the ignition on.
2. Open the battery cover and note all the switch settings from left to right.



E164778

- When the switch is in the up, on, or + position, mark down “left button”.
  - When the switch is in the middle, neutral, or 0 position, mark down “middle button”.
  - When the switch is in the down, off, or – position, mark down “right button”.
3. Press all three function buttons simultaneously for a few seconds and then release. The LED lamps will flash slowly.



E164776

**Note:** *You must complete the following step within 2.5 minutes.*

4. Enter the corresponding DIP switch settings from left to right into the system by pressing and releasing the buttons corresponding to the settings you noted.
5. Simultaneously press and release all three function buttons. The LED lamps will illuminate.



E164776

6. Press and hold the function button you would like to use to control the garage door.

**Note:** *You may need to hold the button from 5–55 seconds before observing movement of the garage door.*

7. When the garage door moves, release the button within one second. After you release the button, the LED lamp will flash slowly.
8. The LED lamp will begin to flash rapidly until programming is complete. If your garage door does not operate, repeat the previous steps. Otherwise, call the toll-free help line at 1-866-572-2728.

The LED lamp above the selected button will illuminate to confirm that the system is responding to the button command.

## Erasing the Function Button Codes

**Note:** *You cannot erase individual buttons.*

1. Press and hold the outer two function buttons simultaneously for approximately 20 seconds until the LED lamps above the buttons flash rapidly

## Universal Garage Door Opener (If Equipped)

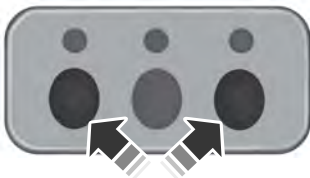

E164777

2. When the LED lamps flash, release the buttons. You have erased all of the button codes.

### FCC and RSS-210 Industry Canada Compliance

This device complies with Part 15 of the FCC Rules and with RSS-210 of Industry Canada. Operation is subject to the following two conditions:

1. This device may not cause harmful interference, and
2. This device must accept any interference received, including interference that may cause undesired operation.

Changes or modifications to your device not expressly approved by the party responsible for compliance can void the user's authority to operate the equipment.

### HomeLink Wireless Control System (If Equipped)

#### WARNING



Do not use the system with any garage door opener that does not have the safety stop and reverse feature as required by U.S. Federal Safety Standards (this includes any garage door opener manufactured before April 1, 1982). A garage door opener that cannot detect an object, signaling the door to stop and reverse, does not meet current federal safety standards. Using a garage door opener without these features increases the risk of serious injury or death.

**Note:** Make sure that the garage door and security device are free from obstruction when you are programming. Do not program the system with the vehicle in the garage.

**Note:** Make sure you keep the original remote control transmitter for use in other vehicles as well as for future system programming.

**Note:** We recommend that, upon the sale or lease termination of your vehicle, you erase the programmed function buttons for security reasons. See **Erasing the Button Codes** later in this section.

**Note:** You can program a maximum of three devices. To change or replace any of the three devices after you have programmed them, you must first erase the current settings. See **Erasing the Button Codes** later in this section.



E142657

The universal garage door opener replaces the common hand-held garage door opener with a three-button transmitter, integrated into the driver's sun visor.

The system includes two primary features, a garage door opener and a platform for remote activation of devices within the home. This functionality allows you to program garage door openers as well as entry gate operators, security systems, entry door locks and home or office lighting.

You can find additional system information online at [www.homelink.com](http://www.homelink.com) or by calling the toll-free help line on 1-800-355-3515.

# Universal Garage Door Opener (If Equipped)

## In-vehicle Programming

This process is to program your hand-held transmitter and your in-vehicle HomeLink button.

**Note:** Put a new battery in the hand-held transmitter. This will ensure quicker training and accurate transmission of the radio-frequency signal.

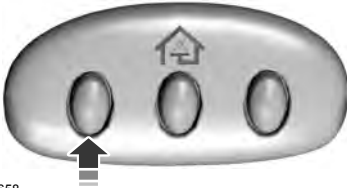

E142658

1. With your vehicle parked outside of the garage, turn your ignition to the **on** position, but do not start your vehicle.
2. Hold your hand-held garage door transmitter 1–3 inches (2–8 centimeters) away from the HomeLink button that you want to program.
3. Using both hands, simultaneously, press and hold the desired HomeLink button and the hand-held transmitter. DO NOT release either one until the HomeLink indicator light flashes slowly and then rapidly. When the indicator light flashes rapidly, you can release both buttons. The rapid flashing indicates successful training.
4. Press and hold the HomeLink button you programmed for five seconds, then release. You may need to do this twice to activate the door. If your garage door does not operate, watch the HomeLink indicator light.

If the indicator light stays on, the programming is complete. See **Programming Your Garage Door Motor** later in this section.

If the indicator light flashes rapidly for two seconds and then turns to a constant light, you have not programmed the HomeLink button yet. Do the following:

Press and hold the HomeLink button while you press and release the hand-held transmitter button every two seconds. The HomeLink indicator light will flash slowly and then rapidly once the HomeLink function button recognizes and accepts the hand-held transmitter's radio frequency signal.

After programming the HomeLink button, begin programming your garage door opener motor.

**Note:** You may need a ladder to reach the unit and you may need to remove the cover or lamp lens on your garage door opener.



E142659

To program additional buttons, repeat Steps 1 – 4.

For questions or comments, please contact HomeLink at [www.homelink.com](http://www.homelink.com) or 1-800-355-3515.

## Programming Your Garage Door Opener Motor

1. Press the learn button on the garage door opener motor and then you have 30 seconds to complete the next two steps.
2. Return to your vehicle.

## Universal Garage Door Opener (If Equipped)

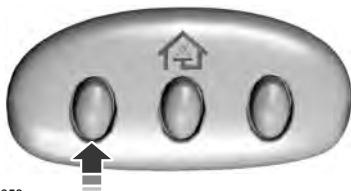

E142658

3. Press and hold the function button you want to program for two seconds, then release. Repeat this step. Depending on your brand of garage door opener, you may need to repeat this sequence a third time.

### Erasing the Function Button Codes

**Note:** You cannot erase individual buttons.

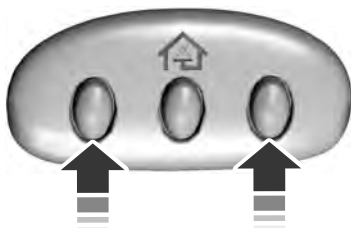

E142660

1. Press and hold the outer two function buttons simultaneously for approximately 20 seconds until the indicator lights above the buttons flash rapidly.
2. When the indicator lights flash, release the buttons. You have erased the codes for all buttons.

### Reprogramming a Single Button

To program a device to a previously trained button, follow these steps:

1. Press and hold the desired button. Do NOT release the button.

2. The indicator light will begin to flash after 20 seconds. Without releasing the button, follow Step 1 in the Programming section.

For questions or comments, contact HomeLink at [www.homelink.com](http://www.homelink.com) or 1-800-355-3515.

### Programming to a Genie Intellicode 2 Garage Door Opener

**Note:** You must program the Genie Intellicode 2 transmitter to operate it with the garage door opener.

**Note:** To program HomeLink to the transmitter, you must first put the transmitter into programming mode.



E142661

- A. Red indicator light
- B. Green indicator light

1. Press and hold one of the buttons on the hand-held transmitter for 10 seconds. The indicator light will change from green to red and green.
2. Press the same button twice to confirm the change to programming mode. If done properly the indicator light will appear red.
3. Hold the transmitter within 1–3 inches (2–8 centimeters) of the button on the visor you want to program.

## Universal Garage Door Opener (If Equipped)

4. Press and hold both the programmed Genie button on the hand-held transmitter and the button you want to program. The indicator light on the visor will flash rapidly when the programming is successful.

**Note:** *The Genie transmitter will transmit for up to 30 seconds. If HomeLink does not program within 30 seconds you will need to press the Genie transmitter again. If the Genie transmitter indicator light displays green and red, release the button until the indicator light turns off before pressing the button again.*

Once you have programmed HomeLink successfully, you must change the Genie transmitter out of program mode. To do this:

1. Press and hold the previously programmed Genie button on the hand-held transmitter for 10 seconds. The indicator light will change from red to red and green.
2. Press the same button twice to confirm the change. If done correctly the indicator light will turn green.

### Programming HomeLink to the Genie Intellicode Garage Door Opener Motor

**Note:** *You may need a ladder to access the garage door opener motor.*

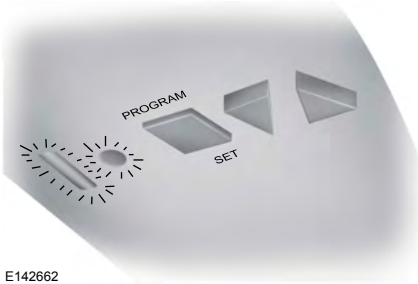

E142662

1. Press and hold the program button on the garage door opener motor until both blue indicator lights turn on.
2. Release the program button. Only the smaller round indicator light should be on.
3. Press and release the program button. The larger purple indicator light will flash.

**Note:** *The next two steps must be completed in 30 seconds.*

4. Press and release the previously programmed button on the Genie Intellicode 2 hand-held transmitter. Both indicator lights on the garage door opener motor unit should now flash purple.
5. Press and hold the previously programmed button on the visor for two seconds. Repeat this step up to three times until the garage door moves.

Programming is now complete.

### Clearing a HomeLink Device

To erase programming from the three HomeLink buttons press and hold the two outer HomeLink buttons until the indicator light begins to flash. The indicator light will begin flashing in 10-20 seconds. When this happens, release both buttons. You have now erased the programming, and the indicator light should blink slowly to indicate the device is in train mode when you press any of the three HomeLink buttons.

# Universal Garage Door Opener (If Equipped)

---

## **FCC and RSS-210 Industry Canada Compliance**

This device complies with Part 15 of the FCC Rules and with RSS-210 of Industry Canada. Operation is subject to the following two conditions: (1) this device may not cause harmful interference, and (2) this device must accept any interference received, including interference that may cause undesired operation.

Changes or modifications to your device not expressly approved by the party responsible for compliance can void the user's authority to operate the equipment.

# Auxiliary Power Points

## 12 Volt DC Power Point

### WARNING



Do not plug optional electrical accessories into the cigar lighter socket (if equipped). Improper use of the lighter can cause damage not covered by your warranty, and can result in fire or serious injury.

**Note:** *If used when the engine is not running, the battery will discharge. There may be insufficient power to restart your engine.*

**Note:** *Do not insert objects other than an accessory plug into the power point. This will damage the outlet and blow the fuse.*

**Note:** *Do not hang any type of accessory or accessory bracket from the plug.*

**Note:** *Do not use the power point over the vehicle capacity of 12 volt DC 180 watts or a fuse may blow.*

**Note:** *Do not use the power point for operating a cigar lighter element.*

**Note:** *Improper use of the power point can cause damage not covered by your warranty.*

**Note:** *Always keep the power point caps closed when not in use.*

Run the engine for full capacity use of the power point. To prevent the battery from being discharged:

- do not use the power point longer than necessary when the engine is not running
- do not leave devices plugged in overnight or when the vehicle is parked for extended periods.

## Locations

Power points may be found:

- On the instrument panel (two locations).
- Inside the center console.
- On the rear of the center console.
- Inside the front under-seat storage compartment (if equipped).
- Inside the rear under-seat storage compartment (if equipped).

## 110 Volt AC Power Points (If Equipped)

### WARNING



Do not keep electrical devices plugged in the power points when the devices are not in use. Do not use any extension cord with the 110 volt AC power points, since it will defeat the safety protection design. Do not use a single power point to power multiple devices. It may cause the power point to exceed the 150 watt load limit and overload, resulting in fire or serious injury.

**Note:** *Keep the engine running to use the power points.*



E143941

Some vehicles may come equipped with more than one power point. One may be located in the center of the rear floor console. The second one (if equipped) may be located on the instrument panel. You can use your power points for powering electrical devices that require up to 150 watts.

# Auxiliary Power Points

---

When the indicator light, located on the power point, is:

- on — the power point is ready to supply power.
- off — the power point power supply is off; ignition is not on.
- flashing — the power point is in fault mode.

The power point temporarily turns off power if the 150 watt limit is exceeded. It can also switch to a fault mode when it is overloaded, overheated, or shorted. Unplug your device and switch the ignition off, and then switch the ignition back on for overloading and shorting conditions. Let the system cool off, and then turn the ignition off, and then switch the ignition back on for an overheating condition.

The power points are not designed for electric devices such as:

- cathode ray tube type televisions
- motor loads, for example vacuum cleaners, electric saws and other electric power tools, or compressor-driven refrigerators
- measuring devices which process precise data, for example medical equipment or measuring equipment
- other appliances requiring an extremely stable power supply, for example microcomputer-controlled electric blankets or touch sensor lamps.



# Storage Compartments

## CENTER CONSOLE (If Equipped)

Stow items in the cupholder carefully as items may become loose during hard braking, acceleration or collisions, including hot drinks which may spill.



E163064

Available console features include:

- Locking storage compartment with hanging file folder supports
- Storage for laptop computer, binder or book between the hanging file folder support and the passenger side of the console bin
- Auxiliary power points

## Removable Front Cupholders

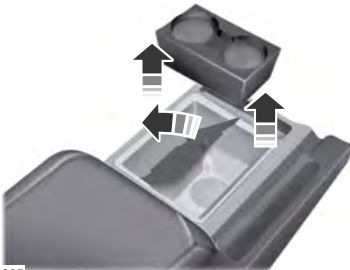

E163065

You can lift the two cupholder modules out. You can also remove the false bottom for hidden storage or to hold a large cup.

## OVERHEAD CONSOLE (If Equipped)

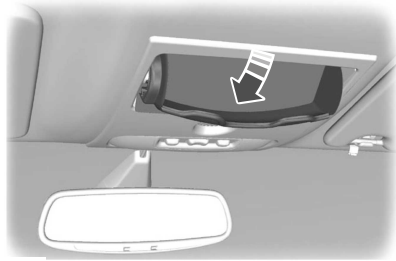

E75193

Press near the rear edge of the door to open it.

# Starting and Stopping the Engine

## GENERAL INFORMATION

### WARNINGS

 Extended idling at high engine speeds can produce very high temperatures in the engine and exhaust system, creating the risk of fire or other damage.

 Do not park, idle or drive your vehicle on dry grass or other dry ground cover. The emission system heats up the engine compartment and exhaust system, creating the risk of fire.

 Do not start the engine in a closed garage or in other enclosed areas. Exhaust fumes can be toxic. Always open the garage door before you start the engine.

 If you smell exhaust fumes inside your vehicle, have your vehicle checked by your authorized dealer immediately. Do not drive your vehicle if you smell exhaust fumes.

If you disconnect the battery, your vehicle may exhibit some unusual driving characteristics for approximately 5 miles (8 kilometers) after you reconnect it. This is because the engine management system must realign itself with the engine. You can disregard any unusual driving characteristics during this period.

The powertrain control system meets all Canadian interference-causing equipment standard requirements regulating the impulse electrical field or radio noise.

When you start the engine, avoid pressing the accelerator pedal before and during operation. Only use the accelerator pedal when you have difficulty starting the engine.

If your vehicle is operated in a heavy snow storm or blowing snow conditions, the engine air induction may become partially clogged with snow and ice. If this occurs, the engine may experience a significant reduction in power output. At the earliest opportunity, clear all the snow and ice away from the air induction inlet.

## IGNITION SWITCH

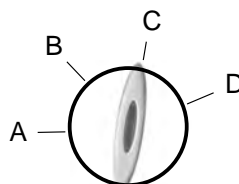

E163165

**A** (off) - The ignition is off.

**Note:** When you switch the ignition off and leave your vehicle, do not leave your key in the ignition. This could cause your vehicle battery to lose charge.

**B** (accessory) - Allows the electrical accessories, such as the radio, to operate while the engine is not running.

**Note:** Do not leave the ignition key in this position for too long. This could cause your vehicle battery to lose charge.

**C** (on) - All electrical circuits are operational and the warning lamps and indicators illuminate.

**D** (start) - Cranks the engine.

# Starting and Stopping the Engine

## STARTING A GASOLINE ENGINE

When you start the engine, the idle speed increases, this helps to warm up the engine. If the engine idle speed does not slow down automatically, have your vehicle checked by an authorized dealer.

Before starting the engine check the following:

- Make sure all occupants have fastened their safety belts.
- Make sure the headlamps and electrical accessories are off.
- Make sure the parking brake is on.
- Move the transmission selector lever to position **P**.
- Turn the ignition key to the on position.

**Note:** Do not touch the accelerator pedal.

1. Fully press the brake pedal.
2. Turn the key to the start position to start the engine. Release the key when the engine starts.

**Note:** The engine may continue cranking for up to 15 seconds or until it starts.

**Note:** If you cannot start the engine on the first try, wait for a short period and try again.

## Failure to Start

If you cannot start the engine after three attempts, wait 10 seconds and follow this procedure:

1. Fully press the brake pedal.
2. Fully press the accelerator pedal and hold it there.
3. Start the engine.

## Stopping the Engine When Your Vehicle is Stationary

1. Move the transmission selector lever to position **P**.

2. Turn the key to the off position.
3. Apply the parking brake.

## Stopping the Engine When Your Vehicle is Moving

### WARNING



Switching off the engine when the vehicle is still moving will result in a loss of brake and steering assistance.

The steering will not lock, but higher effort will be required. When the ignition is switched off, some electrical circuits, including air bags, warning lamps and indicators may also be off. If the ignition was turned off accidentally, you can shift into neutral (N) and re-start the engine.

1. Move the transmission selector lever to position **N** and use the brakes to bring your vehicle to a safe stop.
2. When your vehicle has stopped, move the transmission selector lever to position **P** and turn the key to the off position.
3. Apply the parking brake.

## Cold Weather Starting (Flexible Fuel Vehicles Only)

The starting characteristics of all grades of E85 ethanol make it unsuitable for use when ambient temperatures fall below 0°F (-18°C). Consult your fuel distributor for the availability of winter grade ethanol. As the outside temperature approaches freezing, ethanol fuel distributors should supply winter grade ethanol (same as with unleaded gasoline). If summer grade ethanol is used in cold weather conditions, 0°F to 32°F (-18°C to 0°C), you may experience increased cranking times, rough idle or hesitation until the engine has warmed up.

# Starting and Stopping the Engine

You may experience a decrease in peak performance when the engine is cold when operating on E85 ethanol.

Do not crank the engine for more than 10 seconds at a time as starter damage may occur. If the engine fails to start, turn the key to off and wait 30 seconds before trying again.

Do not use starting fluid such as ether in the air intake system. Such fluid could cause immediate explosive damage to the engine and possible personal injury.

If you should experience cold weather starting problems on E85 ethanol, and neither an alternative brand of E85 ethanol nor an engine block heater is available, the addition of unleaded gasoline to your tank improves cold starting performance. Your vehicle is designed to operate on E85 ethanol alone, unleaded gasoline alone, or any mixture of the two.

## If the Engine Fails to Start Using the Preceding Instructions (Flexible Fuel Vehicles Only)

1. Press and hold down the accelerator one-third to one-half the way to the floor, then crank the engine.
2. When the engine starts, release the key, then gradually release the accelerator pedal as the engine speeds up. If the engine still fails to start, repeat Step 1.

## Guarding Against Exhaust Fumes

### WARNING



If you smell exhaust fumes inside your vehicle, have your vehicle checked by your authorized dealer immediately. Do not drive your vehicle if you smell exhaust fumes. Carbon monoxide is present in exhaust fumes. Take precautions to avoid its dangerous effects.

## Important Ventilating Information

If you stop your vehicle and then leave the engine idling for long periods of time, we recommend that you do one of the following:

- Open the windows at least 1 inch (2.5 centimeters).
- Set your climate control to outside air.

## ENGINE BLOCK HEATER (if

Equipped)

### WARNINGS



Failure to follow engine block heater instructions could result in property damage or serious personal injury.



Do not use your heater with ungrounded electrical systems or two-pronged adapters. There is a risk of electrical shock.



Do not fully close the hood, or allow it to drop under its own weight when using the engine block heater. This could damage the power cable and may cause an electrical short resulting in fire, injury and property damage.

**Note:** *The heater is most effective when outdoor temperatures are below 0°F (-18°C).*

The heater acts as a starting aid by warming the engine coolant. This allows the climate control system to respond quickly. The equipment includes a heater element (installed in the engine block) and a wire harness. You can connect the system to a grounded 120-volt AC electrical source.

# Starting and Stopping the Engine

---

We recommend that you do the following for a safe and correct operation:

- Use a 16-gauge outdoor extension cord that is product certified by Underwriter's Laboratory (UL) or Canadian Standards Association (CSA). This extension cord must be suitable for use outdoors, in cold temperatures, and be clearly marked Suitable for Use with Outdoor Appliances. Do not use an indoor extension cord outdoors. This could result in an electric shock or become a fire hazard.
- Use as short an extension cord as possible.
- Do not use multiple extension cords.
- Make sure that when in operation, the extension cord plug and heater cord plug connections are free and clear of water. This could cause an electric shock or fire.
- Make sure your vehicle is parked in a clean area, clear of combustibles.
- Make sure the heater, heater cord and extension cord are firmly connected.
- Check for heat anywhere in the electrical hookup once the system has been operating for approximately 30 minutes.
- Make sure the system is unplugged and properly stowed before starting and driving your vehicle. Make sure the protective cover seals the prongs of the block heater cord plug when not in use.
- Make sure the heater system is checked for proper operation before winter.

The heater uses 0.4 to 1.0 kilowatt-hours of energy per hour of use. The system does not have a thermostat. It achieves maximum temperature after approximately three hours of operation. Using the heater longer than three hours does not improve system performance and unnecessarily uses electricity.

## Using the Engine Block Heater

Make sure the receptacle terminals are clean and dry prior to use. Clean them with a dry cloth if necessary.

# Fuel and Refueling

## SAFETY PRECAUTIONS

### WARNINGS



Do not overfill the fuel tank. The pressure in an overfilled tank may cause leakage and lead to fuel spray and fire.



The fuel system may be under pressure. If you hear a hissing sound near the fuel filler door, do not refuel until the sound stops. Otherwise, fuel may spray out, which could cause serious personal injury.



Automotive fuels can cause serious injury or death if you misuse or mishandle them.



Fuel ethanol and gasoline may contain benzene, which is a cancer-causing agent.



When refueling always shut the engine off and never allow sparks or open flames near the filler neck.

Never smoke or use a cell phone while refueling. Fuel vapor is extremely hazardous under certain conditions. Avoid inhaling excess fumes.



The flow of fuel through a fuel pump nozzle can produce static electricity, which can cause a fire if you pump fuel into an ungrounded fuel container.

Observe the following guidelines when handling automotive fuel:

- Extinguish all smoking materials and any open flames before refueling your vehicle.
- Automotive fuels can be harmful or fatal if swallowed. Fuel such as gasoline is highly toxic and if swallowed can cause death or permanent injury. If swallowed, call a physician immediately, even if no symptoms are immediately apparent. The toxic effects of fuel may not be visible for hours.
- Avoid inhaling fuel vapors. Inhaling too much fuel vapor of any kind can lead to eye and respiratory tract irritation. In severe cases, excessive or prolonged breathing of fuel vapor can cause serious illness and permanent injury.
- Avoid getting fuel liquid in your eyes. If you splash fuel in your eyes, remove contact lenses (if worn), flush with water for 15 minutes and seek medical attention. Failure to seek proper medical attention could lead to permanent injury.
- Fuels can also be harmful if absorbed through the skin. If you splash fuel on your skin, clothing or both, promptly remove contaminated clothing and wash your skin thoroughly with soap and water. Repeated or prolonged skin contact with fuel liquid or vapor causes skin irritation.
- Be particularly careful if you are taking "Antabuse" or other forms of disulfiram for the treatment of alcoholism. Breathing gasoline vapors, or skin contact could cause an adverse reaction. In sensitive individuals, serious personal injury or sickness may result. If you splash fuel on your skin, promptly wash your skin thoroughly with soap and water. Consult a physician immediately if you experience an adverse reaction.

# Fuel and Refueling

## FUEL QUALITY

**Note:** Do not add after-market fuel additive products to your fuel tank. We recommend that you use only high quality fuel without after-market additives or other engine treatments.

**Note:** Your warranty will not cover any vehicle damage, loss of vehicle performance or repairs to your vehicle caused by the use of fuel not recommended.

### Choosing the Right Fuel

Use only unleaded gasoline or unleaded gasoline blended with a maximum of 15% ethanol in your gasoline vehicle. If your vehicle is a flex fuel vehicle (FFV), it will have a yellow cap.

Do not use:

- Fuels containing more than 15% ethanol or E-85 fuel.
- Fuels containing methanol.
- Fuels containing metallic based additives, including manganese-based compounds.
- Fuels containing the octane booster additive, methylcyclopentadienyl manganese tricarbonyl (MMT).
- Prohibited by law, you cannot use leaded fuel.

### Diesel Engine

Refer to the diesel supplement for information regarding diesel fuel recommendations and requirements of your diesel-powered truck.

### Choosing the Right Fuel With a Flex Fuel Vehicle (If Equipped)

**Note:** Flex fuel vehicles will have a yellow fuel cap.

Use only unleaded gasoline or unleaded gasoline blended with a maximum of 85% ethanol (E-85) in your flex fuel vehicle (FFV).

Do not use:

- Fuels containing more than 85% ethanol or E-100 fuel.
- Fuels containing methanol.
- Fuels containing metallic based additives, including manganese-based compounds.
- Fuels containing the octane booster additive, methylcyclopentadienyl manganese tricarbonyl (MMT).
- Prohibited by law, you cannot use leaded fuel.

Your warranty will not cover any vehicle damage, loss of vehicle performance or repairs to your vehicle, caused by the use of fuel not recommended.

It is best not to alternate repeatedly between gasoline and E85. If you do switch fuels, it is recommended that you add as much fuel as possible—at least half a tank. Do not add less than 5.0 gal (18.9 L) when refueling. You should drive the vehicle immediately after refueling for at least 5.0 (8 km) to allow the vehicle to adapt to the change in ethanol concentration. The recommendation if you exclusively use E85 fuel, is to fill the fuel tank with regular unleaded gasoline at each scheduled oil change.

### Octane Recommendations

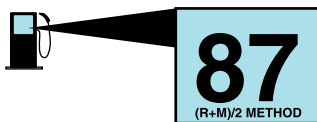

E161513

# Fuel and Refueling

We recommend regular unleaded gasoline with a pump (R+M)/2 octane rating of 87. Some stations offer fuels posted as regular with an octane rating below 87, particularly in high altitude areas. We do not recommend fuels with an octane rating below 87.

Do not be concerned if your engine sometimes knocks lightly. However, if it knocks heavily under most driving conditions while you are using fuel with the recommended octane rating, see your authorized dealer to prevent any engine damage.

## RUNNING OUT OF FUEL

Avoid running out of fuel because this situation may have an adverse effect on powertrain components.

If you run out of fuel:

- You may need to switch the ignition from off to on several times after refueling to allow the fuel system to pump the fuel from the tank to the engine. When restarting, cranking time takes a few seconds longer than normal. With keyless ignition, just start the engine. Crank time will be longer than usual.
- Normally, adding 1 gallon (3.8 liters) of fuel is enough to restart the engine. If the vehicle is out of fuel and on a steep grade, more than 1 gallon (3.8 liters) may be required.
- The service engine soon indicator may come on. For more information on the service engine soon indicator, See **Warning Lamps and Indicators** (page 79).

## Refilling With a Portable Fuel Container

### WARNINGS



The fuel system may be under pressure. If you hear a hissing sound near the fuel filler door, do not refuel until the sound stops. Otherwise, fuel may spray out, which could cause serious personal injury.



Do not try to pry open or push open the fuel system with foreign objects. This could damage the fuel system and its seal and cause personal injury to you or others.

Use the following directions when filling from a portable fuel container:

1. Remove the fuel cap from the fuel filler pipe by rotating it counter clockwise.
2. Slowly insert the portable fuel container into the fuel filler opening.
3. Fill the vehicle with fuel from the portable fuel container.
4. When done, remove the portable fuel container nozzle and reinstall the fuel cap. Insert fuel cap into fuel filler opening and turn clockwise until you hear a click.

## REFUELING

### WARNINGS



Fuel vapor burns violently and a fuel fire can cause severe injuries.



Read and follow all the instructions on the pump island.



Turn off your engine when you are refueling.









Do not smoke if you are near fuel or refueling your vehicle.



# Fuel and Refueling

## WARNINGS



-  Keep sparks, flames and smoking materials away from fuel.
-  Stay outside your vehicle and do not leave the fuel pump unattended when refueling your vehicle. This is against the law in some places.
-  Keep children away from the fuel pump; never let children pump fuel.
-  Do not use personal electronic devices while refueling.
-  Wait at least 10 seconds before removing the fuel pump nozzle to allow any residual fuel to drain into the fuel tank.
-  Stop refueling after the fuel pump nozzle automatically shuts off for the second time. Failure to follow this will fill the expansion space in the fuel tank and could lead to fuel overflowing.
-  Do not remove the fuel pump nozzle from its fully inserted position when refueling.

Use the following guidelines to avoid electrostatic charge build-up when filling an ungrounded fuel container:

- Place approved fuel container on the ground.
- Do not fill a fuel container while it is in the vehicle (including the cargo area).
- Keep the fuel pump nozzle in contact with the fuel container while filling.
- Do not use a device that would hold the fuel pump handle in the fill position.

## Fuel Filler Cap

### WARNINGS

-  The fuel system may be under pressure. If you hear a hissing sound near the fuel filler door, do not refuel until the sound stops. Otherwise, fuel may spray out, which could cause serious personal injury.
-  If you do not use the proper fuel filler cap, excessive pressure or vacuum in the fuel tank may damage the fuel system or cause the fuel cap to disengage in a collision, which may result in possible personal injury.

**Note:** *If you must replace the fuel filler cap, replace it with a fuel filler cap that is designed for your vehicle. The customer warranty may be void for any damage to the fuel tank or fuel system if the correct genuine Ford, Motorcraft or other certified fuel filler cap is not used.*

Your fuel tank filler cap has an indexed design with a 1/4th turn on and off feature. When fueling your vehicle:

1. Put your vehicle in park (P).
2. Switch the engine off.
3. Carefully turn the filler cap counterclockwise until it spins off.
4. Pull to remove the cap from the fuel filler pipe.
5. To install the cap, align the tabs on the cap with the notches on the filler pipe.
6. Turn the filler cap clockwise 1/4 of a turn clockwise until it clicks at least once.

If the Check Fuel Cap light or a Check Fuel Cap message appears in the instrument cluster and stays on after you start the engine, you may not have installed the fuel filler properly.

# Fuel and Refueling

---

If the fuel cap light remains on, at the next opportunity, safely pull off of the road, remove the fuel filler cap, align the cap properly and reinstall it. The check fuel cap light or Check fuel cap message may not reset immediately. It may take several driving cycles for the indicators to turn off. A driving cycle consists of an engine start-up (after four or more hours with the engine off) followed by normal city and highway driving.

## FUEL CONSUMPTION

Empty reserve is the amount of fuel remaining in the tank after the fuel gauge indicates empty. The amount of usable fuel in the empty reserve varies and should not be relied upon to increase driving range.

- The usable capacity of the fuel tank is the amount of fuel that can be added into the tank after the gauge indicates empty
- The advertised capacity is the total fuel tank size. See **Capacities and Specifications** (page 301). It is the combined usable capacity plus the empty reserve.
- Due to the empty reserve, you may not be able to refuel the full amount of the advertised capacity of the fuel tank even when the fuel gauge reads empty.

## Filling the Tank

For consistent results when filling the fuel tank:

- Turn the ignition off before fueling; an inaccurate reading results if the engine is left running.
- Use the same fill rate (low-medium-high) each time the tank is filled.
- Allow no more than two automatic click-offs when filling.

Results are most accurate when the filling method is consistent.

## Calculating Fuel Economy

Do not measure fuel economy during the first 1000 miles (1600 kilometers) of driving (this is your engine's break-in period); a more accurate measurement is obtained after 2000 miles - 3000 miles (3200 kilometers - 4800 kilometers). Also, fuel expense, frequency of fill ups or fuel gauge readings are not accurate ways to measure fuel economy.

1. Fill the fuel tank completely and record the initial odometer reading.
2. Each time you fill the tank, record the amount of fuel added.
3. After at least 3 to 5 tank fill ups, fill the fuel tank and record the current odometer reading.
4. Subtract your initial odometer reading from the current odometer reading.
5. Calculate fuel economy by dividing miles traveled by gallons used (For Metric: Multiply liters used by 100, then divide by kilometers traveled).

Keep a record for at least 1 month and record the type of driving (city or highway). This provides an accurate estimate of the vehicle's fuel economy under current driving conditions. Additionally, keeping records during summer and winter show how temperature impacts fuel economy. In general, lower temperatures mean lower fuel economy.

# Fuel and Refueling

## Conditions

- Heavily loading a vehicle or towing a trailer may reduce fuel economy at any speed.
- Carrying unnecessary weight may reduce fuel economy (approximately 1 mpg [0.4 km/L] is lost for every 400 pounds [180 kilograms] of weight carried).
- Adding certain accessories to your vehicle (for example bug deflectors, rollbars/light bars, running boards, ski racks) may reduce fuel economy.
- Using fuel blended with alcohol may lower fuel economy.
- Fuel economy may decrease with lower temperatures during the first 8–10 miles (12–16 kilometers) of driving.
- Driving on flat terrain offers improved fuel economy as compared to driving on hilly terrain.
- Transmissions give their best fuel economy when operated in the top cruise gear and with steady pressure on the gas pedal.
- Close windows for high speed driving.

Your vehicle is equipped with various emission control components and a catalytic converter that will enable your vehicle to comply with applicable exhaust emission standards. To make sure that the catalytic converter and other emission control components continue to work properly:

- Use only the specified fuel listed.
- Avoid running out of fuel.
- Do not turn off the ignition while your vehicle is moving, especially at high speeds.
- Have the items listed in scheduled maintenance information performed according to the specified schedule.

The scheduled maintenance items listed in scheduled maintenance information are essential to the life and performance of your vehicle and to its emissions system.

If you use parts other than Ford, Motorcraft or Ford-authorized parts for maintenance replacements, or for service of components affecting emission control, such non-Ford parts should be the equivalent to genuine Ford Motor Company parts in performance and durability.

Illumination of the service engine soon indicator, charging system warning light or the temperature warning light, fluid leaks, strange odors, smoke or loss of engine power could indicate that the emission control system is not working properly.

An improperly operating or damaged exhaust system may allow exhaust to enter the vehicle. Have a damaged or improperly operating exhaust system inspected and repaired immediately.

Do not make any unauthorized changes to your vehicle or engine. By law, vehicle owners and anyone who manufactures, repairs, services, sells, leases, trades vehicles, or supervises a fleet of vehicles are not permitted to intentionally remove

## EMISSION CONTROL SYSTEM

### WARNINGS



Do not park, idle, or drive your vehicle in dry grass or other dry ground cover. The emission system heats up the engine compartment and exhaust system, which can start a fire.



Exhaust leaks may result in entry of harmful and potentially lethal fumes into the passenger compartment. If you smell exhaust fumes inside your vehicle, have your dealer inspect your vehicle immediately. Do not drive if you smell exhaust fumes.

# Fuel and Refueling

an emission control device or prevent it from working. Information about your vehicle's emission system is on the Vehicle Emission Control Information Decal located on or near the engine. This decal also lists engine displacement

Please consult your warranty information for complete details.

## On-Board Diagnostics (OBD-II)

Your vehicle is equipped with an on-board diagnostics system (OBD-II) that monitors the engine's emission control system. This system protects the environment by ensuring that your vehicle continues to meet government emission standards. The OBD-II system also assists your authorized dealer in properly servicing your vehicle.



When the service engine soon indicator illuminates, the OBD-II system has detected a malfunction. Temporary malfunctions may cause the service engine soon indicator to illuminate.

Examples of temporary malfunctions are:

- the vehicle has run out of fuel—the engine may misfire or run poorly
- poor fuel quality or water in the fuel—the engine may misfire or run poorly
- the fuel fill inlet may not have been properly closed See **Refueling** (page 141).
- driving through deep water—the electrical system may be wet.

You can correct these temporary malfunctions by filling the fuel tank with good quality fuel, properly closing the fuel fill inlet or letting the electrical system dry out. After three driving cycles without these or any other temporary malfunctions

present, the service engine soon indicator should stay off the next time you start the engine. A driving cycle consists of a cold engine startup followed by mixed city/highway driving. No additional vehicle service is required.

If the service engine soon indicator remains on, have your vehicle serviced at the first available opportunity. Although some malfunctions detected by the OBD-II may not have symptoms that are apparent, continued driving with the service engine soon indicator on can result in increased emissions, lower fuel economy, reduced engine and transmission smoothness, and lead to more costly repairs.

## Readiness for Inspection/Maintenance (I/M) Testing

Some state/provincial and local governments may have Inspection/Maintenance (I/M) programs to inspect the emission control equipment on your vehicle. Failure to pass this inspection could prevent you from getting a vehicle registration.



If the service engine soon indicator is on or the bulb does not work, you may need to have the vehicle serviced. See **On-Board Diagnostics (OBD-II)**.

Your vehicle may not pass the I/M test if the service engine soon indicator is on or not working properly (bulb is burned out), or if the OBD-II system has determined that some of the emission control systems have not been properly checked. In this case, your vehicle is not ready for I/M testing.

# Fuel and Refueling

---

If the vehicle's engine or transmission has just been serviced, or the battery has recently run down or been replaced, the OBD-II system may indicate that the vehicle is not ready for I/M testing. To determine if the vehicle is ready for I/M testing, turn the ignition key to the on position for 15 seconds without cranking the engine. If the service engine soon indicator blinks eight times, it means that the vehicle is not ready for I/M testing; if the service engine soon indicator stays on solid, it means that the vehicle is ready for I/M testing.

The OBD-II system monitors the emission control system during normal driving. A complete check may take several days. If the vehicle is not ready for I/M testing, you may need to perform the following driving cycle consisting of mixed city and highway driving:

Drive on an expressway or highway for a steady 15 minutes, followed by 20 minutes of stop-and-go driving with at least four 30-second idle periods.

Allow the vehicle to sit for at least eight hours without starting the engine. Then, start the engine and complete the above driving cycle. The engine must warm up to its normal operating temperature. Once started, do not turn off the engine until the above driving cycle is complete. If the vehicle is still not ready for I/M testing, you will have to repeat the above driving cycle.

# Transmission

## AUTOMATIC TRANSMISSION

### WARNING



Always set the parking brake fully and make sure the gearshift is latched in park (P). Turn the ignition to the off position and remove the key whenever you leave your vehicle.

### Understanding the Shift Positions of the 5-Speed Automatic Transmission (if Equipped)

P R N D 3 2 1

E161511

#### Putting your vehicle in or out of gear:

1. Fully press down the brake pedal.
2. Move the gearshift lever into the desired gear.
3. Come to a complete stop.
4. Move the gearshift lever and securely latch it in park (P).

#### Park (P)

This position locks the transmission and prevents the rear wheels from turning.

#### Reverse (R)

With the gearshift lever in reverse (R), your vehicle moves backward. Always come to a complete stop before shifting into and out of reverse (R).

#### Neutral (N)

With the gearshift lever in neutral (N), you can start your vehicle and it is free to roll. Hold the brake pedal down while in this position.

#### Drive (D)

Drive (D) is the normal driving position for the best fuel economy. The overdrive function allows automatic upshifts and downshifts through gears one through five.

#### Third (3)

Transmission operates in third (3) gear only. Use third (3) gear for improved traction on slippery roads.

#### Second (2)

Transmission operates in second (2) gear only. Use second (2) gear to start-up on slippery roads.

#### First (1)

- Transmission operates in first (1) gear only.
- Provides maximum engine braking.
- Allows upshifts by moving gearshift lever.
- Does not downshift into first (1) gear at high speeds; allows for first (1) gear when vehicle reaches slower speeds.

#### Forced downshifts

- Allowed in drive (D) with the tow/haul feature on or off.
- Press the accelerator to the floor.
- Allows transmission to select an appropriate gear.

# Transmission

## Tow/Haul Mode

**TOW HAUL** To activate tow/haul, press the button on the gearshift lever once. The TOW HAUL indicator light illuminates in the instrument cluster.

The tow/haul feature:

- Delays upshifts to reduce the frequency of transmission shifting.
- Provides engine braking in all forward gears, which slows your vehicle and assists you in controlling your vehicle when descending a grade.
- Depending on driving conditions and load conditions, may downshift the transmission, slow your vehicle and control your vehicle speed when descending a hill, without pressing the accelerator pedal. The amount of downshift braking provided varies based upon the amount you press the brake pedal.

The tow/haul feature improves transmission operation when towing a trailer or a heavy load. All transmission gear ranges are available when using tow/haul.

To deactivate the tow/haul feature and return to normal driving mode, press the button on the gearshift lever twice. The TOW HAUL light deactivates. Tow/haul also deactivates when you power down your vehicle.

### WARNING



Do not use the tow/haul feature when driving in icy or slippery conditions as the increased engine braking can cause the rear wheels to slide and your vehicle to swing around with the possible loss of vehicle control.

## Understanding the Shift Positions of a 6-Speed Automatic Transmission (If Equipped)



E163183

### Putting your vehicle in or out of gear:

1. Fully press down the brake pedal.
2. Move the gearshift lever into the desired gear.
3. Come to a complete stop.
4. Move the gearshift lever and securely latch it in park (P).

### Park (P)

This position locks the transmission and prevents the rear wheels from turning.

### Reverse (R)

With the gearshift lever in reverse (R), your vehicle moves backward. Always come to a complete stop before shifting into and out of reverse (R).

### Neutral (N)

With the gearshift lever in neutral (N), you can start your vehicle and it is free to roll. Hold the brake pedal down while in this position.

### Drive (D)

Drive (D) is the normal driving position for the best fuel economy. The overdrive function allows automatic upshifts and downshifts through gears one through six.

# Transmission

## M (Manual)

With the gearshift lever in manual (M), the driver can change gears up or down as desired. By moving the gearshift lever from drive position (D) to manual (M) you now have control of selecting the gear you desire using buttons on the shift lever. See Understanding your SelectShift Automatic™ transmission later in this section.

To return to normal drive (D) position, move the shift lever back from manual (M) to drive (D).

The transmission operates in gears one through six.

## Second (2)

Transmission operates in second (2) gear only. Use second (2) gear to start-up on slippery roads.

## First (1)

- Transmission operates in first (1) gear only.
- Provides maximum engine braking.
- Allows upshifts by moving gearshift lever.
- Does not downshift into first (1) gear at high speeds; allows for first (1) gear when vehicle reaches slower speeds.

## Forced downshifts

- Allowed in drive (D) with the tow/haul feature on or off.
- Press the accelerator to the floor.
- Allows transmission to select an appropriate gear.

## Tow/Haul Mode

**TOW HAUL** To activate tow/haul, press the button on the gearshift lever once. The TOW HAUL indicator light illuminates in the instrument cluster.

The tow/haul feature:

- Delays upshifts to reduce the frequency of transmission shifting.
- Provides engine braking in all forward gears, which slows your vehicle and assists you in controlling your vehicle when descending a grade.
- Depending on driving conditions and load conditions, may downshift the transmission, slow your vehicle and control your vehicle speed when descending a hill, without pressing the accelerator pedal. The amount of downshift braking provided will vary based upon the amount you press the brake pedal.

The tow/haul feature improves transmission operation when towing a trailer or a heavy load. All transmission gear ranges are available when using tow/haul.

To deactivate the tow/haul feature and return to normal driving mode, press the button on the gearshift lever twice. The TOW HAUL light deactivates. Tow/haul also deactivates when you power down your vehicle.

## WARNING



Do not use the tow/haul feature when driving in icy or slippery conditions as the increased engine braking can cause the rear wheels to slide and your vehicle to swing around with the possible loss of vehicle control.

## Understanding your SelectShift Automatic™ transmission (If Equipped)

Your vehicle is equipped with a SelectShift Automatic transmission gearshift lever. SelectShift Automatic transmission gives you the ability to change gears up or down (without a clutch) as desired.



# Transmission



E163184

Use the buttons on the shifter to lock or unlock gears and manually select gears. Press the + button to upshift or the – button to downshift.



E163183

With the gearshift lever in drive (D), press the – button to activate SelectShift. The instrument cluster indicates the available and selected gears.

All available gears display with the current gear indicated. Press the – button again to lock out gears beginning with the highest gear. Example: press the – button twice to lock out 6th and 5th gears. Only the available gears display and the transmission automatically shifts between the available gears. Press the + button to unlock gears.

By moving the gearshift lever from the drive (D) position to the manual (M) position you may now manually select the gear you desire. Only the current gear displays. Press the + button or the – button to upshift or downshift. If you press the – button at a vehicle speed that would cause an engine overspeed, the requested gear flashes then disappears and the transmission remains in the current gear.

## Recommended shift speeds

Upshift according to the following chart:

<b>Upshifts when accelerating (recommended for best fuel economy)</b>		
Shift from:	Gasoline engines	Diesel engines
1 – 2	15 mph (24 km/h)	12 mph (19 km/h)
2 – 3	25 mph (40 km/h)	19 mph (31 km/h)
3 – 4	40 mph (64 km/h)	26 mph (42 km/h)
4 – 5	45 mph (72 km/h)	34 mph (55 km/h)
5 – 6	50 mph (80 km/h)	46 mph (74 km/h)

# Transmission

In order to prevent the engine from running at too low an RPM, which may cause it to stall, SelectShift still automatically makes some downshifts if it has determined that you have not downshifted in time. Although SelectShift makes some downshifts for you, it still allows you to downshift at any time as long as the SelectShift determines that there is no damage to the engine from over-revving.

SelectShift does not automatically upshift, even if the engine is approaching the RPM limit. You must shift manually by pressing the + button.

**Note:** *Engine damage may occur if you rev the engine excessively and hold it without shifting.*

## Automatic Transmission Adaptive Learning

This feature's design is to increase durability and provide consistent shift feel over the life of your vehicle. A new vehicle or transmission may have firm shifts, soft shifts or both. This operation is normal and does not affect function or durability of the transmission. Over time, the adaptive learning process fully updates transmission operation. Additionally, whenever you disconnect the battery or install a new battery, the system must relearn the strategy.

## Brake-Shift Interlock

### WARNINGS



Do not drive your vehicle until you verify that the brake lamps are working.



When doing this procedure, you will be taking your vehicle out of park which means your vehicle can roll freely. To avoid unwanted vehicle movement, always fully set the parking brake prior to doing this procedure. Use wheel chocks if appropriate.

### WARNINGS



If the parking brake is fully released, but the brake warning lamp remains illuminated, the brakes may not be working properly. See your authorized dealer.

Your vehicle is equipped with a brake-shift interlock feature that prevents the gearshift lever from moving from park (P) when the ignition is in the 3 (on) position and the brake pedal is not pressed.

If you cannot move the gearshift lever out of park (P) position with the ignition in the 4 (on) position and the brake pedal pressed, a malfunction may have occurred. It is possible that a fuse has blown or your vehicle's brake lamps are not operating properly. See **Fuse Specification Chart** (page 223).

If the fuse is not blown and the brake lamps are working properly, the following procedure allows you to move the gearshift lever from park (P):

1. Apply the parking brake. Switch the ignition key to 1 (off), then remove the key.
2. Move the steering column to the full down and full rearward position (toward the driver's seat).
3. Remove the gearshift lever boot.
4. Place fingers into hole where you removed the gearshift lever boot and pull top half of shroud up and forward to separate it from the lower half of the shroud. There is a hinge at the forward edge of the top shroud. Roll the top half of the shroud upward on the hinge point to clear the hazard flasher button, then pull straight rearward toward the driver's seat to remove.
5. Remove the top half of the shroud.

# Transmission

- Remove the three fasteners under the column that secure the lower shroud half to the column.



E163185

- Pull the lock lever into the full unlocked position and remove the lower shroud cover by pulling the lever handle through the slot in the cover.
- Apply the brake. Gently lift the override disk and move the gearshift lever into neutral (N).



E163186

- Start your vehicle.

Perform Steps 4 through 8 in reverse order, making sure to engage the hinge pivots between the upper and lower halves of the shroud. Keep slight pressure in the forward direction as you rotate the halves together.

## If Your Vehicle Gets Stuck In Mud or Snow

**Note:** Do not rock your vehicle if the engine is not at normal operating temperature or damage to the transmission may occur.

**Note:** Do not rock your vehicle for more than a minute or damage to the transmission and tires may occur, or the engine may overheat.

If your vehicle is stuck in mud or snow, you may rock it out by shifting between forward and reverse gears, stopping between shifts in a steady pattern. Press lightly on the accelerator in each gear.

## POWER TAKE-OFF

Auxiliary equipment called power take-off, or PTO, is often added to the engine or transmission to operate utility equipment. Examples include a wheel-lift for tow trucks, cranes, tools for construction or tire service, and pumping fluids. PTO applications draw auxiliary horsepower from the powertrain, often while the vehicle is stationary. In this condition, there is limited cooling air flow through the radiator and around the vehicle that normally occurs when a vehicle is moving. The aftermarket PTO system installer, having the most knowledge of the final application, is responsible for determining whether additional chassis heat protection or powertrain cooling is required, and alerting the user to the safe and proper operation.

Ford Super Duty Vehicles are approved for use as a stationary (including split shaft capability) or mobile power source, within limits and operating guidelines detailed in the Ford Truck Body Builders Layout Book, found at [www.fleet.ford.com/truckbbas](http://www.fleet.ford.com/truckbbas), and through the Ford Truck Body Builders Advisory Service.

# Four-Wheel Drive (If Equipped)

## USING FOUR-WHEEL DRIVE

### WARNING



For important information regarding safe operation of this type of vehicle, See **General Information** (page 263).

**Note:** Do not use 4X4 mode on dry, hard surfaced roads. Doing so will produce excessive noise, increase tire wear and may damage drive components. 4X4 mode is only intended for consistently slippery or loose surfaces.

**Note:** If 4X4 low is selected while the vehicle is moving above 3 mph (5 km/h), the 4WD system will not perform a shift. This is normal and should be no reason for concern. Refer to *Shifting to/from 4L (4X4 Low)* for proper operation.

### Manual Shift On Stop (MSOS) 4WD system (If Equipped)

**Note:** Some vehicles may be equipped with wheel ornaments that cover the 4x4 manual hub lock. These ornaments must be removed to access the manual hub locks.

**Note:** The vehicle should not be driven in 4X4 High or 4X4 Low modes with the hub locks set to FREE as this condition may damage driveline system components.



E163187

The 4WD system is engaged or disengaged by rotating the control for both front wheel hub locks from the FREE or LOCK position, then manually engaging or disengaging the transfer case with the floor-mounted shifter. For increased fuel economy in 2WD, rotate both hub locks to the FREE position.

### Electronic Shift-On-the-Fly (ESOF) 4WD system

**Note:** If 4X4 Low is selected while the vehicle is moving above 3 mph (5 km/h), the 4WD system will not perform a shift. This is normal and should be no reason for concern. Refer to *Shifting to/from 4L (4X4 Low)* for proper system operation.

**Note:** Auto-manual hub locks can be manually overridden by rotating the hub lock control from AUTO to LOCK.



E163188

For proper operation, make sure that each hub is fully engaged and that both hub locks are set to the same position (both set to LOCK or both set to AUTO). To engage LOCK, turn the hub locks completely clockwise; to engage AUTO, turn the hub locks completely counterclockwise.

The ESOF 4WD system:

## Four-Wheel Drive (If Equipped)

- provides 4x4 High engagement and disengagement while the vehicle is moving.
- is operated by a rotary control located on the instrument panel that allows you select 4x2, 4x4 High or 4x4 Low operation.
- uses auto-manual hub locks that can be engaged and disengaged automatically based on the 4x4 mode selected.
- will increase fuel economy when used in the recommended AUTO lock mode.

### 4WD Indicator Lights

**Note:** When a 4X4 system fault is present, the system will typically remain in whichever 4X4 mode was selected prior to the fault condition occurring. It will not default to 4X2 in all circumstances. When this warning is displayed, have your vehicle serviced by an authorized dealer.

#### 4X2

4x2

Momentarily illuminates when 2H is selected.

#### 4X4 HIGH

4x4  
HIGH

Continuously illuminates when 4H is selected.

#### 4X4 LOW

4x4  
LOW

Continuously illuminates when 4L is selected.

#### CHECK 4X4



Displays when a 4X4 fault is present.

### Using a Manual Shift On Stop (MSOS) 4wd system (If Equipped)

**Note:** High shift efforts may be encountered when attempting to shift into and out of 4x4 modes. It is recommended to allow the vehicle to roll at a speed below 3 mph (5 km/h) when shifting between modes.

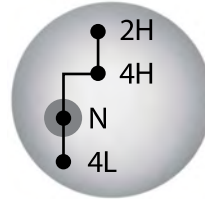

E163189

#### 2H (2WD)

For general on-road driving. Sends power to the rear wheels only and should be used for street and highway driving. Provides optimal smoothness and fuel economy at high speeds

#### 4H (4x4 High)

Used for extra traction such as in snow or icy roads or in off road situations. This mode is not intended for use on dry pavement.

#### N (Neutral)

Only used when towing the vehicle. No power to front or rear wheels.

#### 4L (4x4 Low)

Uses extra gearing to provide maximum power to all four wheels at reduced speeds. Intended only for off road applications such as deep sand, steep grades or pulling heavy objects.

# Four-Wheel Drive (If Equipped)

## Shifting between system modes

**Note:** Do not perform these operations if the rear wheels are slipping.

**Note:** Some noise may be heard as the 4x4 system shifts or engages. This is normal. In order to reduce engagement noise, it is recommended that all shifts be performed at speeds below 3 mph (5 km/h).

**Note:** The vehicle should not be driven in 4X4 High with the hub locks disengaged as this condition may damage driveline system components.

Engage the locking hubs by rotating the hub lock control from FREE to LOCK, then move the transfer case lever from 2H (2WD) to 4H (4x4 High) at a stop or a vehicle speed below 3 mph (5 km/h).

Move the transfer case lever from 4H (4x4 High) to 2H (2WD) at a stop or a vehicle speed below 3 mph (5 km/h), then disengage the locking hubs (optional) by rotating the hub lock control from LOCK to FREE.

For proper operation, make sure that both indicator arrows on the hub are aligned, and that both hubs are set to either FREE or LOCK.

## Shifting to/from 4L (4x4 Low)

1. Bring the vehicle to a stop or a speed below 3 mph (5 km/h).
2. Place the transmission in N (Neutral).
3. Move the transfer case shift lever through N (Neutral) directly to the desired position.
4. If the transfer case does not, or only partially moves to the desired position, perform a shift with the transmission in N (Neutral) and the vehicle rolling at a speed below 3 mph (5 km/h).

5. If shifting to 2H (2WD) with the vehicle at a complete stop, disengage the locking hubs (optional) by rotating the hub lock control from LOCK to FREE.

## Using the N (Neutral) position

### WARNING



Do not leave the vehicle unattended with the transfer case in the N (Neutral) position. Always set the parking brake fully and turn off the ignition when leaving the vehicle.

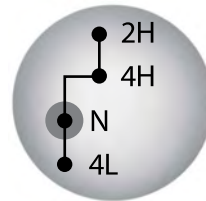

E163189

The transfer case neutral position overrides the transmission and puts the vehicle in neutral regardless of transmission gearshift lever position. The vehicle can move forward or backwards.

This position should only be used when towing the vehicle.

## Four-Wheel Drive (If Equipped)

### Using the Electronic Shift on the Fly 4WD system (If Equipped)



E163190

#### 2H (2WD)

For general on-road driving. Sends power to the rear wheels only and should be used for street and highway driving. Provides optimal smoothness and fuel economy at high speeds.

#### 4H (4X4 HIGH)

Used for extra traction such as in snow or icy roads or in off road situations. This mode is not intended for use on dry pavement.

#### 4L (4X4 LOW)

Uses extra gearing to provide maximum power to all four wheels at reduced speeds. Intended only for off-road applications such as deep sand, steep grades, or pulling heavy objects. 4L (4x4 low) will not engage while the vehicle is moving above 3 mph (5 km/h); this is normal and should be no reason for concern. Refer to Shifting to/from 4L (4x4 low) for proper operation.

#### Shifting between system modes

**Note:** Momentarily releasing the accelerator pedal while performing a shift will improve engagement/disengagement times.

**Note:** Do not perform this operation if the rear wheels are slipping.

**Note:** Some noise may be heard as the system shifts or engages; this is normal.

**Note:** 4X4 high mode is not intended for use on dry pavement.

You can move the control from 2H or 4H at a stop or while driving. The information display may display a message indicating a 4X4 shift is in progress. Once the shift is complete the message center will then display the system mode selected.

If **SHIFT DELAYED PULL FORWARD** is displayed in the information display during the mode shift, transfer case gear tooth blockage is present. To alleviate this condition, place the transmission in a forward gear and move the vehicle forward approximately 5 feet (1.5 meters) to allow the transfer case to complete the mode shift.

#### Shifting to/from 4L (4X4 low)

**Note:** Some noise may be heard as the system shifts or engages; this is normal.

**Note:** 4x4 low mode is not intended for use on dry pavement.

1. Bring the vehicle to a speed of 3 mph (5 km/h) or less.
2. Place the transmission in N (Neutral).
3. Move the 4WD control to the desired position.

The information display will display a message indicating a 4X4 shift is in progress. The information display will then display the system mode selected. If any of the above shift conditions are not met, the shift will not occur and the information display will display information guiding the driver through the proper shifting procedures.

## Four-Wheel Drive (If Equipped)

If **SHIFT DELAYED PULL FORWARD** is displayed in the information display, transfer case gear tooth blockage is present. To alleviate this condition, place the transmission in a forward gear, move the vehicle forward approximately 5 feet (1.5 meters), and shift the transmission back to neutral to allow the transfer case to complete the range shift.

### How Your Vehicle Differs From Other Vehicles

#### WARNING



Vehicles with a higher center of gravity such as utility and four-wheel drive vehicles handle differently than vehicles with a lower center of gravity. Utility and four-wheel drive vehicles are not designed for cornering at speeds as high as passenger cars any more than low-slung sports cars are designed to perform satisfactorily under off-road conditions. Avoid sharp turns, excessive speed and abrupt maneuvers in these vehicles. Failure to drive cautiously could result in an increased risk of loss of vehicle control, vehicle rollover, personal injury and death.

Truck and utility vehicles can differ from some other vehicles. Your vehicle may be higher to allow it to travel over rough terrain without getting hung up or damaging underbody components.

The differences that make your vehicle so versatile also make it handle differently than an ordinary passenger car.

Maintain steering wheel control at all times, especially in rough terrain. Since sudden changes in terrain can result in abrupt steering wheel motion, make sure you grip the steering wheel from the outside. Do not grip the spokes.

Drive cautiously to avoid vehicle damage from concealed objects such as rocks and stumps.

You should either know the terrain or examine maps of the area before driving. Map out your route before driving in the area. To maintain steering and braking control of your vehicle, you must have all four wheels on the ground and they must be rolling, not sliding or spinning.

### Driving Off-Road With Truck and Utility Vehicles

**Note:** *On some models, the initial shift from two-wheel drive to four-wheel drive while the vehicle is moving can cause some momentary clunk and ratcheting sounds. This is the front drivetrain coming up to speed and the automatic locking hubs engaging and is not cause for concern.*

**Note:** *Your vehicle may be equipped with a front air dam that can become damaged (due to reduced ground clearance) when taking your vehicle off-road. This air dam can be taken off by removing two bolts.*

Four-wheel drive vehicles are specially equipped for driving on sand, snow, mud and rough terrain and have operating characteristics that are somewhat different from conventional vehicles, both on and off the road.

Power is supplied to all four wheels through a transfer case. On Four-wheel drive vehicles, the transfer case allows you to select 4WD when necessary. Information on transfer case operation and shifting procedures can be found in this chapter. Information on transfer case maintenance can be found in the Maintenance chapter. You should become thoroughly familiar with this information before you operate your vehicle.



## Four-Wheel Drive (If Equipped)

---

Four-wheel drive (when you select a 4WD mode) uses all four wheels to power the vehicle. This increases traction, enabling you to drive over terrain and road conditions that a conventional two-wheel drive vehicle cannot.

### Basic Operating Principles

- Drive slower in strong crosswinds which can affect the normal steering characteristics of your vehicle.
- When driving your vehicle on surfaces made slippery by loose sand, water, gravel, snow or ice proceed with care.
- Do not use Four-wheel drive on dry, hard surfaced roads. Doing so will produce excessive noise, increase tire wear and may damage drive components. Four-wheel drive modes are only intended for consistently slippery or loose surfaces.

### If Your Vehicle leaves the Road

If your vehicle leaves the road, reduce your vehicle speed and avoid severe braking. When your vehicle speed has been reduced ease your vehicle back onto the road. Do not turn the steering wheel sharply while returning your vehicle to the road.

It may be safer to stay on the shoulder of the road and slow down gradually before returning to the road. You may lose control if you do not slow down or if you turn the steering wheel too sharply or abruptly.

It may be less risky to strike small objects, such as freeway reflectors, with minor damage to your vehicle rather than attempt a sudden return to the road which could cause your vehicle to slide sideways out of control or roll over. Remember, your safety and the safety of others should be your primary concern.

### Emergency Maneuvers

In an unavoidable emergency situation where a sudden sharp turn must be made, remember to avoid over-driving your vehicle (i.e. turn the steering wheel only as rapidly and as far as required to avoid the emergency). Excessive steering can result in loss of vehicle control. Apply smooth pressure to the accelerator pedal or brake pedal when changes in vehicle speed are required. Avoid abrupt steering, acceleration and braking. This could result in an increased risk of vehicle roll over, loss of vehicle control and personal injury. Use all available road surface to bring your vehicle to a safe direction of travel.

In the event of an emergency stop, avoid skidding the tires and do not attempt any sharp steering wheel movements.

If your vehicle goes from one type of surface to another (i.e. from concrete to gravel) there will be a change in the way your vehicle responds to a maneuver (i.e. steering, acceleration or braking).

### Sand

When driving over sand, try to keep all four wheels on the most solid area of the trail. Avoid reducing the tire pressures but shift to a lower gear and drive steadily through the terrain. Apply the accelerator slowly and avoid excessive wheel slip.

When driving at slow speeds in deep sand under high outside temperatures, use a low gear when possible. Low gear operation will maximize the engine and transmission cooling capability.

Avoid driving at excessive speeds, this causes vehicle momentum to work against you and your vehicle could become stuck to the point that assistance may be required from another vehicle. Remember, you may be able to back out the way you came if you proceed with caution.

# Four-Wheel Drive (If Equipped)

## Mud and Water

### Mud

Be cautious of sudden changes in vehicle speed or direction when you are driving in mud. Even four-wheel drive vehicles can lose traction in slick mud. If your vehicle does slide, steer in the direction of the slide until you regain control of your vehicle.

After driving through mud, clean off residue stuck to rotating driveshafts and tires. Excess mud stuck on tires and rotating driveshafts can cause an imbalance that could damage drive components.

### Water

If you must drive through high water, drive slowly. Traction or brake capability may be limited.

When driving through water, determine the depth and avoid water higher than the bottom of the hubs. If the ignition system gets wet, your vehicle may stall.

Once through water, always try the brakes. Wet brakes do not stop your vehicle as effectively as dry brakes. Drying can be improved by applying light pressure to the brake pedal while moving slowly.

**Note:** *Driving through deep water may damage the transmission. If the front or rear axle is submerged in water, the axle lubricant and power transfer unit lubricant should be checked and changed if necessary.*

## Driving on Hilly or Sloping Terrain

Although natural obstacles may make it necessary to travel diagonally up or down a hill or steep incline, you should always try to drive straight up or straight down.

**Note:** *Avoid turning on steep slopes or hills. A danger lies in losing traction, slipping sideways and possible vehicle roll over. Whenever driving on a hill, determine beforehand the route you will use. Do not drive over the crest of a hill without seeing what conditions are on the other side. Do not drive in reverse over a hill without the aid of an observer.*

When climbing a steep slope or hill, start in a lower gear rather than downshifting to a lower gear from a higher gear once the ascent has started. This reduces strain on the engine and the possibility of stalling.

If your vehicle stalls, do not try to turn around because this could cause vehicle roll over. It is better to reverse back to a safe location.

Apply just enough power to the wheels to climb the hill. Too much power will cause the tires to slip, spin or lose traction, resulting in loss of vehicle control.



E143949

Descend a hill in the same gear you would use to climb up the hill to avoid excessive brake application and brake overheating. Do not descend in neutral. Disengage overdrive or move the transmission selector lever to a lower gear. When descending a steep hill, avoid sudden hard braking as you could lose control. The front wheels have to be turning in order to steer your vehicle.

## Four-Wheel Drive (If Equipped)

---

If your vehicle has anti-lock brakes, apply the brakes steadily. Do not pump the brakes.

### Driving on Snow and Ice

#### WARNING



If you are driving in slippery conditions that require tire chains or cables, then it is critical that you drive cautiously. Keep speeds down, allow for longer stopping distances and avoid aggressive steering to reduce the chances of a loss of vehicle control which can lead to serious injury or death. If the rear end of your vehicle slides while cornering, steer in the direction of the slide until you regain control of your vehicle.

---

**Note:** *Excessive tire slippage can cause transmission damage.*

Four-wheel drive vehicles have advantages over two-wheel drive vehicles in snow and ice but can skid like any other vehicle. Should you start to slide while driving on snowy or icy roads, turn the steering wheel in the direction of the slide until you regain control.

Avoid sudden applications of power and quick changes of direction on snow and ice. Apply the accelerator slowly and steadily when starting from a full stop.

Avoid sudden braking. Although a four-wheel drive vehicle may accelerate better than a two-wheel drive vehicle in snow and ice, it will not stop any faster as braking occurs at all four wheels. Do not become overconfident as to road conditions.

Make sure you allow sufficient distance between you and other vehicles for stopping. Drive slower than usual and consider using one of the lower gears. In emergency stopping situations, apply the brake steadily. Do not pump the brake pedal. See **Hints on Driving With Anti-Lock Brakes** (page 164).

### If Your Vehicle Gets Stuck In Mud or Snow

#### WARNING



Do not spin the wheels at over 35 mph (56 km/h). The tires may fail and injure a passenger or bystander.

---

If your vehicle gets stuck in mud or snow, it may be rocked out by shifting between forward and reverse gears, stopping between shifts in a steady pattern. Press lightly on the accelerator in each gear.

**Note:** *Do not rock your vehicle if the engine is not at normal operating temperature, damage to the transmission may occur.*

**Note:** *Do not rock your vehicle for more than a minute, damage to the transmission and tires may occur or the engine may overheat.*

### Parking

#### WARNINGS



If the parking brake is fully released, but the brake warning lamp remains illuminated, the brakes may not be working properly. See your authorized dealer.



Always set the parking brake fully and make sure the gearshift is latched in P (Park). Turn the ignition to the off position and remove the key whenever you leave your vehicle.

---

## Four-Wheel Drive (If Equipped)

---

On some Four-wheel drive vehicles, when the transfer case is in the N (Neutral) position, the engine and transmission are disconnected from the rest of the driveline. Therefore, the vehicle is free to roll even if the automatic transmission is in P (Park) or the manual transmission is in gear. Do not leave the vehicle unattended with the transfer case in the N (Neutral) position. Always set the parking brake fully and turn off the ignition when leaving the vehicle.

### **Maintenance and Modifications**

The suspension and steering systems on your vehicle have been designed and tested to provide predictable performance whether loaded or empty. For this reason, we strongly recommend that you do not make modifications such as adding or removing parts (i.e. lift kits or stabilizer bars) or by using replacement parts not equivalent to the original factory equipment.

We recommend that you use caution when your vehicle has either a high load or device (i.e. ladder or luggage racks). Any modifications to your vehicle that raise the center of gravity may cause your vehicle to roll over when there is a loss of vehicle control.

Failure to maintain your vehicle correctly may void the warranty, increase your repair cost, reduce vehicle performance and operational capabilities and adversely affect you and your passenger's safety. We recommend you frequently inspect your vehicle's chassis components when your vehicle is subject to off road usage.

# Rear Axle

## LIMITED SLIP DIFFERENTIAL

This axle provides added traction on slippery surfaces, particularly when one wheel is on a poor traction surface. Under normal conditions, the limited-slip axle functions like a standard rear axle. The axle may exhibit a slight noise or vibration during tight turns with low vehicle speed. This is normal behavior and indicates the axle is working.

## ELECTRONIC LOCKING DIFFERENTIAL

**Note:** *The electronic locking differential is for off-road use only and is not for use on dry pavement. Using the electronic locking differential on dry pavement will result in increased tire wear, noise and vibration.*

The electronic locking differential is a device housed in the rear axle that allows both rear wheels to turn at the same speed. The electronic locking differential can provide additional traction should your vehicle become stuck. You can activate the differential electronically and shift it on the fly within the differential operating speed range. The differential is for use in mud, rocks, sand, or any off-road condition where you need maximum traction. It is not for use on dry pavement.

The following conditions will affect the electronic locking differential:

- On 2WD vehicles and 4WD vehicles in 2H (4X2) or 4H (4X4 High), the ELD will not engage if the vehicle speed is above 20 mph (32 km/h).
- On 2WD vehicles and 4WD vehicles in 2H (4X2) or 4H (4X4 High), the ELD will automatically disengage at speeds above 25 mph (40 km/h) and will automatically reengage at speeds below 20 mph (32 km/h).
- On 4WD vehicles in 4L (4X4 Low), the ELD can be engaged at any speed and will not automatically disengage.

## Activating the Electronic Locking Differential (If Equipped)

**Note:** *Do not use electronic locking differential on dry, hard surfaced roads. Doing so will produce excessive noise, vibration and increase tire wear.*

**Note:** *If the electronic locking differential has difficulty disengaging, release the accelerator pedal and turn the steering wheel in the opposite direction while rolling.*

## For vehicles equipped with an electronic shift 4WD system

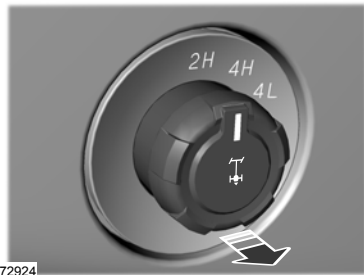

E172924

Pull the 4WD control knob toward you.

# Rear Axle

---

## For 2WD vehicles and vehicles equipped with a manual shift 4WD system



E163191

Turn the control to ON.



Once the indicator light illuminates in the information display, both rear wheel axle shafts will be locked together providing added traction.

If the indicator does not come on, or the indicator turns off while driving, one of the following has occurred:

- The vehicle speed is too high.
- The left and right rear wheel speed difference is too high during an engagement attempt.
- The system has malfunctioned and is accompanied by CHECK LOCKING DIFFERENTIAL in the information display. See your authorized Ford dealer for assistance.

# Brakes

## GENERAL INFORMATION

**Note:** Occasional brake noise is normal. If a metal-to-metal, continuous grinding or continuous squeal sound is present, the brake linings may be worn-out. Have the system checked by an authorized dealer. If your vehicle has continuous vibration or shudder in the steering wheel while braking, have it checked by an authorized dealer.

**Note:** Brake dust may accumulate on the wheels, even under normal driving conditions. Some dust is inevitable as the brakes wear and does not contribute to brake noise. See **Cleaning the Alloy Wheels** (page 260).



See **Warning Lamps and Indicators** (page 79).

Wet brakes result in reduced braking efficiency. Gently press the brake pedal a few times when driving from a car wash or standing water to dry the brakes.

## Brake Over Accelerator

In the event the accelerator pedal becomes stuck or entrapped, apply steady and firm pressure to the brake pedal to slow the vehicle and reduce engine power. If you experience this condition, apply the brakes and bring your vehicle to a safe stop. Move the transmission to park (P), switch the engine off and apply the parking brake. Inspect the accelerator pedal for any interference. If none are found and the condition persists, have your vehicle towed to the nearest authorized dealer.

## Brake Assist

Brake assist detects when you brake rapidly by measuring the rate at which you press the brake pedal. It provides maximum braking efficiency as long as you press the pedal, and can reduce stopping distances in critical situations.

## Anti-lock Brake System

This system helps you maintain steering control during emergency stops by keeping the brakes from locking.



This lamp momentarily illuminates when you turn the ignition on. If the light does not illuminate during start up, remains on or flashes, the system may be disabled. Have the system checked by an authorized dealer. If the anti-lock brake system is disabled, normal braking is still effective.



If the brake warning lamp illuminates when you release the parking brake, have the system checked by an authorized dealer.

## HINTS ON DRIVING WITH ANTI-LOCK BRAKES

**Note:** When the system is operating, the brake pedal will pulse and may travel further. Maintain pressure on the brake pedal. You may also hear a noise from the system. This is normal.

The anti-lock braking system will not eliminate the risks when:

- You drive too closely to the vehicle in front of you.
- Your vehicle is hydroplaning.
- You take corners too fast.
- The road surface is poor.

# Brakes

## PARKING BRAKE

### WARNING



Always set the parking brake fully and make sure the transmission is placed in park (P). Failure to set the parking brake and engage park could result in vehicle roll-away, property damage or bodily injury. Turn the ignition to the lock position and remove the key whenever you leave your vehicle.

Apply the parking brake whenever your vehicle is parked. Press the pedal downward to set the parking brake. The brake warning lamp in the instrument cluster will illuminate and remains illuminated until the parking brake is released.

To release, pull the brake release lever located at the lower left side of the instrument panel.

If you are parking your vehicle on a grade or with a trailer, press and hold the brake pedal down, then set the parking brake. There may be a little vehicle movement as the parking brake sets to hold the vehicle's weight. This is normal and should be no reason for concern. If needed, press and hold the service brake pedal down, then try reapplying the parking brake. Chock the wheels if required. If the parking brake cannot hold the weight of the vehicle, the parking brake may need to be serviced or the vehicle may be overloaded.

## HILL START ASSIST

### WARNINGS



The system does not replace the parking brake. When you leave your vehicle, always apply the parking brake. Failure to leave your vehicle securely parked may lead to a crash or injury. See **Parking Brake** (page 165).

### WARNINGS



You must remain in your vehicle when the system turns on. At all times, you are responsible for controlling your vehicle, supervising the system and intervening, if required. Failure to take care may result in the loss of control of your vehicle, serious personal injury or death.



The system will turn off if a malfunction is apparent or if you rev the engine excessively. Failure to take care may result in the loss of control of your vehicle, serious personal injury or death.

The system makes it easier to pull away when your vehicle is on a slope without the need to use the parking brake.

When the system is active, your vehicle remains stationary on the slope for two to three seconds after you release the brake pedal. This allows time to move your foot from the brake to the accelerator pedal. The system releases the brakes automatically once the engine has developed sufficient drive to prevent your vehicle from rolling down the slope. This is an advantage when pulling away on a slope, for example from a car park ramp, traffic lights or when reversing uphill into a parking space.

**Note:** *The system only functions when you bring your vehicle to a complete standstill. Shift the gearshift lever to reverse (R) when facing downhill and first gear (1) when facing uphill.*

**Note:** *There is no warning light to indicate the system is either on or off.*

### Using Hill Start Assist

1. Press the brake pedal to bring your vehicle to a complete standstill. Keep the brake pedal pressed.



# Brakes

---

2. If the sensors detect that your vehicle is on a slope, the system activates automatically.
3. When you remove your foot from the brake pedal, your vehicle remains on the slope without rolling away for about two to three seconds. This hold time automatically extends if you are in the process of driving off.
4. Drive off in the normal manner. The system releases the brakes automatically.

**Note:** *When you remove your foot from the brake pedal and press the pedal again when the system is active, you will experience significantly reduced brake pedal travel. This is normal.*

## Switching the System On and Off

When you switch the ignition on, the system automatically turns on. You can switch the system on or off in the information display. See **General Information** (page 84). The system remains off until you switch the ignition off.

**Note:** *For vehicles with a manual transmission, the system can be switched on or off.*

**Note:** *For vehicles with an automatic transmission, the system cannot be switched off.*

# Traction Control

## PRINCIPLE OF OPERATION

The traction control system helps avoid drive wheel spin and loss of traction.

If your vehicle begins to slide, the system applies the brakes to individual wheels and, when needed, reduces engine power at the same time. If the wheels spin when accelerating on slippery or loose surfaces, the system reduces engine power in order to increase traction.

## USING TRACTION CONTROL

### (Dual rear wheel vehicles only)

In certain situations (for example, stuck in snow or mud), it may be beneficial to turn the traction control system off. This allows the wheels to spin with full engine power.

## TCS OFF

E162724

Turn the traction control system off by pressing the stability control button located on the instrument panel.

If you cannot turn the system off, see the MyKey chapter for more information.

Placing your vehicle into four-wheel drive mode automatically disables traction control. Traction control operation will resume when you place your vehicle back into two-wheel drive mode.

<b>Engine only traction control (Dual rear wheel vehicles only)</b>		
<b>Button functions</b>	<b>Stability control OFF indicator</b>	<b>Traction control system</b>
Default at start-up	Not illuminated	Enabled
Button pressed momentarily	Illuminated	Disabled
Button pressed again after deactivation	Not illuminated	Enabled
Transfer case switched to 4WD*	Illuminated	Disabled

\*Engaging 4WD automatically disables the traction control system.

# Traction Control

---

## System Indicator Lights and Messages

### WARNING



If a failure has been detected within the AdvanceTrac system, the stability control light will illuminate steadily. Verify that the traction control system was not manually disabled using the stability control button. If the stability control light still illuminates steadily, have the system serviced by an authorized dealer immediately. Operating your vehicle with traction control disabled could lead to an increased risk of loss of vehicle control, vehicle rollover, personal injury and death.

---



The stability control light temporarily illuminates on engine start-up and flashes when a driving condition activates the stability system.





The stability control off light temporarily illuminates on engine start-up and stays on when you turn the traction control system off, or if a problem occurs in the stability system.

# Stability Control

## PRINCIPLE OF OPERATION

### WARNINGS

 Vehicle modifications involving braking system, aftermarket roof racks, suspension, steering system, tire construction and wheel and tire size may change the handling characteristics of your vehicle and may adversely affect the performance of the AdvanceTrac system. In addition, installing any stereo loudspeakers may interfere with and adversely affect the AdvanceTrac system. Install any aftermarket stereo loudspeaker as far as possible from the front center console, the tunnel, and the front seats in order to minimize the risk of interfering with the AdvanceTrac sensors. Reducing the effectiveness of the AdvanceTrac system could lead to an increased risk of loss of vehicle control, vehicle rollover, personal injury and death.

 Remember that even advanced technology cannot defy the laws of physics. It's always possible to lose control of a vehicle due to inappropriate driver input for the conditions. Aggressive driving on any road condition can cause you to lose control of your vehicle increasing the risk of personal injury or property damage. Activation of the AdvanceTrac system is an indication that at least some of the tires have exceeded their ability to grip the road; this could reduce the operator's ability to control the vehicle potentially resulting in a loss of vehicle control, vehicle rollover, personal injury and death. If your AdvanceTrac system activates, SLOW DOWN.

The AdvanceTrac with Roll Stability Control system helps you keep control of your vehicle when on a slippery surface. The electronic stability control portion of the system helps avoid skids and lateral slides and roll stability control helps avoid a vehicle rollover. The traction control system helps avoid drive wheel spin and loss of traction. See **Using Traction Control** (page 167).

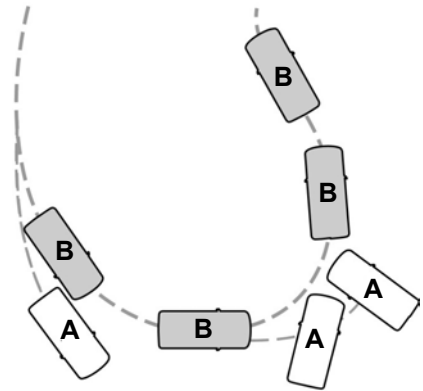

E72903

- A Vehicle without AdvanceTrac with RSC skidding off its intended route.
- B Vehicle with AdvanceTrac with RSC maintaining control on a slippery surface.

## USING STABILITY CONTROL

### AdvanceTrac® with Roll Stability Control™ (RSC®)

**(Single rear wheel vehicles only)**

# Stability Control

The system automatically activates when you start your engine. The electronic stability control and roll stability control portions of the system can be turned off below 35 mph (56 km/h) and are disabled when the transmission is in position **R**. See **Using Traction Control** (page 167).



E169377

You can turn off the traction control portion of the system independently. Press the stability control button located on the instrument panel.

<b>AdvanceTrac with RSC Features (Single rear wheels only)</b>				
<b>Button functions</b>	<b>Stability control light</b>	<b>Roll stability control</b>	<b>Electronic stability control</b>	<b>Traction control system</b>
Default at start-up	Illuminated during bulb check	Enabled	Enabled	Enabled
Button pressed momentarily	Illuminated solid	Enabled	Enabled <sup>1</sup>	Disabled
Button pressed and held for more than 5 seconds at vehicle speed under 35 mph (56 km/h)	Flashes then illuminated solid <sup>2</sup>	Disabled	Disabled	Disabled
Vehicle speed exceeds 35 mph (56 km/h) after button is pressed and held for more than 5 seconds	Illuminated solid	Enabled	Enabled <sup>1</sup>	Disabled

# Stability Control

<b>AdvanceTrac with RSC Features (Single rear wheels only)</b>				
Button pressed again after deactivation	Not illuminated	Enabled	Enabled	Enabled
Transfer case switched to 4WD Low <sup>3</sup>	Illuminated	Disabled	Disabled	Disabled

<sup>1</sup>Electronic stability control has reduced sensitivity compared to fully active system.

<sup>2</sup>Lamp light starts blinking for four seconds after entering the press and hold state.

<sup>3</sup>Engaging 4WD Low locked automatically disables roll stability control, electronic stability control and the traction control system.

# Terrain Response (If Equipped)

## PRINCIPLE OF OPERATION

### WARNINGS



Hill descent control cannot control descent in all surface conditions and circumstances, such as ice or extremely steep grades. Hill descent control is a driver assist system and cannot substitute for good judgment by the driver. Failure to do so may result in loss of vehicle control, crash or serious injury.



Hill descent control does not provide hill hold at zero miles per hour (0 kilometers per hour). When stopped, the parking brake must be applied or the vehicle must be placed in **P** (Park) or it may roll away.

Hill descent control allows the driver to set and maintain vehicle speed while descending steep grades in various surface conditions.

Hill descent control can maintain vehicle speeds on downhill grades between 2 mph (3 km/h) and 12 mph (20 km/h). Above 20 mph (32 km/h), the system remains armed, but descent speed cannot be set or maintained.

Hill descent control requires a cooling down interval after a period of sustained use. The amount of time that the feature can remain active before cooling varies with conditions. The system will provide a warning in the message center and a chime will sound when the system is about to disengage for cooling. At this time, manually apply the brakes as needed to maintain descent speed.

## USING HILL DESCENT CONTROL



Press and release the hill descent button located on the instrument panel. A light in the cluster will illuminate and a chime will sound when this feature is activated.

To increase descent speed, press the accelerator pedal until the desired speed is reached. To decrease descent speed, press the brake pedal until the desired speed is reached.

Whether accelerating or decelerating, once the desired descent speed is reached, remove your feet from the pedals and the chosen vehicle speed will be maintained.

**Note:** *Noise from the ABS pump motor may be observed during hill descent control operation. This is a normal characteristic of the ABS and should be no reason for concern.*

### Hill descent modes

- At speeds below 20 mph (32 km/h): When the Hill Descent Control switch is pressed and Hill Descent Control is active, the Hill Descent Control telltale will flash.
- At speeds below 20 mph (32 km/h): When the Hill Descent Control switch is pressed and conditions are not correct for hill descent activation, the Hill Descent Control system will be enabled, the Hill Descent Control telltale will be solid and a message will display in the information display.

## Terrain Response (If Equipped)

---

- At speeds above 20 mph (32 km/h):  
When the Hill Descent Control switch is pressed, the Hill Descent Control system will be enabled, the telltale in the cluster will not be illuminated and a message will be displayed in the information display.

Refer to the Information Displays for additional Hill Descent Control messages. See **Information Messages** (page 95).



# Parking Aids

## PARKING AID (If Equipped)

### WARNINGS



To help avoid personal injury, please read and understand the limitations of the system as contained in this section. Sensing is only an aid for some (generally large and fixed) objects when moving in reverse on a flat surface at parking speeds. Traffic control systems, inclement weather, air brakes, and external motors and fans may also affect the function of the sensing system; this may include reduced performance or a false activation.



To help avoid personal injury, always use caution when in R (Reverse) and when using the sensing system.



This system is not designed to prevent contact with small or moving objects. The system is designed to provide a warning to assist the driver in detecting large stationary objects to avoid damaging the vehicle. The system may not detect smaller objects, particularly those close to the ground.



Certain add-on devices such as large trailer hitches, bike or surfboard racks and any device that may block the normal detection zone of the system, may create false beeps.

**Note:** *Keep the sensors, located on the bumper or fascia, free from snow, ice and large accumulations of dirt. If the sensors are covered, the system's accuracy can be affected. Do not clean the sensors with sharp objects.*

**Note:** *If your vehicle sustains damage to the bumper or fascia, leaving it misaligned or bent, the sensing zone may be altered causing inaccurate measurement of obstacles or false alarms.*

**Note:** *If your vehicle is equipped with MyKey™, it is possible to prevent turning the sensing system off. See MyKey™ (page 51).*

**Note:** *When a trailer is connected to your vehicle, the Rear Sensing System may detect the trailer and therefore provide warnings. It is suggested that the driver disables the Rear Sensing System when a trailer is connected to your vehicle to prevent these warnings.*

The sensing system warns the driver of obstacles within a certain range of the bumper area. The system turns on automatically whenever the ignition is switched on.

When receiving a detection warning, the radio volume is reduced to a predetermined level. After the warning goes away, the radio volume returns to the previous level.

### Rear Sensing System

The rear sensors are only active when the transmission is in reverse (R). As your vehicle moves closer to the obstacle, the rate of the audible warning increases. When the obstacle is fewer than 12 in (30 cm) away, the warning sounds continuously. If a stationary or receding object is detected farther than 12 in (30 cm) from the side of your vehicle, the tone sounds for only three seconds. Once the system detects an object approaching, the warning sounds again.

# Parking Aids



E130178

Coverage area of up to 6 feet (1.8 meters) from the rear bumper. There is decreased coverage area at the outer corners of the bumper.

The system detects certain objects while the transmission is in reverse (R):

- and moving toward a stationary object at a speed of 3 mph (5 km/h) or less.
- but not moving, and a moving object is approaching the rear of your vehicle at a speed of 3 mph (5 km/h) or less.

The system can be switched off through the information display. If a fault is present in the system, a warning message appears in the information display and does not allow the driver to switch the faulted system on.

## REAR VIEW CAMERA (If Equipped)

### WARNINGS



The rear view camera system is a reverse aid supplement device that still requires the driver to use it in conjunction with the interior and exterior mirrors for maximum coverage.

### WARNINGS



Objects that are close to either corner of the bumper or under the bumper, might not be seen on the screen due to the limited coverage of the camera system.



Back up as slow as possible since higher speeds might limit your reaction time to stop the vehicle.



Use caution when using the rear video camera and the tailgate is ajar. If the tailgate is ajar, the camera will be out of position and the video image may be incorrect. All guidelines (if enabled) have been removed when the tailgate is ajar.



Use caution when turning camera features on or off while in reverse (R). Make sure the vehicle is not moving.

The rear view camera system provides a video image of the area behind your vehicle.

During operation, lines appear in the display that represent your vehicle's path and proximity to objects behind your vehicle.



E163192

The camera is located on the tailgate.

# Parking Aids

## Using the Rear View Camera System

The rear view camera system displays what is behind your vehicle when you place the transmission in reverse (R).

The system uses two types of guides to help you see what is behind your vehicle:

- Fixed guidelines: Show the actual path your vehicle is moving in while reversing in a straight line. This can be helpful when backing into a parking space or aligning your vehicle with another object behind you.
- Centerline: Helps align the center of your vehicle with an object (for example, a trailer).

**Note:** The image may remain on momentarily when you shift the transmission out of reverse (R). If your vehicle speed reaches 6 mph (10 km/h) or 10 seconds elapse and the image remains on, have your system inspected by an authorized dealer.

**Note:** When towing, the camera only sees what you are towing behind your vehicle. This might not provide adequate coverage as it usually provides in normal operation and you might not see some objects. In some vehicles, the guidelines may disappear once you engage the trailer tow connector.

The camera may not operate correctly under the following conditions:

- Nighttime or dark areas if the reverse lamps are not operating.
- Mud, water or debris obstructs the camera's view. Clean the lens with a soft, lint-free cloth and non-abrasive cleaner.
- The camera is misaligned due to damage to the rear of your vehicle.

To access any of the rear view camera system settings, make the following selections in the display screen when the transmission is not in reverse (R):

- Menu > Vehicle > Camera Settings

After changing a system setting, the touch screen shows a preview of the selected features.

## Guidelines and the Centerline

**Note:** Fixed guidelines are only available when the transmission is in reverse (R).

**Note:** The centerline is only available if fixed guidelines are on.

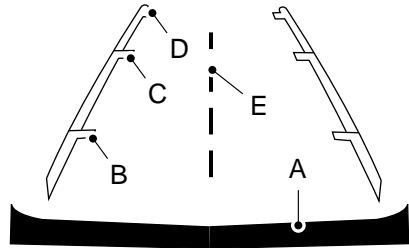

E163914

- A Rear bumper
- B Fixed guideline: Red zone
- C Fixed guideline: Yellow zone
- D Fixed guideline: Green zone
- E Centerline

The fixed guidelines fade in and out depending on the steering wheel position.

Always use caution while reversing. Objects in the red zone are closest to your vehicle and objects in the green zone are farther away. Objects are getting closer to your vehicle as they move from the green zone to the yellow or red zones. Use the side view mirrors and rear view mirror to get better coverage on both sides and rear of the vehicle.

# Parking Aids

---

## Enhanced Park Aids

**Note:** *Enhanced park aids is only available when the transmission is in reverse (R).*

**Note:** *The reverse sensing system is not effective at speeds above 3 mph (5 km/h) and may not detect certain angular or moving objects.*

The system uses red, yellow and green highlights which appear on top of the video image when an object is detected by the reverse sensing system. The alert highlights the closest object detected. The reverse sensing alert can be disabled and if visual park aid alert is enabled, highlighted areas are still displayed.

Selectable settings for this feature are ON and OFF.

## Rear Camera Delay

When shifting the transmission out of reverse (R) and into any gear other than park (P), the camera image remains in the display until your vehicle speed reaches 6 mph (10 km/h) or 10 seconds elapses. This occurs when the rear camera delay feature is ON.

Selectable settings for this feature are ON and OFF. The default setting for the rear camera delay is OFF.

# Cruise Control (If Equipped)

## PRINCIPLE OF OPERATION

Cruise control lets you maintain a set speed without keeping your foot on the accelerator pedal. You can use cruise control when your vehicle speed is greater than 20 mph (30 km/h).

## USING CRUISE CONTROL

### WARNINGS



Do not use cruise control in heavy traffic, on winding roads or when the road surface is slippery. This could result in loss of vehicle control, serious injury or death.



When you are going downhill, your vehicle speed may increase above the set speed. The system will not apply the brakes. Change down a gear to assist the system in maintaining the set speed. Failure to do so could result in loss of vehicle control, serious injury or death.

**Note:** Cruise control will disengage if the vehicle speed decreases more than 10 mph (16 km/h) below your set speed while driving uphill.



E163053

The cruise controls are located on the steering wheel.

## Switching Cruise Control On

Press and release **ON**.



The indicator will appear in the instrument cluster.

## Setting a Speed

1. Accelerate to the desired speed.
2. Press and release **SET+**.
3. Take your foot off the accelerator pedal.

The indicator will change colors in the instrument cluster.

## Changing the Set Speed

**Note:** If you accelerate by pressing the accelerator pedal, the set speed will not change. When you release the accelerator pedal, you will return to the speed that you previously set.

- Press and hold **SET+** or **SET-**. Release the control when you reach the desired speed.
- Press and release **SET+** or **SET-**. The set speed will change in approximately 1 mph (2 km/h) increments.
- Press the accelerator or brake pedal until you reach the desired speed. Press and release **SET+**.

## Canceling the Set Speed

Press **CNCL** or tap the brake pedal. You will not erase the set speed.

## Resuming the Set Speed

Press and release **RSM**.

## Switching Cruise Control Off

**Note:** You will erase the set speed if you switch the system off.

Press and release **OFF** or switch the ignition off.

## STEERING

To help prevent damage to the power steering system:

- Never hold the steering wheel at its furthest turning points (until it stops) for more than three to five seconds when the engine is running.
- Do not operate the vehicle with a low power steering pump fluid level (below the MIN mark on the reservoir).
- Some noise is normal during operation. If excessive, check for low power steering pump fluid level before seeking service by your dealer.
- Heavy or uneven efforts may be caused by low power steering fluid. Check for low power steering pump fluid level before seeking service by your dealer.
- Do not fill the power steering pump reservoir above the MAX mark on the reservoir, as this may result in leaks from the reservoir.

If the power steering system breaks down (or if the engine is turned off), you can steer the vehicle manually, but it takes more effort.

If the steering wanders or pulls, check for:

- an improperly inflated tire
- uneven tire wear
- loose or worn suspension components
- loose or worn steering components
- improper vehicle alignment

If any steering components are serviced or replaced, install new fasteners (many are coated with thread adhesive or have prevailing torque features which may not be re-used). Never re-use a bolt or nut. Torque fasteners to specifications.

A high crown in the road or high crosswinds may also make the steering seem to wander or pull.

# Load Carrying

## LOAD LIMIT

### Vehicle Loading - with and without a Trailer

This section will guide you in the proper loading of your vehicle, trailer or both, to keep your loaded vehicle weight within its design rating capability, with or without a trailer. Properly loading your vehicle will provide maximum return of vehicle design performance. Before loading your vehicle, familiarize yourself with

the following terms for determining your vehicle's weight ratings, with or without a trailer, from the vehicle's Tire Label or Safety Compliance Certification Label:

**Base Curb Weight** - is the weight of the vehicle including a full tank of fuel and all standard equipment. It does not include passengers, cargo, or optional equipment.

**Vehicle Curb Weight** - is the weight of your new vehicle when you picked it up from your authorized dealer plus any aftermarket equipment.

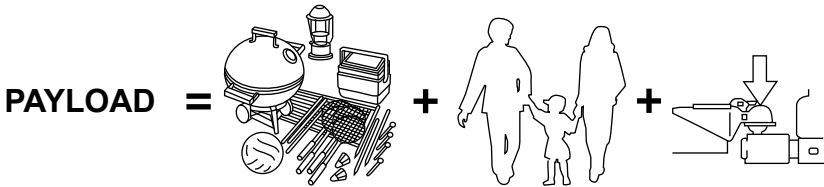

E143816

**Payload** - is the combined weight of cargo and passengers that the vehicle is carrying. The maximum payload for your vehicle can be found on the Tire Label on the B-Pillar or the edge of the driver door (vehicles exported outside the US and Canada may not have a Tire Label). Look for **“THE COMBINED WEIGHT OF OCCUPANTS AND CARGO SHOULD NEVER EXCEED XXX kg OR XXX lb.”** for maximum

payload. The payload listed on the Tire Label is the maximum payload for the vehicle as built by the assembly plant. If you install any aftermarket or authorized-dealer installed equipment on the vehicle, you must subtract the weight of the equipment from the payload listed on the Tire Label in order to determine the new payload.

# Load Carrying

## WARNING



The appropriate loading capacity of your vehicle can be limited either by volume capacity (how much space is available) or by payload capacity (how much weight the vehicle should carry). Once you have reached the maximum payload of your vehicle, do not add more cargo, even if there is space available. Overloading or improperly loading your vehicle can contribute to loss of vehicle control and vehicle rollover.

### Example only:

TIRE AND LOADING INFORMATION			
SEATING CAPACITY		TOTAL 5	FRONT 2   REAR 3
The combined weight of occupants and cargo should never exceed : <b>XXX kg or XXX lbs.</b>			
TIRE XXXXXXXXXXXX	TIRE	SIZE	COLD TIRE PRESSURE
	FRONT	LT225/75R 16.5E	200 KPA, 29 PSI
	REAR	LT225/75R 16.5E	200 KPA, 29 PSI
	SPARE	T145/80D16 P225/60R17	420 KPA, 60 PSI 200 KPA, 29 PSI
			SEE OWNERS MANUAL FOR ADDITIONAL INFORMATION

E142516



# Load Carrying

TIRE AND LOADING INFORMATION		RENSEIGNEMENTS SUR LES PNEUS ET LE CHARGEMENT	
SEATING CAPACITY NOMBRE DE PLACES	TOTAL 5	FRONT AVANT 2	REAR ARRIERE 3
The combined weight of occupants and cargo should never exceed Le poids total des occupants et du chargement ne doit jamais dépasser		492	kg or kg ou 1085 lbs. lb.
TIRE PNEU	SIZE DIMENSIONS	COLD TIRE PRESSURE PRESSION DES PNEUS A FROID	SEE OWNER'S MANUAL FOR ADDITIONAL INFORMATION  VOIR LE MANUEL DE L'USAGER POUR PLUS DE RENSEIGNEMENTS
FRONT AVANT	P235/70R16	240 KPA, 35 PSI	
REAR ARRIERE	P235/70R16	240 KPA, 35 PSI	
SPARE DE SECOURS	T145/90R17	415 KPA, 60 PSI	

E142517

CARGO =



+

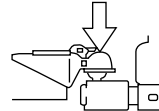

E143817

**Cargo Weight** - includes all weight added to the Base Curb Weight, including cargo and optional equipment. When towing, trailer tongue load or king pin weight is also part of cargo weight.

**GAW (Gross Axle Weight)** - is the total weight placed on each axle (front and rear) including vehicle curb weight and all payload.

**GAWR (Gross Axle Weight Rating)** - is the maximum allowable weight that can be carried by a single axle (front or rear). These numbers are shown on the Safety Compliance Certification Label. The label shall be affixed to either the door hinge pillar, door-latch post, or the door edge that meets the door-latch post, next to the driver seating position. **The total load on each axle must never exceed its Gross Axle Weight Rating.**

# Load Carrying

**Note:** For trailer towing information refer to the *RV and Trailer Towing Guide* available at an authorized dealer.

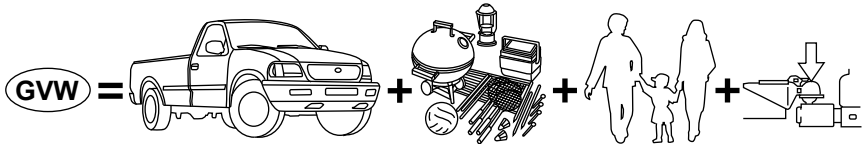

E143818

**GVW (Gross Vehicle Weight)** - is the Vehicle Curb Weight, plus cargo, plus passengers.

**GVWR (Gross Vehicle Weight Rating)** - is the maximum allowable weight of the fully loaded vehicle (including all options, equipment, passengers and cargo). It is shown on the

Safety Compliance Certification Label. The label shall be affixed to either the door hinge pillar, door-latch post, or the door edge that meets the door-latch post, next to the driver seating position. **The Gross Vehicle Weight must never exceed the Gross Vehicle Weight Rating.**

**Example only:**

**MFD. BY FORD MOTOR CO.**

DATE: XX/XX		GVWR: XXXXXLB/ XXXXXKG	
FRONT GAWR: XXXXL		REAR GAWR: XXXXLB	
XXXXKG	WITH	XXXXKG	WITH
XXXX/XXXXXXXX	TIRES	XXXX/XXXXXXXX	TIRES
XXXXXX	RIMS	XXXXXX	RIMS
AT XXX kPa/XX	PSI COLD	AT XXX kPa/XX	PSI COLD

THIS VEHICLE CONFORMS TO ALL APPLICABLE FEDERAL MOTOR VEHICLE SAFETY STANDARDS IN EFFECT ON THE DATE OF MANUFACTURE SHOWN ABOVE.

VIN: XXXXXXXXXXXXXXXXXXXX      XXXXX  
 TYPE: XXX      XXXXX

EXT PNT:	XX	RC:	XX	DSO:	
WB	INT TR	TR/PS	R	AXLE	TR SPR
XXX	XX	X	XX	X XX	XXXXX

XXXXXXXXXXXXXXXX XXXX XXXX-XXXXXX-XX-XX

E142523

# Load Carrying

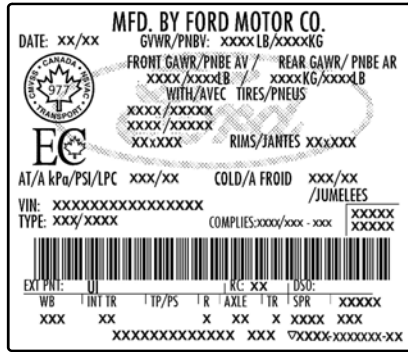

E142524

## WARNING



Exceeding the Safety Compliance Certification Label vehicle weight rating limits could result in substandard vehicle handling or performance, engine, transmission and/or structural damage, serious damage to the vehicle, loss of control and personal injury.

$$\text{GCW} = \text{GVW} +$$

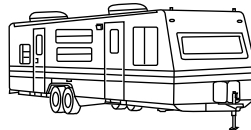

E143819

**GCW (Gross Combined Weight)** - is the Gross Vehicle Weight plus the weight of the fully loaded trailer.

**GCWR (Gross Combined Weight Rating)** - is the maximum allowable weight of the vehicle and the loaded trailer, including all cargo and passengers, that the vehicle can handle without risking damage. (Important: The towing vehicle's braking system is rated

# Load Carrying

---

for operation at Gross Vehicle Weight Rating, not at Gross Combined Weight Rating.) Separate functional brakes should be used for safe control of towed vehicles and for trailers where the Gross Combined Weight of the towing vehicle plus the trailer exceed the Gross Vehicle Weight Rating of the towing vehicle. **The Gross Combined Weight must never exceed the Gross Combined Weight Rating.**

**Maximum Loaded Trailer Weight** - is the highest possible weight of a fully loaded trailer the vehicle can tow. It assumes a vehicle with mandatory options, driver and front passenger weight (150 pounds [68 kilograms] each), no cargo weight (internal or external) and a tongue load of 10–15% (conventional trailer) or king pin weight of 15–25% (fifth wheel trailer). Consult an authorized dealer (or the RV and Trailer Towing Guide available at an authorized dealer) for more detailed information.

**Tongue Load or Fifth Wheel King Pin Weight** - refers to the amount of the weight that a trailer pushes down on a trailer hitch.

**Examples:** For a 5000 pound (2268 kilogram) conventional trailer, multiply 5000 by 0.10 and 0.15 to obtain a proper tongue load range of 500 to 750 pounds (227 to 340 kilograms). For an 11500 pound (5216 kilogram) fifth wheel trailer, multiply by 0.15 and 0.25 to obtain a proper king pin load range of 1725 to 2875 pounds (782 to 1304 kilograms).

## WARNINGS



Do not exceed the GVWR or the GAWR specified on the Safety Compliance Certification Label.



Do not use replacement tires with lower load carrying capacities than the original tires because they may lower the vehicle's GVWR and GAWR limitations. Replacement tires with a higher limit than the original tires do not increase the GVWR and GAWR limitations.



Exceeding any vehicle weight rating limitation could result in serious damage to the vehicle and/or personal injury.

---

## Steps for determining the correct load limit:

1. Locate the statement "The combined weight of occupants and cargo should never exceed XXX kg or XXX lb." on your vehicle's placard.

## Load Carrying

---

2. Determine the combined weight of the driver and passengers that will be riding in your vehicle.
3. Subtract the combined weight of the driver and passengers from XXX kg or XXX lb.
4. The resulting figure equals the available amount of cargo and luggage load capacity. For example, if the “XXX” amount equals 1,400 lb. and there will be five 150 lb. passengers in your vehicle, the amount of available cargo and luggage load capacity is 650 lb.  $(1400 - 750 (5 \times 150) = 650 \text{ lb.})$
5. Determine the combined weight of luggage and cargo being loaded on the vehicle. That weight may not safely exceed the available cargo and luggage load capacity calculated in Step 4.
6. If your vehicle will be towing a trailer, load from your trailer will be transferred to your vehicle. Consult this manual to determine how this reduces the available cargo and luggage load capacity of your vehicle.

The following gives you a few examples on how to calculate the available amount of cargo and luggage load capacity:

\*Suppose your vehicle has a 1400-pound (635-kilogram) cargo and luggage capacity. You decide to go golfing. Is there enough load capacity to carry you, four of your friends and all the golf bags? You and four friends average 220 pounds (99 kilograms) each and the golf bags weigh approximately 30 pounds (13.5 kilograms) each. The calculation would be:  $1400 - (5 \times 220) - (5 \times 30) = 1400 - 1100 - 150 = 150$  pounds. Yes, you have enough load capacity in your vehicle to transport four friends and your golf bags. In metric units, the calculation would be:  $635 \text{ kilograms} - (5 \times 99 \text{ kilograms}) - (5 \times 13.5 \text{ kilograms}) = 635 - 495 - 67.5 = 72.5 \text{ kilograms}$ .

\*Suppose your vehicle has a 1400-pound (635-kilogram) cargo and luggage capacity. You and one of your friends decide to pick up cement from the local home improvement store to finish that patio you have been planning for the past two years. Measuring the inside of the vehicle with the rear seat folded down, you have room for twelve 100-pound (45-kilogram) bags of cement. Do you have enough load capacity to transport the cement to your home? If you and your friend each weigh 220 pounds (99 kilograms), the calculation would be:  $1400 - (2 \times 220) - (12 \times 100) = 1400 - 440 - 1200 = -240$  pounds. No, you do not have enough cargo capacity to carry that much weight. In metric units, the calculation would

# Load Carrying

be: 635 kilograms - (2 x 99 kilograms) - (12 x 45 kilograms) = 635 - 198 - 540 = -103 kilograms. You will need to reduce the load weight by at least 240 pounds (104 kilograms). If you remove three 100-pound (45-kilogram) cement bags, then the load calculation would be: 1400 - (2 x 220) - (9 x 100) = 1400 - 440 - 900 = 60 pounds. Now you have the load capacity to transport the cement and your friend home. In metric units, the calculation would be: 635 kilograms - (2 x 99 kilograms) - (9 x 45 kilograms) = 635 - 198 - 405 = 32 kilograms.

The above calculations also assume that the loads are positioned in your vehicle in a manner that does not overload the Front or the Rear Gross Axle Weight Rating specified for your vehicle on the Safety Compliance Certification Label. The label shall be affixed to either the door hinge pillar, door-latch post, or the door edge that meets the door-latch post, next to the driver seating position.

## Special Loading Instructions for Owners of Pick-up Trucks and Utility-type Vehicles

### WARNING

 Loaded vehicles may handle differently than unloaded vehicles. Extra precautions, such as slower speeds and increased stopping distance, should be taken when driving a heavily loaded vehicle.

Your vehicle can haul more cargo and people than most passenger cars. Depending upon the type and placement of the load, hauling cargo and people may raise the center of gravity of the vehicle.

## TAILGATE

### Tailgate Lock

The tailgate lock can help prevent theft of the tailgate.



E163087

Insert the ignition key into the tailgate lock. Turn it to the right to lock the tailgate. Turn it to the left to unlock the tailgate.

# Load Carrying

## Tailgate Removal

### WARNING



Always properly secure cargo to prevent shifting cargo or cargo falling from vehicle, which could result in compromised vehicle stability and serious personal injury to vehicle occupants or others.

You can remove the tailgate for more loading room.

**Note:** Skip to Step 4 if your vehicle does not have a rearview camera.

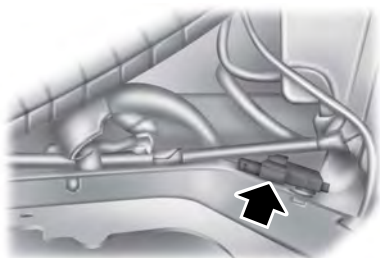

E163090

1. Locate and disconnect the rearview camera in-line connector. It is under the pickup box on the right-hand side of the vehicle near the spare tire.
2. There is a tethered cap on the wire assembly. Install it on the in-line connector that remains under the pickup box.
3. Partially lower the tailgate. Carefully feed the tailgate harness up through the gap between the pickup box and the bumper and place it out of the way under the pickup box.
4. Lower the tailgate.

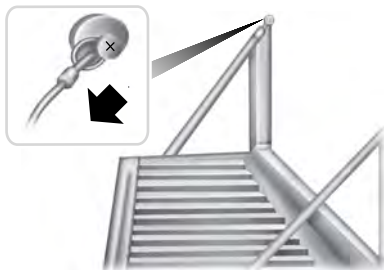

E163092

5. Use a screwdriver to gently pry the spring clip on each connector past the head of the support screw. Disconnect the cable.
6. Disconnect the other cable.
7. Lift the tailgate to a 45-degree angle from horizontal.
8. Lift the right side off its hinge.
9. Lift the tailgate to an 80-degree angle from horizontal.
10. Remove the tailgate from the left side hinge by sliding it to the right.

Reverse the steps to reinstall the tailgate.

### Tailgate Step (If Equipped)

Use the step to make entering the truck bed easier.

To reduce the risk of falling:

- Only operate the step when your vehicle is on a level surface.
- Only operate the step in areas with sufficient lighting.
- Always open the step panel to widen the step.
- Always use the grab handle when climbing on the step.
- Do not use the step with bare feet.
- Make sure the step is clean before use.
- Keep the step load, you plus the load, below 350 pounds (159 kilograms).

# Load Carrying

## Opening the Step

**Note:** Make sure to close and fully latch the step before moving your vehicle. Never drive with the step or grab handle open.

1. Lower the tailgate.
2. Pull the yellow lever on the grab handle to the unlock position.



E163093

3. Raise the handle upright until you feel it latch and see the lever in the lock position. You only need to use the lever when releasing the grab handle.



E163094

4. Rotate the center molding to unlatch the step. Pull it toward you to extend it.
5. Open the step panel to widen the step.

**Note:** Do not tow with the step or grab handle.

Replace the slip resistance tape or grab handle molding if it appears worn or damaged.

## Closing the Step

1. Close the step panel then lift and fully close the step into the tailgate.
2. Move the yellow lever on the grab handle to the unlock position and lower the handle.

## Bed Extender (If Equipped)

**Note:** Do not use the bed extender when driving off road.

**Note:** Make sure to engage the locking pins and knobs fully before driving your vehicle.

**Note:** Make sure to secure all cargo.

**Note:** Do not exceed 150 pounds (68 kilograms) on the tailgate when your vehicle is moving.

**Note:** Do not keep the bed extender in the tailgate mode when you are not using it for restraining cargo. Always keep the bed extender in the grocery mode or the stowed position with the tailgate closed.

## Tailgate Mode



E163095

1. Pull the locking pin toward the center of your vehicle.



# Load Carrying



E163096

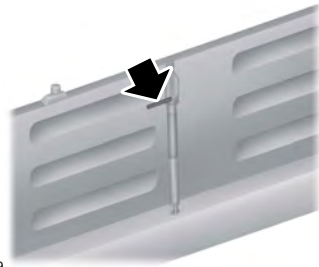

E163099

2. Open the latches to release the panels.

5. Make sure to insert the latch rod into the tailgate hole. Make sure to engage both sides of the locking pins into their holes in the pick-up box.

Reverse the steps to store the bed extender.

## Grocery Mode



E163097

3. Rotate the panels toward the tailgate. Repeat Steps 1-3 on the other side of your vehicle.



E163100

Follow Steps 1-4 of the tailgate mode instructions by rotating the panels away from the tailgate. Close the tailgate.



E163098

4. Connect the two panels. Rotate both knobs one-quarter turn clockwise to secure the panels.

# Towing

---

## TOWING A TRAILER

### WARNINGS



Do not exceed the GVWR or the GAWR specified on the certification label.



Towing trailers beyond the maximum recommended gross trailer weight exceeds the limit of the vehicle and could result in engine damage, transmission damage, structural damage, loss of vehicle control, vehicle rollover and personal injury.

---

Your vehicle may have electrical items, such as fuses or relays, related to towing. See the **Fuses** chapter.

Your vehicle's load capacity designation is by weight, not by volume, so you cannot necessarily use all available space when loading a vehicle.

Towing a trailer places an extra load on your vehicle's engine, transmission, axle, brakes, tires and suspension. Inspect these components periodically during, and after, any towing operation.

## Load Placement

To help minimize how trailer movement affects your vehicle when driving:

- Load the heaviest items closest to the trailer floor.
- Load the heaviest items centered between the left and right side trailer tires.
- Load the heaviest items above the trailer axles or just slightly forward toward the trailer tongue. Do not allow the final trailer tongue weight to go above or below 10-15% of the loaded trailer weight.
- Select a tow bar with the correct rise or drop. When both the loaded vehicle and trailer are connected, the trailer frame should be level, or slightly angled down toward your vehicle, when viewed from the side.

When driving with a trailer or payload, a slight takeoff vibration or shudder may be present due to the increased payload weight. Additional information regarding proper trailer loading and setting your vehicle up for towing is located in another chapter of this manual. See **Load Limit** (page 180).

You can also find information in the **RV & Trailer Towing Guide** available at your authorized dealer, or online.

# Towing

## RV & Trailer Towing Guide Online

Website | <http://www.fleet.ford.com/towing-guides/>

### TRAILER SWAY CONTROL (if Equipped)

#### WARNING



Turning off trailer sway control increases the risk of loss of vehicle control, serious injury or death. Ford does not recommend disabling this feature except in situations where speed reduction may be detrimental (such as hill climbing), the driver has significant trailer towing experience, and can control trailer sway and maintain safe operation.

**Note:** This feature does not prevent trailer sway, but reduces it once it begins.

**Note:** This feature cannot stop all trailers from swaying.

**Note:** In some cases, if vehicle speed is too high, the system may activate multiple times, gradually reducing vehicle speed.

This feature applies your vehicle brakes at individual wheels and, if necessary, reduces engine power. If the trailer begins to sway, the stability control light flashes and the message **TRAILER SWAY REDUCE SPEED** appears in the information display. The first thing to do is slow your vehicle down, then pull safely to the side of the road and check for proper tongue load and trailer load distribution. See **Load Carrying** (page 180).

### RECOMMENDED TOWING WEIGHTS

**Note:** Do not exceed a trailer weight of 5000 pounds (2268 kilograms) when towing with, or by, bumper only.

**Note:** Make sure to take into consideration trailer frontal area. Do not exceed 60 feet<sup>2</sup> (5.6 meters<sup>2</sup>) trailer frontal area.

**Note:** Exceeding this limitation may significantly reduce the performance of your towing vehicle. Selecting a trailer with a low aerodynamic drag and rounded front design helps optimize performance and fuel economy.

**Note:** For high altitude operation, reduce the gross combined weight by 2% per 1000 feet (300 meters) starting at the 1000 foot (300 meter) elevation point.

**Note:** Certain states require electric trailer brakes for trailers over a specified weight. Be sure to check state regulations for this specified weight. The maximum trailer weights listed may be limited to this specified weight, as your vehicle's electrical system may not include the wiring connector needed to use electric trailer brakes.

## Towing

Your vehicle may tow a trailer provided the maximum trailer weight is less than or equal to the

maximum trailer weight listed for your vehicle configuration on the following chart.

<b>Pickup and box delete</b>			
<b>Vehicle</b>	<b>Engine</b>	<b>Rear axle ratio</b>	<b>Maximum GCWR</b>
F-250	6.2L gas	3.73	19000 lb (8618 kg)
		4.30	22000 lb (9979 kg)
	6.7L diesel	3.31, 3.55	23500 lb (10659 kg)
F-350 single rear wheel	6.2L gas	3.73	19000 lb (8618 kg)
		4.30	22000 lb (9979 kg)
	6.7L diesel	3.31, 3.55	23500 lb (10659 kg)
F-350 dual rear wheel	6.2L gas	3.73	19500 lb (8845 kg)
		4.30	22500 lb (10206 kg)
	6.7L diesel	3.73	31900 lb (14470 kg)
		4.30	35000 lb (15875 kg)*
F-450	6.7L diesel	4.30	40400 lb (18325 kg)

\* Requires optional GCWR Package.

# Towing

<b>Chassis cab</b>			
<b>Vehicle</b>	<b>Engine</b>	<b>Rear axle ratio</b>	<b>Maximum GCWR</b>
F-350 single rear wheel	6.2L gas	3.73	19000 lb (8618 kg)
		4.30	22000 lb (9979 kg)
	6.7L diesel	3.73	23500 lb (10659 kg)
F-350 dual rear wheel	6.2L gas	3.73	19500 lb (8845 kg)
		4.30	22500 lb (10206 kg)
	6.7L diesel	3.73, 4.10	24500 lb (11113 kg)
F-450	6.8L gas	4.88	26000 lb (11793 kg)
	6.7L diesel	4.10	26000 lb (11793 kg)
		4.30	30000 lb (13608 kg)*
F-550 (17500/18000 lb GVWR)	6.8L gas	4.88	26000 lb (11793 kg)
	6.7L diesel	4.10	26000 lb (11793 kg)
		4.30	35000 lb (15875 kg)*
F-550 (19000/19500 lb GVWR)	6.8L gas	4.88	26000 lb (11793 kg)

# Towing

Chassis cab			
Vehicle	Engine	Rear axle ratio	Maximum GCWR
	6.7L diesel	4.88	26000 lb (11793 kg)
			35000 lb (15875 kg)*

\* Requires optional GCWR Package.

## Calculating the Maximum Loaded Trailer Weight for Your Vehicle

1. Start with the gross combined weight rating for your vehicle model and axle ratio. See the previous chart.
2. Subtract all of the following that apply to your vehicle:
  - Vehicle curb weight
  - Hitch hardware weight, such as a draw bar, ball, locks or weight distributing hardware
  - Driver weight
  - Passenger(s) weight
  - Payload, cargo and luggage weight
  - Aftermarket equipment weight.

This equals the maximum loaded trailer weight for this combination.

**Note:** *The trailer tongue load is considered part of the payload for your vehicle. Reduce the total payload by the final trailer tongue weight.*

**Note:** *Consult an authorized dealer to determine the maximum trailer weight allowed for your vehicle if you are not sure.*

## ESSENTIAL TOWING CHECKS

Follow these guidelines for safe towing:

- Do not tow a trailer until you drive your vehicle at least 1000 miles (1600 kilometers).
- Consult your local motor vehicle laws for towing a trailer.
- See the instructions included with towing accessories for the proper installation and adjustment specifications.
- Service your vehicle more frequently if you tow a trailer. See your scheduled maintenance information.
- If you use a rental trailer, follow the instructions the rental agency gives you.

See **Load limits** in the Load Carrying chapter for load specification terms found on the tire label and Safety Compliance label and instructions on calculating your vehicle's load.

# Towing

Remember to account for the trailer tongue weight as part of your vehicle load when calculating the total vehicle weight.

## Trailer Towing Connector



E163167

When attaching the trailer wiring connector to your vehicle, only use a proper fitting connector that works with the vehicle and trailer functions. Some seven-position connectors may have the SAE J2863 logo, which confirms that it is the proper wiring connector and works correctly with your vehicle.

Color	Function
Yellow	Left turn signal and stop lamp
White	Ground (-)
Blue	Electric brakes
Green	Right turn signal and stop lamp
Orange	Battery (+)
Brown	Running lights
Grey	Reverse lights

## Using the Rear View Camera To Align Your Trailer Hitch

Use the centerline (E) guideline to assist you in setting your steering wheel properly to help align the trailer hitch and tongue. The fixed guidelines are always shown in the display.

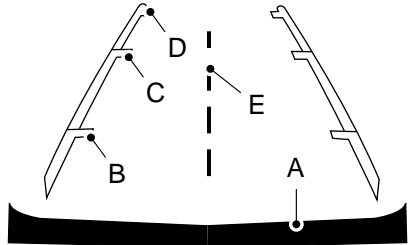

E163914

- A Rear bumper
- B Fixed guideline: Red zone
- C Fixed guideline: Yellow zone
- D Fixed guideline: Green zone
- E Centerline

Always use caution while reversing. Objects in the red zone are closest to your vehicle and objects in the green zone are farther away. Objects are getting closer to your vehicle as they move from the green zone to the yellow or red zones. Use the side view mirrors and rear view mirror to get better coverage on both sides and rear of your vehicle.

Refer to the Rear View Camera section for additional information. See **Rear View Camera** (page 175).

# Towing

## Hitches

### WARNING



On pick-up trucks, the trailer hitch provided on this vehicle enhances crash protection for the fuel system.

Do not remove!

Do not use a hitch that either clamps onto the bumper or attaches to the axle. You must distribute the load in your trailer so that 10-15% for conventional towing or 15-25% for fifth wheel towing of the total weight of the trailer is on the tongue.

## Weight-distributing Hitches

### WARNING



Do not adjust a weight-distributing hitch to any position where the rear bumper of the vehicle is higher than it was before attaching the trailer. Doing so will defeat the function of the weight-distributing hitch, which may cause unpredictable handling, and could result in serious personal injury.

When hooking-up a trailer using a weight-distributing hitch, always use the following procedure:

1. Park the loaded vehicle, without the trailer, on a level surface.
2. Measure the height to the top of your vehicle's front wheel opening on the fender. This is H1.
3. Attach the loaded trailer to your vehicle without the weight-distributing bars connected.
4. Measure the height to the top of your vehicle's front wheel opening on the fender a second time. This is H2.

5. Install and adjust the tension in the weight-distributing bars so that the height of your vehicle's front wheel opening on the fender is approximately halfway between H1 and H2.
6. Check that the trailer is level or slightly nose down toward your vehicle. If not, adjust the ball height accordingly and repeat Steps 2-6.

Once the trailer is level or slightly nose down toward the vehicle:

- Lock the bar tension adjuster in place.
- Check that the trailer tongue securely attaches and locks onto the hitch.
- Install safety chains, lighting, and trailer brake controls as required by law or the trailer manufacturer.

## Fifth-wheel Trailer Hitch (If Equipped)

### WARNINGS



The mounting pads in the bed are specifically designed for certain fifth-wheel trailer hitches and gooseneck ball hitches. Do not use these mounting pads for other purposes. Doing so could result in vehicle structural damage, loss of vehicle control, and personal injury. Contact an authorized dealer to purchase gooseneck and fifth-wheel hitches that are compatible with your vehicle.



Towing trailers beyond the maximum limit of the towing system could result in vehicle structural damage, loss of vehicle control and personal injury.



The hitch rating listed on the trailer hitch label is the maximum possible trailer rating. To find the maximum trailer weight allowed for your specific vehicle, consult an authorized dealer or the RV & Trailer Towing Guide provided by an authorized dealer.



# Towing

Your vehicle may be equipped with a fifth-wheel prep package. This package enables your vehicle to accept certain fifth-wheel trailer hitches and gooseneck ball hitches. The fifth-wheel trailer hitch attaches to the four mounting pads in the pick-up bed. An optional 7-pin trailer wiring connector may be in the bed as well. The gooseneck ball hitch is a separate mounting pad from the fifth-wheel hitch, located in the center of the bed.

Shorter pick-up boxes, such as the 6½-foot box on the F-250 and F-350, provide less clearance between the cab and the fifth-wheel and gooseneck trailer compared to longer box pick-ups, such as an 8-foot box on the F-250 or F-350. When selecting a trailer and tow vehicle, it is critical to check that this combination provides clearance between the front of the trailer and tow vehicle for turns up to 90 degrees. Failure to follow this recommendation could result in the trailer contacting the cab of the tow vehicle during tight turns that are typical during low-speed parking and turning maneuvers. This contact could result in damage to the trailer and tow vehicle.

## Safety Chains

**Note:** *Do not attach safety chains to the bumper.*

Always connect the safety chains to the frame or hook retainers of your vehicle hitch.

To connect the safety chains, cross the chains under the trailer tongue and allow enough slack for turning tight corners. Do not allow the chains to drag on the ground.

## Trailer Brakes

### WARNING



Do not connect a trailer's hydraulic brake system directly to your vehicle's brake system. Your vehicle may not have enough braking power and your chances of having a collision greatly increase.

Electric brakes and manual, automatic or surge-type trailer brakes are safe if you install them properly and adjust them to the manufacturer's specifications. The trailer brakes must meet local and federal regulations.

**The rating for the tow vehicle's braking system operation is at the gross vehicle weight rating, not the gross combined weight rating.**

**Separate functioning brake systems are required for safe control of towed vehicles and trailers weighing more than 1500 pounds (680 kilograms) when loaded.**

## Integrated Trailer Brake Controller

(If Equipped)

### WARNING



The Ford trailer brake controller has been verified to be compatible with trailers having electric-actuated drum brakes (one to four axles) and some electric-over-hydraulic brakes. It will not activate hydraulic surge-style trailer brakes. It is the responsibility of the customer to ensure that the trailer brakes are adjusted appropriately, functioning normally and all electric connections are properly made. Failure to do so may result in loss of vehicle control, crash or serious injury.

# Towing

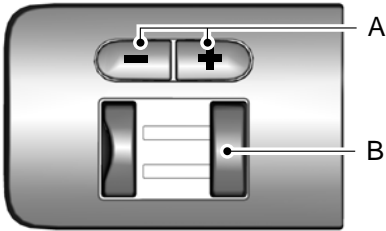

E163166

When used properly, the trailer brake controller assists in smooth and effective trailer braking by powering the trailer's electric or electric-over-hydraulic brakes with a proportional output based on the towing vehicle's brake pressure.

You can adjust the amount of initial trailer brake output by selecting one of three settings through the message center.

Ford has tested the trailer brake controller to be compatible with several major brands of electric-over-hydraulic trailer brakes. Contact an authorized dealer for information on which brands you can use.

The controller user interface consists of the following:

**A:** + and - (Gain adjustment buttons): Pressing these buttons adjusts the controller's power output to the trailer brakes in 0.5 increments. You can increase the gain setting to 10.0 (maximum trailer braking) or decrease it to 0 (no trailer braking). Pressing and holding a button raises or lowers the setting continuously. The gain setting displays in the message center as follows: **TBC GAIN = XX.X.**

**B:** Manual control lever: Slide the control lever to the left to switch on the trailer's electric brakes independent of the tow vehicle's. See the following **Procedure for adjusting gain** section for instructions on proper use of this feature. If you use the manual control while the brake is also applied, the greater of the two inputs determines the power sent to the trailer brakes.

- **Stop lamps:** Using the manual control lever lights both the trailer brake lamps and your vehicle brake lamps except the center high-mount stop lamp, if you make the proper electrical connection to the trailer. Pressing your vehicle brake pedal also lights both trailer and vehicle brake lamps.

The controller shows gain setting, output bar graph, and trailer connectivity status in the information display. They appear in the information display as follows:

- **TBC GAIN = XX.X NO TRAILER:** Shows the current gain setting during a given ignition cycle and when adjusting the gain. This also displays if you use the manual control lever or make gain adjustments with no trailer connected.
- **TBC GAIN = XX.X OUTPUT= // //** //: Displays when you push your vehicle's brake pedal, or upon use of the manual control. Bar indicators light in the information display to indicate the amount of power going to the trailer brakes relative to the brake pedal or manual control input. One bar indicates the least amount of output; six bars indicate maximum output.

# Towing

---

- **TRAILER CONNECTED:** Displays when the system senses a correct trailer wiring connection during a given ignition cycle.
  - **TRAILER DISCONNECTED:** Displays, accompanied by a single audible time, when the system senses a trailer connection and then a disconnection, either intentional or unintentional, during a given ignition cycle. It also displays if a truck or trailer-wiring fault occurs causing the trailer to appear disconnected. This message can also display if you use the manual control lever without a trailer connected.
4. Use the gain adjustment (+ and -) buttons to increase or decrease the gain setting to the desired starting point. A gain setting of 6.0 is a good starting point for heavier loads.
  5. In a traffic-free environment, tow the trailer on a dry, level surface at a speed of 20-25 mph (30-40 km/h) and squeeze the manual control lever completely.
  6. If the trailer wheels lock up, indicated by squealing tires, reduce the gain setting. If the trailer wheels turn freely, increase the gain setting. Repeat Steps 5 and 6 until the gain setting is at a point just below trailer wheel lock-up. If towing a heavier trailer, trailer wheel lock-up may not be attainable even with the maximum gain setting of 10.

## Procedure for Adjusting Gain

**Note:** Only perform this procedure in a traffic-free environment at speeds of approximately 20-25 mph (30-40 km/h).

The gain setting sets the trailer brake controller for the specific towing condition. You should change the setting as towing conditions change. Changes to towing conditions include trailer load, vehicle load, road conditions and weather.

The gain should be set to provide the maximum trailer braking assistance while making sure the trailer wheels do not lock when using the brakes. Locked trailer wheels may lead to trailer instability.

1. Make sure the trailer brakes are in good working condition, functioning normally and properly adjusted. See your trailer dealer if necessary.
2. Hook up the trailer and make the electrical connections according to the trailer manufacturer's instructions.
3. When you plug in a trailer with electric or electric-over-hydraulic brakes, **TRAILER CONNECTED** appears in the information display.

## Initial Output Setting

The trailer brake controller lets you customize how aggressively the trailer brakes engage. The default value is set to "Light". We recommend this setting for the majority of trailers. If you are using an EOH trailer with a high setting voltage, or if you prefer to feel more brake feedback from the trailer, then select "Medium" or "Heavy".

## Trailer Brake Effort Setting

The trailer brake controller allows the user to customize how aggressively the trailer brakes engage. The default value is "Low" and is the recommended setting for most trailers. If your trailer's brakes require more initial voltage, or if you prefer more aggressive trailer braking, then select either the "Medium" or the "High" setting.

# Towing

---

## Information Display Warning Messages

**Note:** *An authorized dealer can diagnose the trailer brake controller to determine exactly which trailer fault has occurred. However, your Ford warranty does not cover this diagnosis if the fault is with the trailer.*

### **TRAILER BRAKE MODULE FAULT**

Displays in response to faults sensed by the trailer brake controller, accompanied by a single tone. If this message appears, contact an authorized dealer as soon as possible for diagnosis and repair. The controller may still function, but with degraded performance.

### **WIRING FAULT ON TRAILER**

Displays when there is a short circuit on the electric brake output wire.

If this message displays, accompanied by a single tone, with no trailer connected, the problem is with your vehicle wiring between the trailer brake controller and the 7-pin connector at the bumper.

If the message only displays with a trailer connected, the problem is with the trailer wiring. Consult your trailer dealer for assistance. This can be a short to ground (such as a chaffed wire), short to voltage (such as a pulled pin on trailer emergency breakaway battery) or the trailer brakes may be drawing too much current.

### **Points to Remember**

**Note:** *Do not attempt removal of the trailer brake controller without consulting the Workshop Manual. Damage to the unit may result.*

- Adjust gain setting before using the trailer brake controller for the first time.
- Adjust gain setting, using the procedure above, whenever road, weather and trailer or vehicle loading conditions change from when the gain was initially set.
- Only use the manual control lever for proper adjustment of the gain during trailer setup. Misuse, such as application during trailer sway, could cause instability of trailer or tow vehicle.
- Avoid towing in adverse weather conditions. The trailer brake controller does not provide anti-lock control of the trailer wheels. Trailer wheels can lock up on slippery surfaces, resulting in reduced stability of trailer and tow vehicle.
- The trailer brake controller is equipped with a feature that reduces output at vehicle speeds below 11 mph (18 km/h) so trailer and vehicle braking is not jerky or harsh. This feature is only available when applying the brakes using your vehicle's brake pedal, not the controller.
- The controller interacts with the brake control system and powertrain control system of your vehicle to provide the best performance on different road conditions.
- Your vehicle's brake system and the trailer brake system work independently of each other. Changing the gain setting on the controller does not affect the operation of your vehicle's brakes whether you attach a trailer or not.

# Towing

---

- When you switch the engine off, the controller output is disabled and the display and module shut down. The controller module and display turn on when you switch the ignition on.
- The trailer brake controller is only a factory-installed or dealer-installed item. Ford is not responsible for warranty or performance of the controller due to misuse or customer installation.

## Trailer Lamps

### WARNING



Never connect any trailer lamp wiring to the vehicle's tail lamp wiring; this may damage the electrical system resulting in fire. Contact your authorized dealer as soon as possible for assistance in proper trailer tow wiring installation. Additional electrical equipment may be required.

Trailer lamps are required on most towed vehicles. Make sure all running lights, brake lights, turn signals and hazard lights are working.

## Using a Step Bumper (If Equipped)

The rear bumper is equipped with an integral hitch and only requires a ball with a one-inch (25.4 millimeter) shank diameter. The bumper has a 5000-pound (2268 kilogram) trailer weight and a 500-pound (227 kilogram) tongue weight capacity

If it is necessary to relocate the hitch ball position, you must install a frame-mounted trailer hitch.

## Before Towing a Trailer

Practice turning, stopping and backing up to get the feel of your vehicle-trailer combination before starting on a trip. When turning, make wider turns so the trailer wheels clear curbs and other obstacles.

## When Towing a Trailer

- Do not drive faster than 70 mph (113 km/h) during the first 500 miles (800 kilometers).
- Do not make full-throttle starts.
- Check your hitch, electrical connections and trailer wheel lug nuts thoroughly after you have traveled 50 miles (80 kilometers).
- When stopped in congested or heavy traffic during hot weather, place the gearshift in position **P** to aid engine and transmission cooling and to help A/C performance.
- Turn off the speed control with heavy loads or in hilly terrain. The speed control may turn off automatically when you are towing on long, steep grades.
- Shift to a lower gear when driving down a long or steep hill. Do not apply the brakes continuously, as they may overheat and become less effective.
- If your transmission is equipped with a Grade Assist or Tow/Haul feature, use this feature when towing. This provides engine braking and helps eliminate excessive transmission shifting for optimum fuel economy and transmission cooling.

# Towing

- If your vehicle is equipped with AdvanceTrac with RSC, this system may turn on during typical cornering maneuvers with a heavily loaded trailer. This is normal. Turning the corner at a slower speed while towing may reduce this tendency.
- If you are towing a trailer frequently in hot weather, hilly conditions, at the gross combined weight rating (or any combination of these factors), consider refilling your rear axle with synthetic gear lubricant (if the axle is not already filled with it). See **Capacities and Specifications** (page 301).
- Allow more distance for stopping with a trailer attached. Anticipate stops and brake gradually.
- Avoid parking on a grade. However, if you must park on a grade:
  1. Turn the steering wheel to point your vehicle tires away from traffic flow.
  2. Set your vehicle parking brake.
  3. Place the automatic transmission in position **P**.
  4. Place wheel chocks in front and back of the trailer wheels. (Chocks not included with vehicle.)

Your vehicle may be equipped with a temporary or conventional spare tire. A "temporary" spare tire is different in size (diameter or width), tread-type (All-Season or All Terrain) or is from a different manufacturer than the road tires on your vehicle. Consult information on the tire label or Safety Compliance label for limitations when using.

## Launching or Retrieving a Boat or Personal Watercraft (PWC)

**Note:** Disconnect the wiring to the trailer **before** backing the trailer into the water.

**Note:** Reconnect the wiring to the trailer **after** you remove the trailer from the water.

When backing down a ramp during boat launching or retrieval:

- Do not allow the static water level to rise above the bottom edge of the rear bumper.
- Do not allow waves to break higher than 6 inches (15 centimeters) above the bottom edge of the rear bumper.

Exceeding these limits may allow water to enter vehicle components:

- Causing internal damage to the components.
- Affecting driveability, emissions, and reliability.

Replace the rear axle lubricant anytime the rear axle has been submerged in water. Water may have contaminated the rear axle lubricant, which is not normally checked or changed unless a leak is suspected or other axle repair is required.

## TOWING POINTS

### WARNINGS



Using recovery hooks is dangerous and should only be done by a person familiar with proper vehicle recovery safety practices. Improper use of recovery hooks may cause hook failure or separation from the vehicle and could result in serious injury or death.



Always slowly remove the slack from the recovery strap prior to pulling. Failure to do so can introduce significantly higher loads which can cause the recovery hooks to break off, or the recovery strap to fail which can cause serious injury or death.



Never link two straps together with a clevis pin. These heavy metal objects could become projectiles if the strap breaks and can cause serious injury or death.

# Towing

Your vehicle comes equipped with frame-mounted front recovery hooks. These hooks should never have a load applied to them greater than the gross vehicle weight rating of your vehicle.

Before using recovery hooks:

- Make sure all attaching points are secure and capable of withstanding the applied load.
- Never use chains, cables or tow straps with metal hook ends.
- Only use recovery straps that have a minimum breaking strength two to three times the gross vehicle weight of the stuck vehicle.
- Make sure the recovery strap is in good condition and free of visible cuts, tears or damage.
- Use a damper device such as a tarp, heavy blanket or piece of carpet draped over the recovery strap to help absorb the energy in the event the strap breaks.
- Make sure the stuck vehicle is not loaded heavier than its gross vehicle weight rating specified on the certification label.
- Always align the tow vehicle and stuck vehicle in a straight line (within 10 degrees).
- Keep bystanders to the **sides** of the vehicle, at a distance of at least twice the length of the recovery strap. This helps avoid injury from the hazard of a recovery hook or strap breaking, or a vehicle lurching into their path.

## TRANSPORTING THE VEHICLE

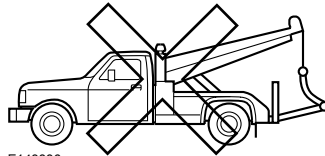
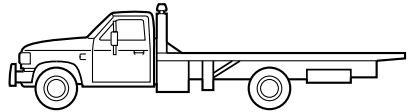
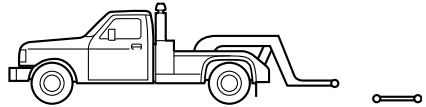

E143886

If you need to have your vehicle towed, contact a professional towing service or, if you are a member of a roadside assistance program, your roadside assistance service provider.

We recommend the use of a wheel lift and dollies or flatbed equipment to tow your vehicle. Do not tow with a slingbelt. Ford Motor Company has not approved a slingbelt towing procedure. Vehicle damage may occur if towed incorrectly, or by any other means.

Ford Motor Company produces a towing manual for all authorized tow truck operators. Have your tow truck operator refer to this manual for proper hook-up and towing procedures for your vehicle.

# Towing

It is acceptable to have your two-wheel drive vehicle towed with the front wheels on the ground (without dollies) and the rear wheels off the ground.

We recommend towing a four-wheel drive vehicle with all wheels off the ground, such as using a wheel lift and dollies or flatbed equipment. However, it is acceptable to use a wheel lift to raise the rear of your vehicle so long as, depending on vehicle configuration, you perform the following before towing:

- If your vehicle is equipped with a manual-shift transfer case, make sure the front wheel hub locks are in the **FREE** position before towing.
- If your vehicle is equipped with an electronic shift-on-the-fly transfer case, make sure you turn the four-wheel drive control to the **2H** position before towing.

**Note:** *Towing an electronic shift-on-the-fly four-wheel drive vehicle with the front wheels on the ground without disengaging the front hubs may cause damage to the automatic transmission.*

**Note:** *Towing a two-wheel drive vehicle or an electronic shift-on-the-fly four-wheel drive vehicle with the rear wheels on the ground for more than 50 miles (80 km) or faster than 35 mph (56 km/h) may cause damage to the automatic transmission.*

**Note:** *Using wheel lift equipment to tow a dual rear wheel vehicle requires removing an outer rear wheel before towing.*

## TOWING THE VEHICLE ON FOUR WHEELS

### Emergency Towing

If your vehicle becomes inoperable (without access to wheel dollies, car-hauling trailer, or flatbed transport vehicle), it can be flat-towed (all wheels on the ground, regardless of the powertrain and transmission configuration) under the following conditions:

- Your vehicle is facing forward for towing in a forward direction.
- Place the transmission in position **N**. If you cannot move the transmission into **N**, you may need to override it. See **Transmission** (page 147).
- Maximum speed is 35 mph (56 km/h).
- Maximum distance is 50 miles (80 kilometers).

### Recreational Towing

**Note:** *Put your climate control system in recirculated air mode to prevent exhaust fumes from entering your vehicle. See **Climate Control** (page 106).*

Follow these guidelines if you have a need for recreational towing, such as towing your vehicle behind a motorhome. We designed these guidelines to prevent damage to your transmission.

### Two-wheel Drive Vehicles and Four-wheel Drive Vehicles Equipped with an Electronic-shift Transfer Case

Do not tow your vehicle with any wheels on the ground, as vehicle or transmission damage may occur. It is recommended to tow your vehicle with all four (4) wheels off the ground, such as when using a car-hauling trailer. Otherwise, you cannot tow your vehicle.



# Towing

---

## **Four-wheel Drive Vehicles Equipped with a Manual-shift Transfer Case**

1. Put the transmission in position **N**.
2. Put the transfer case in position **N**.
3. Put the hub locks in the **FREE** position. Always make sure that both hub locks are set to the same position.

# Driving Hints

---

## BREAKING-IN

You need to break in new tires for approximately 300 miles (480 kilometers). During this time, your vehicle may exhibit some unusual driving characteristics.

Avoid driving too fast during the first 1000 miles (1600 kilometers). Vary your speed frequently and change up through the gears early. Do not labor the engine.

Do not tow during the first 1000 miles (1600 kilometers).

## ECONOMICAL DRIVING

Your fuel economy is affected by several things, such as how you drive, the conditions you drive under, and how you maintain your vehicle.

You may improve your fuel economy by keeping these things in mind:

- Accelerate and slow down in a smooth, moderate fashion.
- Drive at steady speeds without stopping.
- Anticipate stops; slowing down may eliminate the need to stop.
- Combine errands and minimize stop-and-go driving.
- Close the windows for high-speed driving.
- Drive at reasonable speeds (traveling at 55 mph [88 km/h] uses 15% less fuel than traveling at 65 mph [105 km/h]).
- Keep the tires properly inflated and use only the recommended size.
- Use the recommended engine oil.
- Perform all regularly scheduled maintenance.

Avoid these actions; they reduce your fuel economy:

- Sudden accelerations or hard accelerations.
- Revving the engine before turning it off.
- Idle for periods longer than one minute.
- Warm up your vehicle on cold mornings.
- Use the air conditioner or front defroster.
- Use the speed control in hilly terrain.
- Rest your foot on the brake pedal while driving.
- Drive a heavily loaded vehicle or tow a trailer.
- Carry unnecessary weight (approximately 1 mpg [0.4 km/L] is lost for every 400 lb [180 kilogram] of weight carried).
- Driving with the wheels out of alignment.

### Conditions

- Heavily loading a vehicle or towing a trailer may reduce fuel economy at any speed.
- Adding certain accessories to your vehicle (for example bug deflectors, rollbars, light bars, running boards, ski racks or luggage racks) may reduce fuel economy.
- To maximize the fuel economy, drive with the tonneau cover installed (if equipped).
- Using fuel blended with alcohol may lower fuel economy.
- Fuel economy may decrease with lower temperatures during the first 8–10 miles (12–16 kilometers) of driving.
- Driving on flat terrain offers improved fuel economy as compared to driving on hilly terrain.

# Driving Hints

- Transmissions give their best fuel economy when operated in the top cruise gear and with steady pressure on the gas pedal.
- Four-wheel-drive operation (if equipped) is less fuel efficient than two-wheel-drive operation.
- Close the windows for high-speed driving.

## DRIVING THROUGH WATER

### WARNING



Do not drive through flowing or deep water as you may lose control of your vehicle.

**Note:** *Driving through standing water can cause vehicle damage.*

**Note:** *Engine damage can occur if water enters the air filter.*

Before driving through standing water, check the depth. Never drive through water that is higher than the bottom of the wheel hubs.

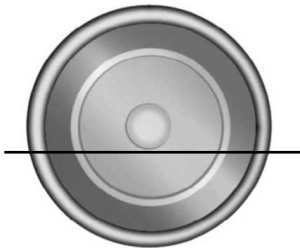

E176913

When driving through standing water, drive very slowly and do not stop your vehicle. Your brake performance and traction may be limited. After driving through water and as soon as it is safe to do so:

- Lightly press the brake pedal to dry the brakes and to check that they work.
- Check that the horn works.
- Check that the exterior lights work.
- Turn the steering wheel to check that the steering power assist works.

## FLOOR MATS

### WARNINGS



Always use floor mats that are designed to fit the foot well of your vehicle. Only use floor mats that leave the pedal area unobstructed. Only use floor mats that are firmly secured to retention posts so that they cannot slip out of position and interfere with the pedals or impair safe operation of your vehicle in other ways.



Pedals that cannot move freely can cause loss of vehicle control and increase the risk of serious personal injury.



Always make sure that the floor mats are properly attached to the retention posts in the carpet that are supplied with your vehicle. Floor mats must be properly secured to both retention posts to make sure mats do not shift out of position.



Never place floor mats or any other covering in the vehicle foot well that cannot be properly secured to prevent them from moving and interfering with the pedals or the ability to control the vehicle.





Never place floor mats or any other covering on top of already installed floor mats. Floor mats should always rest on top of vehicle carpeting surface and not another floor mat or other covering. Additional floor mats or any other covering will reduce the pedal clearance and potentially interfere with pedal operation.

# Driving Hints

## WARNINGS

 Check attachment of floor mats on a regular basis. Always properly reinstall and secure floor mats that have been removed for cleaning or replacement.

 Always make sure that objects cannot fall into the driver foot well while the vehicle is moving. Objects that are loose can become trapped under the pedals causing a loss of vehicle control.

 Failure to properly follow floor mat installation or attachment instructions can potentially cause interference with pedal operation causing a loss of vehicle control.



E142666

To install floor mats, position the floor mat so that the eyelet is over the retention post and press down to lock in.

To remove the floor mat, reverse the installation procedure.

## SNOWPLOWING

Ford recommends that the Super Duty F-Series used for snow removal include the snowplow package option.

## Installing the Snowplow

Weight limits and guidelines for selecting and installing the snowplow are in the Ford Truck Body Builders Layout Book, snowplow section, found at [www.fleet.ford.com/truckbbas](http://www.fleet.ford.com/truckbbas). A typical installation affects the following:

- Certification to government safety laws such as occupant protection and airbag deployment, braking, and lighting. Look for an Alterer's Label on the vehicle from the snowplow installer certifying that the installation meets all applicable Federal Motor Vehicle Safety Standards (FMVSS).
- The Total Accessory Reserve Capacity (TARC) is on the lower right side of the vehicle's Safety Compliance Certification Label. This applies to Ford-completed vehicles of 10,000 pounds (4,536 kilograms) GVWR or less. This is the weight of permanently-attached auxiliary equipment, such as snowplow frame-mounting hardware, that can be added to the vehicle and satisfy Ford compliance certification to FMVSS. Exceeding this weight may require the auxiliary equipment installer additional safety certification responsibility. The Front Accessory Reserve Capacity (FARC) is for customer convenience.
- Rear ballast weight behind the rear axle may be required to prevent exceeding the FGAWR, and provide front-to-rear weight balance for proper braking and steering.
- Front wheel toe may require re-adjustment to prevent premature uneven tire wear. Specifications are in the Ford Workshop Manual.
- Headlight aim may require re-adjustment.

# Driving Hints

- The tire air pressures recommended for general driving are on the vehicle's Safety Certification Label. The maximum cold inflation pressure for the tire and associated load rating is on the tire sidewall. Tire air pressure may require re-adjustment within these pressure limits to accommodate the additional weight of the snowplow installation.
- Federal and some local regulations require additional exterior lamps for snowplow-equipped vehicles. Consult your authorized dealer for additional information.

## Operating the Vehicle with the Snowplow Attached

**Note:** *Do not use your vehicle for snow removal until you have driven at least 500 miles (800 kilometers).*

Ford recommends vehicle speed does not exceed 44.7 mph (72 km/h) when snowplowing.

The attached snowplow blade restricts airflow to the radiator, and may cause the engine to run at a higher temperature: Attention to engine temperature is especially important when outside temperatures are above freezing. Angle the blade to maximize airflow to the radiator and monitor engine temperature to determine whether a left or right angle provides the best performance.

Follow the severe duty schedule in your Scheduled Maintenance information for engine oil and transmission fluid change intervals.

## Snowplowing with your Airbag Equipped Vehicle

### WARNINGS



Do not attempt to service, repair, or modify the airbag supplemental restraint system (SRS) or its fuses. See your Ford or Lincoln Mercury dealer.



Additional equipment such as snowplow equipment may affect the performance of the airbag sensors increasing the risk of injury. Please refer to the Body Builders Layout Book for instructions about the appropriate installation of additional equipment.



All occupants of the vehicle, including the driver, should always properly wear their safety belts, even when provided with an airbag supplemental restraint system (SRS).

Your vehicle is equipped with a driver and passenger airbag supplemental restraint system. The supplemental restraint system will activate in certain frontal and offset frontal collisions when the vehicle sustains sufficient frontal deceleration.

Careless or high speed driving while plowing snow that results in sufficient vehicle decelerations can deploy the airbag. Such driving also increases the risk of accidents

Never remove or defeat the tripping mechanisms designed into the snow removal equipment by its manufacturer. Doing so may cause damage to the vehicle and the snow removal equipment as well as possible airbag deployment.

## Engine temperature while plowing

When driving with a plow, your engine may run at a higher temperature than normal because the attached snowplow blade will restrict airflow to the radiator.

# Driving Hints

---

- If you are driving more than 14.91 mi (24 km) at temperatures above freezing, angle the plow blade either full left or full right to provide maximum airflow to the radiator.
- If you are driving less than 14.91 mi (24 km) at speeds up to 44.7 mph (72 km/h) in cold weather, you will not need to worry about blade position to provide maximum airflow.

## Transmission operation while plowing

### WARNING



Do not spin the wheels at over 34.2 mph (55 km/h). The tires may fail and injure a passenger or bystander.

---

- Shift transfer case to **4L** (4WD Low) when plowing in small areas at speeds below 5 mph (8 km/h).
- Shift transfer case to **4H** (4WD High) when plowing larger areas or light snow at higher speeds. Do not exceed 15 mph (24 km/h).
- Do not shift the transmission from a forward gear to **R** (Reverse) until the engine is at idle and the wheels have stopped.

# Roadside Emergencies

---

## ROADSIDE ASSISTANCE

### Vehicles Sold in the United States: Getting Roadside Assistance

To fully assist you should you have a vehicle concern, Ford Motor Company offers a complimentary roadside assistance program. This program is separate from the New Vehicle Limited Warranty. The service is available:

- 24 hours a day, seven days a week.
- For the coverage period listed on the Roadside Assistance Card included in your Owner's Manual portfolio.

Roadside Assistance covers:

- A flat tire change with a good spare, if provided with the vehicle (except vehicles supplied with a tire inflation kit).
- Battery jump start.
- Lock-out assistance (key replacement cost is the customer's responsibility).
- Fuel delivery — independent service contractors, if not prohibited by state, local or municipal law, shall deliver up to 2 gal (7.6 L) of gasoline or 5 gal (18.9 L) of diesel fuel to a disabled vehicle. Roadside Assistance limits fuel delivery service to two no-charge occurrences within a 12-month period.
- Winch out — available within 100 ft (30.5 m) of a paved or county maintained road, no recoveries.
- Towing — independent service contractors, if not prohibited by state, local or municipal law, shall tow Ford eligible vehicles to an authorized dealer within 35 mi (56 km) of the disablement location or to the nearest

authorized dealer. If a member requests a tow to an authorized dealer that is more than 35 mi (56 km) from the disablement location, the member shall be responsible for any mileage costs in excess of 35 mi (56 km).

Roadside Assistance includes up to \$200 for a towed trailer if the disabled eligible vehicle requires service at the nearest authorized dealer. If the towing vehicle is operational but the trailer is not, then the trailer does not qualify for any roadside services.

### Vehicles Sold in the United States: Using Roadside Assistance

Complete the roadside assistance identification card and place it in your wallet for quick reference. This card is in the owner's information portfolio in the glove compartment.

United States Ford vehicle customers who require Roadside Assistance, call 1-800-241-3673.

If you need to arrange roadside assistance for yourself, Ford Motor Company reimburses a reasonable amount for towing to the nearest dealership within 35 mi (56 km). To obtain reimbursement information, United States Ford vehicle customers call 1-800-241-3673. Customers need to submit their original receipts.

### Vehicles Sold in Canada: Getting Roadside Assistance

Canadian customers who require roadside assistance, call 1-800-665-2006.

### Vehicles Sold in Canada: Using Roadside Assistance

For your convenience, you may complete the roadside assistance identification card found in the centerfold of your warranty guide and retain for future reference.

# Roadside Emergencies

Canadian roadside coverage and benefits may differ from the U.S. coverage. If you require more information, please refer to the coverage section of your warranty guide, call us in Canada at 1-800-665-2006, or visit our website at [www.ford.ca](http://www.ford.ca).

Sykes Assistance Services Corporation administers the Roadside Assistance program. You must receive covered services in Canada or the continental United States. Coverage extends to vehicles that use public, non-seasonal, annually traveled roadways. Roadside Assistance coverage does not extend to vehicles involved in cross-country driving, logging, autocross and any other form of off-road use. Well maintained roads and surfaces help ensure safe travel for the supplier, and allow their representatives to perform service as per the standard operating procedures.

## In Remote Locations

If our supplier cannot take your vehicle by road to the nearest authorized dealership, transportation by rail or water may be necessary. The program covers a tow to the dock or rail terminal and also to the dealership at the end of the trip.

For rail or water transportation, however, contact your authorized dealer to confirm if you are eligible for additional coverage before you authorize or pay for the service.

Call the Ford Roadside Assistance at 1-800-665-2006 for additional information.

## HAZARD WARNING FLASHERS

**Note:** *The hazard warning flashers will operate when the ignition is in any position or if the key is not in the ignition. If used when the engine is not running, the battery will lose charge. As a result, there may be insufficient power to restart your engine.*



In some models, the hazard flasher control is located on the instrument panel.

In other models, this feature is located on the steering column, just behind the steering wheel.



E161463

Use your hazard warning flashers when your vehicle is creating a safety hazard for other motorists.

- Press the flasher control and all front and rear direction indicators flash.
- Press the flasher control again to turn them off.

## FUEL SHUTOFF

### WARNING



Failure to inspect and, if necessary, repair fuel leaks after a collision may increase the risk of fire and serious injury. Ford Motor Company recommends that the fuel system be inspected by an authorized dealer after any collision.



# Roadside Emergencies

In the event of a moderate to severe collision, this vehicle is equipped with a fuel pump shut-off feature that stops the flow of fuel to the engine. Not every impact will cause a shut-off.

Should your vehicle shut off after a collision, you may restart your vehicle by doing the following:

1. Turn the ignition off.
2. Turn the ignition to crank.
3. Turn the ignition off.
4. Turn the ignition on again to re-enable the fuel pump.

## JUMP STARTING THE VEHICLE

### WARNINGS



The gases around the battery can explode if exposed to flames, sparks, or lit cigarettes. An explosion could result in personal injury or vehicle damage.



Batteries contain sulfuric acid which can burn skin, eyes and clothing, if contacted.



Use only an adequate-sized cable with insulated clamps.

## Preparing Your Vehicle

**Note:** Do not attempt to push-start your automatic transmission vehicle. Automatic transmissions do not have push-start capability. Attempting to push-start a vehicle with an automatic transmission may cause transmission damage.

**Note:** Use only a 12-volt supply to start your vehicle.

**Note:** Do not disconnect the battery of the disabled vehicle as this could damage the vehicle's electrical system.

Park the booster vehicle close to the hood of the disabled vehicle, making sure the two vehicles do not touch. Turn all accessories off.

## Connecting the Jumper Cables

### WARNING



Do not attach the cables to fuel lines, engine rocker covers, the intake manifold or electrical components as grounding points. Stay clear of moving parts. To avoid reverse polarity connections, make sure that you correctly identify the positive (+) and negative (-) terminals on both the disabled and booster vehicles before connecting the cables.

**Note:** In the illustration, the bottom vehicle represents the booster vehicle.

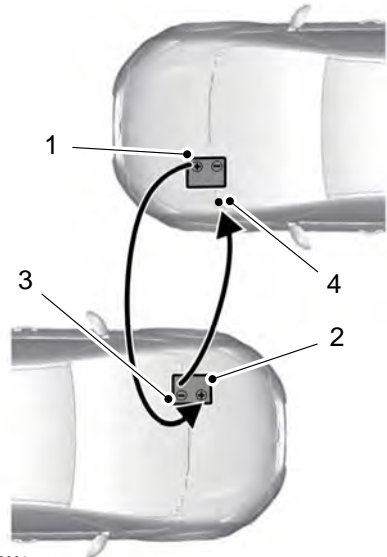

E142664

# Roadside Emergencies

1. Connect the positive (+) jumper cable to the positive (+) terminal of the discharged battery.
2. Connect the other end of the positive (+) cable to the positive (+) terminal of the assisting battery.
3. Connect the negative (-) cable to the negative (-) terminal of the assisting battery.
4. Make the final connection of the negative (-) cable to an exposed metal part of the stalled vehicle's engine, or connect the negative (-) cable to a ground connection point if available.

## WARNING



Do not connect the end of the second cable to the negative (-) terminal of the battery to be jumped. A spark may cause an explosion of the gases that surround the battery.

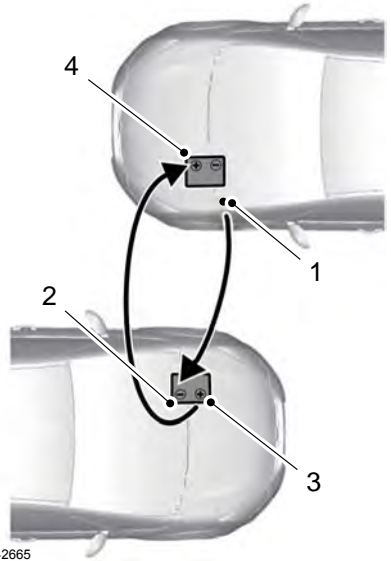

## Jump Starting

1. Start the engine of the booster vehicle and rev the engine moderately, or press the accelerator gently to keep your engine speed between 2000 and 3000 rpm, as shown in your tachometer.
2. Start the engine of the disabled vehicle.
3. Once the disabled vehicle has been started, run both vehicle engines for an additional three minutes before disconnecting the jumper cables.

## Removing the Jumper Cables

Remove the jumper cables in the reverse order that they were connected.

1. Remove the jumper cable from the ground metal surface or connecting point, if available.
2. Remove the jumper cable on the negative (-) terminal of the booster vehicle's battery.
3. Remove the jumper cable from the positive (+) terminal of the booster vehicle's battery.
4. Remove the jumper cable from the positive (+) terminal of the disabled vehicle's battery.

After the disabled vehicle has been started and the jumper cables removed, allow it to idle for several minutes so the battery can recharge.

# Roadside Emergencies

---

## **POST-CRASH ALERT SYSTEM**

The system flashes the turn signal lamps and sounds the horn (intermittently) in the event of a serious impact that deploys an airbag (front, side, side curtain or Safety Canopy) or the safety belt pretensioners.

The horn and lamps will turn off when:

- You press the hazard control button.
- You press the panic button on the remote entry transmitter (if equipped).
- Your vehicle runs out of power.

# Customer Assistance

---

## GETTING THE SERVICES YOU NEED

Warranty repairs to your vehicle must be performed by an authorized dealer. While any authorized dealer handling your vehicle line will provide warranty service, we recommend you return to your selling authorized dealer who wants to ensure your continued satisfaction.

Please note that certain warranty repairs require special training and equipment, so not all authorized dealers are authorized to perform all warranty repairs. This means that, depending on the warranty repair needed, you may have to take your vehicle to another authorized dealer.

A reasonable time must be allowed to perform a repair after taking your vehicle to the authorized dealer. Repairs will be made using Ford or Motorcraft® parts, or remanufactured or other parts that are authorized by Ford.

## Away From Home

If you are away from home when your vehicle needs service, contact the Ford Customer Relationship Center or use the online resources listed below to find the nearest authorized dealer.

In the United States:

### Mailing address

Ford Motor Company  
Customer Relationship Center  
P.O. Box 6248  
Dearborn, MI 48121

### Telephone

1-800-392-3673 (FORD)  
(TDD for the hearing impaired:  
1-800-232-5952)

### Online

Additional information and resources are available online at [www.fordowner.com](http://www.fordowner.com)

These are some of the items that can be found online:

- U.S. dealer locator by Dealer Name, City/State or Zip Code.
- Owner Manuals.
- Maintenance Schedules.
- Recalls.
- Ford Extended Service Plans.
- Ford Genuine Accessories.
- Service specials and promotions.

In Canada:

### Mailing address

Customer Relationship Centre  
Ford Motor Company of Canada, Limited  
P.O. Box 2000  
Oakville, Ontario L6K 0C8

### Telephone

1-800-565-3673 (FORD)

### Online

[www.ford.ca](http://www.ford.ca)

### Twitter

@FordServiceCA (English Canada)  
@FordServiceQC (Quebec)

### Additional Assistance

If you have questions or concerns, or are unsatisfied with the service you are receiving, follow these steps:

1. Contact your Sales Representative or Service Advisor at your selling/servicing authorized dealer.
2. If your inquiry or concern remains unresolved, contact the Sales Manager, Service Manager or Customer Relations Manager.
3. If you require assistance or clarification on Ford Motor Company policies, please contact the Ford Customer Relationship Center.

# Customer Assistance

---

In order to help us serve you better, please have the following information available when contacting a Customer Relationship Center:

- Vehicle Identification Number.
- Your telephone number (home and business).
- The name of the authorized dealer and city where located.
- The vehicle's current odometer reading.

In some states, you must directly notify Ford in writing before pursuing remedies under your state's warranty laws. Ford is also allowed a final repair attempt in some states.

In the United States, a warranty dispute must be submitted to the BBB AUTO LINE before taking action under the Magnuson-Moss Warranty Act, or to the extent allowed by state law, before pursuing replacement or repurchase remedies provided by certain state laws. This dispute handling procedure is not required prior to enforcing state created rights or other rights which are independent of the Magnuson-Moss Warranty Act or state replacement or repurchase laws.

## IN CALIFORNIA (U.S. ONLY)

California Civil Code Section 1793.2(d) requires that, if a manufacturer or its representative is unable to repair a motor vehicle to conform to the vehicle's applicable express warranty after a reasonable number of attempts, the manufacturer shall be required to either replace the vehicle with one substantially identical or repurchase the vehicle and reimburse the buyer in an amount equal to the actual price paid or payable by the consumer (less a reasonable allowance for consumer use). The consumer has the right to choose whether to receive a refund or replacement vehicle.

California Civil Code Section 1793.22(b) presumes that the manufacturer has had a reasonable number of attempts to conform the vehicle to its applicable express warranties if, within the first 18 months of ownership of a new vehicle or the first 18000 miles (29 000 km), whichever occurs first:

1. Two or more repair attempts are made on the same non-conformity likely to cause death or serious bodily injury OR
2. Four or more repair attempts are made on the same nonconformity (a defect or condition that substantially impairs the use, value or safety of the vehicle) OR
3. The vehicle is out of service for repair of nonconformities for a total of more than 30 calendar days (not necessarily all at one time).

In the case of 1 or 2 above, the consumer must also notify the manufacturer of the need for the repair of the nonconformity at the following address:

Ford Motor Company  
16800 Executive Plaza Drive  
Mail Drop 3NE-B  
Dearborn, MI 48126

You are required to submit your warranty dispute to BBB AUTO LINE before asserting in court any rights or remedies conferred by California Civil Code Section 1793.22(b). You are also required to use BBB AUTO LINE before exercising rights or seeking remedies created by the Federal Magnuson-Moss Warranty Act, 15 U.S.C. sec. 2301 et seq. If you choose to seek redress by pursuing rights and remedies not created by California Civil Code Section 1793.22(b) or the Magnuson-Moss Warranty Act, resort to BBB AUTO LINE is not required by those statutes.

# Customer Assistance

## THE BETTER BUSINESS BUREAU (BBB) AUTO LINE PROGRAM (U.S. ONLY)

Your satisfaction is important to Ford Motor Company and to your dealer. If a warranty concern has not been resolved using the three-step procedure outlined earlier in this chapter in the Getting the Services you need section, you may be eligible to participate in the BBB AUTO LINE program.

The BBB AUTO LINE program consists of two parts – mediation and arbitration. During mediation, a representative of the BBB will contact both you and Ford Motor Company to explore options for settlement of the claim. If an agreement is not reached during mediation or you do not want to participate in mediation, and if your claim is eligible, you may participate in the arbitration process. An arbitration hearing will be scheduled so that you can present your case in an informal setting before an impartial person. The arbitrator will consider the testimony provided and make a decision after the hearing.

Disputes submitted to the BBB AUTO LINE program are usually decided within forty days after you file your claim with the BBB. You are not bound by the decision, and may reject the decision and proceed to court where all findings of the BBB Auto Line dispute, and decision, are admissible in the court action. Should you choose to accept the BBB AUTO LINE decision, Ford is then bound by the decision, and must comply with the decision within 30 days of receipt of your acceptance letter.

BBB AUTO LINE Application: Using the information provided below, please call or write to request a program application. You will be asked for your name and address, general information about your new vehicle, information about your warranty concerns, and any steps you have

already taken to try to resolve them. A Customer Claim Form will be mailed that will need to be completed, signed and returned to the BBB along with proof of ownership. Upon receipt, the BBB will review the claim for eligibility under the Program Summary Guidelines.

**You can get more information by calling BBB AUTO LINE at 1-800-955-5100, or writing to:**

**BBB AUTO LINE  
3033 Wilson Boulevard, Suite 600  
Arlington, Virginia 22201**

BBB AUTO LINE applications can also be requested by calling the Ford Motor Company Customer Relationship Center at 1-800-392-3673.

**Note:** *Ford Motor Company reserves the right to change eligibility limitations, modify procedures, or to discontinue this process at any time without notice and without obligation.*

## UTILIZING THE MEDIATION/ARBITRATION PROGRAM (CANADA ONLY)

For vehicles delivered to authorized Canadian dealers. In those cases where you continue to feel that the efforts by Ford of Canada and the authorized dealer to resolve a factory-related vehicle service concern have been unsatisfactory, Ford of Canada participates in an impartial third party mediation/arbitration program administered by the Canadian Motor Vehicle Arbitration Plan (CAMVAP).

The CAMVAP program is a straight forward and relatively speedy alternative to resolve a disagreement when all other efforts to produce a settlement have failed. This procedure is without cost to you and is designed to eliminate the need for lengthy and expensive legal proceedings.

# Customer Assistance

---

In the CAMVAP program, impartial third-party arbitrators conduct hearings at mutually convenient times and places in an informal environment. These impartial arbitrators review the positions of the parties, make decisions and, when appropriate, render awards to resolve disputes. CAMVAP decisions are fast, fair, and final as the arbitrator's award is binding on both you and Ford of Canada.

CAMVAP services are available in all Canadian territories and provinces. For more information, without charge or obligation, call your CAMVAP Provincial Administrator directly at 1-800-207-0685 or visit [www.camvap.ca](http://www.camvap.ca).

## GETTING ASSISTANCE OUTSIDE THE U.S. AND CANADA

Before exporting your vehicle to a foreign country, contact the appropriate foreign embassy or consulate. These officials can inform you of local vehicle registration regulations and where to find unleaded fuel.

If you cannot find unleaded fuel or can only get fuel with an anti-knock index lower than is recommended for your vehicle, contact our Customer Relationship Center.

The use of leaded fuel in your vehicle without proper conversion may damage the effectiveness of your emission control system and may cause engine knocking or serious engine damage. Ford Motor Company or Ford of Canada is not responsible for any damage caused by use of improper fuel. Using leaded fuel may also result in difficulty importing your vehicle back into the United States.

If your vehicle must be serviced while you are traveling or living in Asia-Pacific Region, Sub-Saharan Africa, U.S. Virgin Islands, Central America, the Caribbean, and Israel, contact the nearest authorized dealer. If the authorized dealer cannot help you, contact:

FORD MOTOR COMPANY  
Customer Relationship Center  
1555 Fairlane Drive  
Fairlane Business Park #3  
Allen Park, Michigan 48101  
U.S.A.  
Telephone: (313) 594-4857  
Fax: (313) 390-0804  
Email: [expcac@ford.com](mailto:expcac@ford.com)

For customers in Guam, the Commonwealth of the Northern Mariana Islands (CNMI), America Samoa, and the U.S. Virgin Islands, please feel free to call our Toll-Free Number: (800) 841-FORD (3673).

If your vehicle must be serviced while you are traveling or living in Puerto Rico, contact the nearest authorized dealer. If the authorized dealer cannot help you, contact:

FORD MOTOR COMPANY  
Customer Relationship Center  
1555 Fairlane Drive  
Fairlane Business Park #3  
Allen Park, Michigan 48101  
U.S.A.  
Telephone: (800) 841-FORD (3673)  
FAX: (313) 390-0804  
Email: [prcac@ford.com](mailto:prcac@ford.com)  
[www.ford.com.pr](http://www.ford.com.pr)

If your vehicle must be serviced while you are traveling or living in the Middle East, contact the nearest authorized dealer. If the authorized dealer cannot help you, contact:

# Customer Assistance

---

FORD MOTOR COMPANY  
Customer Relationship Center  
1555 Fairlane Drive  
Fairlane Business Park #3  
Allen Park, Michigan 48101  
U.S.A.  
Telephone: +971 4 3326084  
Toll-Free Number of the Kingdom of Saudi  
Arabia: 800 8971409  
Local Telephone Number of Kuwait:  
24810575  
FAX: +971 4 3327299  
Email: [menacac@ford.com](mailto:menacac@ford.com)  
[www.me.ford.com](http://www.me.ford.com)

If you buy your vehicle in North America and then relocate to any of the above locations, register your vehicle identification number (VIN) and new address with Ford Motor Company Export Operations & Global Growth Initiatives by emailing [expcac@ford.com](mailto:expcac@ford.com).

If you are in another foreign country, contact the nearest authorized dealer. In the event your inquiry is unresolved, communicate your concern with the dealership's Sales Manager, Service Manager or Customer Relations Manager. If you require additional assistance or clarification, please contact the respective Customer Relationship Center as previously listed.

**Customers in the U.S. should call  
1-800-392-3673.**

## ORDERING ADDITIONAL OWNER'S LITERATURE

To order the publications in this portfolio, contact Helm, Incorporated at:

HELM, INCORPORATED  
47911 Halyard Drive  
Plymouth, Michigan 48170  
Attention: Customer Service

Or to order a free publication catalog, call toll free: 1-800-782-4356

Monday-Friday 8:00 a.m. - 6:00 p.m. EST  
Helm, Incorporated can also be reached by their website:

[www.helminc.com](http://www.helminc.com)

(Items in this catalog may be purchased by credit card, check or money order.)

## Obtaining a French Owner's Manual

French Owner's Manual can be obtained from your authorized dealer or by contacting Helm, Incorporated using the contact information listed previously in this section.

## REPORTING SAFETY DEFECTS (U.S. ONLY)



E142557

If you believe that your vehicle has a defect which could cause a crash or could cause injury or death, you should immediately inform the National Highway Traffic Safety Administration (NHTSA) in addition to notifying Ford Motor Company.

If NHTSA receives similar complaints, it may open an investigation, and if it finds that a safety defect exists in a group of vehicles, it may order a recall and remedy campaign. However, NHTSA cannot become involved in individual problems between you, your dealer, or Ford Motor Company.



# Customer Assistance

---

To contact NHTSA, you may call the Vehicle Safety Hotline toll-free at 1-888-327-4236 (TTY: 1-800-424-9153); go to <http://www.safercar.gov>; or write to:

Administrator  
1200 New Jersey Avenue,  
Southeast  
Washington, D.C. 20590

You can also obtain other information about motor vehicle safety from <http://www.safercar.gov>.

## **REPORTING SAFETY DEFECTS (CANADA ONLY)**

If you believe that your vehicle has a defect which could cause a crash or could cause injury or death, you should immediately inform Transport Canada.

<b>Transport Canada Contact Information</b>	
Website	<a href="http://www.tc.gc.ca/eng/roadsafety/menu.htm">http://www.tc.gc.ca/eng/roadsafety/menu.htm</a>
Phone	1-800-333-0510

# Fuses

## FUSE SPECIFICATION CHART

### Power Distribution Box

#### WARNINGS



Always disconnect the battery before servicing high current fuses.



To reduce risk of electrical shock, always replace the cover to the power distribution box before reconnecting the battery or refilling fluid reservoirs.

The power distribution box is located in the engine compartment. It has high-current fuses that protect your vehicle's main electrical systems from overloads.

If you disconnect and reconnect the battery, you will need to reset some features. See **Changing the 12V Battery** (page 244).

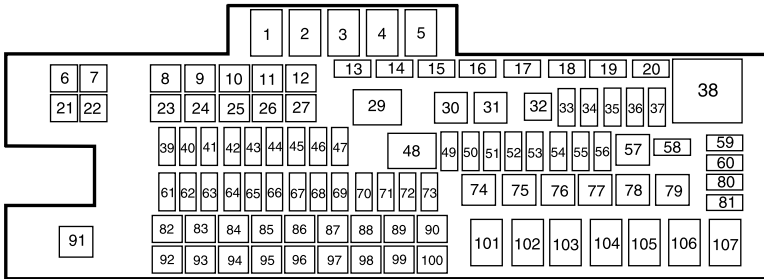

E163101

Fuse or relay number	Fuse amp rating	Protected components
1	Relay	Blower motor
2	—	Not used
3	Relay	Urea heaters (diesel engine)
4	—	Not used
5	Relay	Heated mirrors Rear window defroster
6	—	Not used
7	50A*	Heated mirrors Rear window defroster
8	30A*	Passenger seat
9	30A*	Driver seat
10	40A*	Trailer tow

# Fuses

Fuse or relay number	Fuse amp rating	Protected components
11	—	Not used
12	30A*	Driver smart window motor
13	—	Not used
14	—	Not used
15	Diode	Fuel pump (diesel engine)
16	—	Not used
17	15A**	Heated mirror
18	—	Not used
19	—	Not used
20	—	Not used
21	—	Not used
22	30A*	Trailer tow electric brake
23	40A*	Blower motor
24	—	Not used
25	30A*	Wipers
26	30A*	Trailer tow park lamps
27	25A*	Urea heaters (diesel engine)
28	—	Buss bar
29	Relay	Trailer tow park lamps
30	Relay	A/C clutch
31	Relay	Wipers
32	—	Not used
33	15A**	Vehicle power 1
34	15A**	Vehicle power 2 (diesel engine)
	20A**	Vehicle power 2 (gas engine)
35	10A**	Vehicle power 3
36	15A**	Vehicle power 4 (diesel engine)

# Fuses

Fuse or relay number	Fuse amp rating	Protected components
	20A**	Vehicle power 4 (gas engine)
37	10A**	Vehicle power 5 (diesel engine)
38	Relay	Electronic control module (diesel engine) Powertrain control module (gas engine)
39	10A**	4x4 hub lock
40	15A**	4x4 electronic lock
41	—	Not used
42	20A**	Rear heated seats
43	—	Not used
44	—	Not used
45	10A**	Run/start relay coil
46	10A**	Transmission control module keep-alive power (diesel engine)
47	10A**	A/C clutch feed
48	Relay	Run/start
49	10A**	Rearview camera system
50	10A**	Blower motor relay coil
51	—	Not used
52	10A**	Electronic control module Powertrain control module, Transmission control module run/start
53	10A**	4x4 module
54	10A**	Anti-lock brake system run/start
55	10A**	Rear window defroster coil
56	20A**	Passenger compartment fuse panel run/ start feed
57	Relay	Fuel pump
58	—	Not used
59	—	Not used

## Fuses

Fuse or relay number	Fuse amp rating	Protected components
60	—	Not used
61	—	Not used
62	—	Not used
63	—	Not used
64	—	Not used
65	—	Not used
66	20A**	Fuel pump
67	—	Not used
68	10A**	Fuel pump relay coil
69	—	Not used
70	10A**	Trailer tow backup lamp
71	10A**	Canister vent (gas engine)
72	10A**	Electronic control module relay coil feed keep-alive power Powertrain control module
73	—	Not used
74	—	Not used
75	—	Not used
76	Relay	Trailer tow backup lamp
77	—	Not used
78	—	Not used
79	—	Not used
80	—	Not used
81	—	Not used
82	20A*	Auxiliary power point #2
83	20A*	Auxiliary power point #1
84	30A*	4x4 shift motor
85	30A*	Heated/cooled seats

## Fuses

<b>Fuse or relay number</b>	<b>Fuse amp rating</b>	<b>Protected components</b>
86	25A*	Anti-lock brake system coil feed
87	20A*	Auxiliary power point #5
88	20A*	Auxiliary power point #6
89	40A*	Starter motor
90	25A*	Trailer tow battery charge
91	—	Not used
92	20A*	Auxiliary power point #4
93	20A*	Auxiliary power point #3
94	25A*	Auxiliary switch #1
95	25A*	Auxiliary switch #2
96	50A*	Anti-lock brake system pump
97	40A*	Inverter
98	—	Not used
99	40A*	Instrument panel power inverter
100	—	Not used
101	Relay	Starter
102	—	Not used
103	—	Not used
104	—	Not used
105	—	Not used
106	—	Not used
107	—	Not used

\*Cartridge fuses

\*\*Mini fuses

# Fuses

## Passenger Compartment Fuse Panel

The fuse panel is in the passenger footwell. Remove the panel cover to access the fuses.

Pull the fuse panel cover toward you to remove it. When the clips of the panel disengage, let the panel fall easily.

Use the provided fuse puller tool to remove a fuse. It is on the fuse panel cover.

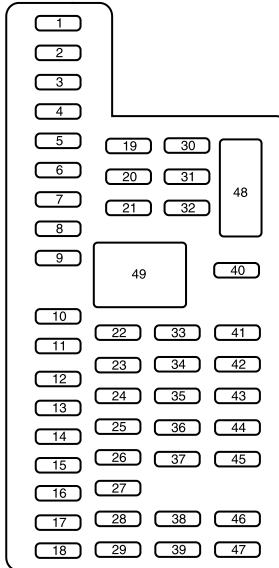

E163102

Fuse or relay number	Fuse amp rating	Protected components
1	30A	Not used (spare)
2	15A	Auxiliary switch relay #4
3	30A	Passenger smart window motor
4	10A	Hood lamp Interior lights
5	20A	Moonroof
6	5A	Driver seat module
7	7.5A	Driver lumbar motor Driver seat switch

## Fuses

Fuse or relay number	Fuse amp rating	Protected components
8	10A	Power mirror switch
9	10A	Auxiliary switch relay #3
10	10A	Customer access feed Run/accessory relay
11	10A	Instrument cluster
12	15A	Interior lighting Lighted running board lamps
13	15A	Right turn signals and brake lamps
14	15A	Left turn signals and brake lamps
15	15A	Backup lamps, Trailer tow backup relay High-mounted stop lamps Reverse signal interior mirror
16	10A	Right low beam headlamp
17	10A	Left low beam headlamp
18	10A	Brake shift interlock Keypad illumination Passive anti-theft transceiver Powertrain control module
19	20A	Amplifier Subwoofer
20	20A	Power door locks
21	10A	Brake on/off switch
22	20A	Horn
23	15A	Not used (spare)
24	15A	Diagnostic connector Electronic finish panel Power fold mirror relay Remote keyless entry Steering wheel control module
25	15A	Not used (spare)
26	5A	Steering wheel control module
27	20A	Not used (spare)



# Fuses

Fuse or relay number	Fuse amp rating	Protected components
28	15A	Ignition switch
29	20A	GPS module Radio SYNC
30	15A	Parking lamp relay Trailer tow parking lamp relay
31	5A	Customer access Trailer brake controller (brake signal)
32	15A	Auto dimming mirror Driver and passenger door lock switch illumination Driver and passenger smart window motor Moonroof motor Passenger window switch Power inverter Rear heated seat switch illumination Telescoping mirror switch
33	10A	Restraint control module
34	10A	Heated steering wheel module Rear heated seats module
35	5A	Reverse park aid module Select shift switch Trailer brake control module
36	10A	Fuel tank select switch
37	10A	Positive temperature coefficient heater
38	10A	AM/FM base radio
39	15A	High beam headlamps
40	10A	Parking lamps (in mirrors) Roof marker lamps
41	7.5A	Passenger airbag deactivation indicator
42	5A	Not used (spare)
43	10A	Wiper relay
44	10A	Auxiliary switches

# Fuses

Fuse or relay number	Fuse amp rating	Protected components
45	5A	Not used (spare)
46	10A	Climate control
47	15A	Fog lamps Fog lamp indicator (in switch)
48	30A Circuit breaker	Power rear sliding window switch Power windows switch Moonroof switch
49	Relay	Delayed accessory

## CHANGING A FUSE

### Fuses

#### WARNING



Always replace a fuse with one that has the specified amperage rating. Using a fuse with a higher amperage rating can cause severe wire damage and could start a fire.

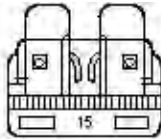

E142430

If electrical components in the vehicle are not working, a fuse may have blown. A break in the fuse wire will indicate a blown fuse. Check the appropriate fuses before replacing any electrical components.

# Maintenance

## GENERAL INFORMATION

Have your vehicle serviced regularly to help maintain its roadworthiness and resale value. There is a large network of authorized dealers that are there to help you with their professional servicing expertise. We believe that their specially trained technicians are best qualified to service your vehicle properly and expertly. They are supported by a wide range of highly specialized tools developed specifically for servicing your vehicle.

To help you service your vehicle, we provide scheduled maintenance information which makes tracking routine service easy. See **Scheduled Maintenance** (page 457).

If your vehicle requires professional service, an authorized dealer can provide the necessary parts and service. Check your warranty information to find out which parts and services are covered.

Use only recommended fuels, lubricants, fluids and service parts conforming to specifications. Motorcraft® parts are designed and built to provide the best performance in your vehicle.

## Precautions

- Do not work on a hot engine.
- Make sure that nothing gets caught in moving parts.
- Do not work on a vehicle with the engine running in an enclosed space, unless you are sure you have enough ventilation.
- Keep all open flames and other burning material (such as cigarettes) away from the battery and all fuel related parts.

## Working with the Engine Off

1. Set the parking brake and shift to park (P).
2. Switch off the engine.
3. Block the wheels.

## Working with the Engine On

### WARNING

 To reduce the risk of vehicle damage and/or personal burn injuries, do not start your engine with the air cleaner removed and do not remove it while the engine is running.

1. Set the parking brake and shift to park (P).
2. Block the wheels

## OPENING AND CLOSING THE HOOD



E142457

1. To open the hood, go inside the vehicle and pull the hood release handle located under the left hand side of the instrument panel.
2. Go to the front of the vehicle and locate the secondary release lever, which is located under the front of the hood, to your right of the center of the vehicle (driver's side), toward the headlight.

# Maintenance

3. Release the hood latch by pushing the secondary release lever to your left, toward the center of the vehicle.
4. Raise the hood.
5. To close the hood, lower the hood and allow it to drop the last 8 to 11 inches (20 to 30 centimeters).

**Note:** Make sure that the hood is closed properly.

## UNDER HOOD OVERVIEW - 6.2L

**Note:** Refer to the diesel supplement for diesel engine component locations.

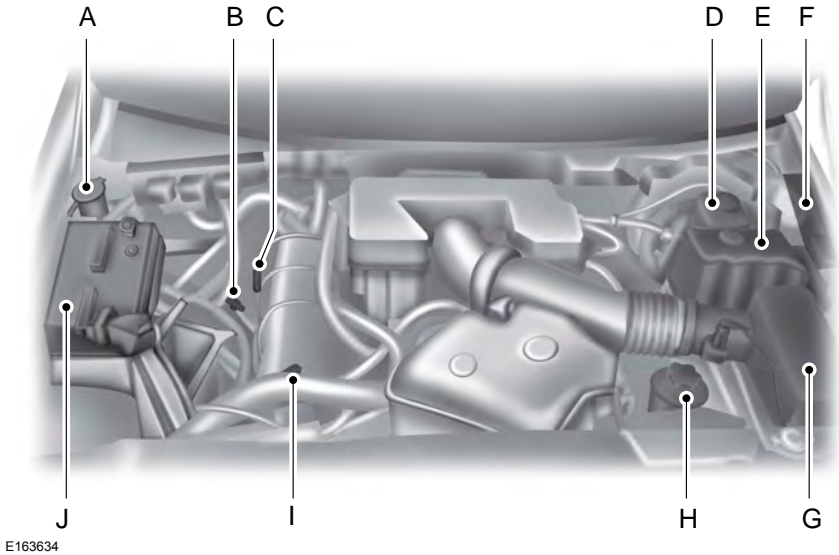

- A. Windshield washer fluid reservoir
- B. Engine oil dipstick
- C. Automatic transmission fluid dipstick
- D. Brake fluid reservoir
- E. Engine coolant reservoir
- F. Power distribution box
- G. Air filter assembly
- H. Power steering fluid reservoir

# Maintenance

- I. Engine oil filler cap
- J. Battery

## UNDER HOOD OVERVIEW - 6.8L

**Note:** Refer to the diesel supplement for diesel engine component locations.

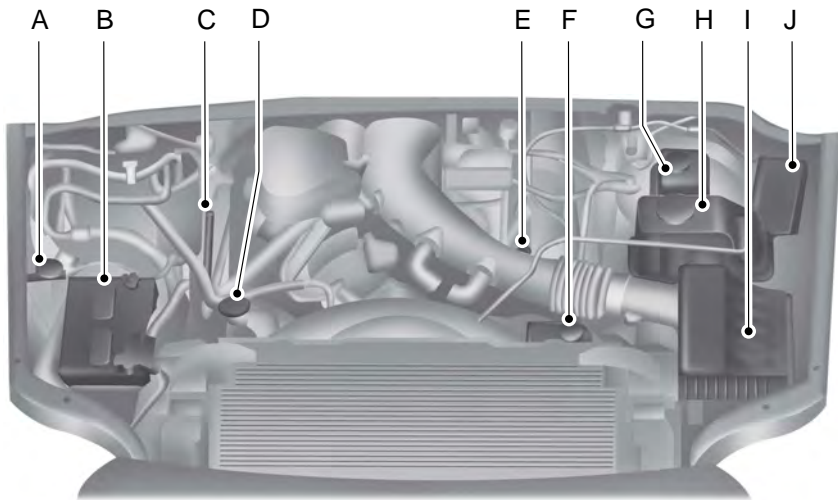

E163635

- A. Windshield washer fluid reservoir
- B. Battery
- C. Automatic transmission fluid dipstick
- D. Engine oil filler cap
- E. Engine oil dipstick
- F. Power steering fluid reservoir
- G. Brake fluid reservoir

# Maintenance

- H. Engine coolant reservoir
- I. Air filter assembly
- J. Power distribution box

## ENGINE OIL DIPSTICK



E161560

- A MIN
- B MAX

## ENGINE OIL CHECK

**Note:** For diesel engine information, refer to the diesel supplement.

1. Make sure that your vehicle is on level ground.
2. Turn the engine off and wait 15 minutes for the oil to drain into the oil pan.
3. Set the parking brake and ensure the gearshift is in P.
4. Open the hood. Protect yourself from engine heat.
5. Locate and carefully remove the engine oil level dipstick. See the Under Hood Overview in this chapter for location of dipstick.

6. Wipe the dipstick clean. Insert the dipstick fully, then remove it again.
  - If the oil level is between the lower and upper holes, the oil level is acceptable. DO NOT ADD OIL.
  - If the oil level is below the lower hole, add enough oil to raise the level within the lower and upper holes.
  - Oil levels above the upper hole may cause engine damage. Some oil must be removed from the engine by an authorized dealer.
7. Put the oil level dipstick back into the oil dipstick tube and ensure it is fully seated.

## Adding Engine Oil

**Note:** Do not remove the filler cap when the engine is running.

**Note:** Do not remove the engine oil level dipstick when the engine is running.

**Note:** Do not add oil further than the MAX mark. Oil levels above the MAX mark may cause engine damage.



E142732

# Maintenance

Only use oils certified for gasoline engines by the American Petroleum Institute (API). An oil with this trademark symbol conforms to the current engine and emission system protection standards and fuel economy requirements of the International Lubricants Specification Advisory Council (ILSAC), comprised of U.S. and Japanese automobile manufacturers.

1. Check the engine oil level.
2. If the engine oil level is not within the normal range, add engine oil that meets Ford specifications. See Capacities and Specifications for more information.
3. Remove the engine oil filler cap and use a funnel to pour the engine oil into the opening.
4. Recheck the engine oil level. Make sure the oil level is not above the normal operating range on the engine oil level dipstick.
5. Install the engine oil level dipstick and ensure it is fully seated.
6. Fully install the engine oil filler cap by turning the filler cap clockwise until three clicks are heard or until the cap is fully seated.

## ENGINE COOLANT CHECK

### WARNINGS



Do not add engine coolant when the engine is hot. Steam and scalding liquids released from a hot cooling system can burn you badly. Also, you can be burned if you spill coolant on hot engine parts.



Do not put engine coolant in the windshield washer fluid container. If sprayed on the windshield, engine coolant could make it difficult to see through the windshield.

### WARNINGS



To reduce the risk of personal injury, make sure the engine is cool before unscrewing the coolant pressure relief cap. The cooling system is under pressure; steam and hot liquid can come out forcefully when the cap is loosened slightly.



Do not add coolant further than the MAX mark.

**Note:** *If your vehicle is equipped with a diesel engine, refer to the Diesel Supplement.*

When the engine is cold, check the concentration and level of the engine coolant at the intervals listed in the scheduled maintenance information. See **Scheduled Maintenance** (page 457).

**Note:** *Make sure that the level is between the MIN and MAX marks on the coolant reservoir.*

**Note:** *Coolant expands when it is hot. The level may extend beyond the MAX mark*

**Note:** *If the level is at the MIN mark, below the MIN mark, or empty, add coolant immediately. See **Adding Engine Coolant** in this chapter.*

The coolant concentration should be maintained within 48% to 50%, which equates to a freeze point between -29°F (-34°C) and -35°F (-37°C).

**Note:** *For best results, coolant concentration should be tested with a refractometer such as Robinair Coolant and Battery Refractometer 75240. We do not recommend the use of hydrometers or coolant test strips for measuring coolant concentrations.*

# Maintenance

**Note:** *Automotive fluids are not interchangeable. Do not use engine coolant or antifreeze or windshield washer fluid outside of its specified function and vehicle location.*

## Adding Engine Coolant

**Note:** *Do not use stop leak pellets, cooling system sealants, or additives as they can cause damage to the engine cooling or heating systems. This damage would not be covered under your vehicle's warranty.*

**Note:** *During normal vehicle operation, the engine coolant may change color from orange to pink or light red. As long as the engine coolant is clear and uncontaminated, this color change does not indicate the engine coolant has degraded nor does it require the engine coolant to be drained, the system to be flushed, or the engine coolant to be replaced.*

- Do not mix different colors or types of coolant in your vehicle. Make sure the correct coolant is used. Mixing of engine coolants may harm your engine's cooling system. The use of an improper coolant may harm engine and cooling system components and may void the warranty. Use prediluted engine coolant meeting the Ford specification. See **Capacities and Specifications** (page 301).
- In case of emergency, a large amount of water without engine coolant may be added in order to reach a vehicle service location. In this instance, the cooling system must be drained, chemically cleaned with Motorcraft® Premium Cooling System Flush, and refilled with engine coolant as soon as possible. Water alone (without engine coolant) can cause engine damage from corrosion, overheating or freezing.

- Do not use alcohol, methanol, brine or any engine coolants mixed with alcohol or methanol antifreeze (coolant). Alcohol and other liquids can cause engine damage from overheating or freezing.
- Do not add extra inhibitors or additives to the coolant. These can be harmful and compromise the corrosion protection of the engine coolant.

Unscrew the cap slowly. Any pressure will escape as you unscrew the cap.

Add prediluted engine coolant meeting the Ford specification. See **Capacities and Specifications** (page 301).

Whenever coolant has been added, the coolant level in the coolant reservoir should be checked the next few times you drive the vehicle. If necessary, add enough prediluted engine coolant to bring the coolant level to the proper level.

## Recycled Engine Coolant

Ford Motor Company does not recommend the use of recycled engine coolant since a Ford-approved recycling process is not yet available.

Used engine coolant should be disposed of in an appropriate manner. Follow your community's regulations and standards for recycling and disposing of automotive fluids.



# Maintenance

## Severe Climates

If you drive in extremely cold climates:

- It may be necessary to have a Ford authorized dealer increase the coolant concentration above 50%.
- A coolant concentration of 60% will provide improved freeze point protection. Engine coolant concentrations above 60% will decrease the overheat protection characteristics of the engine coolant and may cause engine damage.

If you drive in extremely hot climates:

- It may be necessary to have a Ford authorized dealer decrease the coolant concentration to 40%.
- A coolant concentration of 40% will provide improved overheat protection. Engine coolant concentrations below 40% will decrease the corrosion/freeze protection characteristics of the engine coolant and may cause engine damage.

Vehicles driven year-round in non-extreme climates should use prediluted engine coolant for optimum cooling system and engine protection.

## What You Should Know About Fail-Safe Cooling

If the engine coolant supply is depleted, this feature allows the vehicle to be driven temporarily before incremental component damage is incurred. The “fail-safe” distance depends on ambient temperatures, vehicle load and terrain.

## How Fail-Safe Cooling Works

If the engine begins to overheat, the engine coolant temperature gauge will move to the red (hot) area and:



The coolant temperature warning light will illuminate.



The service engine soon indicator will illuminate.

If the engine reaches a preset over-temperature condition, the engine will automatically switch to alternating cylinder operation. Each disabled cylinder acts as an air pump and cools the engine.

When this occurs the vehicle will still operate. However:

- The engine power will be limited.
- The air conditioning system will be disabled.

Continued operation will increase the engine temperature and the engine will completely shut down, causing steering and braking effort to increase.

Once the engine temperature cools, the engine can be re-started. Take your vehicle to an authorized dealer as soon as possible to minimize engine damage.

## When Fail-Safe Mode Is Activated

### WARNINGS



Fail-safe mode is for use during emergencies only. Operate the vehicle in fail-safe mode only as long as necessary to bring the vehicle to rest in a safe location and seek immediate repairs. When in fail-safe mode, the vehicle will have limited power, will not be able to maintain high-speed operation, and may completely shut down without warning, potentially losing engine power, power steering assist, and power brake assist, which may increase the possibility of a crash resulting in serious injury.



Never remove the coolant reservoir cap while the engine is running or hot.

# Maintenance

You have limited engine power when in the fail-safe mode, so drive the vehicle with caution. The vehicle will not be able to maintain high-speed operation and the engine will run rough. Remember that the engine is capable of completely shutting down automatically to prevent engine damage, therefore:

1. Pull off the road as soon as safely possible and turn off the engine.
2. Arrange for the vehicle to be taken to an authorized dealer.
3. If this is not possible, wait a short period for the engine to cool.
4. Check the coolant level and replenish if low.
5. Re-start the engine and take your vehicle to an authorized dealer.

**Note:** *Driving the vehicle without repairing the engine problem increases the chance of engine damage. Take your vehicle to an authorized dealer as soon as possible.*

## Engine Fluid Temperature Management (If Equipped)

### WARNINGS



To reduce the risk of collision and injury, be prepared that the vehicle speed may reduce and the vehicle may not be able to accelerate with full power until the fluid temperatures reduce.



Never remove the coolant reservoir cap while the engine is running or hot.

Your vehicle has been designed to pull a trailer, but because of the added load, the vehicle's engine may temporarily reach higher temperatures during severe operating conditions such as ascending a long or steep grade while pulling a trailer in hot ambient temperatures.

At this time, you may notice your engine coolant temperature gauge needle move toward the H and the POWER REDUCED TO LOWER TEMP message may appear in the information display.

You may notice a reduction in the vehicle's speed caused by reduced engine power. In order to manage the engine fluid temperatures, your vehicle may enter this mode if certain high-temperature and high-load conditions take place. The amount of speed reduction will depend on the vehicle loading, towing, grade, ambient temperature, and other factors. If this occurs, there is no need to pull off the road. The vehicle can continue to be driven while this message is active

The air conditioning may turn on and off during severe operating conditions to protect the engine from overheating. When the engine coolant temperature decreases to a more normal operating temperature, the air conditioning will turn on once again.

If the engine coolant temperature gauge moves fully into the red (hot) area, or if the coolant temperature warning or service engine soon messages appear in your information display:

1. Stop your vehicle as soon as safely possible and shift the transmission into Park (P).
2. Leave the engine running until the coolant temperature gauge needle moves away from the H range. After several minutes, if this does not happen, follow the remaining steps.
3. Switch the engine off and wait for it to cool before checking the coolant level.
4. If the coolant level is normal, you may restart your engine and continue on.

# Maintenance

5. If the coolant is low, add coolant, restart the engine and take your vehicle to an authorized dealer. See Adding engine coolant in this chapter for more information. Refer to fail-safe cooling for additional information.

## AUTOMATIC TRANSMISSION FLUID CHECK

Have an authorized dealer check and change the transmission fluid and filter at the correct service interval. See **Scheduled Maintenance** (page 457).

Do not use supplemental transmission fluid additives, treatments or cleaning agents. The use of these materials may affect transmission operation and result in damage to internal transmission components.

### Checking Automatic Transmission Fluid

For scheduled intervals of the fluid checks and changes, See **Scheduled Maintenance** (page 457). Your transmission does not consume fluid. However, the fluid level should be checked if the transmission is not working properly, i.e., if the transmission slips or shifts slowly or if you notice some sign of fluid leakage.

Automatic transmission fluid expands when warmed. To obtain an accurate fluid check, drive the vehicle until it is at normal operating temperature (approximately 19 mi (30 km)). Verify that the transmission fluid temperature gauge, located on the instrument cluster, is within normal range.

1. Drive the vehicle 19 (30 km) until it reaches normal operating temperature.
2. Park the vehicle on a level surface and engage the parking brake.

3. With the engine running, parking brake engaged and your foot on the brake pedal, move the gearshift lever through all of the gear ranges. Allow sufficient time for each gear to engage.
4. Latch the gearshift lever in **P** and leave the engine running.
5. Remove the dipstick, wiping it clean with a clean, dry lint free rag. If necessary, refer to the Under Hood Overview in this chapter for the location of the dipstick.
6. Install the dipstick making sure it is fully seated in the filler tube.
7. Remove the dipstick and inspect the fluid level. The fluid should be in the designated area for normal operating temperature or ambient temperature.

### Low Fluid Level

Type A



E163739

Type B

# Maintenance



E163740

Do not drive the vehicle if there is no indication of fluid on the dipstick and the ambient temperature is above 50°F (10°C).

## Correct Fluid Level

Type A

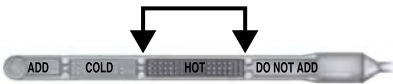

E163741

Type B

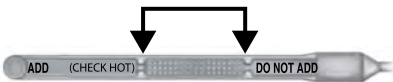

E163742

For vehicles equipped with 5-speed transmissions, check the fluid at the normal operating temperature of 151°F (66°C) to 170°F (77°C) on a level surface. For vehicles equipped with 6-speed transmissions, check the fluid at the normal operating temperature of 196°F (91°C) to 215°F (102°C) on a level surface. The normal operating temperature can be reached after approximately 19 mi (30 km).

## High Fluid Level

Type A

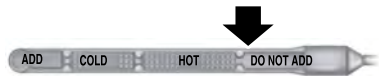

E163743

Type B



E163744

Fluid levels above the safe range may result in transmission failure. An overfill condition of transmission fluid may cause shift and engagement concerns, and possible damage.

# Maintenance

High fluid levels can be caused by an overheating condition.

## Adjusting Automatic Transmission Fluid Levels

**Note:** Use of a non-approved automatic transmission fluid may cause internal transmission component damage.

Before adding any fluid, make sure the correct type is used. The type of fluid used is normally indicated on:

- the dipstick handle.
- See **Capacities and Specifications** (page 301).

If necessary, add fluid in 8 (250 ml) increments through the filler tube until the level is correct.

Type A

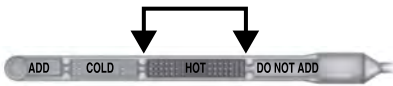

E163745

Type B



E163746

If an overfill occurs, excess fluid should be removed by a qualified technician.

**Note:** An overfill condition of transmission fluid may cause shift and engagement concerns, and possible damage.

Do not use supplemental transmission fluid additives, treatments or cleaning agents. The use of these materials may affect transmission operation and result in damage to internal transmission components.

## TRANSFER CASE FLUID CHECK (If Equipped)

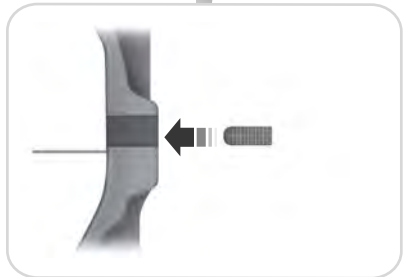
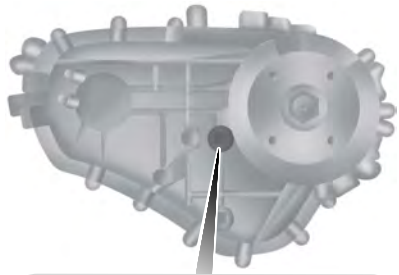

E164246

1. Clean the filler plug.
2. Remove the filler plug and inspect the fluid level.

# Maintenance

3. Add only enough fluid through the filler opening so that the fluid level is at the bottom of the opening.

Only use fluid that meets Ford specifications. See **Capacities and Specifications** (page 301).

## BRAKE FLUID CHECK

Fluid levels between the **MIN** and **MAX** lines are within the normal operating range; there is no need to add fluid. If the fluid levels are outside of the normal operating range, the performance of the system could be compromised; seek service from your authorized dealer immediately.

## POWER STEERING FLUID CHECK

Check the power steering fluid. See **Scheduled Maintenance** (page 457). If adding fluid is necessary, use only MERCON LV ATF

**Note:** *This procedure is for vehicles with gasoline engines. Vehicles with diesel engines are similar. See Under Hood Overview in your diesel supplement.*

Check the fluid level when it is at ambient temperature.

1. Check the fluid level in the reservoir. It should be between the MIN and MAX range. Do not add fluid if the level is within this range.
  2. If the fluid level is low, add fluid to bring the fluid level up to between the MIN and MAX range.
  3. Switch the engine on.
  4. While the engine idles, turn the steering wheel left and right several times.
  5. Switch the engine off.
6. Recheck the fluid level in the reservoir. Do not add fluid if the level is between the MIN and MAX range.
  7. If the fluid is low, add fluid in small amounts, continuously checking the level until it is between the MIN and MAX range. For proper fluid type, See **Capacities and Specifications** (page 301). Be sure to put the cap back on the reservoir.

## WASHER FLUID CHECK

### WARNING



If you operate your vehicle in temperatures below 40°F (5°C), use washer fluid with antifreeze protection. Failure to use washer fluid with antifreeze protection in cold weather could result in impaired windshield vision and increase the risk of injury or accident.

Add fluid to fill the reservoir if the level is low. Only use a washer fluid that meets Ford specifications. See **Capacities and Specifications** (page 301).

State or local regulations on volatile organic compounds may restrict the use of methanol, a common windshield washer antifreeze additive. Washer fluids containing non-methanol antifreeze agents should be used only if they provide cold weather protection without damaging the vehicle's paint finish, wiper blades or washer system.

## FUEL FILTER

Your vehicle is equipped with a lifetime fuel filter that is integrated with the fuel tank. Regular maintenance or replacement is not needed.

# Maintenance

## CHANGING THE 12V BATTERY

### WARNINGS



This vehicle may be equipped with more than one battery, removal of cable from only one battery does not disconnect the vehicle electrical system. Be sure to disconnect cables from all batteries when disconnecting power. Failure to do so may cause serious personal injury or property damage.



Batteries normally produce explosive gases which can cause personal injury. Therefore, do not allow flames, sparks or lighted substances to come near the battery. When working near the battery, always shield your face and protect your eyes. Always provide proper ventilation.



When lifting a plastic-cased battery, excessive pressure on the end walls could cause acid to flow through the vent caps, resulting in personal injury and damage to the vehicle or battery. Lift the battery with a battery carrier or with your hands on opposite corners.



Keep batteries out of reach of children. Batteries contain sulfuric acid. Avoid contact with skin, eyes or clothing. Shield your eyes when working near the battery to protect against possible splashing of acid solution. In case of acid contact with skin or eyes, flush immediately with water for a minimum of 15 minutes and get prompt medical attention. If acid is swallowed, call a physician immediately.

**Note:** *If your battery has a cover/shield, make sure it is reinstalled after the battery has been cleaned or replaced.*

**Note:** *Battery posts, terminals and related accessories contain lead and lead compounds. Wash hands after handling.*

**Note:** *Electrical or electronic accessories or components added to the vehicle by the dealer or the owner may adversely affect battery performance and durability.*

Your vehicle is equipped with a Motorcraft maintenance-free battery which normally does not require additional water during its life of service.

For longer, trouble-free operation, keep the top of the battery clean and dry. Also, make certain the battery cables are always tightly fastened to the battery terminals.

If you see any corrosion on the battery or terminals, remove the cables from the terminals and clean with a wire brush. You can neutralize the acid with a solution of baking soda and water.

It is recommended that the negative battery cable terminal be disconnected from the battery if you plan to store your vehicle for an extended period of time.

Because your vehicle's engine is electronically controlled by a computer, some control conditions are maintained by power from the battery. When the battery is disconnected or a new battery is installed, the engine must relearn its idle and fuel trim strategy for optimum driveability and performance. Flexible fuel vehicles (FFV) must also relearn the ethanol content of the fuel for optimum driveability and performance. To begin this process

1. With the vehicle at a complete stop, set the parking brake.
2. Put the gearshift in **P**, turn off all accessories.
3. Start the engine. Run the engine until it reaches normal operating temperature.
4. Allow the engine to idle for at least one minute.
5. Turn the A/C on and allow the engine to idle for at least one minute.

# Maintenance

---

6. Release the parking brake. With your foot on the brake pedal and with the A/C on, put the vehicle in **D** and allow the engine to idle for at least one minute.
  - If you do not allow the engine to relearn its idle trim, the idle quality of your vehicle may be adversely affected until the idle trim is eventually relearned.
7. Drive the vehicle to complete the relearning process
  - The vehicle may need to be driven 10 mi (16 km) or more to relearn the idle and fuel trim strategy along with the ethanol content for flexible fuel vehicles.
  - For flexible fuel vehicles, if you are operating on E85, you may experience poor starts or an inability to start the engine and driveability problems until the fuel trim and ethanol content have been relearned.

If the battery has been disconnected or a new battery has been installed, the clock and radio settings must be reset once the battery is reconnected.

**Always dispose of automotive batteries in a responsible manner. Follow your local authorized standards for disposal. Call your local authorized recycling center to find out more about recycling automotive batteries.**

## **Battery Management System (If Equipped)**

The battery management system (BMS) monitors battery conditions and takes actions to extend battery life. If excessive battery drain is detected, the system may temporarily disable certain electrical features to protect the battery. Those electrical accessories affected include the rear defrost, heated/cooled seats, climate

control fan, heated steering wheel, audio and navigation system. A message may be shown in the information displays to alert the driver that battery protection actions are active. These messages are only for notification that an action is taking place, and not intended to indicate an electrical problem or that the battery requires replacement.

## **Electrical accessory installation**

To ensure proper operation of the BMS, any electrical devices that are added to the vehicle should not have their ground connection made directly at the negative battery post. A connection at the negative battery post can cause inaccurate measurements of the battery condition and potential incorrect system operation.

**Note:** *Electrical or electronic accessories added to the vehicle by the dealer or the owner may adversely affect battery performance and durability, and may also affect the performance of other electrical systems in the vehicle.*

When a battery replacement is required, the battery should only be replaced with a Ford recommended replacement battery which matches the electrical requirements of the vehicle. After battery replacement, or in some cases after charging the battery with the external charger, the BMS requires eight hours of vehicle sleep time (key off with doors closed) to relearn the new battery state of charge. Prior to relearning the state of charge, the BMS may disable electrical features (to protect the battery) earlier than normal.



# Maintenance

## CHECKING THE WIPER BLADES



E142463

Run the tip of your fingers over the edge of the blade to check for roughness.

Clean the wiper blades with washer fluid or water applied with a soft sponge or cloth.

## CHANGING THE WIPER BLADES

You can manually move the wiper arms when the ignition is off. This allows for ease of blade replacement and cleaning under the blades.



E165804

1. Pull the wiper blade and arm away from the glass.

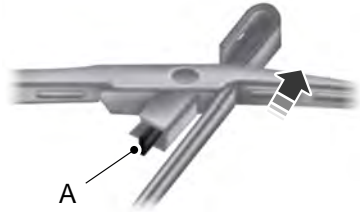

E165794

2. Release the wiper blade lock (A) and separate the wiper blade from the wiper arm.
3. Install in the reverse order.

**Note:** Make sure that the wiper blade locks into place. Lower the wiper arm and blade back on the windshield. The wiper arms will automatically return to their normal position when you turn the ignition on.

- Replace wiper blades at least once per year for optimum performance.
- You can improve poor wiper quality by cleaning the wiper blades and the windshield.

## ADJUSTING THE HEADLAMPS

### Vertical Aim Adjustment

The headlamps on your vehicle are properly aimed at the assembly plant. If your vehicle has been in an accident, the alignment of your headlamps should be checked by your authorized dealer.

# Maintenance

## Headlamp Aiming Target

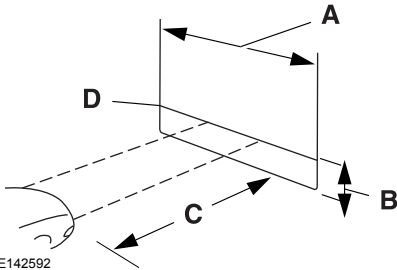

E142592

- A 8 feet (2.4 meters)
- B Center height of lamp to ground
- C 25 feet (7.6 meters)
- D Horizontal reference line

## Vertical Aim Adjustment Procedure

1. Park the vehicle directly in front of a wall or screen on a level surface, approximately 25 feet (7.6 meters) away.
2. Measure the height of the headlamp bulb center from the ground and mark an 8 foot (2.4 meter) horizontal reference line on the vertical wall or screen at this height.

**Note:** To see a clearer light pattern for adjusting, you may want to block the light from one headlamp while adjusting the other.

3. Turn on the low beam headlamps to illuminate the wall or screen and open the hood.

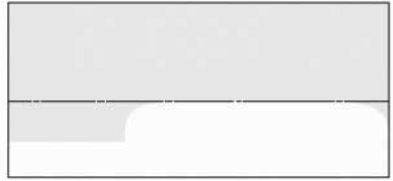

E142465

4. On the wall or screen you will observe a flat zone of high intensity light located at the top of the right hand portion of the beam pattern. If the top edge of the high intensity light zone is not at the horizontal reference line, the headlamp will need to be adjusted.



E163806

5. Locate the vertical adjuster on each headlamp. Using a Phillips #2 screwdriver, turn the adjuster either clockwise or counterclockwise in order to adjust the vertical aim of the headlamp.
6. Repeat steps 3 thru 5 to adjust the other headlamp.
7. Close the hood and turn off the lamps.

## Horizontal Aim Adjustment

Horizontal aim is not required for this vehicle and is not adjustable.

# Maintenance

## REMOVING A HEADLAMP

### WARNING



Handle a halogen headlamp bulb carefully and keep out of children's reach. Grasp the bulb only by its plastic base and do not touch the glass. The oil from your hand could cause the bulb to break the next time the headlamps are operated.

**Note:** If the bulb is accidentally touched, it should be cleaned with rubbing alcohol before being used.

**Note:** This procedure is for replacing the headlamps, park lamps or turn lamps.

1. Make sure the headlamp control is in the Off position and open the hood.

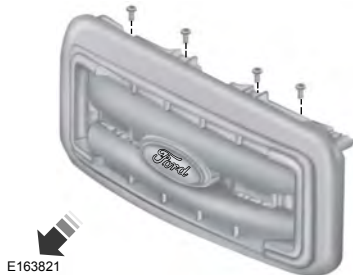

1. Using masking tape or a marker, make an alignment mark between one of the grille brackets and the vehicle radiator support to ensure correct grille alignment during the installation procedure. Do not scratch the black coating from the radiator support.
2. Remove the two grille to headlamp assembly push pins and the four bolts attaching the top of the grille to the radiator support.
3. Pull the top of the grille forward to gain access to the lower grille spring clips.
4. Depress the spring clips through the lower inner grille access openings using a flat head screwdriver.
5. Pull the grill straight out to remove.



6. Remove the four bolts from the headlamp assembly.
7. Pull the assembly straight out disengaging one snap clip from the fender.
8. Disconnect the electrical connector by squeezing the release tab and pushing the connector forward, then pulling it rearward.

# Maintenance



E163823

9. For the headlamp bulb, remove the bulb by turning it counterclockwise and pulling it straight out.



E163824

10. For the park or turn lamp bulb, remove the bulb by turning it counterclockwise and pulling it straight out.
11. Install the new bulb(s) in reverse order.

## CHANGING A BULB

### Lamp Assembly Condensation

Exterior lamps are vented to accommodate normal changes in pressure. Condensation can be a natural by-product of this design. When moist air enters the lamp assembly through the vents, there is a possibility that condensation can occur when the temperature is cold. When

normal condensation occurs, a thin film of mist can form on the interior of the lens. The thin mist eventually clears and exits through the vents during normal operation. Clearing time may take as long as 48 hours under dry weather conditions.

Examples of acceptable condensation are:

- Presence of thin mist (no streaks, drip marks or droplets).
- Fine mist covers less than 50% of the lens.

Examples of unacceptable moisture (usually caused by a lamp water leak) are:

- Water puddle inside the lamp.
- Large water droplets, drip marks or streaks present on the interior of the lens.

Take your vehicle to a dealer for service if any of the above conditions of unacceptable moisture are present.

### Replacing Front Clearance and Identification Lamp Bulbs (If Equipped)



E163825

1. Make sure the headlamps are off.
2. Remove the screw and lens from the lamp assembly.
3. Separate the bulb from the bulb socket.
4. Install the new bulb in reverse order.

# Maintenance

## Replacing Fog Lamp Bulbs (If Equipped)

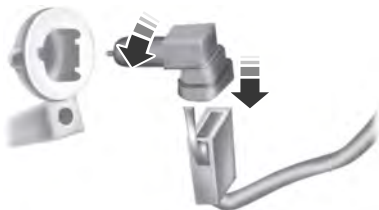

E163826

1. Make sure the headlamps are off.
2. Remove the bulb socket from the fog lamp by turning it counterclockwise.
3. Disconnect the electrical connector from the fog lamp bulb.
4. Install the new bulb in reverse order.

## Replacing Brake/Tail/Turn/Reverse Lamp Bulbs

### Pickup Models

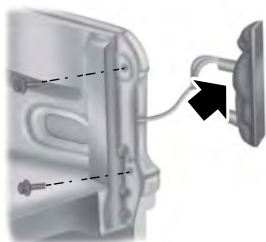

E163827

1. Make sure the headlamps are off, then open the tailgate to expose the lamp assemblies

2. Remove the two bolts from the tail lamp assembly and carefully pull the lamp assembly from the tailgate pillar by releasing the two retaining tabs.
3. Rotate the bulb socket counterclockwise and remove from lamp assembly
4. Pull the bulb straight out of the socket.
5. Install the new bulb in reverse order.

### Chassis Cabs



E163828

1. Make sure the headlamps are off.
2. Remove the four screws and the lamp lens from lamp assembly.
3. Carefully pull the bulb straight out of the socket.
4. Install the new bulb in reverse order.

## Replacing Cargo Lamp and High-mount Brake Lamp Bulbs

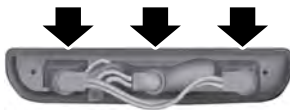

E163829

# Maintenance

1. Make sure the headlamps are off.
2. Remove the screws and lamp assembly from the vehicle as wiring permits.
3. Remove the bulb socket by rotating it counterclockwise.
4. Pull the bulb straight out of the socket.
5. Install the new bulb in reverse order.

1. Reach behind the rear bumper to locate the bulb.
2. Twist the bulb socket counterclockwise and carefully pull to remove it from the lamp assembly.
3. Pull out the old bulb from the socket and push in the new bulb.
4. Install the new bulb in reverse order.

## Replacing the License Plate Lamp Bulb

**Note:** *The license plate bulbs are located behind the rear bumper.*

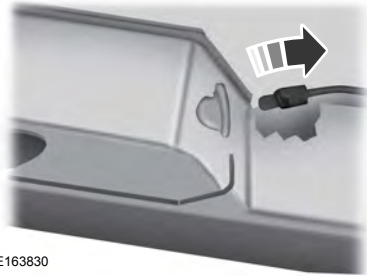

E163830

## BULB SPECIFICATION CHART

Replacement bulbs are specified in the chart below. Headlamp bulbs must be marked with an authorized "D.O.T." for North America and an "E" for Europe to ensure lamp performance, light brightness and pattern and safe visibility. The correct bulbs will not damage the lamp assembly or void the lamp assembly warranty and will provide quality bulb illumination time.

Function	Number of Bulbs	Trade name
*Headlamps	2	H13/9008
*Side marker lamp - front	2	W5W
*Park/Turn lamp- front	2	3157NA
Tail/stop/turn/side marker (pickups only)	2	3157
Tail/stop/turn/side marker (chassis cabs only)	2	3157
Reverse (pickups only)	2	921
Reverse (chassis cabs only)	2	3157
License plate lamp	—	194
Fog lamp	—	9145

# Maintenance

<b>Function</b>	<b>Number of Bulbs</b>	<b>Trade name</b>
High-mount brake lamp	1	912
Cargo lamp	2	912
Map lamp	2	12V6W
Dome/reading lamps	3	578
Interior visor lamp	2	2825
Mirror turn signal	2	2825
Mirror clearance lamp		2825
Front clearance lamps and front identification lamps <sup>1</sup>	5	194
Rear fender clearance <sup>1</sup>	4	LED <sup>2</sup>
Rear identification <sup>1</sup>	3	193 <sup>2</sup>
Underhood Lamp	1	906 LED (if equipped) <sup>2</sup>
To replace all instrument panel lights - see your authorized dealer		
<sup>1</sup> Dual rear wheels, if equipped		
<sup>2</sup> See your authorized dealer to replace the lamp assembly		

# Maintenance

## CHANGING THE ENGINE AIR FILTER

### WARNINGS



To reduce the risk of vehicle damage and personal burn injuries, do not start your engine with the air cleaner removed and do not remove it while the engine is running.



To reduce the risk of vehicle damage and personal burn injuries, do not start your engine with the air cleaner removed and do not remove it while the engine is running.

**Note:** Failure to use the correct air filter element may result in severe engine damage. The customer warranty may be void for any damage to the engine if the correct air filter element is not used.

When changing the air filter element, use only the air filter element listed. See **Capacities and Specifications** (page 301).

Change the air filter element at the proper interval. See **Scheduled Maintenance** (page 457).

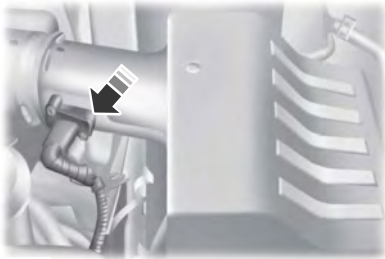

1. Locate the mass air flow sensor electrical connector on the air outlet tube. Disconnect the mass air flow sensor electrical connector.

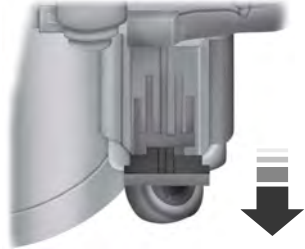

2. Reposition the locking clip on the connector (connector shown from below for clarity), squeeze the connector and pull it off of the air outlet tube.

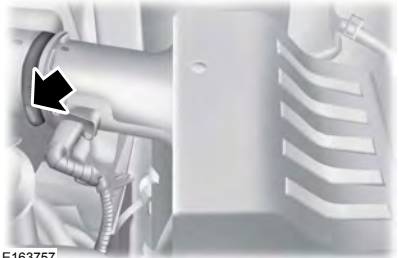

3. Clean the area from around the air tube to the air cover connection to prevent debris from entering the system. Next, loosen the bolt on the air tube clamp so the clamp is no longer snug to the air tube. It is not necessary to completely remove the clamp.
4. Pull the air tube off from the air cleaner housing.



# Maintenance



E163758

5. Release the three clamps that secure the cover to the air filter housing. Push the air filter cover toward the center of the vehicle and up slightly to release it.
6. Remove the air filter element from the air filter housing.
7. Install the new air filter element.

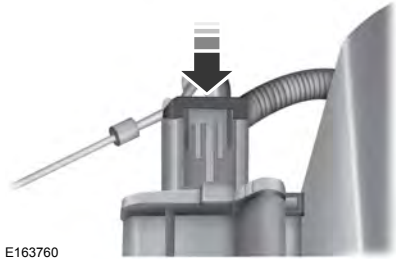

E163760

10. Reconnect the mass air flow sensor electrical connector to the outlet tube. Make sure the locking tab on the connector is in the locked position (connector shown from below for clarity).



E163759

8. Replace the air filter housing cover and secure all the clamps. Be careful not to crimp the filter element edges between the air filter housing and cover and ensure that you properly align the tabs on the edge into the slots.
9. Slip the air tube onto the air filter housing and tighten the air-tube clamp bolt snugly. Do not over tighten air-tube clamp bolt.

# Vehicle Care

---

## GENERAL INFORMATION

Your Ford or Lincoln authorized dealer has many quality products available to clean your vehicle and protect its finishes.

## CLEANING PRODUCTS

For best results, use the following products or products of equivalent quality:

- Motorcraft Bug and Tar Remover (ZC-42)
- Motorcraft Custom Bright Metal Cleaner (ZC-15)
- Motorcraft Detail Wash (ZC-3-A)
- Motorcraft Dusting Cloth (ZC-24)
- Motorcraft Engine Shampoo and Degreaser (U.S. only) (ZC-20)
- Motorcraft Engine Shampoo (Canada only) (CXC-66-A)
- Motorcraft Multi-Purpose Cleaner (Canada only) (CXC-101)
- Motorcraft Premium Glass Cleaner (Canada only) (CXC-100)
- Motorcraft Premium Quality Windshield Washer Fluid (Canada only) [CXC-37-(A, B, D or F)]
- Motorcraft Premium Windshield Wash Concentrate with Bitterant (U.S. only) (ZC-32-B2)
- Motorcraft Professional Strength Carpet & Upholstery Cleaner (ZC-54)
- Motorcraft Premium Leather and Vinyl Cleaner (ZC-56)
- Motorcraft Spot and Stain Remover (U.S. only) (ZC-14)
- Motorcraft Ultra-Clear Spray Glass Cleaner (ZC-23)
- Motorcraft Wheel and Tire Cleaner (ZC-37-A)

## CLEANING THE EXTERIOR

Wash your vehicle regularly with cool or lukewarm water and a neutral pH shampoo, we recommend Motorcraft Detail Wash.

- Never use strong household detergents or soap, for example dish washing or laundry liquid. These products can discolor and spot painted surfaces.
- Never wash your vehicle when is hot to the touch, or during strong or direct sunlight.
- Dry your vehicle with a chamois or soft terry cloth towel to eliminate water spotting.
- Immediately remove fuel spillages, bird droppings, insect deposits and road tar. These may cause damage to your vehicle's paintwork or trim over time. We recommend Motorcraft Bug and Tar Remover.
- Remove any exterior accessories, for example antennas, before entering a car wash.

**Note:** *Suntan lotions and insect repellents can damage painted surfaces. If these substances come in contact with your vehicle, wash the affected area as soon as possible.*

## Exterior Chrome Parts

- Apply a high quality-cleaning product to bumpers and other chrome parts. Follow the manufacturer's instructions. We recommend Motorcraft Custom Bright Metal Cleaner.
- Do not apply the cleaning product to hot surfaces. Do not leave the cleaning product on chrome surfaces longer than the time recommended.
- Using other non-recommended cleaners can result in severe and permanent cosmetic damage.

# Vehicle Care

---

**Note:** *Never use abrasive materials, for example steel wool or plastic pads as they can scratch the chrome surface.*

**Note:** *Do not use chrome cleaner, metal cleaner or polish on wheels or wheel covers.*

## Exterior Plastic Parts

For routine cleaning we recommend Motorcraft Detail Wash. If tar or grease spots are present, we recommend Motorcraft Bug and Tar Remover.

## Stripes or Graphics (If Equipped)

Do not use a commercial or high-pressure sprayer on the surface or edge of stripes and graphics. This can damage them and cause the edges to peel away from the vehicle surface.

## Underbody

Flush the complete underside of your vehicle frequently. Keep body and door drain holes free of debris or foreign material.

## WAXING

Regular waxing is necessary to protect your car's paint from the elements. We recommend that you wash and wax the painted surface once or twice a year.

When washing and waxing, park your vehicle in a shaded area out of direct sunlight. Always wash your vehicle before applying wax.

- Use a quality wax that does not contain abrasives.
- Follow the manufacturer's instructions to apply and remove the wax.
- Apply a small amount of wax in a back-and-forth motion, not in circles.

- Do not allow wax to come in contact with any non-body (low-gloss black) colored trim. The wax will discolor or stain the parts over time.
  - Roof racks.
  - Bumpers.
  - Grained door handles.
  - Side moldings.
  - Mirror housings.
  - Windshield cowl area.
- Do not apply wax to glass areas.
- After waxing, your car's paint should feel smooth, and be free of streaks and smudges.

## CLEANING THE ENGINE

Engines are more efficient when they are clean because grease and dirt buildup keep the engine warmer than normal.

When washing:

- Take care when using a power washer to clean the engine. The high-pressure fluid could penetrate the sealed parts and cause damage.
- Do not spray a hot engine with cold water to avoid cracking the engine block or other engine components.
- Spray Motorcraft Engine Shampoo and Degreaser on all parts that require cleaning and pressure rinse clean. In Canada, use Motorcraft Engine Shampoo.
- Never wash or rinse the engine while it is hot or running; water in the running engine may cause internal damage.

# Vehicle Care

- Never wash or rinse any ignition coil, spark plug wire or spark plug well, or the area in and around these locations.
- Cover the battery, power distribution box, and air filter assembly to prevent water damage when cleaning the engine.

## CLEANING THE WINDOWS AND WIPER BLADES

Car wash chemicals and environmental fallout can result in windshield and wiper blade contamination. Dirty windshield and wipers will result in poor windshield wiper operation. Keep the windshield and wiper blades clean to maintain windshield wiper performance.

To clean the windshield and wiper blades:

- Clean the windshield with a non-abrasive glass cleaner.
- For windshields contaminated with tree sap, chemicals, wax or bugs, clean the entire windshield using steel wool (no greater than 0000 grade) in a circular motion and rinse with water.
- Clean the wiper blades with isopropyl rubbing alcohol or windshield washer concentrate.

**Note:** Do not use razor blades or other sharp objects to clean or remove decals from the inside of the heated rear window. The vehicle warranty does not cover damage caused to the heated rear window grid lines.

## CLEANING THE INTERIOR

### WARNINGS



Do not use cleaning solvents, bleach or dye on the vehicle's safety belts, as these actions may weaken the belt webbing.

### WARNINGS



On vehicles equipped with seat-mounted airbags, do not use chemical solvents or strong detergents. Such products could contaminate the side airbag system and affect performance of the side airbag in a collision.

For fabric, carpets, cloth seats, safety belts and seats equipped with side airbags:

- Remove dust and loose dirt with a vacuum cleaner.
- Remove light stains and soil with Motorcraft Professional Strength Carpet & Upholstery Cleaner.
- If grease or tar is present on the material, spot-clean the area first with Motorcraft Spot and Stain Remover. In Canada, use Motorcraft Multi-Purpose Cleaner.
- If a ring forms on the fabric after spot cleaning, clean the entire area immediately (but do not oversaturate) or the ring will set.
- Do not use household cleaning products or glass cleaners, which can stain and discolor the fabric and affect the flame retardant abilities of the seat materials.

## CLEANING THE INSTRUMENT PANEL AND INSTRUMENT CLUSTER LENS

### WARNING



Do not use chemical solvents or strong detergents when cleaning the steering wheel or instrument panel to avoid contamination of the airbag system.

# Vehicle Care

**Note:** Follow the same procedure as cleaning leather seats for cleaning leather instrument panels and leather interior trim surfaces. See **Cleaning Leather Seats** (page 258).

Clean the instrument panel and cluster lens with a clean, damp and soft cloth, then use a clean, dry and soft cloth to dry these areas.

- Avoid cleaners or polishes that increase the gloss of the upper portion of the instrument panel. The dull finish in this area helps protect you from undesirable windshield reflection.
- Do not use any household cleaning products or glass cleaners as these may damage the finish of the instrument panel, interior trim and cluster lens.
- Wash or wipe your hands clean if you have been in contact with certain products such as insect repellent and suntan lotion to avoid possible damage to the interior painted surfaces.
- Do not allow air fresheners and hand sanitizers to spill onto interior surfaces. If a spill occurs, wipe off immediately. Your warranty may not cover these damages.

If a staining liquid like coffee or juice has been spilled on the instrument panel or on interior trim surfaces:

1. Wipe up spilled liquid using a clean, soft cloth as quickly as possible.
2. Use Motorcraft Premium Leather and Vinyl Cleaner or a commercially available leather cleaning product for automotive interiors. Test any cleaner or stain remover on an inconspicuous area.
3. Alternatively, wipe the surface with a clean, soft cloth and a mild soap and water solution. Dry the area with a clean, soft cloth.

4. If necessary, apply more soap and water solution or cleaning product to a clean, soft cloth and press it onto the soiled area. Allow this to set at room temperature for 30 minutes.
5. Remove the soaked cloth, then with a clean, damp cloth, use a rubbing motion for 60 seconds on the soiled area.
6. Dry the area with a clean, soft cloth.

## CLEANING LEATHER SEATS (If

Equipped)

### Without King Ranch Edition

**Note:** Follow the same procedure as cleaning leather seats for cleaning leather instrument panels and leather interior trim surfaces.

For routine cleaning, wipe the surface with a soft, damp cloth and a mild soap and water solution. Dry the area with a clean, soft cloth.

For cleaning and removing spots and stains such as dye transfer, use Motorcraft Premium Leather and Vinyl Cleaner or a commercially available leather cleaning product for automotive interiors.

**Note:** Test any cleaner or stain remover on an inconspicuous area.

You should:

- Remove dust and loose dirt with a vacuum cleaner.
- Clean and treat spills and stains as soon as possible.

Do not use the following products as these may damage the leather:

- Oil and petroleum or silicone-based leather conditioners.
- Household cleaners.

# Vehicle Care

---

- Alcohol solutions.
- Solvents or cleaners intended specifically for rubber, vinyl and plastics.

## With King Ranch Edition

Your vehicle has seating covered in premium, top-grain leather that is extremely durable, but still requires special care and maintenance in order to preserve longevity and comfort.

Regular cleaning and conditioning maintains the appearance of the leather.

### Cleaning

For dirt, use a vacuum cleaner then use a clean, damp cloth or soft brush.

For routine cleaning, wipe the surface with a soft, damp cloth. For more thorough cleaning, wipe the surface with a mild soap and water solution.

- Clean spills as quickly as possible.
- Test any cleaner or stain remover on an inconspicuous part of the leather as cleaners may darken the leather.
- Do not spill coffee, ketchup, mustard, orange juice or oil-based products on the leather as they may permanently stain the leather.
- Do not use household cleaning products, alcohol solutions, solvents or cleaners intended for rubber, vinyl or plastics.

### Scratches

Because the leather in the seat comes from genuine steer hides, there may be evidence of naturally occurring markings, such as small scars. These markings give character to the seating covers and are considered to be proof of a genuine leather product.

In order to lessen the appearance of certain scratches and other wear marks, apply conditioner on the affected area following the same instructions as in the **Conditioning** section.

### Conditioning

Bottles of King Ranch Leather Conditioner are available at the King Ranch Saddle Shop. Visit the website at [www.krsaddleshop.com](http://www.krsaddleshop.com), or call 1-800-282-KING (5464) in the United States. If you are unable to obtain King Ranch Leather Conditioner, use another premium leather conditioner.

- Clean the surfaces using the steps outlined in the Cleaning section.
- Make sure the leather is dry then apply a nickel-sized amount of conditioner to a clean, dry cloth.
- Rub the conditioner into the leather until it disappears. Allow the conditioner to dry, then repeat the process for the entire interior. If a film appears, wipe it off with a dry, clean cloth.

## REPAIRING MINOR PAINT DAMAGE

Authorized dealers have touch-up paint to match your vehicle's color. Your vehicle color code is printed on a sticker on the front, left-hand side door jamb. Take your color code to your authorized dealer to make sure you get the correct color.

Before repairing minor paint damage, use a cleaner such as Motorcraft Bug and Tar Remover to remove particles such as bird droppings, tree sap, insect deposits, tar spots, road salt and industrial fallout.

Always read the instructions before using cleaning products.

# Vehicle Care

---

## CLEANING THE ALLOY WHEELS *(If Equipped)*

**Note:** Do not apply a cleaning chemical to warm or hot wheel rims and covers.

**Note:** Some automatic car washes may cause damage to the finish on your wheel rims and covers.

**Note:** Industrial-strength or heavy-duty cleaners in combination with brush agitation to remove brake dust and dirt, could wear away the clear coat finish over a period time.

**Note:** Do not use hydrofluoric acid-based or high caustic-based wheel cleaners, steel wool, fuels or strong household detergents.

**Note:** If you intend parking your vehicle for an extended period after cleaning the wheels with a wheel cleaner, drive your vehicle for a few minutes before doing so. This will reduce the risk of increased corrosion of the brake discs.

Alloy wheels and wheel covers are coated with a clear coat paint finish. To maintain their condition we recommend that you:

- Clean the wheels weekly using Motorcraft Wheel and Tire Cleaner. Apply using manufacturer's instructions.
- Use a sponge to remove heavy deposits of dirt and brake dust accumulation.
- Rinse thoroughly with a strong stream of water when you have completed the cleaning process.
- To remove tar and grease, use Motorcraft Bug and Tar Remover.

## VEHICLE STORAGE

If you plan on storing your vehicle for 30 days or more, read the following maintenance recommendations to make sure your vehicle stays in good operating condition.

We engineer and test all motor vehicles and their components for reliable, regular driving. Under various conditions, long-term storage may lead to degraded engine performance or failure unless you use specific precautions to preserve engine components.

### General

- Store all vehicles in a dry, ventilated place.
- Protect from sunlight, if possible.
- If vehicles are stored outside, they require regular maintenance to protect against rust and damage.

### Body

- Wash your vehicle thoroughly to remove dirt, grease, oil, tar or mud from exterior surfaces, rear-wheel housing and the underside of front fenders.
- Periodically wash your vehicle if it is stored in exposed locations.
- Touch-up exposed or primed metal to prevent rust.
- Cover chrome and stainless steel parts with a thick coat of auto wax to prevent discoloration. Re-wax as necessary when you wash your vehicle.
- Lubricate all hood, door and luggage compartment hinges and latches with a light grade oil.
- Cover interior trim to prevent fading.
- Keep all rubber parts free from oil and solvents.

# Vehicle Care

---

## Engine

- Change the engine oil and filter prior to storage because used engine oil contains contaminants which may cause engine damage.
- Start the engine every 15 days for a minimum of 15 minutes. Run at fast idle with the climate controls set to defrost until the engine reaches normal operating temperature.
- With your foot on the brake, shift through all the gears while the engine is running.
- We recommend that you change the engine oil before you use your vehicle again.

## Fuel system

- Fill the fuel tank with high-quality fuel until the first automatic shutoff of the fuel pump nozzle.

## Cooling system

- Protect against freezing temperatures.
- When removing your vehicle from storage, check coolant fluid level. Confirm that there are no cooling system leaks and that fluid is at the recommended level.

## Battery

- Check and recharge as necessary. Keep connections clean.
- If storing your vehicle for more than 30 days without recharging the battery, we recommend that you disconnect the battery cables to maintain battery charge for quick starting.

**Note:** *It is necessary to reset memory features if battery cables are disconnected.*

## Brakes

- Make sure the brakes and parking brake release fully.

## Tires

- Maintain recommended air pressure.

## Miscellaneous

- Make sure all linkages, cables, levers and pins under your vehicle are covered with grease to prevent rust.
- Move vehicles at least 25 ft (7.5 m) every 15 days to lubricate working parts and prevent corrosion.

## Removing Vehicle From Storage

When your vehicle is ready to come out of storage, do the following:

- Wash your vehicle to remove any dirt or grease film build-up on window surfaces.
- Check windshield wipers for any deterioration.
- Check under the hood for any foreign material that may have collected during storage such as mice or squirrel nests.
- Check the exhaust for any foreign material that may have collected during storage.
- Check tire pressures and set tire inflation per the Tire Label.
- Check brake pedal operation. Drive your vehicle 15 ft (4.5 m) back and forth to remove rust build-up.
- Check fluid levels (including coolant, oil and gas) to make sure there are no leaks, and fluids are at recommended levels.
- If you remove the battery, clean the battery cable ends and check for damage.



# Vehicle Care

---

Contact an authorized dealer if you have any concerns or issues.

# Wheels and Tires

## GENERAL INFORMATION

### Notice to utility vehicle and truck owners

#### WARNINGS



Utility vehicles have a significantly higher rollover rate than other types of vehicles. To reduce the risk of serious injury or death from a rollover or other crash you must avoid sharp turns and abrupt maneuvers, drive at safe speeds for the conditions, keep tires properly inflated, never overload or improperly load your vehicle, and make sure every passenger is properly restrained.



In a rollover crash, an unbelted person is significantly more likely to die than a person wearing a seat belt. All occupants must wear seat belts and children/infants must use appropriate restraints to minimize the risk of injury or ejection.



Do not become overconfident in the ability of four-wheel drive vehicles. Although a four-wheel drive vehicle may accelerate better than a two-wheel drive vehicle in low traction situations, it won't stop any faster than two-wheel drive vehicles. Always drive at a safe speed.

Utility vehicles and trucks handle differently than passenger cars in the various driving conditions that are encountered on streets, highways and off-road. Utility vehicles and trucks are not designed for cornering at speeds as high as passenger cars any more than low-slung sports cars are designed to perform satisfactorily under off-road conditions.

Study your owner's manual and any supplements for specific information about equipment features, instructions for safe driving and additional precautions to reduce the risk of an accident or serious injury.

### Four-wheel drive system (if equipped)

#### WARNING



Do not become overconfident in the ability of four-wheel drive vehicles. Although a four-wheel drive vehicle may accelerate better than a two-wheel drive vehicle in low traction situations, it won't stop any faster than two-wheel drive vehicles. Always drive at a safe speed.

A vehicle equipped with four-wheel drive (when selected) has the ability to use all four wheels to power itself. This increases traction which may enable you to safely drive over terrain and road conditions that a conventional two-wheel drive vehicle cannot.

For four-wheel drive vehicles, a spare tire of a different size other than the tire provided should never be used. A dissimilar spare tire size (other than the spare tire provided) or major dissimilar tire sized between the front and rear axles could cause the four-wheel drive system to stop functioning and default to front-wheel drive.



E145298

# Wheels and Tires

## How your vehicle differs from other vehicles

Sport utility vehicles and trucks can differ from some other vehicles in a few noticeable ways. Your vehicle may be:

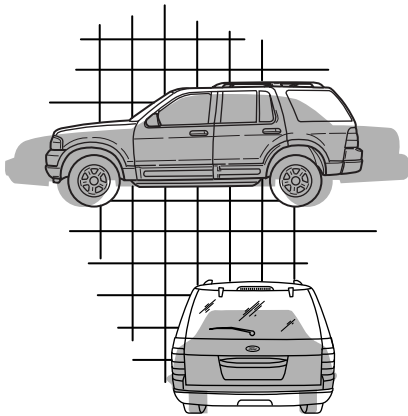

E145299

- Higher - to allow higher load carrying capacity and to allow it to travel over rough terrain without getting hung up or damaging underbody components.
- Shorter - to give it the capability to approach inclines and drive over the crest of a hill without getting hung up or damaging underbody components. All other things held equal, a shorter wheelbase may make your vehicle quicker to respond to steering inputs than a vehicle with a longer wheelbase.
- Narrower - to provide greater maneuverability in tight spaces, particularly in off-road use.

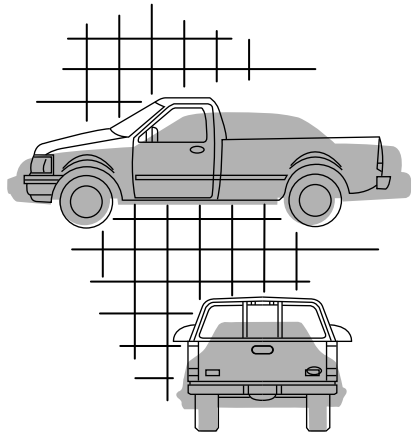

E168583

As a result of the above dimensional differences, Sport utility vehicles and trucks often will have a higher center of gravity and a greater difference in center of gravity between the loaded and unloaded condition. These differences that make your vehicle so versatile also make it handle differently than an ordinary passenger car.

# Wheels and Tires

## TIRE CARE

### Information About Uniform Tire Quality Grading



E142542

Tire Quality Grades apply to new pneumatic passenger car tires. The Quality grades can be found where applicable on the tire sidewall between tread shoulder and maximum section width. For example: **Treadwear 200 Traction AA Temperature A.**

These Tire Quality Grades are determined by standards that the United States Department of Transportation has set.

Tire Quality Grades apply to new pneumatic passenger car tires. They do not apply to deep tread, winter-type snow tires, space-saver or temporary use spare tires, light truck or LT type tires, tires with nominal rim diameters of 10 to 12 inches or limited production tires as defined in Title 49 Code of Federal Regulations Part 575.104 (c)(2).

### U.S. Department of Transportation Tire quality grades:

The U.S. Department of Transportation requires Ford Motor Company to give you the following information about tire grades exactly as the government has written it.

#### Treadwear

The treadwear grade is a comparative rating based on the wear rate of the tire when tested under controlled conditions on a specified government test course. For example, a tire graded 150 would wear one and one-half ( $1\frac{1}{2}$ ) times as well on the government course as a tire graded 100. The relative performance of tires depends upon the actual conditions of their use, however, and may depart significantly from the norm due to variations in driving habits, service practices, and differences in road characteristics and climate.

#### Traction AA A B C

##### WARNING



The traction grade assigned to this tire is based on straight-ahead braking traction tests, and does not include acceleration, cornering, hydroplaning or peak traction characteristics

# Wheels and Tires

---

The traction grades, from highest to lowest are AA, A, B, and C. The grades represent the tire's ability to stop on wet pavement as measured under controlled conditions on specified government test surfaces of asphalt and concrete. A tire marked C may have poor traction performance.

## Temperature A B C

### WARNING



The temperature grade for this tire is established for a tire that is properly inflated and not overloaded. Excessive speed, underinflation, or excessive loading, either separately or in combination, can cause heat buildup and possible tire failure.

The temperature grades are A (the highest), B and C, representing the tire's resistance to the generation of heat and its ability to dissipate heat when tested under controlled conditions on a specified indoor laboratory test wheel. Sustained high temperature can cause the material of the tire to degenerate and reduce tire life, and excessive temperature can lead to sudden tire failure. The grade C corresponds to a level of performance which all passenger car tires must meet under the

Federal Motor Vehicle Safety Standard No. 139. Grades B and A represent higher levels of performance on the laboratory test wheel than the minimum required by law.

## Glossary of Tire Terminology

\***Tire label:** A label showing the original equipment tire sizes, recommended inflation pressure and the maximum weight the vehicle can carry.

\***Tire Identification Number (TIN):** A number on the sidewall of each tire providing information about the tire brand and manufacturing plant, tire size and date of manufacture. Also referred to as DOT code.

\***Inflation pressure:** A measure of the amount of air in a tire.

\***Standard load:** A class of P-metric or Metric tires designed to carry a maximum load at set pressure. For example: For P-metric tires 35 psi (2.4 bar) or 36 (2.5 bar) depending on tire size and for Metric tires 36 psi (2.5 bar). Increasing the inflation pressure beyond this pressure will not increase the tire's load carrying capability.

\***Extra load:** A class of P-metric or Metric tires designed to carry a heavier maximum load at 42 psi (2.9 bar). Increasing the inflation pressure beyond this pressure will not increase the tire's load carrying capability.

# Wheels and Tires

\***kPa:** Kilopascal, a metric unit of air pressure.

\***PSI:** Pounds per square inch, a standard unit of air pressure.

\***Cold tire pressure:** The tire pressure when the vehicle has been stationary and out of direct sunlight for an hour or more and prior to the vehicle being driven for 1 mile (1.6 kilometers).

\***Recommended inflation pressure:** The cold inflation pressure found on the Safety Compliance Certification Label (affixed to either the door hinge pillar, door-latch post, or the door edge that meets the door-latch post, next to the driver's seating position), or Tire Label located on the B-pillar or the edge of the driver's door.

**B-pillar:** The structural member at the side of the vehicle behind the front door.

\***Bead area of the tire:** Area of the tire next to the rim.

\***Sidewall of the tire:** Area between the bead area and the tread.

\***Tread area of the tire:** Area of the perimeter of the tire that contacts the road when mounted on the vehicle.

\***Rim:** The metal support (wheel) for a tire or a tire and tube assembly upon which the tire beads are seated.

## Information Contained on the Tire Sidewall

Both United States and Canada Federal regulations require tire manufacturers to place standardized information on the sidewall of all tires. This information identifies and describes the fundamental characteristics of the tire and also provides a U.S. DOT Tire Identification Number for safety standard certification and in case of a recall.

## Information on P Type Tires

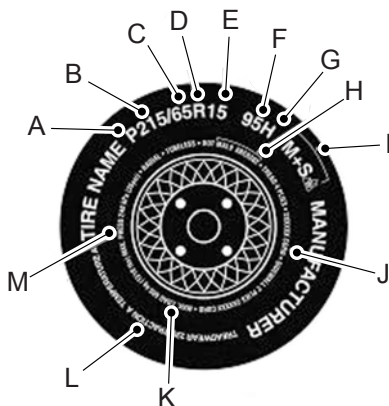

E142543

P215/65R15 95H is an example of a tire size, load index and speed rating. The definitions of these items are listed below. (Note that the tire size, load index and speed rating for your vehicle may be different from this example.)

# Wheels and Tires

A. **P:** Indicates a tire, designated by the Tire and Rim Association, that may be used for service on cars, sport utility vehicles, minivans and light trucks. **Note:** If your tire size does not begin with a letter this may mean it is designated by either the European Tire and Rim Technical Organization or the Japan Tire Manufacturing Association.

B. **215:** Indicates the nominal width of the tire in millimeters from sidewall edge to sidewall edge. In general, the larger the number, the wider the tire.

C. **65:** Indicates the aspect ratio which gives the tire's ratio of height to width.

D. **R:** Indicates a radial type tire.

E. **15:** Indicates the wheel or rim diameter in inches. If you change your wheel size, you will have to purchase new tires to match the new wheel diameter.

F. **95:** Indicates the tire's load index. It is an index that relates to how much weight a tire can carry. You may find this information in your owner's manual. If not, contact a local tire dealer.

**Note:** *You may not find this information on all tires because it is not required by federal law.*

G. **H:** Indicates the tire's speed rating. The speed rating denotes the speed at which a tire is designed to be driven for extended periods of time under a standard condition of load and inflation pressure. The tires on your vehicle may operate at different conditions for load and inflation pressure. These speed ratings may need to be adjusted for the difference in conditions. The ratings range from 81 mph (130 km/h) to 186 mph (299 km/h). These ratings are listed in the following chart.

**Note:** *You may not find this information on all tires because it is not required by federal law.*

Letter rating	mph ( km/h)
M	81 (130)
N	87 (140)
Q	99 (159)
R	106 (171)
S	112 (180)
T	118 (190)
U	124 (200)
H	130 (210)
V	149 (240)

# Wheels and Tires

Letter rating	mph ( km/h)
W	168 (270)
Y	186 (299)

**Note:** For tires with a maximum speed capability over 149 mph (240 km/h), tire manufacturers sometimes use the letters ZR. For those with a maximum speed capability over 186 mph (299 km/h), tire manufacturers always use the letters ZR.

## H. U.S. DOT Tire Identification

**Number:** This begins with the letters DOT and indicates that the tire meets all federal standards. The next two numbers or letters are the plant code designating where it was manufactured, the next two are the tire size code and the last four numbers represent the week and year the tire was built. For example, the numbers 317 mean the 31st week of 1997. After 2000 the numbers go to four digits. For example, 2501 means the 25th week of 2001. The numbers in between are identification codes used for traceability. This information is used to contact customers if a tire defect requires a recall.

I. **M+S or M/S:** Mud and Snow, or

**AT:** All Terrain, or

**AS:** All Season.

## J. Tire Ply Composition and

**Material Used:** Indicates the number of plies or the number of layers of rubber-coated fabric in the tire tread and sidewall. Tire manufacturers also must indicate the ply materials in the tire and the sidewall, which include steel, nylon, polyester, and others.

K. **Maximum Load:** Indicates the maximum load in kilograms and pounds that can be carried by the tire. (affixed to either the door hinge pillar, door-latch post, or the door edge that meets the door-latch post, next to the driver's seating position), or Tire Label located on the B-pillar or the edge of the driver's door.

## L. Treadwear, Traction and Temperature Grades:

\***Treadwear** The treadwear grade is a comparative rating based on the wear rate of the tire when tested under controlled conditions on a specified government test course. For example, a tire graded 150 would wear 1½ times as well on the government course as a tire graded 100.

\***Traction:** The traction grades, from highest to lowest are AA, A, B, and C. The grades represent the tire's ability to stop on wet pavement as measured under controlled conditions on specified government test surfaces of asphalt and concrete. A tire marked C may have poor traction performance.



# Wheels and Tires

**\*Temperature:** The temperature grades are A (the highest), B and C, representing the tire's resistance to the generation of heat and its ability to dissipate heat when tested under controlled conditions on a specified indoor laboratory test wheel.

## M. Maximum Inflation

**Pressure:** Indicates the tire manufacturers' maximum permissible pressure or the pressure at which the maximum load can be carried by the tire. This pressure is normally higher than the vehicle manufacturer's recommended cold inflation pressure which can be found on the Safety Compliance Certification Label (affixed to either the door hinge pillar, door-latch post, or the door edge that meets the door-latch post, next to the driver's seating position), or Tire Label located on the B-pillar or the edge of the driver's door. The cold inflation pressure should never be set lower than the recommended pressure on the vehicle label.

The tire suppliers may have additional markings, notes or warnings such as standard load or radial tubeless.

## Additional Information Contained on the Tire Sidewall for LT Type Tires

**Note:** *Tire Quality Grades do not apply to this type of tire.*

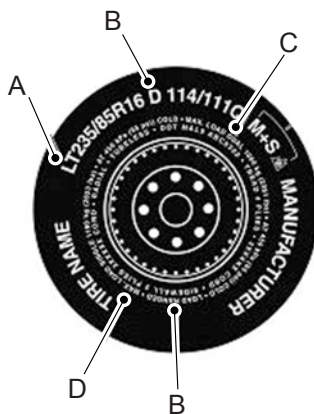

E142544

LT type tires have some additional information beyond those of P type tires. These differences are described below.

**A. LT:** Indicates a tire, designated by the Tire and Rim Association, that is intended for service on light trucks.

**B. Load Range and Load Inflation Limits:** Indicates the tire's load-carrying capabilities and its inflation limits.

**C. Maximum Load Dual lb (kg) at psi (kPa) cold:** Indicates the maximum load and tire pressure when the tire is used as a dual; defined as four tires on the rear axle (a total of six or more tires on the vehicle).

# Wheels and Tires

**D. Maximum Load Single lb (kg) at psi (kPa) cold:** Indicates the maximum load and tire pressure when the tire is used as a single; defined as two tires (total) on the rear axle.

## Information on T Type Tires

T145/80D16 is an example of a tire size.

**Note:** *The temporary tire size for your vehicle may be different from this example. Tire Quality Grades do not apply to this type of tire.*

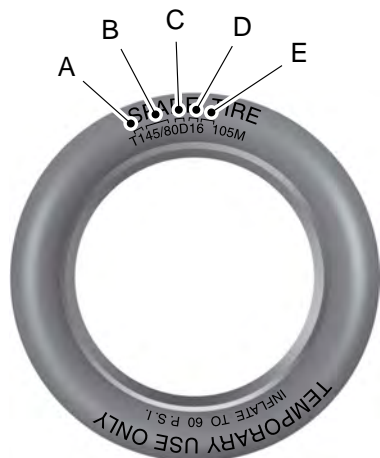

E142545

T type tires have some additional information beyond those of P type tires. These differences are described below:

**A. T:** Indicates a type of tire, designated by the Tire and Rim Association, that is intended for temporary service on cars, sport utility vehicles, minivans and light trucks.

**B. 145:** Indicates the nominal width of the tire in millimeters from sidewall edge to sidewall edge. In general, the larger the number, the wider the tire.

**C. 80:** Indicates the aspect ratio which gives the tire's ratio of height to width. Numbers of 70 or lower indicate a short sidewall.

**D. D:** Indicates a diagonal type tire.

**R:** Indicates a radial type tire.

**E. 16:** Indicates the wheel or rim diameter in inches. If you change your wheel size, you will have to purchase new tires to match the new wheel diameter.

## Location of the Tire Label

You will find a Tire Label containing tire inflation pressure by tire size and other important information located on the B-Pillar or the edge of the driver's door.

## Inflating Your Tires

Safe operation of your vehicle requires that your tires are properly inflated. Remember that a tire can lose up to half of its air pressure without appearing flat.

## Wheels and Tires

---

Every day before you drive, check your tires. If one looks lower than the others, use a tire gauge to check pressure of all tires and adjust if required.

At least once a month and before long trips, inspect each tire and check the tire pressure with a tire gauge (including spare, if equipped). Inflate all tires to the inflation pressure recommended by Ford Motor Company.

You are strongly urged to buy a reliable tire pressure gauge, as automatic service station gauges may be inaccurate. Ford recommends the use of a digital or dial-type tire pressure gauge rather than a stick-type tire pressure gauge.

Use the recommended cold inflation pressure for optimum tire performance and wear. Under-inflation or over-inflation may cause uneven treadwear patterns

### WARNING



Under-inflation is the most common cause of tire failures and may result in severe tire cracking, tread separation or blowout, with unexpected loss of vehicle control and increased risk of injury. Under-inflation increases sidewall flexing and rolling resistance, resulting in heat buildup and internal damage to the tire. It also may result in unnecessary tire stress, irregular wear, loss of vehicle control and accidents. A tire can lose up to half of its air pressure and not appear to be flat!

---

Always inflate your tires to the Ford recommended inflation pressure even if it is less than the maximum inflation pressure information found on the tire. The Ford recommended tire inflation pressure is found on the Safety Compliance Certification Label or Tire Label (affixed to either the door hinge pillar, door-latch post, or the door edge that meets the door-latch post, next to the driver's seating position), or Tire Label located on the B-pillar or the edge of the driver's door. Failure to follow the tire pressure recommendations can cause uneven treadwear patterns and adversely affect the way your vehicle handles

## Wheels and Tires

---

**Note:** *Do not reduce tire pressure to change the ride characteristics of the vehicle. If you do not maintain the inflation pressure at the levels specified by Ford, your vehicle may experience a condition known as shimmy. Shimmy is a severe vibration and oscillation in the steering wheel after the vehicle travels over a bump or dip in the road that does not dampen out by itself. Shimmy may result from significant under-inflation of the tires, improper tires (load range, size, or type), or vehicle modifications such as lift-kits. In the event that your vehicle experiences shimmy, you should slowly reduce speed by either lifting off the accelerator pedal or lightly applying the brakes. The shimmy will cease as the vehicle speed decreases.*

**Maximum Inflation Pressure** is the tire manufacturer's maximum permissible pressure and the pressure at which the maximum load can be carried by the tire. This pressure is normally higher than the manufacturer's recommended cold inflation pressure which can be found on the Safety Compliance Certification Label (affixed to either the door hinge pillar, door-latch post, or the door edge that meets the door-latch post, next to the driver's seating position), or Tire Label located on

the B-pillar or the edge of the driver's door. The cold inflation pressure should never be set lower than the recommended pressure on the Safety Compliance Certification Label or Tire Label.

When weather temperature changes occur, tire inflation pressures also change. A 10°F (6°C) temperature drop can cause a corresponding drop of 1 psi (7 kPa) in inflation pressure. Check your tire pressures frequently and adjust them to the proper pressure which can be found on the Safety Compliance Certification Label or Tire Label.

To check the pressure in your tire(s):

1. Make sure the tires are cool, meaning they are not hot from driving even a mile.

**Note:** *If you are checking tire pressure when the tire is hot, (for example, driven more than 1 mile [1.6 kilometers]), never bleed or reduce air pressure. The tires are hot from driving and it is normal for pressures to increase above recommended cold pressures. A hot tire at or below recommended cold inflation pressure could be significantly under-inflated.*

# Wheels and Tires

---

**Note:** *If you have to drive a distance to get air for your tire(s), check and record the tire pressure first and add the appropriate air pressure when you get to the pump. It is normal for tires to heat up and the air pressure inside to go up as you drive.*

2. Remove the cap from the valve on one tire, then firmly press the tire gauge onto the valve and measure the pressure.

3. Add enough air to reach the recommended air pressure.

**Note:** *If you overfill the tire, release air by pressing on the metal stem in the center of the valve. Then recheck the pressure with your tire gauge.*

4. Replace the valve cap.

5. Repeat this procedure for each tire, including the spare.

**Note:** *Some spare tires operate at a higher inflation pressure than the other tires. For T type mini-spare tires, (see the Dissimilar spare wheel and tire assembly information for a description. Store and maintain at 60 psi (4.15 bar). For full-size and dissimilar spare tires, see the Dissimilar spare wheel and tire assembly information for a description. Store and maintain at the higher of the front and rear inflation pressure as shown on the Safety Compliance Certification Label or Tire Label.*

6. Visually inspect the tires to make sure there are no nails or other objects embedded that could poke a hole in the tire and cause an air leak.

7. Check the sidewalls to make sure there are no gouges, cuts or bulges.

## Tire Inflation Information

### WARNING



An inflated tire and rim can be very dangerous if improperly used, serviced or maintained. To reduce the risk of serious injury, never attempt to re-inflate a tire which has been run flat or seriously under-inflated without first removing the tire from the wheel assembly for inspection. Do not attempt to add air to tires or replace tires or wheels without first taking precautions to protect persons and property.

---

All tires with Steel Carcass Plies (if equipped):

This type of tire utilizes steel cords in the sidewalls. As such, they cannot be treated like normal light truck tires. Tire service, including adjusting tire pressure, must be performed by personnel trained, supervised and equipped according to Federal Occupational Safety and Health Administration regulations. For example, during

## Wheels and Tires

any procedure involving tire inflation, the technician or individual must utilize a remote

inflation device, and ensure that all persons are clear of the trajectory area.

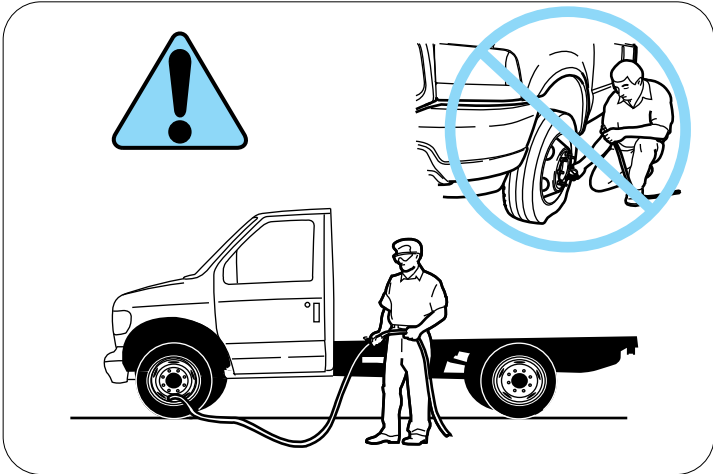

E161437

# Wheels and Tires

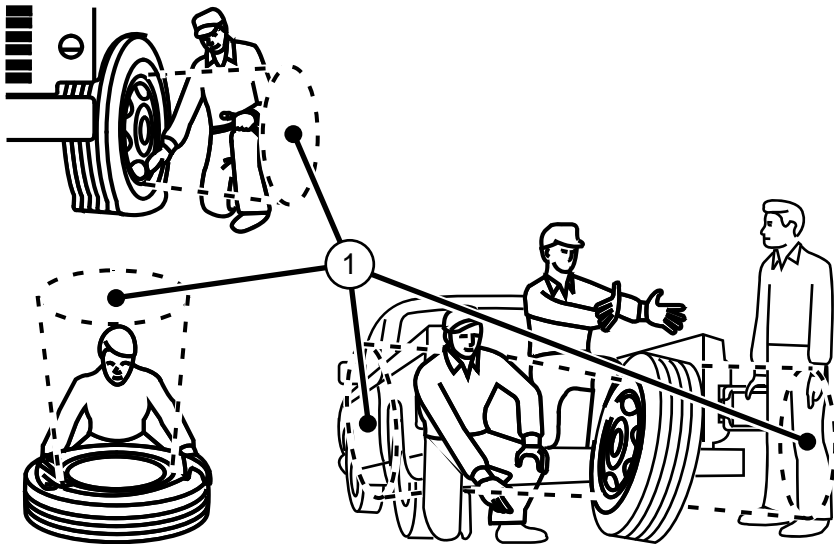

E161438

## WARNING



Stay out of the trajectory (1) as indicated in the illustration.

## Inspecting Your Tires and Wheel Valve Stems

Periodically inspect the tire treads for uneven or excessive wear and remove objects such as stones, nails or glass that may be wedged in the tread grooves. Check the tire and valve stems for holes, cracks, or cuts that may permit air leakage and repair or replace the tire and replace the valve stem. Inspect the tire sidewalls for cracking, cuts, bruises and other signs of damage or excessive

wear. If internal damage to the tire is suspected, have the tire demounted and inspected in case it needs to be repaired or replaced. For your safety, tires that are damaged or show signs of excessive wear should not be used because they are more likely to blow out or fail.

Improper or inadequate vehicle maintenance can cause tires to wear abnormally. Inspect all your tires, including the spare, frequently, and replace them if one or more of the following conditions exist:

# Wheels and Tires

## Tire Wear

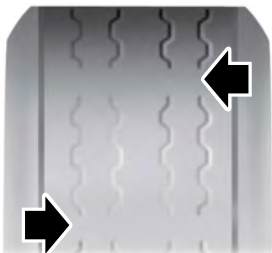

E142546

When the tread is worn down to one sixteenth of an inch (2 millimeters), tires must be replaced to help prevent your vehicle from skidding and hydroplaning. Built-in treadwear indicators, or wear bars, which look like narrow strips of smooth rubber across the tread will appear on the tire when the tread is worn down to one sixteenth of an inch (2 millimeters).

When the tire tread wears down to the same height as these wear bars, the tire is worn out and must be replaced.

## Damage

Periodically inspect the tire treads and sidewalls for damage (such as bulges in the tread or sidewalls, cracks in the tread groove and separation in the tread or sidewall). If damage is observed

or suspected have the tire inspected by a tire professional. Tires can be damaged during off-road use, so inspection after off-road use is also recommended.

## Age

### WARNING



Tires degrade over time depending on many factors such as weather, storage conditions, and conditions of use (load, speed, inflation pressure) the tires experience throughout their lives.

In general, tires should be replaced after six years regardless of tread wear. However, heat caused by hot climates or frequent high loading conditions can accelerate the aging process and may require tires to be replaced more frequently.

You should replace your spare tire when you replace the road tires or after six years due to aging even if it has not been used.

## U.S. DOT Tire Identification Number

Both United States and Canada Federal regulations require tire manufacturers to place standardized information on the sidewall of all tires. This information identifies and



# Wheels and Tires

describes the fundamental characteristics of the tire and also provides a U.S. DOT Tire Identification Number for safety standard certification and in case of a recall.

This begins with the letters DOT and indicates that the tire meets all federal standards. The next two numbers or letters are the plant code designating where it was manufactured, the next two are the tire size code and the last four numbers represent the week and year the tire was built. For example, the numbers 317 mean the 31st week of 1997. After 2000 the numbers go to four digits. For example, 2501 means the 25th week of 2001. The numbers in between are identification codes used for traceability. This information is used to contact customers if a tire defect requires a recall.

## Tire Replacement Requirements

Your vehicle is equipped with tires designed to provide a safe ride and handling capability.

### WARNINGS



Only use replacement tires and wheels that are the same size, load index, speed rating and type (such as P-metric versus LT-metric or all-season versus all-terrain) as those originally provided by Ford. The recommended tire and wheel size

### WARNINGS

may be found on either the Safety Compliance Certification Label or the Tire Label. If this information is not found on these labels then you should contact your authorized dealer as soon as possible. Use of any tire or wheel not recommended by Ford can affect the safety and performance of your vehicle, which could result in an increased risk of loss of vehicle control, vehicle rollover, personal injury and death. Additionally the use of non-recommended tires and wheels could cause steering, suspension, axle, transfer case or power transfer unit failure. If you have questions regarding tire replacement, contact your authorized dealer as soon as possible.



To reduce the risk of serious injury, when mounting replacement tires and wheels, you should not exceed the maximum pressure indicated on the sidewall of the tire to set the beads without additional precautions listed below. If the beads do not seat at the maximum pressure indicated, re-lubricate and try again

# Wheels and Tires

---

## WARNINGS

When inflating the tire for mounting pressures up to 20 psi (1.38 bar) greater than the maximum pressure on the tire sidewall, the following precautions must be taken to protect the person mounting the tire:

1. Make sure that you have the correct tire and wheel size.
2. Lubricate the tire bead and wheel bead seat area again.
3. Stand at a minimum of 12 feet (3.6 meters) away from the wheel and tire assembly.
4. Use both eye and ear protection.

For a mounting pressure more than 20 psi (1.38 bar) greater than the maximum pressure, a Ford dealer or other tire service professional should do the mounting.

Always inflate steel carcass tires with a remote air fill with the person inflating standing at a minimum of 12 feet (3.6 meters) away from the wheel and tire assembly

The two front tires or two rear tires should generally be replaced as a pair.

The tire pressure sensors mounted in the wheels are not designed to be used in aftermarket wheels.

The use of wheels or tires not recommended by Ford Motor Company may affect the operation of your tire pressure monitoring system.

If the tire pressure monitoring system indicator is flashing, the system is malfunctioning. Your replacement tire might be incompatible with your tire pressure monitoring system, or some component of the system may be damaged.

## Replacing a Tire That is Greenhouse Gas Certified

The tires installed on this vehicle at the factory as original equipment are certified for Greenhouse Gas and Fuel Efficiency regulations. Replacement tires must be of equal or lower rolling resistance level (TRRL or Crr). Consult with your tire supplier(s) for appropriate replacement tires.

---

**Important:** Remember to replace the wheel valve stems when the road tires are replaced on your vehicle

# Wheels and Tires

---

## Safety Practices

### WARNINGS



If your vehicle is stuck in snow, mud, or sand, do not rapidly spin the tires; spinning the tires can tear the tire and cause an explosion. A tire can explode in as little as three to five seconds.



Do not spin the wheels at over 35 mph (56 km/h). The tires may fail and injure a passenger or bystander.

---

## Driving habits have a great deal to do with your tire mileage and safety.

- \*Observe posted speed limits
- \*Avoid fast starts, stops and turns
- \*Avoid potholes and objects on the road
- \*Do not run over curbs or hit the tire against a curb when parking

## Highway Hazards

No matter how carefully you drive there's always the possibility that you may eventually have a flat tire on the highway. Drive slowly to the closest safe area out of traffic. This may further damage the flat tire, but your safety is more important.

If you feel a sudden vibration or ride disturbance while driving, or you suspect your tire or vehicle has been damaged, immediately reduce your speed. Drive with caution until you can safely pull off the road. Stop and inspect the tires for damage. If a tire is under-inflated or damaged, deflate it, remove wheel and replace it with your spare tire and wheel. If you cannot detect a cause, have the vehicle towed to the nearest repair facility or tire dealer to have the vehicle inspected.

## Tire and Wheel Alignment

A bad jolt from hitting a curb or pothole can cause the front end of your vehicle to become misaligned or cause damage to your tires. If your vehicle seems to pull to one side when you're driving, the wheels may be out of alignment. Have an authorized dealer check the wheel alignment periodically.

Wheel misalignment in the front or the rear can cause uneven and rapid treadwear of your tires and should be corrected by an authorized dealer. Front-wheel drive vehicles and those with an independent rear suspension may require alignment of all four wheels.

The tires should also be balanced periodically. An unbalanced tire and wheel assembly may result in irregular tire wear.

# Wheels and Tires

## Tire Rotation

### WARNING

 If the tire label shows different tire pressures for the front and rear tires and the vehicle is equipped with a tire pressure monitoring system, then the settings for the system sensors need to be updated. Always perform the system reset procedure after tire rotation. If the system is not reset, it may not provide a low tire pressure warning when necessary.

**Note:** *If your tires show uneven wear ask an authorized dealer to check for and correct any wheel misalignment, tire imbalance or mechanical problem involved before tire rotation.*

**Note:** *Your vehicle may be equipped with a dissimilar spare wheel and tire assembly. A dissimilar spare wheel and tire assembly is defined as a spare wheel and tire assembly that is different in brand, size or appearance from the road tires and wheels. If you have a dissimilar spare wheel and tire assembly it is intended for temporary use only and should not be used in a tire rotation.*

**Note:** *After having your tires rotated, inflation pressure must be checked and adjusted to the vehicle requirements.*

Rotating your tires at the recommended interval (as indicated in the Scheduled Maintenance chapter) will help your tires wear more evenly, providing better tire performance and longer tire life.

Rear-wheel drive vehicles and four-wheel drive vehicles (front tires at left of diagram)

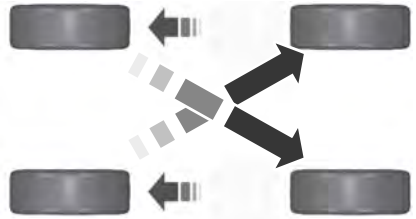

E142548

Dual rear wheel drive vehicle - six tire rotation (front tires at top of diagram)

# Wheels and Tires

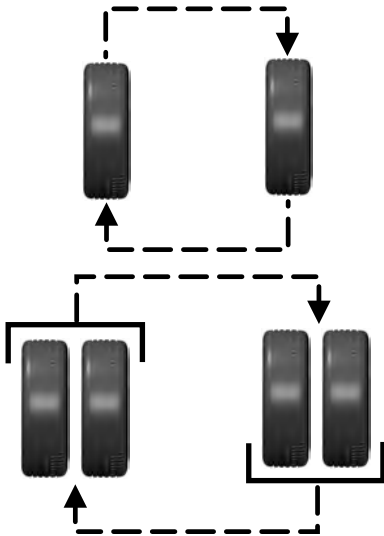

E166988

If your vehicle is equipped with dual rear wheels it is recommended that the front and rear tires (in pairs) be rotated only side to side. We do not recommend splitting up the dual rear wheels. Rotate them side to side as a set. After tire rotation, inflation pressures must be adjusted for the tires new positions in accordance with vehicle requirements.

Sometimes irregular tire wear can be corrected by rotating the tires.

## USING SNOW CHAINS

### WARNING



Snow tires must be the same size, load index, speed rating as those originally provided by Ford. Use of any tire or wheel not recommended by Ford can affect the safety and performance of your vehicle, which could result in an increased risk of loss of vehicle control, vehicle rollover, personal injury and death. Additionally, the use of non-recommended tires and wheels could cause steering, suspension, axle, transfer case or power transfer unit failure.

**Note:** Do not use snow chains on vehicles with 20 inch wheels and tires.

The tires on your vehicle have all-weather treads to provide traction in rain and snow. However, in some climates, you may need to use snow tires and cables. If you need to use cables, it is recommended that steel wheels (of the same size and specifications) be used, as cables may chip aluminum wheels.

**Note:** The suspension insulation and bumpers will help prevent vehicle damage. Do not remove these components from your vehicle when using snow tires and chains.

Follow these guidelines when using snow tires and chains:

- If possible, avoid fully loading your vehicle
- Use only SAE Class S chains.
- Install chains securely, verifying that the chains do not touch any wiring, brake lines or fuel lines.

# Wheels and Tires

- Drive cautiously. If you hear the chains rub or bang against your vehicle, stop and retighten the chains. If this does not work, remove the chains to prevent damage to your vehicle.
- Remove the tire chains when they are no longer needed. Do not use tire chains on dry roads.

If you have any questions regarding snow chains or cables, please contact your authorized dealer.

## TIRE PRESSURE MONITORING SYSTEM

### WARNING



Changes or modifications not expressly approved by the party responsible for compliance could void the user's authority to operate the equipment. The term "IC:" before the radio certifications number only signifies that Industry Canada technical specifications were met.



Each tire, including the spare (if provided), should be checked monthly when cold and inflated to the inflation pressure recommended by the vehicle manufacturer on the vehicle placard or tire inflation pressure label. (If your vehicle has tires of a different size than the size indicated on the vehicle placard or tire inflation pressure label, you should determine the proper tire inflation pressure for those tires.)

As an added safety feature, your vehicle has been equipped with a Tire Pressure Monitoring System (TPMS) that illuminates a low tire pressure telltale when one or more of your tires is significantly under-inflated. Accordingly, when the low tire pressure telltale illuminates, you should stop and check

your tires as soon as possible, and inflate them to the proper pressure. Driving on a significantly under-inflated tire causes the tire to overheat and can lead to tire failure. Under-inflation also reduces fuel efficiency and tire tread life, and may affect the vehicle's handling and stopping ability.

Please note that the TPMS is not a substitute for proper tire maintenance, and it is the driver's responsibility to maintain correct tire pressure, even if under-inflation has not reached the level to trigger illumination of the TPMS low tire pressure telltale.

Your vehicle has also been equipped with a TPMS malfunction indicator to indicate when the system is not operating properly. The TPMS malfunction indicator is combined with the low tire pressure telltale. When the system detects a malfunction, the telltale will flash for approximately one minute and then remain continuously illuminated. This sequence will continue upon subsequent vehicle start-ups as long as the malfunction exists.

When the malfunction indicator is illuminated, the system may not be able to detect or signal low tire pressure as intended. TPMS malfunctions may occur for a variety of reasons, including the installation of replacement or alternate tires or wheels on the vehicle that prevent the TPMS from functioning properly. Always check the TPMS malfunction telltale after replacing one or more tires or wheels on your vehicle to ensure that the replacement or alternate tires and wheels allow the TPMS to continue to function properly.

# Wheels and Tires

The tire pressure monitoring system complies with part 15 of the FCC rules and with RSS-210 of Industry Canada. Operation is subject to the following two conditions: (1) This device may not cause harmful interference, and (2) This device must accept any interference received, including interference that may cause undesired operation.

This device complies with part 15 of the FCC Rules and with Licence exempt RSS Standards of Industry Canada. Operation is subject to the following two conditions:

- This device may not cause harmful interference.
- This device must accept any interference received, including interference that may cause undesired operation.

## Changing Tires With a Tire Pressure Monitoring System



**Note:** Each road tire is equipped with a tire pressure sensor located inside the wheel and tire assembly cavity. The pressure sensor is attached to the valve stem. The pressure sensor is covered by the tire and is not visible unless the tire is removed. Take care when changing the tire to avoid damaging the sensor.

You should always have your tires serviced by an authorized dealer.

Check the tire pressure periodically (at least monthly) using an accurate tire gauge. See *Inflating Your Tires* in this chapter.

## Understanding Your Tire Pressure Monitoring System

The tire pressure monitoring system measures pressure in your four road tires and sends the tire pressure readings to your vehicle. The low tire pressure warning light will turn on if the tire pressure is significantly low. Once the light is illuminated, your tires are under-inflated and need to be inflated to the manufacturer's recommended tire pressure. Even if the light turns on and a short time later turns off, your tire pressure still needs to be checked.

## When Your Temporary Spare Tire is Installed

When one of your road tires needs to be replaced with the temporary spare, the system will continue to identify an issue to remind you that the damaged road wheel and tire assembly needs to be repaired and put back on your vehicle.

To restore the full function of the tire pressure monitoring system, have the damaged road wheel and tire assembly repaired and remounted on your vehicle.

## When You Believe Your System is Not Operating Properly

The main function of the tire pressure monitoring system is to warn you when your tires need air. It can also warn you in the event the system is no longer capable of functioning as intended. See the following chart for information concerning your tire pressure monitoring system:

## Wheels and Tires

<b>Low tire pressure warning light</b>	<b>Possible cause</b>	<b>Customer action required</b>
Solid warning light	Tire(s) under-inflated	Make sure tires are at the proper pressure. See <b>Inflating your tires</b> in this chapter. After inflating your tires to the manufacturer's recommended pressure as shown on the Tire Label (located on the edge of driver's door or the B-Pillar), the vehicle must be driven for at least two minutes over 20 mph (32 km/h) before the light turns off.
	Spare tire in use	Repair the damaged road wheel and tire assembly and reinstall it on the vehicle to restore system function. For a description on how the system functions, see <b>When your temporary spare tire is installed</b> in this section.
	Tire pressure monitoring system malfunction	If the tires are properly inflated and the spare tire is not in use but the light remains on, contact your authorized dealer as soon as possible.
	Tire rotation without sensor training	On vehicles with different front and rear tire pressures, the system must be retrained following every tire rotation. See <b>Tire Care</b> (page 265).
Flashing warning light	Spare tire in use	Repair the damaged road wheel and tire assembly and reinstall it on the vehicle to restore system function. For a description on how the system functions, see <b>When your temporary spare tire is installed</b> in this section.
	Tire pressure monitoring system malfunction	If the tires are properly inflated and the spare tire is not in use but the light remains on, contact your authorized dealer as soon as possible.



# Wheels and Tires

## When Inflating Your Tires

When putting air into your tires (such as at a gas station or in your garage), the tire pressure monitoring system may not respond immediately to the air added to your tires.

It may take up to two minutes of driving over 20 mph (32 km/h) for the light to turn off after you have filled your tires to the recommended inflation pressure.

## How Temperature Affects Your Tire Pressure

The tire pressure monitoring system monitors tire pressure in each pneumatic tire. While driving in a normal manner, a typical passenger tire inflation pressure may increase about 2 to 4 psi (14 to 28 kPa) from a cold start situation. If the vehicle is stationary overnight with the outside temperature significantly lower than the daytime temperature, the tire pressure may decrease about 3 psi (21 kPa) for a drop of 30°F (17°C) in ambient temperature. This lower pressure value may be detected by the tire pressure monitoring system as being significantly lower than the recommended inflation pressure and activate the system warning light for low tire pressure.

If the low tire pressure warning light is on, visually check each tire to verify that no tire is flat. If one or more tires are flat, repair as necessary. Check the air pressure in the road tires. If any tire is under-inflated, carefully drive the vehicle to the nearest location where air can be added to the tires. Inflate all the tires to the recommended inflation pressure.

## Tire Pressure Monitoring System Reset Procedure

### WARNING



To determine the required pressure(s) for your vehicle, see the Safety Compliance Certification Label (affixed to either the door hinge pillar, door-latch post, or the door edge that meets the door-latch post, next to the driver's seating position), or Tire Label located on the B-Pillar or the edge of the driver's door.

**Note:** *You need to perform the tire pressure monitoring system reset procedure after each tire rotation on vehicles that require different recommended tire pressures in the front tires as compared to the rear tires.*

### Overview

To provide the vehicle's load carrying capability, some vehicles require different recommended tire pressures in the front tires as compared to the rear tires. The tire pressure monitoring system equipped on these vehicles is designed to illuminate the low tire pressure warning light at two different pressures; one for the front tires and one for the rear tires.

Since tires need to be rotated to provide consistent performance and maximum tire life, the tire pressure monitoring system needs to know when the tires are rotated to determine which set of tires are on the front and which are on the rear. With this information, the system can detect and properly warn of low tire pressures.

System reset tips:

# Wheels and Tires

---

- To reduce the chances of interference from another vehicle, perform the system reset procedure at least three feet (one meter) away from another Ford Motor Company vehicle undergoing the system reset procedure at the same time.
- Do not wait more than two minutes between resetting each tire sensor or the system will time-out and the entire procedure will have to be repeated on all four wheels.
- A double horn will sound indicating the need to repeat the procedure.

## **Performing the System Reset Procedure**

Read the entire procedure before attempting.

1. Drive the vehicle above 20 mph (32 km/h) for at least two minutes, then park in a safe location where you can easily get to all four tires and have access to an air pump.
2. Place the ignition in the off position and keep the key in the ignition.
3. Cycle the ignition to the on position with the engine off.
4. Turn the hazard flashers on then off three times. You must accomplish this within 10 seconds. If the reset mode has been entered successfully, the horn will sound once, the system indicator will flash and a message is shown in the information display. If this does not occur, please try again starting at Step 2. If after repeated attempts to enter the reset mode, the horn does not sound, the system indicator does not flash and no message is shown in the information display, seek service from your authorized dealer.
5. Train the tire pressure monitoring system sensors in the tires using the following system reset sequence starting with the left front tire in the following clockwise order: Left front (driver's side front tire), Right front (passenger's side front tire), Right rear (passenger's side rear tire), Left rear (driver's side rear tire).
6. Remove the valve cap from the valve stem on the left front tire. Decrease the air pressure until the horn sounds.  
**Note:** The single horn chirp confirms that the sensor identification code has been learned by the module for this position. If a double horn is heard, the reset procedure was unsuccessful, and you must repeat it.
7. Remove the valve cap from the valve stem on the right front tire. Decrease the air pressure until the horn sounds.
8. Remove the valve cap from the valve stem on the right rear tire. Decrease the air pressure until the horn sounds.
9. Remove the valve cap from the valve stem on the left rear tire. Decrease the air pressure until the horn sounds. Training is complete after the horn sounds for the last tire trained (driver's side rear tire), the system indicator stops flashing, and a message is shown in the information display.
10. Turn the ignition off. If two short horn beeps are heard, the reset procedure was unsuccessful and you must repeat it. If after repeating the procedure and two short beeps are heard when the ignition is turned to off, seek assistance from your authorized dealer.

# Wheels and Tires

11. Set all four tires to the recommended air pressure as indicated on the Safety Compliance Certification Label (affixed to either the door hinge pillar, door-latch post, or the door edge that meets the door-latch post, next to the driver's seating position) or Tire Label located on the B-Pillar or the edge of the driver's door.

If your vehicle is equipped with the tire pressure monitoring system, have a flat serviced by an authorized dealer in order to prevent damage to the system sensors. See **Tire Pressure Monitoring System** (page 283). Replace the spare tire with a road tire as soon as possible. During repairing or replacing of the flat tire, have the authorized dealer inspect the system sensor for damage.

## CHANGING A ROAD WHEEL

### WARNINGS



The use of tire sealant may damage your tire pressure monitoring system and should only be used in roadside emergencies. If you must use a sealant, the Ford Tire Mobility Kit sealant should be used. The tire pressure monitoring system sensor and valve stem on the wheel must be replaced by an authorized dealer after use of the sealant.



If the tire pressure monitor sensor becomes damaged, it will no longer function. See **Tire Pressure Monitoring System** (page 283).

**Note:** *If your vehicle is equipped with the tire pressure monitoring system, the indicator light will illuminate when the spare tire is in use. To restore the full function of the monitoring system, all road wheels equipped with tire pressure monitoring sensors must be mounted on the vehicle.*

If you get a flat tire while driving, do not apply the brake heavily. Instead, gradually decrease your speed. Hold the steering wheel firmly and slowly move to a safe place on the side of the road.

## Dissimilar Spare Wheel and Tire Assembly Information

### WARNING



Failure to follow these guidelines could result in an increased risk of loss of vehicle control, injury or death.

If you have a dissimilar spare wheel and tire, then it is intended for temporary use only. This means that if you need to use it, you should replace it as soon as possible with a road wheel and tire assembly that is the same size and type as the road tires and wheels that were originally provided by Ford. If the dissimilar spare tire or wheel is damaged, it should be replaced rather than repaired.

A dissimilar spare wheel and tire assembly is defined as a spare wheel and tire assembly that is different in brand, size or appearance from the road tires and wheels and can be one of three types:

1. **T-type mini-spares:** This spare tire begins with the letter T for tire size and may have Temporary Use Only molded in the sidewall.
2. **Full-size dissimilar spare with label on wheel:** This spare tire has a label on the wheel that states: THIS WHEEL AND TIRE ASSEMBLY FOR TEMPORARY USE ONLY

When driving with one of the dissimilar spare tires listed above, do not:

# Wheels and Tires

- Exceed 50 mph (80 km/h)
- Load the vehicle beyond maximum vehicle load rating listed on the Safety Compliance Label.
- Tow a trailer.
- Use snow chains on the end of the vehicle with the dissimilar spare tire.
- Use more than one dissimilar spare tire at a time.
- Use commercial car washing equipment.
- Try to repair the dissimilar spare tire.

Use of one of the dissimilar spare tires listed above at any one wheel location can lead to impairment of the following:

- Handling, stability and braking performance.
- Comfort and noise.
- Ground clearance and parking at curbs.
- Winter weather driving capability.
- Wet weather driving capability.
- All-wheel driving capability.

### 3. Full-size dissimilar spare without label on wheel

When driving with the full-size dissimilar spare wheel and tire assembly, do not:

- Exceed 70 mph (113 km/h).
- Use more than one dissimilar spare wheel and tire assembly at a time.

- Use commercial car washing equipment.
- Use snow chains on the end of the vehicle with the dissimilar spare wheel and tire assembly.

The usage of a full-size dissimilar spare wheel and tire assembly can lead to impairment of the following:

- Handling, stability and braking performance.
- Comfort and noise.
- Ground clearance and parking at curbs.
- Winter weather driving capability.
- Wet weather driving capability.
- All-wheel driving capability.

When driving with the full-size dissimilar spare wheel and tire assembly additional caution should be given to:

- Towing a trailer.
- Driving vehicles equipped with a camper body.
- Driving vehicles with a load on the cargo rack.

Drive cautiously when using a full-size dissimilar spare wheel and tire assembly and seek service as soon as possible.

### Location of the Spare Tire and Tools

If your vehicle is equipped with a spare tire, jack and associated tools, see the following table for their locations:

Tool	Location
Spare tire (pick-up trucks only)	Under the vehicle, just forward of the rear bumper
Jack	Regular cab and Crew Cab: Fastened to floor pan behind rearmost seat on passenger side

# Wheels and Tires

Tool	Location
	SuperCab: Under rear bench seat on passenger side
Jack handle, lug wrench, lug wrench extension (only available on dual rear wheel vehicles) and wheel chock (only available on single rear wheel vehicles equipped with a diesel engine)	Regular cab: Fastened to floor behind driver seat SuperCab: Fastened to floor under rear seat Crew Cab: Fastened to floor behind rear seat at driver side
Key and spare tire lock	In the glove box

## Removing the Spare Tire (With Spare Tire Carrier Only)

The following tools are required to remove the spare tire:

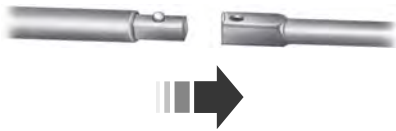

E162795

One handle extension and two typical extensions. To assemble, align the button with the hole and slide the parts together.

To disconnect, press the button and pull apart.

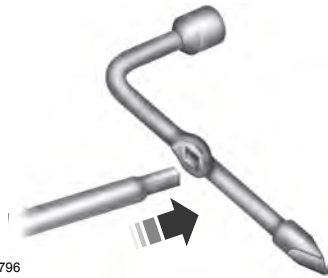

E162796

One wheel nut wrench. Slide over the square end of the jack handle.



E162797

**Note:** For vehicles with dual rear wheels, insert the lug wrench extension into the lug wrench to reach the lug nuts.

# Wheels and Tires

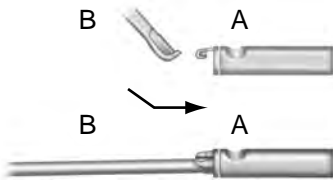

E162798

1. Attach the spare tire lock key (A) to the jack handle (B).



E162799

2. Fully insert the jack handle (with one extension) through the bumper hole and into the guide tube. The key and lock will engage with a slight push and counterclockwise turn. You will feel some resistance when you turn the jack handle assembly.
3. Turn the handle counterclockwise and lower the spare tire until you can slide the tire rearward and the cable is slack.
4. Remove the retainer through the center of the wheel. If your vehicle is equipped with a tether, perform the following steps.

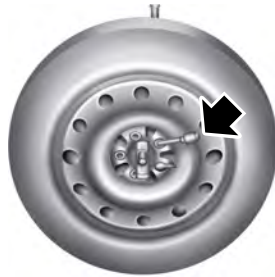



E162800

5. Lift the spare tire on end to access the tether attachment.
6. Use the lug wrench to remove the lug nut from the spare tire tether.
7. If not replacing the spare or flat tire to the underbody storage area, raise the wheel retainer up into the installed position.
8. Use the attached fastener strap (on the spare tire tether) to attach the tether end to the winch retainer prior to raising to the installed position.

## Tire Change Procedure

### WARNINGS

-  When one of the front wheels is off the ground, the transmission alone will not prevent the vehicle from moving or slipping off the jack, even if the transmission is in park (P).
-  To help prevent the vehicle from moving when you change a tire, be sure to place the transmission in park (P), set the parking brake and block (in both directions) the wheel that is diagonally opposite (other side and end of the vehicle) to the tire being changed.
-  Never get underneath a vehicle that is supported only by a jack. If the vehicle slips off the jack, you or someone else could be seriously injured.

# Wheels and Tires

## WARNINGS



Do not attempt to change a tire on the side of the vehicle close to moving traffic. Pull far enough off the road to avoid the danger of being hit when operating the jack or changing the wheel.



Always use the jack provided as original equipment with your vehicle. If using a jack other than the one provided as original equipment with your vehicle, make sure the jack capacity is adequate for the vehicle weight, including any vehicle cargo or modifications.

**Note:** *Passengers should not remain in the vehicle when the vehicle is being jacked.*

Park on a level surface, set the parking brake and activate the hazard flashers.

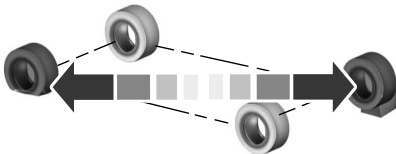

E142551

1. Turn the engine off and block the wheel that is diagonally opposite of the flat tire using the wheel chock. **Note:** Lock the manual hub on the wheel if the vehicle is a 4x4.
2. Remove the jack, jack handle, lug wrench and spare tire from the stowage locations.
3. Use the tip of the lug wrench to remove any wheel trim.
4. Loosen each wheel lug nut  $\frac{1}{2}$  turn counterclockwise, but do not remove them until the wheel is raised off the ground.

## F-250 and F-350 Single Rear Wheel Vehicles



E162801

1. Insert the hooked end of the jack handle into the jack and use the handle to slide the jack under the vehicle.
2. Position the jack according to the following guides:



E162802

Front (4x2).

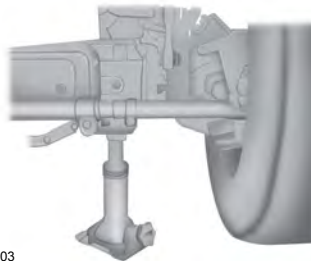

E162803

Front driver side (4x4).

# Wheels and Tires

**Note:** Make sure the jack fits onto the flat area on the outboard side of the differential.

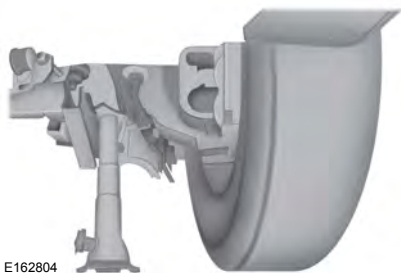

E162804

Front passenger side (4x4).

**Note:** View shown from the rear of the vehicle to clearly identify the jack point. Place the jack directly under the axle.

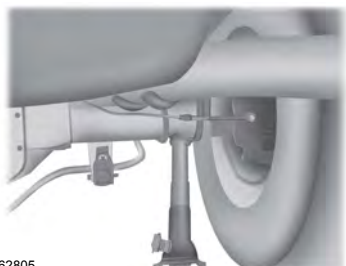

E162805

Rear

**Note:** Jack at the specified locations to avoid damage to the vehicle.

## Jacking the Vehicle



E162811

1. Turn the jack handle clockwise until the wheel is completely off the ground and high enough to install the spare tire.
2. Remove the lug nuts with the lug wrench.
3. Replace the flat tire with the spare tire, making sure the valve stem is facing outward for all front wheels and single rear wheel vehicles. If you are replacing an inboard rear tire on dual rear wheel vehicles, the valve stem must be facing outward. If you are replacing the outboard wheel, the valve stem must be facing inward. Reinstall the lug nuts until the wheel is snug against the hub. Do not fully tighten the lug nuts until the wheel has been lowered.
4. Lower the wheel by turning the jack handle counterclockwise.
5. Remove the jack and fully tighten the lug nuts in the order shown. See **Technical Specifications** (page 299).
6. Stow the flat tire. See Stowing the flat or spare tire if the vehicle is equipped with a spare tire carrier.
7. Stow the jack, jack handle and lug wrench. Make sure the jack is securely fastened so it does not rattle when driving.
8. Unblock the wheels.



# Wheels and Tires



E161441

8-lug nut torque sequence.



E169375

10-lug nut torque sequence.

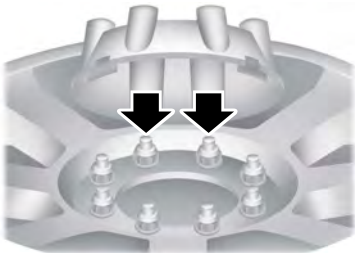

E162820

When installing the wheel center ornaments, make sure that the ornament retention towers on the back side of the ornament are aligned with the studs or lug nuts. The retention towers are designed to be installed over the studs or nuts and retain to the flange on the lug nut.

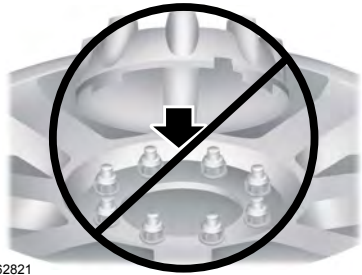

E162821

If the ornament retention towers are aligned between the studs or lug nuts, the ornament is improperly installed. This improper installation may appear and sound correct, but will not keep the ornament on the vehicle. Ornaments improperly installed in this manner will fall off or become loose with minimal force or impact.

## F-350 Dual Rear Wheel, F-450 and F-550 Vehicles



E162812

1. Slide the notched end of the jack handle over the release valve and use the handle to slide the jack under the vehicle. Make sure the valve is closed by turning it clockwise.
2. Position the jack according to the following guides:

# Wheels and Tires

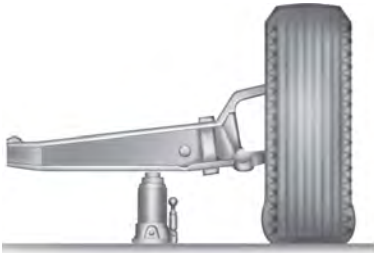

E162813

Front (4x2): F-350 dual rear wheel.

**Note:** Place the jack directly under the I-beam.

**Note:** View shown from the rear of the vehicle to clearly identify the jack point.

**Note:** Place the jack directly under the axle and inboard of the radius arm so that the jack clears the radius arm.

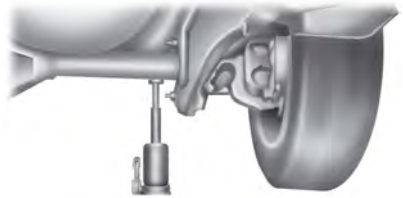

E162816

Front: F-450 and F-550.

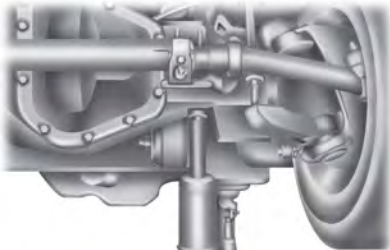

E162814

Front driver side (4x4): F-350 dual rear wheel.

**Note:** Make sure the jack fits onto the flat area on the outboard side of the differential housing.

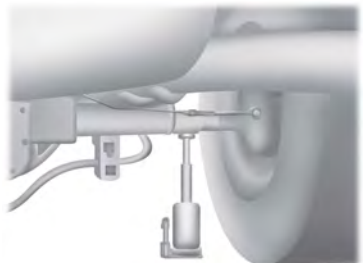

E162817

Rear: F-350 dual rear wheel.

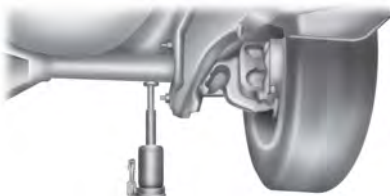

E162815

Front passenger side (4x4): F-350 dual rear wheel.

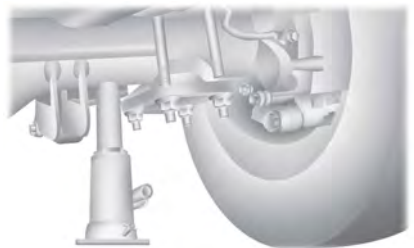

E162818

Rear: F-450 and F-550.

# Wheels and Tires

## Jacking the Vehicle

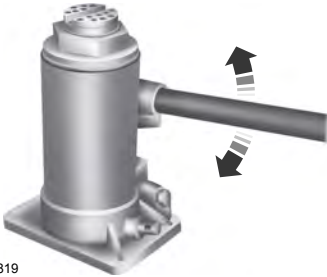

E162819

1. Insert the jack handle into the pump linkage.
2. Use an up-and-down motion with the jack handle to raise the wheel completely off the ground.

**Note:** Hydraulic jacks are equipped with a pressure release valve that prevents lifting loads which exceed the jack's rated capacity.

3. Remove the lug nuts with the lug wrench.
4. Replace the flat tire with the spare tire, making sure the valve stem is facing outward on all front and inboard rear wheels. If you are replacing the outboard wheel, the valve stem must be facing inward. Reinstall the lug nuts until the wheel is snug against the hub. Do not fully tighten the lug nuts until the wheel has been lowered.
5. Lower the wheel by slowly turning the release valve counterclockwise. Opening the release valve slowly will provide a more controlled rate of descent.
6. Remove the jack and fully tighten the lug nuts in the order shown. See **Technical Specifications** (page 299).
7. Stow the flat tire. See Stowing the flat or spare tire if the vehicle is equipped with a spare tire carrier.

8. Stow the jack, jack handle and lug wrench. Make sure the jack is securely fastened so it does not rattle when driving.
9. Unblock the wheels.



E161441

8-lug nut torque sequence.



E169375

10-lug nut torque sequence.

## Installing Dual Rear Wheel Ornaments

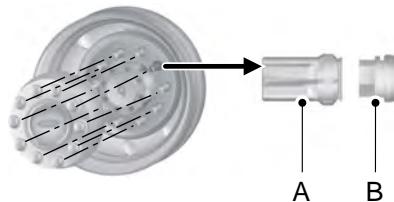

E162822

# Wheels and Tires

1. Align the ornament with the lug nuts. A is the clip and B is the flange.



E162823

2. Hold the ornament so that all of the retention clips are sitting on the flange of the lug nuts.

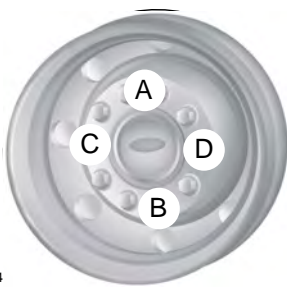

E162824

3. Use your hand or rubber mallet to tap the ornament in a star pattern. There should be an even gap between the ornament and the wheel.
4. Be sure to install all the clips on the nuts over the flanges so that there is an even gap all around and the retention clips are fully seated.



E162825



E162826

## Stowing the Flat or Spare Tire

**Note:** Failure to follow spare tire stowage instructions may result in failure of cable or loss of spare tire.

**Note:** If you are stowing a tire that requires reattaching it to the vehicle with a tether, perform these steps first, then proceed with the following steps.

1. Place the tire on end with the valve stem facing toward the front of the vehicle.
2. Place the tether into the bolt holes in the wheel and attach the lug nut using the lug wrench.

## Wheels and Tires

---

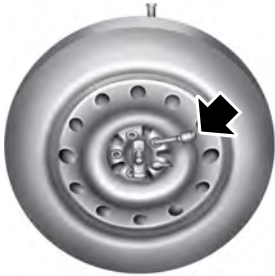

E162800

3. Lay the tire on the ground with the valve stem facing up.
4. Slide the wheel partially under the vehicle and install the retainer through the wheel center. Pull on the cable to align the components at the end of the cable.
5. Turn the jack handle clockwise until the tire is raised to its stowed position underneath the vehicle. The effort to turn the jack handle increases significantly and the spare tire carrier ratchets or slips when the tire is raised to the maximum tightness. Tighten to the best of your ability, to the point where the ratchet/slip occurs, if possible. The spare tire carrier will not allow you to overtighten. If the spare tire carrier ratchets or slips with little effort, take the vehicle to your authorized dealer for assistance at your earliest convenience.
6. Check that the tire lies flat against the frame and is properly tightened. Try to push or pull, then turn the tire to be sure it will not move. Loosen and retighten, if necessary. Failure to properly stow the spare tire may result in failure of the winch cable and loss of the tire.
7. Repeat this tightness check procedure when servicing the spare tire pressure (every six months, per scheduled maintenance information), or at any time that the spare tire is disturbed through service of other components.
8. If removed, install the spare tire lock into the bumper drive tube with the spare tire lock key and jack handle.

# Wheels and Tires

## TECHNICAL SPECIFICATIONS

### Wheel Lug Nut Torque Specifications

#### WARNING



When a wheel is installed, always remove any corrosion, dirt or foreign materials present on the mounting surfaces of the wheel or the surface of the wheel hub, brake drum or brake disc that contacts the wheel. Make sure that any fasteners that attach the rotor to the hub are secured so they do not interfere with the mounting surfaces of the wheel. Installing wheels without correct metal-to-metal contact at the wheel mounting surfaces can cause the wheel nuts to loosen and the wheel to come off while the vehicle is in motion, resulting in loss of control.

Bolt size	lb.ft (Nm)
M14 x 1.5	165 lb.ft (224 Nm)

\*Torque specifications are for nut and bolt threads free of dirt and rust. Use only Ford recommended replacement fasteners.

On vehicles equipped with single rear wheels, retighten the lug nuts to the specified torque at 100 miles (160 kilometers) after any wheel disturbance (such as tire rotation, changing a flat tire, wheel removal).

On vehicles equipped with dual rear wheels, retighten the wheel lug nuts to the specified torque at 100 miles (160 kilometers), and again at 500 miles (800 kilometers) of new vehicle operation and after any wheel disturbance (such as tire rotation, changing a flat tire, wheel removal).

It is important to follow the proper wheel mounting and lug nut torque procedures.

On all two-piece flat wheel nuts, apply one drop of motor oil between the flat washer and the nut. Do not apply motor oil to the wheel nut threads or the wheel stud threads.



E161443

# Wheels and Tires

---



E145950

A Wheel pilot bore

Inspect the wheel pilot hole and mounting surface prior to installation. Remove any visible corrosion or loose particles.

# Capacities and Specifications

## ENGINE SPECIFICATIONS

Engine	6.2L V8 Engine	6.8L V10 Engine
Cubic inches	378	413
Required fuel	Minimum 87 octane	Minimum 87 octane
Firing order	1-5-4-8-6-3-7-2	1-6-5-10-2-7-3-8-4-9
Ignition system	Coil on plug	Coil on plug
Spark plug gap	0.041-0.047 inch (1.04-1.20 mm)	0.039-0.043 inch (1.00-1.10mm)
Compression ratio	9.8:1	9.2:1

### Drivebelt Routing

#### 6.2L Engines

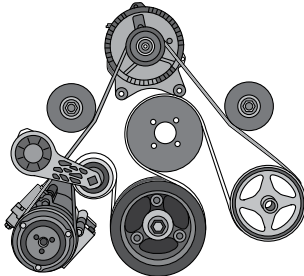

#### 6.8L Engines with A/C



#### 6.8L Engines without A/C





# Capacities and Specifications

## MOTORCRAFT PARTS

Component	6.2L V8 engine	6.8L V10 engine
Air filter element	FA-1883	FA-1883
Oil filter	FL-820-S	FL-820-S
Battery (standard)	BXT-65-650	BXT-65-650
Battery (optional)	BXT-65-750	BXT-65-750
Spark plugs-platinum	CYFS12FP/SP-526	HJFS-24FP/SP-509
Seat filter	FS-104	FS-104
Windshield wiper blade	WW-2201-P	WW-2201-P

For scheduled maintenance, we recommend Motorcraft replacement parts available at your Ford dealer or at [fordparts.com](http://fordparts.com). These parts meet or exceed Ford Motor Company's specifications and are engineered for your vehicle. Use of other parts may impact vehicle performance, emissions and durability. Your warranty may be void for any damage related to use of other parts.

If a Motorcraft oil filter is not available, use an oil filter that meets industry performance specification SAE/USCAR-36.

For spark plug replacement, contact an authorized dealer. Replace the spark plugs at the appropriate intervals. See **Scheduled Maintenance** (page 457).

# Capacities and Specifications

## VEHICLE IDENTIFICATION NUMBER

The vehicle identification number is located on the left-hand side of the instrument panel.

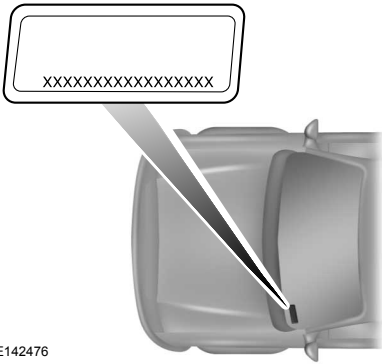

E142476

Please note that in the graphic, XXXX is representative of your vehicle identification number.

The Vehicle Identification Number contains the following information:

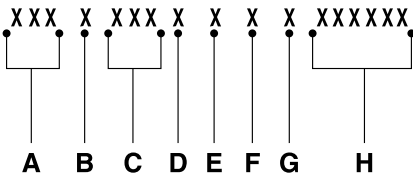

E142477

- A World manufacturer identifier
- B Brake system, Gross Vehicle Weight Rating, Restraint Devices and their locations

- C Make, vehicle line, series, body type
- D Engine type
- E Check digit
- F Model year
- G Assembly plant
- H Production sequence number

## VEHICLE CERTIFICATION LABEL

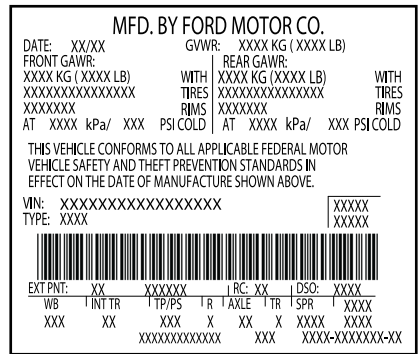

E167469

The National Highway Traffic Safety Administration Regulations require that a Safety Compliance Certification Label be affixed to a vehicle and prescribe where the Safety Compliance Certification Label may be located. The Safety Compliance Certification Label shall be affixed to either the door hinge pillar, the door latch post, or the edge of the door near the door latch, next to the driver's seating position.

# Capacities and Specifications

## TRANSMISSION CODE DESIGNATION

The transmission code is on the Safety Compliance Certification Label. The following table shows the transmission code along with the transmission description.

MFD. BY FORD MOTOR CO.

DATE: XX/XX      GVWR: XXXX KG (XXXX LB)  
 FRONT GAWR:      REAR GAWR:  
 XXXX KG (XXXX LB)      WITH XXXX KG (XXXX LB)      WITH  
 XXXXXXXXXXXXXXXX      TIRES XXXXXXXXXXXXXXXX      TIRES  
 XXXXXXXX      RIMS XXXXXXXX      RIMS  
 AT XXXX kPa/ XXX PSI COLD      AT XXXX kPa/ XXX PSI COLD

THIS VEHICLE CONFORMS TO ALL APPLICABLE FEDERAL MOTOR  
 VEHICLE SAFETY AND THEFT PREVENTION STANDARDS IN  
 EFFECT ON THE DATE OF MANUFACTURE SHOWN ABOVE.

VIN: XXXXXXXXXXXXXXXXXXXX      XXXXX  
 TYPE: XXXX      XXXXX



EXT PNT: XX      XXXXX      RC: XX      DSO: XXXX  
 WB INT TR TP/PS TR AXLE TR SPR XXXX XXXX  
 XXX XX      XXX X XX X XXXX XXXX  
 XXXXXXXXXXXXX      X      XXXX-XXXXXX-XX

↑

E167814

Description	Code
Five-speed automatic transmission 5R110W	T
Six-speed automatic transmission 6R140	P
Six-speed automatic transmission 6R140W	W

# Capacities and Specifications

## TECHNICAL SPECIFICATIONS

Item	Capacity	Ford part name or equivalent	Ford part number / Ford specification
Front axle	5.8 pints (2.8L)	Motorcraft SAE 80W-90 Premium Rear Axle Lubricant	XY-80W90-QL / WSP-M2C197-A
Spindle bearing	—	High Temperature 4X4 Front Axle and Wheel Bearing Grease	XG-11 / WSS-M1C267-A1
Rear axle - F-250/350 (10.50 inch axle) <sup>1</sup>	6.9 pints (3.3L)	Motorcraft SAE 75W-140 Synthetic Rear Axle Lubricant	XY-75W140-QL (U.S.) / WSL-M2C192-A
			CXY-75W140-1L (Canada) / WSL-M2C192-A
Rear axle - F-350 (Dana M80)	8.5 pints (4.0L)	Motorcraft SAE 75W-90 Synthetic Rear Axle Lubricant	XY-75W90-QLS / WSS-M2C918-A
Rear axle - F-450/550 (Dana S110/S130)	14.0 pints (6.6L)	Motorcraft SAE 75W-140 Synthetic Rear Axle Lubricant	XY-75W140-QL (U.S.) / WSL-M2C192-A
			CXY-75W140-1L (Canada) / WSL-M2C192-A
Brake fluid <sup>2</sup>	Between MIN/MAX on brake fluid reservoir	Motorcraft High Performance DOT 3 LV Motor Vehicle Brake Fluid	PM-1-C (U.S.) / WSS-M6C65-A1
		Motorcraft High Performance DOT 4 LV Motor Vehicle Brake Fluid	CPM-1-C (Canada) / WSS-M6C65-A1
Engine coolant (6.2L V8) <sup>3</sup>	21.3 qt (20.2 L)	Motorcraft Orange Antifreeze/Coolant Prediluted	VC-3DIL-B (U.S.) / WSS-M97B44-D2
			CVC-3DIL-B (Canada) /

## Capacities and Specifications

Item	Capacity	Ford part name or equivalent	Ford part number / Ford specification
			WSS-M97B44-D2
Engine coolant (6.8L V10) <sup>3</sup>	26.7 qt (25.3 L)	Motorcraft Orange Antifreeze/Coolant Prediluted	VC-3DIL-B (U.S.) / WSS-M97B44-D2
			CVC-3DIL-B (Canada) / WSS-M97B44-D2
Engine and fuel coolant (diesel engine)	Refer to the diesel supplement.		
Engine oil (6.2L V8 and 6.8L V10 gasoline engines) <sup>4,5,6</sup>	7.0 qt (6.6 L)	Motorcraft SAE 5W-20 Premium Synthetic Blend Motor Oil or Motorcraft SAE 5W-20 Full Synthetic Motor Oil (U.S.)	XO-5W20-QSP or XO-5W20-QFS (U.S.) / WSS-M2C945-A
		Motorcraft SAE 5W-20 Super Premium Motor Oil or Motorcraft SAE 5W-20 Synthetic Motor Oil (Canada)	CXO-5W20-LSP12 or CXO-5W20-LFS12 (Canada) / WSS-M2C945-A
Engine oil (Diesel engines)	Refer to the diesel supplement.		
Fuel tank (incomplete vehicle, steel tank, middle location)	28 gal (106 L)	—	—
Fuel tank (pickup with gasoline engine)	35 gal (132 L)	—	—
Fuel tank (incomplete vehicle, steel tank, aft axle location)	40 gal (151 L)	—	—
Fuel tank (Diesel engines)	Refer to the diesel supplement.		
Hinges, latches, striker plates and rotors, seat tracks, fuel filler door hinge and spring	—	Multi-Purpose Grease (Lithium grease)	Motorcraft XL-5 (aerosol) or CRCSL3151ESB / ESB-MIC93-B

## Capacities and Specifications

Item	Capacity	Ford part name or equivalent	Ford part number / Ford specification
Lock cylinders	—	Motorcraft Penetrating and Lock Lubricant	XL-1 / —
Transmission, parking brake linkages and pivots, brake pedal shift	—	Motorcraft Premium Long-Life Grease	XG-1-E / WSD-M1C227-A
Power steering fluid	—	Motorcraft MERCON LV	XT-10-QLV / Automatic transmission MERCON LV
Transfer case fluid	2.0 qt (1.9 L)	Motorcraft Transfer Case Fluid	XL-12 / ESP-M2C166-H
Automatic transmission fluid (5-speed) <sup>7,8,9</sup>	17.5 qt (16.6 L)	Motorcraft MERCON LV	XT-10-QLV / Automatic transmission MERCON LV
Automatic transmission fluid (6-speed) <sup>7,8,9</sup>	16.7 qt (15.8 L)		
Windshield washer fluid	Fill as required	Motorcraft Premium Windshield Washer Concentrate With Bitterant (U.S.)	ZC-32-B2 (U.S.) / WSB-M8B16-A2
		Premium Quality Windshield Wash (Canada)	CXC-37-(A, B, D, and F) (Canada) / WSB-M8B16-A2
Air conditioning refrigerant <sup>10</sup> (Gasoline engines)	1.81 lb (0.82 kg)	Motorcraft R-134a Refrigerant	YN-19 (U.S.) / WSH-M17B19-A
			CYN-16-R (Canada) / WSH-M17B19-A
Air conditioning refrigerant <sup>10</sup> (Diesel engines)	1.63 lb (0.74 kg)	Motorcraft R-134a Refrigerant	YN-19 (U.S.) / WSH-M17B19-A
			CYN-16-R (Canada) / WSH-M17B19-A
Air conditioning refrigerant compressor oil <sup>10</sup> (Gasoline engines)	4.23 fl oz (125.09 ml)	Motorcraft PAG Refrigerant Compressor Oil	YN-12-D /

## Capacities and Specifications

---

<b>Item</b>	<b>Capacity</b>	<b>Ford part name or equivalent</b>	<b>Ford part number / Ford specification</b>
Air conditioning refrigerant compressor oil <sup>10</sup> (Diesel engines)	3.53 fl oz (104.39 ml)		WSH-M1C231-B

# Capacities and Specifications

---

<sup>1</sup>Add 8 oz. (236 ml) of Additive Friction Modifier XL-3 or equivalent meeting Ford Specification EST-M2C118-A for complete refill of limited slip Ford axles. Ford design rear axles contain a synthetic lubricant that does not require changing unless you submerge the axle in water.

<sup>2</sup>Ford recommends using Motorcraft (Ford) DOT 3 LV High Performance Motor Vehicle Brake Fluid, Motorcraft (Ford) DOT 4 LV High Performance Motor Vehicle Brake Fluid or equivalent meeting WSS-M6C65-A1 or WSS-M6C65-A2. Use of any fluid other than the recommended fluid may cause degraded brake performance and not meet the Ford performance standards. Keep brake fluid clean and dry. Contamination with dirt, water, petroleum products or other materials may result in brake system damage and possible failure.

<sup>3</sup>Add the coolant type originally equipped in your vehicle.

<sup>4</sup>Ford has designed your engine to use Motorcraft engine oils or equivalent oils that meet Ford's specification. It is also acceptable to use an engine oil of recommended viscosity grade that meets API SN requirements and displays the API Certification Mark for gasoline engines.

<sup>5</sup>Do not use oils labeled as API SN unless the label also display the API certification mark. These oils do not meet the requirements of your vehicles engine and emissions system.

<sup>6</sup>Do not use supplemental engine oil additives. They are unnecessary and could lead to engine damage not covered by your Ford warranty.

<sup>7</sup>Use the correct automatic transmission fluid. Transmission fluid requirements are indicated on the dipstick blade or the dipstick handle. Check the container to verify the fluid you are adding is of the correct type. Refer to your scheduled maintenance information to determine the correct service interval.

**Note:** *Automatic transmissions that require MERCON LV should only use MERCON LV fluid. Use of any fluid other than the recommended fluid may cause transmission damage.*

<sup>8</sup>Indicates only approximate dry-fill capacity. Some applications may vary based on cooler size and if equipped with an in-tank cooler. You should set the amount of transmission fluid and fluid level by the indication on the dipstick's normal operating range.

<sup>9</sup>Fill to the proper capacity according to dipstick Type A. For correct dipstick type, See **Automatic Transmission Fluid Check** (page 240).

<sup>9</sup>Fill to the proper capacity according to dipstick Type B. For correct dipstick type, See **Automatic Transmission Fluid Check** (page 240).

<sup>10</sup>See the Warning below:

## WARNING



The air conditioning refrigerant system contains refrigerant R-134a under high pressure. Opening the air conditioning refrigerant system can cause personal injury. Have the air conditioning refrigerant system serviced only by qualified personnel.

---



# Audio System

## GENERAL INFORMATION

### Radio Frequencies and Reception Factors

AM and FM frequencies are established by the Federal Communications Commission (FCC) and the Canadian Radio and Telecommunications Commission (CRTC). Those frequencies are:

- AM: 530, 540-1700, 1710 kHz
- FM: 87.9-107.7, 107.9 MHz

Radio Reception Factors	
<b>Distance and strength</b>	The further you travel from an AM or FM station, the weaker the signal and the weaker the reception.
<b>Terrain</b>	Hills, mountains, tall buildings, bridges, tunnels, freeway overpasses, parking garages, dense tree foliage and thunderstorms can interfere with the reception.
<b>Station overload</b>	When you pass a ground-based broadcast repeating tower, a stronger signal may overtake a weaker one and result in the audio system muting.

### CD and CD Player Information

**Note:** *CD units play commercially pressed 4.75-inch (12 centimeter) audio compact discs only. Due to technical incompatibility, certain recordable and re-recordable compact discs may not function correctly when used in Ford CD players.*

**Note:** *Do not insert CDs with homemade paper (adhesive) labels into the CD player as the label may peel and cause the CD to become jammed. You should use a permanent felt tip marker rather than adhesive labels on your homemade CDs. Ballpoint pens may damage CDs. Please contact an authorized dealer for further information.*

**Note:** *Do not use any irregularly shaped discs or discs with a scratch protection film attached.*

Always handle discs by their edges only. Clean the disc with an approved CD cleaner only. Wipe it from the center of the disc toward the edge. Do not clean in a circular motion.

Do not expose discs to direct sunlight or heat sources for extended periods.

### MP3 Track and Folder Structure

Audio systems capable of recognizing and playing MP3 individual tracks and folder structures work as follows:

- There are two different modes for MP3 disc playback: MP3 track mode (system default) and MP3 folder mode.
- MP3 track mode ignores any folder structure on the MP3 disc. The player numbers each MP3 track on the disc (noted by the .mp3 file extension) from T001 to a maximum of T255. The maximum number of playable MP3 files may be less depending on the structure of the CD and exact model of radio present.

# Audio System

- MP3 folder mode represents a folder structure consisting of one level of folders. The CD player numbers all MP3 tracks on the disc (noted by the .mp3 file extension) and all folders containing MP3 files, from F001 (folder) T001 (track) to F253 T255.
- Creating discs with only one level of folders helps with navigation through the disc files.

If you are burning your own MP3 discs, it is important to understand how the system reads the structures you create. While various files may be present, (files with extensions other than mp3), only files with the .mp3 extension are played; other files are ignored by the system. This enables you to use the same MP3 disc for a variety of tasks on your work computer, home computer and your in-vehicle system.

In track mode, the system displays and plays the structure as if it were only one level deep (all .mp3 files play, regardless of being in a specific folder). In folder mode, the system only plays the .mp3 files in the current folder.

## AUDIO UNIT - VEHICLES WITH: AM/FM

### WARNING



Driving while distracted can result in loss of vehicle control, crash and injury. We strongly recommend that you use extreme caution when using any device that may take your focus off the road. Your primary responsibility is the safe operation of your vehicle. We recommend against the use of any hand-held device while driving and encourage the use of voice-operated systems when possible. Make sure you are aware of all applicable local laws that may affect the use of electronic devices while driving.

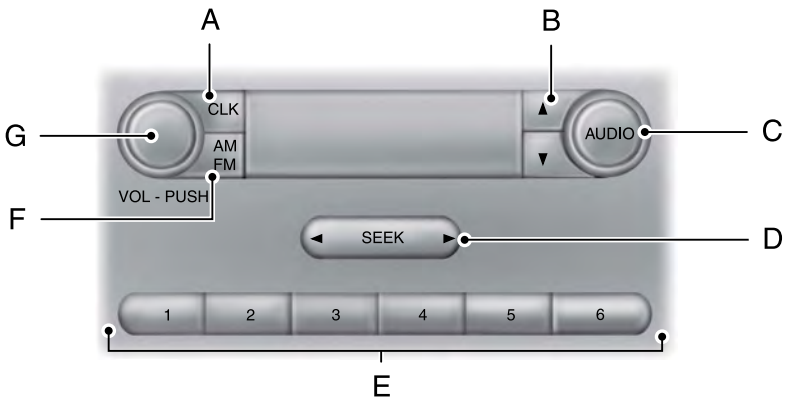

E163157

# Audio System

---

- A **CLK:** Press this button to switch the display between the clock and radio frequency. To set the time, press and hold the button until the hours start to flash. Press the arrow buttons (B) to adjust the hours, then repeat to set the minutes. Press **CLK** again to exit clock mode.
- B **Tune:** Press these arrow buttons to manually search through the radio frequency band. Press and hold for a fast search. In AUDIO mode, press the buttons to adjust different sound settings.
- C **AUDIO:** Press this button to access settings for Treble, Middle, Bass, Fade and Balance.
- D **SEEK:** Press this button to go to the previous or next strong station on the frequency band.
- E **Memory presets:** Store your favorite radio stations. To store a radio station, tune to the station, then press and hold a preset button until sound returns.
- F **AM/FM:** Press this button to select a frequency band and access media through the auxiliary input jack.
- G **VOL-PUSH:** Press this button to switch the system off and on. Turn the control to adjust the volume.

## AUDIO UNIT - VEHICLES WITH: AM/FM/CD/SYNC

### WARNING



Driving while distracted can result in loss of vehicle control, crash and injury. We strongly recommend that you use extreme caution when using any device that may take your focus off the road. Your primary responsibility is the safe operation of your vehicle. We recommend against the use of any hand-held device while driving and encourage the use of voice-operated systems when possible. Make sure you are aware of all applicable local laws that may affect the use of electronic devices while driving.

---

# Audio System

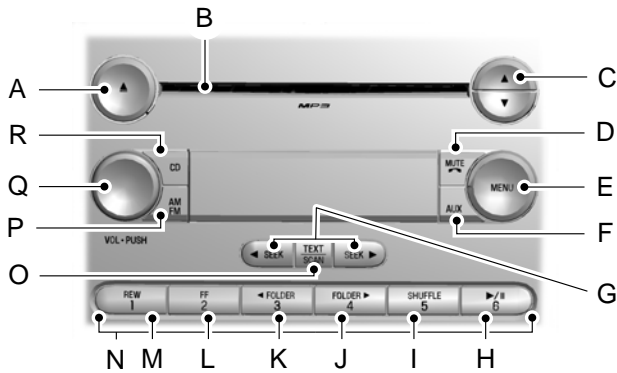

E169515

- A **Eject:** Press to eject a CD.
- B **CD slot:** Insert a CD.
- C **Tune:** Press to search through the radio frequency band manually. Press and hold for a fast search.
- D **Phone:** Press to access the phone features of the SYNC system. See **SYNC™** (page 323).
- E **MENU:** Press to access different audio system features.

If your vehicle is equipped with satellite radio, you can access different menus by pressing **OK**.

Set the time by pressing **MENU** until SET HOURS or SET MINUTES appears and using the arrow buttons to adjust the time.

Set the strongest stations on the radio frequency by pressing **MENU** until AUTOSET appears. AUTOSET does not override your original presets.

**RBDS** displays text transmitted by certain radio stations and searches for music categories. To search for music categories, turn on RBDS (by using the **SEEK** buttons when RBDS ON/OFF appears). Press the up and down arrow buttons to scroll through categories, then use the **SEEK** buttons to begin the search.

SPEEDVOL (speed compensated volume) allows you to adjust radio volume to compensate for noise levels when vehicle speed increases.

# Audio System

---

**Track/Folder** is only available on MP3 files when in CD mode. In track mode, pressing the **SEEK** arrows allows you to scroll through all the tracks on the disc. In folder mode, pressing the **SEEK** arrows allows you to scroll through all the tracks within the selected folder. Press the **FOLDER** buttons to access other folders.

**COMPRESS** (Compression) is only available in CD and MP3 modes. Switching compression on brings the soft and loud passages together for a more consistent listening level. Use the **SEEK** buttons and up and down arrow buttons to switch it on and off.

- F **AUX:** Press to access the media features of the SYNC system. See **SYNC™** (page 323).
- G **SEEK:** In radio mode, press and release these buttons to go to the next (or previous) preset radio station or disc track. In CD and MP3 modes, press these buttons to select the next (or previous) track, or press and hold to advance (or reverse) within the same track.
- H **Play, Pause and OK:** Play and Pause allow you to play or pause a track when listening to a CD. **OK** allows you to confirm commands with phone and media features of the SYNC system. See **SYNC™** (page 323).
- I **SHUFFLE:** Play music on the selected CD or MP3 folder in random order.
- J **FOLDER >:** Press to access the next folder on an MP3 disc.
- K **< FOLDER:** Press to access the previous folder on an MP3 disc.
- L **FF:** Press to fast forward in a CD track or MP3 file manually.
- M **REW:** Press to rewind in a CD track or MP3 file manually.
- N **Memory presets:** Store your favorite radio stations. To store a radio station, tune to the station, then press and hold a preset button until sound returns.
- O **TEXT/SCAN:** In radio, CD and MP3 modes, press and hold to hear a brief sampling of radio stations, CD tracks or MP3 files. In CD and MP3 modes, press and release to display track title, artist name and disc title. In text mode, sometimes the display requires additional text to show. When the < / > indicator is on, press **TEXT** and then use the **SEEK** buttons to view the additional display text.
- P **AM/FM:** Press to select a frequency band.
- Q **VOL-PUSH:** Press to switch the system off and on. Turn it to adjust the volume.
- R **CD:** Press to enter CD or MP3 mode.

# Audio System

## AUDIO UNIT - VEHICLES WITH: SONY AM/FM/CD

**Note:** The MyFord Touch system controls most of the audio features. See **MyFord Touch™** (page 362).

### WARNING



Driving while distracted can result in loss of vehicle control, crash and injury. We strongly recommend that you use extreme caution when using any device that may take your focus off the road. Your primary responsibility is the safe operation of your vehicle. We recommend against the use of any hand-held device while driving and encourage the use of voice-operated systems when possible. Make sure you are aware of all applicable local laws that may affect the use of electronic devices while driving.

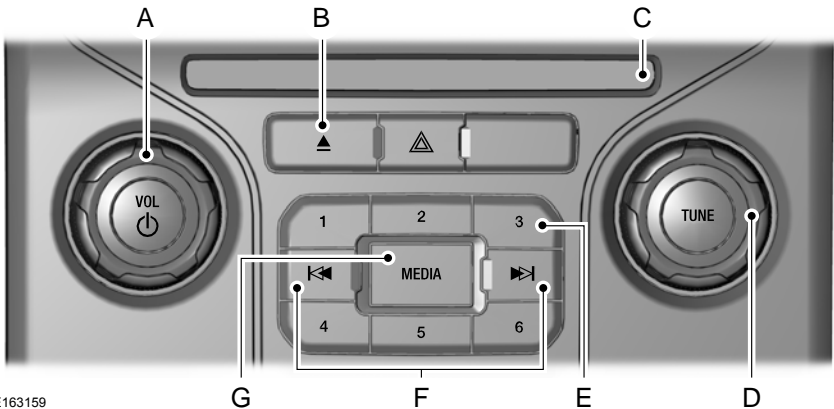

E163159

- A **VOL and Power:** Press this button to switch the system off and on. Turn it to adjust the volume.
- B **Eject:** Press this button to eject a CD.
- C **CD slot:** Insert a CD.
- D **TUNE:** Turn this control to search through the radio frequency band manually.
- E **Memory presets:** Store your favorite radio stations. To store a radio station, tune to the station, then press and hold a preset button until sound returns.

# Audio System

---

## F **Seek, Reverse and Fast Forward:**

In radio mode, select a frequency band and press one of these buttons. The system stops at the first station it finds in that direction.

In Sirius mode, press these buttons to select the previous or next channel. If a specific category is selected (such as Jazz, Rock or News), use these buttons to find the previous or next channel in the selected category.

In CD mode, press these buttons to select the previous or next track.

## G **MEDIA:** Press this button to access different audio modes, such as AM, FM and A/V Input.

## DIGITAL RADIO

**Note:** *HD Radio broadcasts are not available in all markets.*

HD Radio technology is the digital evolution of analog AM/FM radio. Your system has a special receiver that allows it to receive digital broadcasts (where available) in addition to the analog broadcasts, it already receives. Digital broadcasts provide a better sound quality than analog broadcasts with free, crystal-clear audio and no static or distortion. For more information, and a guide to available stations and programming, please visit [www.hdradio.com](http://www.hdradio.com).

When HD Radio is on and you tune to a station broadcasting HD Radio technology, you may notice the HD Radio logo on your screen. When this logo is available, you may also see Title and Artist fields on-screen.

The multicast indicator appears in FM mode (only) if the current station is broadcasting multiple digital broadcasts. The highlighted numbers signify available digital channels where new or different content is available. HD1 signifies the main programming status and is available in analog and digital broadcasts. Other multicast stations (HD2 through HD7) are only available digitally.

When HD Radio broadcasts are active, you can access the following functions:

- **Scan** allows you to hear a brief sampling of all available stations. This feature still works when HD Radio reception is on, although it does not scan for HD2-HD7 channels. You may see the HD logo appear if the station has a digital broadcast.
- **Memory presets** allow you to save an active channel as a memory preset. Touch and hold a memory preset slot until the sound returns. There is a brief mute while the radio saves the station. Sound returns when finished. When switching to an HD2 or HD3 memory preset, the sound mutes before the digital audio plays, because the system has to reacquire the digital signal.

**Note:** *As with any saved radio station, you cannot access the saved station if your vehicle is outside the station's reception area.*

# Audio System

## HD Radio Reception and Station Troubleshooting

<b>Potential reception issues</b>	
Reception area	If you are listening to a multicast station and you are on the fringe of the reception area, the station may mute due to weak signal strength.
	If you are listening to HD1, the system switches back to the analog broadcast until the digital broadcast is available again. However, if you are listening to any of the possible HD2-HD7 multicast channels, the station mutes and stays muted unless it is able to connect to the digital signal again.
Station blending	When the system first receives a station (aside from HD2-HD7 multicast stations), it first plays the station in the analog version. Once the receiver verifies the station is an HD Radio station, it shifts to the digital version. Depending on the station quality, you may hear a slight sound change when the station changes from analog to digital. Blending is the shift from analog to digital sound or digital back to analog sound.

In order to provide the best possible experience, use the contact form to report any station issues found while listening to a station broadcasting with HD Radio technology. Independent entities own and operate each station. These stations are responsible for ensuring all audio streams and data fields are accurate.



# Audio System

Potential station issues		
Issues	Cause	Action
Echo, stutter, skip or repeat in audio. Increase or decrease in audio volume.	This is poor time alignment by the radio broadcaster.	No action required. This is a broadcast issue.
Sound fading or blending in and out.	The radio is shifting between analog and digital audio.	No action required. The reception issue may clear up as you continue to drive.
There is an audio mute delay when selecting HD2 or HD3, multicast preset or <b>Direct Tune</b> .	The digital multicast is not available until the HD Radio broadcast is decoded. Once decoded, the audio is available.	No action required. This is normal behavior. Wait until the audio is available.
Cannot access HD2 or HD3 multicast channel when recalling a preset or from a direct tune.	The previously stored multicast preset or direct tune is not available in your current reception area.	No action required. The station is not available in your current location.
Text information does not match currently playing audio.	Data service issue by the radio broadcaster.	Fill out the station issue form at website listed below.*
There is no text information shown for currently selected frequency.	Data service issue by the radio broadcaster.	Fill out the station issue form at website listed below.*
HD2-HD7 stations not found when <b>Scan</b> is pressed.	Pressing <b>Scan</b> disables HD2-HD7 channel search.	No action required. This is normal behavior.

\* [http://www.ibiquity.com/automotive/report\\_radio\\_station\\_experiences](http://www.ibiquity.com/automotive/report_radio_station_experiences)

HD Radio Technology manufactured under license from iBiquity Digital Corp. U.S. and foreign patents. HD Radio and the HD and HD Radio logos are proprietary trademarks of iBiquity Digital Corp. Ford Motor Company and iBiquity Digital Corp. are not responsible for the content sent using HD Radio technology. Content may be changed, added or deleted at any time at the station owner's discretion.

## SATELLITE RADIO (If Equipped)

SIRIUS® broadcasts a variety of music, news, sports, weather, traffic and entertainment satellite radio channels. For more information and a complete list of SIRIUS satellite radio channels, visit [www.siriusxm.com](http://www.siriusxm.com) in the United States, [www.sirius.ca](http://www.sirius.ca) in Canada, or call SIRIUS at 1-888-539-7474.

# Audio System

**Note:** This receiver includes the eCos real-time operating system. eCos is published under the eCos License.

## Satellite Radio Reception Factors

Potential satellite radio reception issues	
Antenna obstructions	For optimal reception performance, keep the antenna clear of snow and ice build-up and keep luggage and other material as far away from the antenna as possible.
Terrain	Hills, mountains, tall buildings, bridges, tunnels, freeway overpasses, parking garages, dense tree foliage and thunderstorms can interfere with your reception.
Station overload	When you pass a ground-based broadcast-repeating tower, a stronger signal may overtake a weaker one and the audio system may mute.
Satellite radio signal interference	Your display may show ACQUIRING . . . to indicate the interference and the audio system may mute.

## SIRIUS® Satellite Radio Service

**Note:** SIRIUS reserves the unrestricted right to change, rearrange, add or delete programming including canceling, moving or adding particular channels, and its prices, at any time, with or without notice to you. Ford Motor Company shall not be responsible for any such programming changes.



E142593

SIRIUS satellite radio is a subscription-based satellite radio service that broadcasts a variety of music, sports, news, weather, traffic and entertainment programming. Your factory-installed SIRIUS satellite radio system includes hardware and a limited subscription term, which begins on the date of sale or lease of your vehicle. See an authorized dealer for availability.

For more information on extended subscription terms (a service fee is required), the online media player and a complete list of SIRIUS satellite radio channels, and other features, please visit [www.siriusxm.com](http://www.siriusxm.com) in the United States, [www.sirius.ca](http://www.sirius.ca) in Canada, or call SIRIUS at 1-888-539-7474.

## Satellite Radio Electronic Serial Number (ESN)

You need your ESN to activate, modify or track your satellite radio account. When in satellite radio mode, press **Options**.

# Audio System

## Troubleshooting

Message	Condition	Action
Acquiring...	Radio requires more than two seconds to produce audio for the selected channel.	No action required. This message should disappear shortly.
Satellite antenna fault SIRIUS system failure	There is an internal module or system failure present.	If this message does not clear shortly, or with an ignition key cycle, your receiver may have a fault. See an authorized dealer for service.
Invalid Channel	The channel is no longer available.	Tune to another channel or choose another preset.
Unsubscribed Channel	Your subscription does not include this channel.	Contact SIRIUS at 1-888-539-7474 to subscribe to the channel, or tune to another channel.
No Signal	The signal is lost from the SIRIUS satellite or SIRIUS tower to your vehicle antenna.	The signal is blocked. When you move into an open area, the signal should return.
Updating...	Update of channel programming in progress.	No action required. The process may take up to three minutes.
Questions? Call 1-888-539-7474	Your satellite service is no longer available.	Contact SIRIUS at 1-888-539-7474 to resolve subscription issues.
None found Check Channel Guide	All the channels in the selected category are either skipped or locked.	Use the channel guide to turn off the Lock or Skip function on that station.
Subscription Updated	SIRIUS has updated the channels available for your vehicle.	No action required.

# Audio System

## AUDIO INPUT JACK

### WARNINGS



Driving while distracted can result in loss of vehicle control, crash and injury. We strongly recommend that you use extreme caution when using any device that may take your focus off the road. Your primary responsibility is the safe operation of your vehicle. We recommend against the use of any hand-held device while driving and encourage the use of voice-operated systems when possible. Make sure you are aware of all applicable local laws that may affect the use of electronic devices while driving.



For safety reasons, do not connect or adjust the settings on your portable music player while your vehicle is moving.



Store the portable music player in a secure location, such as the center console or the glove box, when your vehicle is moving. Hard objects may become projectiles in a collision or sudden stop, which may increase the risk of serious injury. The audio extension cable must be long enough to allow the portable music player to be safely stored while your vehicle is moving.

The auxiliary input jack allows you to connect and play music from your portable music player through your vehicle speakers. You can use any portable music player designed for use with headphones. Your audio extension cable must have male 1/8th-inch (3.5 millimeter) connectors at each end.

1. Make sure your vehicle, radio and portable music player are turned off and the transmission is in position **P**.
2. Plug the extension cable from the portable music player into the AIJ.
3. Turn on the radio. Select either a tuned FM station or a CD.
4. Adjust the volume as desired.
5. Turn on your portable music player and adjust its volume to half its maximum level.
6. Press **AUX** until **LINE** or **LINE IN** appears in the display. You should hear music from your device even if it is low.
7. Adjust the volume on your portable music player until it reaches the volume level of the FM station or CD. Do this by switching back and forth between the AUX and FM or CD controls.

## USB PORT (If Equipped)

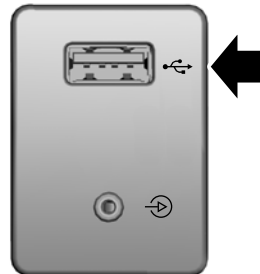
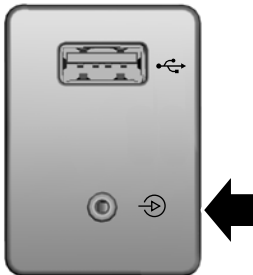

# Audio System

---

The USB port allows you to plug in media playing devices, memory sticks and charge devices (if supported). See **SYNC™** (page 323).

## **MEDIA HUB (If Equipped)**

The media hub is located in a compartment on top of the instrument panel. Push down on the top of the compartment to access the media hub.

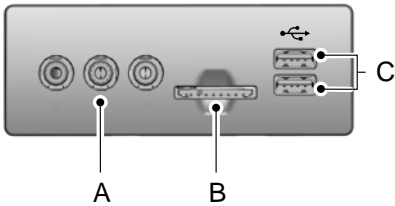

E163162

- A A/V inputs
- B SD card slot
- C USB ports

See **MyFord Touch™** (page 362).

## GENERAL INFORMATION

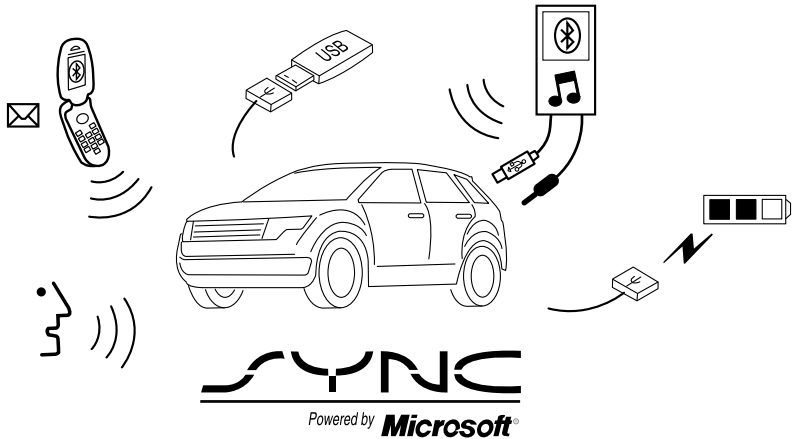

E142598

SYNC is an in-vehicle communications system that works with your Bluetooth-enabled cellular phone and portable media player. This allows you to:

- Make and receive calls.
- Access and play music from your portable music player.
- Use 911 Assist, Vehicle Health Report and SYNC Services (Traffic, Directions & Information).\*
- Use applications, such as Pandora and Stitcher, via SYNC AppLink.\*\*
- Access phonebook contacts and music using voice commands.
- Stream music from your connected phone.
- Text message.

- Use the advanced voice recognition system.
- Charge your USB device (if your device supports this).

\*These features are not available in all markets and may require activation.

\*\*Available AppLink enabled apps vary by market.

Make sure that you review your device's manual before using it with SYNC.

### Support

The SYNC support team is available to help you with any questions you cannot answer on your own.

Monday-Saturday, 8:30am-9:00pm EST.

Sunday, 10:30am-7:30pm EST.

In the United States, call 1-800-392-3673.

In Canada, call 1-800-565-3673.

Times are subject to change due to holidays.

## SYNC Owner Account

Why do I need a SYNC owner account?

- Required to activate Vehicle Health Report and to view the reports online.
- Required to activate the subscription-based SYNC Services and to personalize your Saved Points and Favorites.
- Essential for keeping up with the latest software downloads available for SYNC.
- Access to customer support for any questions you may have.

## Driving Restrictions

For your safety, certain features are speed-dependent and restricted when your vehicle is traveling over 3 mi (5 km).

## Safety Information

### WARNING



Driving while distracted can result in loss of vehicle control, crash and injury. We strongly recommend that you use extreme caution when using any device that may take your focus off the road. Your primary responsibility is the safe operation of your vehicle. We recommend against the use of any hand-held device while driving and encourage the use of voice-operated systems when possible. Make sure you are aware of all applicable local laws that may affect the use of electronic devices while driving.

When using SYNC:

- Do not operate playing devices if the power cords or cables are broken, split or damaged. Place cords and cables out of the way, so they do not interfere with the operation of pedals, seats, compartments or safe driving abilities.
- Do not leave playing devices in your vehicle during extreme conditions as it could cause them damage. See your device's manual for further information.
- Do not attempt to service or repair the system. See an authorized dealer.

## Privacy Information

When a cellular phone is connected to SYNC, the system creates a profile within your vehicle that is linked to that cellular phone. This profile is created in order to offer you more cellular features and to operate more efficiently. Among other things, this profile may contain data about your cellular phone book, text messages (read and unread), and call history, including history of calls when your cellular phone was not connected to the system. In addition, if you connect a media device, the system creates and retains an index of supported media content. The system also records a short development log of approximately 10 minutes of all recent system activity. The log profile and other system data may be used to improve the system and help diagnose any problems that may occur.

The cellular profile, media device index, and development log will remain in the vehicle unless you delete them and are generally accessible only in the vehicle when the cellular phone or media player is connected. If you no longer plan to use the system or the vehicle, we recommend you perform a Master Reset to erase all stored information.

System data cannot be accessed without special equipment and access to the vehicle's SYNC module. Ford Motor Company and Ford of Canada will not access the system data for any purpose other than as described absent consent, a court order, or where required by law enforcement, other government authorities, or other third parties acting with lawful authority. Other parties may seek to access the information independently of Ford Motor Company and Ford of Canada. For further privacy information, see the sections on 911 Assist, Vehicle Health Report, and Traffic, Directions and Information.

## USING VOICE RECOGNITION

This system helps you control many features using voice commands. This allows you to keep your hands on the wheel and focus on what is in front of you.

### Initiating a Voice Session



Push the voice icon. A tone sounds and Listening appears in the display. Say any of the following:

Say	If You Want To
"Bluetooth audio"	Stream audio from your phone.
"Cancel"	Cancel the requested action.
"Line in"	Access the device connected to the auxiliary input jack.
"Mobile apps" *	Access mobile applications.
"Phone"	Make calls.
"Services" *	Access the SYNC Services portal.
"SYNC"	Return to the main menu.
"USB"	Access the device connected to your USB port.
"Vehicle health report" *	Run a vehicle health report.
"Voice settings"	Adjust the level of voice interaction and feedback.
"Help"	Hear a list of voice commands available in the current mode.

\* This is an optional feature and available in the United States only.



## System Interaction and Feedback

The system provides feedback through audible tones, prompts, questions and spoken confirmations depending on the situation and the chosen level of interaction (voice settings). You can customize the voice recognition system to provide more or less instruction and feedback.

The default setting is to a higher level of interaction in order to help you learn to use the system. You can change these settings at any time.

### Adjusting the Interaction Level



Push the voice icon. Say "Voice settings" when prompted, then any of the following:

When you say:	The system:
"Interaction mode standard"	Provides more detailed interaction and guidance.
"Interaction mode advanced"	Provides less audible interaction and more tone prompts.

The system defaults to the standard interaction mode.

Confirmation prompts are short questions the system asks when it is not sure of your request or when there are multiple possible responses to your request. For example, the system may ask "Phone, is that correct?". If turned off, the system simply makes a best guess as to what you requested and may ask you to confirm settings.

When you say:	The system:
"Confirmation prompts off"	Makes a best guess from the command; you may still occasionally be asked to confirm settings.
"Confirmation prompts on"	Clarifies your voice command with a short question.

The system creates candidate lists when it has the same confidence level of several options based on your voice command. When turned on, it may prompt you with as many as four possibilities for clarification.

For example, say "Say 1 after the tone to call John Doe at home. Say 2 after the tone to call Johnny Doe on mobile. Say 3 after the tone to call Jane Doe at home." You could also say "Say 1 after the tone to play John Doe, Say 2 after the tone to play Johnny Doe."

<b>When you say:</b>	<b>The system:</b>
"Media candidate lists off"	Makes a best guess from the media candidate list. You may still occasionally be asked questions.
"Media candidate lists on"	Clarifies your voice command for media candidates.
"Phone candidate lists off"	Makes a best guess from the phone candidate list. You may still occasionally be asked questions.
"Phone candidate lists on"	Clarifies your voice command for phone candidates

## Helpful Hints

- Make sure the interior of your vehicle is as quiet as possible. Wind noise from open windows and road vibrations may prevent the system from correctly recognizing spoken commands.
- After pressing the voice icon, wait until after the tone sounds and Listening appears before saying a command. Any command spoken before this does not register with the system.
- Speak naturally, without long pauses between words.
- At any time, you can interrupt the system while it is speaking by pressing the voice icon.

## USING SYNC™ WITH YOUR PHONE

Hands-free calling is one of the main features of SYNC. While the system supports a variety of features, many are dependent on your cellular phone's functionality. At a minimum, most cellular phones with Bluetooth wireless technology support the following functions:

- Answering an incoming call.
- Ending a call.
- Using privacy mode.
- Dialing a number.
- Redialing.
- Call waiting notification.
- Caller ID.

Other features, such as text messaging using Bluetooth and automatic phonebook download, are phone-dependent features. To check your phone's compatibility, see your phone's manual and visit [www.SYNCMYRide.com](http://www.SYNCMYRide.com), [www.SYNCMYRide.ca](http://www.SYNCMYRide.ca) or [www.syncmaroute.ca](http://www.syncmaroute.ca).

## Pairing a Phone for the First Time

**Note:** SYNC can support downloading up to approximately 1000 entries per Bluetooth-enabled cellular phone.

**Note:** Make sure to switch on the ignition and the radio. Put the transmission in position **P**.

**Note:** To scroll through the menus, press the up and down arrows on your audio system.

Wirelessly pairing your phone with SYNC allows you to make and receive hands-free calls.

1. Press the phone button. When the display indicates there is no phone paired, press **OK**.
2. When **Find SYNC** appears in the display, press **OK**.
3. Put your phone into Bluetooth discovery mode. See your device's manual if necessary.
4. When prompted on your phone's display, enter the six-digit PIN provided by SYNC in the radio display. The display indicates when the pairing is successful.

Depending on your phone's capability and your market, the system may prompt you with questions, such as setting the current phone as the primary phone (the phone SYNC automatically tries to connect with first upon vehicle start-up) and downloading your phonebook.

## Pairing Subsequent Phones

**Note:** Make sure to switch on the ignition and the radio. Put the transmission in position **P**.

**Note:** To scroll through the menus, press the up and down arrows on your audio system.

1. Press the phone button, and then scroll to System Settings. Press **OK**.
2. Scroll to Bluetooth Devices. Press **OK**.
3. Scroll to Add Bluetooth Device. Press **OK**.
4. When **Find SYNC** appears in the display, press **OK**.
5. Put your phone into Bluetooth discovery mode. See your phone's manual if necessary.
6. When prompted on your phone's display, enter the six-digit PIN provided by SYNC in the radio display. The display indicates when the pairing is successful.

The system then prompts with questions, such as if you would like to set the current phone as the primary phone (the phone SYNC automatically tries to connect with first upon vehicle start-up) and download your phone book.

## Phone Voice Commands

Press the voice icon and say "Phone". Say any of the following:

"PHONE"
"Call <name>" <sup>1,2</sup>
"Call <name> at home" <sup>1,2</sup>
"Call <name> at work" <sup>1,2</sup>
"Call <name> in office" <sup>1,2</sup>
"Call <name> on mobile OR cell" <sup>1,2</sup>
"Call <name> on other" <sup>1,2</sup>
"Call history incoming" <sup>2</sup>
"Call history missed" <sup>2</sup>

## SYNC™ (If Equipped)

"PHONE"
"Call history outgoing" <sup>1,2</sup>
"Connections" <sup>1,2</sup>
"Dial" <sup>1,3</sup>
"Go to privacy"
"Hold"
"Join"
"Menu" <sup>1,2,4</sup>
"Phone book <name>" <sup>1,2</sup>
"Phone book <name> at home" <sup>1,2</sup>
"Phone book <name> at office" <sup>1,2</sup>
"Phone book <name> at work" <sup>1,2</sup>
"Phone book <name> on mobile OR cell" <sup>1,2</sup>
"Phone book <name> on other" <sup>1,2</sup>

<sup>1</sup> This command does not require you to say "Phone" first.

<sup>2</sup> This command is not available until phone information is completely downloaded using Bluetooth.

<sup>3</sup> See **Dial** table below.

<sup>4</sup> See **Menu** table below.

**Phone book commands:** When you ask SYNC to access things such as a phonebook name or number, the requested information appears in the display to view. Press the phone button and say, "Call" to call the contact.

"DIAL"
"411 (four-one-one)", "911" (nine-one-one)
"700" (seven hundred)
"800" (eight hundred)
"900" (nine hundred)
"Pound" (#)
"Number <0-9>"
"Asterisk" (*)
"Clear" (deletes all entered digits)
"Delete" (deletes one digit)
"Plus"
"Star"

**Note:** To exit dial mode, press and hold the phone button or press **MENU** to go to the phone menu.

"MENU"
"(Phone) connections"
"(Phone) settings (message) notification off"
"(Phone) settings (message) notification on"
"(Phone) settings (set) phone ringer"
"(Phone) settings (set) ringer 1"
"(Phone) settings (set) ringer 2"
"(Phone) settings (set) ringer 3"
"(Phone) settings (set) ringer off"
"Battery"
"Phone name"

<b>"MENU"</b>
"Signal"
"Text message inbox"

Words in ( ) are optional and do not have to be spoken for the system to understand the command.

## Making Calls

Press the voice icon and when prompted say:

1. Say "Call <name>" or "Dial", then the desired number.
2. When the system confirms the number, say, "Dial" again to initiate the call.

To erase the last spoken digit, say, "Delete" or press the left arrow button. To erase all spoken digits, say "Clear" or press and hold the left arrow button.

To end the call, press and hold the phone button.

## Receiving Calls

When receiving a call, you can:

- Answer the call by pressing the phone button.
- Reject the call by pressing and holding the phone button.
- Ignore the call by doing nothing.

## Phone Options during an Active Call

During an active call, you have more menu features that become available, such as putting a call on hold or joining calls. Use the arrow buttons to scroll through the menu options.

1. Press **MENU** during an active call.
2. After selecting Active Call Menu, press **OK**.
3. Scroll to cycle through the following options:

<b>When you select:</b>	<b>You can:</b>
Mute Call?	Mute the call.
Privacy	Switch a call from an active hands-free environment to your cellular phone for a more private conversation. Press <b>OK</b> when <b>Privacy on/off</b> appears. (The display indicates In Privacy and the system transfers your call.)
Call Hold	Put an active call on hold. Press <b>OK</b> when <b>Hold on/off</b> appears. To answer another call at this time, press the phone button.
Enter Tones	Enter "tones", such as numbers for passwords. Scroll until the desired number appears in the display, then press <b>OK</b> ; a tone sounds as confirmation. Repeat as necessary.
Join Calls	Join two separate calls. (SYNC supports a maximum of three callers on a multiparty call or conference call.) 1. Press the phone button.

## SYNC™ (If Equipped)

When you select:	You can:
	<ol style="list-style-type: none"><li>2. Access the desired contact through SYNC or use voice commands to place the second call. Once actively in the second call, press <b>MENU</b>.</li><li>3. Scroll to Join Calls, and press <b>OK</b>. Press <b>OK</b> again when <b>Join Calls?</b> appears.</li></ol>
Phonebook	<p>Access your phonebook contacts.</p> <ol style="list-style-type: none"><li>1. Press <b>OK</b> to select, and then scroll through your phonebook contacts.</li><li>2. Press <b>OK</b> again when the desired selection appears in the display.</li><li>3. Press the phone button.</li></ol>
Call History	<p>Access your call history log.</p> <ol style="list-style-type: none"><li>1. Press <b>OK</b> to select, then scroll through your call history options (incoming, outgoing or missed).</li><li>2. Press <b>OK</b> when the desired selection appears in the display.</li><li>3. Press the phone button to call the selection.</li></ol>
Return	Exit the current menu.

### Accessing Features through the Phone Menu

SYNC's phone menu allows you to redial a number, access your call history and phonebook and sends text messages as well as access phone and system settings. You can also access advanced features, such as 911 Assist, Vehicle Health Report and SYNC Services.

1. Press the phone button to enter the phone menu.
2. Scroll to cycle through:

When you select:	You can:
Phone Redial	Redial the last number called (if available). Press <b>OK</b> to select, and then press <b>OK</b> again to confirm.
Call History <sup>1</sup>	<p>Access any previously dialed, received or missed calls after you connect your Bluetooth-enabled phone to SYNC.</p> <ol style="list-style-type: none"><li>1. Press <b>OK</b> to select.</li><li>2. Scroll to select from Call History Incoming, Call History Outgoing or Call History Missed. Press <b>OK</b> to make your selection.</li><li>3. Press <b>OK</b> or the phone button to call the desired selection.</li></ol>

## SYNC™ (If Equipped)

When you select:	You can:
	<b>Note:</b> The system attempts to automatically re-download your phonebook and call history each time your phone connects to SYNC (if the auto download feature is on and your Bluetooth-enabled cellular phone supports this feature).
Phonebook <sup>1,2</sup>	Access and call any contacts in your previously downloaded phonebook. 1. Press <b>OK</b> to confirm and enter. If your phonebook has fewer than 255 listings, they appear alphabetically in flat file mode. If there are more than 255 entries, the system organizes them into alphabetical categories. 2. Scroll until the desired contact appears, then press <b>OK</b> . 3. Press <b>OK</b> or the phone button.
Text Message <sup>1</sup>	Send, download and delete text messages.
Phone Settings <sup>1</sup>	View your phone's status, set ring tones, select your message notification, change phone book entries and automatically download your cellular phone among other features.
SYNC Services <sup>3</sup>	Access the SYNC Services portal where you can request various types of information, traffic reports and directions.
911 Assist <sup>4</sup>	Place an emergency call to a 911 operator for you after an accident, when used properly.
Vehicle Health Report <sup>3</sup>	Create and receive a diagnostic report card on your vehicle.
Mobile Apps <sup>3</sup>	Interact with SYNC-capable mobile applications on your smartphone.
System Settings	Access Bluetooth Devices menu listings (Add, Connect, Set as Primary, On and Off, Delete) as well as Advanced menu listings (prompts, languages, defaults, master reset, install application and system information).
Exit Phone Menu	Exit the phone menu by pressing OK.

<sup>1</sup> This is a phone-dependent feature.

<sup>2</sup> This is a phone-dependent and speed-dependent feature.

<sup>3</sup> This is an optional feature and available in the United States only.

<sup>4</sup> This is an optional feature and available in the United States and Canada only.

## Text Messaging

**Note:** *This is a phone-dependent feature.*

SYNC allows you to receive, send, download and delete text messages. The system can also read incoming text messages to you so that you do not have to take your eyes off the road.

### Receiving a Text Message

**Note:** *This is a phone-dependent feature. Your phone must support downloading text messages using Bluetooth to receive incoming text messages.*

When a new message arrives, an audible tone sounds and the display indicates you have a new message. You have these options:

- Press the voice button, wait for the prompt and say "Read message" to have SYNC read the message to you.
- Press **OK** to receive and open the text message or do nothing and the message goes into your text message inbox. Press **OK** again and SYNC reads your message aloud as you are not able to view the message. You can then also choose to reply or forward the message.
- Press **OK** and scroll to choose between:
  - **Reply to Text Message:** Press **OK** to access and then scroll through the list of pre-defined messages to send.
  - **Forward Text Message:** Press **OK** to forward the message to anyone in your Phonebook or Call History. You can also choose Enter Number.

## Sending, Downloading and Deleting Your Text Messages

**Note:** *Forwarding a text message is a speed-dependent feature and is only available when your vehicle is traveling at 3 mph (5 km/h) or less.*

**Note:** *You can only have one recipient per text message.*

Text messaging is a phone-dependent feature. If your phone is compatible, SYNC allows you to receive, send, download and delete text messages.

1. Press the phone button.
2. Scroll to Text Message, and then press **OK**.

Scroll to select from the following options:

- **Send Text Message?** allows you to send a new text message based on a pre-defined set of 15 messages.
- **Download Unread Msgs** allows you to download your unread messages (only) to SYNC. To download the messages, press **OK** to select. The display indicates that it is downloading your messages. When it is complete, SYNC takes you to your inbox.
- **Delete All Messages?** allows you to delete current text messages from SYNC (not your phone). To delete the messages, press **OK** to select. The display indicates when it is finished deleting all your text messages. SYNC returns you to the text message menu.
- **Return** exits the current menu when you press **OK**.

If you select **Send Text Message?:**

1. Press **OK** to select. If the system detects your phone does not support this feature, **Unsupported** appears in the display and SYNC returns to the main menu.
2. Scroll to cycle through the message options in the following chart.



3. Press **OK** when the desired selection is in the display.
4. Enter the name of the recipient. Scroll to cycle through Phonebook or Call History entries. You can also select Enter Number to say the desired number.
5. Press **OK** to enter the desired menu and scroll to select the specific contact.
6. Press **OK** when the contact appears and press **OK** again to confirm when the system asks if you would like to send the message. The system sends each text message with the following signature: "This message was sent from my <Ford or Lincoln>".

Pre-defined text message options
No
Why?
Thanks
Where R you?
I need more directions
I love you
Too funny
Can't wait to see you
I'm stuck in traffic

Pre-defined text message options
Can't talk right now
Call me
Call U later
Be there in 10 minutes
Be there in 20 minutes
Yes

## Accessing Your Phone Settings

These are phone-dependent features. Your phone settings allow you to access and adjust features such as your ring tone, text message notification, modify your phonebook and set up automatic download.

1. Press the phone button.
2. Scroll to Phone Settings, and then press **OK**.
3. Scroll to select from the following options:

When you select:	You can:
Phone Status	See the provider, name, signal power, battery power and roaming status of your connected phone. Press <b>OK</b> to select and scroll to view the information. When done, press <b>OK</b> again to return to the phone status menu.
Set Ringer	Select which ring tone sounds during an incoming call (one of the system's or your phone's). <ol style="list-style-type: none"> <li>1. Press <b>OK</b> to select and scroll to hear Ringer 1, Ringer 2, Ringer 3 and Phone Ringer.</li> <li>2. Press <b>OK</b> to select.</li> </ol>

## SYNC™ (If Equipped)

When you select:	You can:
	If your phone supports in-band ringing, your phone's ring tone plays when you choose Phone Ringer.
Message Notification	Have the option of hearing an audible tone to notify you when a text message arrives. 1. Press <b>OK</b> to select and scroll between Message Notification On and Message Notification Off. 2. Press <b>OK</b> to select.
Modify Phonebook	Modify the contents of your phonebook (such as add, delete or download). Press <b>OK</b> to choose between:
	Add Contacts: Press <b>OK</b> to add more contacts from your phone book. Push the desired contact(s) on your phone. See your phone's manual on how to push contacts.
	Delete Phonebook: Press <b>OK</b> to delete the current phone book and call history. When <b>Delete Phonebook</b> appears, press <b>OK</b> to confirm. SYNC takes you back to the Phone Settings menu.
	Download Phonebook: Press <b>OK</b> to select, then and press <b>OK</b> again when <b>Confirm Download?</b> appears.
Auto Download	Automatically download your phone book each time your phone connects to SYNC.* Press <b>OK</b> to select. When <b>Auto Download On?</b> appears, press <b>OK</b> to have your phonebook automatically downloaded each time.** Select Off if you do not want to download your phonebook every time your phone connects to SYNC. Your phonebook, call history and text messages can only be accessed when your specific phone is connected to SYNC.
Return	Exit the current menu.

\*Downloading times are phone-dependent and quantity-dependent.

\*\*When Auto Download is on, it automatically deletes any changes, additions or deletions saved since your last download.

### System Settings

This menu provides access to your Bluetooth Devices and Advanced menu features. Use the arrow buttons to scroll through the menu options.

### Bluetooth Devices

The Bluetooth Devices menu allows you to add, connect and delete devices, set a phone as primary as well as turn your Bluetooth feature on and off.

## SYNC™ (If Equipped)

1. Press the phone button to enter the phone menu
2. Scroll to System Settings. Press **OK**.
3. Scroll to Bluetooth Devices. Press **OK**.
4. Scroll to select from the following options:

If you select:	You can:
Add Bluetooth Device*	See <b>Using SYNC™ With Your Phone</b> (page 327).
Connect Bluetooth Device	Connect a previously paired Bluetooth-enabled phone.** 1. Press <b>OK</b> to select and view a list of previously paired phones. 2. Scroll until you find the desired device, and then press <b>OK</b> to connect the phone.
Set as Primary Phone	Set a previously paired phone as your primary phone. Press <b>OK</b> to select and scroll to select the desired phone. Press <b>OK</b> to confirm. SYNC attempts to connect with the primary phone at every ignition cycle. When you select a phone as a primary phone, it appears first in the list and the system marks it with an asterisk.
Set Bluetooth	Turn the Bluetooth feature on and off. Press <b>OK</b> and scroll to toggle between On and Off. Make a selection, and then press <b>OK</b> . Setting Bluetooth to off disconnects all Bluetooth devices and turns off all Bluetooth features.
Delete Device	Delete a paired phone. Press <b>OK</b> and scroll to select the device. Press <b>OK</b> to confirm.
Delete All Devices	Delete all previously paired phones (and all information originally saved with those phones). Press <b>OK</b> to select.
Return	Exit the current menu.

\* This is a speed-dependent feature.

\*\*You can only connect one device at a time. When another phone is connected, the previous one is disconnected.

## SYNC™ (If Equipped)

### Advanced

The Advanced menu allows you to access and set prompts, languages, defaults, perform a master reset, install an application and view system information.

1. Press the phone button to enter the phone menu
2. Scroll to System Settings. Press **OK**.
3. Scroll to Advanced. Press **OK**.
4. Scroll to select from the following options:

If you select:	You can:
Prompts	Get help from SYNC by using questions, helpful hints or asking you for a specific action. To turn these prompts on or off: 1. Press <b>OK</b> to select and scroll to select between On and Off. 2. Press <b>OK</b> when the desired selection appears in the display. SYNC takes you back to the Advanced menu.
Languages	Choose between English, Français and Español. Once selected, all of the radio displays and prompts are in the selected language. 1. Press <b>OK</b> to select and then scroll through the languages. 2. Press <b>OK</b> when the desired selection appears in the display. If you change the language setting, the display indicates that the system is updating. When complete, SYNC takes you back to the Advanced menu.
Factory Defaults	Return to the factory default settings. This selection does not erase your indexed information (phonebook, call history, text messages and paired devices). 1. Press <b>OK</b> to select and then press <b>OK</b> again when <b>Restore Defaults?</b> appears in the display. 2. Press <b>OK</b> to confirm.
Master Reset	Completely erase all information stored on SYNC (phonebook, call history, text messages and paired devices) and return to the factory default settings. Press <b>OK</b> to select. The display indicates when complete and SYNC takes you back to the Advanced menu.
Install Application?	Install applications you have downloaded. Press <b>OK</b> and scroll to select. Press <b>OK</b> to confirm.
Delete All Devices	Delete all previously paired phones (and all information originally saved with those phones). Press <b>OK</b> to select.
System Info	Access the Auto Version number as well as the FDN number.

## SYNC™ (If Equipped)

If you select:	You can:
	Press <b>OK</b> to select.
MAP Profile	This is a Bluetooth component, which can further help your phone with the exchange of text messages.
Return	Exit the current menu.

### SYNC™ APPLICATIONS AND SERVICES (If Equipped)

In order for the following features to work, your cellular phone must be compatible with SYNC. To check your phone's compatibility, visit [www.SYNCMYRide.com](http://www.SYNCMYRide.com), [www.SYNCMYRide.ca](http://www.SYNCMYRide.ca) or [www.syncmaroute.ca](http://www.syncmaroute.ca).

- SYNC Services\*: Provides access to traffic, directions and information such as travel, horoscopes, stock prices and more.
- 911 Assist: Can alert 911 in the event of an emergency.
- Vehicle Health Report\*: Provides a diagnostic and maintenance report card of your vehicle.
- SYNC AppLink: Allows you to connect to and use certain applications such as Pandora and Stitcher (if your phone is compatible).

\*This is an optional feature and available in the United States only.

### 911 Assist (If Equipped)

#### WARNINGS



Unless the 911 Assist setting is set on before a crash, the system will not dial for help which could delay response time, potentially increasing the risk of serious injury or death after a crash.

#### WARNINGS



Do not wait for 911 Assist to make an emergency call if you can do it yourself. Dial emergency services immediately to avoid delayed response time which could increase the risk of serious injury or death after a crash. If you do not hear 911 Assist within five seconds of the crash, the system or phone may be damaged or non-functional.



Always place your phone in a secure location in your vehicle so it does not become a projectile or get damaged in a crash. Failure to do so may cause serious injury to someone or damage the phone which could prevent 911 Assist from working properly.

**Note:** The SYNC 911 Assist feature must be set on before the incident.

**Note:** Before setting this feature on, make sure that you read the 911 Assist Privacy Notice later in this section for important information.

**Note:** If any user turns 911 Assist on or off, that setting applies for all paired phones. If 911 Assist is turned off, either a voice message plays or a display message (or icon) comes on (or both) when your vehicle is started after a previously paired phone connects.

**Note:** Every phone operates differently. While SYNC 911 Assist works with most cellular phones, some may have trouble using this feature.

If a crash deploys an airbag (excluding knee airbags and rear inflatable safety belts [if equipped]) or activates the fuel pump shut-off, your SYNC-equipped vehicle may be able to contact emergency services by dialing 911 through a paired and connected Bluetooth-enabled phone. You can learn more about the 911 Assist feature, visit [www.SYNCMyRide.com](http://www.SYNCMyRide.com), [www.SYNCMyRide.ca](http://www.SYNCMyRide.ca) or [www.syncmaroute.ca](http://www.syncmaroute.ca).

See **Supplementary Restraints System** (page 36). Important information about airbag deployment is in this chapter.

See **Roadside Emergencies** (page 212). Important information about the fuel pump shut-off is in this chapter.

### Setting 911 Assist On or Off

1. Press the phone button to enter the phone menu.
2. Scroll to select 911 Assist.
3. Press **OK** to confirm and enter the 911 Assist menu.
4. Scroll to select between On or Off.
5. Press **OK** when the desired option appears in the radio display. **Set On** or **Set Off** appears in the display as confirmation.

Off selections include:

- Off with reminder: Provides a display and voice reminder at phone connection at vehicle start.
- Off without reminder: Provides a display reminder only without a voice reminder at phone connection.

To make sure that 911 Assist works properly:

- SYNC must be powered and working properly at the time of the incident and throughout feature activation and use.
- The 911 Assist feature must be set on before the incident.

- You must pair and connect a Bluetooth-enabled and compatible cell phone to SYNC.
- A connected Bluetooth-enabled phone must have the ability to make and maintain an outgoing call at the time of the incident.
- A connected Bluetooth-enabled phone must have adequate network coverage, battery power and signal strength.
- The vehicle must have battery power and be located in the U.S., Canada or in a territory in which 911 is the emergency number.

### In the Event of a Crash

Not all crashes will deploy an airbag or activate the fuel pump shut-off (the triggers for 911 Assist). If a connected cell phone sustains damage or loses its connection to SYNC during a crash, SYNC will search for and try to connect to a previously paired cell phone; SYNC will then attempt to call the emergency services.

Before making the call:

- SYNC provides a short window of time (about 10 seconds) to cancel the call. If you fail to cancel the call, SYNC attempts to dial 911.
- SYNC says the following, or a similar message: "SYNC will attempt to call 911, to cancel the call, press Cancel on your screen or press and hold the phone button on your steering wheel."

If you do not cancel the call, and SYNC makes a successful call, a pre-recorded message plays for the 911 operator, and then the occupant(s) in your vehicle is able to talk with the operator. Be prepared to provide your name, phone number and location immediately, because not all 911 systems are capable of receiving this information electronically.

## 911 Assist May Not Work If

- Your cellular phone or 911 Assist hardware sustains damage in a crash.
- The vehicle's battery or the SYNC system has no power.
- The phone(s) previously paired or connected to the system are thrown from your vehicle.

## 911 Assist Privacy Notice

When you turn on 911 Assist, it may disclose to emergency services that your vehicle has been in a crash involving the deployment of an airbag or activation of the fuel pump shut-off. Certain versions or updates to 911 Assist may also be capable of electronically or verbally disclosing to 911 operators your vehicle location or other details about your vehicle or crash to assist 911 operators to provide the most appropriate emergency services. If you do not want to disclose this information, do not turn the feature on.

## Vehicle Health Report

### WARNING



Always follow scheduled maintenance instructions, regularly inspect your vehicle, and seek repair for any damage or problem you suspect. Vehicle Health Report supplements, but cannot replace, normal maintenance and vehicle inspection. Vehicle Health Report only monitors certain systems electronically monitored by your vehicle and will not monitor or report the status of any other system, (such as brake lining wear). Failure to perform scheduled maintenance and regularly inspect your vehicle may result in vehicle damage and serious injury.

**Note:** This feature is only available in the United States.

**Note:** Your Vehicle Health Report feature requires activation before use. Visit [www.SYNCMYRIDE.com](http://www.SYNCMYRIDE.com) to register. There is no fee or subscription associated with Vehicle Health Report, but you must register to use this feature.

**Note:** This feature may not function properly if you have enabled caller ID blocking on your cellular phone. Before running a report, review the Vehicle Health Report Privacy Notice.

**Note:** In order to allow a break-in period for your vehicle, you may not be able to create a Vehicle Health Report until your vehicle odometer has reached 200 miles.

**Note:** Cellular phone and SMS charges may apply when making a report.

Register for Vehicle Health Report and set your report preferences at [www.SYNCMYRIDE.com](http://www.SYNCMYRIDE.com). After registering, you can request a Vehicle Health Report (inside your vehicle). Return to your account at [www.SYNCMYRIDE.com](http://www.SYNCMYRIDE.com) to view your report. You can also choose for SYNC to remind you automatically to run reports at specific mileage intervals.

The system allows you to check your vehicle's overall health in the form of a diagnostic report card. The Vehicle Health Report contains valuable information such as:

- Vehicle diagnostic information
- Scheduled maintenance
- Open recalls and Field Service Actions
- Items noted during vehicle inspections by an authorized dealer that still need servicing.

You can run a report (after your vehicle has been running a minimum of 60 seconds) by pressing the voice button and saying "Vehicle Health Report", or pressing the phone button.

To run a report using the phone button:

## SYNC™ (If Equipped)

1. Press the phone button to enter phone menu.
2. Scroll to select Vehicle Health, and then press **OK**.
3. Scroll to select from the following options:

Vehicle Health Report options	
User Preferences: Press <b>OK</b> to select and enter the menu. Scroll to select from:	<b>Automatic Reports:</b> Press <b>OK</b> to and select On or Off. Select On to have SYNC automatically prompt you to run a health report at certain mileage intervals.*
	<b>Mileage Intervals:</b> Press <b>OK</b> . Scroll to select between 5000, 7500 or 10000-mile intervals and press <b>OK</b> to make your selection.
	<b>Return:</b> Press OK to exit the menu.
Run Report?	Press <b>OK</b> for SYNC to run a health report of your vehicle's diagnostic systems and send the results to Ford where it combines with scheduled maintenance information, open recalls and other field service actions and vehicle inspection items that still need servicing from an authorized dealer.
Return	Exit the current menu.

\*You must first turn this feature on before you can select the desired mileage interval.

### Vehicle Health Report Privacy Notice

When you create a Vehicle Health Report, Ford Motor Company may collect your cellular phone number (to process your report request) and diagnostic information about your vehicle. Certain versions or updates to Vehicle Health Report may also collect more vehicle information. Ford may use your vehicle information it collects for any purpose. If you do not want to disclose your cellular phone number or vehicle information, do not run the feature or set up your Vehicle Health Report profile at [www.SYNCMYRide.com](http://www.SYNCMYRide.com). See [www.SYNCMYRide.com](http://www.SYNCMYRide.com) (Vehicle Health Report Terms and Conditions, and Privacy Statement) for more information.

### SYNC Services: Traffic, Directions & Information (TDI) (If Equipped, Unites States Only)

**Note:** SYNC Services varies by trim level and model year and may require a subscription. Traffic alerts and turn-by-turn directions available in select markets. Message and data rates may apply. Ford Motor Company reserves the right to change or discontinue this product service at any time without prior notification or incurring any future obligation.



**Note:** SYNC Services requires activation before use. Visit [www.SYNCMyRide.com](http://www.SYNCMyRide.com) to register and check your eligibility for complimentary services. Standard phone and message rates may apply. Subscription may be required. You must also have the active SYNC Services Bluetooth-enabled cellular phone paired and connected to the system in order to connect to, and use, SYNC Services. See **Using SYNC™ With Your Phone** (page 327).

**Note:** This feature does not function properly if you have enabled caller ID blocking on your cellular phone. Make sure your cellular phone is not blocking caller ID before using SYNC Services.

**Note:** The driver is ultimately responsible for the safe operation of the vehicle, and therefore, must evaluate whether it is safe to follow the suggested directions. Any navigation features provided are only an aid. Make your driving decisions based on your observations of local conditions and existing traffic regulations. Do not follow the route suggestions if doing so would result in an unsafe or illegal maneuver, place you in an unsafe situation, or if you would be directed into an area that you consider unsafe. Maps used by this system may be inaccurate because of errors, changes in roads, traffic conditions or driving conditions.

**Note:** When you connect, the service uses GPS technology and advanced vehicle sensors to collect your vehicle's current location, travel direction and speed to help provide you with the directions, traffic reports, or business searches you request. Further, to provide the services you request, for continuous improvement, the service may collect and record call details and voice communications. For more information, see SYNC Services Terms and Conditions at [www.SYNCMyRide.com](http://www.SYNCMyRide.com). If you do not want Ford or its service providers to collect your vehicle travel information or other information identified in the Terms and Conditions, do not subscribe or use the service.

SYNC Services uses advanced vehicle sensors, integrated GPS technology and comprehensive map and traffic data, to give you personalized traffic reports, precise turn-by-turn directions, business search, news, sports, weather and more. For a complete list of services, or to learn more, please visit [www.SYNCMyRide.com](http://www.SYNCMyRide.com).

### Connecting to SYNC Services Using Voice Commands

1. Press the voice button.
2. When prompted, say "Services". This initiates an outgoing call to SYNC Services using your paired and connected Bluetooth-enabled cellular phone.
3. Once you connect to the service, follow the voice prompts to request the desired service, such as Traffic or Directions. You can also say, "What are my choices?" to receive a list of available services from which to choose.
4. Say, "Services" to return to the Services main menu or for help, say, "Help".

## Connecting to SYNC Services Using the Phone Menu

1. Press the phone button to enter the phone menu.
2. Scroll to Services.
3. Press **OK** to confirm and enter the Services menu. The display indicates the system is connecting.
4. Press **OK**. SYNC initiates the call to the Services portal.
5. Once you connect to the service, follow the voice prompts to request the desired service, such as Traffic or Directions. You can also say, "What are my choices?" to receive a list of available services from which to choose.
6. Say, "Services" to return to the Services main menu or for help, say, "Help".

## Receiving Turn-by-Turn Directions

1. When connected to SYNC Services, say "Directions" or "Business search". To find the closest business or type of business to your current location, just say "Business search" and then "Search near me". If you need further assistance in finding a location you can say "Operator" at any time within a Directions or Business search to speak with a live operator. The system may prompt you to speak with an operator when it has difficulty matching your voice request. The live operator can

assist you by searching for businesses by name or by category, residential addresses by street address or by name or specific street intersections. Operator Assist is a feature of your SYNC Services subscription. For more information on Operator Assist, visit [www.SYNCMyRide.com/support](http://www.SYNCMyRide.com/support).

2. Follow the voice prompts to select your destination. Once you select your destination, the system uploads your current vehicle location, calculates a route based on current traffic conditions and sends it back to your vehicle. After the route download is complete, the phone call automatically ends. You then receive audible and visual driving instructions as you travel toward your destination.
3. While on an active route, you can select or say "Route summary" or "Route status" to view the Route Summary turn list or the Route Status ETA. You can also turn voice guidance on or off, cancel the route or update the route.

If you miss a turn, SYNC automatically asks if you want the route updated. Just say, "Yes" when prompted and the system sends a new route to your vehicle.

## Disconnecting from SYNC Services

1. Press and hold the phone button on the steering wheel.
2. Say "Goodbye" from the SYNC Services main menu.

SYNC Services quick tips	
Personalizing	You can personalize your Services feature to provide quicker access to your most used or favorite information. You can save address points such as work or home. You can also save favorite information like sports teams or a news category. You can learn more about personalization by logging onto <a href="http://www.SYNCMyRide.com">www.SYNCMyRide.com</a> .
Push to interrupt	Press the voice button at any time (while connected to SYNC Services) to interrupt a voice prompt or an audio clip (such as a sports report) and say your voice command.
Portable	Your subscription is associated with your Bluetooth-enabled cellular phone number, not your VIN (Vehicle Identification Number). You can pair and connect your phone to any vehicle equipped with SYNC Services and continue enjoying your personalized services. You can even access your account outside your vehicle. Just use the number on your phone's call history. Traffic and Directions features do not function properly but information services and the 411 connect and text message features are available.

## SYNC AppLink

**Note:** This feature is only available in the United States.

**Note:** You must pair and connect your smartphone to SYNC to access AppLink.

**Note:** iPhone users need to connect the phone to the USB port in order to start the application. We recommend you lock your iPhone after starting an application.

**Note:** The AppLink feature is not available if your vehicle is equipped with the MyFord Touch or MyLincoln Touch system.

**Note:** Depending on your display type, you can access AppLink from the media menu, the phone menu, or by using voice commands. Once an app is running through AppLink, you can control main features of the app through voice commands and steering wheel controls.

## To Access Using the Phone Menu

1. Press the phone button to access the SYNC phone menu on-screen.
2. Scroll to Mobile Apps and press OK to access a list of available applications.
3. Scroll through the list of available applications and press OK to select a particular app.
4. Once an app is running through SYNC, you can access an app's menu by pressing the **MENU** button to first access the SYNC menu.
5. Select "SYNC-Media" by pressing **OK**.
6. Scroll until "<App name> Menu" is displayed (such as, Pandora Menu), then press **OK**. From here, you can access an application's features, such as Thumbs up and Thumbs down. For more information, please visit [www.SYNCMyRide.com](http://www.SYNCMyRide.com).

### To Access Using the Media Menu

1. Press the **AUX** button on the center console.
2. Press **MENU** to access the SYNC menu.
3. Select "SYNC-Media" by pressing **OK**.
4. Scroll to Mobile Apps and press **OK** to access a list of available applications.
5. Scroll through the list of available applications and press **OK** to select a particular app.
6. Once an app is running through SYNC, you can access an app's menu by pressing the **MENU** button to first access the SYNC menu.
7. Select "SYNC-Media" by pressing **OK**.
8. Scroll until "<App name> Menu" is displayed (such as, Pandora Menu), then press **OK**. From here, you can access an application's features, such as Thumbs up and Thumbs down. For more information, please visit [www.SYNCMyRide.com](http://www.SYNCMyRide.com).

### To Access Using Voice Commands

1. Press the voice icon.
2. When prompted, say "Mobile Apps".
3. Say the name of the application after the tone.
4. The app should start. While an app is running through SYNC, you can press the voice button and speak commands specific to the app, such as "Play Station Quickmix". Say "Help" to discover available voice commands.

## USING SYNC™ WITH YOUR MEDIA PLAYER

You can access and play music from your digital music player over your vehicle's speaker system using the system's media menu or voice commands. You can also sort and play your music by specific categories, such as artist and album.

**Note:** *The system is capable of indexing up to 6,000 songs.*

SYNC is capable of hosting nearly any digital media player including: iPod®, Zune™, Plays from device players, and most USB drives. SYNC also supports audio formats, such as MP3, WMA, WAV and ACC.

### Connecting Your Digital Media Player to the USB Port

**Note:** *If your digital media player has a power switch, make sure you switch it on before plugging it in.*

### To Connect Using Voice Commands

1. Plug the device into the USB port.
2. Press the voice icon and when prompted, say "USB".
3. You can now play music by saying any of the appropriate voice commands. See the media voice commands.

### To Connect Using the System Menu

1. Plug the device into the USB port.
2. Press **AUX** and then **MENU** to enter the media menu.
3. Scroll to Select Source. Press **OK**.
4. Scroll to USB. Press **OK**.
5. Depending on how many digital media files are on your connected device, **Indexing** may appear in the radio display. When indexing is complete, the screen returns to the Play menu.

# SYNC™ (If Equipped)

Press **OK** and scroll through selections of:

- Play All
- Albums
- Genres
- Playlists
- Tracks
- Explore USB
- Similar Music
- Return

## What's Playing?

At any time when a track is playing, you can press the voice icon and ask the system "What's playing?". The system reads the metadata tags (if populated) of the playing track to you.

## Media Voice Commands



Press the voice icon. When prompted, say "USB", then any of the following:

"USB"
"Autoplay off"
"Autoplay on"
"Connections"
"Pause"
"Play"
"Play album <name>" <sup>1,2</sup>
"Play all"
"Play artist <name>" <sup>1,2</sup>
"Play genre <name>" <sup>1,2</sup>
"Play next folder" <sup>3</sup>
"Play next track"

"USB"
"Play playlist <name>" <sup>1,2</sup>
"Play previous folder" <sup>3</sup>
"Play previous track"
"Play song <name>" <sup>1,2</sup>
"Play track <name>" <sup>1,2</sup>
"Refine album <name>" <sup>1,2</sup>
"Refine artist <name>" <sup>1,2</sup>
"Refine song <name>" <sup>1,2</sup>
"Refine track <name>" <sup>1,2</sup>
"Repeat off"
"Repeat on"
"Search album <name>" <sup>1,2</sup>
"Search artist <name>" <sup>1,2</sup>
"Search genre <name>" <sup>1,2</sup>
"Search song <name>" <sup>1,2</sup>
"Search track <name>" <sup>1,2</sup>
"Shuffle off"
"Shuffle on"

## SYNC™ (If Equipped)

<b>"USB"</b>
"Similar music"
"What's playing?"

<sup>1</sup> <name> is a dynamic listing, meaning that it could be the name of anything, such as a group, artist or song.

<sup>2</sup> This voice command is not available until indexing is complete.

<sup>3</sup> This voice command is only available in folder mode.

<b>Voice command guide</b>	
"Autoplay"	Turn autoplay on to listen to music processed during indexing. Turn autoplay off to allow the indexing process to finish before the system plays any of your music.*
"Search genre" or "Play genre"	The system searches all the data from your indexed music and, if available, begins to play the chosen type of music. You can only play genres of music that are present in the GENRE metadata tags that you have on your digital media player.
"Similar music"	The system compiles a playlist and then plays music similar to what is currently playing from the USB port using indexed metadata information.
"Search" or "Play" artist, track or album	The system searches for specific artist, track or album information from the music indexed through the USB port.
"Refine"	This allows you to make your previous command more specific. For example, if you asked to search and play all music by a certain artist, you could then say, "Refine album" and choose a specific album from the list to view. If you then select Play, the system only plays music from that specific album.

\*Indexing times can vary from device to device and with regard to the number of songs the system needs to process.

Press the voice icon. When prompted, say, "Bluetooth audio", then any of the following:

<b>"BLUETOOTH AUDIO"</b>
"Connections"
"Pause"
"Play"
"Play next track"
"Play previous track"

## SYNC™ (If Equipped)

### Media Menu Features

The media menu allows you to select your media source, how to play your music (such as by artist, genre, shuffle or repeat),

and also to add, connect or delete devices.

1. Press **AUX** and then **MENU** to enter the media menu.
2. Scroll to cycle through:

When you select:	You can:
Play Menu	Play your music by artist, album, genre, playlist, track, similar music or play all music. You can also choose to Explore USB to view the supported digital music files on your playing device.
Select Source	Select and play music from your USB port, auxiliary input jack (line in) or stream music from your Bluetooth-enabled phone.
	SYNC USB: Press <b>OK</b> to access music plugged into your USB port. You can also plug in devices to charge them (if supported by your device). Once connected, the system indexes any readable media files. <sup>1</sup>
	Bluetooth Audio: This is a phone-dependent feature that allows you to stream music playing on your Bluetooth-enabled phone. If supported by your device, you can press <b>SEEK</b> to play the previous or next track.
Media Settings	SYNC Line In: Press <b>OK</b> to select and play music from your portable music player over your vehicle's speakers. <sup>2</sup>
	Choose to shuffle or repeat your music and select your Autoplay settings. Once you turn these selections on, they remain on until you turn them off. Press <b>SEEK</b> to play the previous or next track. <sup>3</sup>
	Shuffle: Press <b>OK</b> to shuffle available media files in the current playlist. To shuffle all media tracks, you must select Play All in the play menu and then select Shuffle.
	Repeat: Press <b>OK</b> to repeat any song.
Mobile Apps	Autoplay: Turn autoplay on to listen to music processed during indexing. Turn autoplay off to allow the indexing process to finish before the system plays any of your music. <sup>4</sup>
	Interact with SYNC-capable mobile applications on your smartphone.

## SYNC™ (If Equipped)

When you select:	You can:
System Settings	Access Bluetooth Device menu listings (Add, Connect, Set as Primary, On and Off, Delete) as well as Advanced menu listings (prompts, languages, defaults, master reset, install application and system information).
Exit Media Menu	Press <b>OK</b> to exit the media menu.

<sup>1</sup>The time required to complete this depends on the size of the media the system needs to index. If autoplay is on, you can listen to media processed during indexing. If autoplay is off, you cannot listen to music until the system finishes indexing media. SYNC is capable of indexing thousands of average size media and notifies you if it reaches the maximum indexing file size.

<sup>2</sup>If you have already connected a device to the USB port, you cannot access the line in feature. Some digital media players require both USB and line in ports to stream data and music separately.

<sup>3</sup>Some digital media players require both USB and line in ports to stream data and music separately

<sup>4</sup>Indexing times can vary from device to device and with regard to the number of songs the system needs to process.

### Accessing Your Play Menu

This menu allows you to select and play your media by artist, album, genre, playlist, track, similar music or even to explore what is on your USB device.

**Note:** *If your digital media player has a power switch, make sure you switch it on before plugging it in.*

1. Press **AUX** and then **MENU** to enter the media menu.
2. Scroll to Play. Press **OK**.

If there are no media files to access, the display indicates there is no media. If there are media files, you have the following options:

When you select:	You can:
Play All	Play all indexed media (tracks) from your playing device in flat file mode, one at a time in numerical order. Press <b>OK</b> to select. The first track title appears in the display.
Artists	Sort all indexed media by artist. Once selected, the system lists and then play all artists and tracks alphabetically. If there are fewer than 255 indexed artists, the system lists them alphabetically in flat file mode. If there are more than 255, the system categorizes them alphabetically.



## SYNC™ (If Equipped)

When you select:	You can:
	1. Press <b>OK</b> to select. You can select to play All Artists or any indexed artist. 2. Scroll to choose the desired artist. Press <b>OK</b> .
Albums	Sort all indexed media by albums. If there are fewer than 255 indexed albums, the system lists them alphabetically in flat file mode. If there are more than 255, the system categorizes them alphabetically. 1. Press <b>OK</b> to enter the album menu and select from playing all albums or from any individual indexed album. 2. Scroll to choose the desired album. Press <b>OK</b> .
Genres	Sort indexed music by genre (category) type. SYNC lists the genres alphabetically in flat file mode. If there are more than 255, the system categorizes them alphabetically. 1. Press <b>OK</b> to select. 2. Scroll to select the desired genre. Press <b>OK</b> .
Playlists	Access your playlists (from formats, such as .ASX, .M3U, .WPL or .MTP). The system lists your playlists alphabetically in flat-file mode. If there are more than 255, the system categorizes them alphabetically. 1. Press <b>OK</b> to select. 2. Scroll to select the desired playlist. Press <b>OK</b> .
Tracks	Search for and play a specific indexed track. SYNC lists your tracks alphabetically in flat file mode. If there are more than 255, the system categorizes them alphabetically. 1. Press <b>OK</b> to select. 2. Scroll to select the desired track. Press <b>OK</b> .
Explore USB	Explore all supported digital media on your media device connected to the USB port. You can only view media content which is compatible with SYNC; other files saved are not visible. 1. Press <b>OK</b> to select. 2. Scroll to explore indexed media on your flash drive.
Similar Music*	Play music similar to what is currently playing from the USB port. The system uses the metadata information of each song to compile a playlist for you.

## SYNCTM (If Equipped)

When you select:	You can:
	Press <b>OK</b> to select. The system creates a new list of similar songs and begins playing. This feature does not include tracks with incomplete metadata information.
Return	Exit the current menu.

\*With certain playing devices, if your metadata tags are not populated, the tracks are not available in voice recognition, play menu or similar music. However, if you place these tracks onto your playing device in "Mass Storage Device Mode", they are available in voice recognition, play menu browsing and similar music. The system places Unknown items into any unpopulated metadata tag.

## System Settings

### Bluetooth Devices

The Bluetooth Devices menu allows you to add, connect and delete a device as turn the Bluetooth feature on and off.

1. Press **AUX** and then **MENU** to enter the media menu.
2. Scroll to System Settings. Press **OK**.
3. Scroll to Bluetooth Devices. Press **OK**.

When you select:	You can:
Add Bluetooth Device*	Pair more devices to the system. 1. Press <b>OK</b> to select and press <b>OK</b> again when <b>Find SYNCTM</b> appears in the display. 2. Follow the directions in your phone's manual to put your phone into discovery mode. A six-digit PIN appears in the display. 3. When prompted on your phone's six-digit display, enter the PIN.
Connect Bluetooth Device	Connect a previously paired Bluetooth-enabled device. 1. Press <b>OK</b> to select and view a list of previously paired devices. 2. Scroll until you find the desired device, and then press <b>OK</b> to connect the device.
Set Bluetooth	Turn the Bluetooth feature on and off.** 1. Press <b>OK</b> and scroll to toggle between On and Off. 2. Make a selection, and then press <b>OK</b> .
Delete Device	Delete a paired media device. 1. Press <b>OK</b> and scroll to select the device. 2. Press <b>OK</b> to confirm.
Delete All Devices	Delete all previously paired devices.

## SYNC™ (If Equipped)

When you select:	You can:
	Press <b>OK</b> to select.
Return	Exit the current menu.

\*This is a speed-dependent feature.

\*\*Setting Bluetooth to off disconnects all Bluetooth devices and turns off all Bluetooth features.

### Advanced

The Advanced menu allows you to access and set prompts, languages, defaults and perform a master reset.

1. Press **AUX** and then **MENU** to enter the media menu.
2. Scroll to System Settings. Press **OK**.
3. Scroll to Advanced. Press **OK**.

When you select:	You can:
Prompts	Have SYNC guide you by asking questions, helpful hints or ask you for a specific action. 1. Press <b>OK</b> to select and scroll to select between on or off. 2. Press <b>OK</b> when the desired selection appears in the display. SYNC takes you back to the Advanced menu.
Languages	Choose from English, Français or Español. The displays and prompts are in the selected language. 1. Press <b>OK</b> to select and then scroll through the languages. 2. Press <b>OK</b> when the desired selection appears in the display. 3. If you change the language setting, the display indicates that the system is updating. When complete, SYNC takes you back to the Advanced menu.
Factory Defaults	Return to the factory default settings. This selection does not erase your indexed information (phonebook, call history, text messages and paired devices). 1. Press <b>OK</b> to select. 2. Press <b>OK</b> again when <b>Restore Defaults?</b> appears in the display. 3. Press <b>OK</b> to confirm.

## SYNC™ (If Equipped)

When you select:	You can:
Master Reset	Completely erase all information stored on SYNC (all phonebook, call history, text messages and all paired devices) and return to the factory default settings.
Application	Download new software applications (if available) and then load the desired applications through your USB port. See the web site for more information.
Return	Exit the current menu.

### SYNC™ TROUBLESHOOTING

Your SYNC system is easy to use. However, should questions arise, see the tables below.

Use the website at any time to check your phone's compatibility, register your account and set preferences as well as access a customer representative via an online chat (during certain hours). Visit [www.SYNCMYRide.com](http://www.SYNCMYRide.com), [www.SYNCMYRide.ca](http://www.SYNCMYRide.ca) or [www.syncmaroute.ca](http://www.syncmaroute.ca) for more information.

Phone issues		
Issue	Possible cause(s)	Possible solution(s)
There is excessive background noise during a phone call.	The audio control settings on your phone may be affecting SYNC performance.	Review your phone's manual about audio adjustments.
During a call, I can hear the other person but they cannot hear me.	This may be a possible phone malfunction.	Try turning off the device, resetting the device, removing the device's battery, then trying again.
SYNC is not able to download my phonebook.	This is a phone-dependent feature. This may be a possible phone malfunction.	Go to the website to review your phone's compatibility. Try turning off the device, resetting the device or removing the device's battery, then trying again. Try pushing your phonebook contacts to SYNC by using the Add Contacts feature. Use the SYNCmyphone feature available on the website.

## SYNC™ (If Equipped)

<b>Phone issues</b>		
<b>Issue</b>	<b>Possible cause(s)</b>	<b>Possible solution(s)</b>
The system says Phonebook Downloaded but the phonebook in SYNC is empty or missing contacts.	This may be a limitation on your phone's capability.	Try pushing your phonebook contacts to SYNC by using the Add Contacts feature. If the missing contacts are stored on your SIM card, try moving them to the device memory. Remove any pictures or special ring tones associated with the missing contact. Depending upon your phone, you may have to grant SYNC permission to access your phonebook contacts. Make sure to confirm when prompted by your phone during the phonebook download.
I am having trouble connecting my phone to SYNC.	This is a phone-dependent feature. This may be a possible phone malfunction.	Go to the website to review your phone's compatibility. Try turning off the device, resetting the device or removing the device's battery, then trying again. Try deleting your device from SYNC, deleting SYNC from your device and trying again. Check the security and auto accept and prompt always settings relative to the SYNC Bluetooth connection on your phone. Update your device's firmware. Turn off the Auto phonebook download setting.
Text messaging is not working on SYNC.	This is a phone-dependent feature.	Go to the website to review your phone's compatibility.

## SYNC™ (If Equipped)

<b>Phone issues</b>		
<b>Issue</b>	<b>Possible cause(s)</b>	<b>Possible solution(s)</b>
	This may be a possible phone malfunction.	Try turning off the device, resetting the device or removing the device's battery, then trying again.

<b>USB and media issues</b>		
<b>Issue</b>	<b>Possible cause(s)</b>	<b>Possible solution(s)</b>
I am having trouble connecting my device.	This may be a possible device malfunction.	Try turning off the device, resetting the device, removing the device's battery, then trying again. Make sure you are using the manufacturer's cable. Make sure you insert the USB cable correctly into the device and the USB port. Make sure that the device does not have an auto-install program or active security settings.
SYNC does not recognize my device when I turn on the car.	This is a device limitation.	Make sure you are not leaving the device in your vehicle during very hot or cold temperatures.
Bluetooth audio does not stream.	This is a phone-dependent feature. The device is not connected.	Review the device compatibility chart on the SYNC website to confirm your phone supports the Bluetooth audio streaming function. Make sure you correctly connect the device to SYNC, and that you have pressed play on your device.
SYNC does not recognize music that is on my device.	Your music files may not contain the correct artist, song title, album or genre information.	Make sure that all song details are populated.

## SYNC™ (If Equipped)

<b>USB and media issues</b>		
<b>Issue</b>	<b>Possible cause(s)</b>	<b>Possible solution(s)</b>
	The file may be corrupted. The song may have copy-right protection, which does not allow it to play.	Some devices require you to change the USB settings from mass storage to MTP class.

<b>Vehicle Health Report and Services (Traffic, Directions and Information) issues</b>		
<b>Issue</b>	<b>Possible cause(s)</b>	<b>Possible solution(s)</b>
I received a text that I did not activate Vehicle Health Report.	You did not activate your account on the website. You may have the wrong VIN (vehicle identification number) listed.	This is a free feature, but you must first register online to use it. Make sure that your VIN is correctly listed in your account.
I am unable to retrieve the report on the website, or I receive a system error.	The preferred dealer information did not load correctly.	When you register your account, you must choose a preferred dealer. If it already lists a dealer, try selecting another dealer and logging out. Log back in, change it back to your preferred dealer, and retrieve the report.
I am unable to submit a report.	This could be due to your phone's compatibility. Bad signal strength. You did not register your phone correctly on the website.	Update your cellular number in your account on the website. Make sure you have full signal strength and that your Bluetooth volume level has been turned up. Make sure the currently connected phone is registered on your SYNCMyRide account. Try deleting your phone and performing a clean pairing.
I heard a commercial when I tried to use Traffic, Directions and Information.	You did not activate this phone for this service. Your phone has ID blocker active.	This is a free feature, but you must first register online to use it.

## SYNC™ (If Equipped)

<b>Vehicle Health Report and Services (Traffic, Directions and Information) issues</b>		
<b>Issue</b>	<b>Possible cause(s)</b>	<b>Possible solution(s)</b>
		<p>Turn off ID blocker on your phone as the system recognizes you by your phone number.</p> <p>Make sure the currently connected phone is the same one that is registered on your SYNCMyRide account.</p>

<b>Voice command issues</b>		
<b>Issue</b>	<b>Possible cause(s)</b>	<b>Possible solution(s)</b>
SYNC does not understand what I am saying.	<p>You may be using the wrong voice commands.</p> <p>You may be speaking too soon or at the wrong time.</p>	<p>Review the phone voice commands and the media voice commands at the beginning of their respective sections.</p> <p>After pressing the voice icon, wait until after the tone sounds and Listening appears before saying a command. Any command spoken before this does not register with the system.</p>
SYNC does not understand the name of a song or artist.	<p>You may be using the wrong voice commands.</p> <p>You may be saying the name differently than the way you saved it.</p> <p>The system may not be reading the name the same way you are saying it.</p>	<p>Review the media voice commands at the beginning of the media section.</p> <p>Say the song or artist exactly as listed. If you say "Play Artist Prince", the system does not play music by Prince and the Revolution or Prince and the New Power Generation.</p> <p>Make sure you are saying the complete title, such as "California remix featuring Jennifer Nettles".</p>



## SYNC™ (If Equipped)

<b>Voice command issues</b>		
<b>Issue</b>	<b>Possible cause(s)</b>	<b>Possible solution(s)</b>
		<p>If the song titles are in all CAPS, you have to spell them. LOLA requires you to say "L-O-L-A".</p> <p>Do not use special characters in the title. The system does not recognize them.</p>
<p>SYNC does not understand or is calling the wrong contact when I want to make a call.</p>	<p>You may be using the wrong voice commands.</p> <p>You may be saying the name differently than the way you saved it.</p> <p>The system may not be reading the name the same way you are saying it.</p> <p>Contacts in your phonebook may be very short and similar, or they may contain special characters.</p> <p>Your phonebook contacts may be in CAPS.</p>	<p>Review the Phone voice commands at the beginning of the phone section.</p> <p>Make sure you are saying the contacts exactly as they are listed. For example, if you save a contact as Joe Wilson, say "Call Joe Wilson".</p> <p>Using the SYNC phone menu, open the phonebook and scroll to the name SYNC is having trouble understanding. SYNC will read the name to you, giving you some idea of the pronunciation SYNC is expecting.</p> <p>The system works better if you list full names, such as "Joe Wilson" rather than "Joe".</p> <p>Do not use special characters, such as 123 or ICE, as the system does not recognize them.</p> <p>If a contact is in CAPS, you have to spell it. JAKE requires you to say "Call J-A-K-E".</p>

## SYNC™ (If Equipped)

<b>AppLink issues</b>		
<b>Issue</b>	<b>Possible cause(s)</b>	<b>Possible solution(s)</b>
AppLink Mobile Applications: When I select "Find New Apps," SYNC does not find any applications.	An AppLink capable phone is not connected to SYNC.	Ensure you have a compatible smartphone; an Android with OS 2.3 or higher or an iPhone 3GS or newer with iOS 5.0 or higher. Additionally, ensure your phone is paired and connected to SYNC in order to find AppLink-capable apps on your device. iPhone users must also connect to SYNC's USB port with an Apple USB cable.
My phone is connected, but I still cannot find any apps.	AppLink-enabled apps are not installed and running on your mobile device.	Ensure you have downloaded and installed the latest version of the app from your phone's app store. Ensure the app is running on your phone. Some apps require you to register or login on the app on the phone before using them with AppLink. Also, some may have a "Ford SYNC" setting, so check the app's settings menu on the phone.
My phone is connected, my app(s) are running, but I still cannot find any apps.	Sometime apps do not properly close and re-open their connection to SYNC, over ignition cycles, for example.	Closing and restarting apps may help SYNC find the application if you cannot discover it inside the vehicle. On an Android device, if apps have an "Exit" or 'Quit' option, select that then restart the app. If the app does not have that option, you can also manually "Force Close" the app by going to the phone's settings

## SYNC™ (If Equipped)

<b>AppLink issues</b>		
<b>Issue</b>	<b>Possible cause(s)</b>	<b>Possible solution(s)</b>
		<p>menu, selecting 'Apps.' then finding the particular app and choosing 'Force stop.' Don't forget to restart the app afterwards, then select "Find New Apps" on SYNC.</p> <p>On an iPhone with iOS7+, to force close an app, double tap the home button then swipe up on the app to close it. Tab the home button again, then select the app again to restart it. After a few seconds, the app should then appear in SYNC's Mobile App's Menu.</p>
<p>My Android phone is connected, my app(s) are running, I restarted them, but I still cannot find any apps.</p>	<p>There is a bluetooth bug on some older versions of the Android OS that may cause apps that were found on your previous vehicle drive to not be found again if you have not turned off bluetooth.</p>	<p>Reset the Bluetooth on your phone by turning it off and then turning Bluetooth back on. If you are in your vehicle, SYNC should be able to automatically re-connect to your phone if you press the "Phone" button.</p>

## SYNC™ (If Equipped)

<b>AppLink issues</b>		
<b>Issue</b>	<b>Possible cause(s)</b>	<b>Possible solution(s)</b>
My iPhone phone is connected, my app is running, I restarted the app but I still cannot find it on SYNC.	The USB connection to SYNC may need to be reset.	Unplug the USB cable from the phone, wait a moment, and plug the USB cable back in to the phone. After a few seconds, the app should appear in SYNC's Mobile Apps Menu. If not, "Force Close" the application and restart it.
I have an Android phone. I found and started my media app on SYNC, but there is no sound or the sound is very low.	The bluetooth volume on the phone may be low.	Try increasing the Bluetooth volume of the device by using the device's volume control buttons which are most often found on the side of the device.
I can only see some of the AppLink apps running on my phone listed in SYNC's Mobile Apps Menu.	Some Android devices have a limited number of bluetooth ports apps can use to connect. If you have more AppLink apps on your phone than the number of available Bluetooth ports, you will not see all of your apps listed in SYNC's mobile apps menu.	Force close or uninstall the apps you do not want SYNC to find. If the app has a "Ford SYNC" setting, disable that setting in the app's settings menu on the phone.

# MyFord Touch™ (If Equipped)

## GENERAL INFORMATION

### WARNING



Driving while distracted can result in loss of vehicle control, crash and injury. We strongly recommend that you use extreme caution when using any device that may take your focus off the road. Your primary responsibility is the safe operation of your vehicle. We recommend against the use of any hand-held device while driving and encourage the use of voice-operated systems when possible. Make sure you are aware of all applicable local laws that may affect the use of electronic devices while driving.

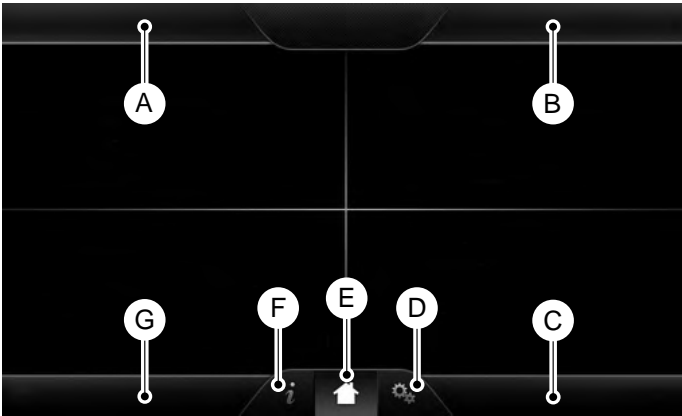

E161891

- A Phone
- B Navigation (or Information if your vehicle is not equipped with Navigation)
- C Climate (or Settings, if your vehicle is equipped with manual climate control)
- D Settings (if your vehicle is equipped with automatic climate control)
- E Home
- F Information
- G Entertainment

# MyFord Touch™ (If Equipped)

This system uses a four-corner strategy to provide quick access to several vehicle features and settings. The touchscreen provides easy interaction with your cellular phone, multimedia, climate control and navigation system. The corners display any active modes within those menus, such as phone status or the climate temperature.

**Note:** *Some features are not available while your vehicle is moving.*

**Note:** *Your system is equipped with a feature that allows you to access and control audio features for 30 minutes after you switch the ignition off (and no doors open).*

## PHONE

Press to select any of the following:

- Phone
- Quick Dial
- Phonebook
- History
- Messaging
- Settings

## NAVIGATION

Press to select any of the following:

- My Home
- Favorites
- Previous Destinations
- Point of Interest
- Emergency
- Street Address
- Intersection
- City Center
- Map
- Edit Route
- Cancel Route

## CLIMATE

Press to select any of the following:

- Driver Settings
- Recirculated Air
- Auto
- Dual
- Passenger Settings
- A/C
- Defrost



## SETTINGS

Press to select any of the following:

- Clock
- Display
- Sound
- Vehicle
- Settings
- Help



## HOME

Press to access your home screen. Depending on your vehicle's option package and software, your screens may vary in appearance from the descriptions in this section. Your features may also be limited depending on your market. Check with an authorized dealer for availability.



## INFORMATION

Press to select any of the following:

- Services
- Travel Link
- Alerts
- Calendar
- Apps

## ENTERTAINMENT

Press to select any of the following:

- AM
- FM
- SIRIUS
- CD
- USB
- BT Stereo
- SD Card
- A/V In

## Using the Touch-Sensitive Controls on Your System

To turn a feature on and off, just touch the graphic with your finger. To get the best performance from the touch-sensitive controls:

- Do not press hard on the controls. They are sensitive to light touch.
- Use your bare finger to touch the center of a touch-control graphic. Touching off-center of the graphic may affect operation of a nearby control.
- Make sure your hands are clean and dry.
- Since the touchscreen operates based on the touch of a finger, you may have trouble using it if you are wearing gloves.
- Keep metal and other conductive material away from the surface of the touchscreen as this may cause electronic interference (for example, inadvertently turning on a feature other than the one you meant to turn on).

## Cleaning the Touchscreen Display

Use a clean, soft cloth such as one used for cleaning glasses. If dirt or fingerprints are still visible, apply a small amount of alcohol to the cloth. Do not pour or spray alcohol onto the display. Do not use detergent or any type of solvent to clean the display.

## Using Your Bezel Controls

Depending on your vehicle and option package, you may also have these controls on your bezel:

- Power: Switch the media or climate features off and on.
- **VOL:** Control the volume of playing media.
- Temperature, fan and climate control buttons: Control the temperature, fan speed or settings of the climate control system.
- Seek and Tune buttons: Use as you normally would in media modes.
- Eject: Eject a CD from the entertainment system.
- **SOURCE:** Touch the word repeatedly to see all available media modes. The screen does not change, but you see the media change in the lower left status bar.
- **MEDIA:** Touch the word to access the Sound menu where you can adjust settings such as: Bass, Treble, Midrange, Balance and Fade, DSP (Digital Signal Processing), Occupancy Mode and Speed Compensated Volume. (Your vehicle may not have all of these sound options.)
- Hazard flasher: Switch the hazard flashers off and on.

## Using Your Steering Wheel Controls

Depending on your vehicle and option package, you can use your steering wheel controls to interact with the touchscreen system. See **Steering Wheel** (page 62).

## Support

The SYNC support team is available to help you with any questions you are not able to answer on your own.

# MyFord Touch™ (If Equipped)

Monday-Saturday, 8:30am-9:00pm EST.

Sunday, 10:30am-7:30pm EST.

In the United States, call: 1-800-392-3673.

In Canada, call: 1-800-565-3673.

Times are subject to change due to holidays.

## Safety Information

### WARNING



Driving while distracted can result in loss of vehicle control, crash and injury. We strongly recommend that you use extreme caution when using any device that may take your focus off the road. Your primary responsibility is the safe operation of your vehicle. We recommend against the use of any hand-held device while driving and encourage the use of voice-operated systems when possible. Make sure you are aware of all applicable local laws that may affect the use of electronic devices while driving.

- Do not attempt to service or repair the system. See an authorized dealer.
- Do not operate playing devices if the power cords or cables are broken, split or damaged. Place cords and cables out of the way, so they do not interfere with the operation of pedals, seats, compartments or safe driving abilities.

- Do not leave playing devices in your vehicle during extreme conditions as it could cause them damage. See your device's user guide for further information.
- For your safety, some SYNC functions are speed-dependent. Their use is limited to when your vehicle is traveling at speeds under 3 mph (5 km/h).

Make sure that you review your device's manual before using it with SYNC.

## Speed-restricted Features

Some features of this system may be too difficult to use while your vehicle is moving so they are restricted from use unless your vehicle is stationary.

- Screens crowded with information, such as Point of Interest reviews and ratings, SIRIUS Travel Link sports scores, movie times or ski conditions.
- Any action that requires you to use a keyboard is restricted, such as entering a navigation destination or editing information.
- All lists are limited so the user can view fewer entries (such as phone contacts or recent phone call entries).

See the following chart for more specific examples.

Restricted features	
Cellular Phone	Pairing a Bluetooth phone
	Adding phonebook contacts or uploading phonebook contacts (from a USB)
	List entries are limited for phone contacts and recent phone call entries
System Functionality	Editing the keypad code
	Enabling Valet Mode



## MyFord Touch™ (If Equipped)

<b>Restricted features</b>	
	Editing settings while the rear view camera or active park assist are active
Wi-Fi and Wireless	Editing wireless settings
	Editing the list of wireless networks
Videos, Photos and Graphics	Playing video
	Editing the screen's wallpaper or adding new wallpaper
Text Messages	Composing text messages
	Viewing received text messages
	Editing preset text messages
Navigation	Using the keyboard to enter a destination
	Demo navigation route
	Adding or editing Address Book entries or Avoid Areas

### Privacy Information

When you connect a cellular phone to SYNC, the system creates a profile within your vehicle that links to that cellular phone. This profile helps in offering you more cellular features and operating more efficiently. Among other things, this profile may contain data about your cellular phone book, text messages (read and unread), and call history, including history of calls when your cell phone was not connected to the system. In addition, if you connect a media device, the system creates and retains an index of supported media content. The system also records a short development log of approximately 10 minutes of all recent system activity. The log profile and other system data may be used to improve the system and help diagnose any problems that may occur.

The cellular profile, media device index, and development log remain in your vehicle unless you delete them and are generally accessible only in your vehicle when the cellular phone or media player is connected. If you no longer plan to use the system or your vehicle, we recommend you perform a Master Reset to erase all stored information.

System data cannot be accessed without special equipment and access to your vehicle's SYNC module. Ford Motor Company and Ford of Canada do not access the system data for any purpose other than as described absent consent, a court order, or where required by law enforcement, other government authorities, or other third parties acting with lawful authority. Other parties may seek to access the information independently of Ford Motor Company and Ford of Canada. For further privacy information, see the sections on 911 Assist, Vehicle Health Report, and Traffic, Directions and Information.

## Using Voice Recognition

This system helps you control many features using voice commands. This allows you to keep your hands on the wheel and focus on what is in front of you. The system provides feedback through audible tones, prompts, questions and spoken confirmations depending on the situation and the chosen level of interaction (voice settings).

The system also asks short questions (confirmation prompts) when it is not sure of your request or when there are multiple possible responses to your request.

When using voice commands, words and icons may appear in the lower left status bar indicating the status of the voice session (such as Listening, Success, Failed, Paused or Try Again).

## How to Use Voice Commands with Your System



Press the voice icon. After the tone, speak your command clearly.

<b>These commands can be said at any time during a voice session</b>
"Cancel"
"Exit"
"Go back"
"List of commands"
"Main menu"
"Next page"
"Previous page"
"What can I say?"
"Help"

## What Can I Say?

To access the available voice commands for the current session, do one of the following:

- During a voice session, press the Help icon (?) in the lower left status bar of the screen.
- Say, "What can I say?" for an on-screen listing of the possible voice commands associated with your current voice session.
- Press the voice icon. After the tone, say, "Help" to hear a list of possible voice commands.

## Helpful Hints

- Make sure the interior of your vehicle is as quiet as possible. Wind noise from open windows and road vibrations may prevent the system from correctly recognizing spoken commands.
- After pressing the voice icon, wait until after the tone sounds and Listening appears before saying a command. Any command spoken prior to this does not register with the system.
- Speak naturally, without long pauses between words.
- At any time, you can interrupt the system while it is speaking by pressing the voice icon.

## Accessing a List of Available Commands

- If you use the touchscreen, press the Settings icon > **Help** > **Voice Command List**.
- If you use the steering wheel control, press the voice icon. After the tone, speak your command clearly.

# MyFord Touch™ (If Equipped)

Available voice commands
"Audio list of commands"
"Bluetooth audio list of commands"
"Browse list of commands"
"CD list of commands"
"Climate control list of commands"
"List of commands"
"Navigation list of commands" *
"Phone list of commands"
"Radio list of commands"
"SD card list of commands"
"Sirius satellite list of commands" **
"Travel link list of commands" *
"USB list of commands"
"Voice instructions list of commands"
"Voice settings list of commands"
"Help"

\* This command is only available when your vehicle is equipped with the navigation system, and the navigation system SD card is in the card slot.

\*\* This command is only available when you have an active SIRIUS satellite radio subscription.

## Voice Settings

Voice settings allow you to customize the level of system interaction, help and feedback. The system defaults to standard interaction that uses candidate lists and confirmation prompts as these provide the highest level of guidance and feedback.

- **Interaction Mode:** Novice mode provides detailed interaction and guidance while the advanced mode has less audible interaction and more tone prompts.
- **Confirmation Prompts:** The system uses these short questions to confirm your voice request. If turned off, the system simply makes a best guess as to what you requested. The system may still occasionally ask you to confirm settings.
- **Phone and Media Candidate Lists:** Candidate lists are lists of possible results from your voice commands. The system creates these lists when it has the same confidence level of several options based on your voice command.

To access these settings using the touchscreen:

1. Press the Settings icon > **Settings** > **Voice Control**.
2. Select from:
  - Interaction Mode
  - Confirmation Prompts
  - Media Candidate Lists
  - Phone Candidate Lists
  - Voice Control Volume.

To access these settings using voice commands:

1. Press the voice icon. Wait for the prompt "Please say a command". Another tone sounds to let you know the system is listening.
2. Say any of the following commands:

Voice settings using voice commands
"Confirmation prompts off"
"Confirmation prompts on"
"Interaction mode advanced"

## MyFord Touch™ (If Equipped)

Voice settings using voice commands
"Interaction mode novice"
"Media candidate lists off"
"Media candidate lists on"
"Phone candidate lists off"
"Phone candidate lists on"
"Help"

### *Using Voice Commands with the Touchscreen Options*

Your voice system has a dual mode feature which allows you to switch between using voice commands and making on-screen selections. This is available only when the system displays a list of candidates generated during a voice session. For example, when entering in a street address or trying to call a contact from the phone you paired to the system.

## SETTINGS



E161968

- A Clock
- B Display
- C Sound
- D Vehicle
- E Settings
- F Help



Under this menu, you can set your clock, access and adjust the display, sound and vehicle settings as well as access settings for specific modes or the help feature.

## Clock

**Note:** You cannot manually set the date. Your vehicle's GPS does this for you.

**Note:** If the battery has been disconnected, your vehicle needs to acquire a GPS signal to update the clock. Once your vehicle acquires the signal, it may take a few minutes for the update to display the correct time.



1. Press the Settings icon > **Clock**.
2. Press **+** and **-** to adjust the time.

From this screen, you can also make other adjustments such as 12-hour or 24-hour mode, activate GPS time synchronization and have the system automatically update new time zones.

You can also turn the outside air temperature display off and on. It appears at the top center of the touchscreen, next to the time and date.

The system automatically saves any updates you make to the settings.

## Display

You can adjust the touchscreen display through the touchscreen or by pressing the voice button on your steering wheel controls and when prompted, say, "Display settings".



Press the Settings icon > **Display**, to access and make adjustments using the touchscreen.

- **Brightness** allows you to make the screen display brighter or dimmer.
- **Auto DIM**, when set to **On**, lets you use the Auto Dim Manual Offset feature. When set to **Off**, screen brightness does not change.
- **Mode** allows you to set the screen to a certain brightness or have the system automatically change based on the outside light level, or turn the display off.
  - If you select **AUTO** or **NIGHT**, you have the options of turning the display's Auto Dim feature on or off and changing the Auto Dim Manual Offset feature.
- **Auto Dim Manual Offset** allows you to adjust screen dimming as the outside lighting conditions change from day to night. This feature also allows you to adjust screen brightness using the instrument panel dimming control.
- **Edit Wallpaper**
  - You can have your touchscreen display the default photo or upload your own.

## Uploading Photos for Your Home Screen Wallpaper

**Note:** You cannot load photos directly from your camera. You must access the photos either from your USB mass storage device or from an SD card.

**Note:** Photographs with extremely large dimensions (such as 2048 x 1536) may not be compatible and appear as a blank (black) image on the display.

Your system allows you to upload and view up to 32 photos.



To access, press the Settings icon > **Display** > **Edit Wallpaper**, and then follow the system prompts to upload your photographs.

# MyFord Touch™ (If Equipped)

Only the photograph(s), which meets the following conditions, display:

- Compatible file formats are as follows: .jpg, .gif, .png, .bmp
- Each file must be 1.5 MB or less.
- Recommended dimensions: 800 x 384

## Sound



Press the Settings icon > **Sound**, then select from the following:

Sound
Bass
Midrange
Treble
Set Balance and Fade
DSP*
Occupancy Mode*
Speed Compensated Volume

\* Your vehicle may not have these sound settings.

## Vehicle



Press the Settings icon > **Vehicle**, then select from the following:

- Vehicle Health Report
- Rear View Camera
- Enable Valet Mode.

## Vehicle Health Report

Turn **Automatic Reminders** on and off and set the mileage interval at which you would like to receive the reports. Press **?** for more information on these selections.

When done making your selections, press **Run Vehicle Health Report Now** if you want your report.

You can find more information on Vehicle Health Report in this chapter. See **Information** (page 402).

## Rear View Camera

This menu allows you to access settings for your rear view camera.



Press the Settings icon > **Vehicle** > **Rear View Camera**, then select from the following settings:

- Rear Camera Delay
- Visual Park Aid Alert
- Guidelines.

You can find more information on the rear view camera in another chapter. See **Rear View Camera** (page 175).

## Enable Valet Mode

Valet mode allows you to lock the system. No information is accessible until the system is unlocked with the correct PIN. You can create your own four-digit PIN to lock and unlock the system.



1. Press the Settings icon > **Vehicle** > **Enable Valet Mode**.
2. Enter a four-digit PIN twice, as prompted.

After you press **Continue**, the system locks until you enter the PIN again.

**Note:** *If the system locks, and you need to reset the PIN, enter 3681 and the system unlocks.*

# MyFord Touch™ (If Equipped)

## Settings

Access and adjust system settings, voice features, as well as phone, navigation and wireless settings.

## System



Press the Settings icon > **Settings** > **System**, then select from the following:

System	
Language	Select to have the touchscreen display in English, Spanish or French.
Distance	Select to display units in kilometers or miles.
Temperature	Select to display units in Celsius or Fahrenheit.
System Prompt Volume	Adjust the volume of voice prompts from the system.
Touch Screen Button Beep	Select to have the system beep to confirm choices made through the touchscreen.
Touch Panel Button Beep	Select to have the system beep to confirm button choices made through the climate or audio system.
Keyboard Layout	Have the touchscreen keyboard display in QWERTY or ABC format.
Install Applications	Install any downloaded applications or view the current software licenses.
Master Reset	Select to restore factory defaults. This erases all personal settings and personal data.

## Voice Control



Press the Settings icon > **Settings** > **Voice Control**, then select from the following:

## MyFord Touch™ (If Equipped)

Voice control	
Interaction Mode	Standard interaction mode provides more detailed interaction and guidance. Advanced mode has less audible interaction and more tone prompts.
Confirmation Prompts	Have the system ask you short questions if it has not clearly heard or understood your request.*
Media Candidate Lists	Candidate lists are possible results from your voice commands. The system simply makes a best guess at your request with these turned off.
Phone Candidate Lists	Candidate lists are possible results from your voice commands. The system simply makes a best guess at your request with these turned off.
Voice Control Volume	This allows you to adjust the system's voice volume level.

\* Even with confirmation prompts turned off, the system may occasionally ask you to confirm settings

### Media Player



Press the Settings icon > **Settings** > **Media Player**, then select from the following:

Media player	
Autoplay	When this feature is on, the system automatically switches to the media source upon initial connection. This allows you to listen to music during the indexing process. When this feature is off, the system does not automatically switch to the inserted media source.
Bluetooth Devices	Select to connect, disconnect, add or delete a device. You can also set a device as your favorite so that the system automatically attempts to connect to that device at every ignition cycle.
Index Bluetooth Audio Devices	When this feature is on, the system automatically indexes media on your connected Bluetooth device.



## MyFord Touch™ (If Equipped)

Media player	
Gracenote Database Info	This allows you to view the version level of the Gracenote Database.
Gracenote Mgmt	With this feature on, the Gracenote Database supplies metadata information for your music files. This overrides information from your device. This feature defaults to off.
Cover Art Priority	With this feature on, the Gracenote Database supplied cover art for your music files. This overrides any art from your device. This feature defaults to Media Player.

### Navigation



Press the Settings icon > **Settings** > **Navigation**, then select from the following:

Navigation	
Map Preferences	Turn breadcrumbs on and off.
	Have the system display your turn list top to bottom or bottom to top.
	Turn the Parking POI notification on and off.
Route Preferences	Choose to have the system display the Shortest, Fastest or most Ecological route first. If you set <b>Always Use Preferred Route to Yes</b> , the system uses the selected route type to calculate only one route to the desired destination. <b>Always Use Preferred Route</b> bypasses route selection in destination programming. The system only calculates one route based on the preferred route setting. <b>Eco Time Penalty</b> allows you to select a low, medium or high cost for the calculated Eco Route. The higher the setting, the longer the time allotment is for the route.
	Have the system avoid freeways.
	Have the system avoid tollroads.
	Have the system avoid ferries or car trains.
	Have the system use HOV (high-occupancy vehicle) lanes.
Navigation Preferences	Have the system use guidance prompts.

## MyFord Touch™ (If Equipped)

Navigation	
	Have the system automatically fill-in State/Province information.
Traffic Preferences	Have the system display areas where roadwork occurs.
	Have the system display incident icons.
	Have the system display areas where difficult driving conditions may occur.
	Have the system display areas where snow and ice on the road may occur.
	Have the system display any smog alerts.
	Have the system display weather warnings.
	Have the system display where there may be reduced visibility.
	Have the system turn on your radio for traffic announcements.
Avoid Areas	Enter specific areas that you would like to avoid on planned navigation routes.

### Phone



Press the Settings icon > **Settings** > **Phone**, then select from the following:

Phone	
Bluetooth Devices	Connect, disconnect, add or delete a device, as well as save it as a favorite.
Bluetooth	Turn Bluetooth on and off.
Do Not Disturb	Have all calls go directly to your voice mail and not ring inside your vehicle. With this feature turned on, text message notifications are also suppressed and do not ring inside your vehicle.
911 Assist	Turn on or turn off the 911 Assist feature. See <b>Information</b> (page 402).

## MyFord Touch™ (If Equipped)

Phone	
Phone Ringer	Select the type of notification for phone calls - ring tone, beep, text to speech, or have it be silent.
Text Message Notification	Select the type of notification for text messages - alert tone, beep, text to speech, or have it be silent.
Internet Data Connection	If compatible with your phone, you can adjust your internet data connection. Select to make your connection profile with the personal area network or to turn off your connection. You can also choose to adjust your settings or have the system always connect, never connect when roaming or query on connect. Press <b>?</b> for more information.
Manage Phonebook	Access features, such as automatic phonebook download, re-download your phonebook, add contacts from your phone as well as delete or upload your phonebook.
Roaming Warning	Have the system alert you when in Roaming mode.

### Wireless & Internet

Your system has a Wi-Fi feature that creates a wireless network within your vehicle, thereby allowing other devices (such as personal computers or phones) in your vehicle to speak to each other, share files or play games. Using this Wi-Fi

feature, everyone in your vehicle can also gain access the internet if you have a USB mobile broadband connection inside your vehicle, your phone supports personal area networking and if you park outside a wireless hotspot.



Press the Settings icon > **Settings > Wireless & Internet**, then select from the following:

## MyFord Touch™ (If Equipped)

<b>Wi-fi</b>	
Wi-Fi Settings	<p><b>Wi-Fi Network (Client) Mode</b> turns the Wi-Fi feature on and off in your vehicle. Make sure you turn it on for connectivity purposes.</p> <p><b>Choose a Wireless Network</b> allows you to use a previously stored wireless network. You can categorize by alphabetical listing, priority and signal strength. You can also choose to search for a network, connect to a network, disconnect from a network, receive more information, prioritize a network or delete a network.</p> <p><b>Gateway (Access Point) Mode</b> makes SYNC an access point for a phone or a computer when turned on. This forms the local area network within your vehicle for things, such as game playing, file transfer and internet browsing. Press <b>?</b> for more information.</p> <p><b>Gateway (Access Point) Settings</b> allows you to view and change settings for using SYNC as the internet gateway.</p> <p><b>Gateway (Access Point) Device List</b> allows you to view recent connections to your Wi-Fi system.</p>
USB Mobile Broadband	<p>Instead of using Wi-Fi, your system can also use a USB mobile broadband connection to access the internet. (You must turn on your mobile broadband device on your personal computer before connecting it to the system.) This screen allows you to set up what is your typical area for your USB mobile broadband connection. (USB mobile broadband settings may not display if the device is already on.) You can select the following: Country, Carrier, Phone Number, User Name and Password.</p>
Bluetooth Settings	<p>Shows you the currently paired devices as well as giving you your typical Bluetooth options to connect, disconnect, set as favorite, delete and add device. Bluetooth is a registered trademark of the Bluetooth SIG.</p>
Prioritize Connection Methods	<p>Choose your connection methods and change them as needed. You can select to Change Order and have the system either always attempt to connect using a USB mobile broadband or using Wi-Fi.</p>

# MyFord Touch™ (If Equipped)



The Wi-Fi

CERTIFIED Logo is a certification mark of the Wi-Fi Alliance.

## Help



Press the Settings icon > **Help**, then select from the following:

E142626

<b>Help</b>	
Where Am I?	View your vehicle's current location, if your vehicle is equipped with navigation. If your vehicle is not equipped with navigation, you do not see this button.
System Information	Touchscreen system serial number
	Your vehicle identification number (VIN)
	Touchscreen system software version
	Navigation system version
	Map database version
	Sirius satellite radio ESN
Gracenote Database Information and Library version	
Software Licenses	View the licenses for any software and applications installed on your system.
Driving Restrictions	Certain features are not accessible when your vehicle is moving.
911 Assist	Turn on and turn off the 911 Assist feature. See <b>Information</b> (page 402). <b>In Case of Emergency (ICE) Quick Dial:</b> allows you to save up to two numbers as ICE contacts for quick access if there is an emergency. Select <b>Edit</b> to access your phonebook and then select the desired contacts. The numbers then appear as options on this screen for the ICE 1 and ICE 2 buttons. The ICE contacts you select appear at the end of the 911 Assist call process.
Voice Command List	View categorized lists of voice commands.

## MyFord Touch™ (If Equipped)

To access Help using the voice commands, press the voice button, then, after the tone,

say "Help". The system provides allowable voice commands for the current mode.

### ENTERTAINMENT

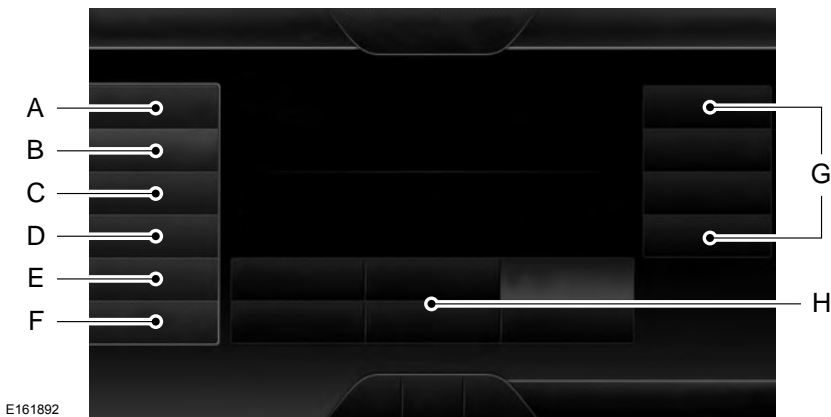

E161892

- A AM 1 and AM AST
- B FM 1, FM 2 and FM AST
- C SIRIUS
- D CD
- E USB
- F Touch this button to scroll down for more options, such as SD Card, BT Stereo and A/V In
- G These buttons change with the media mode you are in.
- H Radio memory presets and CD controls.

**Note:** Some features may not be available in your area. Contact an authorized dealer for more information.

You can access these options using the touchscreen or voice commands.

### Browsing Device Content

When listening to audio on a device, you can browse through other devices without having to change sources. For example, if you are currently listening to audio on an SD card, you can browse all the artists that are stored on your USB device.

## MyFord Touch™ (If Equipped)



Press the voice icon on the steering wheel. When prompted, you can say:

<b>"BROWSE" within devices</b>
"Browse"*
"Browse <league> games"***
"Browse <Sirius category> channels"***
"Browse SD card"
"Browse Sirius channel guide"***
"Browse USB"
"Help"

\* If you only say, "Browse", you can then say any commands in the following chart.

\*\* This command is only usable if you have an active subscription to SIRIUS satellite radio.

<b>"BROWSE"</b>
"<League> Games"*
"<Sirius category> channels"*
"SD card"***
"Sirius Channel Guide"*
"USB"***
"Help"

\* This command is only usable if you have an active subscription to SIRIUS satellite radio.

\*\* For more commands in SD card or USB mode, see the "SD Card and USB Port" section of this chapter.

Your voice system allows you to change audio sources with a simple voice command. For example, if you are listening to music on a USB device, then want to switch to a satellite radio channel, simply press the voice button on the steering wheel controls and say the name of the SIRIUS station (such as, "the Highway"). The following voice commands are available at the top level of the voice session no matter which current audio source you are listening to (such as a USB device or SIRIUS satellite radio).

**Note:** *This is only available when your MyFord Touch system language is set to North American English.*

<b>Sample commands</b>
"<87.9-107.9>"
"<530-1710>"
"<Channel name>".
"AM <530-1710>"
"FM <87.9-107.9>"
"Play [album] <name>".
"Play [artist] <name>".
"Play [genre] <name>".
"Play [playlist] <name>".
"Play [song] <name>".
"Play <name>"
"Play <name (song or album)> by <artist name>"

# MyFord Touch™ (If Equipped)

Sample commands
"Sirius <0-223>".
"Sports games".

\* This command is only usable if you have an active subscription to SIRIUS satellite radio.

\*\* The commands that have [ ] around the word means that the word is optional. For example, if you say, "Play Metallica", this is the same as the voice command, "Play [artist] <name>".

## AM/FM Radio



Touch the **AM** or **FM** tab to listen to the radio.

To change between AM and FM presets, just touch the **AM** or **FM** tab.

## Memory Presets

Save a station by pressing and holding one of the memory preset areas. There is a brief mute while the radio saves the station. Sound returns when finished.

## HD Radio

Touch this button to turn HD Radio on. The light on the button illuminates when the feature is on. HD Radio allows you to receive radio broadcasts digitally, where available, providing free, crystal-clear sound. See HD Radio information later in this chapter.

## Scan

Touch this button to go to the next strong AM or FM radio station. The light on the button illuminates when the feature is on.

## Options

### Sound Settings

Touch this button to adjust settings for:

- Bass
- Midrange
- Treble
- Balance and Fade
- DSP (Digital Signal processing)
- Occupancy Mode
- Speed Compensated Volume.

**Note:** *Your vehicle may not have all these sound settings.*

### Set PTY for Seek/Scan

This allows you to select a category of music you would like to search for. You can then choose to either seek or scan for the stations playing that category.

### RDS Text Display

This allows you to view the information broadcast by FM stations.

### AST

AST (Autostore) allows you to have the system automatically store the six strongest stations in your current location.

### TAG Button

This feature is available when HD Radio is on, and allows you to tag a song to download later. When you select On, **TAG** appears on-screen when HD Radio is active. You can touch **TAG** to save the information of the song that is playing. When you plug in your portable music player, the information transfers, if supported by your device. When you are connected to iTunes, the tags appear to remind you of the songs you would like to download. See HD Radio information later in this chapter.



## Direct Tune

Touch this button to manually enter the desired station number. Touch **Enter** when you are done.

## HD Radio™ Information (If Available)

**Note:** *HD Radio broadcasts are not available in all markets.*

HD Radio technology is the digital evolution of analog AM/FM radio. Your system has a special receiver that allows it to receive digital broadcasts (where available) in addition to the analog broadcasts, it already receives. Digital broadcasts provide a better sound quality than analog broadcasts with free, crystal-clear audio and no static or distortion. For more information, and a guide to available stations and programming, please visit [www.hdradio.com](http://www.hdradio.com).

When HD Radio is on and you tune to a station broadcasting HD Radio technology, you may notice the following indicators on your screen:



E142616

The HD Radio logo is grey when acquiring a digital station, and then changes to orange when digital audio is playing. When this logo is available, you may also see Title and Artist fields on-screen.

The multicast indicator appears in FM mode (only) if the current station is broadcasting multiple digital broadcasts. The highlighted numbers signify available digital channels where new or different content is available. HD1 signifies the main programming status and is available in analog and digital broadcasts. Other multicast stations (HD2 through HD7) are only available digitally.

**TAG** allows you to save a song to download later when you are on an acquired HD Radio station and the feature is on. To turn the feature on and use it:

1. Press **AM** or **FM** > **Options** > **TAG Button** > **On**.
2. When you hear a song you like, touch **TAG**.
3. The system automatically saves the song's information and transfers it to your portable music player (if supported) when you connect it to the system. The system automatically transfers the tag to your player (if already connected) and a pop-up confirms the transfer.
4. When you access iTunes with your portable music player, the tags appear to you as a reminder. The system allows you to tag up to approximately 100 songs. For a list of devices that support tagging, see [www.SYNCMYride.com](http://www.SYNCMYride.com), [www.SYNCMYride.ca](http://www.SYNCMYride.ca) or [www.syncmaroute.ca](http://www.syncmaroute.ca).

## MyFord Touch™ (If Equipped)

When HD Radio broadcasts are active, you can access the following functions:

- **Scan** allows you to hear a brief sampling of all available stations. This feature still works when HD Radio reception is on, although it does not scan for HD2-HD7 channels. You may see the HD logo appear if the station has a digital broadcast.

- **Memory presets** allow you to save an active channel as a memory preset. Touch and hold a memory preset slot until the sound returns. There is a brief mute while the radio saves the station. Sound returns when finished. When switching to an HD2 or HD3 memory preset, the sound mutes before the digital audio plays, because the system has to reacquire the digital signal.

**Note:** *As with any saved radio station, you cannot access the saved station if your vehicle is outside the station's reception area.*

### HD Radio Reception and Station Troubleshooting

Potential reception issues	
Reception area	If you are listening to a multicast station and you are on the fringe of the reception area, the station may mute due to weak signal strength.
	If you are listening to HD1, the system switches back to the analog broadcast until the digital broadcast is available again. However, if you are listening to any of the possible HD2-HD7 multicast channels, the station mutes and stays muted unless it is able to connect to the digital signal again.
Station blending	When the system first receives a station (aside from HD2-HD7 multicast stations), it first plays the station in the analog version. Once the receiver verifies the station is an HD Radio station, it shifts to the digital version. Depending on the station quality, you may hear a slight sound change when the station changes from analog to digital. Blending is the shift from analog to digital sound or digital back to analog sound.

In order to provide the best possible experience, use the contact form to report any station issues found while listening to a station broadcasting with HD Radio technology. Independent entities own and operate each station. These stations are responsible for ensuring all audio streams and data fields are accurate.

# MyFord Touch™ (If Equipped)

Potential station issues		
Issues	Cause	Action
Echo, stutter, skip or repeat in audio. Increase or decrease in audio volume.	This is poor time alignment by the radio broadcaster.	No action required. This is a broadcast issue.
Sound fading or blending in and out.	The radio is shifting between analog and digital audio.	No action required. The reception issue may clear up as you continue to drive.
There is an audio mute delay when selecting HD2 or HD3, multicast preset or <b>Direct Tune</b> .	The digital multicast is not available until the HD Radio broadcast is decoded. Once decoded, the audio is available.	No action required. This is normal behavior. Wait until the audio is available.
Cannot access HD2 or HD3 multicast channel when recalling a preset or from a direct tune.	The previously stored multicast preset or direct tune is not available in your current reception area.	No action required. The station is not available in your current location.
Text information does not match currently playing audio.	Data service issue by the radio broadcaster.	Fill out the station issue form at website listed below.*
There is no text information shown for currently selected frequency.	Data service issue by the radio broadcaster.	Fill out the station issue form at website listed below.*
HD2-HD7 stations not found when <b>Scan</b> is pressed.	Pressing <b>Scan</b> disables HD2-HD7 channel search.	No action required. This is normal behavior.

\* [http://www.ibiquity.com/automotive/report\\_radio\\_station\\_experiences](http://www.ibiquity.com/automotive/report_radio_station_experiences)

HD Radio Technology manufactured under license from iBiquity Digital Corp. U.S. and foreign patents. HD Radio and the HD and HD Radio logos are proprietary trademarks of iBiquity Digital Corp. Ford Motor Company and iBiquity Digital Corp. are not responsible for the content sent using HD Radio technology. Content may be changed, added or deleted at any time at the station owner's discretion.

## Radio Voice Commands



If you are listening to the radio, press the voice button on the steering wheel controls. When prompted, say any of the following commands.

If you are not listening to the radio, press the voice button and, after the tone, say "Radio", then any of the following commands.

## MyFord Touch™ (If Equipped)

<b>"RADIO"</b>
"<87.9-107.9>"
"<87.9-107.9> HD" <sup>1</sup>
"<530-1710>"
"AM"
"AM <530-1710>"
"AM autosest"
"AM autosest preset <#>"
"AM preset <#>"
"Browse" <sup>2</sup>
"FM"
"FM <87.9-107.9>"
"FM <87.9-107.9> HD <#>" <sup>1</sup>
"FM autosest"
"FM autosest preset <#>"
"FM preset <#>"
"FM 1"
"FM 1 preset <#>"
"FM 2"
"FM 2 preset <#>"
"HD <#>" <sup>1</sup>
"Preset <#>"
"Radio off"
"Radio on"
"Set PTY"

<b>"RADIO"</b>
"Tune" <sup>3</sup>
"Help"

<sup>1</sup> If available.

<sup>2</sup> If you have said "Browse", see the "Browse" chart later in this section.

<sup>3</sup> If you have said "Tune", see the following "Tune" chart.

<b>"TUNE"</b>
"<530-1710>"
"<87.9-107.9>"
"<87.9-107.9> HD <#>" <sup>*</sup>
"AM"
"AM <530-1710>"
"AM autosest"
"AM autosest preset <#>"
"AM preset <#>"
"FM"
"FM <87.9-107.9>"
"FM <87.9-107.9> HD <#>" <sup>*</sup>
"FM autosest"
"FM autosest preset <#>"
"FM preset <#>"
"FM 1"
"FM 1 preset <#>"
"FM 2"
"FM 2 preset <#>"

# MyFord Touch™ (If Equipped)

"TUNE"
"HD <#>"*
"Preset <#>"
"Help"

\* If available.

## SIRIUS® Satellite Radio (If Activated)



Press the lower left corner of the touchscreen, and then select the **SIRIUS** tab.

### Memory Presets

Save a channel by pressing and holding one of the memory preset areas. There is a brief mute while the radio saves the channel. Sound returns when finished.

### ALERT

Save the current song, artist, or team as a favorite. The system alerts you when it plays again on any channel.

### Replay

Replay audio on the current channel. You can replay approximately 45 minutes of audio as long as you have remained tuned to the current station. Changing stations erases the previous audio.

While in replay mode:

- Press and release the seek buttons to hear the previous or next song.
- Press and hold the seek buttons to reverse or fast forward in the current track.
- Press play or pause to play or pause the audio.
- Press **Replay** to return to live audio if you have been using the feature to replay audio.

### Scan

Touch this button to hear a brief sampling of channels.

### Options

Touch this button to view and adjust various media settings.

### Sound Settings

Touch this button to adjust settings for:

- Bass
- Midrange
- Treble
- Balance and Fade
- DSP (Digital Signal processing)
- Occupancy Mode
- Speed Compensated Volume.

**Note:** *Your vehicle may not have all these sound settings.*

### Set Category for Seek/Scan

This allows you to select a category of music you would like to search for. You can then choose to either seek or scan for the stations playing that category.

### Parental Lockout

This allows you to lock and unlock channels, change or reset your PIN or unlock all channels. To use this feature, you need your initial PIN, which is 1234.

### Artist/Title/Team Alerts

This feature allows you to select Artists, Titles and Teams that you would like the system to alert you to when they are playing on other channels. Press Edit Alerts to delete or turn off alerts. You can also set all alerts to on or off. When an alert appears on the screen, you can choose to

## MyFord Touch™ (If Equipped)

Tune to the channel, to Cancel the alert or to Disable Alerts. If you are listening to a sporting event, you can save your favorite teams so that the system can alert you when they are playing on a satellite radio channel.

**Note:** SIRIUS does not support the Alert feature on all channels. Ford Motor Company shall not be responsible for Alert feature variation.

### Electronic Serial Number (ESN)

SIRIUS requires this number when communicating with you about your account.

### Direct Tune

Touch this button to manually enter the desired satellite channel number. Touch **Enter** when you are done.

### Browse

Touch this button to view a list of all available stations. Scroll to see more categories. Touch the station you want to listen to.

Touch **Skip** if you want to skip this channel.

Touch **Lock** if you do not want anyone to listen to this channel.

Touch **Title** or **Artist** to see song and artists on other stations.

### SIRIUS Satellite Radio Information

**Note:** SIRIUS reserves the unrestricted right to change, rearrange, add or delete programming including canceling, moving or adding particular channels, and its prices, at any time, with or without notice to you. Ford Motor Company shall not be responsible for any such programming changes.



E142593

SIRIUS satellite radio is a subscription-based satellite radio service that broadcasts a variety of music, sports, news, weather, traffic and entertainment programming. Your factory-installed SIRIUS satellite radio system includes hardware and a limited subscription term that begins on the date of sale or lease of your vehicle. See an authorized dealer for availability.

For more information on extended subscription terms (a service fee is required), the online media player and a list of SIRIUS satellite radio channels, and other features, please visit [www.siriusxm.com](http://www.siriusxm.com) in the United States, [www.sirius.ca](http://www.sirius.ca) in Canada, or call SIRIUS at 1-888-539-7474.

**Note:** This receiver includes the eCos real-time operating system. eCos is published under the eCos License.

### Satellite Radio Electronic Serial Number (ESN)

You need your ESN to activate, modify or track your satellite radio account. The ESN is on the System Information Screen (SR ESN:XXXXXXXXXXXX). To access your ESN, touch the bottom left corner of the touchscreen. Touch **SIRIUS > Options**.

## MyFord Touch™ (If Equipped)

### **SIRIUS Satellite Radio Reception Factors and Troubleshooting**

<b>Potential reception issues</b>	
Antenna obstructions	For optimal reception performance, keep the antenna clear of snow and ice build-up and keep luggage and other materials as far away from the antenna as possible.
Terrain	Hills, mountains, tall buildings, bridges, tunnels, freeway overpasses, parking garages, dense tree foliage and thunderstorms can interfere with your reception.
Station overload	When you pass a ground-based broadcast-repeating tower, a stronger signal may overtake a weaker one and the audio system may mute.
Satellite radio signal interference	Your display may show ACQUIRING... to indicate the interference and the audio system may mute.

<b>Troubleshooting tips</b>		
<b>Radio display</b>	<b>Cause</b>	<b>Action</b>
Acquiring...	Radio requires more than two seconds to produce audio for the selected channel.	No action required. This message should disappear shortly.
Sat Fault/SIRIUS System Failure.	There is an internal module or system failure present.	If this message does not clear shortly, or with an ignition key cycle, your receiver may have a fault. See an authorized dealer for service.
Invalid Channel.	The channel is no longer available.	Tune to another channel or choose another preset.
Unsubscribed Channel.	Your subscription does not include this channel.	Contact SIRIUS at 1-888-539-7474 to subscribe to the channel, or tune to another channel.
No Signal.	The signal is lost from the SIRIUS satellite or SIRIUS tower to your vehicle antenna.	The signal is blocked. When you move into an open area, the signal should return.

## MyFord Touch™ (If Equipped)

<b>Troubleshooting tips</b>		
<b>Radio display</b>	<b>Cause</b>	<b>Action</b>
Updating.	Update of channel programming in progress.	No action required. The process may take up to three minutes.
Call SIRIUS 1-888-539-7474.	Your satellite service is no longer available.	Contact SIRIUS at 1-888-539-7474 to resolve subscription issues.
None found. Check Channel Guide.	All the channels in the selected category are either skipped or locked.	Use the channel guide to turn off the Lock or Skip function on that station.
Subscription Updated.	SIRIUS has updated the channels available for your vehicle.	No action required.

### **SIRIUS Satellite Radio Voice Commands**



If you are listening to SIRIUS satellite radio, press the voice button on the steering wheel controls. When prompted, say any of the following commands.

If you are not listening to SIRIUS satellite radio, press the voice button and, after the tone, say "SIRIUS", then any of the following commands.

<b>"SIRIUS"</b>
"<Channel name>"
"Preset <#>"
"SAT"
"SAT preset <#>"
"SAT 1"
"SAT 1 Preset <#>"
"SAT 2"

<b>"SIRIUS"</b>
"SAT 2 preset <#>"
"SAT 3"
"SAT 3 preset <#>"
"Sirius <0-223>"
"Sirius off"
"Sirius on"
"Sports game" <sup>*</sup>
"Tune" <sup>**</sup>
"Help"

<sup>\*</sup> If you have said "Sports game", see the following "Sports game" chart.

<sup>\*\*</sup> If you have said "Tune", see the following "Tune" chart.



# MyFord Touch™ (If Equipped)

"SPORTS GAME"
"Tune to the <college name> game"
"Tune to the <team city> game"
"Tune to the <team city> <team name> game"
"Tune to the <team name> game"
"Help"

"TUNE"
"<Channel Name>"
"Preset <#>"
"SAT"
"SAT 1"
"SAT 1 preset <#>"
"SAT 2"
"SAT 2 preset <#>"
"SAT 3"
"SAT 3 preset <#>"
"Sirius <0-223>"
"Help"

## CD



Press the lower left corner of the touchscreen, and then select the **CD** tab.

You can also advance and reverse the current track or current folder, if applicable.

### Repeat

Touch this button to repeat the currently playing track, all tracks on the disc or turn the feature off if already on.

## Shuffle

Touch this button to play the tracks or entire albums in random order, or turn the feature off if already on.

## Scan

Touch this button to hear a brief sampling of all available tracks.

## More Info

Touch this button to see disc information.

## Options

### Sound Settings

Touch this button to adjust settings for:

- Bass
- Midrange
- Treble
- Balance and Fade
- DSP (Digital Signal processing)
- Occupancy Mode
- Speed Compensated Volume.

**Note:** *Your vehicle may not have all these sound settings.*

### Compression

Touch this button to turn the compression feature on and off.

## Browse

Touch this button to look through all available CD tracks.

### CD Voice Commands



If you are listening to a CD, press the voice button on the steering wheel controls. When prompted, say any of the following commands.

If you are not listening to a CD, press the voice button and, after the tone, say "CD", then any of the following commands.

# MyFord Touch™ (If Equipped)

<b>"CD"</b>
"Pause"
"Play"
"Play next track"
"Play previous track"
"Play track <1-512>"
"Repeat"
"Repeat folder"*
"Repeat off"
"Repeat track"
"Shuffle"
"Shuffle CD"*
"Shuffle folder"*
"Shuffle off"
"Help"

\*This applies to WMA or MP3 files only.

## SD Card Slot and USB Port

### SD Card

**Note:** Your SD card slot is spring-loaded. To remove the SD card, press the card in and the system ejects it. Do not attempt to pull the card to remove it as this could cause damage.

**Note:** The navigation system also uses this card slot. See **Navigation** (page 414).

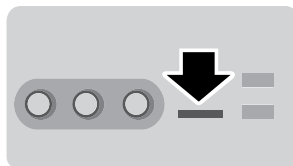

E142619

The SD card slot is located either in the center console or behind a small access door in the instrument panel. To access and play music from your device, press the lower left corner of the touchscreen.



E142620

SD logo is a trademark of SD-3C, LLC.

### USB Port

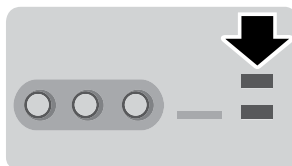

E142621

The USB ports are located either in the center console or behind a small access door in the instrument panel. To access and play music from your device, press the lower left corner of the touchscreen.

## MyFord Touch™ (If Equipped)

This feature allows you to plug in media playing devices, memory sticks, flash drives or thumb drives, and charge devices if they support this feature.

In order to playback video from your iPod or iPhone, you must have a special combination USB/RCA composite video cable (which you can buy from Apple). When you connect the cable to your iPod or iPhone, plug the other end into both the RCA jacks and the USB port.

### Playing Music from Your Device

**Note:** The system is capable of indexing up to 30,000 songs.



Insert your device and select the **SD Card** or **USB** tab once the system recognizes it. You can then select from the following options:

#### Repeat

This feature replays the currently playing song or album.

#### Shuffle

Touch this button to play music on the selected album or folder in random order.

#### Similar Music

This feature allows you to choose music similar to what is currently playing.

#### More Info

Touch this button to see disc information such as current track, artist name, album and genre.

#### Options

Touch this button to view and adjust various media settings.

**Sound Settings** allows you to adjust settings for:

- Bass
- Midrange
- Treble
- Balance and Fade
- DSP (Digital Signal processing)
- Occupancy Mode
- Speed Compensated Volume.

**Note:** Your vehicle may not have all these sound settings.

**Media Player Settings** allows you to select more settings, which is under Media Player. See **Settings** (page 369).

**Device Information** displays software and firmware information about the currently connected media device.

**Update Media Index** indexes your device when you connect it for the first time and each time the content changes (such as adding or removing tracks) to make sure you have the latest voice commands available for all media on the device.

#### Browse

This feature allows you to view the contents of the device. It also allows you to search by categories, such as genre, artist or album.

If you want to view song information such as Title, Artist, File, Folder, Album, and Genre, touch the on-screen album art.

You can also touch **What's Playing** to hear how the system pronounces the current band and song. This can be helpful when using voice commands to make sure the system correctly plays your request.

# MyFord Touch™ (If Equipped)

## Playing Video from Your Device

To access and play video from your device, your vehicle's transmission must be in position **P** with the ignition in accessory mode. See **Starting and Stopping the Engine** (page 135).

## SD Card and USB Voice Commands



If you are listening to a USB device or an SD card, press the voice button on the steering wheel controls. When prompted, say any of the following commands.

If you are not listening to a USB device or an SD card, press the voice button and, after the tone, say "USB" or "SD card", then any of the following commands.

"USB" or "SD CARD"
"Browse"
"Next"
"Pause"
"Play"
"Play album <name>"
"Play all"
"Play artist <name>"
"Play audiobook <name>"
"Play author <name>"
"Play composer <name>"
"Play folder <name>"
"Play genre <name>"
"Play movie <name>"**
"Play music video <name>"**
"Play playlist <name>"

"USB" or "SD CARD"
"Play podcast <name>"
"Play podcast episode <name>"
"Play similar music"
"Play song <name>"
"Play TV show <name>"**
"Play TV show episode <name>"**
"Play video <name>"**
"Play video podcast <name>"**
"Play video podcast episode <name>"**
"Play video playlist <name>"**
"Previous"
"Repeat all"
"Repeat off"
"Repeat one"
"Shuffle"
"Shuffle album"
"Shuffle off"
"What's this?"
"Help"

\* If you have said you would like to browse your USB or SD card, the system prompts you to specify what you would like to browse. When prompted, see the following "Browse" chart.

\*\* These commands are only available in USB mode and are device-dependent.

# MyFord Touch™ (If Equipped)

<b>"BROWSE"</b>
"Album <name>"
"All albums"
"All artists"
"All audiobooks"
"All authors"
"All composers"
"All folders"
"All genres"
"All movies"*
"All music videos"*
"All playlists"
"All podcasts"
"All songs"
"All TV shows"
"All video playlists"*
"All video podcasts"*
"All videos"
"Artist <name>"
"Audiobook <name>"
"Author <name>"
"Composer <name>"
"Folder <name>"
"Genre <name>"
"Playlist <name>"
"Podcast <name>"

<b>"BROWSE"</b>
"TV show <name>"*
"Video <name>"*
"Video playlist <name>"*
"Video podcast <name>"*
"Help"

\* This command is only available in USB mode and is device-dependent.

## Supported Media Players, Formats and Metadata Information

SYNC is capable of hosting nearly any digital media player, including iPod, Zune™, plays from device players, and most USB drives. Supported audio formats include MP3, WMA, WAV and AAC.

It is also able to organize your indexed media from your playing device by metadata tags. Metadata tags, which are descriptive software identifiers embedded in the media files, provide information about the file.

If your indexed media files contain no information embedded in these metadata tags, SYNC may classify the empty metadata tags as **Unknown**.

In order to playback video from your iPod or iPhone, you must have a special combination USB/RCA composite video cable (which you can buy from Apple). When you connect the cable to your iPod or iPhone, plug the other end into both the RCA jacks and the USB port.

## Bluetooth Audio

Your system allows you to stream audio over your vehicle's speakers from your connected, Bluetooth-enabled cellular phone.



To access, press the lower left corner on the touchscreen, then select the **BT Stereo** tab.

## Bluetooth Audio Voice Commands



If you are listening to a Bluetooth audio device, press the voice button on the steering wheel control. When prompted, say "Next song", "Pause", "Play" or "Previous song".

If you are not listening to a Bluetooth audio device, press the voice button and, after the tone, say "Next song", "Pause", "Play" or "Previous song".

## A/V Inputs

### WARNINGS



Driving while distracted can result in loss of vehicle control, crash and injury. We strongly recommend that you use extreme caution when using any device that may take your focus off the road. Your primary responsibility is the safe operation of your vehicle. We recommend against the use of any handheld device while driving and encourage the use of voice-operated systems when possible. Make sure you are aware of all applicable local laws that may affect the use of electronic devices while driving.



For safety reasons, do not connect or adjust the settings on your portable music player while your vehicle is moving.



Store the portable music player in a secure location, such as the center console or the glove box, when your vehicle is moving. Hard objects may become projectiles in a crash or sudden stop, which may increase the risk of serious injury. The audio extension cable must be long enough to allow the portable music player to be safely stored while your vehicle is moving.

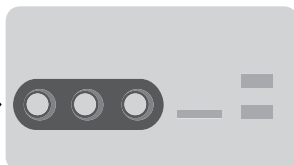

E142622

Your A/V inputs allow you to connect an auxiliary audio/video source (such as a gaming system or a personal camcorder) by connecting RCA cords (not included) to these input jacks. The jacks are yellow, red and white and are located either behind a small access door on the instrument panel or in your center console.

You can also use the A/V inputs as an auxiliary input jack to play music from your portable music player over your vehicle's speakers. Plug in your 1/8 inch (3.5 millimeter) RCA adapter into the two left A/V input jacks (red and white).

Press the lower left corner of the touchscreen, and then select **A/V In**.

To use the auxiliary input jack feature, make sure that your portable music player is designed for use with headphones and that it is fully charged. You also need an audio extension cable with stereo male 1/8-inch (3.5 millimeter) connectors at one end and a RCA jack at the other.

1. Switch off the engine, radio and portable music player. Set the parking brake and put the transmission in position **P**.
2. Attach one end of the audio extension cable to the headphone output of your player and the other end into the adapter in one of the two left A/V input jacks (white or red) inside the center console.

## MyFord Touch™ (If Equipped)

3. Press the lower left corner on the touchscreen. Select either a tuned FM station or a CD (if there is a CD already loaded into the system).
4. Adjust the volume as desired.
5. Turn the portable music player on and adjust the volume to  $\frac{1}{2}$  the maximum.
6. Press the lower left corner on the touchscreen. Select the **A/V In** tab. (You should hear audio from your portable music player although it may be low.)
7. Adjust the sound on your portable music player until it reaches the level of the FM station or CD by switching back and forth between the controls.

In order to playback video from your iPod or iPhone, you must have a special combination USB/RCA composite video cable (which you can buy from Apple). When you connect the cable to your iPod or iPhone, plug the other end into both the RCA jacks and the USB port.

### Troubleshooting

- Do not connect the audio input jack to a line level output. The jack only works correctly with devices that have a headphone output with a volume control.
- Do not set the portable music player's volume level higher than is necessary to match the volume of the CD or FM radio as this causes distortion and reduces sound quality.
- If the music sounds distorted at lower listening levels, turn the portable music player volume down. If the problem persists, replace or recharge the batteries in the portable media player.
- Control the portable media player in the same manner when used with headphones, as the auxiliary input jack does not provide control (such as Play or Pause) over the attached portable media player.

## PHONE

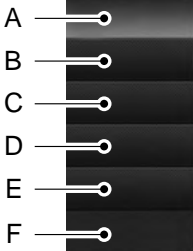

E161968

- A Phone
- B Quick Dial
- C Phonebook
- D History
- E Messaging
- F Settings

Hands-free calling is one of the main features of SYNC. Once you pair your phone, you can access many options using the touchscreen or voice commands. While the system supports a variety of features, many are dependent on your cellular phone's functionality.

At a minimum, most cellular phones with Bluetooth wireless technology support the following functions:

- Answering an incoming call.
- Ending a call.
- Using privacy mode.
- Dialing a number.
- Redialing.
- Call waiting notification.
- Caller ID.

Other features, such as text messaging using Bluetooth and automatic phonebook download, are phone-dependent features. To check your phone's compatibility, see your phone's user manual and visit [www.SYNCMyRide.com](http://www.SYNCMyRide.com), [www.SYNCMyRide.ca](http://www.SYNCMyRide.ca) or [www.syncmaroute.ca](http://www.syncmaroute.ca).

## Pairing Your Phone for the First Time

### WARNING



Driving while distracted can result in loss of vehicle control, crash and injury. We strongly recommend that you use extreme caution when using any device that may take your focus off the road. Your primary responsibility is the safe operation of your vehicle. We recommend against the use of any handheld device while driving and encourage the use of voice-operated systems when possible. Make sure you are aware of all applicable local laws that may affect the use of electronic devices while driving.

The first thing you must do to use the phone features of SYNC is to pair your Bluetooth-enabled cellular phone with SYNC. This allows you to use your phone in a hands-free manner.

**Note:** *Put the transmission in park (P). Switch on your vehicle ignition and the radio.*

1. Touch **Add Phone** in the upper left corner of the touchscreen. **Find SYNC** appears on the screen, and instructs you to begin the pairing process from your device.
2. Make sure that Bluetooth is set to **On** and that your cellular phone is in the proper mode. See your phone's manual if necessary.



# MyFord Touch™ (If Equipped)

**Note:** Select **SYNC**, and a six-digit PIN appears on your device.

3. If prompted to enter a PIN on your device, it does not support Secure Simple Pairing. To pair, enter the PIN displayed on the touchscreen. Skip the next step.
4. When prompted on your phone's display, confirm that the PIN provided by SYNC matches the PIN displayed on your cellular phone.
5. The display indicates when the pairing is successful.

SYNC may prompt you with more phone options. For more information on your phone's capability, see your phone's manual and visit the website.

## Pairing Subsequent Phones

**Note:** Put the transmission in park (P). Switch on your vehicle ignition and the radio.

1. Press the **Phone** corner of the touchscreen > **Settings** > **BT Devices** > **Add Device**.
2. Make sure that Bluetooth is set to **On** and that your cellular phone is in the proper mode. See your phone's manual if necessary.

**Note:** Select **SYNC**, and a six-digit PIN appears on your device.

3. If prompted to enter a PIN on your device, it does not support Secure Simple Pairing. To pair, enter the PIN displayed on the touchscreen. Skip the next step.
4. When prompted on your phone's display, confirm that the PIN provided by SYNC matches the PIN displayed on your cellular phone.
5. The display indicates when the pairing is successful.

SYNC may prompt you with more phone options. For more information on your phone's capability, see your phone's manual and visit the website.

## Making Calls



Press the voice button on your steering wheel controls. When prompted, say, "Call <name>" or say "Dial", then the desired number.



To end the call or exit phone mode, press and hold the phone button.

## Receiving Calls

During an incoming call, an audible tone sounds. Call information appears in the display if it is available.



Accept the call by pressing **Accept** on the touchscreen or by pressing the phone button on your steering wheel controls.

Reject the call by pressing **Reject** on the touchscreen or by pressing and holding the phone button on your steering wheel controls.

Ignore the call by doing nothing. SYNC logs it as a missed call.

## Phone Menu Options

Press the top left corner on your touchscreen to select from the following options:

### Phone

Touch this button to access the on-screen numerical pad to enter a number and place a call. During an active call, you can also choose to:

- Mute the call.
- Put the call on hold.
- Turn on the privacy feature.

- Join two calls.
- End the call.

## Quick Dial

Set up favorite contacts from your phonebook or history folder.

## Phonebook

Touch this button to access and call any contacts in your previously downloaded phone book. The system places the entries in alphabetical categories summarized at the top of the screen.

To switch on contact picture settings, if your device supports this feature, press **Phone > Settings > Manage Phonebook > Download photos from Phonebook > On**.

## History

After you connect your Bluetooth-enabled phone to SYNC, you can access any previously dialed, received or missed calls. You can also choose to save these to your Favorites or to Quick Dial.

**Note:** *This is a phone-dependent feature. If your phone does not support downloading call history using Bluetooth, SYNC keeps track of calls made with the SYNC system.*

## Messaging

Send text messages using your touchscreen. See **Text messaging** later in this section.

## Settings

Touch this button to access various phone settings, such as turning Bluetooth on and off, managing your phonebook and more. See **Phone settings** later in this section.

## Text Messaging

**Note:** *Downloading and sending text messages using Bluetooth are phone-dependent features.*

**Note:** *Certain features in text messaging are speed-dependent and not available when your vehicle is traveling at speeds over 3 mph (5 km/h).*

**Note:** *SYNC does not download read text messages from your phone.*

You can send and receive text messages using Bluetooth, read them aloud and translate text messaging acronyms, such as LOL.

1. Touch the top left corner of the display to access the **Phone** menu.
2. Select **Messaging**.
3. Choose from the following:
  - Listen (speaker icon).
  - Dial.
  - Send Text.
  - View.
  - Delete.

## Composing a Text Message

**Note:** *This is a speed-dependent feature. It is unavailable when your vehicle is traveling at speeds over 3 mph (5 km/h).*

**Note:** *Downloading and sending text messages using Bluetooth are phone-dependent features.*

1. Touch the top left corner of the display to access the **Phone** menu.
2. Touch **Messaging > Send Text**.
3. Enter a phone number or choose from your phonebook.
4. You can select from the following options:

# MyFord Touch™ (If Equipped)

- **Send**, which sends the message as it is.
- **Edit Text**, which allows you to customize the pre-defined message or create a message on your own.

You can then preview the message, verify the recipient as well as update the message list.

Text message options
I'll call you back in a few minutes.
I just left, I'll be there soon.
Can you give me a call?
I'm on my way.
I'm running a few minutes late.
I'm ahead of schedule, so I'll be there early.
I'm outside.
I'll call you when I get there.
OK
Yes
No
Thanks
Stuck in traffic.
Call me later.
LOL

## Receiving a Text Message

**Note:** If you select **View** and your vehicle is traveling over 3 mph (5 km/h), the system offers to read the message to you instead of allowing you to view it while driving.

When a new message arrives, an audible tone sounds and the screen displays a pop-up with the caller name and ID, if supported by your phone. You can press:

- **View** to view the text message.
- **Listen** for SYNC to read the message to you.
- **Dial** to call the contact.
- **Ignore** to exit the screen.

## Phone Settings

Press **Phone > Settings**.

## Bluetooth Devices

Touch this tab to connect, disconnect, add or delete a device, as well as save it as a favorite.

## Bluetooth

Touch this tab to turn Bluetooth off or on.

## Do Not Disturb

Touch this tab if you want all calls to go directly to your voice mail and not ring in the vehicle. When this feature is on, text message notifications do not ring inside the cabin either.

## 911 Assist

Turn on or turn off the 911 Assist feature. See **Information** (page 402).

## Phone Ringer

Select the ring tone you want to hear when you receive a call. Choose from possible system ring tones, your currently paired phone's ring tone, a beep, text-to-speech or a silent notification.

# MyFord Touch™ (If Equipped)

## Text Message Notification

Select a text message notification, if supported by your phone. Choose from possible system alert tones, text-to-speech or silent.

## Internet Data Connection

If your phone is compatible, use this screen to adjust your internet data connection. Select to make your connection profile with the personal area network or to switch off your connection. You can also choose to adjust your settings or have the system always connect, never connect when roaming or query on connect. Press ? for more information.

## Manage Phonebook

Touch this button to access features such as automatic phonebook download, re-download your phonebook, add contacts from your phone as well as delete or upload your phonebook.

## Roaming Warning

Touch this button to have the system alert you when your phone is in roaming mode.

## Phone Voice Commands



Press the voice button on the steering wheel controls. When prompted, say any of the following commands:

"PHONE"
"Call"
"Call <name>"
"Call <name> at home"
"Call <name> at work"
"Call <name> on cell"

"PHONE"
"Call <name> on other"
"Call voicemail"
"Dial"
"Do not disturb off"
"Do not disturb on"
"Forward text messages"
"Go to hands free"*
"Hold call off"*
"Hold on"
"Join calls"*
"Listen to text message <#>"
"Listen to text messages"
"Messages"***
"Mute call"*
"Pair phone"
"Privacy on"*
"Read text message"
"Reply to text messages"
"Turn ringer off"
"Turn ringer on"

# MyFord Touch™ (If Equipped)

"PHONE"
"Unmute call"*
"Help"

\* This command is only available during an active call.

\*\* If you say "Messages", see the following "Messages" chart for additional commands.

"MESSAGES"
"Call"
"Forward text messages"
"Listen to text message <#>"
"Listen to text messages"
"Reply to text messages"
"Help"

## INFORMATION



E161889

- A SYNC Services
- B Sirius Travel Link
- C Alerts
- D Calendar
- E SYNC Applications

Under the Information menu, you can access features such as:

- SYNC Services
- Sirius Travel Link
- Alerts
- Calendar
- SYNC Applications



If your vehicle is equipped with Navigation, press the **Information** button to access these features. If your vehicle is not equipped with Navigation, press the corner of the touchscreen with the gear tab.

## SYNC Services (If Equipped, United States Only)

**Note:** SYNC Services varies by trim level and model year and may require a subscription. Traffic alerts and turn-by-turn directions available in select markets. Message and data rates may apply. Ford Motor Company reserves the right to change or discontinue this product service at any time without prior notification or incurring any future obligation.

**Note:** SYNC Services requires activation before use. Visit [www.SYNCMyRide.com](http://www.SYNCMyRide.com) to register and check your eligibility for complimentary services. Standard phone and message rates may apply. Subscription may be required. You must also have the active SYNC Services Bluetooth-enabled cellular phone paired and connected to the system in order to connect to, and use, SYNC Services. See **Phone** (page 396).

**Note:** This feature does not function properly if you have enabled caller ID blocking on your cellular phone. Make sure your cellular phone is not blocking caller ID before using SYNC Services.

**Note:** The driver is ultimately responsible for the safe operation of the vehicle, and therefore, must evaluate whether it is safe to follow the suggested directions. Any navigation features provided are only an aid. Make your driving decisions based on your observations of local conditions and existing traffic regulations. Do not follow the route suggestions if doing so would result in an unsafe or illegal maneuver, if you would be placed in an unsafe situation, or if you would be directed into an area that you consider unsafe. Maps used by this system may be inaccurate because of errors, changes in roads, traffic conditions or driving conditions.

**Note:** When you connect, the service uses GPS technology and advanced vehicle sensors to collect your vehicle's current location, travel direction and speed to help provide you with the directions, traffic reports, or business searches you request. Further, to provide the services you request, for continuous improvement, the service may collect and record call details and voice communications. For more information, see SYNC Services Terms and Conditions at [www.SYNCMyRide.com](http://www.SYNCMyRide.com). If you do not want Ford or its service providers to collect your vehicle travel information or other information identified in the Terms and Conditions, do not subscribe or use the service.

SYNC Services uses advanced vehicle sensors, integrated GPS technology and comprehensive map and traffic data, to give you personalized traffic reports, precise turn-by-turn directions, business search, news, sports, weather and more. For a complete list of services, or to learn more, please visit [www.SYNCMyRide.com](http://www.SYNCMyRide.com).

## Connecting to SYNC Services Using Voice Commands



# MyFord Touch™ (If Equipped)

1. Press the voice button.
2. When prompted, say "Services". This initiates an outgoing call to SYNC Services using your paired and connected Bluetooth-enabled cellular phone.
3. Once you connect to the service, follow the voice prompts to request the desired service, such as "Traffic" or "Directions". You can also say, "What are my choices?" to receive a list of available services from which to choose.
4. Say, "Services" to return to the Services main menu or for help, say, "Help".

## Connecting to SYNC Services Using the Touchscreen



If your vehicle is equipped with Navigation, press the **Information** button.

If your vehicle is not equipped with Navigation, press the green tab on your touchscreen.

1. Select **Connect to Services** to initiate an outgoing call to SYNC Services using your phone.
2. Once connected, follow the voice prompts to request your desired Service, such as "Traffic" or "Directions". You can also say, "What are my choices?" to receive a list of available services from which to choose.
3. Say, "Services" to return to the Services main menu or for help, say, "Help".

## Receiving Turn-by-Turn Directions

1. When connected to SYNC Services, say "Directions" or "Business search". To find the closest business or type of business to your current location, just say "Business search" and then "Search near me". If you need further

assistance in finding a location you can say "Operator" at any time within a Directions or Business search to speak with a live operator. The system may prompt you to speak with an operator when it has difficulty matching your voice request. The live operator can assist you by searching for businesses by name or by category, residential addresses by street address or by name or specific street intersections. Operator Assist is a feature of your SYNC Services subscription. For more information on Operator Assist, visit [www.SYNCMyRide.com/support](http://www.SYNCMyRide.com/support).

2. Follow the voice prompts to select your Destination. After the route download is finished, the phone call automatically ends.

If your vehicle is not equipped with Navigation:

- Turn-by-turn directions appear in the information display, in the status bar of your touchscreen system and on the SYNC Services screen. You also receive driving instructions from audible prompts.
- When on an active route, you can select **Route Summary** or **Route Status** using the touchscreen controls or voice commands to view the **Route Summary Turn List** or the **Route Status ETA**. You can also turn voice guidance on or off, cancel the route or update the route.

If you miss a turn, SYNC automatically asks if you want the route updated. Just say, "Yes" when prompted and the system delivers a new route to your vehicle.

If your vehicle is equipped with Navigation, SYNC Services downloads your requested destination to the navigation system. The navigation system then calculates the route and provides driving instructions. See **Navigation** (page 414).

# MyFord Touch™ (If Equipped)

## Disconnecting from SYNC Services

1. Press and hold the hang-up phone

button on the steering wheel.

2. Say "Good-bye" from the SYNC Services main menu.

### SYNC Services quick tips

Personalizing	You can personalize your Services feature to provide quicker access to your most used or favorite information. You can save address points, such as work or home. You can also save favorite information like sports teams, such as Detroit Lions, or a news category. You can learn more about personalization by logging onto <a href="http://www.SYNCMyRide.com">www.SYNCMyRide.com</a> .
Push to interrupt	Press the voice button at any time (while connected to SYNC Services) to interrupt a voice prompt or an audio clip (such as a sports report) and say your voice command.
Portable	Your subscription is associated with your Bluetooth-enabled cellular phone number, not your VIN (Vehicle Identification Number). You can pair and connect your phone to any vehicle equipped with SYNC Services and continue enjoying your personalized services.

## SYNC Services Voice Commands



When a route has been downloaded (non-navigation systems), press the voice button on the steering wheel controls. When prompted, say any of the following commands:

<b>"SERVICES"</b>
"Cancel route"
"Navigation voice off"
"Navigation voice on"
"Next turn"
"Route status"
"Route summary"

### "SERVICES"

"Services"

"Update route"

"Help"

## Sirius Travel Link (If Equipped)

### WARNING



Driving while distracted can result in loss of vehicle control, crash and injury. We strongly recommend that you use extreme caution when using any device that may take your focus off the road. Your primary responsibility is the safe operation of your vehicle. We recommend against the use of any handheld device while driving and encourage the use of voice-operated systems when possible. Make sure you are aware of all applicable local laws that may affect the use of electronic devices while driving.



# MyFord Touch™ (If Equipped)

**Note:** In order to use Sirius Travel Link, your vehicle must be equipped with navigation and your navigation SD card must be in the SD card slot.

**Note:** This feature is only available in the United States.

**Note:** A paid subscription is required to access and use these features. Go to [www.siriusxm.com/travellink](http://www.siriusxm.com/travellink) for more information.

**Note:** Visit [www.siriusxm.com/traffic](http://www.siriusxm.com/traffic) and click on Coverage map and details for a complete listing of all traffic areas covered by Sirius Travel Link.

**Note:** Neither Sirius nor Ford is responsible for any errors or inaccuracies in the Sirius Travel Link services or its use in vehicles.

When you subscribe to Sirius Travel Link, it can help you locate the best gas prices, find movie listings, get current traffic alerts, view the current weather map, get accurate ski conditions and see scores to current sports games.



If your vehicle is equipped with Navigation, touch the **I** (Information) button to access these features. If your vehicle is not equipped with Navigation, touch the corner of the touchscreen with the green tab.

## Traffic On Route and Traffic Nearby

Touch these buttons to identify traffic incidents on your route, nearby your vehicle's current location or near any of your favorite places, if programmed.

## Fuel Prices

Touch this button to view fuel prices at stations close to your vehicle's location or on an active navigation route.

## Movie Listings

Touch this button to view nearby movie theaters and their show times, if available.

## Weather

Touch this button to view the nearby weather, current weather, or the five day forecast for the chosen area. Select **Map** to see the weather map, which can show storms, radar information, charts and winds. Select **Area** to select from a listing of weather locations.

## Sports Info

Touch this button to view scores and schedules from a variety of sports. You can also save up to 10 favorite teams for easier access. The score automatically refreshes when a game is in progress.

## Ski Conditions

Touch this button to view ski conditions for a specific area.

## Sirius Travel Link Voice Commands



Press the voice button on the steering wheel controls. When prompted, say any of the following commands:

<b>"SIRIUS TRAVEL LINK"</b>
"5-day weather forecast"
"Fuel prices"
"Movie listings"
"Sports headlines"*
"Sports schedules"*
"Sports scores"*
"Traffic"

# MyFord Touch™ (If Equipped)

<b>"SIRIUS TRAVEL LINK"</b>
"Weather"
"Weather map"
"Help"

\* If you say "Sports headlines", "Sports schedules" or "Sports scores", you can then say any of the commands in the following chart.

<b>Sports-related commands</b>
"Baseball"
"College basketball"
"College football"
"Golf"
"MLS"
"My teams"
"NBA"
"NFL"
"NHL"
"WNBA"
"Help"

<b>Additional sports-related voice commands</b>
"Baseball headlines"
"Baseball schedule"
"Baseball scores"
"College basketball headlines"
"College basketball schedule"
"College basketball scores"

<b>Additional sports-related voice commands</b>
"College football headlines"
"College football schedule"
"College football scores"
"Golf headlines"
"Golf leaderboard"
"Golf schedule"
"MLS headlines"
"MLS schedule"
"MLS scores"
"Motor sports headlines"
"Motor sports order"
"Motor sports schedule"
"My team headlines"
"My teams schedule"
"My teams scores"
"NBA headlines"
"NBA schedule"
"NBA scores"
"NFL headlines"
"NFL schedule"
"NFL scores"
"NHL headlines"
"NHL schedule"
"NHL scores"
"WNBA headlines"

# MyFord Touch™ (If Equipped)

## Additional sports-related voice commands

"WNBA schedule"

"WNBA scores"

"Help"

## Alerts

 If your vehicle is equipped with Navigation, touch the I (Information) button to access these features. If your vehicle is not equipped with Navigation, touch the corner of the touchscreen with the green tab.

Press **Alerts**, and then choose from any of the following services:

- **View** the complete message.
- **Delete** the message.
- **Delete All** messages.

This screen displays any system messages (such as an SD card fault).

**Note:** The system alerts you to any messages by turning the information icon yellow. After you read or delete the messages, the icon returns to white.

## Calendar

 If your vehicle is equipped with Navigation, touch the I (Information) button to access these features. If your vehicle is not equipped with Navigation, touch the corner of the touchscreen with the green tab.

Press **Calendar**. You can view the current calendar by day, week or month.

## 911 Assist (If Equipped)

### WARNINGS



Unless the 911 Assist setting is set on before a crash, the system will not dial for help, which could delay response time, potentially increasing the risk of serious injury or death after a crash.



Do not wait for 911 Assist to make an emergency call if you can do it yourself. Dial emergency services immediately to avoid delayed response time, which could increase the risk of serious injury or death after a crash. If you do not hear 911 Assist within five seconds of the crash, the system or phone may be damaged or non-functional.



Always place your phone in a secure location in your vehicle so it does not become a projectile or damaged in a crash. Failure to do so may cause serious injury to someone or damage the phone, which could prevent 911 Assist from working properly.

**Note:** The SYNC 911 Assist feature must be set on prior to the incident.

**Note:** Before setting this feature on, make sure that you read the 911 Assist Privacy Notice later in this section for important information.

**Note:** If any user turns 911 Assist on or off, that setting applies for all paired phones. If 911 Assist is turned off, either a voice message plays or a display message (or icon) comes on (or both) when your vehicle is started after a previously paired phone connects.

**Note:** Every phone operates differently. While SYNC 911 Assist works with most cellular phones, some may have trouble using this feature.

If a crash deploys an airbag, excluding knee airbags and rear inflatable safety belts where fitted or activates the fuel pump shut-off, your SYNC-equipped vehicle may be able to contact emergency services by dialing 911 through a paired and connected Bluetooth-enabled phone. You can learn more about the 911 Assist feature, visit [www.SYNCMyRide.com](http://www.SYNCMyRide.com), [www.SYNCMyRide.ca](http://www.SYNCMyRide.ca) or [www.syncmaroute.ca](http://www.syncmaroute.ca).

See **Supplementary Restraints System** (page 36). Important information regarding airbag deployment is in this chapter.

See **Roadside Emergencies** (page 212). Important information regarding the fuel pump shut-off is in this chapter.

### Setting 911 Assist On



If your vehicle is equipped with Navigation, touch the **i** (Information) button to access these features. If your vehicle is not equipped with Navigation, touch the corner of the touchscreen with the green tab.

Touch **Apps > 911 Assist**, then select **On**.



You can also access 911 Assist by:

- Pressing the Settings icon > **Settings > Phone > 911 Assist**, or
- Pressing the Settings icon > **Help > 911 Assist**.

To make sure that 911 Assist works properly:

- SYNC must be powered and working properly at the time of the incident and throughout feature activation and use.
- The 911 Assist feature must be set on prior to the incident.

- You must pair and connect a Bluetooth-enabled and compatible phone to SYNC.
- A connected Bluetooth-enabled phone must have the ability to make and maintain an outgoing call at the time of the incident.
- A connected Bluetooth-enabled phone must have adequate network coverage, battery power and signal strength.
- The vehicle must have battery power and be located in the United States, Canada or in a territory in which 911 is the emergency number.

### In the Event of a Crash

Not all crashes deploy an airbag or activate the fuel pump shut-off (which would trigger 911 Assist); however, SYNC tries to contact emergency services if 911 Assist triggers. If a connected phone sustains damage or loses connection to SYNC, SYNC searches for, and tries to connect to, any available previously paired phone and tries to make the call to 911.

Before making the call:

- SYNC provides a short window of time (approximately 10 seconds) to cancel the call. If you fail to cancel the call, SYNC attempts to dial 911.
- SYNC says the following, or a similar message: "SYNC will attempt to call 911, to cancel the call, press Cancel on your screen or press and hold the phone button on your steering wheel."

If you do not cancel the call, and SYNC makes a successful call, a pre-recorded message plays for the 911 operator, and then the occupant(s) in your vehicle is able to talk with the operator. Be prepared to provide your name, phone number and location immediately, because not all 911 systems are capable of receiving this information electronically.

# MyFord Touch™ (If Equipped)

## 911 Assist May Not Work If:

- Your cellular phone or 911 Assist hardware sustains damage in a crash.
- The vehicle's battery or the SYNC system has no power.
- The phone(s) previously paired or connected to the system are thrown from the vehicle.

## 911 Assist Privacy Notice

When you turn on 911 Assist, it may disclose to emergency services that your vehicle has been in a crash involving the deployment of an airbag or activation of the fuel pump shut-off. Certain versions or updates to 911 Assist may also be capable of electronically or verbally disclosing to 911 operators your vehicle location or other details about your vehicle or crash to assist 911 operators to provide the most appropriate emergency services. If you do not want to disclose this information, do not turn the feature on.

## Vehicle Health Report (If Equipped, United States Only)

### WARNING



Always follow scheduled maintenance instructions, regularly inspect your vehicle, and seek repair for any damage or problem you suspect. Vehicle Health Report supplements, but cannot replace, normal maintenance and vehicle inspection. Vehicle Health Report only monitors certain systems electronically monitored by your vehicle and will not monitor or report the status of any other system, (such as brake lining wear). Failure to perform scheduled maintenance and regularly inspect your vehicle may result in vehicle damage and serious injury.

**Note:** Your Vehicle Health Report feature requires activation prior to use. Visit [www.SYNCMYRIDE.com](http://www.SYNCMYRIDE.com) to register. There is no fee or subscription associated with Vehicle Health Report, but you must register to use this feature.

**Note:** This feature may not function properly if you have enabled caller ID blocking on your cellular phone. Before running a report, review the Vehicle Health Report Privacy Notice.

**Note:** In order to allow a break-in period for your vehicle, you may not be able to create a Vehicle Health Report until your vehicle odometer has reached 200 miles.

**Note:** Cellular phone and SMS charges may apply when making a report.

Register for Vehicle Health Report and set your report preferences at [www.SYNCMYRIDE.com](http://www.SYNCMYRIDE.com). After registering, you can request a Vehicle Health Report (inside your vehicle). Return to your account at [www.SYNCMYRIDE.com](http://www.SYNCMYRIDE.com) to view your report. You can also choose for SYNC to remind you automatically to run reports at specific mileage intervals. Cellular phone airtime usage may apply when reporting.

The system allows you to check your vehicle's overall health in the form of a diagnostic report card. The Vehicle Health Report contains valuable information, for example:

- Vehicle diagnostic information.
- Scheduled maintenance.
- Open recalls and Field Service Actions.
- Items noted during vehicle inspections by your authorized dealer that still need servicing.

## Making a Report



If you want to run a report by using the touchscreen, touch **Apps > Vehicle Health Report.**

# MyFord Touch™ (If Equipped)



To run a report by voice command, press the voice button on the steering wheel and, when prompted, say "Vehicle health report".

## Vehicle Health Report Privacy Notice

When you create a Vehicle Health Report, Ford Motor Company may collect your cellular phone number (to process your report request) and diagnostic information about your vehicle. Certain versions or updates to Vehicle Health Report may also collect more vehicle information. Ford may use your vehicle information it collects for any purpose. If you do not want to disclose your cellular phone number or vehicle

information, do not run the feature or set up your Vehicle Health Report profile at [www.SYNCMYride.com](http://www.SYNCMYride.com). See [www.SYNCMYride.com](http://www.SYNCMYride.com) (Vehicle Health Report Terms and Conditions, and Privacy Statement) for more information.

## CLIMATE

Touch the lower right corner on the touchscreen to access your climate control features. Depending on your vehicle line and option package, your climate screen may look different from this screen.

**Note:** You can switch temperature units between Fahrenheit and Celsius. See **Settings** (page 369).

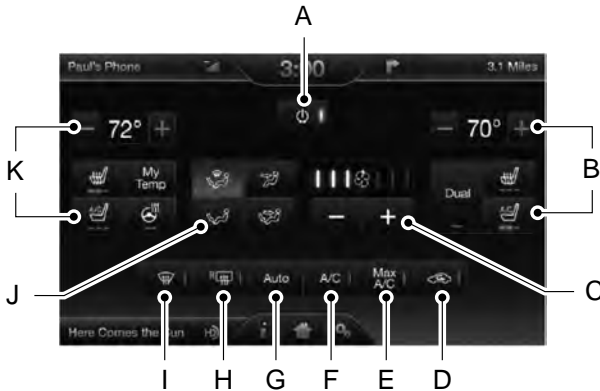

E166138

- A Power:** Touch the button to turn the system on and off. Switching off the climate control system prevents outside air from entering the vehicle.
- B Passenger settings:**
  - Touch the **+** or **-** to increase or decrease the air temperature on the passenger side of the vehicle.
  - Touch the heated seat icon to turn the heated seat off and on (if equipped).
  - Touch the climate-controlled seat icon to turn the climate-controlled seat off and on (if equipped).

## MyFord Touch™ (If Equipped)

---

Touch **DUAL** to turn separate passenger side temperature controls off and on. When you turn off DUAL, the passenger side temperature changes to match the driver side temperature.

**Note:** The passenger side temperature and the **DUAL** indicator automatically turn on when the passenger is adjusting their temperature control.

- C **Fan speed:** Touch **+** or **-** to increase or decrease the volume of air circulated in your vehicle.
- D **Recirculated air:** Touch the button to switch between outside air and recirculated air. When you select recirculated air, the air currently in the passenger compartment recirculates. This may reduce the time needed to cool the interior (when used with **A/C**) and may reduce unwanted odors from entering your vehicle.

**Note:** Recirculated air may turn off automatically (or be prevented from turning on) in all airflow modes except **MAX A/C** to reduce risk of fogging.
- E **MAX A/C:** Touch the button to maximize cooling. Recirculated air flows through the instrument panel vents, air conditioning automatically turns on, and the fan automatically adjusts to the highest speed.
- F **A/C:** Touch the button to turn air conditioning compressor on or off. Use air conditioning with recirculated air to improve cooling performance and efficiency.

**Note:** In certain conditions, the air conditioning compressor may continue to operate even after you switch off the air conditioning with the **A/C** button.
- G **AUTO:** Touch the button to turn on automatic operation. Select the desired temperature using the temperature control. The system adjusts fan speed, air distribution, air conditioning operation, and selects outside air or recirculated air to heat or cool the vehicle in order to maintain the desired temperature. You can also use the **AUTO** button to turn off dual zone operation by touching and holding the button for more than two seconds.
- H **Heated rear window:** Turns the heated rear window on and off. See **Heated Windows and Mirrors** (page 111).
- I **Defrost:** Press the button to distribute air to the windshield vents and de-mister. Air distribution to instrument panel and footwell vents turn off. You can use this setting to defog and clear the windshield of a thin covering of ice.
- J **Air distribution control:** Touch these buttons to turn airflow from the windshield, instrument panel, or footwell vents on or off. The system can distribute air through any combination of these vents.
- K **Driver settings:**

Touch the **+** or **-** to increase or decrease the air temperature on the passenger side of the vehicle.

Touch the heated seat icon to turn the heated seat off and on (if equipped).

## MyFord Touch™ (If Equipped)

Touch the climate-controlled seat icon to turn the climate-controlled seat off and on (if equipped).

Touch **MyTemp** to select your preset temperature setpoint. Touch and hold **MyTemp** to save a new preset temperature setpoint.

Touch the heated steering wheel icon to turn the heated steering wheel on and off (if equipped).

**Note:** *If your vehicle is equipped with a wood-trimmed steering wheel, it does not heat between the 10 o'clock and 2 o'clock positions.*

### Climate Control Voice Commands



Press the voice button on the steering wheel controls. When prompted, say any of the following commands:

Climate control commands
"Climate automatic"
"Climate off"
"Climate on"
"Climate temperature <15.5-29.5> degrees"
"Climate temperature <60-85> degrees"
"Help"

There are additional climate control commands but in order to access them, you have to say "Climate" first. When the system is ready to listen, you may say any of the following commands:

"CLIMATE"
"A/C off"
"A/C on"
"Automatic"

"CLIMATE"
"Defrost off"
"Defrost on"
"Dual off"
"Floor on"
"Fan decrease"
"Fan increase"
"Floor on"
"MAX A/C off"
"MAX A/C on"
"My temp"
"Off"
"On"
"Panel floor on"
"Panel off"
"Panel on"
"Recirc off"
"Recirc on"
"Temperature"*
"Temperature <15.5-29.5> degrees"
"Temperature <60-85> degrees"
"Temperature decrease"
"Temperature high"



# MyFord Touch™ (If Equipped)

"CLIMATE"
"Temperature increase"
"Temperature low"
"Windshield floor on"
"Help"

\* If you say "Temperature", you can then say any of the commands in the following chart.

"TEMPERATURE"
"<15.5-29.5> degrees"
"<60-85> degrees"
"High"
"Low"
"Help"

## NAVIGATION

**Note:** The navigation SD card must be in the SD card slot to operate the navigation system. If you need a replacement SD card, see an authorized dealer.

**Note:** The SD card slot is spring-loaded. To remove the SD card, just push the card in and release it. Do not attempt to pull the card out to remove it; this could cause damage.

Your navigation system is comprised of two main features, destination mode and map mode.

To set a destination, press the green corner of your touchscreen, then the **Dest** button when it appears. See **Setting a Destination** later in this chapter.

To view the navigation map and your vehicle's current location, touch the green bar in the upper right-hand corner of the touchscreen, or, press **Dest**, then **Map**. See **Map mode** later in this chapter.

## Setting a Destination

Press the green corner of your touchscreen, then the **Dest** button when it appears. Choose any of the following:

Destination
My Home
Favorites
Previous Destinations
Point of Interest
Emergency
Street Address
Intersection
City Center
Map
Edit Route
Cancel Route

1. Enter the necessary information into the highlighted text fields (in any order). For address destination entry, the **Go!** button appears once you enter all the necessary information. Pressing the **Go!** button makes the address location appear on the map. If you choose **Previous Destination**, the last 20 destinations you have selected appear.

# MyFord Touch™ (If Equipped)

2. Select **Set as Dest** to make this your destination. You can also choose to set this as a waypoint (have the system route to this point on the way to your current destination) or save it as a favorite. The system considers any **Avoid Areas** selections in its route calculation.
3. Choose from up to three different types of routes, and then select **Start Route**.
  - Fastest: Uses the fastest moving roads possible.
  - Shortest: Uses the shortest distance possible.
  - Eco Route: Uses the most fuel-efficient route.

You can cancel the route or have the system demo the route for you. Select **Route Prefs** to set route preferences like avoiding freeways, tollroads, ferries and car trains as well as to use or not use high-occupancy vehicle lanes. (High-occupancy vehicle lanes are also known as carpool or diamond lanes. People who ride in buses, vanpools or carpools use these lanes.)

**Note:** *If your vehicle is on a recognized road and you do not press the **Start Route** button, the system defaults to the Fastest Route option and begins guidance.*

During route guidance, you can press the talking bubble icon that appears in the upper right navigation corner (green bar) if you want the system to repeat route guidance information. When the system repeats the last guidance instruction, it updates the distance to the next guidance instruction, since it detects when the vehicle is moving.

## Point of Interest (POI) Categories

Main categories
Food/Drink & Dining
Travel & Transportation
Financial
Emergency
Community
Health & Medicine
Automotive
Shopping
Entertainment & Arts
Recreation & Sports
Government
Domestic Services

Subcategories
Restaurant
Golf
Parking
Home & Garden
Personal Care Services
Auto Dealership
Govt Office
Public Transit
Education

To expand these listings, press the + in front of the listing.

## MyFord Touch™ (If Equipped)

The system also allows you to sort alphabetically, by distance or by cityseekr listings (if available).

### cityseekr

**Note:** *cityseekr point of interest (POI) information is limited to approximately 912 cities (881 in the United States, 20 in Canada and 11 in Mexico).*



E142634

cityseekr, when available, is a service that provides more information about certain points of interest such as restaurants, hotels and attractions.

When you have selected a point of interest, the location and information appear, such as address and phone number. If cityseekr lists the point of interest, more information is available, such as a brief description, check-in and checkout times or restaurant hours.

Press **More Information** for a longer review, a list of services and facilities, the average room or meal price as well as the website. This screen displays the point of interest icon such as:



Hotel



Coffeehouse



Food & Drink



Nightlife



Attraction



This icon appears when your selection exists in multiple categories within the system.

When you are viewing more information for hotels, cityseekr also tells you if the hotel has certain services and facilities using icons, such as:

- Restaurant.
- Business center.
- Handicap facilities.
- Laundry.
- Refrigerator.
- 24 hour room service.
- Fitness center.
- Internet access.
- Pool.
- Wi-fi.

For restaurants, cityseekr can provide information such as star rating, average cost, review, handicap access, hours of operation, and website address.

For hotels, cityseekr can provide information such as star rating, price category, review, check-in and checkout times, hotel service icons and website address.

## Setting Your Navigation Preferences

Select settings for the system to take into account when planning your route.



Press the Settings icon > **Settings** > **Navigation**.

### Map Preferences

#### Breadcrumbs

Display your vehicle's previously traveled route with white dots. Switch this feature **ON** or **OFF**.

#### Turn List Format

Have the system display your turn list **Top to Bottom** or **Bottom to Top**.

#### Parking POI Notification

Set the automatic parking point of interest notification. Switch this feature **ON** or **OFF**. When parking point of interest notification is on, the icons display on the map when you get close to your destination. This may not be very useful in dense areas, and may clutter the map when other points of interest display.

### Route Preferences

#### Preferred Route

Choose to have the system display the Shortest, Fastest or most Ecological route first. If you set **Always Use Preferred Route** to **Yes**, the system uses the selected route type to calculate only one route to the desired destination.

#### Always Use Preferred Route

Bypass route selection in destination programming. The system only calculates one route based on preferred route setting.

### Eco Time Penalty

Select a low, medium or high cost for the calculated Eco Route. The higher the setting, the longer the time allotment is for the route.

### Avoid

These features allow you to choose to have the system avoid freeways, toll roads, ferries and car trains when planning your route. Switch these features **ON** or **OFF**.

### Use HOV Lanes

Have the system use high-occupancy vehicle lanes, if available, when planning your route.

### Navigation Preferences

#### Guidance Prompts

Have the system use **Voice & Tones** or **Tone Only** on your programmed route.

#### Auto - Fill State/Province

Have the system automatically fill in the state and province based on the information already entered into the system. Switch this feature **ON** or **OFF**.

### Traffic Preferences

#### Avoid Traffic Problems

Choose how you want the system to handle traffic problems along your route.

- **Automatic:** Have the system reroute you to avoid traffic incidents that develop and impact the current route. The system does not provide a traffic alert notification.
- **Manual:** Have the system always provide a traffic alert notification for traffic incidents along the planned route. You have a choice to accept or ignore the notification before making the route deviation.

## Traffic Alert Notification

Have the system display traffic alert notifications.

Other traffic alert features allows you to turn on certain, or all, traffic icons on the map such as road work, incident, accidents and closed roads. Scroll down to view all the different types of alerts. Switch these features **ON** or **OFF**.

## Avoid Areas

Choose areas which you want the system to avoid when calculating a route for you.

Press **Add** to program an entry. Once you make a selection, the system tries to avoid the area(s) if possible for all routes. To delete a selection, choose the listing on the screen. When the screen changes to **Avoid Areas Edit**, you can press **Delete** at the bottom right of the screen.

## Map Mode

Press the green bar in the upper right area of the touchscreen to view map mode. Map mode shows advanced viewing comprised of both 2D city maps as well as 3D landmarks (when available).

2D city maps show detailed outlines of buildings, visible land use and land elements and detailed railway infrastructure for the most essential cities around the globe. These maps also contain features, such as town blocks, building footprints and railways.

3D landmarks appear as clear, visible objects that are typically recognizable and have a certain tourist value. The 3D landmarks appear in 3D map mode only. Coverage varies and improves with updated map releases.



E174016

Change the appearance of the map display by repeatedly pressing the arrow button in the upper left corner of the screen. It toggles between three different map modes: Heading up, North up and 3D.



**Heading up (2D map)** always shows the direction of forward travel to be upward on the screen.

This view is available for map scales up to 2.5 miles (4 kilometers). The system remembers this setting for larger map scales, but shows the map in North up only. If the scale returns below this level, the system restores Heading up.



**North up (2D map)** always shows the northern direction to be upward on the screen.



**3D map mode** provides an elevated perspective of the map. This viewing angle can be adjusted and the map can be rotated 180 degrees by touching the map twice, and then dragging your finger along the shaded bar with arrows at the bottom of the map.

**View** switches between full map, street list and exit view in route guidance.

**Menu** displays a pop-up box that allows direct access to navigation settings, View/Edit Route, SIRIUS Travel Link, Guidance Mute and Cancel Route.

# MyFord Touch™ (If Equipped)



Press the speaker button on the map to mute route guidance. When the light on the button illuminates, the feature is on. The speaker button appears on the map only when route guidance is active.



Re-center the map by pressing this icon whenever you scroll the map away from your vehicle's current location.

## Auto Zoom

Press the green bar to access map mode, then select the **+** or **-** zoom button to bring up the zoom level and Auto buttons on the touchscreen. When you press **Auto**, Auto Zoom turns on and **Auto** displays in the bottom left corner of the screen in the map scale. The map zoom level then synchronizes with vehicle speed. The slower your vehicle is traveling, the farther the map zooms in; the faster your vehicle is traveling, the farther the map zooms out. To switch off the feature, just press the **+** or **-** button again.

In 3D mode, rotate the map view by swiping your finger across the shaded bar with the arrows.

The ETA box under the zoom buttons appears when a route is active and displays the distance and time to your destination. If the button is pressed, a pop up appears with the destination listed (and waypoint if applicable) along with mileage and time to destination. You may also select to have either the estimated time to reach your destination or your estimated arrival time.

## Map Icons



**Vehicle mark** shows the current location of your vehicle. It stays in the center of the map display, except when in scroll mode.



**Scroll cursor** allows you to scroll the map; the fixed icon is in the center of the screen. The map position closest to the cursor is in a window on the top center part of the screen.



**Address book entry default icon(s)** indicates the location on the map of an address book entry. This is the default symbol shown after the entry has been stored to the Address Book by any method other than the map. You can select from any of the 22 icons available. You can use each icon more than once.



**Home** indicates the location on the map currently stored as the home position. You can only save one address from the Address Book as your Home entry. You cannot change this icon.



**POI (Point Of Interest) icons** indicate locations of any point of interest categories you choose to display on the map. You can choose to display three point of interest categories on the map at one time.



**Starting point** indicates the starting point of a planned route.



**Waypoint** indicates the location of a waypoint on the map. The number inside the circle is different for each waypoint and represents the position of the waypoint in the route list.



**Destination symbol** indicates the ending point of a planned route.



**Next maneuver point** indicates the location of the next turn on the planned route.



**No GPS symbol** indicates that insufficient GPS satellite signals are available for accurate map positioning. This icon may display

under normal operation in an area with poor GPS access.

## Quick-touch Buttons

When in map mode, touch anywhere on the map display to access the following options:

### Set as Dest

Touch this button to select a scrolled location on the map as your destination. You may scroll the map by pressing your index finger on the map display. When you reach the desired location, simply let go and then touch **Set as Dest**.

### Set as Waypoint

Touch this button to set the current location as a waypoint.

### Save to Favorites

Touch this button to save the current location to your favorites.

### POI Icons

Touch this button to select icons to display on the map. You can select up to three icons to display on the map at the same time. Turn these **ON** or **OFF**.

### Cancel Route

Touch this button to cancel the active route.

### View/Edit Route

Access these features when a route is active:

- View Route
- Edit Destination/Waypoints

- Edit Turn List
- Detour
- Edit Route Preferences
- Edit Traffic Preferences
- Cancel Route.

Nokia is the digital map provider for the navigation application. If you find map data errors, you may report them directly to Nokia by going to <http://mapreporter.navteq.com>. Nokia evaluates all reported map errors and responds with the result of their investigation by e-mail.

## Navigation Map Updates

Annual navigation map updates are available for purchase through your dealership, by calling 1-866-4NAVTEQ (1-866-462-8837) (in Mexico, call 01-800-557-5539) or going to [www.navigation.com/sync](http://www.navigation.com/sync). You need to specify the make and model of your vehicle to determine if there is an update available.

## Navigation Voice Commands



When in navigation mode, press the voice button on the steering wheel controls. After the tone, say any of the following commands:

Navigation system voice commands
"Cancel next waypoint" <sup>1</sup>
"Cancel route" <sup>1</sup>
"Destination" <sup>2</sup>
"Destination <nametag>"
"Destination <POI category>"
"Destination favorites"
"Destination home"

# MyFord Touch™ (If Equipped)

Navigation system voice commands
"Destination intersection"
"Destination nearest <POI category>"
"Destination nearest POI"
"Destination play nametags"
"Destination POI"
"Destination POI category"
"Destination previous destination"
"Destination street address"
"Detour" <sup>1</sup>
"Navigation" <sup>3</sup>
"Navigation voice volume decrease"
"Navigation voice volume increase"
"Repeat instruction" <sup>1</sup>
"Show 3D"
"Show heading up"
"Show map"
"Show north up"
"Show route" <sup>1</sup>
"Show turn list" <sup>1</sup>
"Voice guidance off"
"Voice guidance on"
"Where am I?"
"Zoom in"

Navigation system voice commands
"Zoom out"
"Help"

<sup>1</sup> These commands are only available when a navigation route is active.

<sup>2</sup> If you say "Destination", you can then say any command in the following "Destination" chart.

<sup>3</sup> If you say "Navigation", you can then say any command in the following "Navigation" chart.

<b>"DESTINATION"</b>
"<nametag>"
"<POI category>"
"Favorites"
"Home"
"Intersection"
"Nearest <POI category>"
"Nearest POI"
"Play nametags"
"POI category"
"Previous destination"
"Street address"
"Help"

<b>"NAVIGATION"</b>
"Destination" <sup>2</sup>
"Zoom city"
"Zoom country"
"Zoom minimum"



# MyFord Touch™ (If Equipped)

<b>"NAVIGATION"</b>
"Zoom maximum"
"Zoom province"
"Zoom state"
"Zoom street"
"Zoom to <distance>"
"Help"

\* If you say "Destination", you can then say any command in the "Destination" chart.

## One-shot Destination Street Address

When you say either "Navigation destination street address" or "Destination street address", the system asks you to say the full address. The system displays an example on-screen. You can then speak the address naturally, such as "One two three four Main Street, Anytown".

## MYFORD TOUCH™ TROUBLESHOOTING

Your SYNC system is easy to use. However, should questions arise, see the tables below.

Use the website at any time to check your phone's compatibility, register your account and set preferences as well as access a customer representative via an online chat (during certain hours). For more information visit:

<b>Websites</b>
<a href="http://www.SYNCMyRide.com">www.SYNCMyRide.com</a>
<a href="http://www.SYNCMyRide.ca">www.SYNCMyRide.ca</a>
<a href="http://www.syncmaroute.ca">www.syncmaroute.ca</a>

<b>Phone issues</b>		
<b>Issue</b>	<b>Possible cause(s)</b>	<b>Possible solution(s)</b>
There is excessive background noise during a phone call.	The audio control settings on your phone may be affecting SYNC performance.	Review your phone's manual about audio adjustments.
During a call, I can hear the other person but they cannot hear me.	This may be a possible phone malfunction.	Try turning off the device, resetting the device, removing the device's battery, then trying again.
SYNC is not able to download my phonebook.	This is a phone-dependent feature. This may be a possible phone malfunction.	Go to the website to review your phone's compatibility. Try turning off the device, resetting the device or removing the device's battery, then trying again. Try pushing your phonebook contacts to SYNC by using the Add Contacts feature.

## MyFord Touch™ (If Equipped)

<b>Phone issues</b>		
<b>Issue</b>	<b>Possible cause(s)</b>	<b>Possible solution(s)</b>
		Use the SYNCmyphone feature available on the website.
The system says Phonebook Downloaded but the phonebook in SYNC is empty or missing contacts.	This may be a limitation on your phone's capability.	<p>Try pushing your phonebook contacts to SYNC by using the Add Contacts feature. If the missing contacts are stored on your SIM card, try moving them to the device memory.</p> <p>Remove any pictures or special ring tones associated with the missing contact.</p> <p>Depending upon your phone, you may have to grant SYNC permission to access your phonebook contacts. Make sure to confirm when prompted by your phone during the phonebook download.</p>
I am having trouble connecting my phone to SYNC.	This is a phone-dependent feature. This may be a possible phone malfunction.	<p>Go to the website to review your phone's compatibility. Try turning off the device, resetting the device or removing the device's battery, then trying again. Try deleting your device from SYNC, deleting SYNC from your device and trying again.</p> <p>Check the security and auto accept and prompt always settings relative to the SYNC Bluetooth connection on your phone.</p> <p>Update your device's firmware.</p> <p>Turn off the Auto phonebook download setting.</p>

## MyFord Touch™ (If Equipped)

<b>Phone issues</b>		
<b>Issue</b>	<b>Possible cause(s)</b>	<b>Possible solution(s)</b>
		You can also preform the MyFord Touch reset procedure.
Text messaging is not working on SYNC.	This is a phone-dependent feature. This may be a possible phone malfunction.	Go to the website to review your phone's compatibility. Try turning off the device, resetting the device or removing the device's battery, then trying again.

<b>USB and media issues</b>		
<b>Issue</b>	<b>Possible cause(s)</b>	<b>Possible solution(s)</b>
I am having trouble connecting my device.	This may be a possible device malfunction.	Try turning off the device, resetting the device, removing the device's battery, then trying again. Make sure you are using the manufacturer's cable. Make sure you insert the USB cable correctly into the device and the USB port. Make sure that the device does not have an auto-install program or active security settings.
SYNC does not recognize my device when I turn on the car.	This is a device limitation.	Make sure you are not leaving the device in your vehicle during very hot or cold temperatures.
Bluetooth audio does not stream.	This is a phone-dependent feature. The device is not connected.	Review the device compatibility chart on the SYNC website to confirm your phone supports the Bluetooth audio streaming function. Make sure you correctly connect the device to SYNC, and that you have pressed play on your device.

## MyFord Touch™ (If Equipped)

<b>USB and media issues</b>		
<b>Issue</b>	<b>Possible cause(s)</b>	<b>Possible solution(s)</b>
		You can also preform the MyFord Touch reset procedure.
SYNC does not recognize music that is on my device.	Your music files may not contain the correct artist, song title, album or genre information. The file may be corrupted. The song may have copy-right protection, which does not allow it to play.	Make sure that all song details are populated. Some devices require you to change the USB settings from mass storage to MTP class.

<b>Vehicle Health Report and Services (Traffic, Directions and Information) issues</b>		
<b>Issue</b>	<b>Possible cause(s)</b>	<b>Possible solution(s)</b>
I received a text that I did not activate Vehicle Health Report.	You did not activate your account on the website. You may have the wrong VIN (vehicle identification number) listed.	This is a free feature, but you must first register online to use it. Make sure that your VIN is correctly listed in your account.
I am unable to retrieve the report on the website, or I receive a system error.	The preferred dealer information did not load correctly.	When you register your account, you must choose a preferred dealer. If it already lists a dealer, try selecting another dealer and logging out. Log back in, change it back to your preferred dealer, and retrieve the report.
I am unable to submit a report.	This could be due to your phone's compatibility. Bad signal strength. You did not register your phone correctly on the website.	Update your cellular number in your account on the website. Make sure you have full signal strength and that your Bluetooth volume level has been turned up.

## MyFord Touch™ (If Equipped)

<b>Vehicle Health Report and Services (Traffic, Directions and Information) issues</b>		
<b>Issue</b>	<b>Possible cause(s)</b>	<b>Possible solution(s)</b>
		Make sure the currently connected phone is registered on your SYNCMyRide account. Try deleting your phone and performing a clean pairing.
I heard a commercial when I tried to use Traffic, Directions and Information.	You did not activate this phone for this service. Your phone has ID blocker active.	This is a free feature, but you must first register online to use it. Turn off ID blocker on your phone as the system recognizes you by your phone number. Make sure the currently connected phone is the same one that is registered on your SYNCMyRide account.

<b>Voice command issues</b>		
<b>Issue</b>	<b>Possible cause(s)</b>	<b>Possible solution(s)</b>
SYNC does not understand what I am saying.	You may be using the wrong voice commands. You may be speaking too soon or at the wrong time.	Review the phone voice commands and the media voice commands at the beginning of their respective sections. After pressing the voice icon, wait until after the tone sounds and Listening appears before saying a command. Any command spoken before this does not register with the system.
SYNC does not understand the name of a song or artist.	You may be using the wrong voice commands. You may be saying the name differently than the way you saved it.	Review the media voice commands at the beginning of the media section.

## MyFord Touch™ (If Equipped)

<b>Voice command issues</b>		
<b>Issue</b>	<b>Possible cause(s)</b>	<b>Possible solution(s)</b>
	<p>The system may not be reading the name the same way you are saying it.</p>	<p>Say the song or artist exactly as listed. If you say "Play Artist Prince", the system does not play music by Prince and the Revolution or Prince and the New Power Generation. Make sure you are saying the complete title, such as "California remix featuring Jennifer Nettles". If the song titles are in all CAPS, you have to spell them. LOLA requires you to say "L-O-L-A". Do not use special characters in the title. The system does not recognize them.</p>
<p>SYNC does not understand or is calling the wrong contact when I want to make a call.</p>	<p>You may be using the wrong voice commands. You may be saying the name differently than the way you saved it. The system may not be reading the name the same way you are saying it. Contacts in your phonebook may be very short and similar, or they may contain special characters. Your phonebook contacts may be in CAPS.</p>	<p>Review the Phone voice commands at the beginning of the phone section. Make sure you are saying the contacts exactly as they are listed. For example, if you save a contact as Joe Wilson, say "Call Joe Wilson". Using the SYNC phone menu, open the phonebook and scroll to the name SYNC is having trouble understanding. SYNC will read the name to you, giving you some idea of the pronunciation SYNC is expecting. The system works better if you list full names, such as "Joe Wilson" rather than "Joe".</p>

## MyFord Touch™ (If Equipped)

<b>Voice command issues</b>		
<b>Issue</b>	<b>Possible cause(s)</b>	<b>Possible solution(s)</b>
		Do not use special characters, such as 123 or ICE, as the system does not recognize them. If a contact is in CAPS, you have to spell it. JAKE requires you to say "Call J-A-K-E".

<b>Touchscreen System Reset</b>
The touchscreen system has System Reset feature that can be performed if the function of a SYNC feature is lost. This reset is intended to restore functionality and will not erase any information previously stored in the system (such as paired devices, phonebook, call history, text messages, or user settings). To perform a System Reset, press and hold the Seek Up (>>) button while pressing and holding the Radio Power button. After approximately 5 seconds the screen will go black. Allow a 1-2 minutes for the system reset to complete. You may then resume using the SYNC system.

# Accessories

---

For a complete listing of the accessories that are available for your vehicle, please contact an authorized dealer or visit our online store at **www.Accessories.Ford.com** (United States only).

Ford Motor Company will repair or replace any properly authorized dealer-installed Ford Genuine Accessories found to be defective in factory-supplied materials or workmanship during the warranty period, as well as any component damaged by the defective accessories.

Ford Motor Company will warrant your vehicle through the warranty that provides the greatest benefit:

- 24 months, unlimited mileage.
- The remainder of your new vehicle limited warranty.

Contact an authorized dealer for details and a copy of the warranty.

## Exterior style

- Bug shields.
- Exhaust tip.
- Deflectors.
- Running boards.
- Splash guards.
- Step bars.
- Fog lamps.
- Custom graphics\*.
- Stainless-steel wheel covers\*.
- Wheel well liners.

## Interior style

- Floor mats.
- Cargo organizers.
- Custom seat covers\*.

## Lifestyle

- Ash cup / smoker's package.
- Bedliners and bedmats.
- Rear-seat entertainment\*.
- Tonneau covers\*.
- Trailer hitches, wiring harnesses and accessories.
- Racks and carriers\*.
- Truck bed camping tent\*.
- Sportliner cargo liner\*.
- Bed extender.

## Peace of mind

- Keyless entry keypad.
- Back-up alarm\*.
- Remote start and alarms.
- Wheel locks.
- Protective seat covers\*.
- Bumper and hitch-mounted parking sensors\*.
- Cable lock\*.
- Bed hooks\*.
- Tool/Cargo boxes\*.
- Speed/Cruise control.

\*The accessory manufacturer designs, develops and therefore warrants Ford Licensed Accessories, and does not design or test these accessories to Ford Motor Company engineering requirements. Contact an authorized Ford dealer for the manufacturer's limited warranty details, and request a copy of the Ford Licensed Accessories product limited warranty from the accessory manufacturer.



# Accessories

---

For maximum vehicle performance, keep the following information in mind when adding accessories or equipment to your vehicle:

- When adding accessories, equipment, passengers and luggage to your vehicle, do not exceed the total weight capacity of the vehicle or of the front or rear axle (GVWR or GAWR as indicated on the Safety Compliance Certification label). Ask an authorized dealer for specific weight information.
- The Federal Communications Commission (FCC) and Canadian Radio Telecommunications Commission (CRTC) regulate the use of mobile communications systems that are equipped with radio transmitters, for example, two-way radios, telephones and theft alarms. Any such equipment installed in your vehicle should comply with Federal Communications Commission (FCC) and Canadian Radio Telecommunications Commission (CRTC) regulations and should be installed only by an authorized dealer.
- An authorized dealer needs to install mobile communications systems. Improper installation may harm the operation of your vehicle, particularly if the manufacturer did not design the mobile communication system specifically for automotive use.
- If you or an authorized Ford dealer add any non-Ford electrical or electronic accessories or components to your vehicle, you may adversely affect battery performance and durability. In addition, you may also adversely affect the performance of other electrical systems in the vehicle.

## AUXILIARY SWITCHES

For maximum vehicle performance, keep the following information in mind when adding accessories or equipment to your vehicle:

- When adding accessories, equipment, passengers and luggage to your vehicle, do not exceed the total weight capacity of the vehicle or of the front or rear axle (GVWR or GAWR as indicated on the Safety Compliance Certification label). Ask an authorized dealer for specific weight information.
- The Federal Communications Commission (FCC) and Canadian Radio Telecommunications Commission (CRTC) regulate the use of mobile communications systems equipped with radio transmitters, for example, two-way radios, telephones and theft alarms. Any such equipment installed in your vehicle should comply with Federal Communications Commission (FCC) and Canadian Radio Telecommunications Commission (CRTC) regulations, and should be installed by an authorized dealer.
- An authorized dealer needs to install mobile communications systems. Improper installation may harm the operation of your vehicle, particularly if the manufacturer did not design the mobile communication system specifically for automotive use.
- If you or an authorized Ford dealer add any non-Ford electrical or electronic accessories or components to your vehicle, you may adversely affect battery performance and durability. In addition, you may also adversely affect the performance of other electrical systems in the vehicle.

# Accessories



E163431

The auxiliary switch option package provides four switches, mounted in the center of the instrument panel. These switches operate only while the ignition is in the on position, whether the engine is running or not. Ford recommends, however, that the engine remain running to maintain battery charge when using the auxiliary switches for extended periods of time or higher current draws.

**Note:** When your vehicle has a diesel engine, use the auxiliary switches only while the engine is running. The glow plugs also drain battery power when the ignition key is in the on position. Using the auxiliary switches, even for limited amounts of time, can cause your battery to drain quickly and prevent your vehicle from restarting.

When switched on, the auxiliary switches provide 8 amps, 12 amps or 20 amps of electrical battery power for a variety of personal or commercial uses.

The relay box for the auxiliary switches is on the end of the left side of the instrument panel. See your authorized dealer for service.

The relays are coded as shown:

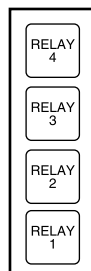

E163432

Each switch includes a power lead, a blunt-cut and sealed wire located below the instrument panel and to the left of the steering column.

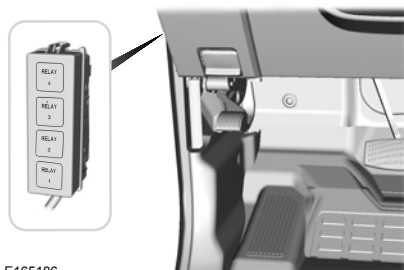

E165186

The power leads are coded as shown:

Switch	Circuit Number	Wire Color	Fuse Amp Rating
AUX 1	CAC05	Yellow	25A
AUX 2	CAC06	Green with Brown Trace	25A
AUX 3	CAC07	Violet with Green Trace	10A
AUX 4	CAC08	Brown	15A

# Accessories

---

Learn more about auxiliary switches by  
visiting  
<https://www.fleet.ford.com/truckbbas/>.

# Appendices

---

## END USER LICENSE AGREEMENT

### SYNC End User License Agreement (EULA)

- You have acquired a device ("DEVICE") that includes software licensed by Ford Motor Company and its affiliates ("FORD MOTOR COMPANY") from an affiliate of Microsoft Corporation ("MS"). Those installed software products of MS origin, as well as associated media, printed materials, and "online" or electronic documentation ("MS SOFTWARE") are protected by international intellectual property laws and treaties. The MS SOFTWARE is licensed, not sold. All rights reserved.
- The MS SOFTWARE may interface with and/or communicate with, or may be later upgraded to interface with and/or communicate with additional software and/or systems provided by FORD MOTOR COMPANY. The additional software and systems of FORD MOTOR COMPANY origin, as well as associated media, printed materials, and "online" or electronic documentation ("FORD SOFTWARE") are protected by international intellectual property laws and treaties. The FORD SOFTWARE is licensed, not sold. All rights reserved.

- The MS SOFTWARE and/or FORD SOFTWARE may interface with and/or communicate with, or may be later upgraded to interface with and/or communicate with additional software and/or systems provided by third party software and service suppliers. The additional software and services of third party origin, as well as associated media, printed materials, and "online" or electronic documentation ("THIRD PARTY SOFTWARE") are protected by international intellectual property laws and treaties. The THIRD PARTY SOFTWARE is licensed, not sold. All rights reserved.
- The MS SOFTWARE, FORD SOFTWARE and THIRD PARTY SOFTWARE hereinafter collectively and individually will be referred to as "SOFTWARE".

**IF YOU DO NOT AGREE TO THIS END USER LICENSE AGREEMENT ("EULA") DO NOT USE THE DEVICE OR COPY THE SOFTWARE. ANY USE OF THE SOFTWARE, INCLUDING BUT NOT LIMITED TO USE ON THE DEVICE, WILL CONSTITUTE YOUR AGREEMENT TO THIS EULA (OR RATIFICATION OF ANY PREVIOUS CONSENT).**

**GRANT OF SOFTWARE LICENSE:** This EULA grants you the following license:

- You may use the SOFTWARE as installed on the DEVICE and as otherwise interfacing with systems and/or services provide by or through FORD MOTOR COMPANY or its third party software and service providers.

# Appendices

---

## Description of Other Rights and Limitations

- **Speech Recognition:** If the SOFTWARE includes speech recognition component(s), you should understand that speech recognition is an inherently statistical process and that recognition errors are inherent in the process. Neither FORD MOTOR COMPANY nor its suppliers shall be liable for any damages arising out of errors in the speech recognition process.
- **Limitations on Reverse Engineering, Decompilation and Disassembly:** You may not reverse engineer, decompile, or disassemble nor permit others to reverse engineer, decompile or disassemble the SOFTWARE, except and only to the extent that such activity is expressly permitted by applicable law notwithstanding this limitation.
- **Limitations on Distributing, Copying, Modifying and Creating Derivative Works:** You may not distribute, copy, make modifications to or create derivative works based on the SOFTWARE, except and only to the extent that such activity is expressly permitted by applicable law notwithstanding this limitation.
- **Single EULA:** The end user documentation for the DEVICE and related systems and services may contain multiple EULAs, such as multiple translations and/or multiple media versions (e.g., in the user documentation and in the software). Even if you receive multiple EULAs, you are licensed to use only one (1) copy of the SOFTWARE.
- **SOFTWARE Transfer:** You may permanently transfer your rights under this EULA only as part of a sale or transfer of the DEVICE, provided you retain no copies, you transfer all of the SOFTWARE (including all component parts, the media and printed materials, any upgrades, and, if applicable, the Certificate(s) of Authenticity), and the recipient agrees to the terms of this EULA. If the SOFTWARE is an upgrade, any transfer must include all prior versions of the SOFTWARE.
- **Termination:** Without prejudice to any other rights, FORD MOTOR COMPANY or MS may terminate this EULA if you fail to comply with the terms and conditions of this EULA.
- **Security Updates/Digital Rights Management:** Content owners use the WMDRM technology included in your DEVICE to protect their intellectual property, included copyrighted content. Portions of the SOFTWARE on your DEVICE use WMDRM software to access WMDRM-protected content. If the WMDRM software fails to protect the content, content owners may ask Microsoft to revoke the SOFTWARE's ability to use WMDRM to play or copy protected content. This action does not affect unprotected content. When your DEVICE downloads licenses for protected content, you agree that Microsoft may include a revocation list with the licenses. Content owners may require you to upgrade the SOFTWARE on your DEVICE to access their content. If you decline an upgrade, you will not be able to access content that requires the upgrade.

# Appendices

---

- **Consent to Use of Data:** You agree that MS, Microsoft Corporation, FORD MOTOR COMPANY, third party software and systems suppliers, their affiliates and/or their designated agent may collect and use technical information gathered in any manner as part of product support services related to the SOFTWARE or related services. MS, Microsoft Corporation, FORD MOTOR COMPANY, third party software and services suppliers, their affiliates and/or their designated agent may use this information solely to improve their products or to provide customized services or technologies to you. MS, Microsoft Corporation, FORD MOTOR COMPANY, third party software and systems suppliers, their affiliates and/or their designated agent may disclose this information to others, but not in a form that personally identifies you.
- **Internet-Based Services Components:** The SOFTWARE may contain components that enable and facilitate the use of certain Internet-based services. You acknowledge and agree that MS, Microsoft Corporation, FORD MOTOR COMPANY, third party software and service suppliers, their affiliates and/or their designated agent may automatically check the version of the SOFTWARE and/or its components that you are utilizing and may provide upgrades or supplements to the SOFTWARE that may be automatically downloaded to your DEVICE.
- **Additional Software/Services:** The SOFTWARE may permit FORD MOTOR COMPANY, third party software and service suppliers, MS, Microsoft Corporation, their affiliates and/or their designated agent to provide or make available to you SOFTWARE updates,

supplements, add-on components, or Internet-based services components of the SOFTWARE after the date you obtain your initial copy of the SOFTWARE ("Supplemental Components").

If FORD MOTOR COMPANY or third party software and services suppliers provide or make available to you Supplemental Components and no other EULA terms are provided along with the Supplemental Components, then the terms of this EULA shall apply.

If MS, Microsoft Corporation, their affiliates and/or their designated agent make available Supplemental Components, and no other EULA terms are provided, then the terms of this EULA shall apply, except that the MS, Microsoft Corporation or affiliate entity providing the Supplemental Component(s) shall be the licensor of the Supplemental Component(s).

FORD MOTOR COMPANY, MS, Microsoft Corporation, their affiliates and/or their designated agent reserve the right to discontinue without liability any Internet-based services provided to you or made available to you through the use of the SOFTWARE.

## Appendices

---

- **Links to Third Party Sites:** The MS SOFTWARE may provide you with the ability to link to third party sites through the use of the SOFTWARE. The third party sites are not under the control of MS, Microsoft Corporation, their affiliates and/or their designated agent. Neither MS nor Microsoft Corporation nor their affiliates nor their designated agent are responsible for (i) the contents of any third party sites, any links contained in third party sites, or any changes or updates to third party sites, or (ii) webcasting or any other form of transmission received from any third party sites. If the SOFTWARE provides links to third party sites, those links are provided to you only as a convenience, and the inclusion of any link does not imply an endorsement of the third party site by MS, Microsoft Corporation, their affiliates and/or their designated agent.
- **Obligation to Drive Responsibly:** You recognize your obligation to drive responsibly and keep attention on the road. You will read and abide with the DEVICE operating instructions particularly as they pertain to safety and assumes any risk associated with the use of the DEVICE.

### **UPGRADES AND RECOVERY MEDIA:**

If the SOFTWARE is provided by FORD MOTOR COMPANY separate from the DEVICE on media such as a ROM chip, CD ROM disk(s) or via web download or other means, and is labeled "For Upgrade Purposes Only" or "For Recovery Purposes Only" you may install one (1) copy of such SOFTWARE onto the DEVICE as a replacement copy for the existing SOFTWARE, and use it in accordance with this EULA, including any additional EULA terms accompanying the upgrade SOFTWARE.

### **INTELLECTUAL PROPERTY RIGHTS:**

All title and intellectual property rights in and to the SOFTWARE (including but not limited to any images, photographs, animations, video, audio, music, text and "applets" incorporated into the SOFTWARE), the accompanying printed materials, and any copies of the SOFTWARE, are owned by MS, Microsoft Corporation, FORD MOTOR COMPANY, or their affiliates or suppliers. The SOFTWARE is licensed, not sold. You may not copy the printed materials accompanying the SOFTWARE. All title and intellectual property rights in and to the content which may be accessed through use of the SOFTWARE is the property of the respective content owner and may be protected by applicable copyright or other intellectual property laws and treaties. This EULA grants you no rights to use such content. All rights not specifically granted under this EULA are reserved by MS, Microsoft Corporation, FORD MOTOR COMPANY, third party software and service providers, their affiliates and suppliers. Use of any on-line services which may be accessed through the SOFTWARE may be governed by the respective terms of use relating to such services. If this SOFTWARE contains documentation that is provided only in electronic form, you may print one copy of such electronic documentation.

**EXPORT RESTRICTIONS:** You acknowledge that the SOFTWARE is subject to U.S. and European Union export jurisdiction. You agree to comply with all applicable international and national laws that apply to the SOFTWARE, including the U.S. Export Administration Regulations, as well as end-user, end-use and destination restrictions issued by U.S. and other governments. For additional information, see <http://www.microsoft.com/exporting/>.

# Appendices

---

**TRADEMARKS:** This EULA does not grant you any rights in connection with any trademarks or service marks of FORD MOTOR COMPANY, MS, Microsoft Corporation, third party software or service providers, their affiliates or suppliers.

**PRODUCT SUPPORT:** Product support for the SOFTWARE is not provided by MS, its parent corporation Microsoft Corporation, or their affiliates or subsidiaries. For product support, please refer to FORD MOTOR COMPANY instructions provided in the documentation for the DEVICE. Should you have any questions concerning this EULA, or if you desire to contact FORD MOTOR COMPANY for any other reason, please refer to the address provided in the documentation for the DEVICE.

**No Liability for Certain Damages:** EXCEPT AS PROHIBITED BY LAW, FORD MOTOR COMPANY, ANY THIRD PARTY SOFTWARE OR SERVICES SUPPLIERS, MS, MICROSOFT CORPORATION AND THEIR AFFILIATES SHALL HAVE NO LIABILITY FOR ANY INDIRECT, SPECIAL, CONSEQUENTIAL OR INCIDENTAL DAMAGES ARISING FROM OR IN CONNECTION WITH THE USE OR PERFORMANCE OF THE SOFTWARE. THIS LIMITATION SHALL APPLY EVEN IF ANY REMEDY FAILS OF ITS ESSENTIAL PURPOSE. IN NO EVENT SHALL MS, MICROSOFT CORPORATION AND/OR THEIR AFFILIATES BE LIABLE FOR ANY AMOUNT IN EXCESS OF U.S. TWO HUNDRED FIFTY DOLLARS (U.S. \$250.00).

- THERE ARE NO WARRANTIES OTHER THAN THOSE THAT MAY EXPRESSLY BE PROVIDED FOR YOUR NEW VEHICLE.

## **Adobe**

Contains Adobe® [Flash® Player] or [AIR®] technology by Adobe Systems Incorporated. This [Licensee Product] contains [Adobe® Flash® Player] [Adobe® AIR®] software under license from Adobe Systems Incorporated, Copyright ©1995-2009 Adobe Macromedia Software LLC. All rights reserved. Adobe, Flash and AIR are trademarks of Adobe Systems Incorporated.

## **End User Notice**

### **Microsoft® Windows® Mobile for Automotive Important Safety Information**

This system Ford SYNC contains software that is licensed to Manufacturer FORD MOTOR COMPANY by an affiliate of Microsoft Corporation pursuant to a license agreement. Any removal, reproduction, reverse engineering or other unauthorized use of the software from this system in violation of the license agreement is strictly prohibited and may subject you to legal action.

**Read and follow instructions:** Before using your Windows Automotive- based system, read and follow all instructions and safety information provided in this end user manual ("User's Guide"). Not following precautions found in this User's Guide can lead to an accident or other serious consequences.

**Keep User's Guide in vehicle:** When kept in the vehicle, the User's Guide will be a ready reference for you and other users unfamiliar with the Windows Automotive-based system. Please make certain that before using the system for the first time, all persons have access to the User's Guide and read its instructions and safety information carefully.



# Appendices

---

## WARNING



Operating certain parts of this system while driving can distract your attention away from the road, and possibly cause an accident or other serious consequences. Do not change system settings or enter data non-verbally (using your hands) while driving. Stop the vehicle in a safe and legal manner before attempting these operations. This is important since while setting up or changing some functions you might be required to distract your attention away from the road and remove your hands from the wheel.

---

### General Operation

**Voice Command Control:** Functions within the Windows Automotive-based system may be accomplished using only voice commands. Using voice commands while driving allows you to operate the system without removing your hands from the wheel.

**Prolonged Views of Screen:** Do not access any function requiring a prolonged view of the screen while you are driving. Pull over in a safe and legal manner before attempting to access a function of the system requiring prolonged attention. Even occasional short scans to the screen may be hazardous if your attention has been diverted away from your driving task at a critical time.

**Volume Setting:** Do not raise the volume excessively. Keep the volume at a level where you can still hear outside traffic and emergency signals while driving. Driving while unable to hear these sounds could cause an accident.

### Use of Speech Recognition Functions:

Speech recognition software is inherently a statistical process which is subject to errors. It is your responsibility to monitor any speech recognition functions included in the system and address any errors.

**Navigation Features:** Any navigation features included in the system are intended to provide turn by turn instructions to get you to a desired destination. Please make certain all persons using this system carefully read and follow instructions and safety information fully.

**Distraction Hazard:** Any navigation features may require manual (non-verbal) setup. Attempting to perform such set-up or insert data while driving can seriously distract your attention and could cause an accident or other serious consequences. Stop the vehicle in a safe and legal manner before attempting these operations.

**Let Your Judgment Prevail:** Any navigation features are provided only as an aid. Make your driving decisions based on your observations of local conditions and existing traffic regulations. Any such feature is not a substitute for your personal judgment. Any route suggestions made by this system should never replace any local traffic regulations or your personal judgment or knowledge of safe driving practices.

**Route Safety:** Do not follow the route suggestions if doing so would result in an unsafe or illegal maneuver, if you would be placed in an unsafe situation, or if you would be directed into an area that you consider unsafe. The driver is ultimately responsible for the safe operation of the vehicle and therefore, must evaluate whether it is safe to follow the suggested directions.

# Appendices

---

**Potential Map Inaccuracy:** Maps used by this system may be inaccurate because of changes in roads, traffic controls or driving conditions. Always use good judgment and common sense when following the suggested routes.

**Emergency Services:** Do not rely on any navigation features included in the system to route you to emergency services. Ask local authorities or an emergency services operator for these locations. Not all emergency services such as police, fire stations, hospitals and clinics are likely to be contained in the map database for such navigation features.

## **Telenav Software End User License Agreement**

Please read these terms and conditions carefully before you use the Telenav Software. Your use of the Telenav Software indicates that you accept these terms and conditions. If you do not accept these terms and conditions, do not break the seal of the package, launch, or otherwise use the Telenav Software.

These terms and conditions represent the agreement ("Agreement") between you and Telenav, Inc. ("Telenav") with respect to the Telenav Software (including upgrades, modifications, or additions thereto) (collectively "Telenav Software"). All references herein to "you" and "your" means you, your employees, agents, and contractors, and any other entity on whose behalf you accept these terms and conditions, all of whom shall also be bound by this Agreement. Additionally, all of your account information, as well as other payment and personal information provided by you to Telenav (directly or through the use of the Telenav Software, is subject to Telenav's privacy policy located at <http://www.telenav.com>.

Telenav may revise this Agreement and the privacy policy at any time, with or without notice to you. You agree to visit <http://www.telenav.com> from time to time to review the then current version of this Agreement and of the privacy policy.

## **1. Safe and Lawful Use**

You acknowledge that devoting attention to the Telenav Software may pose a risk of injury or death to you and others in situations that otherwise require your undivided attention, and you therefore agree to comply with the following when using the Telenav Software: (a) observe all traffic laws and otherwise drive safely; (b) use your own personal judgment while driving. If you feel that a route suggested by the Telenav Software instructs you to perform an unsafe or illegal maneuver, places you in an unsafe situation, or directs you into an area that you consider to be unsafe, do not follow such instructions; (c) do not input destinations, or otherwise manipulate the Telenav Software, unless your vehicle is stationary and parked; (d) do not use the Telenav Software for any illegal, unauthorized, unintended, unsafe, hazardous, or unlawful purposes, or in any manner inconsistent with this Agreement; (e) arrange all GPS and wireless devices and cables necessary for use of the Telenav Software in a secure manner in your vehicle so that they will not interfere with your driving and will not prevent the operation of any safety device (such as an airbag).

You agree to indemnify and hold Telenav harmless against all claims resulting from any dangerous or otherwise inappropriate use of the Telenav Software in any moving vehicle, including as a result of your failure to comply with the directions above.

# Appendices

---

## 2. Account Information

You agree: (a) when registering the Telenav Software, to provide Telenav with true, accurate, current, and complete information about yourself, and (b) to inform Telenav promptly of any changes to such information, and to keep it true, accurate, current and complete.

## 3. Software License

Subject to your compliance with the terms of this Agreement, Telenav hereby grants to you a personal, non-exclusive, non-transferable license (except as expressly permitted below in connection with your permanent transfer of the Telenav Software license), without the right to sublicense, to use the Telenav Software (in object code form only) in order to access and use the Telenav Software. This license shall terminate upon any termination or expiration of this Agreement. You agree that you will use the Telenav Software only for your personal business or leisure purposes, and not to provide commercial navigation services to other parties.

### 3.1 License Limitations

You agree not to do any of the following: (a) reverse engineer, decompile, disassemble, translate, modify, alter or otherwise change the Telenav Software or any part thereof; (b) attempt to derive the source code, audio library or structure of the Telenav Software without the prior express written consent of Telenav; (c) remove from the Telenav Software, or alter, any of Telenav's or its suppliers' trademarks, trade names, logos, patent or copyright notices, or other notices or markings; (d) distribute, sublicense or otherwise transfer the Telenav Software to others, except as part of your permanent transfer of the Telenav Software; or (e) use the Telenav Software in any manner that (i) infringes the intellectual property

or proprietary rights, rights of publicity or privacy or other rights of any party, (ii) violates any law, statute, ordinance or regulation, including but not limited to laws and regulations related to spamming, privacy, consumer and child protection, obscenity or defamation, or (iii) is harmful, threatening, abusive, harassing, tortuous, defamatory, vulgar, obscene, libelous, or otherwise objectionable; and (f) lease, rent out, or otherwise permit unauthorized access by third parties to the Telenav Software without advanced written permission of Telenav.

## 4. Disclaimers

To the fullest extent permissible pursuant to applicable law, in no event will Telenav, its licensors and suppliers, or agents or employees of any of the foregoing, be liable for any decision made or action taken by you or anyone else in reliance on the information provided by the Telenav Software. Telenav also does not warrant the accuracy of the map or other data used for the Telenav Software. Such data may not always reflect reality due to, among other things, road closures, construction, weather, new roads and other changing conditions. You are responsible for the entire risk arising out of your use of the Telenav Software. For example but without limitation, you agree not to rely on the Telenav Software for critical navigation in areas where the well-being or survival of you or others is dependent on the accuracy of navigation, as the maps or functionality of the Telenav Software are not intended to support such high risk applications, especially in more remote geographical areas.

TELENAV EXPRESSLY DISCLAIMS AND EXCLUDES ALL WARRANTIES IN CONNECTION WITH THE TELENNAV SOFTWARE, WHETHER STATUTORY, EXPRESS OR IMPLIED, INCLUDING ALL WARRANTIES WHICH MAY ARISE FROM

# Appendices

---

COURSE OF DEALING, CUSTOM OR TRADE AND INCLUDING, BUT NOT LIMITED TO, THE IMPLIED WARRANTIES OF MERCHANTABILITY, FITNESS FOR A PARTICULAR PURPOSE AND NON-INFRINGEMENT OF THIRD PARTY RIGHTS WITH RESPECT TO THE TELENAV SOFTWARE. Certain jurisdictions do not permit the disclaimer of certain warranties, so this limitation may not apply to you.

## **5. Limitation of Liability**

TO THE EXTENT PERMITTED UNDER APPLICABLE LAW, UNDER NO CIRCUMSTANCES SHALL TELENAV OR ITS LICENSORS AND SUPPLIERS BE LIABLE TO YOU OR TO ANY THIRD PARTY FOR ANY INDIRECT, INCIDENTAL, CONSEQUENTIAL, SPECIAL OR EXEMPLARY DAMAGES (INCLUDING IN EACH CASE, BUT NOT LIMITED TO, DAMAGES FOR THE INABILITY TO USE THE EQUIPMENT OR ACCESS DATA, LOSS OF DATA, LOSS OF BUSINESS, LOSS OF PROFITS, BUSINESS INTERRUPTION OR THE LIKE) ARISING OUT OF THE USE OF OR INABILITY TO USE THE TELENAV SOFTWARE, EVEN IF TELENAV HAS BEEN ADVISED OF THE POSSIBILITY OF SUCH DAMAGES.

NOTWITHSTANDING ANY DAMAGES THAT YOU MIGHT INCUR FOR ANY REASON WHATSOEVER (INCLUDING, WITHOUT LIMITATION, ALL DAMAGES REFERENCED HEREIN AND ALL DIRECT OR GENERAL DAMAGES IN CONTRACT, TORT (INCLUDING NEGLIGENCE) OR OTHERWISE), THE ENTIRE LIABILITY OF TELENAV AND OF ALL OF TELENAV'S SUPPLIERS SHALL BE LIMITED TO THE AMOUNT ACTUALLY PAID BY YOU FOR THE TELENAV SOFTWARE. SOME

STATES AND/OR JURISDICTIONS DO NOT ALLOW THE EXCLUSION OR LIMITATION OF INCIDENTAL OR CONSEQUENTIAL DAMAGES, SO THE ABOVE LIMITATIONS OR EXCLUSIONS MAY NOT APPLY TO YOU.

## **6. Arbitration and Governing Law**

You agree that any dispute, claim or controversy arising out of or relating to this Agreement or the Telenav Software shall be settled by independent arbitration involving a neutral arbitrator and administered by the American Arbitration Association in the County of Santa Clara, California. The arbitrator shall apply the Commercial Arbitration Rules of the American Arbitration Association, and the judgment upon the award rendered by the arbitrator may be entered by any court having jurisdiction. Note that there is no judge or jury in an arbitration proceeding and the decision of the arbitrator shall be binding upon both parties. You expressly agree to waive your right to a jury trial.

This Agreement and performance hereunder will be governed by and construed in accordance with the laws of the State of California, without giving effect to its conflict of laws provisions. To the extent judicial action is necessary in connection with the binding arbitration, both Telenav and you agree to submit to the exclusive jurisdiction of the courts of the County of Santa Clara, California. The United Nations Convention on Contracts for the International Sale of Goods shall not apply.

## **7. Assignment**

You may not resell, assign, or transfer this Agreement or any of your rights or obligations, except in totality, in connection with your permanent transfer of the Telenav Software, and expressly conditioned upon the new user of the Telenav Software agreeing to be bound by

# Appendices

---

the terms and conditions of this Agreement. Any such sale, assignment or transfer that is not expressly permitted under this paragraph will result in immediate termination of this Agreement, without liability to Telenav, in which case you and all other parties shall immediately cease all use of the Telenav Software. Notwithstanding the foregoing, Telenav may assign this Agreement to any other party at any time without notice, provided the assignee remains bound by this Agreement.

## **8. Miscellaneous**

### **8.1**

This Agreement constitutes the entire agreement between Telenav and you with respect to the subject matter hereof.

### **8.2**

Except for the limited licenses expressly granted in this Agreement, Telenav retains all right, title and interest in and to the Telenav Software, including without limitation all related intellectual property rights. No licenses or other rights which are not expressly granted in this Agreement are intended to, or shall be, granted or conferred by implication, statute, inducement, estoppel or otherwise, and Telenav and its suppliers and licensors hereby reserve all of their respective rights other than the licenses explicitly granted in this Agreement.

### **8.3**

By using the Telenav Software, you consent to receive from Telenav all communications, including notices, agreements, legally required disclosures or other information in connection with the Telenav Software (collectively, "Notices") electronically. Telenav may provide such

Notices by posting them on Telenav's Website or by downloading such Notices to your wireless device. If you desire to withdraw your consent to receive Notices electronically, you must discontinue your use of the Telenav Software.

### **8.4**

Telenav's or your failure to require performance of any provision shall not affect that party's right to require performance at any time thereafter, nor shall a waiver of any breach or default of this Agreement constitute a waiver of any subsequent breach or default or a waiver of the provision itself.

### **8.5**

If any provision herein is held unenforceable, then such provision will be modified to reflect the intention of the parties, and the remaining provisions of this Agreement will remain in full force and effect.

### **8.6**

The headings in this Agreement are for convenience of reference only, will not be deemed to be a part of this Agreement, and will not be referred to in connection with the construction or interpretation of this Agreement. As used in this Agreement, the words "include" and "including," and variations thereof, will not be deemed to be terms of limitation, but rather will be deemed to be followed by the words "without limitation."

## **9. Other Vendors Terms and Conditions**

The Telenav Software utilizes map and other data licensed to Telenav by third party vendors for the benefit of you and other end users. This Agreement includes end-user terms applicable to these companies (included at the end of this

# Appendices

---

Agreement), and thus your use of the Telenav Software is also subject to such terms. You agree to comply with the following additional terms and conditions, which are applicable to Telenav's third party vendor licensors:

## **9.1 End User Terms Required by HERE North America, LLC**

The data ("Data") is provided for your personal, internal use only and not for resale. It is protected by copyright, and is subject to the following terms and conditions which are agreed to by you, on the one hand, and Telenav ("Telenav") and its licensors (including their licensors and suppliers) on the other hand.

© 2013 HERE. All rights reserved.

The Data for areas of Canada includes information taken with permission from Canadian authorities, including: © Her Majesty the Queen in Right of Canada, © Queen's Printer for Ontario, © Canada Post Corporation, GeoBase®, © Department of Natural Resources Canada.

HERE holds a non-exclusive license from the United States Postal Service® to publish and sell ZIP+4® information.

©United States Postal Service® 2014. Prices are not established, controlled or approved by the United States Postal Service®. The following trademarks and registrations are owned by the USPS: United States Postal Service, USPS, and ZIP+4.

The Data for Mexico includes certain data from Instituto Nacional de Estadística y Geografía.

## **TERMS AND CONDITIONS**

## **9.2 End User Terms Required by NAV2 (Shanghai) Co., Ltd**

The data ("Data") is provided for your personal, internal use only and not for resale. It is protected by copyright, and is subject to the following terms and conditions which are agreed to by you, on the one hand, and NAV2 (Shanghai) Co., Ltd ("NAV2") and its licensors (including their licensors and suppliers) on the other hand.

© 20xx. All rights reserved.

### ***Permitted Use.***

You agree to use this Data together with the Telenav Software solely for the internal business and personal purposes for which you were licensed, and not for service bureau, time-sharing or other similar purposes. Accordingly, but subject to the restrictions set forth in the following paragraphs, you agree not to otherwise reproduce, copy, modify, decompile, disassemble, create any derivative works of, or reverse engineer any portion of this Data, and may not transfer or distribute it in any form, for any purpose, except to the extent permitted by mandatory laws.

### ***Restrictions.***

Except where you have been specifically licensed to do so by Telenav, and without limiting the preceding paragraph, you may not use this Data (a) with any products, systems, or applications installed or otherwise connected to or in communication with vehicles, capable of vehicle navigation, positioning, dispatch, real time route guidance, fleet management or similar applications; or (b) with or in communication with any

# Appendices

---

positioning devices or any mobile or wireless-connected electronic or computer devices, including without limitation cellular phones, palmtop and handheld computers, pagers, and personal digital assistants or PDAs.

## **Warning.**

The Data may contain inaccurate or incomplete information due to the passage of time, changing circumstances, sources used and the nature of collecting comprehensive geographic data, any of which may lead to incorrect results.

## **No Warranty.**

This Data is provided to you "as is," and you agree to use it at your own risk. Telenav and its licensors (and their licensors and suppliers) make no guarantees, representations or warranties of any kind, express or implied, arising by law or otherwise, including but not limited to, content, quality, accuracy, completeness, effectiveness, reliability, fitness for a particular purpose, usefulness, use or results to be obtained from this Data, or that the Data or server will be uninterrupted or error-free.

## **Disclaimer of Warranty:**

TELENAV AND ITS LICENSORS (INCLUDING THEIR LICENSORS AND SUPPLIERS) DISCLAIM ANY WARRANTIES, EXPRESS OR IMPLIED, OF QUALITY, PERFORMANCE, MERCHANTABILITY, FITNESS FOR A PARTICULAR PURPOSE OR NON-INFRINGEMENT. Some States, Territories and Countries do not allow certain warranty exclusions, so to that extent the above exclusion may not apply to you.

## **Disclaimer of Liability:**

TELENAV AND ITS LICENSORS (INCLUDING THEIR LICENSORS AND SUPPLIERS) SHALL NOT BE LIABLE TO YOU: IN RESPECT OF ANY CLAIM, DEMAND OR ACTION, IRRESPECTIVE OF THE NATURE OF THE CAUSE OF THE CLAIM, DEMAND OR ACTION ALLEGING ANY LOSS, INJURY OR DAMAGES, DIRECT OR INDIRECT, WHICH MAY RESULT FROM THE USE OR POSSESSION OF THE INFORMATION; OR FOR ANY LOSS OF PROFIT, REVENUE, CONTRACTS OR SAVINGS, OR ANY OTHER DIRECT, INDIRECT, INCIDENTAL, SPECIAL OR CONSEQUENTIAL DAMAGES ARISING OUT OF YOUR USE OF OR INABILITY TO USE THIS INFORMATION, ANY DEFECT IN THE INFORMATION, OR THE BREACH OF THESE TERMS OR CONDITIONS, WHETHER IN AN ACTION IN CONTRACT OR TORT OR BASED ON A WARRANTY, EVEN IF TELENAV OR ITS LICENSORS HAVE BEEN ADVISED OF THE POSSIBILITY OF SUCH DAMAGES. Some States, Territories and Countries do not allow certain liability exclusions or damages limitations, so to that extent the above may not apply to you.

## **Export Control.**

You shall not export from anywhere any part of the Data or any direct product thereof except in compliance with, and with all licenses and approvals required under, applicable export laws, rules and regulations, including but not limited to the laws, rules and regulations administered by the Office of Foreign Assets Control of the U.S. Department of Commerce and the Bureau of Industry and Security of the U.S. Department of Commerce. To the extent

# Appendices

that any such export laws, rules or regulations prohibit HERE from complying with any of its obligations hereunder to deliver or distribute Data, such failure shall be excused and shall not constitute a breach of this Agreement.

## **Entire Agreement.**

These terms and conditions constitute the entire agreement between Telenav (and its licensors, including their licensors and suppliers) and you pertaining to the subject matter hereof, and supersedes in their entirety any and all written or oral agreements previously existing between us with respect to such subject matter.

## **Governing Law.**

The above terms and conditions shall be governed by the laws of the State of Illinois [insert "Netherlands" where European HERE Data is used], without giving effect to (i) its conflict of laws provisions, or (ii) the United Nations Convention for Contracts for the International Sale of Goods, which is explicitly excluded. You agree to submit to the jurisdiction of the State of Illinois [insert "The Netherlands" where European HERE Data is used] for any and all disputes, claims and actions arising from or in connection with the Data provided to you hereunder.

## **Government End Users.**

If the Data is being acquired by or on behalf of the United States government or any other entity seeking or applying rights similar to those customarily claimed by the United States government, this Data is a "commercial item" as that term is defined at 48 C.F.R. ("FAR") 2.101, is licensed in accordance with these End-User Terms, and each copy of Data delivered or otherwise furnished shall be marked and embedded as appropriate with the following "Notice of Use," and shall be treated in accordance with such Notice:

### **NOTICE OF USE**

CONTRACTOR (MANUFACTURER/  
SUPPLIER) NAME: HERE

CONTRACTOR (MANUFACTURER/  
SUPPLIER) ADDRESS: c/o Nokia, 425  
West Randolph Street, Chicago, Illinois  
60606

This Data is a commercial item as defined in FAR 2.101 and is subject to these End-User Terms under which this Data was provided.

© 1987 – 2014 HERE – All rights reserved.

If the Contracting Officer, federal government agency, or any federal official refuses to use the legend provided herein, the Contracting Officer, federal government agency, or any federal official must notify HERE prior to seeking additional or alternative rights in the Data.

## I. US/Canada Territory

A. United States Data. The End-User Terms for any Application containing Data for the United States shall contain the following notices:

"HERE holds a non-exclusive license from the United States Postal Service® to publish and sell ZIP+4® information."

"©United States Postal Service® 20XX. Prices are not established, controlled or approved by the United States Postal Service®. The following trademarks and registrations are owned by the USPS: United States Postal Service, USPS, and ZIP+4."



## Appendices

---

B. Canada Data. The following provisions apply to the Data for Canada, which may include or reflect data from third party licensors (“Third Party Data”), including Her Majesty the Queen in Right of Canada (“Her Majesty”), Canada Post Corporation (“Canada Post”) and the Department of Natural Resources of Canada (“NRCan”):

1. Disclaimer and Limitation: Client agrees that its use of the Third Party Data is subject to the following provisions:

a. Disclaimer: The Third Party Data is licensed on an “as is” basis. The licensors of such data, including Her Majesty, Canada Post and NRCan, make no guarantees, representations or warranties respecting such data, either express or implied, arising by law or otherwise, including but not limited to, effectiveness, completeness, accuracy or fitness for a particular purpose.

b. Limitation on Liability: The Third Party Data licensors, including Her Majesty, Canada Post and NRCan, shall not be liable: (i) in respect of any claim, demand or action, irrespective of the nature of the cause of the claim, demand or action alleging any loss, injury or damages, direct or indirect, which may result from the use or possession of such Data; or (ii) in any way for loss of revenues or contracts, or any other consequential loss of any kind resulting from any defect in the Data.

2. Copyright Notice: In connection with each copy of all or any portion of the Data for the Territory of Canada, Client shall affix in a conspicuous manner the following copyright notice on at least one of: (i) the label for the storage media of the copy; (ii) the packaging for the copy; or (iii) other materials packaged with the copy, such as user manuals or end user license agreements: “This data includes information taken with permission from Canadian authorities, including © Her Majesty the Queen in Right of Canada, © Queen’s Printer for Ontario, © Canada Post Corporation, GeoBase®, © The Department of Natural Resources Canada. All rights reserved.”

3. End-User Terms: Except as otherwise agreed by the parties, in connection with the provision of any portion of the Data for the Territory of Canada to End-Users as may be authorized under the Agreement, Client shall provide such End-Users, in a reasonably conspicuous manner, with terms (set forth with other end user terms required to be provided under the Agreement, or as otherwise may be provided, by Client) which shall include the following provisions on behalf of the Third Party Data licensors, including Her Majesty, Canada Post and NRCan:

The Data may include or reflect data of licensors, including Her Majesty the Queen in the Right of Canada (“Her Majesty”), Canada Post Corporation (“Canada Post”) and the Department of Natural Resources Canada (“NRCan”). Such data is licensed on an “as is” basis. The licensors, including Her Majesty, Canada Post and NRCan, make no guarantees, representations or warranties respecting such data,

# Appendices

---

either express or implied, arising by law or otherwise, including but not limited to, effectiveness, completeness, accuracy or fitness for a particular purpose. The licensors, including Her Majesty, Canada Post and NRCan, shall not be liable in respect of any claim, demand or action, irrespective of the nature of the cause of the claim, demand or action alleging any loss, injury or damages, direct or indirect, which may result from the use or possession of the data or the Data. The licensors, including Her Majesty, Canada Post and NRCan, shall not be liable in any way for loss of revenues or contracts, or any other consequential loss of any kind resulting from any defect in the data or the Data.

End User shall indemnify and save harmless the licensors, including Her Majesty, Canada Post and NRCan, and their officers, employees and agents from and against any claim, demand or action, irrespective of the nature of the cause of the claim, demand or action, alleging loss, costs, expenses, damages or injuries (including injuries resulting in death) arising out of the use or possession of the data or the Data.

4. Additional Provisions: The terms contained in this Section are in addition to all of the rights and obligations of the parties under the Agreement. To the extent that any of the provisions of this Section are inconsistent with, or conflict with, any other provisions of the Agreement, the provisions of this Section shall prevail.

II. Mexico. The following provision applies to the Data for Mexico, which includes certain data from the Instituto Nacional de Estadística y Geografía (“INEGI”):

A. Any and all copies of the Data and/or packaging containing Data for Mexico shall contain the following notice: “Fuente: INEGI (Instituto Nacional de Estadística y Geografía)”

III. Latin America Territory

A. Third Party Notices. Any and all copies of the Data and/or packaging relating thereto shall include the respective Third Party Notices set forth below and used as described below corresponding to the Territory (or portion thereof) included in such copy:

Territory Notice

Ecuador “INSTITUTO GEOGRAFICO MILITAR DEL ECUADOR AUTORIZACION N° IGM-2011-01- PCO-01 DEL 25 DE ENERO DE 2011”  
“source: © IGN 2009 - BD TOPO ®”

Guadeloupe,  
French  
Guiana  
and

Martinique “Fuente: INEGI (Instituto Nacional de Estadística y Geografía)”  
Mexico

IV. Middle East Territory

# Appendices

---

A. Third Party Notices. Any and all copies of the Data and/or packaging relating thereto shall include the respective Third Party Notices set forth below and used as described below corresponding to the Territory (or portion thereof) included in such copy:

Country Notice

Jordan “© Royal Jordanian Geographic Centre”. The foregoing notice requirement for Jordan Data is a material term of the Agreement. If Client or any of its permitted sublicensees (if any) fail to meet such requirement, HERE shall have the right to terminate Client’s license with respect to the Jordan Data.

B. Jordan Data. Client and its permitted sublicensees (if any) are restricted from licensing and/or otherwise distributing HERE’s database for the country of Jordan (“Jordan Data”) for use in Enterprise Applications to (i) non-Jordanian entities for use of the Jordan Data solely in Jordan or (ii) Jordan-based customers. In addition, Client, its permitted sublicensees (if any) and End-Users are restricted from using the Jordan Data in Enterprise Applications if such party is (i) a non-Jordanian entity using the Jordan Data solely in Jordan or (ii) a Jordan-based customer. For purposes of the foregoing, “Enterprise Applications” shall mean Geomarketing applications, GIS applications, mobile business asset management applications, call center applications, telematics applications, public organization Internet applications or for providing geocoding services.

## V. Europe Territory

### A. Use of Certain Traffic Codes in Europe

1. General Restrictions Applicable to Traffic Codes. Client acknowledges and agrees that in certain countries of the Europe Territory, Client will need to obtain rights directly from third party RDS-TMC code providers to receive and use the Traffic Codes in the Data and to deliver to End-Users Transactions in any way derived from or based on such Traffic Codes. For such countries, HERE shall deliver the Data incorporating Traffic Codes to Client only after receiving certification from Client of its having obtained such rights.

2. Display of Third Party Rights Legends for Belgium. Client shall, for each Transaction that uses Traffic Codes for Belgium, provide the following notice to the End-User: “Traffic Codes for Belgium are provided by the Ministerie van de Vlaamse Gemeenschap and the Ministère de l’Équipement et des Transports.”

B. Paper Maps. With respect to any license granted to Client relating to making, selling or distributing paper maps (i.e., a map fixed on a paper or paper-like medium): (a) such license with respect to Data for the Territory of Great Britain is conditioned on Client’s entering into and complying with a separate written agreement with the Ordnance Survey (“OS”) to create and sell paper maps, Client’s paying to the OS any and all applicable paper map royalties, and Client’s complying with the OS copyright notice requirements; (b) such license for selling or otherwise distributing for charge with respect to Data for the Territory of Czech Republic

## Appendices

is conditioned on Client's obtaining prior written consent from Kartografie a.s.; (c) such license for selling or distributing with respect to Data for the Territory of Switzerland is conditioned on Client's obtaining a permit from Bundesamt für Landestopografie of Switzerland; (d) Client is restricted from using Data for the Territory of France to create paper maps with a scale between 1:5,000 and 1:250,000; and (e) Client is restricted from using any Data to create, sell or distribute paper maps that are the same or substantially similar, in terms of data content and specific use of color, symbols and scale, to paper maps published by the European national mapping agencies, including without limitation, Landervermessungämter of Germany, Topografische Dienst of the Netherlands, Nationaal Geografisch Instituut of Belgium, Bundesamt für Landestopografie of Switzerland, Bundesamt für Eich-und Vermessungswesen of Austria, and the National Land Survey of Sweden.

C. OS Enforcement. Without limiting Section IV(B) above, with respect to Data for the Territory of Great Britain, Client acknowledges and agrees that the Ordnance Survey ("OS") may bring a direct action against Client to enforce compliance with the OS copyright notice (see Section IV(D) below) and paper map requirements (see Section IV(B) above) contained in this Agreement.

D. Third Party Notices. Any and all copies of the Data and/or packaging relating thereto shall include the respective Third Party Notices set forth below and used as described below corresponding to the Territory (or portion thereof) included in such copy:

Country(ies) Notice

Austria	"© Bundesamt für Eich- und Vermessungswesen"
Croatia Cyprus, Estonia, Latvia, Lithuania, Moldova, Poland, Slovenia and/or Ukraine	"© EuroGeographics"
France	"source: © IGN 2009 – BD TOPO ®"
Germany	"Die Grundlegendaten wurden mit Genehmigung der zuständigen Behörden entnommen"
Great Britain	"Contains Ordnance Survey data © Crown copyright and database right 2010 Contains Royal Mail data © Royal Mail copyright and database right 2010"
Greece	"Copyright Geomatics Ltd."
Hungary	"Copyright © 2003; Top-Map Ltd."
Italy	"La Banca Dati Italiana è stata prodotta usando quale riferimento anche cartografia numerica ed al tratto prodotta e fornita dalla Regione Toscana."
Norway	"Copyright © 2000; Norwegian Mapping Authority"
Portugal	"Source: IgeoE – Portugal"
Spain	"Información geográfica propiedad del CNIG"

# Appendices

---

Sweden “Based upon electronic data  
© National Land Survey  
Sweden.”

Switzer- “Topografische Grundlage: ©  
land Bundesamt für Landestopo-  
graphie.

E. Respective Country Distribution. Client acknowledges that HERE has not received approvals to distribute map data for the following countries in such respective countries: Albania, Belarus, Kyrgyzstan, Moldova and Uzbekistan. HERE may update such list from time to time. The license rights granted to Client under this TL with respect to the Data for such countries are contingent upon Client’s compliance with all applicable laws and regulations, including, without limitation, any required licenses or approvals to distribute the Application incorporating such Data in such respective countries.

## VI. Australia Territory

A. Third Party Notices. Any and all copies of the Data and/or packaging relating thereto shall include the respective Third Party Notices set forth below and used as described below corresponding to the Territory (or portion thereof) included in such copy:

Copyright. Based on data provided under license from PSMA Australia Limited ([www.pasma.com.au](http://www.pasma.com.au)).

Product incorporates data which is © 20XX Telstra Corporation Limited, GM Holden Limited, Intelomatics Australia Pty Ltd and Continental Pty Ltd.

B. Third Party Notices for Australia. In addition to the foregoing, the End-User Terms for any Application containing RDS-TMC Traffic Codes for Australia shall contain the following notice: “Product incorporates traffic location codes which is © 20XX Telstra Corporation Limited and its licensors.”

## VII. China Territory

### *Personal Use Only*

You agree to use this Data together with [insert name of Client Application] for the solely personal, non-commercial purposes for which you were licensed, and not for service bureau, time-sharing or other similar purposes. Accordingly, but subject to the restrictions set forth in the following paragraphs, you may copy this Data only as necessary for your personal use to (i) view it, and (ii) save it, provided that you do not remove any copyright notices that appear and do not modify the Data in any way. You agree not to otherwise reproduce, copy, modify, decompile, disassemble or reverse engineer any portion of this Data, and may not transfer or distribute it in any form, for any purpose, except to the extent permitted by mandatory laws.

### *Restrictions*

Except where you have been specifically licensed to do so by NAV2 , and without limiting the preceding paragraph, you may not (a) use this Data with any products, systems, or applications installed or otherwise connected to or in communication with vehicles, capable of vehicle navigation, positioning, dispatch, real time route guidance, fleet management or similar applications; or (b)

# Appendices

---

with or in communication with any positioning devices or any mobile or wireless-connected electronic or computer devices, including without limitation cellular phones, palmtop and handheld computers, pagers, and personal digital assistants or PDAs. You agree to cease using this Data if you fail to comply with these terms and conditions.

## **Limited Warranty**

NAV2 warrants that (a) the Data will perform substantially in accordance with the accompanying written materials for a period of ninety (90) days from the date of receipt, and (b) any support services provided by NAV2 shall be substantially as described in applicable written materials provided to you by NAV2, and NAV2's support engineers will make commercially reasonable efforts to solve any problem issues.

## **rigCustomer Remedies**

NAV2 and its suppliers' entire liability and your exclusive remedy shall be, at NAV2's sole discretion, either (a) return of the price paid, if any, or (b) repair or replacement of the Data that do not meet NAV2's Limited Warranty and that are returned to NAV2 with a copy of your receipt. This Limited Warranty is void if failure of the Data has resulted from accident, abuse, or misapplication. Any replacement Data will be warranted for the remainder of the original warranty period or thirty (30) days, whichever is longer. Neither these remedies nor any product support services offered by NAV2 are available without proof of purchase from an authorized international source.

## **No Other Warranty:**

EXCEPT FOR THE LIMITED WARRANTY SET FORTH ABOVE AND TO THE EXTENT PERMITTED BY APPLICABLE LAW, NAV2 AND ITS LICENSORS (INCLUDING THEIR LICENSORS AND SUPPLIERS) DISCLAIM ANY WARRANTIES, EXPRESS OR IMPLIED, OF QUALITY, PERFORMANCE, MERCHANTABILITY, FITNESS FOR A PARTICULAR PURPOSE, OWNERSHIP OR NON-INFRINGEMENT. Certain warranty exclusions may not be permitted under applicable law, so to that extent the above exclusion may not apply to you.

## **Limited Liability:**

TO THE EXTENT PERMITTED BY APPLICABLE LAW, NAV2 AND ITS LICENSORS (INCLUDING THEIR LICENSORS AND SUPPLIERS) SHALL NOT BE LIABLE TO YOU: IN RESPECT OF ANY CLAIM, DEMAND OR ACTION, IRRESPECTIVE OF THE NATURE OF THE CAUSE OF THE CLAIM, DEMAND OR ACTION ALLEGING ANY LOSS, INJURY OR DAMAGES, DIRECT OR INDIRECT, WHICH MAY RESULT FROM THE USE OR POSSESSION OF THE INFORMATION; OR FOR ANY LOSS OF PROFIT, REVENUE, CONTRACTS OR SAVINGS, OR ANY OTHER DIRECT, INDIRECT, INCIDENTAL, SPECIAL OR CONSEQUENTIAL DAMAGES ARISING OUT OF YOUR USE OF OR INABILITY TO USE THIS INFORMATION, ANY DEFECT IN THE INFORMATION, OR THE BREACH OF THESE TERMS OR CONDITIONS, WHETHER IN AN ACTION IN CONTRACT OR TORT OR BASED ON A WARRANTY, EVEN IF NAV2 OR ITS LICENSORS HAVE BEEN ADVISED OF THE POSSIBILITY OF SUCH DAMAGES. UNDER NO CIRCUMSTANCES SHALL NAV2'S OR ITS SUPPLIERS' LIABILITY HEREUNDER EXCEED THE PRICE PAID. Certain liability exclusions may not be permitted under applicable law, so to that extent the above exclusion may not apply to you.

# Appendices

---

## **Export Control**

You agree not to export to anywhere any part of the Data provided to you or any direct product thereof except in compliance with, and with all licenses and approvals required under, applicable export laws, rules and regulations.

## **IP Protection**

The Data are owned by NAV2 or its suppliers and are protected by applicable copyright and other intellectual property law and treaties. The Data are provided solely on the basis of a license to use, not sale.

## **Entire Agreement**

These terms and conditions constitute the entire agreement between NAV2 (and its licensors, including their licensors and suppliers) and you pertaining to the subject matter hereof, and supersedes in their entirety any and all written or oral agreements previously existing between us with respect to such subject matter.

## **Governing Law.**

The above terms and conditions shall be governed by the laws of the People's Republic of China, without giving effect to (i) its conflict of laws provisions, or (ii) the United Nations Convention for Contracts for the International Sale of Goods, which is explicitly excluded. Any dispute arising from or in connection with the Data provided to you hereunder shall be submitted to the Shanghai International Economic and Trade Arbitration Commission for arbitration.

## **Gracenote® Copyright**

CD and music-related data from Gracenote, Inc., copyright© 2000-2007 Gracenote. Gracenote Software, copyright © 2000-2007 Gracenote. This product and service may practice one or more of the following U.S. Patents #5,987,525, #6,061,680, #6,154,773, #6,161,132, #6,230,192, #6,230,207, #6,240,459, #6,330,593 and other patents issued or pending. Some services supplied under license from Open Globe, Inc. for U.S. Patent: #6,304,523.

Gracenote and CDDB are registered trademarks of Gracenote. The Gracenote logo and logotype, and the "Powered by Gracenote™" logo are trademarks of Gracenote.

## **Gracenote® End User License Agreement (EULA)**

This device contains software from Gracenote, Inc. of 2000 Powell Street Emeryville, California 94608 ("Gracenote").

The software from Gracenote (the "Gracenote Software") enables this device to do disc and music file identification and obtain music-related information, including name, artist, track, and title information ("Gracenote Data") from online servers ("Gracenote Servers"), and to perform other functions. You may use Gracenote Data only by means of the intended End User functions of this device.

This device may contain content belonging to Gracenote's providers. If so, all of the restrictions set forth herein with respect to Gracenote Data shall also apply to such content and such content providers shall be entitled to all of the benefits and protections set forth herein that are available to Gracenote.

## Appendices

---

You agree that you will use the content from Gracenote ("Gracenote Content"), Gracenote Data, the Gracenote Software, and Gracenote Servers for your own personal, non-commercial use only. You agree not to assign, copy, transfer or transmit the Gracenote Content, Gracenote Software or any Gracenote Data (except in a Tag associated with a music file) to any third party. YOU AGREE NOT TO USE OR EXPLOIT GRACENOTE CONTENT, GRACENOTE DATA, THE GRACENOTE SOFTWARE, OR GRACENOTE SERVERS, EXCEPT AS EXPRESSLY PERMITTED HEREIN.

You agree that your non-exclusive licenses to use the Gracenote Content, Gracenote Data, the Gracenote Software, and Gracenote Servers will terminate if you violate these restrictions. If your licenses terminate, you agree to cease any and all use of the Gracenote Content, Gracenote Data, the Gracenote Software, and Gracenote Servers. Gracenote, respectively, reserve all rights in Gracenote Data, the Gracenote Software, and the Gracenote Servers and Gracenote Content, including all ownership rights. Under no circumstances will either Gracenote become liable for any payment to you for any information that you provide, including any copyrighted material or music file information. You agree that Gracenote may enforce its respective rights, collectively or separately, under this agreement against you, directly in each company's own name.

Gracenote uses a unique identifier to track queries for statistical purposes. The purpose of a randomly assigned numeric identifier is to allow Gracenote to count queries without knowing anything about who you are. For more information, see the web page at [www.gracenote.com](http://www.gracenote.com) for the Gracenote Privacy Policy.

THE GRACENOTE SOFTWARE, EACH ITEM OF GRACENOTE DATA AND THE GRACENOTE CONTENT ARE LICENSED TO YOU "AS IS". NEITHER GRACENOTE MAKES ANY REPRESENTATIONS OR WARRANTIES, EXPRESS OR IMPLIED, REGARDING THE ACCURACY OF ANY GRACENOTE DATA FROM THE GRACENOTE SERVERS OR GRACENOTE CONTENT. GRACENOTE COLLECTIVELY AND SEPARATELY RESERVE THE RIGHT TO DELETE DATA AND/OR CONTENT FROM THE COMPANIES' RESPECTIVE SERVERS OR, IN THE CASE OF GRACENOTE, CHANGE DATA CATEGORIES FOR ANY CAUSE THAT GRACENOTE DEEMS SUFFICIENT. NO WARRANTY IS MADE THAT EITHER GRACENOTE CONTENT OR THE GRACENOTE SOFTWARE OR GRACENOTE SERVERS ARE ERROR-FREE OR THAT THE FUNCTIONING OF THE GRACENOTE SOFTWARE OR GRACENOTE SERVERS WILL BE UNINTERRUPTED. GRACENOTE IS NOT OBLIGATED TO PROVIDE YOU WITH ANY ENHANCED OR ADDITIONAL DATA TYPES THAT GRACENOTE MAY CHOOSE TO PROVIDE IN THE FUTURE AND IS FREE TO DISCONTINUE ITS ONLINE SERVICES AT ANY TIME. GRACENOTE DISCLAIMS ALL WARRANTIES EXPRESS OR IMPLIED, INCLUDING, BUT NOT LIMITED TO, IMPLIED WARRANTIES OF MERCHANTABILITY, FITNESS FOR A PARTICULAR PURPOSE, TITLE, AND NON-INFRINGEMENT. NEITHER GRACENOTE WARRANTS THE RESULTS THAT WILL BE OBTAINED BY YOUR USE OF THE GRACENOTE SOFTWARE OR ANY GRACENOTE SERVER. IN NO CASE WILL GRACENOTE BE LIABLE FOR ANY CONSEQUENTIAL OR INCIDENTAL DAMAGES OR FOR ANY LOST PROFITS OR LOST REVENUES FOR ANY REASON WHATSOEVER.

© Gracenote 2007.



# Appendices

---

## **Vehicle with SYNC only United States and Mexico**

FCC ID: KMHSG1G1

IC: 1422A-SG1G1

### **Mexico**

Model: KMHSG1P1

NOM-121-SCT1-2009

The operation of this equipment is subject to the following two conditions: (1) This equipment or device may not cause harmful interference, and (2) this equipment or device must accept any interference, including interference that may cause undesired operation.

## **Vehicle with SYNC with Touchscreen/My Touch**

FCC ID: KMHSYNCG2

IC: 1422A-SYNCG2

This device complies with Part 15 of the FCC Rules and with RSS-210 of Industry Canada. Operation is subject to the following two conditions: (1) This device may not cause harmful interference, and (2) this device must accept any interference received, including interference that may cause undesired operation.

### **WARNING**



Changes or modifications not expressly approved by the party responsible for compliance could void the user's authority to operate the equipment. The term "IC" before the radio certification number only signifies that Industry Canada technical specifications were met.

---

The antenna used for this transmitter must not be co-located or operating in conjunction with any other antenna or transmitter.

# Extended Service Plan (ESP)

---

PROTECT YOURSELF FROM THE RISING COST OF VEHICLE REPAIRS WITH A FORD EXTENDED SERVICE PLAN.

## **SERVICE PLANS (U.S. Only)**

More than 32 million Ford owners have discovered the powerful protection of Ford Extended Service Plan. It is the extended service plan backed by Ford Motor Company, and provides peace of mind protection beyond the New Vehicle Limited Warranty coverage.

### **Ford ESP Can Quickly Pay for Itself**

One service bill – the cost of parts and labor – can easily exceed the price of your Ford Extended Service Plan. With Ford ESP you minimize your risk for unexpected repair bills and rising repair costs.

### **Up to 1,000+ Covered Vehicle Components**

There are four core Extended Service Plans with different levels of coverage. Ask your authorized dealer for details.

1. PremiumCARE - Our most comprehensive coverage. With over 1,000 covered components, this plan is so complete that we generally only discuss what's not covered.
2. ExtraCARE - Covers 113 components, and includes many high-tech items.
3. BaseCARE - Covers 84 components.
4. PowertrainCARE - Covers 29 critical components.

Ford Extended Service Plan is honored by all authorized Ford dealers in the U.S., Canada and Mexico. It is the extended service plan authorized and backed by Ford Motor Company.

That means you get:

- Reliable, quality service at any Ford or Lincoln dealership
- Repairs performed by factory trained technicians, using genuine parts

### **Rental Car Reimbursement**

#### ***1st day Rental Benefit***

You take advantage of replacement transportation if your vehicle is at your authorized dealer for same day covered repairs.

#### ***Extended Rental Benefits***

If your vehicle is kept overnight for covered repairs, you are eligible for rental car coverage, including bumper to bumper warranty repairs, and Field Service Actions.

### **Roadside Assistance**

Exclusive 24/7 roadside assistance, including:

- Towing, flat-tire change and battery jump starts
- Out of fuel and lock-out assistance.
- Travel expense reimbursement for lodging, meals and rental car.
- Destination assistance for taxi, shuttle, rental car coverage and emergency transportation.

### **Transferable Coverage**

If you sell your vehicle before your Ford Extended Service Plan coverage expires, you can transfer any remaining coverage to the new owner. Whenever you sell your vehicle, prospective buyers may have a higher degree of confidence that vehicle was properly maintained with Ford ESP, thereby improving resale value.

# Extended Service Plan (ESP)

---

## Avoid the Rising Cost of Properly Maintaining Your Vehicle!

Ford Extended Service Plan also offers a Premium Maintenance Plan that covers all scheduled maintenance, and selected wear items. The coverage is prepaid, so you never have to worry about affording your vehicle's maintenance. It covers regular checkups, routine inspections, preventive care and replacement of select items that require periodic attention for normal wear:

- Windshield wiper blades.
- Spark plugs.
- The clutch disc.
- Brake pads and linings.
- Shock absorbers.
- Struts.
- Engine Belts.
- Engine coolant hoses, clamps and o-rings.
- Diesel exhaust fluid replenishment.

## Interest Free Finance Options Available

Take advantage of our interest free installment payment plan. Just a 10% down payment will provide you with an affordable, no interest, no fee payment program allowing you all the security and benefits Ford ESP has to offer while paying over time. You are pre-approved with no credit checks, no hassles! To learn more, call our Ford ESP specialists at 800-367-3377.

Ford ESP  
P.O. Box 321067  
Detroit, MI 48232

## SERVICE PLANS (CANADA ONLY)

You can get more protection for your vehicle by purchasing a Ford Extended Service Plan. Ford Extended Service Plan is the only service contract backed by Ford Motor Company of Canada, Limited. Depending on the plan you purchase, Ford Extended Service Plan provides benefits such as:

- Rental reimbursement.
- Coverage for certain maintenance and wear items.
- Protection against repair costs after your New Vehicle Limited Warranty Coverage expires.
- Roadside Assistance benefits.

There are several Ford Extended Service Plans available in various time, distance and deductible combinations. Each plan is tailored to fit your own driving needs, including reimbursement for towing and rental. When you purchase Ford Extended Service Plan, you receive added peace-of-mind protection throughout Canada and the United States, provided by a network of participating authorized Ford Motor Company dealers.

**Note:** *Repairs performed outside of Canada and the United States are not eligible for Ford Extended Service Plan coverage.*

This information is subject to change. For more information, visit your local Ford of Canada dealer or [www.ford.ca](http://www.ford.ca) to find the Ford Extended Service Plan that is right for you.

# Scheduled Maintenance

---

## GENERAL MAINTENANCE INFORMATION

### Why Maintain Your Vehicle?

Carefully following the maintenance schedule helps protect against major repair expenses resulting from neglect or inadequate maintenance and may help to increase the value of your vehicle when you sell or trade it. Keep all receipts for completed maintenance with your vehicle.

We have established regular maintenance intervals for your vehicle based upon rigorous testing. It is important that you have your vehicle serviced at the proper times. These intervals serve two purposes; one is to maintain the reliability of your vehicle and the second is to keep your cost of owning your vehicle down.

It is your responsibility to have all scheduled maintenance performed and to make sure that the materials used meet the specifications identified in this owner's manual. See **Capacities and Specifications** (page 301).

Failure to perform scheduled maintenance invalidates warranty coverage on parts affected by the lack of maintenance.

### Why Maintain Your Vehicle at Your Dealership?

#### Factory-trained Technicians

Service technicians participate in extensive factory-sponsored certification training to help them become experts on the operation of your vehicle. Ask your dealership about the training and certification their technicians have received.

### Genuine Ford and Motorcraft Replacement Parts

Dealerships stock Ford, Motorcraft and Ford-authorized branded re-manufactured replacement parts. These parts meet or exceed our specifications. Parts installed at your dealership carry a nationwide 24-month or unlimited mile (kilometer) parts and labor limited warranty.

If you do not use Ford authorized parts they may not meet our specifications and depending on the part, it could affect emissions compliance.

### Convenience

Many dealerships have extended evening and Saturday hours to make your service visit more convenient and they offer one stop shopping. They can perform any services that are required on your vehicle, from general maintenance to collision repairs.

**Note:** *Not all dealers have extended hours or body shops. Please contact your dealer for details.*

### Protecting Your Investment

Maintenance is an investment that pays dividends in the form of improved reliability, durability and resale value. To maintain the proper performance of your vehicle and its emission control systems, make sure you have scheduled maintenance performed at the designated intervals.

Your vehicle is very sophisticated and built with multiple, complex, performance systems. Every manufacturer develops these systems using different specifications and performance features. That is why it is important to rely upon your dealership to properly diagnose and repair your vehicle.

# Scheduled Maintenance

Ford Motor Company has recommended maintenance intervals for various parts and component systems based upon engineering testing. Ford Motor Company relies upon this testing to determine the most appropriate mileage for replacement of oils and fluids to protect your vehicle at the lowest overall cost to you and recommends against maintenance schedules that deviate from the scheduled maintenance information.

We strongly recommend the use of only genuine Ford, Motorcraft or Ford-authorized re-manufactured replacement parts engineered for your vehicle.

## Additives and Chemicals

This owner's manual and the Ford Workshop Manual list the recommended additives and chemicals for your vehicle. We do not recommend using chemicals or additives not approved by us as part of your vehicle's normal maintenance. Please consult your warranty information.

## Oils, Fluids and Flushing

In many cases, fluid discoloration is a normal operating characteristic and, by itself, does not necessarily indicate a concern or that the fluid needs to be changed. However, a qualified expert, such as the factory-trained technicians at your dealership, should inspect discolored fluids that also show signs of overheating or foreign material contamination immediately.

Make sure to change your vehicle's oils and fluids at the specified intervals or in conjunction with a repair. Flushing is a viable way to change fluid for many vehicle sub-systems during scheduled maintenance. It is critical that systems are flushed only with new fluid that is the same as that required to fill and operate the system or using a Ford-approved flushing chemical.

## Owner Checks and Services

Make sure you perform the following basic maintenance checks and inspections every month or at six-month intervals.

<b>Check every month</b>
Engine oil level.
Function of all interior and exterior lights.
Tires (including spare) for wear and proper pressure.
Windshield washer fluid level.

<b>Check every six months</b>
Battery connections. Clean if necessary.
Body and door drain holes for obstructions. Clean if necessary.
Cooling system fluid level and coolant strength.
Door weatherstrips for wear. Lubricate if necessary.

# Scheduled Maintenance

<b>Check every six months</b>
Hinges, latches and outside locks for proper operation. Lubricate if necessary.
Parking brake for proper operation.
Safety belts and seat latches for wear and function.
Safety warning lamps (brake, ABS, airbag and safety belt) for operation.
Washer spray and wiper operation. Clean or replace blades as necessary.

## Multi-point Inspection

In order to keep your vehicle running right, it is important to have the systems on your vehicle checked regularly. This can help identify potential issues and prevent major problems. We recommend having the following multi-point inspection performed at every scheduled maintenance interval to help make sure your vehicle keeps running great.

<b>Multi-point inspection</b>	
Accessory drive belt(s)	Horn operation
Battery performance	Radiator, cooler, heater and A/C hoses
Engine and cabin air filter	Suspension component for leaks or damage
Exhaust system	Steering and linkage
Exterior lamps and hazard warning system operation	Tires (including spare) for wear and proper pressure**
Fluid levels*; fill if necessary	Windshield for cracks, chips or pits
For oil and fluid leaks	Washer spray and wiper operation

\* Brake, coolant recovery reservoir, automatic transmission, power steering and window washer.

\*\*If your vehicle is equipped with a temporary mobility kit, check the tire sealant expiration Use By date on the canister. Replace as needed.

# Scheduled Maintenance

Be sure to ask your dealership service advisor or technician about the multi-point vehicle inspection. It is a comprehensive way to perform a thorough inspection of

your vehicle. Your checklist gives you immediate feedback on the overall condition of your vehicle.

## NORMAL SCHEDULED MAINTENANCE

### 6.2L and 6.8L Gasoline Engines

<b>Every 7500 miles (12000 km) or six months (whichever comes first)</b>
Change engine oil and filter.
Rotate tires*, inspect tire wear and measure tread depth.
Inspect wheels and related components for abnormal noise, wear, looseness or drag.
Perform multi-point inspection (recommended).

\*Vehicles with dual rear wheels should rotate the front wheels when specified; rear wheels only if unusual wear is noted.

<b>Every 15000 miles (24000 km) or 12 months (whichever comes first)</b>
Inspect automatic transmission fluid level. Consult dealer for requirements.
Inspect brake pads, shoes, rotors, drums, brake linings, hoses and parking brake.
Inspect engine cooling system strength and hoses.
Inspect exhaust system and heat shields.
Inspect front axle and U-joints. Lubricate if equipped with grease fittings (Four-wheel drive vehicles).
Inspect steering linkage, ball joints, suspension, tie-rod ends, driveshaft and U-joints. Lubricate if equipped with grease fittings.

<b>Other maintenance items</b>	
Every 30000 miles (48000 km)	Replace climate-controlled (heated and cooled) seat filter.*
	Replace engine air filter.
Every 60000 miles (96000 km)	Change automatic transmission fluid and filter on 5-speed transmission. Consult dealer for requirements.

## Scheduled Maintenance

Other maintenance items	
	Replace front wheel bearing grease and grease seal if non-sealed bearings are used.
Every 97500 miles (156000 km)	Replace spark plugs.
Every 105000 miles (168000 km)	Change engine coolant.**
	Replace rear axle fluid.
	Inspect accessory drive belt(s).***
Every 150000 miles (240000 km)	Change automatic transmission fluid and filter on 6-speed transmission. Consult dealer for requirements.
	Replace accessory drive belt(s) if not replaced within the last 100000 miles (160000 km).
	Replace front wheel bearings and seals if non-sealed bearings are used.

\* If your vehicle has climate-controlled (heated and cooled) seats.

\*\* Initial replacement at six years or 105000 miles (168000 kilometers), then every three years or 45000 miles (72000 kilometers).

\*\*\* If not replaced, inspect every 15000 miles (24000 kilometers).

### 6.7L Diesel Engine

See the diesel supplement for scheduled maintenance information.

## SPECIAL OPERATING CONDITIONS SCHEDULED MAINTENANCE

### 6.2L and 6.8L Gasoline Engines

If you operate your vehicle **primarily** in any of the following conditions, you need to perform extra maintenance as indicated. If you operate your vehicle **occasionally** under any of these conditions, it is not necessary to perform the extra maintenance. For specific recommendations, see your dealership service advisor or technician.



## Scheduled Maintenance

<b>Towing a trailer or using a car-top carrier</b>	
Inspect frequently, service as required	Inspect and lubricate U-joints.
	See axle maintenance items under <b>Exceptions</b> .
Every 5000 miles (8000 km)	Inspect the wheels and related components for abnormal noise, wear, looseness or drag.
	Rotate tires*, inspect tires for wear and measure tread depth.
Every 5000 miles (8000 km) or six months	Change engine oil and filter.
	Inspect and lubricate U-joints.
Every 30000 miles (48000 km)	Replace front wheel bearing grease and grease seals if non-sealed bearings are used.
Every 60000 miles (96000 km)	Change transfer case fluid (Four-wheel drive vehicles).
	Replace spark plugs.

\*Vehicles with dual rear wheels should rotate the front wheels when specified; rear wheels only if unusual wear is noted.

<b>Extensive idling or low-speed driving for long distances, as in heavy commercial use (such as delivery, taxi, patrol car or livery)</b>	
Inspect frequently, service as required	Replace engine air filter.
Every 5000 miles (8000 km)	Inspect brake system.
	Inspect wheels and related components for abnormal noise, wear, looseness or drag.
	Lubricate control arm and steering ball joints if equipped with grease fittings.
	Rotate tires*, inspect tires for wear and measure tread depth.
Every 5000 miles (8000 km) or six months	Inspect and lubricate U-joints.
Every 5000 miles (8000 km), six months or 200 engine hours	Change engine oil and filter.

## Scheduled Maintenance

<b>Extensive idling or low-speed driving for long distances, as in heavy commercial use (such as delivery, taxi, patrol car or livery)</b>	
Every 30000 miles (48000 km)	Change transfer case fluid (Four-wheel drive vehicles).
	Replace front wheel bearing grease and grease seals if non-sealed bearings are used.
Every 60000 miles (96000 km)	Replace spark plugs.

\*Vehicles with dual rear wheels should rotate the front wheels when specified; rear wheels only if unusual wear is noted.

<b>Operating in dusty or sandy conditions (such as unpaved or dusty roads)</b>	
Inspect frequently, service as required	Replace engine air filter.
Every 5000 miles (8000 km)	Inspect the wheels and related components for abnormal noise, wear, looseness or drag.
	Rotate tires*, inspect tires for wear and measure tread depth.
Every 5000 miles (8000 km) or six months	Change engine oil and filter.
	Inspect and lubricate U-joints.
Every 30000 miles (48000 km)	Replace front wheel bearing grease and grease seals if non-sealed bearings are used.
Every 50000 miles (80000 km)	Change rear axle fluid (F-450 and F-550 only).
Every 60000 miles (96000 km)	Change transfer case fluid (Four-wheel drive vehicles).

\*Vehicles with dual rear wheels should rotate the front wheels when specified; rear wheels only if unusual wear is noted.

# Scheduled Maintenance

<b>Off-road operation</b>	
Inspect frequently, service as required	Inspect steering linkage, ball joints and U-joints, Lubricate if equipped with grease fittings.
	Replace engine air filter.
Every 5000 miles (8000 km) or six months	Change engine oil and filter.
	Inspect the wheels and related components for abnormal noise, wear, looseness or drag.
	Rotate tires*, inspect tires for wear and measure tread depth.
Every 30000 miles (48000 km)	Replace front wheel bearing grease and grease seals if non-sealed bearings are used.
Every 50000 miles (80000 km)	Change rear axle fluid (F-450 and F-550 only).
Every 60000 miles (96000 km)	Change transfer case fluid (Four-wheel drive vehicles).

\*Vehicles with dual rear wheels should rotate the front wheels when specified; rear wheels only if unusual wear is noted.

<b>Exclusive use of E85 (Flex fuel vehicles only)</b>	
Every oil change interval	If ran exclusively on E85, fill the fuel tank full with regular unleaded fuel.

## 6.7L Diesel Engine

See the diesel supplement for special operating condition information.

### Exceptions

There are several exceptions to the Normal Schedule:

#### Axle Maintenance

Change the axle fluid anytime an axle is submerged in water.

Rear axles and power take-off units with synthetic fluid and light-duty trucks equipped with Ford-design axles are lubricated for life; do not check or change fluid unless a leak is suspected, service is required or the assembly has been submerged in water. During long periods of trailer towing with outside temperatures above 70°F (21°C) and at wide-open throttle for long periods above 45 mph (72 km/h), change non-synthetic rear axle fluid every 3000 miles (4800 kilometers) or three months, whichever comes first. This interval can be waived if the axle is filled with 75W140 synthetic gear fluid meeting

# Scheduled Maintenance

---

Ford specification WSL-M2C192-A, part number FITZ-19580-B, or equivalent. Add friction modifier XL-3 (EST-M2C118-A) or equivalent for complete refill of Traction-Lok rear axles. See **Capacities and Specifications** (page 301).

## **Additional Axle Maintenance for F-450 and F-550**

Change rear axle fluid every 100000 miles (160000 kilometers) under normal driving conditions on all commercial applications. When operating your vehicle at or near maximum gross vehicle weights, change the rear axle fluid every 50000 miles (80000 kilometers). In addition, follow this 50000-mile (80000-kilometer) schedule when operating your vehicle under the special operating conditions, where noted.

## **California Fuel Filter Replacement**

If you register your vehicle in California, the California Air Resources Board has determined that the failure to perform this maintenance item does not nullify the emission warranty or limit recall liability before the completion of your vehicle's useful life. Ford Motor Company, however, urges you to have all recommended maintenance services performed at the specified intervals and to record all vehicle service.

## **Hot Climate Oil Change Intervals**

Vehicles operating in the Middle East, North Africa, Sub-Saharan Africa or locations with similar climates using an American Petroleum Institute (API) Certified for Gasoline Engines (Certification mark) oil of SM or SN quality, the normal oil change interval is 3000 miles (5000 kilometers).

If the available API SM or SN oils are not available, then the oil change interval is 1800 miles (3000 kilometers).

## **Engine Air Filter and Cabin Air Filter Replacement**

The life of the engine air filter and cabin air filter is dependent on exposure to dusty and dirty conditions. Vehicles operated in these conditions require frequent inspection and replacement of the engine air filter and cabin air filter.

## **Diesel Particulate Filter**

The filter may need to be removed for ash cleaning at approximately 120000 miles (192000 kilometers) or greater (actual mileage can vary greatly depending upon engine and vehicle operating conditions) and replaced with a new or re-manufactured (ash cleaned) part. The filter may need to be replaced at approximately 250000 miles (400000 kilometers) depending upon engine and vehicle operating conditions. In both cases, the engine control system sets a service light (wrench icon) to inform you to bring your vehicle to the dealer for service. If there are any issues with the oxidation catalyst or particulate filter system, a service light (wrench or engine icon) sets by the engine control system to inform you to bring your vehicle into a dealer for service.

# Scheduled Maintenance

## SCHEDULED MAINTENANCE RECORD

<input type="radio"/> Repair Order #:	<p>Dealer stamp</p>
<input type="radio"/> Distance:	
<input type="radio"/> Engine hours (optional):	
<input type="radio"/> Multi-point inspection (recommended): <input type="checkbox"/>	
<input type="radio"/> Signature:	

<input type="radio"/> Repair Order #:	<p>Dealer stamp</p>
<input type="radio"/> Distance:	
<input type="radio"/> Engine hours (optional):	
<input type="radio"/> Multi-point inspection (recommended): <input type="checkbox"/>	
<input type="radio"/> Signature:	

# Scheduled Maintenance

<input type="radio"/> Repair Order #:	<p>Dealer stamp</p>
<input type="radio"/> Distance:	
<input type="radio"/> Engine hours (optional):	
<input type="radio"/> Multi-point inspection (recommended): <input type="checkbox"/>	
<input type="radio"/> Signature:	

<input type="radio"/> Repair Order #:	<p>Dealer stamp</p>
<input type="radio"/> Distance:	
<input type="radio"/> Engine hours (optional):	
<input type="radio"/> Multi-point inspection (recommended): <input type="checkbox"/>	
<input type="radio"/> Signature:	

<input type="radio"/> Repair Order #:	<p>Dealer stamp</p>
<input type="radio"/> Distance:	
<input type="radio"/> Engine hours (optional):	
<input type="radio"/> Multi-point inspection (recommended): <input type="checkbox"/>	
<input type="radio"/> Signature:	

# Scheduled Maintenance

<input type="radio"/> Repair Order #:	<p>Dealer stamp</p>
<input type="radio"/> Distance:	
<input type="radio"/> Engine hours (optional):	
<input type="radio"/> Multi-point inspection (recommended): <input type="checkbox"/>	
<input type="radio"/> Signature:	

<input type="radio"/> Repair Order #:	<p>Dealer stamp</p>
<input type="radio"/> Distance:	
<input type="radio"/> Engine hours (optional):	
<input type="radio"/> Multi-point inspection (recommended): <input type="checkbox"/>	
<input type="radio"/> Signature:	

<input type="radio"/> Repair Order #:	<p>Dealer stamp</p>
<input type="radio"/> Distance:	
<input type="radio"/> Engine hours (optional):	
<input type="radio"/> Multi-point inspection (recommended): <input type="checkbox"/>	
<input type="radio"/> Signature:	

# Scheduled Maintenance

<input type="radio"/> Repair Order #:	<p>Dealer stamp</p>
<input type="radio"/> Distance:	
<input type="radio"/> Engine hours (optional):	
<input type="radio"/> Multi-point inspection (recommended): <input type="checkbox"/>	
<input type="radio"/> Signature:	

<input type="radio"/> Repair Order #:	<p>Dealer stamp</p>
<input type="radio"/> Distance:	
<input type="radio"/> Engine hours (optional):	
<input type="radio"/> Multi-point inspection (recommended): <input type="checkbox"/>	
<input type="radio"/> Signature:	

<input type="radio"/> Repair Order #:	<p>Dealer stamp</p>
<input type="radio"/> Distance:	
<input type="radio"/> Engine hours (optional):	
<input type="radio"/> Multi-point inspection (recommended): <input type="checkbox"/>	
<input type="radio"/> Signature:	



# Scheduled Maintenance

<input type="radio"/> Repair Order #:	<p>Dealer stamp</p>
<input type="radio"/> Distance:	
<input type="radio"/> Engine hours (optional):	
<input type="radio"/> Multi-point inspection (recommended): <input type="checkbox"/>	
<input type="radio"/> Signature:	

<input type="radio"/> Repair Order #:	<p>Dealer stamp</p>
<input type="radio"/> Distance:	
<input type="radio"/> Engine hours (optional):	
<input type="radio"/> Multi-point inspection (recommended): <input type="checkbox"/>	
<input type="radio"/> Signature:	

<input type="radio"/> Repair Order #:	<p>Dealer stamp</p>
<input type="radio"/> Distance:	
<input type="radio"/> Engine hours (optional):	
<input type="radio"/> Multi-point inspection (recommended): <input type="checkbox"/>	
<input type="radio"/> Signature:	

# Scheduled Maintenance

<input type="radio"/> Repair Order #:	<p>Dealer stamp</p>
<input type="radio"/> Distance:	
<input type="radio"/> Engine hours (optional):	
<input type="radio"/> Multi-point inspection (recommended): <input type="checkbox"/>	
<input type="radio"/> Signature:	

<input type="radio"/> Repair Order #:	<p>Dealer stamp</p>
<input type="radio"/> Distance:	
<input type="radio"/> Engine hours (optional):	
<input type="radio"/> Multi-point inspection (recommended): <input type="checkbox"/>	
<input type="radio"/> Signature:	

<input type="radio"/> Repair Order #:	<p>Dealer stamp</p>
<input type="radio"/> Distance:	
<input type="radio"/> Engine hours (optional):	
<input type="radio"/> Multi-point inspection (recommended): <input type="checkbox"/>	
<input type="radio"/> Signature:	

# Scheduled Maintenance

<input type="radio"/> Repair Order #:	<p>Dealer stamp</p>
<input type="radio"/> Distance:	
<input type="radio"/> Engine hours (optional):	
<input type="radio"/> Multi-point inspection (recommended): <input type="checkbox"/>	
<input type="radio"/> Signature:	

<input type="radio"/> Repair Order #:	<p>Dealer stamp</p>
<input type="radio"/> Distance:	
<input type="radio"/> Engine hours (optional):	
<input type="radio"/> Multi-point inspection (recommended): <input type="checkbox"/>	
<input type="radio"/> Signature:	

<input type="radio"/> Repair Order #:	<p>Dealer stamp</p>
<input type="radio"/> Distance:	
<input type="radio"/> Engine hours (optional):	
<input type="radio"/> Multi-point inspection (recommended): <input type="checkbox"/>	
<input type="radio"/> Signature:	

# Index

## 4

### 4WD

See: Four-Wheel Drive.....153

## A

### A/C

See: Climate Control.....106

### About This Manual.....7

Protecting the Environment.....7

### ABS

See: Brakes.....164

### ABS driving hints

See: Hints on Driving With Anti-Lock  
Brakes.....164

### Accessories.....429

Exterior style.....429

Interior style.....429

Lifestyle.....429

Peace of mind.....429

### Accessories

See: Replacement Parts  
Recommendation.....12

### Adjusting the Headlamps.....246

Horizontal Aim Adjustment.....247

Vertical Aim Adjustment.....246

### Adjusting the Pedals.....65

### Adjusting the Steering Wheel.....62

### Airbag Disposal.....46

### Air Conditioning

See: Climate Control.....106

### Alarm

See: Anti-Theft Alarm.....61

### Anti-Theft Alarm.....61

Arming the Alarm.....61

Disarming the Alarm.....61

### Appendices.....433

### Audible Warnings and Indicators.....82

Headlamps On Warning Chime.....82

Key in Ignition Warning Chime.....82

Parking Brake On Warning Chime.....83

### Audio Control.....62

Media.....63

Seek, Next or Previous.....63

### Audio Input Jack.....321

### Audio System.....310

General Information.....310

Audio Unit - Vehicles With: AM/FM/CD/  
SYNC.....312

Audio Unit - Vehicles With: AM/FM.....311

Audio Unit - Vehicles With: Sony AM/  
FM/CD.....315

### Autolamps.....67

Autolamps - Programmable Exit  
Delay.....68

### Automatic Climate Control.....107

### Automatic Transmission.....147

Brake-Shift Interlock.....151

If Your Vehicle Gets Stuck In Mud or  
Snow.....152

Understanding the Shift Positions of a  
6-Speed Automatic Transmission.....148

Understanding the Shift Positions of the  
5-Speed Automatic Transmission.....147

Understanding your SelectShift  
Automatic™ transmission.....149

### Automatic Transmission Fluid

Check.....240

Checking Automatic Transmission  
Fluid.....240

### Auxiliary Power Points.....132

110 Volt AC Power Points.....132

12 Volt DC Power Point.....132

Locations.....132

### Auxiliary Switches.....430

## B

### Bonnet Lock

See: Opening and Closing the Hood.....232

### Booster Seats.....24

Types of Booster Seats.....25

### Brake Fluid Check.....243

### Brakes.....164

General Information.....164

### Breaking-In.....207

### Bulb Specification Chart.....251

## C

### California Proposition 65.....11

### Capacities and Specifications.....301

Technical Specifications.....305

### Car Wash

See: Cleaning the Exterior.....255

# Index

Center Console.....	134	Cleaning the Instrument Panel and Instrument Cluster Lens.....	257
Removable Front Cupholders.....	134	Cleaning the Interior.....	257
Changing a Bulb.....	249	Cleaning the Windows and Wiper Blades.....	257
Lamp Assembly Condensation.....	249	Clearing All MyKeys.....	53
Replacing Brake/Tail/Turn/Reverse Lamp Bulbs.....	250	Climate.....	411
Replacing Cargo Lamp and High-mount Brake Lamp Bulbs.....	250	Climate Control Voice Commands.....	413
Replacing Fog Lamp Bulbs (If Equipped).....	250	Climate Control.....	106
Replacing Front Clearance and Identification Lamp Bulbs (If Equipped).....	249	Climate Controlled Seats.....	121
Replacing the License Plate Lamp Bulb.....	251	Cooled Seats.....	121
Changing a Fuse.....	231	Heated Seats.....	121
Fuses.....	231	Coolant Check	
Changing a Road Wheel.....	288	See: Engine Coolant Check.....	236
Dissimilar Spare Wheel and Tire Assembly Information.....	288	Crash Sensors and Airbag Indicator.....	45
Location of the Spare Tire and Tools.....	289	Creating a MyKey.....	51
Removing the Spare Tire (With Spare Tire Carrier Only).....	290	Programming/Changing Configurable Settings.....	52
Tire Change Procedure.....	291	Cruise Control.....	63
Changing the 12V Battery.....	244	Principle of Operation.....	178
Battery Management System (If Equipped).....	245	Cruise control	
Changing the Engine Air Filter.....	253	See: Using Cruise Control.....	178
Changing the Wiper Blades.....	246	Customer Assistance.....	217
Checking MyKey System Status.....	53		
Checking the Wiper Blades.....	246	<b>D</b>	
Child Restraint and Safety Belt		Data Recording.....	9
Maintenance.....	35	Event Data Recording.....	10
Child Safety.....	15	Service Data Recording.....	9
General Information.....	15	Daytime Running Lamps.....	68
Child Safety Locks.....	27	Digital Radio.....	316
Child Seat Positioning.....	26	HD Radio Reception and Station Troubleshooting.....	317
Cleaning Leather Seats.....	258	Direction Indicators.....	69
With King Ranch Edition.....	259	Lane Change.....	69
Without King Ranch Edition.....	258	Driver and Passenger Airbags.....	37
Cleaning Products.....	255	Children and Airbags.....	42
Cleaning the Alloy Wheels.....	260	Driver and Front Passenger Seating Adjustment.....	37
Cleaning the Engine.....	256	Passenger Airbag On and Off Switch .....	37
Cleaning the Exterior.....	255	Driving Aids.....	179
Exterior Chrome Parts.....	255	Driving Hints.....	207
Exterior Plastic Parts.....	256	Driving Through Water.....	208
Stripes or Graphics.....	256	DRL	
Underbody.....	256	See: Daytime Running Lamps.....	68

# Index

## E

Economical Driving.....	207
Electronic Locking Differential.....	162
Activating the Electronic Locking Differential.....	162
Emission Control System.....	144
On-Board Diagnostics (OBD-II).....	145
Readiness for Inspection/Maintenance (I/M) Testing.....	145
End User License Agreement.....	433
SYNC End User License Agreement (EULA).....	433
Engine Block Heater.....	137
Using the Engine Block Heater.....	138
Engine Coolant Check.....	236
Adding Engine Coolant.....	237
Recycled Engine Coolant.....	237
Severe Climates.....	238
What You Should Know About Fail-Safe Cooling.....	238
Engine Immobilizer	
See: Passive Anti-Theft System.....	60
Engine Oil Check.....	235
Adding Engine Oil.....	235
Engine Oil Dipstick.....	235
Engine Specifications.....	301
Drivebelt Routing.....	301
Entertainment.....	379
A/V Inputs.....	395
AM/FM Radio.....	381
Bluetooth Audio.....	394
Browsing Device Content.....	379
CD.....	390
SD Card Slot and USB Port.....	391
SIRIUS® Satellite Radio (If Activated).....	386
Supported Media Players, Formats and Metadata Information.....	394

Essential Towing Checks.....	195
Before Towing a Trailer.....	202
Hitches.....	197
Integrated Trailer Brake Controller.....	198
Launching or Retrieving a Boat or Personal Watercraft (PWC).....	203
Safety Chains.....	198
Trailer Brakes.....	198
Trailer Lamps.....	202
Trailer Towing Connector.....	196
Using a Step Bumper (If Equipped).....	202
Using the Rear View Camera To Align Your Trailer Hitch.....	196
When Towing a Trailer.....	202
Event Data Recording	
See: Data Recording.....	9
Export Unique Options.....	14
Extended Service Plan (ESP).....	455
SERVICE PLANS (CANADA ONLY).....	456
SERVICE PLANS (U.S. Only).....	455
Exterior Mirrors.....	72
Clearance Lamps.....	73
Fold-Away Exterior Mirrors.....	73
Heated Exterior Mirrors.....	73
Memory Mirrors.....	73
Power Exterior Mirrors.....	72
Telescoping Mirrors.....	74

## F

Fastening the Safety Belts.....	29
Fastening the Cinch Tongue.....	30
Safety Belt Extension Assembly.....	31
Safety Belt Locking Modes.....	30
Using Safety Belts During Pregnancy.....	30
Using the Safety Belt with Cinch Tongue (Front Center and Rear Center Seats Only).....	29
Floor Mats.....	208
Fog Lamps - Front	
See: Front Fog Lamps.....	69
Foot Pedals	
See: Adjusting the Pedals.....	65
Ford Credit.....	11
(U.S. Only).....	11
Four-Wheel Drive.....	153
Front Fog Lamps.....	69
Front Seat Armrest.....	122

# Index

Fuel and Refueling.....	139
Fuel Consumption.....	143
Calculating Fuel Economy.....	143
Filling the Tank.....	143
Fuel Filter.....	243
Fuel Quality.....	140
Choosing the Right Fuel.....	140
Choosing the Right Fuel With a Flex Fuel Vehicle (If Equipped).....	140
Diesel Engine.....	140
Octane Recommendations.....	140
Fuel Shutoff.....	213
Fuses.....	223
Fuse Specification Chart.....	223
Passenger Compartment Fuse Panel.....	228
Power Distribution Box.....	223

## G

Garage Door Opener	
See: Universal Garage Door Opener.....	124
Gauges.....	77
Engine Coolant Temperature Gauge.....	78
Engine Oil Pressure Gauge.....	78
Fuel Gauge.....	78
Information Display.....	79
Transmission Fluid Temperature Gauge.....	78
General Information on Radio	
Frequencies.....	47
General Maintenance Information.....	457
Multi-point Inspection.....	459
Owner Checks and Services.....	458
Protecting Your Investment.....	457
Why Maintain Your Vehicle?.....	457
Why Maintain Your Vehicle at Your Dealership?.....	457
Getting Assistance Outside the U.S. and Canada.....	220
Getting the Services You Need.....	217
Away From Home.....	217
Global Opening.....	72
Opening the Windows.....	72

## H

Handbrake	
See: Parking Brake.....	165
Hazard Warning Flashers.....	213
HDC	
See: Using Hill Descent Control.....	172
Head Restraints.....	113
Adjusting the Head Restraint.....	114
Heated Seats.....	119
Rear Heated Seats .....	120
Heated Steering Wheel.....	64
Heated Windows and Mirrors.....	111
Heated Exterior Mirror.....	111
Heated Rear Window.....	111
Heating	
See: Climate Control.....	106
Hill Start Assist.....	165
Switching the System On and Off.....	166
Using Hill Start Assist.....	165
Hints on Controlling the Interior	
Climate.....	109
Cooling the Interior Quickly.....	110
General Hints.....	109
Heating the Interior Quickly.....	109
Recommended Settings for Cooling .....	110
Recommended Settings for Heating.....	110
Side Window Defogging in Cold Weather.....	111
Hints on Driving With Anti-Lock Brakes.....	164
Hood Lock	
See: Opening and Closing the Hood.....	232

## I

Ignition Switch.....	135
In California (U.S. Only).....	218
Information Display Control.....	63
Type 1.....	63
Type 2.....	64
Information Displays.....	84
General Information.....	84

# Index

Information.....	402
911 Assist.....	408
Alerts.....	408
Calendar.....	408
Sirius Travel Link.....	405
SYNC Services (If Equipped, United States Only).....	403
Vehicle Health Report (If Equipped, United States Only).....	410
Information Messages.....	95
4WD.....	104
AdvanceTrac™.....	95
Alarm.....	95
Diesel Messages.....	96
Doors and Locks.....	99
Drivetrain.....	99
Engine.....	100
Fuel.....	100
Key.....	101
Maintenance.....	101
MyKey®.....	101
Off Road.....	103
Park Aid.....	102
Park Brake.....	102
Power Steering.....	102
Tire Pressure Monitoring System.....	103
Trailer.....	104
Installing Child Seats.....	16
Child Seats.....	16
Tether Strap Attachment.....	22
Tether Strap Attachment (Rear SuperCab Only).....	23
Using Cinch Tongue Lap and Shoulder Belts (All Front Center, Super Cab and Crew Cab Rear Center Positions).....	19
Using Lap and Shoulder Belts.....	17
Using Lower Anchors and Tethers for Children (LATCH).....	21
Using Tether Straps.....	21
Instrument Cluster.....	77
Instrument Lighting Dimmer.....	68
Interior Lamps.....	69
Front Map Lamps (If equipped).....	69
Rear Dome and Map Lamps.....	70
Interior Mirror.....	74
Auto-Dimming Mirror.....	74
Introduction.....	7
<b>J</b>	
Jump Starting the Vehicle.....	214
Connecting the Jumper Cables.....	214
Jump Starting.....	215
Preparing Your Vehicle.....	214
Removing the Jumper Cables.....	215
<b>K</b>	
Keyless Entry.....	57
SECURICODE™ KEYLESS ENTRY KEYPAD.....	57
Keys and Remote Controls.....	47
<b>L</b>	
Lighting Control.....	67
Headlamp Flasher.....	67
High Beams.....	67
Lighting.....	67
Limited Slip Differential.....	162
Load Carrying.....	180
Load Limit.....	180
Special Loading Instructions for Owners of Pick-up Trucks and Utility-type Vehicles.....	187
Vehicle Loading - with and without a Trailer.....	180
Locking and Unlocking.....	56
Autolock and Autounlock.....	56
Battery Saver.....	57
Illuminated Entry.....	57
Power Door Locks.....	56
Remote Control.....	56
Smart Unlocks.....	56
Locks.....	56
Lug Nuts	
See: Changing a Road Wheel.....	288
<b>M</b>	
Maintenance.....	232
General Information.....	232
Manual Climate Control.....	106



# Index

Manual Seats.....	115
Manual Lumbar .....	116
Moving the Seat Backward and Forward.....	115
Recline Adjustment.....	115
Media Hub.....	322
Memory Function.....	116
Easy Entry and Exit Feature.....	117
Message Center	
See: Information Displays.....	84
Mirrors	
See: Heated Windows and Mirrors.....	111
See: Windows and Mirrors.....	71
Mobile Communications Equipment.....	13
Moonroof.....	75
Bounce-Back.....	76
Opening and Closing the Moonroof.....	75
Venting the Moonroof.....	76
Motorcraft Parts.....	302
MyFord Touch™.....	362
General Information.....	362
MyFord Touch™ Troubleshooting.....	422
MyKey Troubleshooting.....	55
MyKey™.....	51
Principle of Operation.....	51

## N

Navigation.....	414
cityseekr.....	416
Map Mode.....	418
Navigation Map Updates.....	420
Navigation Voice Commands.....	420
Point of Interest (POI) Categories.....	415
Quick-touch Buttons.....	420
Setting a Destination.....	414
Setting Your Navigation Preferences.....	417
Normal Scheduled Maintenance.....	460
6.2L and 6.8L Gasoline Engines.....	460
6.7L Diesel Engine.....	461

## O

Oil Check	
See: Engine Oil Check.....	235
Opening and Closing the Hood.....	232

Ordering Additional Owner's Literature.....	221
Obtaining a French Owner's Manual.....	221
Overhead Console.....	134

## P

Parking Aid.....	174
Rear Sensing System.....	174
Parking Aids.....	174
Parking Brake.....	165
Passive Anti-Theft System.....	60
SecuriLock™.....	60
PATS	
See: Passive Anti-Theft System.....	60
Pedals.....	65
Perchlorate.....	11
Phone.....	396
Making Calls.....	398
Pairing Subsequent Phones.....	398
Pairing Your Phone for the First Time.....	397
Phone Menu Options.....	398
Phone Settings.....	400
Phone Voice Commands.....	401
Receiving Calls.....	398
Text Messaging.....	399
Post-Crash Alert System.....	216
Power Door Locks	
See: Locking and Unlocking.....	56
Power Seats.....	116
Power Lumbar.....	116
Power Recline.....	116
Power Steering Fluid Check.....	243
Power Take-Off.....	152
Power Windows.....	71
Accessory Delay.....	72
Bounce-Back.....	71
One-Touch Up or Down.....	71
Power Sliding Back Window.....	72
Window Lock.....	72

## R

Rear Axle.....	162
Rear Seat Armrest.....	123

# Index

Rear Seats.....	117	Roadside Emergencies.....	212
Folding the Rear Seat Back (Crew Cab)		Running-In	
.....	118	See: Breaking-In.....	207
Folding up the Rear Seat Cushion.....	118	Running Out of Fuel.....	141
Rear Under Seat Storage (Crew Cab).....	119	Refilling With a Portable Fuel	
Returning the Seat to the Seating		Container.....	141
Position.....	118		
Rear View Camera.....	175	<b>S</b>	
Using the Rear View Camera System.....	176	Safety Belt Height Adjustment.....	32
Rear View Camera		Safety Belt Minder.....	33
See: Rear View Camera.....	175	Belt-Minder™.....	33
Recommended Towing Weights.....	192	Safety Belts.....	28
Calculating the Maximum Loaded Trailer		Principle of Operation.....	28
Weight for Your Vehicle.....	195	Safety Belt Warning Lamp and Indicator	
Refueling.....	141	Chime.....	32
Fuel Filler Cap.....	142	Conditions of operation.....	33
Remote Control.....	47	Safety Canopy™.....	44
Car Finder.....	48	Safety Precautions.....	139
Integrated Keyhead Transmitters	47	Satellite Radio.....	318
Memory Feature.....	48	Satellite Radio Electronic Serial Number	
Remote Start	49	(ESN).....	319
Replacing the Battery.....	47	Satellite Radio Reception Factors.....	319
Sounding a Panic Alarm.....	49	SIRIUS® Satellite Radio Service.....	319
Remote Start.....	112	Troubleshooting.....	320
Automatic Settings.....	112	Scheduled Maintenance Record.....	466
Removing a Headlamp.....	248	Scheduled Maintenance.....	457
Repairing Minor Paint Damage.....	259	Seats.....	113
Replacement Parts		Security.....	60
Recommendation.....	12	Settings.....	369
Collision Repairs.....	12	Clock.....	370
Scheduled Maintenance and Mechanical		Display.....	370
Repairs.....	12	Settings.....	372
Warranty on Replacement Parts.....	12	Sound.....	371
Replacing a Lost Key or Remote		Vehicle.....	371
Control.....	50	Side Airbags.....	43
Reporting Safety Defects (Canada		Sitting in the Correct Position.....	113
Only).....	222	Snow Chains	
Reporting Safety Defects (U.S.		See: Using Snow Chains.....	282
Only).....	221	Snowplowing.....	209
Roadside Assistance.....	212	Engine temperature while plowing.....	210
Vehicles Sold in Canada: Getting Roadside		Installing the Snowplow.....	209
Assistance.....	212	Operating the Vehicle with the Snowplow	
Vehicles Sold in Canada: Using Roadside		Attached.....	210
Assistance.....	212	Snowplowing with your Airbag Equipped	
Vehicles Sold in the United States: Getting		Vehicle.....	210
Roadside Assistance.....	212	Transmission operation while	
Vehicles Sold in the United States: Using		plowing.....	211
Roadside Assistance.....	212		

# Index

Special Notices.....	12
New Vehicle Limited Warranty.....	12
On-board Diagnostics (OBD-II).....	12
Special Instructions.....	12
Using your Vehicle as an Ambulance.....	13
Using your Vehicle as a Stationary Power Source.....	13
Using your Vehicle With a Snowplow.....	13
Special Operating Conditions Scheduled Maintenance.....	461
6.2L and 6.8L Gasoline Engines.....	461
6.7L Diesel Engine.....	464
Exceptions.....	464
Speed Control See: Cruise Control.....	178
Stability Control.....	169
Principle of Operation.....	169
Starter Switch See: Ignition Switch.....	135
Starting a Gasoline Engine.....	136
Cold Weather Starting (Flexible Fuel Vehicles Only).....	136
Failure to Start.....	136
Guarding Against Exhaust Fumes.....	137
Important Ventilating Information.....	137
Stopping the Engine When Your Vehicle is Moving.....	136
Stopping the Engine When Your Vehicle is Stationary.....	136
Starting and Stopping the Engine.....	135
General Information.....	135
Steering.....	179
Steering Wheel.....	62
Storage Compartments.....	134
Sunroof See: Moonroof.....	75
Sun Visors.....	75
Illuminated Vanity Mirror.....	75
Slide-on-rod.....	75
Supplementary Restraints System.....	36
Principle of Operation.....	36
Symbols Glossary.....	7
SYNC™ Applications and Services.....	338
911 Assist.....	338
SYNC Applink.....	344
SYNC Services: Traffic, Directions & Information (TDI) (If Equipped, Unites States Only).....	341
Vehicle Health Report.....	340
SYNC™.....	323
General Information.....	323
SYNC™ Troubleshooting.....	353
<b>T</b>	
Tailgate.....	187
Bed Extender.....	189
Tailgate Lock.....	187
Tailgate Removal.....	188
Tailgate Step.....	188
Technical Specifications See: Capacities and Specifications.....	301
Terrain Response.....	172
Principle of Operation.....	172
The Better Business Bureau (BBB) Auto Line Program (U.S. Only).....	219
Tire Care.....	265
Glossary of Tire Terminology.....	266
Information About Uniform Tire Quality Grading.....	265
Information Contained on the Tire Sidewall.....	267
Temperature A B C.....	266
Traction AA A B C.....	265
Treadwear.....	265
Tire Pressure Monitoring System.....	283
Changing Tires With a Tire Pressure Monitoring System.....	284
Understanding Your Tire Pressure Monitoring System.....	284
Tires See: Wheels and Tires.....	263
Towing a Trailer.....	191
Load Placement.....	191
Towing Points.....	203
Towing the Vehicle on Four Wheels.....	205
Emergency Towing.....	205
Recreational Towing.....	205

# Index

Towing.....	191
Traction Control.....	167
Principle of Operation.....	167
Trailer Sway Control.....	192
Transfer Case Fluid Check.....	242
Transmission Code Designation.....	304
Transmission.....	147
See: Transmission.....	147
Transporting the Vehicle.....	204

## U

Under Hood Overview - 6.2L.....	233
Under Hood Overview - 6.8L.....	234
Universal Garage Door Opener.....	124
CAR2U® Home Automation System.....	124
HomeLink Wireless Control System.....	127
USB Port.....	321
Using Cruise Control.....	178
Switching Cruise Control Off.....	178
Switching Cruise Control On.....	178
Using Four-Wheel Drive.....	153
4WD Indicator Lights.....	154
Driving Off-Road With Truck and Utility Vehicles.....	157
Electronic Shift-On-the-Fly (ESOF) 4WD system.....	153
How Your Vehicle Differs From Other Vehicles.....	157
Manual Shift On Stop (MSOS) 4WD system.....	153
Using a Manual Shift On Stop (MSOS) 4wd system.....	154
Using the Electronic Shift on the Fly 4WD system.....	156
Using Hill Descent Control.....	172
Hill descent modes.....	172
Using MyKey With Remote Start Systems.....	55
Using Snow Chains.....	282
Using Stability Control.....	169
AdvanceTrac® with Roll Stability Control™ (RSC®).....	169

## Using SYNC™ With Your Media

Player.....	345
Accessing Your Play Menu.....	349
Connecting Your Digital Media Player to the USB Port.....	345
Media Menu Features.....	348
Media Voice Commands.....	346
System Settings.....	351
What's Playing?.....	346
Using SYNC™ With Your Phone.....	327
Accessing Features through the Phone Menu.....	331
Accessing Your Phone Settings.....	334
Making Calls.....	330
Pairing a Phone for the First Time.....	328
Pairing Subsequent Phones.....	328
Phone Options during an Active Call.....	330
Phone Voice Commands.....	328
Receiving Calls.....	330
System Settings.....	335
Text Messaging.....	333
Using Traction Control.....	167
System Indicator Lights and Messages.....	168
Using Voice Recognition.....	325
Initiating a Voice Session.....	325
System Interaction and Feedback.....	326
Utilizing the Mediation/Arbitration Program (Canada Only).....	219

## V

Vehicle Care.....	255
General Information.....	255
Vehicle Certification Label.....	303
Vehicle Identification Number.....	303
Vehicle Storage.....	260
Battery.....	261
Body.....	260
Brakes.....	261
Cooling system.....	261
Engine.....	261
Fuel system.....	261
General.....	260
Miscellaneous.....	261
Removing Vehicle From Storage.....	261
Tires.....	261

# Index

---

Ventilation	
See: Climate Control.....	106
VIN	
See: Vehicle Identification Number.....	303
Voice Control.....	63

Windshield Wipers.....	66
Speed dependent wipers.....	66
Wipers and Washers.....	66

## W

Warning Lamps and Indicators.....	79
4X2.....	82
4X4 HIGH.....	82
4X4 LOW.....	82
Anti-Lock Braking System.....	79
Battery.....	79
Brake System.....	79
Check Fuel Cap.....	80
Cruise Control.....	80
Diesel Warning Lights.....	82
Direction Indicator.....	80
Door Ajar.....	80
Electronic Locking Differential.....	80
Engine Coolant Temperature.....	80
Engine Oil.....	80
Fasten Safety Belt.....	80
Front Airbag.....	80
High Beam.....	80
Hill Descent.....	80
Low Fuel Level.....	81
Low Tire Pressure Warning.....	81
Powertrain Malfunction/Reduced Power/Electronic Throttle Control.....	81
Service Engine Soon.....	81
Stability Control.....	81
Stability Control Off.....	82
Transmission Tow/Haul.....	82
Washer Fluid Check.....	243
Washers	
See: Cleaning the Exterior.....	255
See: Wipers and Washers.....	66
Waxing.....	256
Wheel Nuts	
See: Changing a Road Wheel.....	288
Wheels and Tires.....	263
General Information.....	263
Technical Specifications.....	299
Windows and Mirrors.....	71
Windshield Washers.....	66