

DODGE

2011

Caliber

OWNER'S MANUAL

VEHICLES SOLD IN CANADA

With respect to any Vehicles Sold in Canada, the name Chrysler Group LLC shall be deemed to be deleted and the name Chrysler Canada Inc. used in substitution therefore.

DRIVING AND ALCOHOL

Drunken driving is one of the most frequent causes of accidents.

Your driving ability can be seriously impaired with blood alcohol levels far below the legal minimum. If you are drinking, don't drive. Ride with a designated non-drinking driver, call a cab, a friend, or use public transportation.

WARNING!

Driving after drinking can lead to an accident. Your perceptions are less sharp, your reflexes are slower, and your judgment is impaired when you have been drinking. Never drink and then drive.

This manual illustrates and describes the operation of features and equipment that are either standard or optional on this vehicle. This manual may also include a description of features and equipment that are no longer available or were not ordered on this vehicle. Please disregard any features and equipment described in this manual that are not on this vehicle.

Chrysler Group LLC reserves the right to make changes in design and specifications, and/or make additions to or improvements to its products without imposing any obligation upon itself to install them on products previously manufactured.

Copyright © 2010 Chrysler Group LLC



TABLE OF CONTENTS

SECTION		PAGE	
1	INTRODUCTION	3	1
2	THINGS TO KNOW BEFORE STARTING YOUR VEHICLE	9	2
3	UNDERSTANDING THE FEATURES OF YOUR VEHICLE	89	3
4	UNDERSTANDING YOUR INSTRUMENT PANEL	185	4
5	STARTING AND OPERATING	289	5
6	WHAT TO DO IN EMERGENCIES	371	6
7	MAINTAINING YOUR VEHICLE	391	7
8	MAINTENANCE SCHEDULES	439	8
9	IF YOU NEED CONSUMER ASSISTANCE	455	9
10	INDEX	465	10

INTRODUCTION

CONTENTS

■ Introduction	4	■ Vehicle Identification Number	6
■ How To Use This Manual	4	■ Vehicle Modifications/Alterations	7
■ Warnings And Cautions	6		

INTRODUCTION

Congratulations on selecting your new Chrysler Group LLC vehicle. Be assured that it represents precision workmanship, distinctive styling, and high quality - all essentials that are traditional to our vehicles.

This Owner's Manual has been prepared with the assistance of service and engineering specialists to acquaint you with the operation and maintenance of your vehicle. It is supplemented by Warranty Information, and various customer-oriented documents. Please take the time to read these publications carefully. Following the instructions and recommendations in this manual will help assure safe and enjoyable operation of your vehicle.

NOTE: After reviewing the owner information, it should be stored in the vehicle for convenient referencing and remain with the vehicle when sold.

When it comes to service, remember that your authorized dealer knows your vehicle best, has factory-trained technicians and genuine MOPAR® parts, and cares about your satisfaction.









































HOW TO USE THIS MANUAL

Consult the Table of Contents to determine which section contains the information you desire.

Since the specification of your vehicle depends on the items of equipment ordered, certain descriptions and illustrations may differ from your vehicle's equipment

The detailed index at the back of this Owner's Manual contains a complete listing of all subjects.

Consult the following table for a description of the symbols that may be used on your vehicle or throughout this Owner's Manual:

											ESP BAS ELECTRONIC STABILITY PROGRAM / BRAKE ASSIST SYSTEM
											BRAKE BRAKE SYSTEM WARNING PARKING BRAKE
										AWD!	 FAILURE OF ANTILOCK BRAKING SYSTEM
										4WD!	BRAKE BRAKE SYSTEM WARNING PARKING BRAKE
											TOW/HAUL TOW / HAUL
											4 LOW FOUR WHEEL DRIVE LOW
			SRS AIRBAG							A/C PUSH	 ELECTRONIC STABILITY CONTROL OFF

WARNINGS AND CAUTIONS

This Owner's Manual contains **WARNINGS** against operating procedures that could result in a collision or bodily injury. It also contains **CAUTIONS** against procedures that could result in damage to your vehicle. If you do not read this entire manual, you may miss important information. Observe all Warnings and Cautions.

VEHICLE IDENTIFICATION NUMBER

The Vehicle Identification Number (VIN) is found on the left front corner of the instrument panel, visible through the windshield. This number also is stamped into the right front body, on the right front seat crossmember under the carpet. This number also appears on the vehicle registration and title.



Vehicle Identification Number

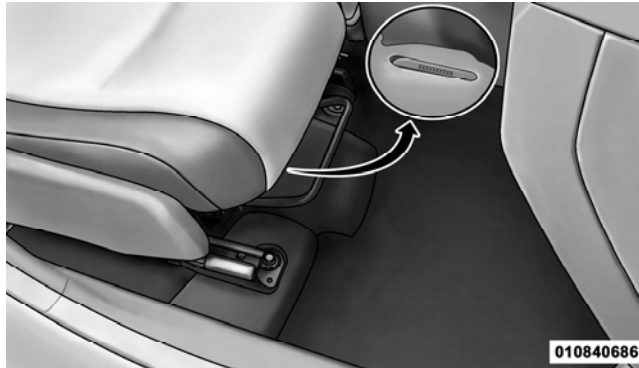

Right Front Body VIN Location

NOTE: It is illegal to remove or alter the VIN.

VEHICLE MODIFICATIONS/ALTERATIONS

WARNING!

Any modifications or alterations to this vehicle could seriously affect its roadworthiness and safety and may lead to a accident resulting in serious injury or death.

THINGS TO KNOW BEFORE STARTING YOUR VEHICLE

CONTENTS

■ A Word About Your Keys	12	■ Vehicle Security Alarm — If Equipped	17
□ Ignition Key Removal	12	□ To Arm The System	17
□ Locking Doors With A Key	14	□ To Disarm The System	18
□ Key-In-Ignition Reminder	14	□ Vehicle Security Alarm Manual Override	18
■ Sentry Key®	14	■ Remote Keyless Entry (RKE) — If Equipped	18
□ Replacement Keys	15	□ To Unlock The Doors And Liftgate	19
□ Customer Key Programming	16	□ Remote Key Unlock, Driver Door/All First Press	19
□ General Information	17	□ Illuminated Approach — If Equipped	20

10 THINGS TO KNOW BEFORE STARTING YOUR VEHICLE

- To Lock The Doors And Liftgate 20
- Sound Horn With Remote Key Lock 20
- Flash Lights With Remote Key Lock/Unlock . . . 21
- Using The Panic Alarm 22
- Programming Additional Transmitters 23
- General Information 23
- Transmitter Battery Replacement 23
- Remote Starting System — If Equipped 24
 - How To Use Remote Start 25
- Door Locks 27
 - Power Door Locks 28
 - Child-Protection Door Lock System (Rear Doors) — If Equipped 31
- Power Windows — If Equipped 33
 - Power Window Switches 33
 - Auto-Down 34
 - Window Lockout Switch 35
- Liftgate 35
- Occupant Restraints 37
 - Lap/Shoulder Belts 41
 - Adjustable Upper Shoulder Belt Anchorage . . . 46
 - Lap/ Shoulder Belt Operating Instructions With A Mini-Latch And Buckle 47
 - Lap/Shoulder Belt Untwisting Procedure 50
 - Seat Belts In Passenger Seating Positions 50
 - Automatic Locking Retractor Mode (ALR) — If Equipped 51

□ Seat Belt Pretensioners — If Equipped	52
□ Energy Management Feature	53
□ Supplemental Active Head Restraints (AHR)	53
□ Enhanced Seat Belt Use Reminder System (BeltAlert®)	57
□ Seat Belt Extender	59
□ Seat Belts And Pregnant Women	59
□ Supplemental Restraint System (SRS) — Air Bags	59
□ Advanced Front Air Bag Features	62
□ Air Bag Deployment Sensors And Controls	66

THINGS TO KNOW BEFORE STARTING YOUR VEHICLE 11

□ Event Data Recorder (EDR)	73
□ Child Restraints	74
■ Engine Break-In Recommendations	84
■ Safety Tips	84
□ Transporting Passengers	84
□ Exhaust Gas	85
□ Safety Checks You Should Make Inside The Vehicle	86
□ Periodic Safety Checks You Should Make Outside The Vehicle	88

A WORD ABOUT YOUR KEYS

The authorized dealer that sold you your new vehicle has the key code numbers for your vehicle locks. These numbers can be used to order duplicate keys. Ask your authorized dealer for these numbers and keep them in a safe place.

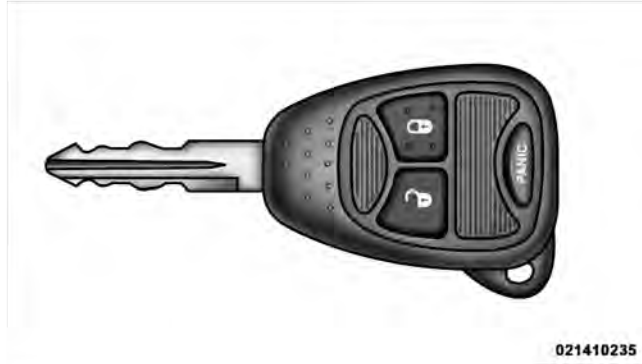

Vehicle Key

Ignition Key Removal

1. Place the shift lever in PARK (if equipped with an automatic transmission).
2. Turn the ignition switch to the ACC (Accessory) position.
3. Push the key and cylinder inward and rotate the key to the LOCK position.
4. Remove the key from the ignition switch lock cylinder.

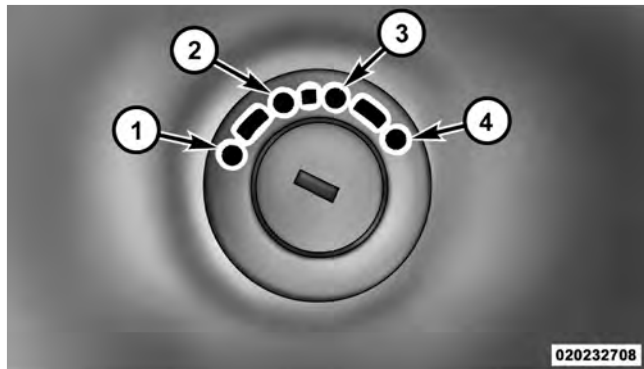

Ignition Switch Positions

- | | |
|---------------------|------------|
| 1 — LOCK | 3 — ON/RUN |
| 2 — ACC (ACCESSORY) | 4 — START |

NOTE: If you try to remove the key before you place the shift lever in PARK, the key may become trapped temporarily in the ignition switch cylinder. If this occurs, rotate the key to the right slightly, then remove the key as

described. If a malfunction occurs, the system will trap the key in the ignition cylinder to warn you that this safety feature is inoperable. The engine can be started and stopped but the key cannot be removed until you obtain service.

2

WARNING!

- Never leave children alone in a vehicle. Leaving unattended children in a vehicle is dangerous for a number of reasons. A child or others could be seriously or fatally injured. Don't leave the keys in the ignition. A child could operate power windows, other controls, or move the vehicle.
- Do not leave children or animals inside parked vehicles in hot weather. Interior heat build-up may cause serious injury or death.

CAUTION!

An unlocked car is an invitation to thieves. Always remove the key from the ignition and lock all the doors when leaving the vehicle unattended.

Locking Doors With A Key

You can insert the key with either side up. To lock the door, turn the key to the right. To unlock the door, turn the key to the left. Refer to “Maintenance Procedures” in “Maintaining Your Vehicle” for further information.

Key-In-Ignition Reminder

Opening the driver’s door when the key is in the ignition and the ignition position is LOCK or ACC, sounds a signal to remind you to remove the key.

NOTE: With the driver’s door open and the key in the ignition, the power door locks will not lock and Remote Keyless Entry (RKE) transmitter will not function.

SENTRY KEY®

The Sentry Key® Immobilizer System prevents unauthorized vehicle operation by disabling the engine. The system does not need to be armed or activated. Operation is automatic, regardless of whether the vehicle is locked or unlocked.

The system uses ignition keys that have an embedded electronic chip (transponder) to prevent unauthorized vehicle operation. Therefore, only keys that are programmed to the vehicle can be used to start and operate the vehicle. The system will shut the engine off in two seconds if someone uses an invalid key to try to start the engine.

NOTE: A key that has not been programmed is also considered an invalid key, even if it is cut to fit the ignition switch lock cylinder for that vehicle.

During normal operation, after turning on the ignition switch, the Vehicle Security Light will turn on for three

seconds for a bulb check. If the light remains on after the bulb check, it indicates that there is a problem with the electronics. In addition, if the Vehicle Security Light begins to flash after the bulb check, it indicates that someone used an invalid key to try to start the engine. Either of these conditions will result in the engine being shut off after two seconds.

If the Vehicle Security Light turns on during normal vehicle operation (vehicle running for longer than 10 seconds), it indicates that there is a fault in the electronics. Should this occur, have the vehicle serviced as soon as possible by an authorized dealer.

CAUTION!

The Sentry Key® Immobilizer system is not compatible with some after-market remote starting systems. Use of these systems may result in vehicle starting problems and loss of security protection.

All of the keys provided with your new vehicle have been programmed to the vehicle electronics.

Replacement Keys

NOTE: Only keys that are programmed to the vehicle electronics can be used to start and operate the vehicle. Once a Sentry Key® is programmed to a vehicle, it cannot be programmed to any other vehicle.

CAUTION!

Always remove the Sentry Keys® from the vehicle and lock all doors when leaving the vehicle unattended.

At the time of purchase, the original owner is provided with a four-digit Personal Identification Number (PIN). Keep the PIN in a secure location. This number is required for authorized dealer replacement of keys. Duplication of keys may be performed at an authorized

dealer or by following the customer key programming procedure. This procedure consists of programming a blank key to the vehicle electronics. A blank key is one that has never been programmed.

NOTE: When having the Sentry Key® Immobilizer System serviced, bring all vehicle keys with you to an authorized dealer.

Customer Key Programming

If you have two valid Sentry Keys®, you can program new Sentry Keys® to the system by performing the following procedure:

1. Cut the additional Sentry Key® Transponder blank(s) to match the ignition switch lock cylinder key code.
2. Insert the first valid key into the ignition switch. Turn the ignition switch to the ON/RUN position for at least three seconds, but no longer than 15 seconds. Then, turn the ignition switch to the LOCK position and remove the first key.

3. Insert the second valid key into the ignition switch. Turn the ignition switch to the ON/RUN position within 15 seconds. After 10 seconds, a chime will sound. In addition, the Vehicle Security Light will begin to flash. Turn the ignition switch to the LOCK position and remove the second key.

4. Insert a blank Sentry Key® into the ignition switch. Turn the ignition switch to the ON/RUN position within 60 seconds. After 10 seconds, a single chime will sound. In addition, the Vehicle Security Light will stop flashing. To indicate that programming is complete, the Vehicle Security Light will turn on again for three seconds and then turn off.

The new Sentry Key® is programmed. **The Remote Keyless Entry (RKE) transmitter will also be programmed during this procedure.**

Repeat this procedure to program up to eight keys. If you do not have a programmed Sentry Key®, contact your authorized dealer for details.

NOTE: If a programmed key is lost, see your authorized dealer to have all remaining keys erased from the system's memory. This will prevent the lost key from starting your vehicle. The remaining keys must then be reprogrammed. All vehicle keys must be taken to an authorized dealer at the time of service to be reprogrammed.

General Information

The Sentry Key® system complies with FCC rules Part 15 and with RSS-210 of Industry Canada. Operation is subject to the following conditions:

- This device may not cause harmful interference.
- This device must accept any interference that may be received, including interference that may cause undesired operation.

VEHICLE SECURITY ALARM — IF EQUIPPED

This Vehicle Security Alarm monitors the doors, liftgate, and ignition switch for unauthorized operation.

When the alarm is activated, the interior switches for door locks are disabled. The Vehicle Security Alarm provides both audio and visual signals, the horn will sound, the headlights, park lamps and/or turn signals will flash repeatedly for three minutes. If the disturbance is still present (driver's door, passenger door, other doors, ignition) after three minutes, the parking lights and tail lights will flash for an additional 15 minutes.

To Arm The System

1. Remove the key from the ignition switch and get out of the vehicle.
2. Lock the door using either the power door LOCK switch or the Remote Keyless Entry (RKE) transmitter and close all doors.

18 THINGS TO KNOW BEFORE STARTING YOUR VEHICLE

3. The Vehicle Security Light in the instrument cluster will flash rapidly for approximately 16 seconds. This shows that the Vehicle Security Alarm is arming. During this period, if a door is opened, the ignition switch is turned to ON/RUN, or the power door locks are unlocked in any manner, the Vehicle Security Alarm will automatically disarm. After approximately 16 seconds, the Vehicle Security Light will flash slowly. This shows that the Vehicle Security Alarm is fully armed.

To Disarm The System

Press UNLOCK on the RKE transmitter, or insert the key into the ignition switch and turn the ignition switch to the ON/RUN position.

Vehicle Security Alarm Manual Override

The Vehicle Security Alarm will not arm if you lock the doors using the manual door lock plunger.

REMOTE KEYLESS ENTRY (RKE) — IF EQUIPPED

This system allows you to lock or unlock the doors and liftgate or activate the Panic Alarm from distances up to approximately 66 ft (20 m) using a hand-held Remote Keyless Entry (RKE) transmitter. The RKE transmitter does not need to be pointed at the vehicle to activate the system.

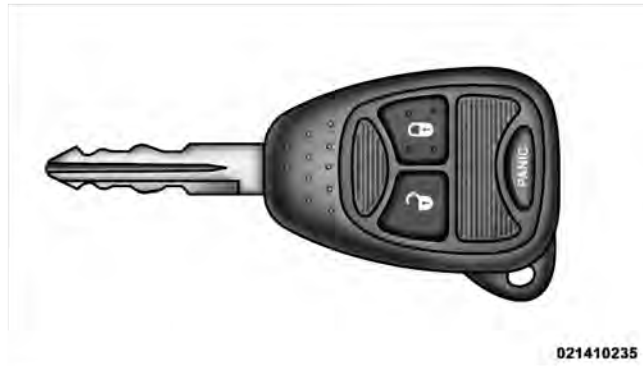

021410235

Three Button RKE Transmitter

NOTE: The line of transmission must not be blocked with metal objects.

To Unlock The Doors And Liftgate

Press and release the UNLOCK button on the RKE transmitter once to unlock the driver's door, or twice within five seconds to unlock all doors and liftgate. The turn signal lights will flash to acknowledge the unlock signal. The illuminated entry system will also turn on.

Remote Key Unlock, Driver Door/All First Press

This feature lets you program the system to unlock either the driver's door or all doors on the first press of the UNLOCK button on the RKE transmitter. To change the current setting, proceed as follows:

- For vehicles equipped with the Electronic Vehicle Information Center (EVIC), refer to "Electronic Vehicle Information Center (EVIC)/Personal Settings (Customer-Programmable Features)" in "Understanding Your Instrument Panel" for further information.

- For vehicles not equipped with the EVIC, perform the following steps:

1. Press and hold the LOCK button on a programmed RKE transmitter for at least 4 seconds, but no longer than 10 seconds. Then, press and hold the UNLOCK button while still holding the LOCK button.
2. Release both buttons at the same time.
3. Test the feature while outside of the vehicle by pressing the LOCK/UNLOCK buttons on the RKE transmitter with the ignition switch in the LOCK position and the key removed.
4. Repeat these steps if you want to return this feature to its previous setting.

NOTE: Pressing the LOCK button on the RKE transmitter while you are inside the vehicle will activate the Vehicle Security Alarm. Opening a door with the Vehicle Security Alarm activated will cause the alarm to sound. Press the UNLOCK button to deactivate the Vehicle Security Alarm.

Illuminated Approach — If Equipped

This feature activates the headlights for up to 90 seconds when the doors are unlocked with the RKE transmitter. The time for this feature is programmable on vehicles equipped with the EVIC. Refer to “Electronic Vehicle Information Center (EVIC)/Personal Settings (Customer-Programmable Features)” in “Understanding Your Instrument Panel” for further information.

NOTE: None of the courtesy lights will operate if the dimmer control is in the “defeat” position (extreme downward position), unless the overhead map/reading lights are turned on manually.

To Lock The Doors And Liftgate

Press and release the LOCK button on the RKE transmitter to lock all doors and liftgate. The turn signal lights will flash and the horn will chirp to acknowledge the signal.

Sound Horn With Remote Key Lock

This feature will cause the horn to chirp when the doors are locked with the RKE transmitter. This feature can be turned on or turned off. To change the current setting, proceed as follows:

- For vehicles equipped with the EVIC, refer to “Electronic Vehicle Information Center (EVIC)/Personal Settings (Customer-Programmable Features)” in “Understanding Your Instrument Panel” for further information.

- For vehicles not equipped with the EVIC, perform the following steps:
 1. Press the LOCK button on a programmed RKE transmitter for at least 4 seconds, but no longer than 10 seconds. Then, press the PANIC button while still holding the LOCK button.
 2. Release both buttons at the same time.
 3. Test the feature while outside of the vehicle by pressing the LOCK button on the RKE transmitter with the ignition switch in the LOCK position and the key removed.
 4. Repeat these steps if you want to return this feature to its previous setting.

NOTE: Pressing the LOCK button on the RKE transmitter while you are in the vehicle will activate the Vehicle Security Alarm. Opening a door with the Vehicle Security Alarm activated will cause the alarm to sound. Press the UNLOCK button to deactivate the Vehicle Security Alarm.

Flash Lights With Remote Key Lock/Unlock

This feature will cause the turn signal lights to flash when the doors are locked or unlocked with the RKE transmitter. This feature can be turned on or turned off. To change the current setting, proceed as follows:

- For vehicles equipped with the EVIC, refer to “Electronic Vehicle Information Center (EVIC)/Personal Settings (Customer-Programmable Features)” in “Understanding Your Instrument Panel” for further information.

22 THINGS TO KNOW BEFORE STARTING YOUR VEHICLE

- For vehicles not equipped with the EVIC, perform the following steps:
 1. Press and hold the UNLOCK button on a programmed RKE transmitter for at least 4 seconds, but no longer than 10 seconds. Then, press and hold the LOCK button while still holding the UNLOCK button.
 2. Release both buttons at the same time.
 3. Test the feature while outside of the vehicle by pressing the LOCK/UNLOCK buttons on the RKE transmitter with the ignition switch in the LOCK position and the key removed.
 4. Repeat these steps if you want to return this feature to its previous setting.

NOTE: Pressing the LOCK button on the RKE transmitter while you are in the vehicle will activate the Vehicle Security Alarm. Opening a door with the Vehicle Security

Alarm activated will cause the alarm to sound. Press the UNLOCK button to deactivate the Vehicle Security Alarm.

Using The Panic Alarm

To turn the Panic Alarm feature ON or OFF, press and hold the PANIC button on the RKE transmitter for at least one second and release. When the Panic Alarm is on, the headlights and park lights will flash, the horn will pulse on and off and the interior lights will turn on.

The Panic Alarm will stay on for three minutes unless you turn it off by pressing the PANIC button a second time or if the vehicle speed is 5 mph (8 km/h) or greater.

NOTE: When you turn off the Panic Alarm by pressing the PANIC button a second time, you may have to move closer to the vehicle due to the radio frequency noises of the system.

Programming Additional Transmitters

Refer to Sentry Key® “Customer Key Programming.”

If you do not have a programmed RKE transmitter, contact your authorized dealer for details.

General Information

This device complies with Part 15 of FCC rules and with RS-210 of Industry Canada. Operation is subject to the following conditions:

1. This device may not cause harmful interference.
2. This device must accept any interference that may be received including interference that may cause undesired operation.

NOTE: Changes or modifications not expressly approved by the party responsible for compliance could void the user’s authority to operate the equipment.

If your RKE transmitter fails to operate from a normal distance, check for these two conditions:

1. Weak battery in the RKE transmitter. The expected life of a battery is five years.
2. Closeness to a radio transmitter such as a radio station tower, airport transmitter, military base, and some mobile or CB radios.

Transmitter Battery Replacement

NOTE: Perchlorate Material – special handling may apply. See www.dtsc.ca.gov/hazardouswaste/perchlorate
The recommended replacement battery is CR2032.

24 THINGS TO KNOW BEFORE STARTING YOUR VEHICLE

1. If the RKE transmitter is equipped with a screw, remove the screw. With the RKE transmitter buttons facing down, use a flat blade screwdriver to pry the two halves of the RKE transmitter apart. Make sure not to damage the elastomer seal during removal.

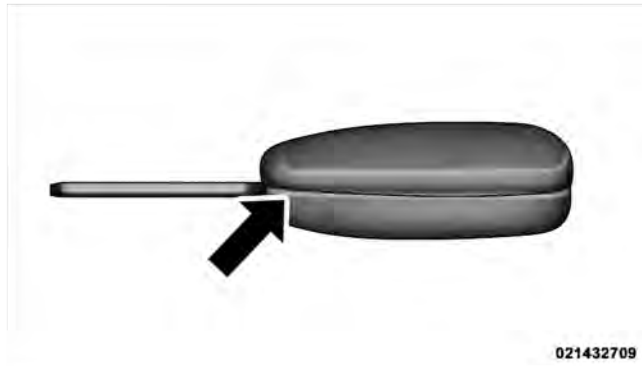

Separating Case Halves

021432709

2. Remove and replace the battery. Avoid touching the new battery with your fingers. Skin oils may cause battery deterioration. If you touch a battery, clean it with rubbing alcohol.

3. To reassemble the RKE transmitter case, snap the two halves together.

NOTE: If the RKE transmitter is equipped with a screw, reinstall and tighten the screw until snug.

REMOTE STARTING SYSTEM — IF EQUIPPED

This system uses the Remote Keyless Entry (RKE) transmitter to start the engine conveniently from outside the vehicle while still maintaining security. The system has a range of approximately 300 ft (91 m).



NOTE: The vehicle must be equipped with an automatic transmission to be equipped with Remote Start.

How To Use Remote Start

All of the following conditions must be met before the engine will remote start:

- Shift lever in PARK
- Doors closed
- Hood closed
- Hazard switch off
- Brake switch inactive (brake pedal not pressed)
- Ignition key removed from ignition switch
- Battery at an acceptable charge level
- RKE PANIC button not pressed
- System not disabled from previous remote start event
- Vehicle theft alarm not active

WARNING!

- Do not start or run an engine in a closed garage or confined area. Exhaust gas contains Carbon Monoxide (CO) which is odorless and colorless. Carbon Monoxide is poisonous and can cause serious injury or death when inhaled.
- Keep Remote Keyless Entry (RKE) transmitters away from children. Operation of the Remote Start System, windows, door locks or other controls could cause serious injury or death.

Remote Start Abort Message On Electronic Vehicle Information Center (EVIC) — If Equipped

The following messages will display in the EVIC if the vehicle fails to remote start or exits remote start prematurely:

- Remote Start Aborted - Door Ajar

26 THINGS TO KNOW BEFORE STARTING YOUR VEHICLE

- Remote Start Aborted - Hood Ajar
- Remote Start Aborted - Fuel Low
- Remote Start Aborted - System Fault

The EVIC message stays active until the ignition is turned to the ON/RUN position.

To Enter Remote Start

 Press and release the REMOTE START button on the RKE transmitter twice within five seconds. The parking lights will flash and the horn will chirp twice (if programmed). Then, the engine will start and the vehicle will remain in the Remote Start mode for a 15-minute cycle.

NOTE:

- The park lamps will turn on and remain on during Remote Start mode.

- For security, power window and power sunroof operation (if equipped) are disabled when the vehicle is in the Remote Start mode.
- The engine can be started two consecutive times (two 15-minute cycles) with the RKE transmitter. However, the ignition switch must be cycled to the ON/RUN position before you can repeat the start sequence for a third cycle.

Remote start will also cancel if any of the following occur:

- The engine stalls or RPM exceeds 2500
- Any engine warning lamps come on
- Fuel lamp turns on
- The hood is opened
- The hazard switch is pressed
- The transmission is moved out of PARK
- The brake pedal is pressed

To Exit Remote Start Mode Without Driving The Vehicle

Press and release the REMOTE START button one time, or allow the engine to run for the entire 15-minute cycle.

NOTE: To avoid unintentional shut downs, the system will disable the one time press of the REMOTE START button for two seconds after receiving a valid Remote Start request.

To Exit Remote Start Mode And Drive The Vehicle

Before the end of the 15-minute cycle, press and release the UNLOCK button on the RKE transmitter to unlock the doors and disarm the Vehicle Security Alarm (if equipped). Then, insert the key into the ignition switch and turn the switch to the ON/RUN position.

NOTE: The ignition switch must be in the ON/RUN position in order to drive the vehicle.

DOOR LOCKS

The power door locks can be manually locked or unlocked from inside the vehicle by using the door lock knob. If the lock knob is down when the door is closed, the door will lock. Therefore, make sure the key is not inside the vehicle before closing the door.

2



Manual Door Lock Knob

WARNING!

- Do not leave children or animals inside parked vehicles in hot weather. Interior heat build-up may cause serious injury or death.
- For personal security and safety in the event of an accident, lock the vehicle doors as you drive as well as when you park and leave the vehicle.
- When leaving the vehicle, always remove the key from the ignition lock and lock your vehicle. Do not leave unattended children in the vehicle or with access to an unlocked vehicle. Unsupervised use of vehicle equipment may cause severe personal injuries or death.

CAUTION!

An unlocked vehicle is an invitation to thieves. Always remove the key from the ignition and lock all of the doors when leaving the vehicle unattended.

Power Door Locks

A power door lock switch is on each front door trim panel. Press this switch to lock or unlock the doors and liftgate.

NOTE: To prevent from locking the key in the vehicle, the power door lock switch will not operate when the key is in the ignition and either front door is open. A chime will sound as a reminder to remove the key.



Driver Power Door Lock Switch

1 - Unlock

2 - Lock

Automatic Door Locks — If Equipped

The doors will lock automatically on vehicles with power door locks if all of the following conditions are met:

1. The Auto Lock feature is enabled.

2. The transmission is in gear.
3. All doors are closed.
4. The throttle is pressed.
5. The vehicle speed is above 15 mph (24 km/h).
6. The doors were not previously locked using the power door lock switch or Remote Keyless Entry (RKE) transmitter.

Automatic Door Locks Programming

The Automatic Door Locks feature can be enabled or disabled as follows:

- For vehicles equipped with the Electronic Vehicle Information Center (EVIC), refer to “Electronic Vehicle Information Center (EVIC) — If Equipped/Personal Settings (Customer-Programmable Features)” in “Understanding Your Instrument Panel” for further information.

30 THINGS TO KNOW BEFORE STARTING YOUR VEHICLE

- For vehicles not equipped with the EVIC, perform the following procedure:
 1. Close all doors and place the key in the ignition switch.
 2. Within 15 seconds, cycle the ignition switch between LOCK and ON/RUN and then back to LOCK four times ending up in the LOCK position (do not start the engine).
 3. Within 30 seconds, press the power door LOCK switch to lock the doors.
 4. A single chime will indicate the completion of the programming.
 5. Repeat these steps if you want to return this feature to its previous setting.

NOTE:

- If you do not hear the chime it means that the system did not enter the programming mode and you will need to repeat the procedure.
- Use the Automatic Door Locks feature in accordance with local laws.

Automatic Unlock Doors On Exit

The doors will unlock automatically if:

1. The Automatic Unlock Doors On Exit feature is enabled.
2. The transmission was in gear and the vehicle speed returned to 0 mph (0 km/h).
3. The transmission is in NEUTRAL or PARK.
4. The driver's door is opened.
5. The doors were not previously unlocked.

Automatic Unlock Doors On Exit Programming

The Automatic Unlock Doors On Exit feature can be enabled or disabled as follows:

- For vehicles equipped with the EVIC, refer to “Electronic Vehicle Information Center (EVIC)/Personal Settings (Customer-Programmable Features)” in “Understanding Your Instrument Panel” for further information.
- For vehicles not equipped with the EVIC, perform the following procedure:
 1. Close all doors and place the key in the ignition.
 2. Within 15 seconds, cycle the ignition switch between LOCK and ON/RUN and then back to LOCK four times ending up in the LOCK position (do not start the engine).
 3. Within 30 seconds, press the power door UNLOCK switch to unlock the doors.

4. A single chime will indicate the completion of the programming.

5. Repeat these steps if you want to return this feature to its previous setting.

NOTE:

- If you do not hear the chime it means that the system did not enter the programming mode and you will need to repeat the procedure.
- Use the Automatic Unlock Doors On Exit feature in accordance with local laws.

Child-Protection Door Lock System (Rear Doors) — If Equipped

To provide a safer environment for small children riding in the rear seats, the rear doors are equipped with Child-Protection Door Lock system.

To Engage Or Disengage The Child-Protection Door Lock System

1. Open the rear door.
2. Insert the tip of the ignition key into the lock and rotate to the LOCK or UNLOCK position.
3. Repeat steps 1 and 2 for the opposite rear door.

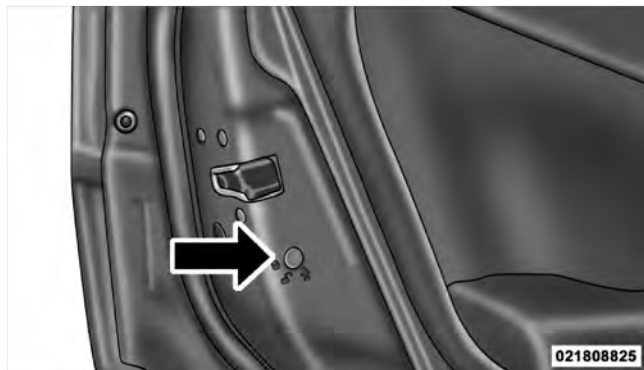

Child-Protection Door Lock Location



Child-Protection Door Lock Function

WARNING!

Avoid trapping anyone in a vehicle in a collision. Remember that the rear doors can only be opened from the outside when the Child-Protection locks are engaged.

NOTE: For emergency exit with the system engaged, move the lock knob up (unlocked position), roll down the window and open the door with the outside door handle.

POWER WINDOWS — IF EQUIPPED

Power Window Switches

The window controls on the driver's door trim panel control all the door windows. There are single window controls on each passenger door trim panel, which operate the passenger door windows. The window controls will operate when the ignition switch is in the ON/RUN or ACC position.

NOTE:

- For vehicles not equipped with the Electronic Vehicle Information Center (EVIC), the power window switches will remain active for 45 seconds after the ignition switch is turned to the LOCK position. Opening either front door will cancel this feature.
- For vehicles equipped with the EVIC, the power window switches will remain active for up to 10 minutes after the ignition switch is turned to the LOCK position. Opening either front door will cancel this feature. The time for this feature is programmable. Refer to "Electronic Vehicle Information Center (EVIC)/Personal Settings (Customer-Programmable Features)" in "Understanding Your Instrument Panel" for further information.

WARNING!

Never leave children in a vehicle with the key in the ignition switch. Occupants, particularly unattended children, can become entrapped by the windows while operating the power window switches. Such entrapment may result in serious injury or death.



Power Window Switch Location

Auto-Down

The driver's door window switch has an Auto-Down feature. Push the window switch past the first detent, release, and the window will go down automatically. To cancel the Auto-Down movement, operate the switch in either the up or down direction and release the switch.

Window Lockout Switch

The window lockout switch on the driver's door allows you to disable the window control on the other doors. To disable the window controls on the other doors, press the window LOCKOUT switch. To enable the window controls, press the window LOCKOUT switch a second time.



Window Lockout Switch

LIFTGATE

NOTE: The key that is used to start your vehicle is also used to lock or unlock the doors and open the liftgate.

To unlock the liftgate, insert the key into the lock and turn it to the right (manual lock models only). The liftgate can also be unlocked using the Remote Keyless Entry (RKE) transmitter or by activating the power door lock switches located on the front doors. The central locking/unlocking feature (if equipped) can also be activated from the liftgate key cylinder.

Once unlocked, the liftgate can be opened or closed without using the key. To open the liftgate, squeeze the liftgate release and pull the liftgate open with one fluid motion.



022210243

Liftgate Handle

NOTE:

- In the event of a power malfunction, or the RKE transmitter is inoperative, insert the key into the liftgate lock cylinder and turn it to the right (manual lock models only). Using the liftgate handle, pull the liftgate open with one fluid motion.
- Although the liftgate has no inside release mechanism, the liftgate trim panel includes an opening with a snap-in cap that provides access to release the latch in the event of an electrical system malfunction.

WARNING!

- Driving with the liftgate open can allow poisonous exhaust gases into your vehicle. You and your passengers could be injured by these fumes. Keep the liftgate closed when you are operating the vehicle.

(Continued)

WARNING! (Continued)

- If you are required to drive with the liftgate open, make sure that all windows are closed, and the climate control blower switch is set at high speed. Do not use the recirculation mode.

Gas props support the liftgate in the open position. However, because the gas pressure drops with temperature, it may be necessary to assist the props when opening the liftgate in cold weather.

OCCUPANT RESTRAINTS

Some of the most important safety features in your vehicle are the restraint systems:

- Three-point lap and shoulder belts for all seating positions
- Advanced Front Air Bags for driver and front passenger

- Supplemental Active Head Restraints (AHR) located on top of the front seats (integrated into the head restraint)
- Supplemental Driver Side Knee Air Bag
- Supplemental Side Air Bag Inflatable Curtains (SABIC) for the driver and passengers seated next to a window
- Supplemental Seat-Mounted Side Air Bags (SAB) — if equipped
- An energy-absorbing steering column and steering wheel
- Knee bolsters/blockers for front seat occupants
- Front seat belts incorporate pretensioners that may enhance occupant protection by managing occupant energy during an impact event — if equipped

38 THINGS TO KNOW BEFORE STARTING YOUR VEHICLE

- All seat belt systems (except the driver's) include Automatic Locking Retractors (ALRs), which lock the seat belt webbing into position by extending the belt all the way out and then adjusting the belt to the desired length to restrain a child seat or secure a large item in a seat — if equipped

Please pay close attention to the information in this section. It tells you how to use your restraint system properly, to keep you and your passengers as safe as possible.

If you will be carrying children too small for adult-sized seat belts, the seat belts or the Lower Anchors and Tether for CHildren (LATCH) feature also can be used to hold infant and child restraint systems. For more information on LATCH, refer to Lower Anchors and Tether for CHildren (LATCH).

Here are some simple steps you can take to minimize the risk of harm from a deploying air bag:

1. **Children 12 years old and under should always ride buckled up in a rear seat.**

WARNING!

Infants in rear facing child restraints should never ride in the front seat of a vehicle with a passenger Advanced Front Air Bag. An air bag deployment can cause severe injury or death to infants in that position.

Children that are not big enough to wear the vehicle seat belt properly (see section on Child Restraints) should be secured in the rear seat in child restraints or belt-positioning booster seats. Older children who do not use child restraints or belt-positioning booster seats should

ride properly buckled up in the rear seat. Never allow children to slide the shoulder belt behind them or under their arm.

If a child from 1 to 12 years old (not in a rear facing child seat) must ride in the front passenger seat, move the seat as far back as possible and use the proper child restraint. (Refer to “Child Restraints”)

You should read the instructions provided with your child restraint to make sure that you are using it properly.

- 2. All occupants should always wear their lap and shoulder belts properly.**
- 3. The driver and front passenger seats should be moved back as far as practical to allow the Advanced Front Air Bags room to inflate.**

4. Do not lean against the door or window. Your vehicle has Supplemental Side Air Bag Inflatable Curtains (SABIC) or Supplemental Seat-Mounted Side Air Bags (SAB), and deployment occurs, the SABIC and SAB air bags will inflate forcefully into the space between you and the door.

5. If the air bag system in this vehicle needs to be modified to accommodate a disabled person, contact the Customer Center. Phone numbers are provided under “If You Need Assistance”.

WARNING!

- Relying on the air bags alone could lead to more severe injuries in a collision. The air bags work with your seat belt to restrain you properly. In some collisions, the air bags won't deploy at all. Always wear your seat belts even though you have air bags.
- Being too close to the steering wheel or instrument panel during Advanced Front Air Bag deployment could cause serious injury, including death. Air Bags need room to inflate. Sit back, comfortably extending your arms to reach the steering wheel or instrument panel.

(Continued)

WARNING! (Continued)

- Supplemental Side Air Bag Inflatable Curtain (SABIC) and Seat-Mounted Side Air Bags (SAB) also need room to inflate. Do not lean against the door or window. Sit upright in the center of the seat.
- In an accident, you and your passengers can suffer much greater injuries if you are not properly buckled up. You can strike the interior of your vehicle or other passengers, or you can be thrown out of the vehicle. Always be sure you and others in your vehicle are buckled up properly.

Buckle up even though you are an excellent driver, even on short trips. Someone on the road may be a poor driver and cause an accident that includes you. This can happen far away from home or on your own street.

Research has shown that seat belts save lives, and they can reduce the seriousness of injuries in an accident. Some of the worst injuries happen when people are thrown from the vehicle. Seat belts reduce the possibility of ejection and the risk of injury caused by striking the inside of the vehicle. Everyone in a motor vehicle should be belted at all times.

Lap/Shoulder Belts

All the seating positions in your vehicle are equipped with combination lap/shoulder belts.

The belt webbing retractor is designed to lock during very sudden stops or accidents. This feature allows the shoulder part of the belt to move freely with you under normal conditions. However in a collision, the belt will lock and reduce the risk of you striking the inside of the vehicle or being thrown out.

WARNING!

- **It is dangerous to ride in a cargo area, inside or outside of a vehicle. In an accident, people riding in these areas are more likely to be seriously injured or killed.**
- **Do not allow people to ride in any area of your vehicle that is not equipped with seats and seat belts.**
- **Be sure everyone in your vehicle is in a seat and using a seat belt properly.**
- **Wearing a seat belt incorrectly is dangerous. Seat belts are designed to go around the large bones of your body. These are the strongest parts of your body and can take the forces of an accident the best.**

(Continued)

WARNING! (Continued)

- Wearing your belt in the wrong place could make your injuries in an accident much worse. You might suffer internal injuries, or you could even slide out of part of the belt. Follow these instructions to wear your seat belt safely and to keep your passengers safe, too.
- Two people should never be belted into a single seat belt. People belted together can crash into one another in an accident, hurting one another badly. Never use a lap/shoulder belt or lap belt for more than one person, no matter what their size.

Lap/Shoulder Belt Operating Instructions

1. Enter the vehicle and close the door. Sit back and adjust the seat.

2. The seat belt latch plate is along side the pillar near the back of your seat. Grasp the latch plate and pull out the belt. Slide the latch plate up the webbing as far as necessary to allow the belt to go around your lap.

**Pulling Out The Latch Plate**

3. When the belt is long enough to fit, insert the latch plate into the buckle until you hear a “click.”



Inserting Latch Plate Into Buckle

WARNING!

- A belt that is buckled into the wrong buckle will not protect you properly. The lap portion could ride too high on your body, possibly causing internal injuries. Always buckle your belt into the buckle nearest you.
- A belt that is too loose will not protect you properly. In a sudden stop you could move too far forward, increasing the possibility of injury. Wear your seat belt snugly.

(Continued)

WARNING! (Continued)

- A belt that is worn under your arm is dangerous. Your body could strike the inside surfaces of the vehicle in an accident, increasing head and neck injury. A belt worn under the arm can cause internal injuries. Ribs aren't as strong as shoulder bones. Wear the belt over your shoulder so that your strongest bones will take the force in a collision.
- A shoulder belt placed behind you will not protect you from injury during an accident. You are more likely to hit your head in a collision if you do not wear your shoulder belt. The lap and shoulder belt are meant to be used together.

4. Position the lap belt across your thighs, below your abdomen. To remove slack in the lap belt portion, pull up on the shoulder belt. To loosen the lap belt if it is too tight, tilt the latch plate and pull on the lap belt. A snug belt reduces the risk of sliding under the belt in an accident.



Positioning Lap Belt

WARNING!

- A lap belt worn too high can increase the risk of internal injury in an accident. The belt forces won't be at the strong hip and pelvic bones, but across your abdomen. Always wear the lap belt as low as possible and keep it snug.
- A twisted belt will not protect you properly. In a collision, it could even cut into you. Be sure the belt is straight. If you can't straighten a belt in your vehicle, take it to your authorized dealer immediately and have it fixed.

5. Position the shoulder belt on your chest so that it is comfortable and not resting on your neck. The retractor will withdraw any slack in the belt.

6. To release the belt, push the red button on the buckle. The belt will automatically retract to its stowed position. If necessary, slide the latch plate down the webbing to allow the belt to retract fully.

WARNING!

A frayed or torn belt could rip apart in an accident and leave you with no protection. Inspect the belt system periodically, checking for cuts, frays, or loose parts. Damaged parts must be replaced immediately. Do not disassemble or modify the system. Seat belt assemblies must be replaced after an accident if they have been damaged (bent retractor, torn webbing, etc.).

Adjustable Upper Shoulder Belt Anchorage

In the driver and front passenger seat, the shoulder belt can be adjusted upward or downward to position the belt away from your neck. Push the anchorage button to release the anchorage, and move it up or down to the position that fits you best.

NOTE: The adjustable upper shoulder belt anchorage is equipped with an Easy Up feature. This feature allows the shoulder belt anchorage to be adjusted in the upward position without pressing the release button. To verify the shoulder belt anchorage is latched, pull downward on the shoulder belt anchorage until it is locked into position.



Adjustable Anchorage

As a guide, if you are shorter than average, you will prefer a lower position, and if you are taller than average, you will prefer a higher position. When you release the anchorage, try to move it down to make sure that it is locked in position. In the rear seat, move toward the center of the seat to position the belt away from your neck.

Lap/ Shoulder Belt Operating Instructions With A Mini-Latch And Buckle

A three point seat belt with a mini-latch and buckle, allows the shoulder belt to detach from the lower anchor when the seat is folded. The mini-buckle and shoulder belt can then be stored out of the way in the right side trim panel for added convenience.

1. Remove the mini-latch and regular latch from its stowed position in the right rear side trim panel.

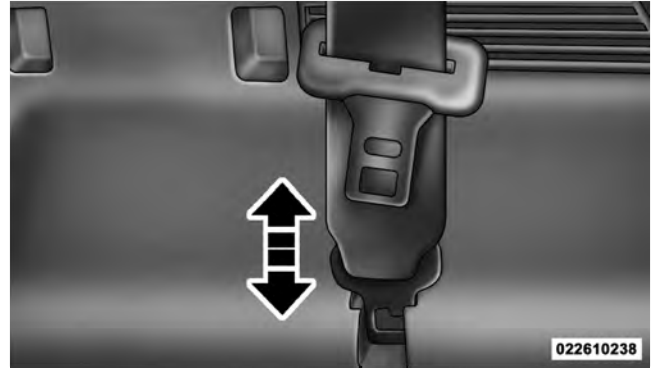

Mini-Latch Stowage

2. Grasp the mini-latch plate and pull the belt over the seat.

48 THINGS TO KNOW BEFORE STARTING YOUR VEHICLE

3. Route the shoulder belt to the inside of the right head restraint.



Routing The Rear Center Shoulder Belt

4. When the belt is long enough to fit, insert the mini-latch plate into the mini-buckle until you hear a “click.”

5. Sit back in seat. Slide the regular latch plate up the webbing as far as necessary to allow the belt to go around your lap.

6. When the belt is long enough to fit, insert the latch plate into the buckle until you hear a “click.”

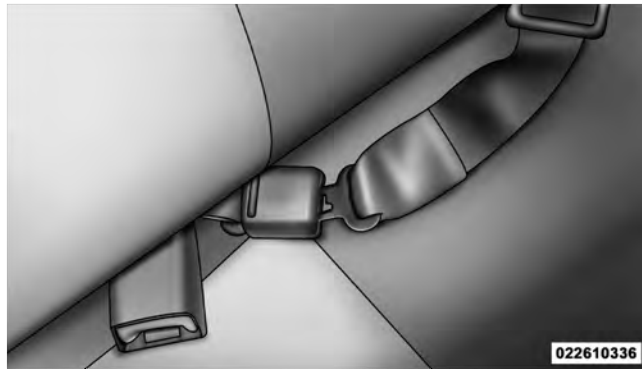

Connecting Mini-Latch To Buckle

7. Position the lap belt across your thighs, below your abdomen. To remove slack in the lap belt portion, pull up on the shoulder belt. To loosen the lap belt if it is too tight, pull on the lap belt. A snug belt reduces the risk of sliding under the belt in an accident.

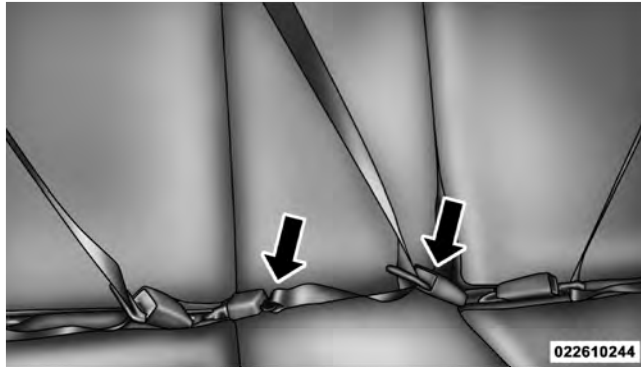

Rear Center Seat Belt Buckled

8. Position the shoulder belt on your chest so that it is comfortable and not resting on your neck. The retractor will withdraw any slack in the belt.

9. To release the belt, push the red button on the buckle.

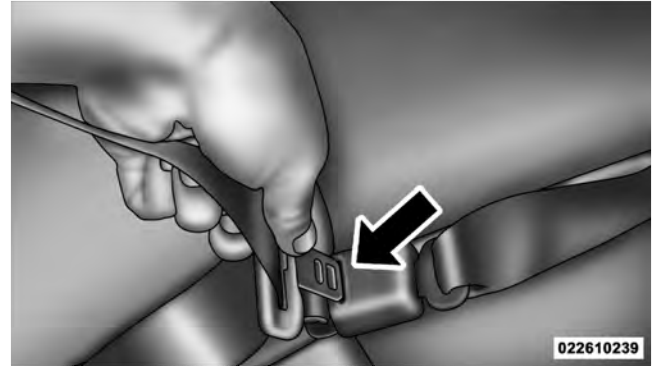

Detaching Mini-Latch And Buckle

10. To disengage the mini-latch from the mini-buckle for storage, insert the regular latch plate into the black

button on the top of the mini-buckle. The belt will automatically retract to its stowed position. If necessary, slide the latch plate down the webbing to allow the belt to retract fully. Insert the mini-latch plate into the slot provided in the trim panel.

Lap/Shoulder Belt Untwisting Procedure

Use the following procedure to untwist a twisted lap/shoulder belt.

1. Position the latch plate as close as possible to the anchor point.
2. At about 6 to 12 in (15 to 30 cm) above the latch plate, grasp and twist the belt webbing 180 degrees to create a fold that begins immediately above the latch plate.
3. Slide the latch plate upward over the folded webbing. The folded webbing must enter the slot at the top of the latch plate.

4. Continue to slide the latch plate up until it clears the folded webbing.

Seat Belts In Passenger Seating Positions

The seat belts in the passenger seating positions are equipped with an Automatic Locking Retractor (ALR) which are used to secure a child restraint system. For additional information, refer to “Installing Child Restraints Using The Vehicle Seat Belt” under the “Child Restraints” section. The chart below defines the type of feature for each seating position.

	Driver	Center	Passenger
First Row	N/A	N/A	ALR
Second Row	ALR	ALR	ALR
Third Row	N/A	N/A	ALR

- N/A — Not Applicable
- ALR — Automatic Locking Retractor

If the passenger seating position is equipped with an ALR and is being used for normal usage:

Only pull the belt webbing out far enough to comfortably wrap around the occupant's mid-section so as to not activate the ALR. If the ALR is activated, you will hear a ratcheting sound as the belt retracts. Allow the webbing to retract completely in this case and then carefully pull out only the amount of webbing necessary to comfortably wrap around the occupant's mid-section. Slide the latch plate into the buckle until you hear a "click."

Automatic Locking Retractor Mode (ALR) — If Equipped

In this mode, the shoulder belt is automatically pre-locked. The belt will still retract to remove any slack in the shoulder belt. The Automatic Locking Mode is available on all passenger-seating positions with a combination lap/shoulder belt. Use the Automatic Locking Mode

anytime a child safety seat is installed in a seating position that has a belt with this feature. Children 12 years old and under should always be properly restrained in the rear seat.

How To Engage The Automatic Locking Mode

1. Buckle the combination lap and shoulder belt.
2. Grasp the shoulder portion and pull downward until the entire belt is extracted.
3. Allow the belt to retract. As the belt retracts, you will hear a clicking sound. This indicates the safety belt is now in the Automatic Locking Mode.

How To Disengage The Automatic Locking Mode

Unbuckle the combination lap/shoulder belt and allow it to retract completely to disengage the Automatic Locking Mode and activate the vehicle sensitive (emergency) locking mode.

WARNING!

- **The belt and retractor assembly must be replaced if the seat belt assembly Automatic Locking Retractor (ALR) feature or any other seat belt function is not working properly when checked according to the procedures in the Service Manual.**
- **Failure to replace the belt and retractor assembly could increase the risk of injury in collisions.**

Seat Belt Pretensioners — If Equipped

The seat belts for both front seating positions may be equipped with pretensioning devices that are designed to remove slack from the seat belt in the event of an accident. These devices may improve the performance of the seat belt by assuring that the belt is tight about the occupant early in an accident. Pretensioners work for all size occupants, including those in child restraints.

NOTE: These devices are not a substitute for proper seat belt placement by the occupant. The seat belt still must be worn snugly and positioned properly.

The pretensioners are triggered by the Occupant Restraint Controller (ORC). Like the air bags, the pretensioners are single use items. A deployed pretensioner or a deployed air bag must be replaced immediately.

Energy Management Feature

This vehicle has a safety belt system with an Energy Management feature in the front seating positions to help further reduce the risk of injury in the event of a head-on accident. This safety belt system has a retractor assembly that is designed to release webbing in a controlled manner. This feature is designed to help reduce the belt force acting on the occupant's chest.

WARNING!

- **The belt and retractor assembly must be replaced if the seat belt assembly Automatic Locking Retractor (ALR) feature or any other seat belt function is not working properly when checked according to the procedures in the Service Manual.**
- **Failure to replace the belt and retractor assembly could increase the risk of injury in accidents.**

Supplemental Active Head Restraints (AHR)

These head restraints are passive, deployable components, and vehicles with this equipment cannot be readily identified by any markings, only through visual inspection of the head restraint. The head restraint will be split in two halves, with the front half being soft foam and trim, the back half being decorative plastic.

How The Active Head Restraints (AHR) Work

The Occupant Restraint Controller (ORC) determines whether the severity, or type of rear impact will require the Active Head Restraints (AHR) to deploy. If a rear impact requires deployment, both the driver and front passenger seat AHRs will be deployed.

When AHRs deploy during a rear impact, the front half of the head restraint extends forward to minimize the gap between the back of the occupant's head and the AHR.

54 THINGS TO KNOW BEFORE STARTING YOUR VEHICLE

This system is designed to help prevent or reduce the extent of injuries to the driver and front passenger in certain types of rear impacts.

NOTE: The Active Head Restraints (AHR) may or may not deploy in the event of a front or side impact. However if during a front impact, a secondary rear impact occurs, the AHR may deploy based on the severity and type of the impact.

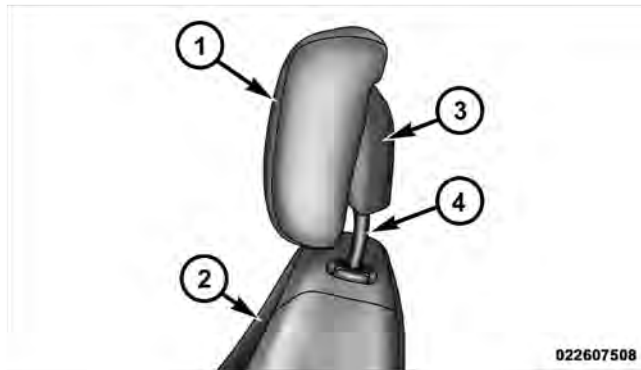

022607508

Active Head Restraint (AHR) Components

- | | |
|---|--|
| 1 — Head Restraint Front Half
(Soft Foam and Trim) | 3 — Head Restraint Back Half
(Decorative Plastic Rear
Cover) |
| 2 — Seatback | 4 — Head Restraint Guide
Tubes |

CAUTION!

All occupants, including the driver, should not operate a vehicle or sit in a vehicle's seat until the head restraints are placed in their proper positions in order to minimize the risk of neck injury in the event of an accident.

NOTE: For more information on properly adjusting and positioning the head restraint, refer to "Adjusting Active Head Restraints" in "Understanding The Features Of Your Vehicle".

Resetting Active Head Restraints (AHR)

If the Active Head Restraints are triggered in an accident, you must reset the head restraint on the driver's and front passenger seat. You can recognize when the Active Head Restraint has been triggered by the fact that they have moved forward (as shown in step three of the resetting procedure).

1. Grasp the deployed AHR from the rear seat.



Hand Positioning Points On AHR

2. Position the hands on the top of the deployed AHR at a comfortable position.

56 THINGS TO KNOW BEFORE STARTING YOUR VEHICLE

3. Pull **down** then **rearward** towards the rear of the vehicle then **down** to engage the locking mechanism.

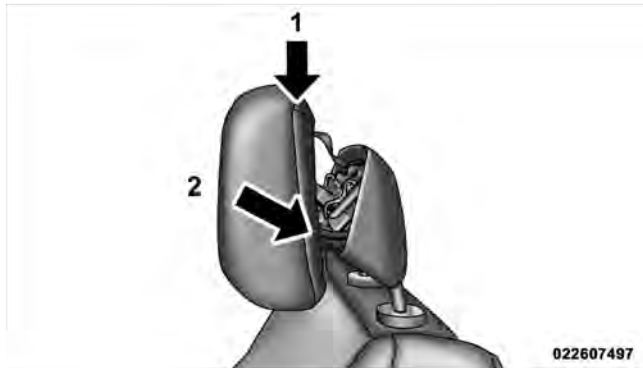

- 1 — Downward Movement
- 2 — Rearward Movement

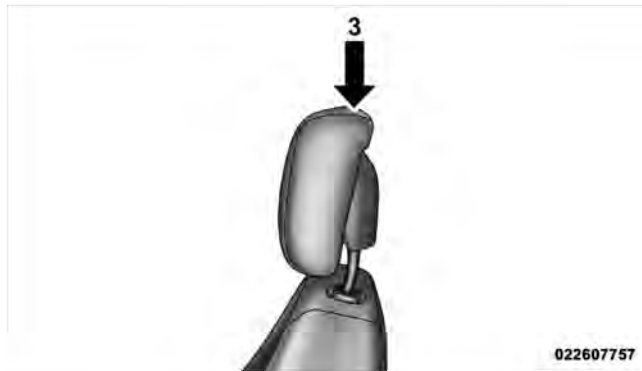

3 — Final Downward Movement To Engage Locking Mechanism

4. The AHR front soft foam and trim half should lock into the back decorative plastic half.



022607494

AHR In Reset Position

NOTE:

- If you have difficulties or problems resetting the Active Head Restraints, see an authorized dealer.
- For safety reasons, have the Active Head Restraints checked by a qualified specialist at an authorized dealer.

Enhanced Seat Belt Use Reminder System (BeltAlert®)

BeltAlert® is a feature intended to remind the driver and front passenger (if equipped with front passenger BeltAlert®) to fasten their seat belts. This feature is active whenever the ignition is on. If the driver or front seat passenger is unbelted, the Seat Belt Reminder Light will turn on and remain on until both front seat belts are fastened. BeltAlert® triggers within 60 seconds of vehicle speed over 5 mph (8 km/h). The reminder sequence lasts for 96 seconds or until the respective seat belts are fastened. After the sequence completes, the Seat Belt Reminder Light remains illuminated until front belts are fastened. The driver should instruct all other occupants to fasten their seat belts. If a front seat belt is unbuckled while traveling at speeds greater than 5 mph (8 km/h), BeltAlert® will chime as a single notification and illuminate the Seat Belt Reminder Light, then will proceed to the 96 second reminder sequence.

The front passenger seat BeltAlert® is not active when the front passenger seat is unoccupied. BeltAlert® may be triggered when an animal or heavy object is on the front passenger seat or when the seat is folded flat (if equipped). It is recommended that pets be restrained in the rear seat in pet harnesses or pet carriers that are secured by seat belts, and cargo is properly stowed.

BeltAlert® Programming

NOTE: Chrysler Group LLC does not recommend deactivating the BeltAlert®.

BeltAlert® can be enabled or disabled by your authorized dealer or by performing the following procedure:

NOTE: The following steps must occur within the first 60 seconds of the ignition switch being turned to the ON/RUN or START position.

1. Turn the ignition switch to the LOCK position and buckle the driver's or front passenger's seat belt.

2. Turn the ignition switch to the ON/RUN position and wait for the Seat Belt Reminder Light to turn off.

3. Within 60 seconds of turning the ignition switch to the ON/RUN position, unbuckle and then re-buckle the driver's or front passenger's seat belt at least three times within 10 seconds, ending with the seat belt buckled.

NOTE: Watch for the Seat Belt Reminder Light to turn on while unbuckling and off while re-buckling the seat belt. It may be necessary to retract the seat belt.

4. Turn the ignition switch to the LOCK position. A single chime will sound to signify that you have successfully completed the programming.

BeltAlert® can be reactivated by repeating this procedure.

NOTE: Although BeltAlert® has been deactivated, the Seat Belt Reminder Light will continue to illuminate while the driver's or front passenger's seat belt remains unbuckled.

Seat Belt Extender

If a seat belt is too short, even when fully extended, and when the adjustable upper shoulder belt anchorage (if equipped) is in its lowest position, your authorized dealer can provide you with a seat belt extender. This extender should be used only if the existing belt is not long enough. When it is not required, remove the extender and store it.

WARNING!

Using a seat belt extender when not needed can increase the risk of injury in an accident. Only use when the seat belt is not long enough when it is worn low and snug, and in the recommended seating positions. Remove and store the extender when not needed.

Seat Belts And Pregnant Women

We recommend that pregnant women use the seat belts throughout their pregnancy. Keeping the mother safe is the best way to keep the baby safe.

Pregnant women should wear the lap part of the belt across the thighs and as snug across the hips as possible. Keep the belt low so that it does not come across the abdomen. That way the strong bones of the hips will take the force if there is an accident.

Supplemental Restraint System (SRS) — Air Bags

This vehicle has Advanced Front Air Bags for both the driver and front passenger as a supplement to the seat belt restraint systems. The driver's Advanced Front Air Bag is mounted in the center of the steering wheel. The passenger's Advanced Front Air Bag is mounted in the instrument panel, above the glove compartment. The words SRS AIRBAG are embossed on the air bag covers.

60 THINGS TO KNOW BEFORE STARTING YOUR VEHICLE

In addition, the vehicle is equipped with a Supplemental Driver Side Knee Air Bag mounted in the instrument panel below the steering column.



Advanced Front Air Bag And Knee Bolster Locations

- 1 — Driver And Passenger
Advanced Front Air Bags
2 — Supplemental Driver Side
Knee Air Bag
3 — Knee Bolster

NOTE: These air bags are certified to the new Federal regulations for Advanced Air Bags.

The Advanced Front Air Bags have a multistage inflator design. This allows the air bag to have different rates of inflation that are based on the severity and type of collision.

This vehicle may be equipped with driver and/or front passenger seat track position sensors that may adjust the inflation rate of the Advanced Front Air Bags based upon seat position.

This vehicle may be equipped with a driver and/or front passenger seat belt buckle switch that detects whether the driver or front passenger seat belt is fastened. The seat belt buckle switch may adjust the inflation rate of the Advanced Front Air Bags.

This vehicle may be equipped with Supplemental Side Air Bag Inflatable Curtains (SABIC) to protect the driver, front, and rear passengers sitting next to a window. The SABIC are located above the side windows. The trim covering the side air bags is labeled SRS AIRBAG. This vehicle may also be equipped with Supplemental Seat-Mounted Side Air Bags (SAB). If the vehicle is equipped with Supplemental Seat-Mounted Side Air Bags they are marked with an air bag label sewn into the outboard side of the front seats.

NOTE:

- Air Bag covers may not be obvious in the interior trim, but they will open during air bag deployment.
- After any accident, the vehicle should be taken to an authorized dealer immediately.

Air Bag System Components

Your vehicle may be equipped with the following air bag system components:

- Occupant Restraint Controller (ORC)
- Air Bag Warning Light
- Steering Wheel and Column
- Instrument Panel
- Supplemental Driver Side Knee Air Bag
- Knee Impact Bolster
- Driver Advanced Front Air Bag
- Passenger Advanced Front Air Bag
- Supplemental Seat-Mounted Side Air Bags (SAB)
- Supplemental Side Air Bag Inflatable Curtains (SABIC)

- Front and Side Impact Sensors
- Front Seat Belt Pretensioners, Seat Belt Buckle Switch, and Seat Track Position Sensors
- Supplemental Active Head Restraint for Driver and Front Passenger

Advanced Front Air Bag Features

The Advanced Front Air Bag system has multistage driver and front passenger air bags. This system provides output appropriate to the severity and type of collision as determined by the Occupant Restraint Controller (ORC), which may receive information from the front impact sensors.

The first stage inflator is triggered immediately during an impact that requires air bag deployment. This low output is used in less severe collisions. A higher energy output is used for more severe collisions.

WARNING!

- No objects should be placed over or near the air bag on the instrument panel, because any such objects could cause harm if the vehicle is in a collision severe enough to cause the air bag to inflate.
- Do not put anything on or around the air bag covers or attempt to open them manually. You may damage the air bags and you could be injured because the air bags may no longer be functional. The protective covers for the air bag cushions are designed to open only when the air bags are inflating.
- Do not drill, cut or tamper with the knee bolster in any way.
- Do not mount any accessories to the knee bolster such as alarm lights, stereos, citizen band radios, etc.

Supplemental Seat-Mounted Side Air Bags (SAB) — If Equipped

Supplemental Seat-Mounted Side Air Bags (SAB) provide enhanced protection to help protect an occupant during a side impact. The Supplemental Seat-Mounted Side Air Bag is marked with an air bag label sewn into the outboard side of the front seats.

When the air bag deploys, it opens the seam between the front and side of the seat’s trim cover. Each air bag deploys independently; a left side impact deploys the left air bag only and a right-side impact deploys the right air bag only.

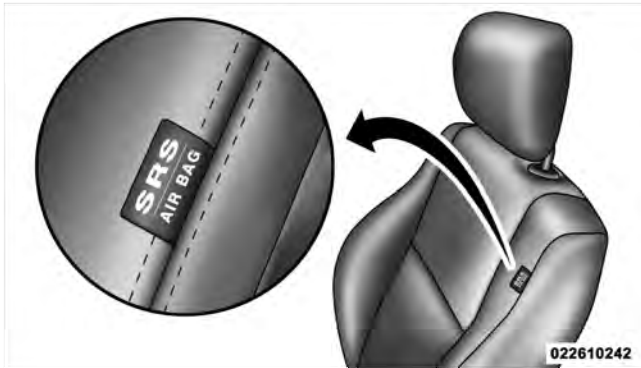

Supplemental Seat-Mounted Side Air Bag Label

Supplemental Side Air Bag Inflatable Curtain (SABIC)

SABIC air bags may offer side-impact protection to front and rear seat outboard occupants in addition to that provided by the body structure. Each air bag features inflated chambers placed adjacent to the head of each outboard occupant that reduce the potential for side-impact head injuries. The SABIC air bags deploy downward, covering both windows on the impact side.



Supplemental Side Air Bag Inflatable Curtains (SABIC) Label Location

NOTE: Air Bag covers may not be obvious in the interior trim, but they will open during air bag deployment.

The system includes side impact sensors that are calibrated to deploy the side air bags during impacts that require air bag occupant protection.

WARNING!

- **If your vehicle is equipped with left and right Supplemental Side Air Bag Inflatable Curtain (SABIC), do not stack luggage or other cargo up high enough to block the location of the SABIC. The area where the side curtain air bag is located should remain free from any obstructions.**
- **Do not use accessory seat covers or place objects between you and the side air bags; the performance could be adversely affected and/or objects could be pushed into you, causing serious injury.**

Supplemental Driver Side Knee Air Bag

The Supplemental Driver Side Knee Air Bag provides enhanced protection and works together with the Driver Advanced Front Air Bag during a frontal impact.

Knee Impact Bolster

The Knee Impact Bolster helps protect the knees of the passenger side front passenger by positioning the passenger for the best interaction with the Advanced Front Air Bags.

Along with seat belts and pretensioners, Advanced Front Air Bags work with the Supplemental Driver Side Knee Air Bag and the passenger side knee bolster to provide improved protection for the driver and front passenger. Side air bags also work with seat belts to improve occupant protection.

Air Bag Deployment Sensors And Controls

Occupant Restraint Controller (ORC)

The ORC is part of a Federally regulated safety system required for this vehicle.

The ORC determines if deployment of the front and/or side air bags in a frontal or side collision is required. Based on the impact sensor's signals, a central electronic ORC deploys the Advanced Front Air Bags, Supplemental Driver Side Knee Air Bag, SABIC air bags, Supplemental Seat-Mounted Side Air Bags — if equipped, and front seat belt pretensioners — if equipped, as required, depending on the severity and type of impact.

Advanced Front Air Bags and Supplemental Driver Side Knee Air Bag are designed to provide additional protection by supplementing the seat belts in certain frontal collisions depending on the severity and type of collision. Advanced Front Air Bags are not expected to reduce the risk of injury in rear, or side collisions.

The Advanced Front Air Bags and Supplemental Driver Side Knee Air Bag will not deploy in all frontal collisions, including some that may produce substantial vehicle damage — for example, some pole collisions, truck underrides, and angle offset collisions. On the other hand, depending on the type and location of impact, Advanced Front Air Bags may deploy in crashes with little vehicle front-end damage but that produce a severe initial deceleration.

The side air bags will not deploy in all side collisions. Side air bag deployment will depend on the severity and type of collision.

Because air bag sensors measure vehicle deceleration over time, vehicle speed and damage by themselves are not good indicators of whether or not an air bag should have deployed.

Seat belts are necessary for your protection in all accidents, and also are needed to help keep you in position, away from an inflating air bag.

The ORC monitors the readiness of the electronic parts of the air bag system whenever the ignition switch is in the START or ON/RUN position. If the key is in the OFF position, in the ACC position, or not in the ignition, the air bag system is not on and the air bags will not inflate.

The ORC contains a backup power supply system that may deploy the air bags even if the battery loses power or it becomes disconnected prior to deployment.



Also, the ORC turns on the Air Bag Warning Light in the instrument panel for approximately four to eight seconds for a self-check when the ignition is first turned on. After the self-check, the Air Bag Warning Light will turn off. If the ORC detects a malfunction in any part of the system, it

turns on the Air Bag Warning Light, either momentarily or continuously. A single chime will sound if the light comes on again after initial startup.

It also includes diagnostics that will illuminate the instrument cluster Air Bag Warning Light if a malfunction is noted that could affect the air bag system. The diagnostics also record the nature of the malfunction.

WARNING!

Ignoring the Air Bag Warning Light in your instrument panel could mean you won't have the air bags to protect you in a collision. If the light does not come on as a bulb check when the ignition is first turned on, stays on after you start the vehicle, or if it comes on as you drive, have an authorized dealer service the air bag system immediately.

Driver And Passenger Advanced Front Air Bag Inflator Units

The Driver and Passenger Advanced Front Air Bag Inflator Units are located in the center of the steering wheel and on the right side of the instrument panel. When the ORC detects a collision requiring the Advanced Front Air Bags, it signals the inflator units. A large quantity of non-toxic gas is generated to inflate the Advanced Front Air Bags. Different air bag inflation rates are possible, based on the collision type and severity. The steering wheel hub trim cover and the upper right side of the instrument panel separate and fold out of the way as the air bags inflate to their full size. The air bags fully inflate in about 50 to 70 milliseconds. This is about half of the time it takes to blink your eyes. The air bags then quickly deflate while helping to restrain the driver and front passenger.

The Advanced Front Air Bag gas is vented through the vent holes in the sides of the air bag. In this way, the air bags do not interfere with your control of the vehicle.

Supplemental Driver Side Knee Air Bag Inflator Unit

The Supplemental Driver Side Knee Air Bag unit is located in the instrument panel trim beneath the steering column. When the ORC detects a collision requiring the air bag, it signals the inflator units. A large quantity of non-toxic gas is generated to inflate the Supplemental Driver Side Knee Air Bag. The trim cover separates and folds out of the way allowing the air bag to inflate to the full size. The air bag fully inflates in about 15 to 20 milliseconds. The Supplemental Driver Side Knee Air Bag gas is vented through small vent holes in the side of the air bag.

Supplemental Seat-Mounted Side Air Bag (SAB) Inflator Units — If Equipped

The Supplemental Seat-Mounted Side Air Bags (SAB) are designed to activate only in certain side collisions.

The ORC determines if a side collision requires the side air bags to inflate, based on the severity and type of collision.

Based on the severity and type of collision, the side air bag inflator on the crash side of the vehicle may be triggered, releasing a quantity of non-toxic gas. The inflating SAB exits through the seat seam into the space between the occupant and the door. The SAB fully inflates in about 10 milliseconds. The side air bag moves at a very high speed and with such a high force that it could injure you if you are not seated properly, or if items are positioned in the area where the side air bag inflates. This especially applies to children.

Supplemental Side Air Bag Inflatable Curtain (SABIC) Inflator Units

During collisions where the impact is confined to a particular area of the side of the vehicle, the ORC may deploy the SABIC air bags, depending on the severity and type of collision. In these events, the ORC will deploy the SABIC only on the impact side of the vehicle.

A quantity of non-toxic gas is generated to inflate the side curtain air bag. The inflating side curtain air bag pushes the outside edge of the headliner out of the way and covers the window. The air bag inflates in about 30 milliseconds (about one-quarter of the time that it takes to blink your eyes) with enough force to injure you if you are not belted and seated properly, or if items are positioned in the area where the side curtain air bag inflates. This especially applies to children. The side curtain air bag is only about 3-1/2 in (9 cm) thick when it is inflated.

Because air bag sensors estimate deceleration over time, vehicle speed and damage are not good indicators of whether or not an air bag should have deployed.

Front And Side Impact Sensors

In front and side impacts, impact sensors can aid the ORC in determining appropriate response to impact events.

Enhanced Accident Response System

In the event of an impact causing air bag deployment, if the communication network remains intact, and the power remains intact, depending on the nature of the event the ORC will determine whether to have the Enhanced Accident Response System perform the following functions:

- Cut off fuel to the engine.

- Flash hazard lights as long as the battery has power or until the ignition key is turned off.
- Turn on the interior lights, which remain on as long as the battery has power or until the ignition key is removed.
- Unlock the doors automatically.

If A Deployment Occurs

The front air bags are designed to deflate immediately after deployment.

NOTE: Front and/or side air bags will not deploy in all collisions. This does not mean something is wrong with the air bag system.

If you do have a collision, which deploys the air bags, any or all of the following may occur:

- The nylon air bag material may sometimes cause abrasions and/or skin reddening to the driver and front passenger as the air bags deploy and unfold. The abrasions are similar to friction rope burns or those you might get sliding along a carpet or gymnasium floor. They are not caused by contact with chemicals. They are not permanent and normally heal quickly. However, if you haven't healed significantly within a few days, or if you have any blistering, see your doctor immediately.
- As the air bags deflate, you may see some smoke-like particles. The particles are a normal by-product of the process that generates the non-toxic gas used for air bag inflation. These airborne particles may irritate the skin, eyes, nose, or throat. If you have skin or eye irritation, rinse the area with cool water. For nose or

throat irritation, move to fresh air. If the irritation continues, see your doctor. If these particles settle on your clothing, follow the garment manufacturer's instructions for cleaning.

Do not drive your vehicle after the air bags have deployed. If you are involved in another collision, the air bags will not be in place to protect you.

WARNING!

Deployed air bags and seat belt pretensioners cannot protect you in another collision. Have the air bags, seat belt pretensioners, and the front seat belt retractor assemblies replaced by an authorized dealer immediately. Also, have the Occupant Restraint Controller (ORC) system serviced as well.

Maintaining Your Air Bag System

WARNING!

- Modifications to any part of the air bag system could cause it to fail when you need it. You could be injured if the air bag system is not there to protect you. Do not modify the components or wiring, including adding any kind of badges or stickers to the steering wheel hub trim cover or the upper right side of the instrument panel. Do not modify the front bumper, vehicle body structure, or add aftermarket side steps or running boards.
- It is dangerous to try to repair any part of the air bag system yourself. Be sure to tell anyone who works on your vehicle that it has an air bag system.

(Continued)

WARNING! (Continued)

- Do not attempt to modify any part of your air bag system. The air bag may inflate accidentally or may not function properly if modifications are made. Take your vehicle to an authorized dealer for any air bag system service. If your seat including your trim cover and cushion needs to be serviced in any way (including removal or loosening/tightening of seat attachment bolts), take the vehicle to your authorized dealer. Only manufacturer approved seat accessories may be used. If it is necessary to modify the air bag system for persons with disabilities, contact your authorized dealer.

Air Bag Warning Light



You will want to have the air bags ready to inflate for your protection in a collision. The Air Bag Warning Light monitors the internal circuits and interconnecting wiring associated with air bag system electrical components. While the air bag system is designed to be maintenance free. If any of the following occurs, have an authorized dealer service the air bag system immediately.

- The Air Bag Warning Light does not come on during the four to eight seconds when the ignition switch is first turned to the ON/RUN position.
- The Air Bag Warning Light remains on after the four to eight-second interval.
- The Air Bag Warning Light comes on intermittently or remains on while driving.

NOTE: If the speedometer, tachometer, or any engine related gauges are not working, the Occupant Restraint Controller (ORC) may also be disabled. The air bags may not be ready to inflate for your protection. Promptly check the fuse block for blown fuses. Refer to the label located on the inside of the fuse block cover for the proper air bag fuses. See your authorized dealer if the fuse is good.

Event Data Recorder (EDR)

This vehicle is equipped with an event data recorder (EDR). The main purpose of an EDR is to record, in certain crash or near crash-like situations, such as an air bag deployment or hitting a road obstacle, data that will assist in understanding how a vehicle's systems performed. The EDR is designed to record data related to vehicle dynamics and safety systems for a short period of time, typically 30 seconds or less. The EDR in this vehicle is designed to record such data as:

- How various systems in your vehicle were operating;

- Whether or not the driver and passenger safety belts were buckled/fastened;
- How far (if at all) the driver was depressing the accelerator and/or brake pedal; and,
- How fast the vehicle was traveling.

These data can help provide a better understanding of the circumstances in which crashes and injuries occur.

NOTE: EDR data are recorded by your vehicle only if a non-trivial crash situation occurs; no data are recorded by the EDR under normal driving conditions and no personal data (e.g., name, gender, age, and crash location) are recorded. However, other parties, such as law enforcement, could combine the EDR data with the type of personally identifying data routinely acquired during a crash investigation.

To read data recorded by an EDR, special equipment is required, and access to the vehicle or the EDR is needed.

In addition to the vehicle manufacturer, other parties, such as law enforcement, that have the special equipment, can read the information if they have access to the vehicle or the EDR.

Child Restraints

Everyone in your vehicle needs to be buckled up at all times, including babies and children. Every state in the United States and all Canadian provinces require that small children ride in proper restraint systems. This is the law, and you can be prosecuted for ignoring it.

Children 12 years or younger should ride properly buckled up in a rear seat, if available. According to crash statistics, children are safer when properly restrained in the rear seats, rather than in the front.

There are different sizes and types of restraints for children from newborn size to the child almost large enough for an adult safety belt. Always check the child

seat owner's manual to ensure you have the correct seat for your child. Use the restraint that is correct for your child.

WARNING!

In a collision, an unrestrained child, even a tiny baby, can become a projectile inside the vehicle. The force required to hold even an infant on your lap could become so great that you could not hold the child, no matter how strong you are. The child and others could be badly injured. Any child riding in your vehicle should be in a proper restraint for the child's size.

Infants And Child Restraints

- Safety experts recommend that children ride rearward-facing in the vehicle until they are at least one year old and weigh at least 20 lbs (9 kg). Two types

of child restraints can be used rearward-facing: infant carriers and convertible child seats. Both types of child restraints are held in the vehicle by the lap/shoulder belt or the LATCH child restraint anchorage system. Refer to "LATCH — Child Seat Anchorage System (Lower Anchors and Tether for Children)".

- The infant carrier is only used rearward-facing in the vehicle. It is recommended for children who weigh up to about 20 lbs (9 kg). Convertible child seats can be used either rearward-facing or forward-facing in the vehicle. Convertible child seats often have a higher weight limit in the rearward-facing direction than infant carriers do, so they can be used rearward-facing by children who weigh more than 20 lbs (9 kg) but are younger than one year old. Both types of child restraints are held in the vehicle by the lap/shoulder belt or the LATCH child restraint anchorage system. Refer to the "LATCH – Child Seat Anchorage System (Lower Anchors and Tether for Children)" in this section.

WARNING!

Rearward-facing child seats must never be used in the front seat of a vehicle with a front passenger air bag. An air bag deployment could cause severe injury or death to infants in this position.

Children Too Large For Booster Seats

Children who are large enough to wear the shoulder belt comfortably and whose legs are long enough to bend over the front of the seat when their back is against the seatback should use the lap/shoulder belt in a rear seat.

- Make sure that the child is upright in the seat.
- The lap portion should be low on the hips and as snug as possible.
- Check belt fit periodically. A child's squirming or slouching can move the belt out of position.

- If the shoulder belt contacts the face or neck, move the child closer to the center of the vehicle. Never allow a child to put the shoulder belt under an arm or behind their back.

Here are some tips on getting the most out of your child restraint:

- Before buying any restraint system, make sure that it has a label certifying that it meets all applicable Safety Standards. Chrysler Group LLC also recommends that you make sure that you can install the child restraint in the vehicle where you will use it, before you buy it.
- The restraint must be appropriate for your child's weight and height. Check the label on the restraint for weight and height limits.
- Carefully follow the instructions that come with the restraint. If you install the restraint improperly, it may not work when you need it.

NOTE: For additional information, refer to www.seatcheck.org or call 1-866-SEATCHECK. Canadian residents should refer to Transport Canada's website for additional information: <http://www.tc.gc.ca/roadsafety/safedrivers/childsafety/index.htm>

Older Children And Child Restraints

- Children who weigh more than 20 lbs (9 kg) and who are older than one year can ride forward-facing in the vehicle. Forward-facing child seats and convertible child seats used in the forward-facing direction are for children who weigh 20 to 40 lbs (9 to 18 kg) and who are older than one year. These child seats are also held in the vehicle by the lap/shoulder belt or the LATCH child restraint anchorage system. Refer to "LATCH — Child Seat Anchorage System (Lower Anchors and Tether for CHildren)".
- The belt-positioning booster seat is for children weighing more than 40 lbs (18 kg), but who are still too small

to fit the vehicle's seat belts properly. If the child cannot sit with knees bent over the vehicle's cushion while the child's back is against the seatback; they should use a Belt Positioning Booster Seat. The child and booster seat are held in the vehicle by the lap/shoulder belt.

WARNING!

- **Improper installation can lead to failure of an infant or child restraint. It could come loose in a collision. The child could be badly injured or killed. Follow the manufacturer's directions exactly when installing an infant or child restraint.**
- **A rearward-facing child restraint should only be used in a rear seat. A rearward-facing child restraint in the front seat may be struck by a deploying passenger air bag which may cause severe or fatal injury to the infant.**

Lower Anchors and Tether for Children (LATCH)

Your vehicle is equipped with the child restraint anchorage system called LATCH, which stands for Lower Anchors and Tether for Children. The LATCH system provides for the installation of the child restraint without using the vehicle seat belt, instead securing the child restraint using lower anchorages and upper tether straps from the child restraint to the vehicle structure.

LATCH-compatible child restraint systems are now available. However, because the lower anchorages are to be introduced over a period of years, child restraint systems having attachments for those anchorages will continue to have features for installation using the vehicle's seat belts. Child restraints having tether straps and hooks for connection to the top tether anchorages have been available for some time. For some older child restraints, many child restraint manufacturers offer add-on tether strap kits or retrofit kits. You are urged to take advantage of all the available attachments provided with your child restraint in any vehicle.

Child seats with fixed lower attachments must be installed in the outboard positions only. If you are installing LATCH-compatible child restraints in adjacent rear seating positions, you can use the LATCH anchors or the vehicle's seat belt for the outboard position, but you must use the vehicle's seat belt at the center position. If your child restraints are not LATCH-compatible, you can only install the child restraints using the vehicle's seat belts. Please refer to "Installing The Child Restraint System" for typical installation instructions.

WARNING!

You should never install LATCH-compatible child seats so that two seats share a common anchorage. If installing seats in adjacent seating positions, or if your child restraints are not LATCH-compatible, install the restraints using the vehicle's seat belts.

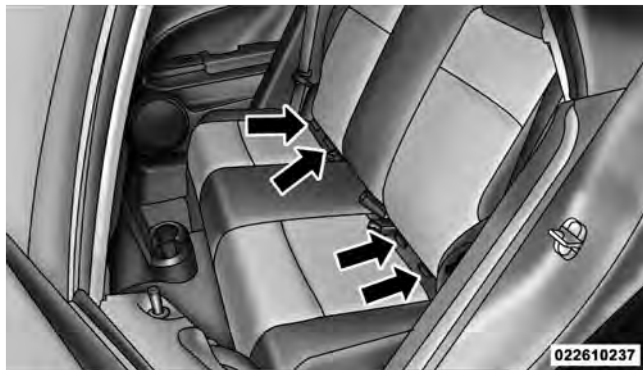

Rear Seat LATCH Anchorages

Installing The LATCH – Compatible Child Restraint System

We urge you to carefully follow the directions of the manufacturer when installing your child restraint. Not all child restraint systems will be installed as described here.

Again, carefully follow the installation instructions that are provided with the child restraint system.



The lower anchorages are round bars, part of the seat and body structure, and are readily visible. In addition, there are tether strap anchorages behind each rear seating position, located in the rear surface of the seat back.

These are round bars, located at the rear of the seat cushion where it meets the seat back, and just visible when you lean into the rear seat to install the child restraint. You will easily feel them if you run your finger along the intersection of the surfaces

The lower strap hooks are passed over the top of each bar, pushing aside the seat cover material



Many, but not all, restraint systems will be equipped with separate straps on each side, with each having a hook or connector for

attachment to the lower anchorage and a means of adjusting the tension in the strap. Forward-facing toddler restraints and some rear-facing infant restraints will also be equipped with a tether strap, a hook for attachment to the tether strap anchorage and a means of adjusting the tension of the strap.

While there are LATCH anchorages at all three rear seating positions, do not install child restraints at all three positions at the same time. The anchorages are not designed to restrain three child restraints at one time. Instead, you may install one child restraint at the center position, or two child restraints at the right and left positions.

You will first loosen the child seat adjusters on the lower straps and on the tether strap so that you can more easily attach the hook or connectors to the vehicle anchorages. Next, attach the lower hooks or connectors over the top of the seat cover material. Then attach the tether strap to

the anchorage directly behind the seat where you are placing the child restraint, being careful to route the tether strap to provide the most direct path between the anchor and the child restraint, preferably between the head restraint posts underneath the head restraint. Finally, tighten all three straps as you push the child restraint rearward and downward into the seat, removing slack in the straps according to the child restraint manufacturer's instructions.

NOTE:

- Ensure that the tether strap does not slip into the opening between the seatbacks as you remove the slack in the strap.
- When using the LATCH attaching system to install a child restraint, please ensure that all seat belts not being used for occupant restraints are stowed and out of reach of children. It is recommended that before installing the child restraint, buckle the seat belt so the

seat belt is tucked behind the child restraint. This should stow the seat belt out of the reach of an inquisitive child. Remind all children in the vehicle that the seat belts are not toys and that they should not play with them. In addition, never leave unattended children in the vehicle.

WARNING!

Improper installation of a child restraint to the LATCH anchorages can lead to failure of an infant or child restraint. The child could be badly injured or killed. Follow the manufacturer's directions exactly when installing an infant or child restraint.

Installing Child Restraints Using The Vehicle Seat Belt

The seat belts in the passenger seating positions are equipped with an Automatic Locking Retractor (ALR) to secure a Child Restraint System (CRS). These types of

seat belts are designed to keep the lap portion of the seat belt tight around the child restraint so that it is not necessary to use a locking clip. The ALR will make a ratcheting noise if you extract the entire belt from the retractor and then allow the belt to retract into the retractor. For additional information on ALR, refer to "Automatic Locking Mode" description under "Seat Belts In Passenger Seating Positions" section. The chart below defines the seating positions with an Automatic Locking Retractor (ALR) or a cinching latch plate.

	Driver	Center	Passenger
	CRS Lock	CRS Lock	CRS Lock
First Row	N/A	N/A	ALR
Second Row	ALR	ALR	ALR
Third Row	N/A	N/A	N/A

- N/A — Not Applicable
- ALR — Automatic Locking Retractor

Installing a Child Restraint with an ALR:

1. To install a child restraint with ALR, first, pull enough of the seat belt webbing from the retractor to route it through the belt path of the child restraint. Slide the latch plate into the buckle until you hear a “click.” Next, extract all the seat belt webbing out of the retractor and then allow the belt to retract into the retractor. As the belt retracts, you will hear a ratcheting sound. This indicates the safety belt is now in the Automatic Locking mode.
2. Finally, pull on any excess webbing to tighten the lap portion around the child restraint. Any seat belt system will loosen with time, so check the belt occasionally, and pull it tight if necessary.

- In the rear seat, you may have trouble tightening the lap/shoulder belt on the child restraint because the buckle or latch plate is too close to the belt path opening on the restraint. Disconnect the latch plate from the buckle and twist the short buckle-end belt several times to shorten it. Insert the latch plate into the buckle with the release button facing out.
- If the belt still can't be tightened, or if pulling and pushing on the restraint loosens the belt, disconnect the latch plate from the buckle, turn the buckle around, and insert the latch plate into the buckle again. If you still can't make the child restraint secure, try a different seating position.

To attach a child restraint tether strap:

- Route the tether strap to provide the most direct path for the strap between the anchor and the child seat, routing it over the head restraint.



- If necessary, move the seat forward to provide better access to the tether anchor.
- Attach the tether strap hook of the child restraint to the tether anchor and remove slack in the tether strap according to the child restraint manufacturer's instructions.

NOTE: Ensure that the tether strap does not slip into the opening between the seatbacks as you remove slack in the strap.

WARNING!

An incorrectly anchored tether strap could lead to increased head motion and possible injury to the child. Use only the anchor position directly behind the child seat to secure a child restraint top tether strap.

Transporting Pets

Air Bags deploying in the front seat could harm your pet. An unrestrained pet will be thrown about and possibly injured, or could injure a passenger during panic braking or in an accident.

Pets should be restrained in the rear seat in pet harnesses or pet carriers that are secured by seat belts.

ENGINE BREAK-IN RECOMMENDATIONS

A long break-in period is not required for the engine and drivetrain (transmission and axle) in your vehicle.

Drive moderately during the first 300 miles (500 km). After the initial 60 miles (100 km), speeds up to 50 or 55 mph (80 or 90 km/h) are desirable.

While cruising, brief full-throttle acceleration within the limits of local traffic laws contributes to a good break-in. Wide-open throttle acceleration in low gear can be detrimental and should be avoided.

The engine oil installed in the engine at the factory is a high-quality energy conserving type lubricant. Oil changes should be consistent with anticipated climate conditions under which vehicle operations will occur. For the recommended viscosity and quality grades, refer to "Maintenance Procedures" in "Maintaining Your Vehicle". NON-DETERGENT OR STRAIGHT MINERAL OILS MUST NEVER BE USED.

A new engine may consume some oil during its first few thousand miles (kilometers) of operation. This should be considered a normal part of the break-in and not interpreted as an indication of difficulty.

SAFETY TIPS

Transporting Passengers

NEVER TRANSPORT PASSENGERS IN THE CARGO AREA.

WARNING!

- Do not leave children or animals inside parked vehicles in hot weather. Interior heat build-up may cause serious injury or death.

(Continued)

WARNING! (Continued)

- It is extremely dangerous to ride in a cargo area, inside or outside of a vehicle. In a collision, people riding in these areas are more likely to be seriously injured or killed.
- Do not allow people to ride in any area of your vehicle that is not equipped with seats and seat belts.
- Be sure everyone in your vehicle is in a seat and using a seat belt properly.

Exhaust Gas**WARNING!**

Exhaust gases can injure or kill. They contain carbon monoxide (CO), which is colorless and odorless. Breathing it can make you unconscious and can eventually poison you. To avoid breathing (CO), follow these safety tips:

Do not run the engine in a closed garage or in confined areas any longer than needed to move your vehicle in or out of the area.

If it is necessary to sit in a parked vehicle with the engine running, adjust your heating or cooling controls to force outside air into the vehicle. Set the blower at high speed.

If you are required to drive with the trunk/liftgate open, make sure that all windows are closed and the climate control BLOWER switch is set at high speed. DO NOT use the recirculation mode.

The best protection against carbon monoxide entry into the vehicle body is a properly maintained engine exhaust system.

Whenever a change is noticed in the sound of the exhaust system, when exhaust fumes can be detected inside the vehicle, or when the underside or rear of the vehicle is damaged, have a competent mechanic inspect the complete exhaust system and adjacent body areas for broken, damaged, deteriorated, or mispositioned parts. Open seams or loose connections could permit exhaust fumes to seep into the passenger compartment. In addition, inspect the exhaust system each time the vehicle is raised for lubrication or oil change. Replace as required.

Safety Checks You Should Make Inside The Vehicle

Seat Belts

Inspect the belt system periodically, checking for cuts, frays, and loose parts. Damaged parts must be replaced immediately. Do not disassemble or modify the system.

Front seat belt assemblies must be replaced after a collision. Rear seat belt assemblies must be replaced after a collision if they have been damaged (i.e., bent retractor, torn webbing, etc.). If there is any question regarding belt or retractor condition, replace the belt.

Airbag Warning Light

The light should come on and remain on for four to eight seconds as a bulb check when the ignition switch is first turned ON. If the light is not lit during starting, see your authorized dealer. If the light stays on, flickers, or comes on while driving, have the system checked by an authorized dealer.

Defroster

Check operation by selecting the defrost mode and place the blower control on high speed. You should be able to feel the air directed against the windshield. See your authorized dealer for service if your defroster is inoperable.

Floor Mat Safety Information

Always use floor mats designed to fit the footwell of your vehicle. Use only floor mats that leave the pedal area unobstructed and that are firmly secured so that they cannot slip out of position and interfere with the pedals or impair safe operation of your vehicle in other ways.

WARNING!

Pedals that cannot move freely can cause loss of vehicle control and increase the risk of serious personal injury.

(Continued)

WARNING! (Continued)

- Always make sure that floor mats are properly attached to the floor mat fasteners.
- Never place or install floor mats or other floor coverings in the vehicle that cannot be properly secured to prevent them from moving and interfering with the pedals or the ability to control the vehicle.
- Never put floor mats or other floor coverings on top of already installed floor mats. Additional floor mats and other coverings will reduce the size of the pedal area and interfere with the pedals.
- Check mounting of mats on a regular basis. Always properly reinstall and secure floor mats that have been removed for cleaning.

(Continued)

WARNING! (Continued)

- Always make sure that objects cannot fall into the driver footwell while the vehicle is moving. Objects can become trapped under the brake pedal and accelerator pedal causing a loss of vehicle control.
- If required, mounting posts must be properly installed, if not equipped from the factory. Failure to properly follow floor mat installation or mounting can cause interference with the brake pedal and accelerator pedal operation causing loss of control of the vehicle.

Periodic Safety Checks You Should Make Outside The Vehicle**Tires**

Examine tires for excessive tread wear and uneven wear patterns. Check for stones, nails, glass, or other objects

lodged in the tread or sidewall. Inspect the tread for cuts and cracks. Inspect sidewalls for cuts, cracks and bulges. Check the wheel nuts for tightness. Check the tires (including spare) for proper cold inflation pressure.

Lights

Have someone observe the operation of exterior lights while you work the controls. Check turn signal and high beam indicator lights on the instrument panel.

Door Latches

Check for positive closing, latching, and locking.

Fluid Leaks

Check area under vehicle after overnight parking for fuel, engine coolant, oil, or other fluid leaks. Also, if gasoline fumes are detected or if fuel, power steering fluid, or brake fluid leaks are suspected, the cause should be located and corrected immediately.

UNDERSTANDING THE FEATURES OF YOUR VEHICLE

CONTENTS

■ Mirrors	93	■ Uconnect™ Phone — If Equipped	97
□ Inside Day/Night Mirror	93	□ Operation	99
□ Automatic Dimming Mirror — If Equipped	94	□ Phone Call Features	107
□ Outside Mirror — Driver Side	95	□ Uconnect™ Phone Features	110
□ Outside Mirror — Passenger Side	95	□ Advanced Phone Connectivity	114
□ Power Mirrors — If Equipped	95	□ Things You Should Know About Your Uconnect™ Phone	116
□ Heated Mirrors — If Equipped	96	□ General Information	127
□ Vanity Mirrors — If Equipped	96		
□ Sun Visor Sliding Feature	97		

- Voice Command — If Equipped 127
 - Voice Command System Operation 127
 - Commands 128
 - Voice Training 132
- Seats 132
 - Power Seats — If Equipped 132
 - Heated Seats — If Equipped 134
 - Manual Front Seat Forward/Rearward Adjustment 135
 - Manual Seat Height Adjustment — If Equipped 136
 - Manual Lumbar — If Equipped 136
 - Driver's Seatback Recline 137
 - Fold-Flat Front Passenger Seat 138
 - Head Restraints 138
 - Folding Rear Seat 142
 - Reclining Rear Seat — If Equipped 143
- To Open And Close The Hood 144
- Lights 146
 - Multifunction Lever 146
 - Headlights And Parking Lights 146
 - Daytime Running Lights — If Equipped 147
 - Lights-On Reminder 147
 - Fog Lights — If Equipped 148
 - Turn Signals 148
 - High/Low Beam Switch 149
 - Flash-To-Pass 149

<ul style="list-style-type: none"> □ Instrument Panel Dimmer 150 □ Map/Reading Lights 150 ■ Windshield Wipers And Washers 151 <ul style="list-style-type: none"> □ Windshield Wiper Operation 152 □ Intermittent Wiper System 153 □ Windshield Washers 153 □ Mist Feature 154 ■ Tilt Steering Column 154 ■ Electronic Speed Control — If Equipped 155 <ul style="list-style-type: none"> □ To Activate 156 □ To Set A Desired Speed 156 □ To Deactivate 156 □ To Resume Speed 157 	<ul style="list-style-type: none"> □ To Vary The Speed Setting 157 □ Manual Transmission 157 <ul style="list-style-type: none"> □ To Accelerate For Passing 157 ■ Garage Door Opener — If Equipped 158 <ul style="list-style-type: none"> □ Programming HomeLink® 160 □ Gate Operator/Canadian Programming 162 □ Using HomeLink® 163 <ul style="list-style-type: none"> □ Reprogramming A Single HomeLink® Button 163 □ Security 163 □ Troubleshooting Tips 164 □ General Information 164
--	---

- Power Sunroof — If Equipped 165
 - Opening Sunroof — Express 166
 - Opening Sunroof — Manual Mode 166
 - Closing Sunroof — Express 166
 - Closing Sunroof — Manual Mode 166
 - Pinch Protect Feature 167
 - Venting Sunroof — Express 167
 - Sunshade Operation 167
 - Wind Buffeting 167
 - Sunroof Maintenance 167
 - Ignition Off Operation 168
- Electrical Power Outlets 168
- Power Inverter — If Equipped 171
- Cupholders 173
- Console Features 174
- Cargo Area Features 175
 - Cargo Light/Removable Self-Recharging Flashlight 175
 - Cargo Cover 176
 - Removable Load Floor 178
 - Cargo Tie-Down Loops 179
 - Fold Down Speakers — If Equipped 180
- Rear Window Features 180
 - Rear Window Wiper/Washer 180
 - Rear Window Defroster 181
- Chill Zone® Beverage Cooler Storage Compartment — If Equipped 182

MIRRORS

Inside Day/Night Mirror

A two-point pivot system allows for horizontal and vertical mirror adjustment. Adjust the mirror to center on the view through the rear window.

Headlight glare can be reduced by moving the small control under the mirror to the night position (toward the rear of vehicle). The mirror should be adjusted while set in the day position (toward the windshield).

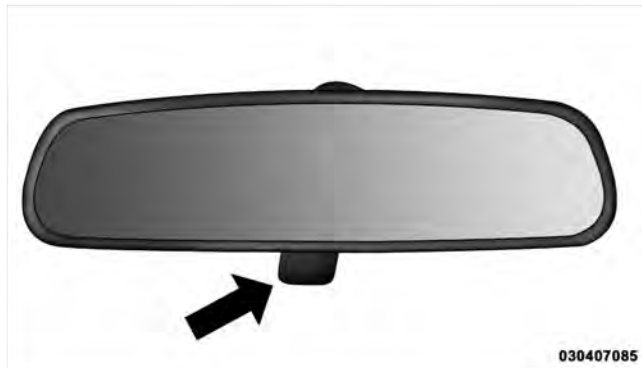

3

030407085

Adjusting Rearview Mirror

Automatic Dimming Mirror — If Equipped

This mirror automatically adjusts for headlight glare from vehicles behind you. You can turn the feature on or off by pressing the button at the base of the mirror. A light to the left of the button will illuminate to indicate when the dimming feature is activated. The sensor to the right of the button does not illuminate.



Automatic Dimming Mirror

CAUTION!

To avoid damage to the mirror during cleaning, never spray any cleaning solution directly onto the mirror. Apply the solution onto a clean cloth and wipe the mirror clean.

Outside Mirror — Driver Side

Adjust the flat outside mirror so you can just see the side of your vehicle in the part of the mirror closest to the vehicle with your head close to the door glass.

Outside Mirror — Passenger Side

Adjust the convex outside mirror so you can just see the side of your vehicle in the part of the mirror closest to the vehicle with your head close to the center of the vehicle.

WARNING!

Vehicles and other objects seen in the passenger side convex mirror will look smaller and farther away than they really are. Relying too much on your passenger side mirror could cause you to collide with another vehicle or other object. Use your inside mirror when judging the size or distance of a vehicle seen in this convex mirror.

Power Mirrors — If Equipped

The power mirror controls are located on the driver's door trim panel.



Power Mirror Control

To adjust a mirror, turn the control wand toward the left or right mirror positions indicated. Tilt the control wand in the direction you want the mirror to move.



Mirror Directions

When you are finished adjusting the mirror, turn the control to the center position to prevent accidentally moving a mirror.

WARNING!

Vehicles and other objects seen in the passenger side convex mirror will look smaller and farther away than they really are. Relying too much on your passenger side mirror could cause you to collide with another vehicle or other object. Use your inside mirror when judging the size or distance of a vehicle seen in this convex mirror.

Heated Mirrors — If Equipped



These mirrors are heated to melt frost or ice. This feature is activated whenever you turn on the rear window defroster. Refer to “Rear Window Features” in “Understanding The Features Of Your Vehicle” for further information.

Vanity Mirrors — If Equipped

To use the vanity mirror, rotate the sun visor down and swing the mirror cover upward.

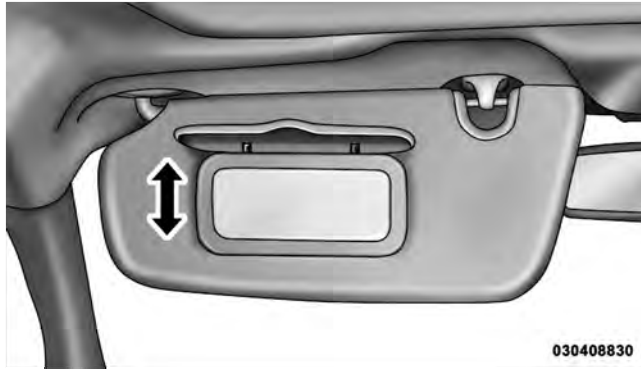

Vanity Mirror

Sun Visor Sliding Feature

The sun visors may be extended out to provide more coverage of the side glass.

Uconnect™ Phone — IF EQUIPPED

Uconnect™ Phone is a voice-activated, hands-free, in-vehicle communications system. Uconnect™ Phone allows you to dial a phone number with your mobile phone using simple voice commands (e.g., “Call” ... “Mike” ... “Work” or “Dial” ... “248-555-1212”). Your mobile phone’s audio is transmitted through your vehicle’s audio system; the system will automatically mute your radio when using the Uconnect™ Phone.

NOTE: The Uconnect™ Phone requires a mobile phone equipped with the Bluetooth® “Hands-Free Profile”, Version 0.96 or higher. See the Uconnect™ website for supported phones.

For Uconnect™ customer support, visit the following websites:

- www.chrysler.com/uconnect
- www.dodge.com/uconnect

- www.jeep.com/uconnect
- or call 1-877-855-8400

Uconnect™ Phone allows you to transfer calls between the system and your mobile phone as you enter or exit your vehicle and enables you to mute the system's microphone for private conversation.

The Uconnect™ Phone is driven through your Bluetooth® "Hands-Free Profile" mobile phone. Uconnect™ features Bluetooth® technology - the global standard that enables different electronic devices to connect to each other without wires or a docking station, so Uconnect™ Phone works no matter where you stow your mobile phone (be it your purse, pocket, or briefcase), as long as your phone is turned on and has been paired to the vehicle's Uconnect™ Phone. The Uconnect™ Phone allows up to seven mobile phones to be linked to the



system. Only one linked (or paired) mobile phone can be used with the system at a time. The system is available in English, Spanish, or French languages.

WARNING!

Any voice commanded system should be used only in safe driving conditions following local laws and phone use. All attention should be kept on the roadway ahead. Failure to do so may result in a collision causing serious injury or death.

Uconnect™ Phone Button



The radio or steering wheel controls (if equipped) will contain the two control buttons (Uconnect™ Phone  button and Voice Command  button) that will enable you to access the system. When you press the button you will hear the word Uconnect™ followed by a BEEP. The beep is your signal to give a command.

Voice Command Button

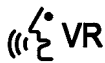

Actual button location may vary with the radio. The individual buttons are described in the “Operation” section.

The Uconnect™ Phone can be used with any Hands-Free Profile certified Bluetooth® mobile phone. See the Uconnect™ website for supported phones. Refer to your mobile service provider or the phone manufacturer for details.

The Uconnect™ Phone is fully integrated with the vehicle’s audio system. The volume of the Uconnect™ Phone can be adjusted either from the radio volume control knob or from the steering wheel radio control (right switch), if so equipped.

The radio display will be used for visual prompts from the Uconnect™ Phone such as “CELL” or caller ID on certain radios.

Operation

Voice commands can be used to operate the Uconnect™ Phone and to navigate through the Uconnect™ Phone menu structure. Voice commands are required after most Uconnect™ Phone prompts. You will be prompted for a specific command and then guided through the available options.

- Prior to giving a voice command, one must wait for the beep, which follows the “Ready” prompt or another prompt.
- For certain operations, compound commands can be used. For example, instead of saying “Setup” and then “Pair a Device”, the following compound command can be said: “Pair a Bluetooth® Device”.
- For each feature explanation in this section, only the compound form of the voice command is given. You can also break the commands into parts and say each part of the command when you are asked for it. For



example, you can use the compound form voice command “Phonebook New Entry”, or you can break the compound form command into two voice commands: “Phonebook” and “New Entry”. Please remember, the Uconnect™ Phone works best when you talk in a normal conversational tone, as if speaking to someone sitting a few feet/meters away from you.

Voice Command Tree

Refer to “Voice Tree” in this section.

Help Command

If you need assistance at any prompt, or if you want to know your options at any prompt, say “Help” following the beep. The Uconnect™ Phone will play some of the options at any prompt if you ask for help.

To activate the Uconnect™ Phone, simply press the  button and follow the audible prompts for directions. Uconnect™ Phone sessions begin with a press of the  button on the radio control head.

Cancel Command

At any prompt, after the beep, you can say “Cancel” and you will be returned to the main menu. However, in a few instances the system will take you back to the previous menu.

Pair (Link) Uconnect™ Phone To A Mobile Phone

To begin using your Uconnect™ Phone, you must pair your compatible Bluetooth® enabled mobile phone.

To complete the pairing process, you will need to reference your mobile phone Owner’s Manual. The Uconnect™ website may also provide detailed instructions for pairing.

The following are general phone to Uconnect™ Phone pairing instructions:

- Press the  button to begin.
- After the “Ready” prompt and the following beep, say “Device Pairing”.

- When prompted, after the beep, say “Pair a Device” and follow the audible prompts.
- You will be asked to say a four-digit Personal Identification Number (PIN), which you will later need to enter into your mobile phone. You can enter any four-digit PIN. You will not need to remember this PIN after the initial pairing process.
- For identification purposes, you will be prompted to give the Uconnect™ Phone a name for your mobile phone. Each mobile phone that is paired should be given a unique phone name.
- You will then be asked to give your mobile phone a priority level between one and seven, with one being the highest priority. You can pair up to seven mobile phones to your Uconnect™ Phone. However, at any given time, only one mobile phone can be in use, connected to your Uconnect™ System. The priority allows the Uconnect™ Phone to know which mobile

phone to use if multiple mobile phones are in the vehicle at the same time. For example, if priority three and priority five phones are present in the vehicle, the Uconnect™ Phone will use the priority three mobile phone when you make a call. You can select to use a lower priority mobile phone at any time (refer to “Advanced Phone Connectivity” in this section).

Dial By Saying A Number

- Press the  button to begin.
- After the “Ready” prompt and the following beep, say “Dial”.
- The system will prompt you to say the number you want to call.
- For example, you can say “234-567-8901”.

- The Uconnect™ Phone will confirm the phone number and then dial. The number will appear in the display of certain radios.

Call By Saying A Name

- Press the  button to begin.
- After the “Ready” prompt and the following beep, say “Call”.
- The system will prompt you to say the name of the person you want to call.
- After the “Ready” prompt and the following beep, say the name of the person you want to call. For example, you can say “John Doe”, where John Doe is a previously stored name entry in the Uconnect™ phonebook or downloaded phonebook. To learn how to store a name in the phonebook, refer to “Add Names to Your Uconnect™ Phonebook”, in the phonebook.

- The Uconnect™ system will confirm the name and then dial the corresponding phone number, which may appear in the display of certain radios.

Add Names To Your Uconnect™ Phonebook

NOTE: Adding names to the Uconnect™ Phonebook is recommended when the vehicle is not in motion.

- Press the  button to begin.
- After the “Ready” prompt and the following beep, say “Phonebook New Entry”.
- When prompted, say the name of the new entry. Use of long names helps the Voice Command and it is recommended. For example, say “Robert Smith” or “Robert” instead of “Bob”.

- When prompted, enter the number designation (e.g., “Home”, “Work”, “Mobile”, or “Other”). This will allow you to store multiple numbers for each phonebook entry, if desired.
- When prompted, recite the phone number for the phonebook entry that you are adding.

After you are finished adding an entry into the phonebook, you will be given the opportunity to add more phone numbers to the current entry or to return to the main menu.

The Uconnect™ Phone will allow you to enter up to 32 names in the phonebook with each name having up to four associated phone numbers and designations. Each language has a separate 32-name phonebook accessible only in that language. In addition, if equipped and supported by your phone, Uconnect™ Phone automatically downloads your mobile phone’s phonebook.

Phonebook Download – Automatic Phonebook Transfer From Mobile Phone

If equipped and specifically supported by your phone, Uconnect™ Phone automatically downloads names (text names) and number entries from your mobile phone’s phonebook. Specific Bluetooth® Phones with Phone Book Access Profile may support this feature. See Uconnect™ website for supported phones.

- To call a name from the Uconnect™ Phonebook or downloaded Phonebook, follow the procedure in “Call by Saying a Name” section.
- Automatic download and update, if supported, begins as soon as the Bluetooth® wireless phone connection is made to the Uconnect™ Phone, for example, after you start the vehicle.
- A maximum of 1000 entries per phone will be downloaded and updated every time a phone is connected to the Uconnect™ Phone.

- Depending on the maximum number of entries downloaded, there may be a short delay before the latest downloaded names can be used. Until then, if available, the previously downloaded phonebook is available for use.
- Only the phonebook of the currently connected mobile phone is accessible.
- Only the mobile phone's phonebook is downloaded. SIM card phonebook is not part of the Mobile phonebook.
- This downloaded phonebook cannot be edited or deleted on the Uconnect™ Phone. These can only be edited on the mobile phone. The changes are transferred and updated to Uconnect™ Phone on the next phone connection.

Edit Uconnect™ Phonebook Entries

NOTE:



- Editing names in the phonebook is recommended when the vehicle is not in motion.
- Automatic downloaded phonebook entries cannot be deleted or edited.
- Press the  button to begin.
- After the "Ready" prompt and the following beep, say "Phonebook Edit Entry".
- You will then be asked for the name of the phonebook entry that you wish to edit.
- Next, choose the number designation (home, work, mobile, or other) that you wish to edit.
- When prompted, recite the new phone number for the phonebook entry that you are editing.

After you are finished editing an entry in the phonebook, you will be given the opportunity to edit another entry in the phonebook, call the number you just edited, or return to the main menu.

“Phonebook Edit Entry” can be used to add another phone number to a name entry that already exists in the phonebook. For example, the entry John Doe may have a mobile and a home number, but you can add “John Doe’s” work number later using the “Phonebook Edit Entry” feature.

Delete Uconnect™ Phonebook Entry



NOTE: Editing phonebook entries is recommended when the vehicle is not in motion.

- Press the  button to begin.
- After the “Ready” prompt and the following beep, say “Phonebook Delete”.
- After you enter the Phonebook Delete menu, you will then be asked for the name of the entry that you wish to delete. You can either say the name of a phonebook entry that you wish to delete or you can say “List Names” to hear a list of the entries in the phonebook from which you choose. To select one of the entries from the list, press the  button while the Uconnect™ Phone is playing the desired entry and say “Delete”.
- After you enter the name, the Uconnect™ Phone will ask you which designation you wish to delete: home, work, mobile, other, or all. Say the designation you wish to delete.
- Note that only the phonebook entry in the current language is deleted.
- Automatic downloaded phonebook entries cannot be deleted or edited.

Delete/Erase “All” Uconnect™ Phonebook Entries

- Press the  button to begin.
- After the “Ready” prompt and the following beep, say “Phonebook Erase All”.
- The Uconnect™ Phone will ask you to verify that you wish to delete all the entries from the phonebook.
- After confirmation, the phonebook entries will be deleted.
- Note that only the phonebook in the current language is deleted.
- Automatic downloaded phonebook entries cannot be deleted or edited.

List All Names In The Uconnect™ Phonebook

- Press the  button to begin.
- After the “Ready” prompt and the following beep, say “Phonebook List Names”.
- The Uconnect™ Phone will play the names of all the phonebook entries, including the downloaded phonebook entries, if available.
- To call one of the names in the list, press the  button during the playing of the desired name, and say “Call”.



NOTE: The user can also exercise “Edit” or “Delete” operations at this point.

- The Uconnect™ Phone will then prompt you as to the number designation you wish to call.
- The selected number will be dialed.

Phone Call Features

The following features can be accessed through the Uconnect™ Phone if the feature(s) are available on your mobile service plan. For example, if your mobile service plan provides three-way calling, this feature can be accessed through the Uconnect™ Phone. Check with your mobile service provider for the features that you have.

Answer Or Reject An Incoming Call — No Call Currently In Progress

When you receive a call on your mobile phone, the Uconnect™ Phone will interrupt the vehicle audio system, if on, and will ask if you would like to answer the call. Press the  button to accept the call. To reject the call, press and hold the  button until you hear a single beep, indicating that the incoming call was rejected.

Answer Or Reject An Incoming Call — Call Currently In Progress

If a call is currently in progress and you have another incoming call, you will hear the same network tones for call waiting that you normally hear when using your mobile phone. Press the  button to place the current call on hold and answer the incoming call.



NOTE: The Uconnect™ Phone compatible phones in the market today do not support rejecting an incoming call when another call is in progress. Therefore, the user can only answer an incoming call or ignore it.

Making A Second Call While Current Call Is In Progress

To make a second call while you are currently on a call, press the  button and say “Dial” or “Call” followed by the phone number or phonebook entry you wish to call. The first call will be on hold while the second call is

in progress. To go back to the first call, refer to “Toggling Between Calls” in this section. To combine two calls, refer to “Conference Call” in this section.

Place/Retrieve A Call From Hold

To put a call on hold, press the  button until you hear a single beep. This indicates that the call is on hold. To bring the call back from hold, press and hold the  button until you hear a single beep.



Toggling Between Calls

If two calls are in progress (one active and one on hold), press the  button until you hear a single beep, indicating that the active and hold status of the two calls have switched. Only one call can be placed on hold at a time.



Conference Call

When two calls are in progress (one active and one on hold), press and hold the  button until you hear a double beep indicating that the two calls have been joined into one conference call.

Three-Way Calling

To initiate three-way calling, press the  button while a call is in progress, and make a second phone call, as described under “Making a Second Call While Current Call is in Progress”. After the second call has established, press and hold the  button until you hear a double beep, indicating that the two calls have been joined into one conference call.

Call Termination

To end a call in progress, momentarily press the  button. Only the active call(s) will be terminated and if there is a call on hold, it will become the new active call. If the active call is terminated by the phone far end, a call on hold may not become active automatically. This is cell phone-dependent. To bring the call back from hold, press and hold the  button until you hear a single beep.

Redial

- Press the  button to begin.
- After the “Ready” prompt and the following beep, say “Redial”.
- The Uconnect™ Phone will call the last number that was dialed from your mobile phone.

NOTE: This may not be the last number dialed from the Uconnect™ Phone.

Call Continuation

Call continuation is the progression of a phone call on the Uconnect™ Phone after the vehicle ignition key has been switched to OFF. Call continuation functionality available on the vehicle can be any one of three types:

- After the ignition key is switched to OFF, a call can continue on the Uconnect™ Phone either until the call ends, or until the vehicle battery condition dictates cessation of the call on the Uconnect™ Phone and transfer of the call to the mobile phone.
- After the ignition key is switched to OFF, a call can continue on the Uconnect™ Phone for a certain duration, after which the call is automatically transferred from the Uconnect™ Phone to the mobile phone.
- An active call is automatically transferred to the mobile phone after the ignition key is switched to OFF.

Uconnect™ Phone Features

Language Selection

To change the language that the Uconnect™ Phone is using:

- Press the  button to begin.
- After the “Ready” prompt and the following beep, say the name of the language you wish to switch to English, Espanol, or Francais.
- Continue to follow the system prompts to complete the language selection.

After selecting one of the languages, all prompts and voice commands will be in that language.

NOTE: After every Uconnect™ Phone language change operation, only the language-specific 32-name phone-book is usable. The paired phone name is not language-specific and is usable across all languages.

Emergency Assistance

If you are in an emergency and the mobile phone is reachable:

- Pick up the phone and manually dial the emergency number for your area.

If the phone is not reachable and the Uconnect™ Phone is operational, you may reach the emergency number as follows:

- Press the  button to begin.
- After the “Ready” prompt and the following beep, say “Emergency” and the Uconnect™ Phone will instruct the paired mobile phone to call the emergency number. This feature is supported in the U.S., Canada, and Mexico.

NOTE:

- The emergency number dialed is based on the country where the vehicle is purchased (911 for the U.S. and

Canada and 060 for Mexico). The number dialed may not be applicable with the available mobile service and area.

- If supported, this number may be programmable on some systems. To do this, press the  button and say “Setup”, followed by “Emergency”.
- The Uconnect™ Phone does slightly lower your chances of successfully making a phone call as to that for the mobile phone directly.

WARNING!

To use your Uconnect™ Phone System in an emergency, your mobile phone must be:

- turned on,
- paired to the Uconnect™ System,
- and have network coverage.

Towing Assistance

If you need towing assistance:

- Press the  button to begin.
- After the “Ready” prompt and the following beep, say “Towing Assistance”.

NOTE:

- The towing assistance number dialed is based on the country where the vehicle is purchased (1-800-528-2069 for the U.S., 1-877-213-4525 for Canada, 55-14-3454 for Mexico City and 1-800-712-3040 for outside Mexico City in Mexico). Please refer to the 24-Hour “Towing Assistance” coverage details on the DVD in the Warranty Information Booklet and the 24-Hour Towing Assistance references.
- If supported, this number may be programmable on some systems. To do this, press the  button and say “Setup”, followed by “Towing Assistance”.

Paging

To learn how to page, refer to “Working with Automated Systems”. Paging works properly except for pagers of certain companies, which time out a little too soon to work properly with the Uconnect™ Phone.



Voice Mail Calling

To learn how to access your voice mail, refer to “Working with Automated Systems”.

Working With Automated Systems

This method is used in instances where one generally has to press numbers on the mobile phone keypad while navigating through an automated telephone system.

You can use your Uconnect™ Phone to access a voice mail system or an automated service, such as a paging service or automated customer service line. Some services require immediate response selection. In some instances, that may be too quick for use of the Uconnect™ Phone.

When calling a number with your Uconnect™ Phone that normally requires you to enter in a touch-tone sequence on your mobile phone keypad, you can press the VR button and say the sequence you wish to enter, followed by the word “Send”. For example, if required to enter your PIN followed with a pound, (3 7 4 6 #), you can press the VR button and say, “3 7 4 6 # Send”. Saying a number, or sequence of numbers, followed by “Send”, is also to be used for navigating through an automated customer service center menu structure, and to leave a number on a pager.

You can also send stored Uconnect™ phonebook entries as tones for fast and easy access to voice mail and pager entries. To use this feature, dial the number you wish to call and then press the VR button and say, “Send.” The system will prompt you to enter the name or number and say the name of the phonebook entry you wish to send.

The Uconnect™ Phone will then send the corresponding phone number associated with the phonebook entry, as tones over the phone.

NOTE:

- You may not hear all of the tones due to mobile phone network configurations. This is normal.
- Some paging and voice mail systems have system time out settings that are too short and may not allow the use of this feature.

Barge In — Overriding Prompts

The “Voice Command” button can be used when you wish to skip part of a prompt and issue your voice command immediately. For example, if a prompt is asking “Would you like to pair a phone, clear a...,” you could press the  button and say, “Pair a Phone” to select that option without having to listen to the rest of the voice prompt.

Turning Confirmation Prompts ON/OFF

Turning confirmation prompts off will stop the system from confirming your choices (e.g., the Uconnect™ Phone will not repeat a phone number before you dial it).

- Press the  button to begin.
- After the “Ready” prompt and the following beep, say one of the following:
 - “Setup Confirmation Prompts On”
 - “Setup Confirmation Prompts Off”

Phone And Network Status Indicators

If available on the radio and/or on a premium display such as the instrument panel cluster, and supported by your mobile phone, the Uconnect™ Phone will provide notification to inform you of your phone and network status when you are attempting to make a phone call using Uconnect™ Phone. The status is given for network signal strength, phone battery strength, etc.

Dialing Using The Mobile Phone Keypad

You can dial a phone number with your mobile phone keypad and still use the Uconnect™ Phone (while dialing via the mobile phone keypad, the user must exercise caution and take precautionary safety measures). By dialing a number with your paired Bluetooth® mobile phone, the audio will be played through your vehicle's audio system. The Uconnect™ Phone will work the same as if you dial the number using Voice Command.

NOTE: Certain brands of mobile phones do not send the dial ring to the Uconnect™ Phone to play it on the vehicle audio system, so you will not hear it. Under this situation, after successfully dialing a number the user may feel that the call did not go through even though the call is in progress. Once your call is answered, you will hear the audio.

Mute/Un-Mute (Mute OFF)

When you mute the Uconnect™ Phone, you will still be able to hear the conversation coming from the other party, but the other party will not be able to hear you. In order to mute the Uconnect™ Phone:

- Press the  VR button.
- Following the beep, say "Mute".

In order to un-mute the Uconnect™ Phone:

- Press the  VR button.
- Following the beep, say "Mute off".

Advanced Phone Connectivity

Transfer Call To And From Mobile Phone

The Uconnect™ Phone allows ongoing calls to be transferred from your mobile phone to the Uconnect™ Phone without terminating the call. To transfer an ongoing call

from your Uconnect™ Phone paired mobile phone to the Uconnect™ Phone or vice versa, press the  button and say “Transfer Call”.

Connect Or Disconnect Link Between The Uconnect™ Phone And Mobile Phone

Your mobile phone can be paired with many different electronic devices, but can only be actively “connected” with one electronic device at a time.

If you would like to connect or disconnect the Bluetooth® connection between your mobile phone and the Uconnect™ Phone System, follow the instructions described in your mobile phone User’s Manual.



List Paired Mobile Phone Names

- Press the  button to begin.
- After the “Ready” prompt and the following beep, say “Setup Phone Pairing”.

- When prompted, say “List Phones”.
- The Uconnect™ Phone will play the phone names of all paired mobile phones in order from the highest to the lowest priority. To “Select” or “Delete” a paired phone being announced, press the  button and say “Select” or “Delete”. Also, see the next two sections for an alternate way to “Select” or “Delete” a paired phone.



Select Another Mobile Phone

This feature allows you to select and start using another phone paired with the Uconnect™ Phone.

- Press the  button to begin.
- After the “Ready” prompt and the following beep, say “Setup Select Phone” and follow the prompts.
- You can also press the  button at any time while the list is being played, and then choose the phone that you wish to select.

- The selected phone will be used for the next phone call. If the selected phone is not available, the Uconnect™ Phone will return to using the highest priority phone present in or near (approximately within 30 ft (9 m)) the vehicle.

Delete Uconnect™ Phone Paired Mobile Phones

- Press the  button to begin.
- After the “Ready” prompt and the following beep, say “Setup Phone Pairing”.
- At the next prompt, say “Delete” and follow the prompts.
- You can also press the  button at any time while the list is being played, and then choose the phone you wish to delete.

Things You Should Know About Your Uconnect™ Phone



Uconnect™ Phone Tutorial

To hear a brief tutorial of the system features, press the  button and say “Uconnect™ Tutorial.”

Voice Training

For users experiencing difficulty with the system recognizing their voice commands or numbers, the Uconnect™ Phone Voice Training feature may be used. To enter this training mode, follow one of the two following procedures:

From outside the Uconnect™ Phone mode (e.g., from radio mode):

- Press and hold the  button for five seconds until the session begins, or,
- Press the  button and say the “Voice Training, System Training, or Start Voice Training” command.

You can either press the Uconnect™ Phone button to restore the factory setting or repeat the words and phrases when prompted by the Uconnect™ Phone. For best results, the Voice Training session should be completed when the vehicle is parked with the engine running, all windows closed, and the blower fan switched off.

This procedure may be repeated with a new user. The system will adapt to the last trained voice only.

Reset

- press the  button.
- After the “Ready” prompt, and the following beep, say “Setup”, then “Reset”.

This will delete all phone pairing, phone book entries, and other settings in all language modes. The System will prompt you before resetting to factory settings.

Voice Command

- For best performance, adjust the rearview mirror to provide at least ½ in (1 cm) gap between the overhead console (if equipped) and the mirror.
- Always wait for the beep before speaking.
- Speak normally, without pausing, just as you would speak to a person sitting a few feet/meters away from you.
- Make sure that no one other than you is speaking during a Voice Command period.
- Performance is maximized under:
 - low-to-medium blower setting,
 - low-to-medium vehicle speed,
 - low road noise,
 - smooth road surface,

- fully closed windows,
- dry weather condition.
- Even though the system is designed for users speaking in North American English, French, and Spanish accents, the system may not always work for some.
- When navigating through an automated system such as voice mail, or when sending a page, at the end of speaking the digit string, make sure to say "Send".
- Storing names in the phonebook when the vehicle is not in motion is recommended.
- It is not recommended to store similar sounding names in the Uconnect™ Phonebook.
- Phonebook (Downloaded and Uconnect™ Phone Local) name recognition rate is optimized when the entries are not similar.
- Numbers must be spoken in single digits. "800" must be spoken "eight-zero-zero" not "eight hundred".
- You can say "O" (letter "O") for "0" (zero).
- Even though international dialing for most number combinations is supported, some shortcut dialing number combinations may not be supported.
- In a convertible vehicle, system performance may be compromised with the convertible top down.

Far End Audio Performance

- Audio quality is maximized under:
 - low-to-medium blower setting,
 - low-to-medium vehicle speed,
 - low road noise,
 - smooth road surface,

- fully closed windows,
- dry weather conditions, and
- operation from the driver's seat.
- Performance, such as audio clarity, echo, and loudness to a large degree rely on the phone and network, and not the Uconnect™ Phone.
- Echo at the phone far end can sometimes be reduced by lowering the in-vehicle audio volume.
- In a convertible vehicle, system performance may be compromised with the convertible top down.

Recent Calls

If your phone supports “Automatic Phonebook Download”, Uconnect™ Phone can list your Outgoing, Incoming and Missed Calls.

SMS

Uconnect™ Phone can read or send new messages on your phone.

Read Messages:

If you receive a new text message while your phone is connected to Uconnect™ Phone, an announcement will be made to notify you that you have a new text message. If you wish to hear the new message:

- Press the  button.
- After the “Ready” prompt and the following beep, say “SMS Read” or “Read Messages.”
- Uconnect™ Phone will play the new text message for you.

After reading a message, you can “Reply” or “Forward” the message using Uconnect™ Phone.

Send Messages:

You can send messages using Uconnect™ Phone. To send a new message:

- Press the  button.
- After the “Ready” prompt and the following beep, say “SMS Send” or “Send Message.”
- You can either say the message you wish to send or say “List Messages.” There are 20 preset messages.

To send a message, press the  button while the system is listing the message and say “Send.”

Uconnect™ Phone will prompt you to say the name or number of the person you wish to send the message to.

List of Preset Messages:

1. Yes
2. No

3. Where are you?
4. I need more direction.
5. L O L
6. Why
7. I love you
8. Call me
9. Call me later
10. Thanks
11. See You in 15 minutes
12. I am on my way
13. I'll be late
14. Are you there yet?
15. Where are we meeting?

16. Can this wait?
17. Bye for now
18. When can we meet
19. Send number to call
20. Start without me

Turn SMS Incoming Announcement ON/OFF

Turning the SMS Incoming Announcement OFF will stop the system from announcing the new incoming messages.

- Press the  button.
- After the “Ready” prompt and the following beep, say “Setup, SMS Incoming Message Announcement,” you will then be given a choice to change it.

Bluetooth® Communication Link

Mobile phones have been found to lose connection to the Uconnect™ Phone. When this happens, the connection can generally be reestablished by switching the phone off/on. Your mobile phone is recommended to remain in Bluetooth® ON mode.

Power-Up

After switching the ignition key from OFF to either the ON or ACC position, or after a language change, you must wait at least fifteen seconds prior to using the system.

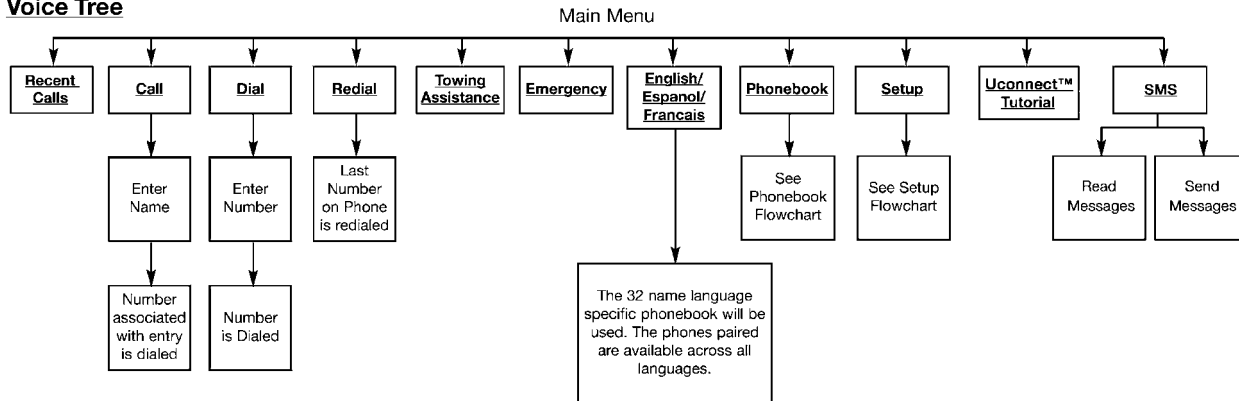
Voice Tree

Note: Available Voice commands are shown in bold face and are underlined.

Voice Tree – Phonebook

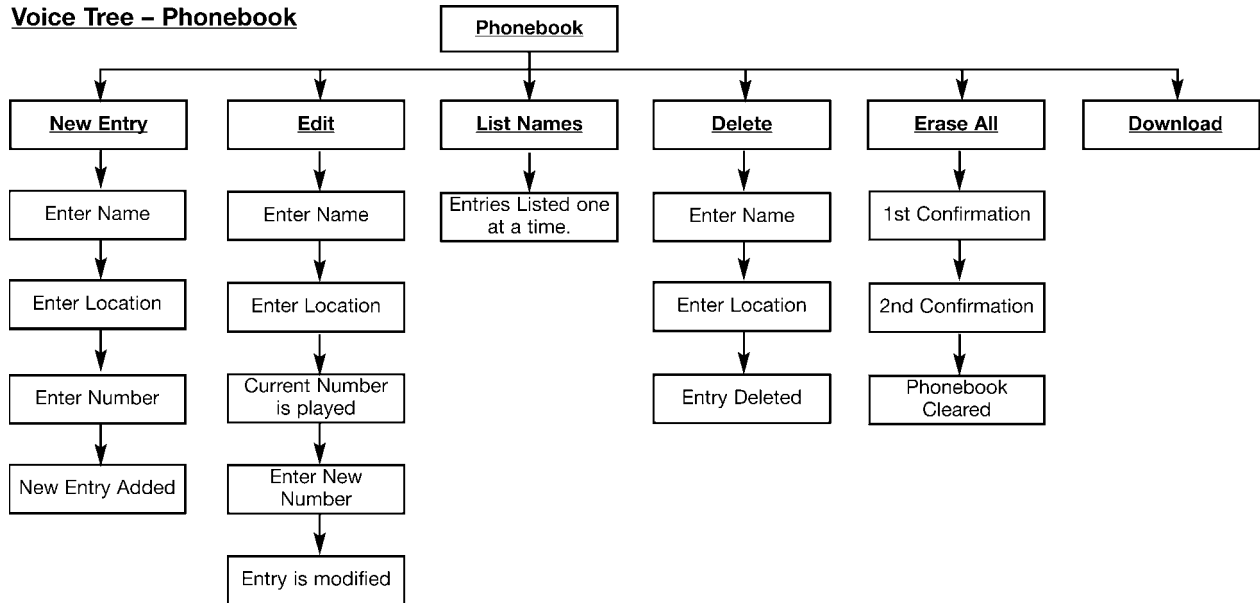

Note: Available Voice commands are shown in bold face and are underlined.

Voice Tree – Setup

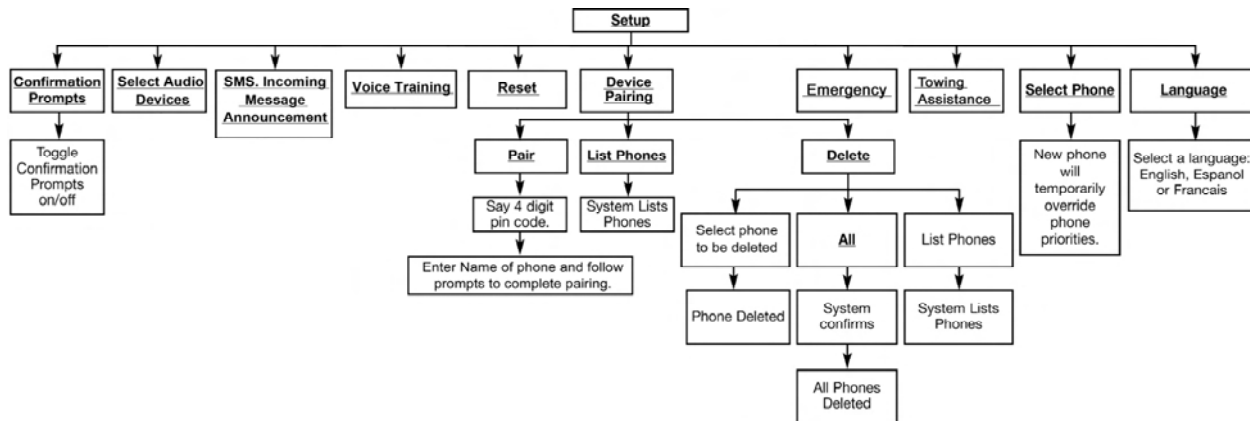

Note: Available Voice commands are shown in bold face and are underlined.

030605540

Voice Commands	
Primary	Alternate(s)
zero	
one	
two	
three	
four	
five	
six	
seven	
eight	
nine	
star (*)	
plus (+)	
pound (#)	
add location	
all	

Voice Commands	
Primary	Alternate(s)
call	
cancel	
confirmation prompts	
continue	
delete	
dial	
download	
edit	
emergency	
English	
erase all	
Espanol	
Francais	
help	
home	

Voice Commands	
Primary	Alternate(s)
language	
list names	
list phones	
mobile	
mute	
mute off	
new entry	
no	
other	
pair a phone	
phone pairing	pairing
phonebook	phone book
previous	
record again	
redial	

Voice Commands	
Primary	Alternate(s)
return to main menu	return or main menu
select phone	select
send	
set up	phone settings or phone set up
towing assistance	
transfer call	
Uconnect™ Tutorial	
try again	
voice training	
work	
yes	

General Information

This device complies with Part 15 of the FCC rules and RSS 210 of Industry Canada. Operation is subject to the following conditions:

- Changes or modifications not expressly approved by the party responsible for compliance could void the user's authority to operate the equipment.
- This device may not cause harmful interference.
- This device must accept any interference received, including interference that may cause undesired operation.

VOICE COMMAND — IF EQUIPPED

Voice Command System Operation

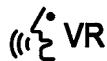

This Voice Command system allows you to control your AM, FM radio, satellite radio, disc player, and a memo recorder.

NOTE: Take care to speak into the Voice Interface System as calmly and normally as possible. The ability of the Voice Interface System to recognize user voice commands may be negatively affected by rapid speaking or a raised voice level.

WARNING!

Any voice commanded system should be used only in safe driving conditions following local laws. All attention should be kept on the roadway ahead. Failure to do so may result in a collision causing serious injury or death.

When you press the Voice Command  button, you will hear a beep. The beep is your signal to give a command.

NOTE: If you do not say a command within a few seconds, the system will present you with a list of options.

If you ever wish to interrupt the system while it lists options, press the Voice Command  button, listen for the beep, and say your command.

Pressing the Voice Command  button while the system is speaking is known as “barging in.” The system will be interrupted, and after the beep, you can add or change commands. This will become helpful once you start to learn the options.

NOTE: At any time, you can say the words “Cancel”, “Help” or “Main Menu”.

These commands are universal and can be used from any menu. All other commands can be used depending upon the active application.

When using this system, you should speak clearly and at a normal speaking volume.

The system will best recognize your speech if the windows are closed, and the heater/air conditioning fan is set to low.

At any point, if the system does not recognize one of your commands, you will be prompted to repeat it.

To hear the first available Menu, press the Voice Command  button and say “Help” or “Main Menu”.

Commands

The Voice Command system understands two types of commands. Universal commands are available at all times. Local commands are available if the supported radio mode is active.

Changing the Volume

1. Start a dialogue by pressing the Voice Command  button.

2. Say a command (e.g., “Help”).
3. Use the ON/OFF VOLUME rotary knob to adjust the volume to a comfortable level while the Voice Command system is speaking. Please note the volume setting for Voice Command is different than the audio system.

Main Menu

Start a dialogue by pressing the Voice Command  button. You may say “Main Menu” to switch to the main menu.

In this mode, you can say the following commands:

- “Radio” (to switch to the radio mode)
- “Disc” (to switch to the disc mode)
- “Memo” (to switch to the memo recorder)
- “Setup” (to switch to system setup)

Radio AM

To switch to the AM band, say “AM” or “Radio AM”. In this mode, you may say the following commands:

- “Frequency #” (to change the frequency)
- “Next Station” (to select the next station)
- “Previous Station” (to select the previous station)
- “Radio Menu” (to switch to the radio menu)
- “Main Menu” (to switch to the main menu)

Radio FM

To switch to the FM band, say “FM” or “Radio FM”. In this mode, you may say the following commands:

- “Frequency #” (to change the frequency)
- “Next Station” (to select the next station)
- “Previous Station” (to select the previous station)

- “Menu Radio” (to switch to the radio menu)
- “Main Menu” (to switch to the main menu)

Satellite Radio

To switch to satellite radio mode, say “Sat” or “Satellite Radio”. In this mode, you may say the following commands:

- “Channel Number” (to change the channel by its spoken number)
- “Next Channel” (to select the next channel)
- “Previous Channel” (to select the previous channel)
- “List Channel” (to hear a list of available channels)
- “Select Name” (to say the name of a channel)
- “Menu Radio” (to switch to the radio menu)
- “Main Menu” (to switch to the main menu)

Disc

To switch to the disc mode, say “Disc”. In this mode, you may say the following commands:

- “Track” (#) (to change the track)
- “Next Track” (to play the next track)
- “Previous Track” (to play the previous track)
- “Main Menu” (to switch to the main menu)

Memo

To switch to the voice recorder mode, say “Memo”. In this mode, you may say the following commands:

- “New Memo” (to record a new memo) — During the recording, you may press the Voice Command ( VR button to stop recording. You proceed by saying one of the following commands:
 - “Save” (to save the memo)

- “Continue” (to continue recording)
- “Delete” (to delete the recording)
- “Play Memos” (to play previously recorded memos)
 - During the playback you may press the Voice Command (Ⓜ️) button to stop playing memos. You proceed by saying one of the following commands:
 - “Repeat” (to repeat a memo)
 - “Next” (to play the next memo)
 - “Previous” (to play the previous memo)
 - “Delete” (to delete a memo)
- “Delete All” (to delete all memos)

Setup

To switch to system setup, you may say on of the following:

- “Change to setup”

- “Switch to system setup”
- “Change to setup”
- “Main menu setup” or
- “Switch to setup”

In this mode, you may say the following commands:

- “Language English”
- “Language French”
- “Language Spanish”
- “Tutorial”
- “Voice Training”

NOTE: Keep in mind that you have to press the Voice Command (Ⓜ️) button first and wait for the beep before speaking the “Barge In” commands.

Voice Training

For users experiencing difficulty with the system recognizing their voice commands or numbers the Uconnect™ Voice “Voice Training” feature may be used.

1. Press the Voice Command  button, say “System Setup” and once you are in that menu then say “Voice Training.” This will train your own voice to the system and will improve recognition.

2. Repeat the words and phrases when prompted by Uconnect™ Voice. For best results, the “Voice Training” session should be completed when the vehicle is parked, engine running, all windows closed, and the blower fan switched off. This procedure may be repeated with a new user. The system will adapt to the last trained voice only.

SEATS

Seats are a part of the Occupant Restraint System of the vehicle.

WARNING!

- It is dangerous to ride in a cargo area, inside or outside of a vehicle. In a collision, people riding in these areas are more likely to be seriously injured or killed.
- Do not allow people to ride in any area of your vehicle that is not equipped with seats and seat belts. In a collision, people riding in these areas are more likely to be seriously injured or killed.
- Be sure everyone in your vehicle is in a seat and using a seat belt properly.

Power Seats — If Equipped

Some models may be equipped with a power driver’s seat. The power seat switch is located on the outboard side of the seat near the floor. Use the switch to move the seat up, down, forward, rearward, or to tilt the seat.



Power Seat Switch

Adjusting The Seat Forward Or Rearward

The seat can be adjusted both forward and rearward. Push the seat switch forward or rearward, the seat will move in the direction of the switch. Release the switch when the desired position has been reached.

Adjusting The Seat Up Or Down

The height of the seats can be adjusted up or down. Pull upward or push downward on the seat switch, the seat will move in the direction of the switch. Release the switch when the desired position has been reached.

Tilting The Seat Up Or Down

The angle of the seat cushion can be adjusted in four directions. Pull upward or push downward on the front or rear of the seat switch, the front or rear of the seat cushion will move in the direction of the switch. Release the switch when the desired position has been reached.

3

WARNING!

- **Adjusting a seat while driving may be dangerous. Moving a seat while driving could result in loss of control which could cause a collision and serious injury or death.**

(Continued)

WARNING! (Continued)

- Seats should be adjusted before fastening the seat belts and while the vehicle is parked. Serious injury or death could result from a poorly adjusted seat belt.

CAUTION!

Do not place any article under a power seat or impede its ability to move as it may cause damage to the seat controls. Seat travel may become limited if movement is stopped by an obstruction in the seat's path.

Heated Seats — If Equipped

On some models, the front driver and passenger seats may be equipped with heaters in both the seat cushions and seatbacks.

You can choose from HIGH, LOW or OFF heat settings. Amber indicator lights in each switch indicate the level of heat in use. Two indicator lights will illuminate for HIGH, one for LOW and none for OFF.



Press the switch once to select HIGH-level heating. Press the switch a second time to select LOW-level heating. Press the switch a third time to shut the heating elements OFF.

If HIGH-level heating is selected, the system automatically switches to LOW-level heating and turns one indicator light off after 30 minutes of continuous operation. It will turn the heater and the remaining indicator light off after an additional 30 minutes of continuous operation. If LOW-level heating is selected, the system automatically turns the heater and the indicator light off after 30 minutes of continuous operation.

NOTE: Once a heat setting is selected, heat will be felt within two to five minutes.

WARNING!

- Persons who are unable to feel pain to the skin because of advanced age, chronic illness, diabetes, spinal cord injury, medication, alcohol use, exhaustion or other physical condition must exercise care when using the seat heater. It may cause burns even at low temperatures, especially if used for long periods of time.
- Do not place anything on the seat that insulates against heat, such as a blanket or cushion. This may cause the seat heater to overheat. Sitting in a seat that has been overheated could cause serious burns due to the increased surface temperature of the seat.

Manual Front Seat Forward/Rearward Adjustment

On models equipped with manual seats, the adjusting bar is located at the front of the seats, near the floor.



030907665

Front Seat Adjustment

While sitting in the seat, lift up on the bar and move the seat forward or rearward. Release the bar once you have reached the desired position. Then, using body pressure, move forward and rearward on the seat to be sure that the seat adjusters have latched.

WARNING!

- Adjusting a seat while driving may be dangerous. Moving a seat while driving could result in loss of control which could cause a collision and serious injury or death.
- Seats should be adjusted before fastening the seat belts and while the vehicle is parked. Serious injury or death could result from a poorly adjusted seat belt.

Manual Seat Height Adjustment — If Equipped

The driver's seat height can be raised or lowered by using a lever, located on the outboard side of the seat. Pull upward on the lever to raise the seat height or push downward on the lever to lower the seat height.



030907660

Seat Height Adjustment**Manual Lumbar — If Equipped**

The lumbar adjustment lever is located on the outboard side of the driver's seatback. Rotate the lever downward to increase the lumbar support or rotate the lever upward to decrease the lumbar support.



030907661

Lumbar Adjustment

Driver's Seatback Recline

To adjust the seatback, lift the lever located on the outboard side of the seat, lean back to the desired position and release the lever. To return the seatback, lift the lever, lean forward and release the lever.



030907662

Recline Lever

WARNING!

Do not ride with the seatback reclined so that the shoulder belt is no longer resting against your chest. In a collision you could slide under the seat belt, which could result in serious injury or death.

Fold-Flat Front Passenger Seat

To fold the front passenger seat, lift the recliner lever to the full upward position and push the seatback forward until it rests on the seat cushion.



030907664

Fold-Flat Front Passenger Seat Lever

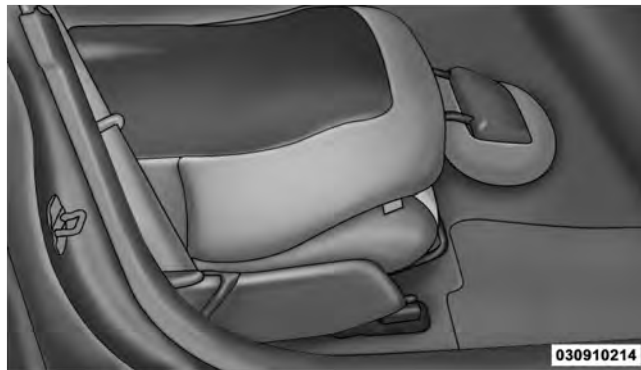

030910214

Front Passenger Seat Folded Flat

Head Restraints

Head restraints are designed to reduce the risk of injury by restricting head movement in the event of a rear impact. Head restraints should be adjusted so that the top of the head restraint is located above the top of your ear.

WARNING!

The head restraints for all occupants must be properly adjusted prior to operating the vehicle or occupying a seat. Head restraints should never be adjusted while the vehicle is in motion. Driving a vehicle with the head restraints improperly adjusted or removed could cause serious injury or death in the event of a collision.

Active Head Restraints — Front Seats

Active Head Restraints are passive, deployable components, and vehicles with this equipment can not be

readily identified by any markings, only through visual inspection of the head restraint. The head restraint will be split in two halves, with the front half being soft foam and trim, the back half being decorative plastic.

When AHRs deploy during a rear impact, the front half of the head restraint extends forward to minimize the gap between the back of the occupant's head and the AHR. This system is designed to help prevent or reduce the extent of injuries to the driver and front passenger in certain types of rear impacts. Refer to "Occupant Restraints" in "Things To Know Before Starting Your Vehicle" for further information.

140 UNDERSTANDING THE FEATURES OF YOUR VEHICLE

To raise the head restraint, pull upward on the head restraint. To lower the head restraint, press the push button, located at the base of the head restraint, and push downward on the head restraint.

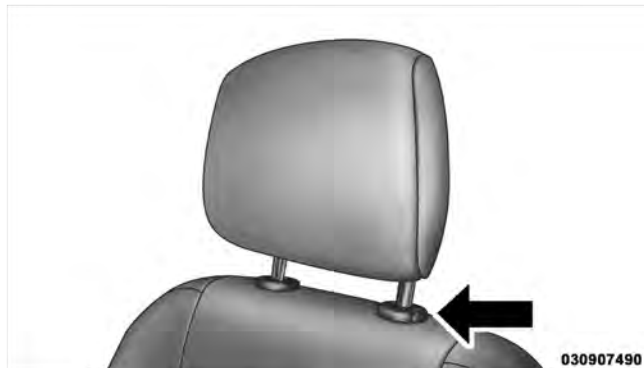

Push Button

For comfort the Active Head Restraints can be tilted forward and backward. To tilt the head restraint closer to the back of your head, pull forward on the bottom of the head restraint. Push rearward on the bottom of the head restraint to move the head restraint away from your head.



Active Head Restraint (Normal Position)

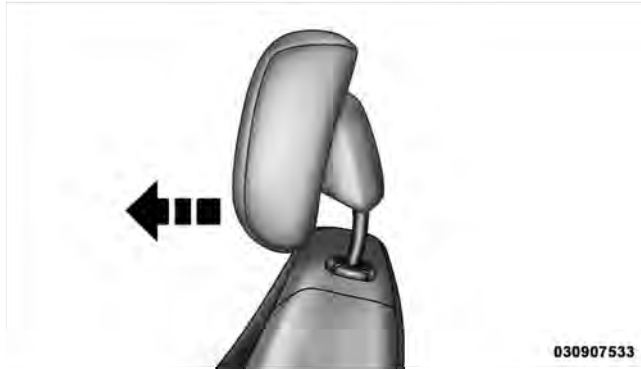

030907533

Active Head Restraint (Tilted)

NOTE:

- The head restraints should only be removed by qualified technicians, for service purposes only. If either of the head restraints require removal, see your authorized dealer.

- In the event of deployment of an Active Head Restraint, refer to “Occupant Restraints/Resetting Active Head Restraints (AHR)” in “Things To Know Before Starting Your Vehicle” for further information.

WARNING!

- Do not place items over the top of the Active Head Restraint, such as coats, seat covers or portable DVD players. These items may interfere with the operation of the Active Head Restraint in the event of a collision and could result in serious injury or death.

(Continued)

WARNING! (Continued)

- **Active Head Restraints may be deployed if they are struck by an object such as a hand, foot or loose cargo. To avoid accidental deployment of the Active Head Restraint ensure that all cargo is secured, as loose cargo could contact the Active Head Restraint during sudden stops. Failure to follow this warning could cause personal injury if the Active Head Restraint is deployed.**

Rear Head Restraints

The head restraints in the rear are non adjustable. Refer to "Occupant Restraints" in "Things to Know Before Starting Your Vehicle" for information on Tether routing.

Folding Rear Seat

To provide additional storage area, each rear seatback can be folded forward. Pull the strap forward to move the seat forward and flat.

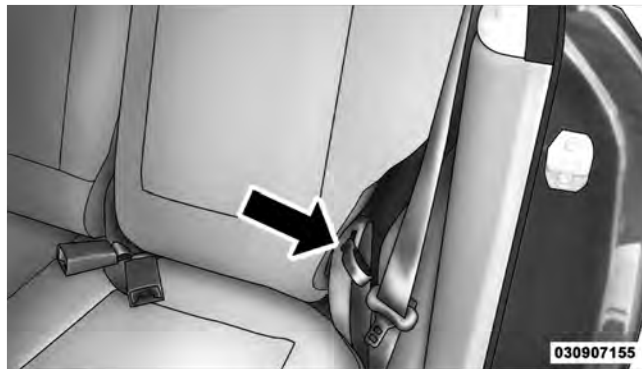

Folding Seat Strap

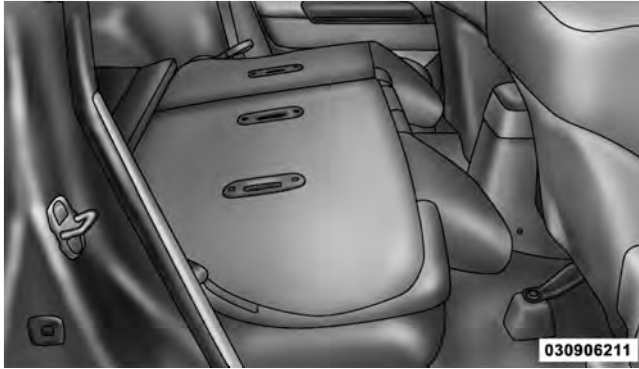

Rear Seats Folded Flat

Reclining Rear Seat — If Equipped

For additional comfort, pull the strap forward just enough to release the seatback latch.



Reclining Rear Seat Strap

144 UNDERSTANDING THE FEATURES OF YOUR VEHICLE

Then push the seatback to a reclined position, approximately 35 degrees maximum, and release the strap.

WARNING!

Do not ride with the seatback reclined so that the shoulder belt is no longer resting against your chest. In a collision you could slide under the seat belt, which could result in serious injury or death.

TO OPEN AND CLOSE THE HOOD

To open the hood, two latches must be released.

1. Pull the hood release lever located on the left kick panel.

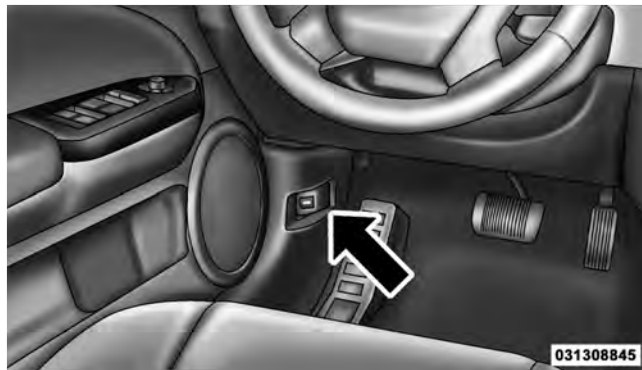

Hood Release Lever

2. Move the safety catch located under the front edge of the hood, near the center and raise the hood.



031308846

Safety Catch

Lift the hood prop rod, clipped to the right side (left side when standing in front of hood) of the engine compartment, to secure the hood in the open position. Place the hood prop at the location stamped into the inner hood surface.

CAUTION!

To prevent possible damage, do not slam the hood to close it. Lower the hood until it is open approximately 8 in (20 cm) and then drop it. This should secure both latches. Never drive your vehicle unless the hood is fully closed, with both latches engaged.

WARNING!

Be sure the hood is fully latched before driving your vehicle. If the hood is not fully latched, it could open when the vehicle is in motion and block your vision. Failure to follow this warning could result in serious injury or death.

LIGHTS

Multifunction Lever

The multifunction lever controls the operation of the headlights, parking lights, turn signals, headlight beam selection, instrument panel light dimming, interior lights, the passing lights and fog lights. The multifunction lever is located on the left side of the steering column.



031407547

Multifunction Lever

Headlights And Parking Lights

Turn the end of the multifunction lever to the first detent for parking light operation. Turn the multifunction lever to the second detent for headlight operation.



031407548

Headlight Control

Daytime Running Lights — If Equipped

This feature may be performed by either low beam headlights or by high beam headlights, depending on the specific regulations of your geographical area. Daytime Running Lights (DRL), may operate at a lower intensity than the normal lamp operation. The high beam headlights will come on as Daytime Running Lights (DRL), which is at a lower intensity than the normal high beams. The DRL's will come on whenever the ignition is ON, the engine is running, the headlight switch is off, the parking brake is off, the turn signal is off, and the shift lever is in any position except for PARK.

NOTE: The DRLs will automatically turn off when the turn signals or Hazard Warning flashers are in operation and automatically turn back on when the turn signals and Hazard Warning flashers are not operating.

Lights-On Reminder

If the headlights or parking lights are on after the ignition is turned OFF, a chime will sound to alert the driver when the driver's door is opened.

Fog Lights — If Equipped

 The front fog light switch is on the multifunction lever. To activate the front fog lights, turn on the parking lights or the low beam headlights and pull out the end of the multifunction lever.



Fog Light Control

NOTE: The fog lights will only operate when the parking lights or the low beam headlight are on. Switching from low beam to high beam headlights will cause the fog lights to turn off.

Turn Signals

Move the multifunction lever up or down and the arrows on each side of the instrument cluster flash to show proper operation of the front and rear turn signal lights.

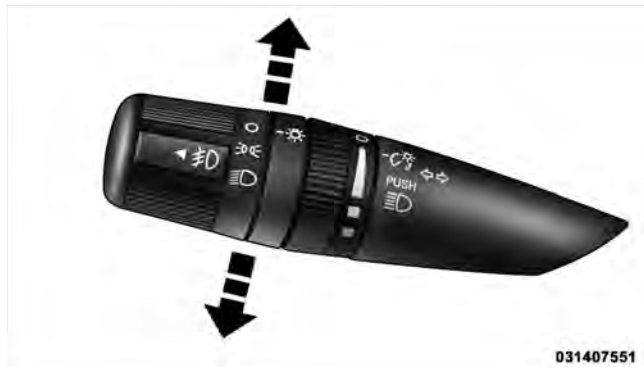

Turn Signal Control

NOTE: If either light remains on and does not flash, or there is a very fast flash rate, check for a defective outside light bulb. If an indicator fails to light when the lever is moved, it would suggest that the indicator bulb is defective.

Lane Change Assist

Tap the lever up or down once, without moving beyond the detent, and the turn signal (right or left) will flash three times then automatically turn off.

High/Low Beam Switch

Push the multifunction lever away from you to switch the headlights to high beam. Pull the multifunction lever toward you to switch the headlights back to low beam.

Flash-To-Pass

You can signal another vehicle with your headlights by lightly pulling the multifunction lever toward you. This turn on the high beam headlights until the multifunction lever is released.

NOTE: If the multifunction lever is held in the flash-to-pass position for more than 30 seconds, the high beams will shut off. If this occurs, wait 30 seconds for the next flash-to-pass operation.

Instrument Panel Dimmer

Rotate the center portion of the lever to the extreme bottom position to fully dim the instrument panel lights and prevent the interior lights from illuminating when a door is opened.

Rotate the center portion of the lever up to increase the brightness of the instrument panel lights when the parking lights or headlights are on.

Rotate the center portion of the lever upward to the next detent position to brighten the odometer and radio when the parking lights or headlights are on.

Rotate the center portion of the lever upward to the last detent to turn on the interior lighting.

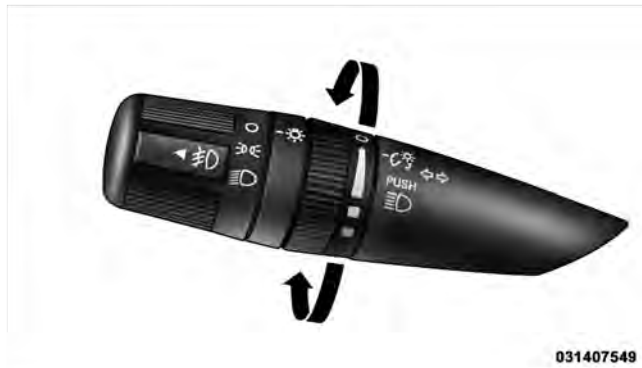

031407549

Dimmer Control

Map/Reading Lights

These lights are mounted between the sun visors above the rearview mirror. Each light is turned on by pressing the button. Press the button a second time to turn the light off. The lights also come on when a door is opened or the dimmer control is turned fully upward, past the second detent.



031409884

Map/Reading Lights

NOTE: The lights will remain on until the switch is pressed a second time, so be sure they have been turned off before leaving the vehicle. The lights will turn off automatically 10 minutes after the ignition is turned OFF if the door is left open or light is switched on.

WINDSHIELD WIPERS AND WASHERS



The windshield wiper/washer control lever is located on the right side of the steering column. The front wipers are operated by rotating a switch, located on the end of the lever. For information on the rear wiper/washer, refer to “Rear Window Features” in “Understanding The Features Of Your Vehicle”.

3



036407502

Wiper/Washer Control Lever

CAUTION!

- Turn the windshield wipers off when driving through an automatic car wash. Damage to the windshield wipers may result if the wiper control is left in any position other than off.
- In cold weather, always turn off the wiper switch and allow the wipers to return to the “Park” position before turning off the engine. If the wiper switch is left on and the wipers freeze to the windshield, damage to the wiper motor may occur when the vehicle is restarted.
- Always remove any buildup of snow that prevents the windshield wiper blades from returning to the off position. If the windshield wiper control is turned off and the blades cannot return to the off position, damage to the wiper motor may occur.

Windshield Wiper Operation

Rotate the end of the lever upward to the second detent past the intermittent settings for low-speed wiper operation.

Rotate the end of the lever upward to the third detent past the intermittent settings for high-speed wiper operation.



031507503

Wiper Control

Intermittent Wiper System

Use the intermittent wiper when weather conditions make a single wiping cycle, with a variable pause between cycles, desirable. Select the delay interval by turning the end of the lever. Rotate the end of the lever upward (clockwise) to decrease the delay time and downward (counterclockwise) to increase the delay time. The delay can be regulated from a maximum of approximately 18 seconds between cycles, to a cycle every second.

NOTE: The wiper delay times depend on vehicle speed. If the vehicle is moving less than 10 mph (16 km/h), delay times will be doubled.

Windshield Washers

To use the washer, pull the control lever toward you and hold while spray is desired. If the lever is pulled while in the delay range, the wiper will operate in low-speed while the lever is pulled and for two wipe cycles after the lever is released, and then resume the intermittent interval previously selected.

If the lever is pulled while in the off position, the wipers will operate for two wipe cycles, then turn off.

WARNING!

Sudden loss of visibility through the windshield could lead to a collision. You might not see other vehicles or other obstacles. To avoid sudden icing of the windshield during freezing weather, warm the windshield with the defroster before and during windshield washer use.

Mist Feature

Push down on the control lever to activate a single wipe to clear the windshield of road mist or spray from a passing vehicle. As long as the lever is held down, the wipers will continue to operate.



031507504

Mist Control

TILT STEERING COLUMN

This feature allows you to tilt the steering column upward or downward. The tilt control lever is located on the left-side of the steering column, below the turn signal controls.

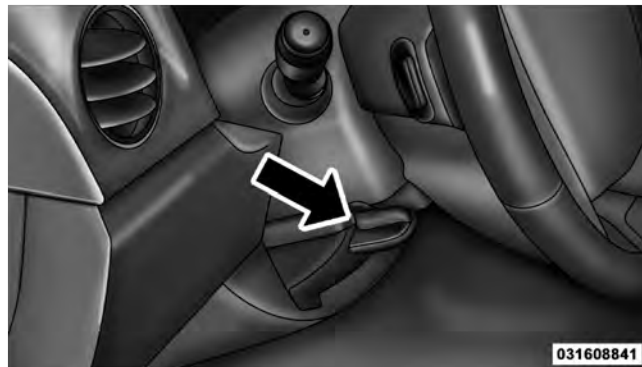

031608841

Tilt Steering Control

Push down on the lever to unlock the column. With one hand firmly on the steering wheel, move the steering column up or down as desired. Push the lever up to lock the column firmly in place.

WARNING!

Do not adjust the steering column while driving. Adjusting the steering column while driving or driving with the steering column unlocked, could cause the driver to lose control of the vehicle. Be sure the steering column is locked before driving your vehicle. Failure to follow this warning may result in serious injury or death.

ELECTRONIC SPEED CONTROL — IF EQUIPPED

When engaged, Electronic Speed Control takes over the accelerator operation at speeds greater than 25 mph (40 km/h). The Electronic Speed Control lever is located on the right side of the steering wheel.



81bc4c2c

Electronic Speed Control Lever

NOTE: In order to ensure proper operation, the Electronic Speed Control System has been designed to shut down if multiple Speed Control functions are operated at the same time. If this occurs, the Electronic Speed Control

System can be reactivated by pushing the Electronic Speed Control ON/OFF button and resetting the desired vehicle set speed.

To Activate

Push the ON/OFF button. The CRUISE indicator in the instrument cluster will illuminate. To turn the system off, push the ON/OFF button a second time. The CRUISE indicator will turn off. The system should be turned off when not in use.

WARNING!

Leaving the Electronic Speed Control system on when not in use is dangerous. You could accidentally set the system or cause it to go faster than you want. You could lose control and have an accident. Always leave the Electronic Speed Control system off when you are not using it.

To Set A Desired Speed

Turn the Electronic Speed Control ON. When the vehicle has reached the desired speed, press down on the Electronic Speed Control lever and release. Release the accelerator and the vehicle will operate at the selected speed.

NOTE: The vehicle should be traveling at a steady speed and on level ground before pressing the SET lever.

To Deactivate

A soft tap on the brake pedal, pulling the Electronic Speed Control lever toward you CANCEL, normal braking or pressing the clutch pedal while slowing the vehicle will deactivate Electronic Speed Control without erasing the set speed memory. Pressing the ON/OFF button or turning the ignition switch OFF erases the set speed memory.

To Resume Speed

To resume a previously set speed, push the RESUME ACCEL lever up and release. Resume can be used at any speed above 20 mph (32 km/h).

To Vary The Speed Setting

When the Electronic Speed Control is set, you can increase speed by pushing up and holding the RESUME ACCEL lever. If the lever is continually held in the RESUME ACCEL position, the set speed will continue to increase until the lever is released, then the new set speed will be established.

Tapping the RESUME ACCEL lever once will result in a 1 mph (2 km/h) increase in set speed. Each subsequent tap of the lever results in an increase of 1 mph (2 km/h).

To decrease speed while the Electronic Speed Control is set, push down and hold the SET DECEL lever. If the lever is continually held in the SET DECEL position, the set speed will continue to decrease until the lever is

released. Release the lever when the desired speed is reached, and the new set speed will be established.

Pressing the SET DECEL lever once will result in a 1 mph (2 km/h) decrease in set speed. Each subsequent tap of the lever results in a decrease of 1 mph (2 km/h).

Manual Transmission

Pressing the clutch pedal will disengage the speed control. A slight increase in engine RPM before the Electronic Speed Control disengages is normal.

Vehicles equipped with manual transmissions may need to be shifted into a lower gear to climb hills without speed loss.

To Accelerate For Passing

Press the accelerator as you would normally. When the pedal is released, the vehicle will return to the set speed.

Using Electronic Speed Control On Hills

NOTE: The Electronic Speed Control system maintains speed, up and down hills. A slight speed change on moderate hills is normal.

On steep hills, a greater speed loss or gain may occur so it may be preferable to drive without Electronic Speed Control.

WARNING!

Electronic Speed Control can be dangerous where the system cannot maintain a constant speed. Your vehicle could go too fast for the conditions, and you could lose control and have an accident. Do not use Electronic Speed Control in heavy traffic or on roads that are winding, icy, snow-covered or slippery.

GARAGE DOOR OPENER — IF EQUIPPED

HomeLink® replaces up to three remote controls (hand-held transmitters) that operate devices such as garage door openers, motorized gates, lighting or home security systems. The HomeLink® unit operates off your vehicle's battery.

The HomeLink® buttons that are located in the headliner or sun visor designate the three different HomeLink® channels.

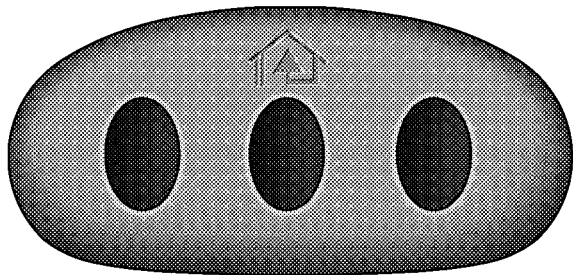

81cb44fe

HomeLink® Buttons

NOTE: HomeLink® is disabled when the Vehicle Security Alarm is active.

WARNING!

- Your motorized door or gate will open and close while you are training the Universal Transceiver. Do not train the transceiver if people, pets or other objects are in the path of the door or gate. Only use this transceiver with a garage door opener that has a “stop and reverse” feature as required by Federal safety standards. This includes most garage door opener models manufactured after 1982. Do not use a garage door opener without these safety features. Call toll-free 1-800-355-3515 or, on the Internet at www.HomeLink.com for safety information or assistance.
- Vehicle exhaust contains carbon monoxide, a dangerous gas. Do not run your vehicle in the garage while training the transceiver. Exhaust gas can cause serious injury or death.

Programming HomeLink®

Before You Begin

If you have not trained any of the HomeLink® buttons, erase all channels before you begin training.

To do this, press and hold the two outside buttons for 20 seconds until the red indicator flashes.

It is recommended that a new battery be placed in the handheld transmitter of the device that is being copied to HomeLink® for more efficient training and accurate transmission of the radio-frequency signal.

Your vehicle should be parked outside of the garage when programming.

1. Turn the ignition switch to the ON/RUN position.
2. Hold the battery side of the handheld transmitter away from the HomeLink® button you wish to program.

Place the handheld transmitter 1–3 in (3-8 cm) away from the HomeLink® button you wish to program while keeping the indicator light in view.

3. Simultaneously press and hold both the chosen HomeLink® button and the handheld transmitter button until the HomeLink® indicator changes from a slow to a rapidly blinking light, then release both the HomeLink® and handheld transmitter buttons.

Watch for the HomeLink® indicator to change flash rates. When it changes, it is programmed. It may take up to 30 seconds or longer in rare cases. The garage door may open and close while you train.

NOTE:

- Some gate operators and garage door openers may require you to replace Step 3 with procedures noted in the “Gate Operator/Canadian Programming” section.

- After training a HomeLink® channel, if the garage door does not operate with HomeLink® and the garage door opener was manufactured after 1995, the garage door opener may have a rolling code. If so, proceed to Step 5 “Programming A Rolling Code System.”

4. Press and hold the just-trained HomeLink® button and observe the indicator light.

If the indicator light stays on constantly, programming is complete and the garage door (or device) should activate when the HomeLink® button is pressed.

If the indicator light blinks rapidly for two seconds, and then turns to a constant light, continue with programming for a Rolling Code.

5. Programming A Rolling Code System

At the garage door opener motor (in the garage), locate the “Learn” or “Training” button.

This can usually be found where the hanging antenna wire is attached to the garage door opener motor (it is NOT the button normally used to open and close the door).

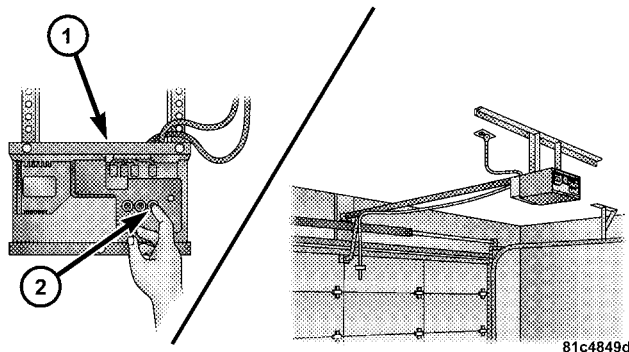

1 — Garage Door Opener
2 — Training Button

81c4849d

6. Firmly press and release the LEARN or TRAINING button. The name and color of the button may vary by manufacturer.

NOTE: You have 30 seconds in which to initiate the next step after the LEARN button has been pressed.

7. Return to the vehicle and press the programmed HomeLink® button twice (holding the button for two seconds each time). If the device is plugged in and activates, programming is complete.

If the device does not activate, press the button a third time (for two seconds) to complete the training.

If you have any problems, or require assistance, please call toll-free 1-800-355-3515 or, on the Internet at www.HomeLink.com for information or assistance.

To program the remaining two HomeLink® buttons, repeat each step for each remaining button. DO NOT erase the channels.

Gate Operator/Canadian Programming

Canadian radio-frequency laws require transmitter signals to “time-out” (or quit) after several seconds of transmission – which may not be long enough for HomeLink® to pick up the signal during programming. Similar to this Canadian law, some U.S. gate operators are designed to “time-out” in the same manner.

It may be helpful to unplug the device during the cycling process to prevent possible overheating of the garage door or gate motor.

If you are having difficulties programming a garage door opener or a gate operator, replace “Programming HomeLink®” Step 3 with the following:

3. Continue to press and hold the HomeLink® button, while you press and release (“cycle”), your handheld transmitter every two seconds until HomeLink® has successfully accepted the frequency signal. The indicator light will flash slowly and then rapidly when fully trained.

If you unplugged the device for training, plug it back in at this time.

Then proceed with Step 4 under “Programming HomeLink®” earlier in this section.

Using HomeLink®

To operate, press and release the programmed HomeLink® button. Activation will now occur for the trained device (i.e., garage door opener, gate operator, Security system, entry door lock, home/office lighting, etc.,). The handheld transmitter of the device may also be used at any time.

Reprogramming A Single HomeLink® Button

To reprogram a channel that has been previously trained, follow these steps:

1. Turn the ignition switch to the ON/RUN position.

2. Press and hold the desired HomeLink® button until the indicator light begins to flash after 20 seconds. **Do not release the button.**

3. **Without releasing the button**, proceed with Programming HomeLink® Step 2 and follow all remaining steps.

Security

It is advised to erase all channels before you sell or turn in your vehicle.

To do this, press and hold the two outside buttons for 20 seconds until the red indicator flashes. Note that all channels will be erased. Individual channels cannot be erased.

The HomeLink® Universal Transceiver is disabled when the Vehicle Security Alarm is active.

Troubleshooting Tips

If you are having trouble programming HomeLink®, here are some of the most common solutions:

- Replace the battery in the original transmitter.
- Press the LEARN button on the Garage Door Opener to complete the training for a Rolling Code.
- Did you unplug the device for training, and remember to plug it back in?

If you have any problems, or require assistance, please call toll-free 1-800-355-3515 or, on the Internet at www.HomeLink.com for information or assistance.

General Information

This device complies with FCC rules Part 15 and Industry Canada RSS-210. Operation is subject to the following two conditions:

1. This device may not cause harmful interference.
2. This device must accept any interference that may be received including interference that may cause undesired operation.

NOTE: The transmitter has been tested and it complies with FCC and IC rules. Changes or modifications not expressly approved by the party responsible for compliance could void the user's authority to operate the device.

The term IC before the certification/registration number only signifies that Industry Canada technical specifications were met.

POWER SUNROOF — IF EQUIPPED

The power sunroof switch is located in the reading light.

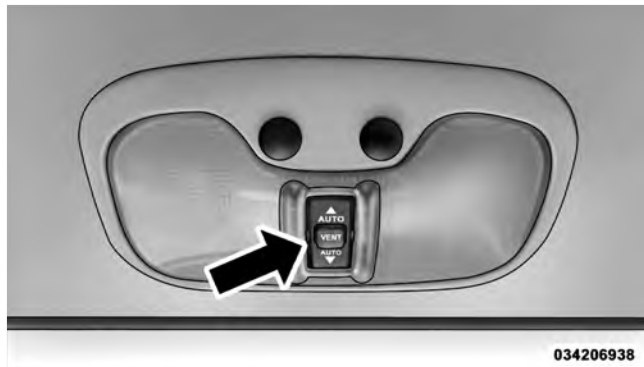

Power Sunroof Switch

WARNING!

- Never leave children in a vehicle with the key in the ignition switch. Occupants, particularly unattended children, can become entrapped by the power sunroof while operating the power sunroof switch. Such entrapment may result in serious injury or death.
- In a collision, there is a greater risk of being thrown from a vehicle with an open sunroof. You could also be seriously injured or killed. Always fasten your seat belt properly and make sure all passengers are properly secured too.
- Do not allow small children to operate the sunroof. Never allow your fingers, other body parts, or any object to project through the sunroof opening. Injury may result.

Opening Sunroof — Express

Press the switch rearward and release it within one-half second and the sunroof will open automatically from any position. The sunroof will open fully and stop automatically. This is called “Express Open”. During Express Open operation, any movement of the sunroof switch will stop the sunroof.

Opening Sunroof — Manual Mode

To open the sunroof, press and hold the switch rearward to full open. Any release of the switch will stop the movement and the sunroof will remain in a partially opened condition until the switch is pushed and held rearward again.

Closing Sunroof — Express

Press the switch forward and release it within one-half second and the sunroof will close automatically from any position. The sunroof will close fully and stop automatically. This is called “Express Close”. During Express Close operation, any movement of the switch will stop the sunroof.

Closing Sunroof — Manual Mode

To close the sunroof, press and hold the switch in the forward position. Any release of the switch will stop the movement and the sunroof will remain in a partially closed condition until the switch is pushed and held forward again.

Pinch Protect Feature

This feature will detect an obstruction in the opening of the sunroof during Express Close operation. If an obstruction in the path of the sunroof is detected, the sunroof will automatically retract. Remove the obstruction if this occurs. Next, press the switch forward and release to Express Close.

NOTE: Pinch protection is disabled while the switch is pressed.

Venting Sunroof — Express

Press and release the Vent button within one half second and the sunroof will open to the vent position. This is called “Express Vent”, and it will occur regardless of sunroof position. During Express Vent operation, any movement of the switch will stop the sunroof.

Sunshade Operation

The sunshade can be opened manually. However, the sunshade will open automatically as the sunroof opens.

NOTE: The sunshade cannot be closed if the sunroof is open.

Wind Buffeting

Wind buffeting can be described as the perception of pressure on the ears or a helicopter-type sound in the ears. Your vehicle may exhibit wind buffeting with the windows down, or the sunroof (if equipped) is in certain open or partially open positions. This is a normal occurrence and can be minimized. If the buffeting occurs with the rear windows open, open the front and rear windows together to minimize the buffeting. If the buffeting occurs with the sunroof open, adjust the sunroof opening to minimize the buffeting or open any window.

Sunroof Maintenance

Use only a non-abrasive cleaner and a soft cloth to clean the glass panel.

Ignition Off Operation

For vehicles not equipped with the Electronic Vehicle Information Center (EVIC), the power sunroof switch will remain active for 45 seconds after the ignition switch is turned to the LOCK position. Opening either front door will cancel this feature.

For vehicles equipped with the EVIC, the power sunroof switch will remain active for up to approximately ten minutes after the ignition switch is turned to the LOCK position. Opening either front door will cancel this feature. The time is programmable. Refer to “Electronic Vehicle Information Center (EVIC)/Personal Settings (Customer-Programmable Features)” in “Understanding Your Instrument Panel” for further information.

ELECTRICAL POWER OUTLETS

There is a standard 12 Volt (13 Amp) power outlet located in the instrument panel for added convenience. This power outlet can power cellular phones, electronics and other low power devices.



12 Volt Power Outlet

Power is available when the ignition switch is in the ON or ACC position. Insert the cigar lighter or accessory plug into the outlet for use. **To preserve the heating element, do not hold the lighter in the heating position.**

NOTE: To ensure proper operation, a MOPAR® knob and element must be used.

CAUTION!

- Do not exceed the maximum power of 160 Watts (13 Amps) at 12 Volts. If the 160 Watt (13 Amp) power rating is exceeded the fuse protecting the system will need to be replaced.
- Power outlets are designed for accessory plugs only. Do not insert any other object in the power outlets as this will damage the outlet and blow the fuse. Improper use of the power outlet can cause damage not covered by your warranty.



034636797

Power Outlet Fuse Location

WARNING!

To avoid serious injury or death:

- Only devices designed for use in this type of outlet should be inserted into any 12 Volt outlet.
- Do not touch with wet hands.
- Close the lid when not in use and while driving the vehicle.
- If this outlet is mishandled, it may cause an electric shock and failure.

CAUTION!

- Many accessories that can be plugged in draw power from the vehicle's battery, even when not in use (i.e., cellular phones, etc.). Eventually, if plugged in long enough, the vehicle's battery will discharge sufficiently to degrade battery life and/or prevent the engine from starting.
- Accessories that draw higher power (i.e., coolers, vacuum cleaners, lights, etc.) will degrade the battery even more quickly. Only use these intermittently and with great caution.
- After the use of high power draw accessories, or long periods of the vehicle not being started (with accessories still plugged in), the vehicle must be driven a sufficient length of time to allow the generator to recharge the vehicle's battery.

POWER INVERTER — IF EQUIPPED

A 115 Volt (150 Watt) AC power inverter is located on the rear of the center console for added convenience. This outlet can power cellular phones, electronics and other low power devices requiring power up to 150 Watts. Certain high-end video games, such as Playstation3 and XBox360 will exceed this power limit, as will most power tools.

The power inverter is designed with built-in overload protection. If the power rating of 150 Watts is exceeded, the power inverter will automatically shut down. Once the electrical device has been removed from the outlet the inverter should automatically reset. If the power rating exceeds approximately 170 Watts, the power inverter may have to be reset manually. To reset the inverter manually, unplug the device and plug it in again.

NOTE: To avoid overloading the circuit, check the power ratings on electrical devices prior to using the inverter.

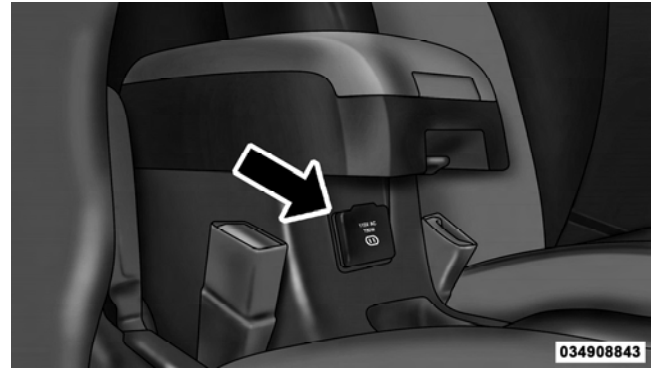

115 Volt Power Outlet

WARNING!

To avoid serious injury or death:

- Do not use a three-prong adaptor.
- Do not insert any objects into the receptacles.
- Do not touch with wet hands.
- Close the lid when not in use.
- If this outlet is mishandled, it may cause an electric shock and failure.

CAUTION!

- Many accessories that can be plugged in draw power from the vehicle's battery, even when not in use (i.e., cellular phones, etc.). Eventually, if plugged in long enough, the vehicle's battery will discharge sufficiently to degrade battery life and/or prevent engine starting.
- Accessories that draw higher power (i.e., coolers, vacuum cleaners, lights, etc.) will degrade the battery even more quickly. Only use these intermittently and with great caution.
- After the use of high power draw accessories, or long periods of the vehicle not being started (with accessories still plugged in), the vehicle must be driven a sufficient length of time to allow the generator to recharge the vehicle's battery.

CUPHOLDERS

Your vehicle is equipped with four cupholders. There are two cupholders located in the front.

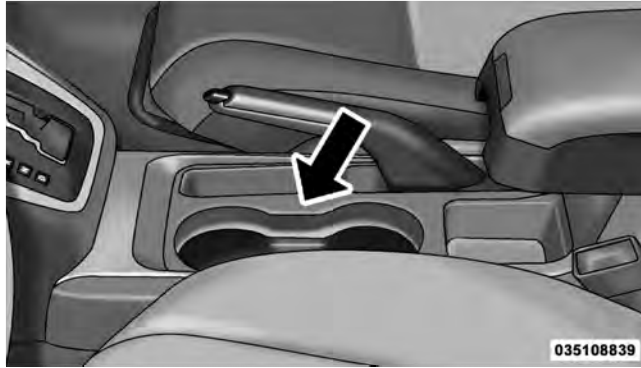

Front Cupholders

There are two cupholders behind the center console for rear passengers.

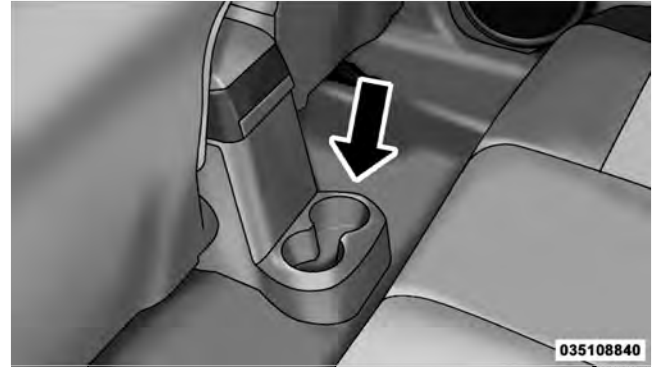

Rear Cupholders

CONSOLE FEATURES

The floor console contains both an upper and lower storage compartment.

To open the upper storage compartment, push inward on the upper handle to unlatch the upper lid and lift the lid open.

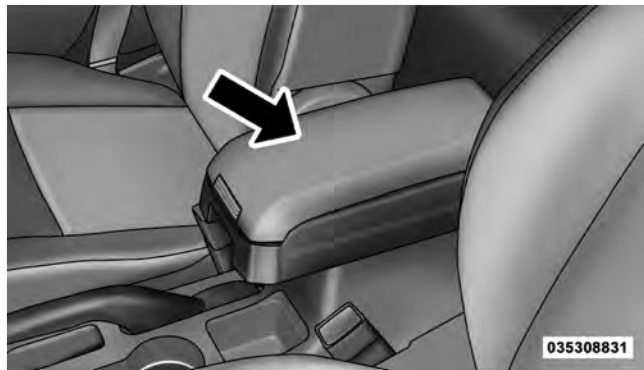

Upper Storage Compartment



Upper Storage Compartment

To open the lower storage compartment, lift upward on the lower handle to unlatch the lower storage compartment and lift the lid open.

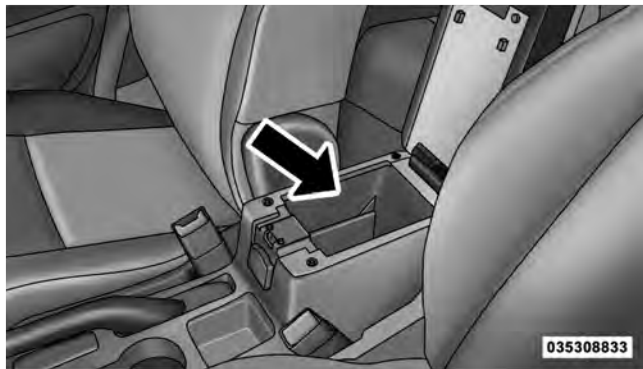

Lower Storage Compartment

WARNING!

Do not operate this vehicle with a console compartment lid in the open position. Cellular phones, music players, and other handheld electronic devices should be stowed while driving. Use of these devices while driving can cause an accident due to distraction, resulting in death or injury.

3

CARGO AREA FEATURES

Cargo Light/Removable Self-Recharging Flashlight

The dual-function light is mounted in the headliner above the cargo area to illuminate the cargo area, and part of it snaps out of the bezel to serve as a flashlight when needed. The flashlight features two bright LED light bulbs and is powered by rechargeable lithium batteries that recharge when snapped back into place for convenience.

Press in on the flashlight to release it.



Press And Release

To operate the flashlight, press the switch once for high, twice for low, and a third time to return to off.



Three-Press Switch

Cargo Cover

The cargo area trim panels include two notches for mounting the available tonneau cover that accommodates the reclining rear seat.

To install the Cargo Cover, insert either end of the cover into one of the two notches located in the rear trim panels. With one of the cover ends installed, push inward on the opposite end and install it into the same notch location of the rear trim panel.

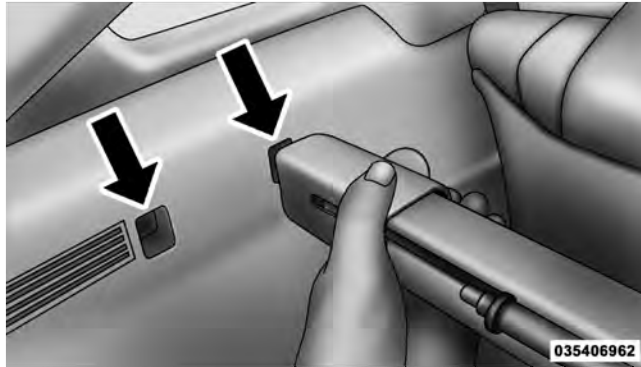

Rear Trim Notches

Using the handle, pull the cover toward you and guide the rear cover posts into the guides located on both sides of the rear trim panel.

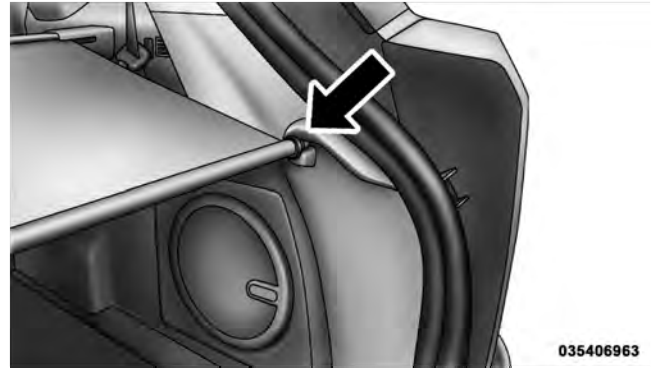

Cargo Cover Guides

WARNING!

In a collision a cargo cover loose in the vehicle could cause injury. It could fly around in a sudden stop and strike someone in the vehicle. Do not store the cargo cover on the cargo floor or in the passenger compartment. Remove the cover from the vehicle when taken from its mounting. Do not store in the vehicle.

Removable Load Floor

The cargo area contains a removable load floor.

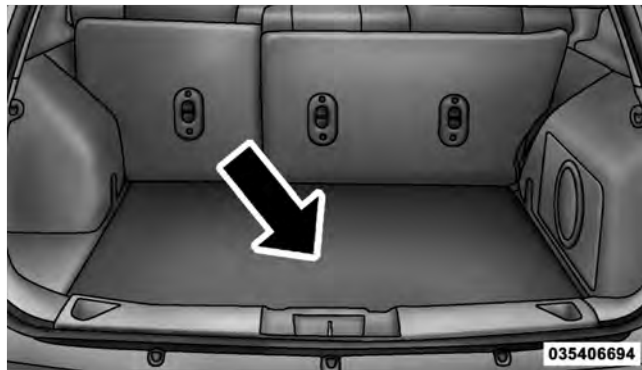

Rear Cargo Area

Cargo Tie-Down Loops

There are two D-rings installed in the cargo area for securing cargo.

WARNING!

- Cargo tie-down loops are not safe anchors for a child seat tether strap. In a sudden stop or collision a loop could pull loose and allow the child seat to come loose. A child could be badly injured. Use only the anchors provided for child seat tethers.
- The weight and position of cargo and passengers can change the vehicle center of gravity and vehicle handling. To avoid loss of control resulting in personal injury, follow these guidelines for loading your vehicle:

(Continued)

WARNING! (Continued)

- Always place cargo evenly on the cargo floor. Put heavier objects as low and as far forward as possible.
- Place as much cargo as possible in front of the rear axle. Too much weight or improperly placed weight over or behind the rear axle can cause the rear of the vehicle to sway.
- Do not pile luggage or cargo higher than the top of the seatback. This could impair visibility or become a dangerous projectile in a sudden stop or collision.
- To help protect against personal injury, passengers should not be seated in the rear cargo area. The rear cargo space is intended for load carrying purposes only, not for passengers, who should sit in seats and use seat belts.

Fold Down Speakers — If Equipped

When the liftgate is open, the speakers can swing down off the trim panel to face rearward, for tailgating and other activities.



Fold-Down Speakers

035408853

REAR WINDOW FEATURES

Rear Window Wiper/Washer

The rear wiper/washer is controlled by a rotary switch located on the center portion of the control lever. The control lever is located on the right side of the steering column.



Rear Wiper/Washer Control

031507505

 Rotate the center portion of the lever upward to the first detent position for rear wiper operation.

NOTE: The rear wiper operates in an intermittent mode only.

 Rotate the center portion of the lever past the first detent to activate the rear washer. The washer pump and the wiper will continue to operate as long as the switch is held (for a maximum of 10 seconds). Upon release, the wiper will continue to cycle two times before returning to the set position.

If the rear wiper is operating when the ignition is turned OFF, the wiper will automatically return to the “park” position if power accessory delay is active. Power accessory delay can be cancelled by opening the door, if this happens the rear wiper will stop at its current position and will not go to “park”.

Rear Window Defroster

 The rear window defroster button is located on the bottom right-side of the blower control knob. Press this button to turn on the rear window defroster and the heated outside mirrors (if equipped). An indicator in the button will illuminate when the rear window defroster is on. The rear window defroster automatically turns off after approximately 10 minutes. For an additional five minutes of operation, press the button a second time.

NOTE: To prevent excessive battery drain, use the rear window defroster only when the engine is operating.

CAUTION!

Failure to follow these cautions can cause damage to the heating elements:

- Use care when washing the inside of the rear window. Do not use abrasive window cleaners on the interior surface of the window. Use a soft cloth and a mild washing solution, wiping parallel to the heating elements. Labels can be peeled off after soaking with warm water.
- Do not use scrapers, sharp instruments, or abrasive window cleaners on the interior surface of the window.
- Keep all objects a safe distance from the window.

CHILL ZONE® BEVERAGE COOLER STORAGE COMPARTMENT — IF EQUIPPED

The glove compartment is located on the passenger side of the vehicle. The large glove compartment door swings downward and features two levels of storage. The upper bin functions as the Chill Zone® cooled beverage storage compartment (for vehicles equipped with air conditioning) for storing up to four 20 oz (1 L) bottles or cans. When desired, cool air enters the Chill Zone® to keep the contents cool, depending on ambient temperature and A/C settings.

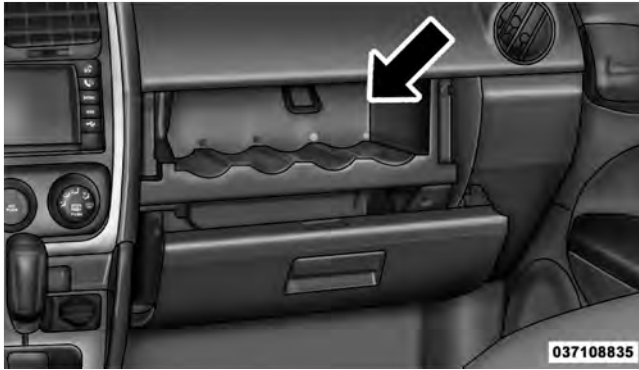

Glove Compartment and Chill Zone®

NOTE: The use of the Chill Zone® is for nonperishable beverages only.

Inside the Chill Zone® is a vent which, when opened, allows either air conditioned or fresh air to flow into the

Chill Zone® compartment. Depending on ambient temperature and A/C setting, the compartment can keep beverages cool.

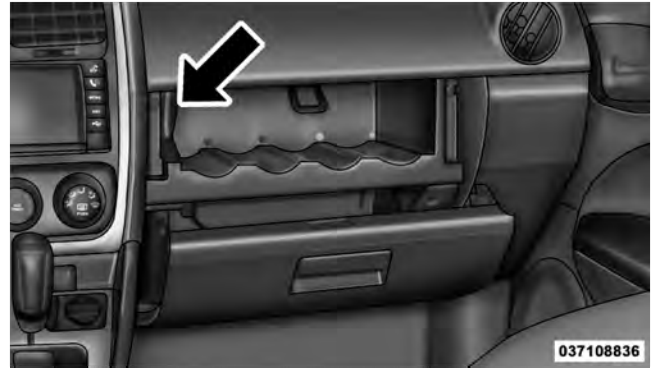

Positioning Slide Control

Vehicles without air conditioning can use that space for storage. The lower bin holds the Owner's Manual and other important documents.

UNDERSTANDING YOUR INSTRUMENT PANEL

CONTENTS

■ Instrument Panel Features	188	□ Average Fuel Economy	209
■ Instrument Cluster — Base	189	□ Distance To Empty (DTE)	209
■ Instrument Cluster — Premium	190	□ Elapsed Time	210
■ Instrument Cluster Descriptions	191	□ Tire Pressure Monitor (TPM)	210
■ Electronic Vehicle Information Center (EVIC) — If Equipped	205	□ Personal Settings (Customer-Programmable Features)	210
□ Oil Change Required — If Equipped	207	■ Media Center 230 (REQ) — AM/FM Stereo Radio And 6-Disc CD/DVD Changer (MP3/WMA AUX Jack)	216
□ EVIC Functions	208	□ Operating Instructions - Radio Mode	216
□ Compass/Temperature/Audio	209		

- Operation Instructions - (Disc Mode For CD And MP3/WMA Audio Play, DVD-Video) . . . 224
- Notes On Playing MP3/WMA Files 226
- List Button (Disc Mode For MP3/WMA Play) 229
- Info Button (Disc Mode For MP3/WMA Play) 229
- Uconnect™ Multimedia (Satellite Radio) — If Equipped 231
- Media Center 730N/430/430N (RHR/RER/RBZ/RHB) CD/DVD/HDD/NAV — If Equipped 235
 - Operating Instructions (Voice Command System) — If Equipped . . . 235
 - Operating Instructions (Uconnect™ Phone) — If Equipped 235
- Media Center 130 (Sales Code RES) 236
 - Operating Instructions — Radio Mode 236
 - Operation Instructions — CD Mode For CD And MP3 Audio Play 239
 - Notes On Playing MP3 Files 241
 - Operation Instructions - Auxiliary Mode 244
- Media Center 130 With Satellite Radio (Sales Code RES+RSC). 244
 - Operating Instructions — Radio Mode 245
 - Operation Instructions — CD Mode For CD And MP3 Audio Play 250
 - Notes On Playing MP3 Files 252
 - List Button (CD Mode For MP3 Play) 255
 - Info Button (CD Mode For MP3 Play) 255

<ul style="list-style-type: none"> □ Uconnect™ Multimedia (Satellite Radio) — If Equipped 256 ■ iPod® Control — If Equipped 260 <ul style="list-style-type: none"> □ Connecting The iPod® 261 □ Using This Feature 261 □ Controlling The iPod® Using Radio Buttons 262 □ Play Mode 262 □ List Or Browse Mode 263 ■ iPod®/USB/MP3 Control — If Equipped 265 <ul style="list-style-type: none"> □ Connecting The iPod® Or External USB Device 266 □ Using This Feature 267 □ Controlling The iPod® Or External USB Device Using Radio Buttons 267 	<ul style="list-style-type: none"> □ Play Mode 267 □ List Or Browse Mode 269 □ Bluetooth Streaming Audio (BTSA) 271 ■ Steering Wheel Audio Controls — If Equipped 272 <ul style="list-style-type: none"> □ Radio Operation 273 □ CD Player 273 ■ CD/DVD Disc Maintenance 273 ■ Radio Operation And Mobile Phones 274 ■ Climate Controls 274 <ul style="list-style-type: none"> □ Manual Heating And Air Conditioning 275 □ Automatic Temperature Control (ATC) — If Equipped 279 □ Operating Tips 285
--	---

INSTRUMENT PANEL FEATURES

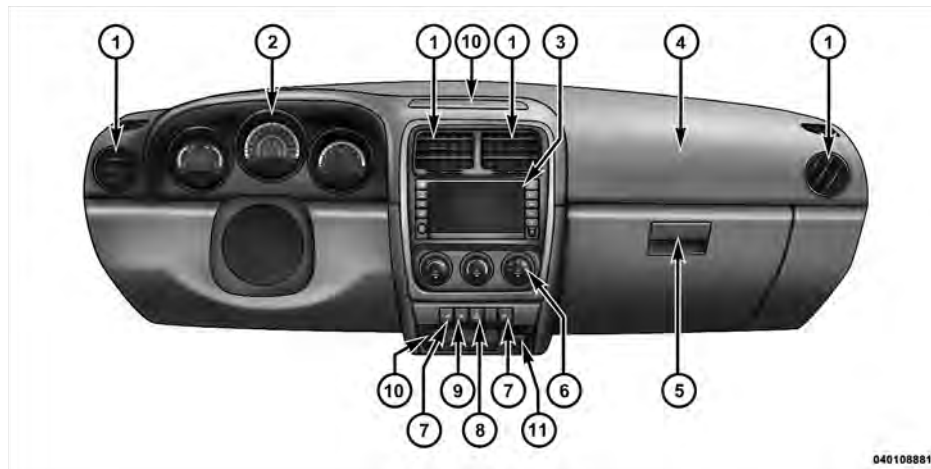

040108881

- | | | |
|------------------------|---|----------------------------------|
| 1 — Air Outlet | 5 — Lower Glove Compartment/Beverage Cooler – If Equipped | 9 — ESC OFF Switch – If Equipped |
| 2 — Instrument Cluster | 6 — Climate Controls | 10 — Storage Bins |
| 3 — Radio | 7 — Heated Seat Switches – If Equipped | 11 — Power Outlet |
| 4 — Passenger Airbag | 8 — Hazard Warning Flasher | |

INSTRUMENT CLUSTER — BASE

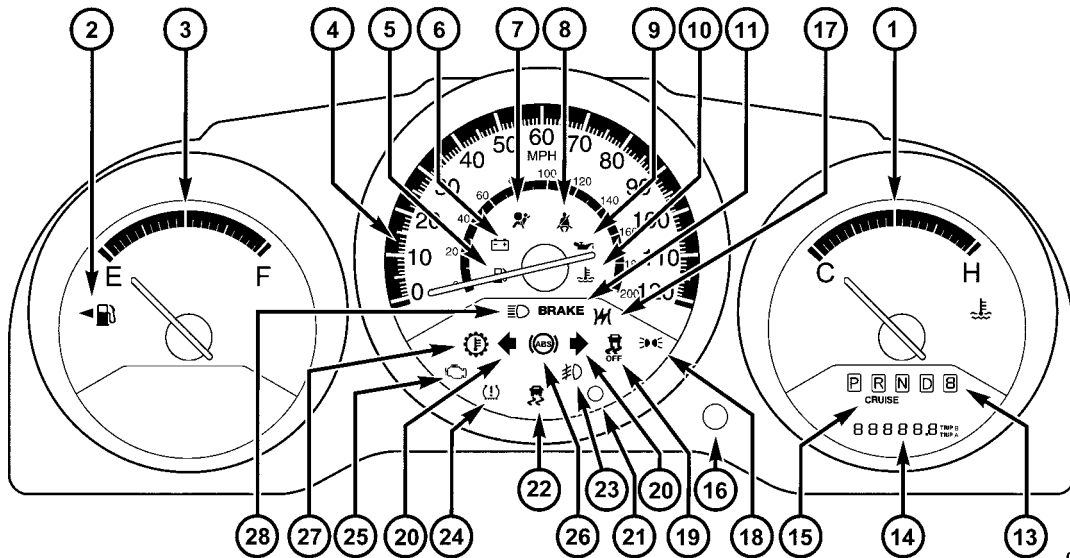

INSTRUMENT CLUSTER — PREMIUM

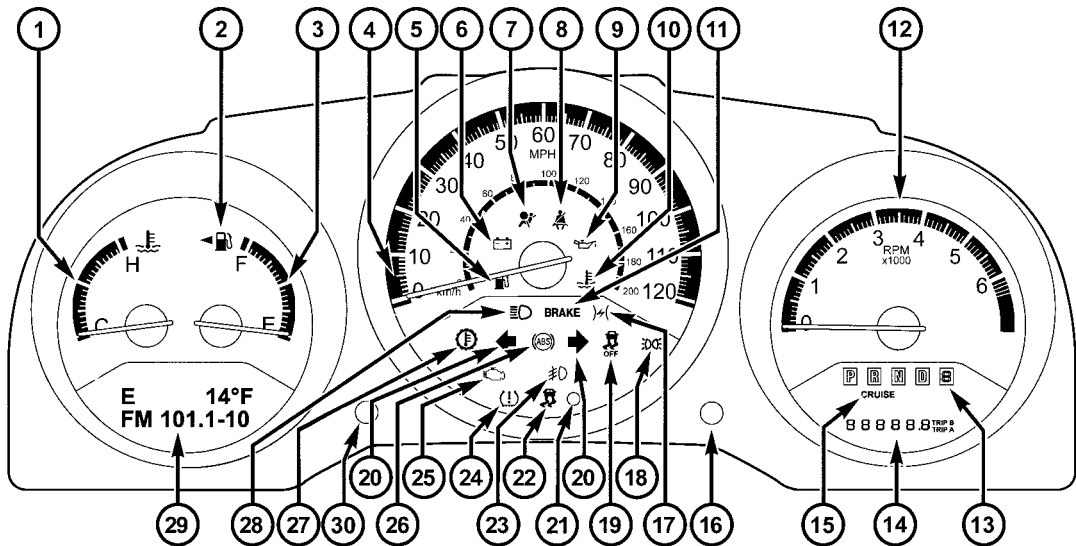

INSTRUMENT CLUSTER DESCRIPTIONS

1. *Temperature Gauge*

The temperature gauge shows engine coolant temperature. Any reading within the normal range indicates that the engine cooling system is operating satisfactorily.

The gauge pointer will likely indicate a higher temperature when driving in hot weather, up mountain grades, or when towing a trailer. It should not be allowed to exceed the upper limits of the normal operating range.

CAUTION!

Driving with a hot engine cooling system could damage your vehicle. If the temperature gauge reads "H" pull over and stop the vehicle. Idle the vehicle with the air conditioner turned off until the pointer drops back into the normal range. If the pointer remains on the "H" and you hear continuous chimes, turn the engine off immediately and call an authorized dealership for service.

WARNING!

A hot engine cooling system is dangerous. You or others could be badly burned by steam or boiling coolant. You may want to call an authorized dealership for service if your vehicle overheats. If you decide to look under the hood yourself, see “Maintaining Your Vehicle”. Follow the warnings under the Cooling System Pressure Cap paragraph.

2. Fuel Door Reminder

This indicates that the fuel filler door is located on the left side of the vehicle.

3. Fuel Gauge

When the ignition switch is in the ON/RUN position, the pointer will show the level of fuel remaining in the fuel tank.

4. Speedometer

The Speedometer shows the vehicle speed in miles per hour and/or kilometers per hour (mph/kph).

5. Low Fuel Light

When the fuel level reaches approximately 2.0 gal (7.8 L) this light will turn on, and remain on until fuel is added.

6. Charging System Light

This light shows the status of the electrical charging system. The light should come on when the ignition switch is first turned to ON/RUN and remain on briefly as a bulb check. If the light stays on or comes on while driving, turn off some of the vehicle's non-essential electrical devices or increase engine speed (if at idle). If the charging system light remains on, it means that the vehicle is experiencing a problem with the charging system. Obtain SERVICE IMMEDIATELY. See an authorized dealer.

If jump starting is required, refer to “Jump Starting Procedures” in “What To Do In Emergencies”.

7. *Airbag Warning Light*



This light will turn on for four to eight seconds as a bulb check when the ignition switch is first turned to ON/RUN. If the light is either not on during starting, stays on, or turns on while driving, have the system inspected at an authorized dealer as soon as possible. Refer to “Occupant Restraints” in “Things To Know Before Starting Your Vehicle” for further information.

8. *Seat Belt Reminder Light*



When the ignition switch is first turned to ON/RUN, this light will turn on for four to eight seconds as a bulb check. During the bulb check, if the driver’s seat belt is unbuckled, a chime will sound. After the bulb check or when driving, if the driver’s seat belt remains unbuckled, the Seat Belt Reminder Light

will illuminate and the chime will sound. Refer to “Occupant Restraints” in “Things To Know Before Starting Your Vehicle” for further information.

9. *Oil Pressure Warning Light*



This light indicates low engine oil pressure. The light should turn on momentarily when the engine is started. If the light turns on while driving, stop the vehicle and shut off the engine as soon as possible. A chime will sound for four minutes when this light turns on.

Do not operate the vehicle until the cause is corrected. This light does not indicate how much oil is in the engine. The engine oil level must be checked under the hood.

10. *Engine Temperature Warning Light*



This light warns of an overheated engine condition. As temperatures rise and the gauge approaches **H**, this indicator will illuminate and a single chime will sound after reaching a set threshold.

Further overheating will cause the temperature gauge to pass **H**, the indicator will continuously flash and a continuous chime will occur until the engine is allowed to cool.

If the light turns on while driving, safely pull over and stop the vehicle. If the A/C system is on, turn it off. Also, shift the transmission into NEUTRAL and idle the vehicle. If the temperature reading does not return to normal, turn the engine off immediately and call for service. Refer to "If Your Engine Overheats" in "What To Do In Emergencies" for further information.

11. Brake Warning Light

This light monitors various brake functions, including brake fluid level and parking brake application. If the brake light turns on it may indicate that the parking brake is applied, that the brake fluid level is low, or that there is a problem with the anti-lock brake system reservoir.

If the light remains on when the parking brake has been disengaged, and the fluid level is at the full mark on the master cylinder reservoir, it indicates a possible brake hydraulic system malfunction or that a problem with the Brake Booster has been detected by the Anti-Lock Brake System (ABS) / Electronic Stability Control (ESC) system. In this case, the light will remain on until the condition has been corrected. If the problem is related to the brake booster, the ABS pump will run when applying the brake and a brake pedal pulsation may be felt during each stop.

The dual brake system provides a reserve braking capacity in the event of a failure to a portion of the hydraulic system. A leak in either half of the dual brake system is indicated by the Brake Warning Light, which will turn on when the brake fluid level in the master cylinder has dropped below a specified level.

The light will remain on until the cause is corrected.

NOTE: The light may flash momentarily during sharp cornering maneuvers, which change fluid level conditions. The vehicle should have service performed, and the brake fluid level checked.

If brake failure is indicated, immediate repair is necessary.

WARNING!

Driving a vehicle with the red brake light on is dangerous. Part of the brake system may have failed. It will take longer to stop the vehicle. You could have a collision. Have the vehicle checked immediately.

Vehicles equipped with the Anti-Lock Brake System (ABS), are also equipped with Electronic Brake Force Distribution (EBD). In the event of an EBD failure, the Brake Warning Light will turn on along with the ABS Light. Immediate repair to the ABS system is required.

Operation of the Brake Warning Light can be checked by turning the ignition switch from the OFF position to the ON/RUN position. The light should illuminate for approximately two seconds. The light should then turn off unless the parking brake is applied or a brake fault is detected. If the light does not illuminate, have the light inspected by an authorized dealer.

The light also will turn on when the parking brake is applied with the ignition switch in the ON/RUN position.

NOTE: This light shows only that the parking brake is applied. It does not show the degree of brake application.

12. Tachometer

The white area of the scale shows the permissible engine revolutions-per-minute (RPM x 1000) for each gear range. Before reaching the red area, ease up on the accelerator to prevent engine damage.

13. *Shift Lever Indicator*

The Shift Lever Indicator is self-contained within the instrument cluster. It displays the gear position of the automatic transmission.

14. *Odometer / Trip Odometer Display Area*

This display indicates the total distance the vehicle has been driven.

NOTE: U.S. Federal regulations require that upon transfer of vehicle ownership, the seller certify to the purchaser the correct mileage that the vehicle has been driven. If your odometer needs to be repaired or serviced, the repair technician should leave the odometer reading the same as it was before the repair or service. If s/he cannot do so, then the odometer must be set at zero, and a sticker must be placed in the door jamb stating what the mileage was before the repair or service. It is a good idea for you to make a record of the odometer reading before

the repair/service, so that you can be sure that it is properly reset, or that the door jamb sticker is accurate if the odometer must be reset at zero.

Vehicle Odometer Messages

When the appropriate conditions exist, the following odometer messages will display:

door	Door Ajar
gate	Gate Ajar
gASCAP	Fuel Cap Fault
LoW TirE	Low Tire Pressure
noFUSE	Fuse Fault
CHAngE OIL	Oil Change Required
HOTOIL	Engine Oil Temp Too Hot

NOTE: If the vehicle is equipped with the optional Electronic Vehicle Information Center (EVIC) in the instrument cluster, all warnings including “door” and

“gATE” and “Oil Change Required” will only be displayed in the EVIC display. For additional information, refer to “Electronic Vehicle Information Center (EVIC) — If Equipped”.

gASCAP

If the vehicle diagnostic system determines that the fuel filler cap is loose, improperly installed, or damaged, a “gASCAP” message will display in the odometer display area. Tighten the fuel filler cap properly and press the TRIP ODOMETER button to turn off the message. If the problem continues, the message will appear the next time the vehicle is started.

A loose, improperly installed, or damaged fuel filler cap may also turn on the Malfunction Indicator Light (MIL).

LoW TirE

When tire pressure is low, the odometer display will toggle between LoW and TirE for three cycles.

HOTOIL

When this message is displayed there is a engine over-temperature condition. When this condition occurs, the “HOTOIL” message will be displayed in the odometer along with a chime.

Refer to “Engine Oil Overheating” under in “What To Do In Emergencies”.

noFUSE

If the vehicle diagnostic system determines that the Ignition Off Draw (IOD) fuse is improperly installed, or damaged, a “noFUSE” message will display in the odometer display area. For further information on fuses and fuse locations refer to “Fuses” in “Maintaining Your Vehicle”.

CHAngE OIL

Your vehicle is equipped with an engine oil change indicator system. The “CHAngE OIL” message will flash in the instrument cluster odometer for approximately

five seconds after a single chime has sounded to indicate the next scheduled oil change interval. The engine oil change indicator system is duty cycle based, which means the engine oil change interval may fluctuate dependent upon your personal driving style.

Unless reset, this message will continue to display each time you turn the ignition switch to the ON/RUN position. To turn off the message temporarily, press and release the Trip Odometer button on the instrument cluster. To reset the oil change indicator system (after performing the scheduled maintenance), refer to the following procedure:

1. Turn the ignition switch to the ON/RUN position.
Do not start the engine.
2. Fully depress the accelerator pedal slowly three times within 10 seconds.
3. Turn the ignition switch to the OFF/LOCK position.

NOTE: If the indicator message illuminates when you start the vehicle, the oil change indicator system did not reset. If necessary, repeat this procedure.

15. *Cruise Indicator — If Equipped*

CRUISE This indicator shows that the Speed Control system is ON.

16. *Trip/Odometer Display Reset Button*

Press this button to change the display from odometer to either of the two trip odometer settings. Trip A or Trip B will appear when in the trip odometer mode. Push in and hold the button for two seconds to reset the trip odometer to 0 miles (0 km). The odometer must be in Trip mode to reset.

17. *Electronic Throttle Control (ETC) Light*



This light informs you of a problem with the Electronic Throttle Control (ETC) system. If a problem is detected, the light will come on while the engine is running. Cycle the ignition

key when the vehicle has completely stopped and the shift lever is placed in the NEUTRAL position. The light should turn off. If the light remains lit with the engine running, your vehicle will usually be drivable; however, see an authorized dealer for service as soon as possible. If the light is flashing when the engine is running, immediate service is required and you may experience reduced performance, an elevated/rough idle or engine stall and your vehicle may require towing. The light will come on when the ignition is first turned to ON/RUN and remain on briefly as a bulb check. If the light does not come on during starting, have the system checked by an authorized dealer.

18. *Park/Headlight ON Indicator — If Equipped*

 This indicator will illuminate when the park lights or headlights are turned on.

19. *Electronic Stability Control (ESC) OFF Indicator Light — If Equipped*



This light indicates the Electronic Stability Control system (ESC) has been turned off by the driver.

20. *Turn Signal Indicators*



The arrow will flash with the exterior turn signal when the turn signal lever is operated.

If the vehicle electronics sense that the vehicle is driven more than 1 mile (1.6 km) with either turn signal on, a continuous chime will sound to alert you to turn the signals off. If either indicator flashes at a rapid rate, check for a defective outside light bulb.

21. *Vehicle Security Light — If Equipped*



This light will flash at a fast rate for approximately 16 seconds, when the vehicle security alarm is arming, and then will flash slowly until the vehicle is disarmed.

22. *Electronic Stability Control (ESC) Activation/ Malfunction Indicator Light — If Equipped*



The “ESC Activation/Malfunction Indicator Light” in the instrument cluster will come on when the ignition switch is turned to the ON/RUN position. It should go out with the engine running. If the “ESC Activation/Malfunction Indicator Light” comes on continuously with the engine running, a malfunction has been detected in the ESC system. If this light remains on after several ignition cycles, and the vehicle has been driven several miles (kilometers) at speeds greater than 30 mph (48 km/h), see your authorized dealer as soon as possible to have the problem diagnosed and corrected.

NOTE:

- The “ESC Off Indicator Light” and the “ESC Activation/Malfunction Indicator Light” come on momentarily each time the ignition switch is turned to ON/RUN.
- Each time the ignition is turned to ON/RUN, the ESC system will be ON, even if it was turned off previously.
- The ESC system will make buzzing or clicking sounds when it is active. This is normal; the sounds will stop when ESC becomes inactive following the maneuver that caused the ESC activation.

23. *Front Fog Light Indicator — If Equipped*



This indicator will illuminate when the front fog lights are on.

24. Tire Pressure Monitoring Telltale Light



Each tire, including the spare (if provided), should be checked monthly when cold and inflated to the inflation pressure recommended by the vehicle manufacturer on the vehicle placard or tire inflation pressure label. (If your vehicle has tires of a different size than the size indicated on the vehicle placard or tire inflation pressure label, you should determine the proper tire inflation pressure for those tires.)

As an added safety feature, your vehicle has been equipped with a Tire Pressure Monitoring System (TPMS) that illuminates a low tire pressure telltale when one or more of your tires is significantly under-inflated. Accordingly, when the low tire pressure telltale illuminates, you should stop and check your tires as soon as possible, and inflate them to the proper pressure. Driving on a significantly under-inflated tire causes the tire to overheat and can lead to tire failure. Under-inflation also

reduces fuel efficiency and tire tread life, and may affect the vehicle's handling and stopping ability.

Please note that the TPMS is not a substitute for proper tire maintenance, and it is the driver's responsibility to maintain correct tire pressure, even if under-inflation has not reached the level to trigger illumination of the TPMS low tire pressure telltale.

Your vehicle has also been equipped with a TPMS malfunction indicator to indicate when the system is not operating properly. The TPMS malfunction indicator is combined with the low tire pressure telltale. When the system detects a malfunction, the telltale will flash for approximately one minute and then remain continuously illuminated. This sequence will continue upon subsequent vehicle start-ups as long as the malfunction exists. When the malfunction indicator is illuminated, the system may not be able to detect or signal low tire pressure as intended. TPMS malfunctions may occur for a variety of reasons, including the installation of replacement or

alternate tires or wheels on the vehicle that prevent the TPMS from functioning properly. Always check the TPMS malfunction telltale after replacing one or more tires or wheels on your vehicle, to ensure that the replacement or alternate tires and wheels allow the TPMS to continue to function properly.

CAUTION!

The TPMS has been optimized for the original equipment tires and wheels. TPMS pressures and warning have been established for the tire size equipped on your vehicle. Undesirable system operation or sensor damage may result when using replacement equipment that is not of the same size, type, and/or style. Aftermarket wheels can cause sensor damage. Do not use tire sealant from a can or balance beads if your vehicle is equipped with a TPMS, as damage to the sensors may result.

25. *Malfunction Indicator Light (MIL)*



The Malfunction Indicator Light (MIL) is part of an onboard diagnostic system, called OBD, that monitors engine and automatic transmission control systems. The light will illuminate when the key is in the ON/RUN position, before engine start. If the bulb does not come on when turning the key from OFF to ON/RUN, have the condition checked promptly.

Certain conditions, such as a loose or missing gas cap, poor fuel quality, etc., may illuminate the MIL after engine start. The vehicle should be serviced if the light stays on through several of your typical driving cycles. In most situations, the vehicle will drive normally and will not require towing.

CAUTION!

Prolonged driving with the MIL on could cause damage to the engine control system. It also could affect fuel economy and drivability. If the MIL is flashing, severe catalytic converter damage and power loss will soon occur. Immediate service is required.

WARNING!

A malfunctioning catalytic converter, as referenced above, can reach higher temperatures than in normal operating conditions. This can cause a fire if you drive slowly or park over flammable substances such as dry plants, wood, cardboard, etc. This could result in death or serious injury to the driver, occupants or others.

26. Anti-Lock Brake (ABS) Light

This light monitors the Anti-Lock Brake System (ABS). The light will turn on when the ignition switch is turned to the ON/RUN position and may stay on for as long as four seconds.

If the ABS light remains on or turns on while driving, it indicates that the Anti-Lock portion of the brake system is not functioning and that service is required. However, the conventional brake system will continue to operate normally if the BRAKE warning light is not on.

If the ABS light is on, the brake system should be serviced as soon as possible to restore the benefits of Anti-Lock brakes. If the ABS light does not turn on when the ignition switch is turned to the ON/RUN position, have the light inspected by an authorized dealer.

27. Transmission Temperature Warning Light — If Equipped



During sustained high speed driving on hot days, the automatic transmission oil may become too hot. If this happens, the Transmission Temperature Warning Light will come on and the vehicle will slow slightly until the automatic transmission cools down enough to allow a return to the requested speed. If the high speed is maintained, the overheating will reoccur as before in a cyclic fashion.

CAUTION!

Continuous driving with the Transmission Temperature Warning Light illuminated will eventually cause severe transmission damage or transmission failure.

WARNING!

If the Transmission Temperature Warning Light is illuminated and you continue operating the vehicle, in some circumstances you could cause the fluid to boil over, come in contact with hot engine or exhaust components and cause a fire.

28. High Beam Indicator



This indicator shows that the high beam headlights are on. Push the multifunction lever forward to switch the headlights to high beam, and pull toward yourself (normal position) to return to low beam.

29. *Electronic Vehicle Information Center (EVIC)*

Display — If Equipped

When the appropriate conditions exist, this display shows the EVIC messages.

Refer to the Electronic Vehicle Information Center (EVIC) for further information.

30. *Electronic Vehicle Information Center (EVIC)*

Display Button — If Equipped

Press the left EVIC button to scroll through sub-menus. Press and hold the reset button for approximately two seconds, to reset the display shown.

Refer to the Electronic Vehicle Information Center (EVIC) for further information.

ELECTRONIC VEHICLE INFORMATION CENTER (EVIC) — IF EQUIPPED

The Electronic Vehicle Information Center (EVIC) features a driver-interactive display that is located in the instrument cluster.

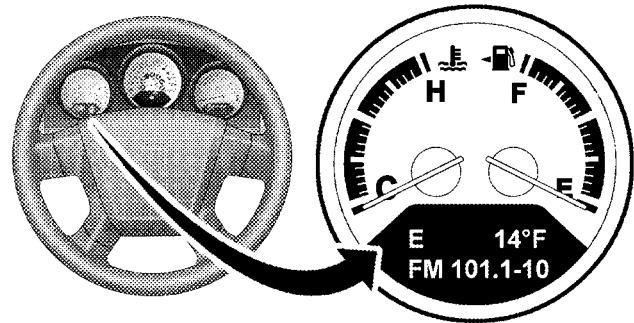

041008827

Electronic Vehicle Information Center (EVIC)

The EVIC consists of the following:

- System Status
- Vehicle Information Warning Message Displays
- Personal Settings (Customer-Programmable Features)
- Compass Heading
- Outside Temperature Display
- Trip Computer Functions
- Uconnect™ phone Displays — If equipped
- Audio Mode Display
- Tire Pressure Monitor (TPM)

When the appropriate conditions exist, the EVIC displays the following messages:

- Turn Signal On (with a continuous warning chime after 1 mile (1.6 km) of distance travelled)
- Left Front Turn Signal Light Out (with a single chime)
- Left Rear Turn Signal Light Out (with a single chime)
- Right Front Turn Signal Light Out (with a single chime)
- Right Rear Turn Signal Light Out (with a single chime)
- RKE Battery Low (with a single chime)
- Personal Settings Not Available – vehicle not in park (automatic transmission) or vehicle is in motion (manual transmission).
- Left/Right Front Door Ajar (one or more doors open, with a single chime if speed is above 1 mph/1 km/h)
- Left/Right Rear Door Ajar (one or more doors open, with a single chime if speed is above 1 mph/1 km/h)
- Door(s) Ajar (with a single chime if vehicle is in motion)

- Gate Ajar (with a single chime)
- Headlamps or Park Lamps On
- Key In Ignition
- Check TPM System
- Oil Change Required

Oil Change Required — If Equipped

Your vehicle is equipped with an engine oil change indicator system. The “Change Oil” message will flash in the instrument cluster odometer for approximately 5 seconds after a single chime has sounded to indicate the next scheduled oil change interval. The engine oil change indicator system is duty cycle based, which means the engine oil change interval may fluctuate dependent upon your personal driving style.

Unless reset, this message will continue to display each time you turn the ignition switch to the ON/RUN position. To turn off the message temporarily, press and release the Trip Odometer button on the instrument cluster. To reset the oil change indicator system (after performing the scheduled maintenance), refer to the following procedure.

1. Turn the ignition switch to the ON position (do not start the engine.)
2. Fully depress the accelerator pedal slowly three times within 10 seconds.
3. Turn the ignition switch to the OFF/LOCK position.

NOTE: If the indicator message illuminates when you start the vehicle, the oil change indicator system did not reset. If necessary, repeat this procedure.

EVIC Functions



EVIC Button

Press the EVIC button until one of the following functions are displayed on the EVIC:

- Compass/Temperature/Audio
- Average Fuel Economy
- Distance To Empty (DTE)
- Elapsed Time
- Tire Pressure Monitor (TPM)
- Personal Settings

To Reset The Display

Pressing and holding the EVIC button once will clear the function currently being displayed. Reset will only occur if a resettable function is currently being displayed. To reset all resettable functions, press and release the EVIC button a second time within three seconds of resetting the currently displayed function (reset ALL will be displayed during this three-second window).

Compass/Temperature/Audio

Press and release the EVIC button to display one of eight compass headings to indicate the direction the vehicle is facing, the outside temperature, and the current radio station.

For additional information regarding the compass, refer to “Personal Settings (Customer-Programmable Features)”.

Average Fuel Economy

Shows the average fuel economy since the last reset. When the fuel economy is reset, the display will read “RESET” or show dashes for two seconds. Then, the history information will be erased, and the averaging will continue from the last fuel reading before the reset.

Distance To Empty (DTE)

Shows the estimated distance that can be travelled with the fuel remaining in the tank. This estimated distance is determined by a weighted average of the instantaneous and average fuel economy, according to the current fuel tank level. This is not resettable.

NOTE: Significant changes in driving style or vehicle loading will greatly affect the actual drivable distance of the vehicle, regardless of the DTE displayed value.

When the DTE value is less than 30 miles (48 km) estimated driving distance, the DTE display will change to a text display of “LOW FUEL”. This display will continue until the vehicle runs out of fuel. Adding a significant amount of fuel to the vehicle will turn off the “LOW FUEL” text and a new DTE value will be displayed, based on the current values in the DTE calculation and the current fuel tank level.

Elapsed Time

Shows the total elapsed time of travel since the last reset when the ignition switch is in the ACC position. Elapsed time will increment when the ignition switch is in the ON or START position.

Tire Pressure Monitor (TPM)

Refer to “Tire Pressure Monitoring System (TPMS)” in “Starting and Operating” for further information.

Personal Settings**(Customer-Programmable Features)**

This allows the driver to set and recall features when the transmission is in PARK (automatic transmission) or the vehicle is stopped (manual transmission).

Press and release the EVIC button until “Personal Settings” is displayed in the EVIC.

Use the EVIC button to display one of the following choices:

Language

When in this display you may select different languages for all display nomenclature, including the trip functions. Pressing the EVIC button while in this display selects English, Espanol, or Francais depending on availability. As you continue, the displayed information will be shown in the selected language.

NOTE: Uconnect™ language will not change using the EVIC. Please refer to “Uconnect™ phone — If Equipped” in “Understanding The Features Of Your Vehicle” for further information.

Lock Doors Automatically at 15 MPH (24 km/h)

When ON is selected, all doors lock automatically when the speed of the vehicle reaches 15 mph (24 km/h). Press and hold the EVIC button when in this display until “ON” or “OFF” appears to make your selection.

Auto Unlock On Exit

When ON is selected all the vehicle's doors will unlock when the driver's door is opened if the vehicle is stopped (manual transmission) or the vehicle is stopped and the transmission is in PARK or NEUTRAL position (automatic transmission). Press and hold the EVIC button when in this display until "ON" or "OFF" appears to make your selection.

Remote Unlock Driver's Door 1st

When Driver's Door 1st is selected only the driver's door will unlock on the first press of the Remote Keyless Entry (RKE) transmitter UNLOCK button and require a second press to unlock the remaining locked doors. When Remote Unlock All Doors is selected, all of the doors will unlock at the first press of the RKE transmitter UNLOCK button. Press and hold the EVIC button when in this display until "Driver's Door 1st" or "All Doors" appears to make your selection.

Sound Horn with Remote Key Lock

When ON is selected, a short horn sound will occur when the RKE transmitter LOCK button is pressed. This feature may be selected with or without the Flash Lights with Remote Key Lock feature. Press and hold the EVIC button when in this display until "ON" or "OFF" appears to make your selection.

Flash Lights with Remote Key Lock

When ON is selected, the front and rear turn signals will flash when the doors are locked or unlocked using the RKE transmitter. This feature may be selected with or without the sound horn on lock feature selected. Press and hold the EVIC button when in this display until "ON" or "OFF" appears to make your selection.

Delay Turning Headlights Off

When this feature is selected, the driver can choose to have the headlights remain on for 0, 30, 60, or 90 seconds

when exiting the vehicle. Press and hold the EVIC button when in this display until 0, 30, 60, or 90 appears to make your selection.

Delay Power Off to Accessories Until Exit

When this feature is selected, the power window switches, radio, Uconnect™ phone, power sunroof, and power outlets will remain active for up to 10 minutes after the ignition switch has been turned off. Opening either front vehicle door will cancel this feature. Press and hold the EVIC button when in this display until “OFF”, “45 sec.”, “5 min.”, or “10 min.” appears to make your selection.

Turn Headlights on with Remote Key Unlock

When this feature is selected, the headlights will activate and remain on for up to 90 seconds when the doors are unlocked using the RKE transmitter. Press and hold the EVIC button when in this display until “OFF”, “30 sec.”, “60 sec.”, or “90 sec.” appears to make your selection.

Confirmation of Voice Commands — If Equipped

When ON is selected all voice commands from the Uconnect™ system are confirmed. Press and hold the EVIC button when in this display until “ON” or “OFF” appears to make your selection.

Illuminated Approach

When this feature is selected the headlights will activate and remain on for up to 90 seconds when the doors are unlocked using the RKE transmitter. Press and hold the EVIC button when in this display until “OFF”, “30 sec.”, “60 sec.”, or “90 sec.” appears to make your selection.

Hill Start Assist (HSA) — If Equipped

When on is selected, the HSA system is active. Refer to “Electronic Brake Control System” in “Starting And Operating” for system function and operating information. To make your selection, press and release the EVIC button until “On” or “Off” appears.

Display Units In

The EVIC, odometer, and Uconnect™ gps system units can be changed between English and Metric.

Press and hold the EVIC button when in this display until “ENGLISH” or “METRIC” appears to make your selection.

Automatic Compass Calibration

When the vehicle is new, the compass may appear erratic and the EVIC will display “CAL” until the compass is calibrated. You may also calibrate the compass by completing one or more 360 degree turns (in an area free from large metal or metallic objects) until the “CAL” message displayed in the EVIC turns off. The compass will now function normally.

NOTE: A good calibration requires a level surface and an environment free from large metallic objects such as buildings, bridges, underground cables, railroad tracks, etc

Compass Variance

Compass Variance is the difference between Magnetic North and Geographic North. To ensure compass accuracy, the compass variance should be properly set according to the variance map for the zone where the vehicle will be driven. When properly set, the compass will automatically account for this difference.

NOTE: Magnetic and battery powered devices, (such as cell phones, iPod's, radar detectors, PDA's and laptops) should be kept away from the top of the instrument panel. This is where the compass module is located and such devices may interfere and cause false compass readings.

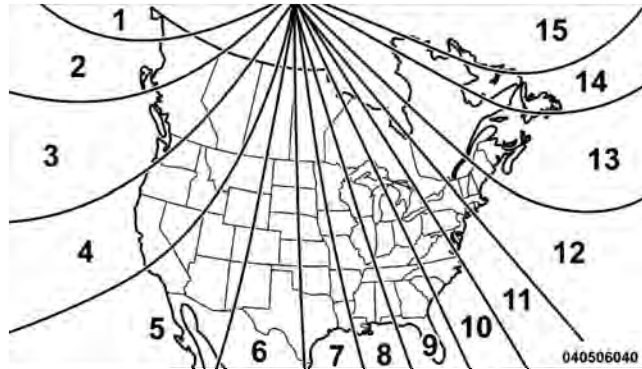

Compass Variance Map

To Set the Variance: with the ignition in the ON position, with a short button press (less than one second) press and release the EVIC button several times until you have displayed the "Personal Settings (Customer-Programmable Features)" menu. Once in the "Personal Settings (Customer-Programmable Features)" menu, press and release (less than one second) the EVIC button several times until "Compass Variance" is highlighted. The "Compass Variance" message and the current variance zone number will be displayed. To change the zone, press and hold (longer than two seconds) the EVIC button to increment the variance one step. Repeat as necessary, with individual long (for at least one second) EVIC button presses for each increment, until the desired variance is achieved. To exit the Variance Programming, press the EVIC button with a short (less than one second) button press.

NOTE: The factory default Zone is 8. During programming, the Zone value will wrap around from Zone 15 to Zone 1.

Manual Compass Calibration

If the compass appears erratic or inaccurate, and the variance has been properly set, you may wish to manually recalibrate the compass. To manually calibrate the compass:

1. Start the engine and leave the transmission in the PARK position.
2. Using a quick button press (less than one second), press and release the EVIC button several times until the EVIC displays the "Personal Settings (Customer-Programmable Features)" menu.
3. Once in the "Personal Settings (Customer-Programmable Features)" menu, press and release (less than one second) the EVIC button several times until "Calibrate Compass (Yes)" is displayed.

4. Using a long button press (more than one second) press the EVIC button, this will place the Compass in calibration mode. The CAL indicator will come on continuously in the EVIC display to indicate that the compass is now in the calibration mode, and that the vehicle can now be driven to calibrate.

5. To complete the compass calibration, drive the vehicle in one or more complete 360-degree circle under 5 mph (8 km/h) in an area free from power lines and large metallic objects, until the "CAL" indicator turns off. The compass will now function normally.

NOTE: A short EVIC button press from the "Calibrate Compass (Yes)" screen will exit the EVIC Customer-Programmable Features, and return it to its normal operating mode.

MEDIA CENTER 230 (REQ) — AM/FM STEREO RADIO AND 6-DISC CD/DVD CHANGER (MP3/WMA AUX JACK)

NOTE: The radio sales code is located on the lower right side of the radio faceplate.

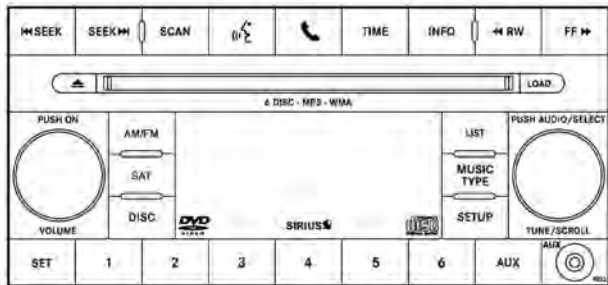

042040029

Media Center 230 (REQ)

Operating Instructions - Radio Mode

NOTE: The ignition switch must be in the ON or ACC position to operate the radio.

Power Switch/Volume Control (Rotary)

Push the ON/VOLUME control knob to turn on the radio. Press the ON/VOLUME control knob a second time to turn off the radio.

Electronic Volume Control

The electronic volume control turns continuously (360 degrees) in either direction without stopping. Turning the ON/VOLUME control knob to the right increases the volume and to the left decreases it.

When the audio system is turned ON, the sound will be set at the same volume level as last played.

SEEK Buttons

Press and release the SEEK buttons to search for the next listenable station in AM/FM mode. Press the right switch to seek up and the left switch to seek down. The radio will remain tuned to the new station until you make another selection. Holding either button will bypass stations without stopping until you release it.

SCAN Button

Pressing the SCAN button causes the tuner to search for the next listenable station in AM, FM or Satellite (if equipped) frequencies, pausing for five seconds at each listenable station before continuing to the next. To stop the search, press the SCAN button a second time.

Voice Command Button Uconnect™ Phone — If Equipped

Press this button to operate the Uconnect™ Phone feature (if equipped). Refer to “Voice Command in the Uconnect™ User Manual located on the DVD for further details.

If your vehicle is not equipped with or this feature is not available on your vehicle, a “Not Equipped With Uconnect Phone” message will display on the radio screen.

Phone Button Uconnect™ Phone — If Equipped

Press this button to operate the Uconnect™ Phone feature (if equipped). Refer to “Uconnect™ Phone” in the Uconnect™ User Manual located on the DVD for further details.

If your vehicle is not equipped with or this feature is not available on your vehicle, a “Not Equipped With Uconnect Phone” message will display on the radio screen.

TIME Button

Press the TIME button to alternate locations of the time and frequency display.

Clock Setting Procedure

1. Press and hold the TIME button until the hours blink.
2. Adjust the hours by turning the right side TUNE/SCROLL control knob.
3. After adjusting the hours, press the right side TUNE/SCROLL control knob to set the minutes. The minutes will begin to blink.
4. Adjust the minutes using the right side TUNE/SCROLL control knob. Press the TUNE/SCROLL control knob to save the time change.
5. To exit, press any button/knob or wait five seconds.

The clock can also be set by pressing the SETUP button and selecting the "SET HOME CLOCK" entry. Once in this display follow the above procedure, starting at step 2.

INFO Button

Press the INFO button for an RDS station (one with call letters displayed). The radio will return a Radio Text message broadcast from an FM station (FM mode only).

RW/FF

Pressing the RW (Rewind) or FF (Fast Forward) buttons causes the tuner to search for the next frequency in the direction of the arrows. This feature operates in AM, FM or Satellite (if equipped) frequencies.

TUNE Control

Turn the rotary TUNE/SCROLL control knob clockwise to increase or counterclockwise to decrease the frequency.

Setting the Tone, Balance, and Fade

Push the rotary TUNE/SCROLL control knob and BASS will display. Turn the TUNE/SCROLL control knob to the right or left to increase or decrease the bass tones.

Push the rotary TUNE/SCROLL control knob a second time and MID will display. Turn the TUNE/SCROLL control knob to the right or left to increase or decrease the mid-range tones.

Push the rotary TUNE/SCROLL control knob a third time and TREBLE will display. Turn the TUNE/SCROLL control knob to the right or left to increase or decrease the treble tones.

Push the rotary TUNE/SCROLL control knob a fourth time and BALANCE will display. Turn the TUNE/SCROLL control knob to the right or left to adjust the sound level from the right or left side speakers.

Push the rotary TUNE/SCROLL control knob a fifth time and FADE will display. Turn the TUNE/SCROLL control knob to the left or right to adjust the sound level between the front and rear speakers.

Push the rotary TUNE/SCROLL control knob again to exit setting tone, balance, and fade.

MUSIC TYPE Button

Pressing this button once will turn on the Music Type mode for five seconds. Pressing the MUSIC TYPE button or turning the TUNE/SCROLL control knob within five seconds will allow the program format type to be selected. Many radio stations do not currently broadcast Music Type information.

Toggle the MUSIC TYPE button to select the following format types:

Program Type	16-Digit Character Display
No program type or undefined	None
Adult Hits	Adlt Hit
Classical	Classicl
Classic Rock	Cls Rock
College	College
Country	Country
Foreign Language	Language

Program Type	16-Digit Character Display
Information	Inform
Jazz	Jazz
News	News
Nostalgia	Nostalgia
Oldies	Oldies
Personality	Persnlty
Public	Public
Rhythm and Blues	R & B
Religious Music	Rel Musc
Religious Talk	Rel Talk
Rock	Rock
Soft	Soft
Soft Rock	Soft Rck
Soft Rhythm and Blues	Soft R & B
Sports	Sports
Talk	Talk

Program Type	16-Digit Character Display
Top 40	Top 40
Weather	Weather

By pressing the SEEK button when the Music Type icon is displayed, the radio will be tuned to the next frequency station with the same selected Music Type name. The Music Type function only operates when in the FM mode.

If a preset button is activated while in the Music Type (Program Type) mode, the Music Type mode will be exited and the radio will tune to the preset station.

SETUP Button

Pressing the SETUP button allows you to select between the following items:

NOTE: Turn the TUNE/SCROLL control knob to scroll through the entries. Push the AUDIO/SELECT button to select an entry and make changes.

- **DVD Enter** - When the disc is in DVD Menu mode, selecting DVD Enter will allow you to play the current highlighted selection. Use the remote control to scroll up and down the menu (if equipped).



- **DISC Play/Pause** - You can toggle between playing the DVD and pausing the DVD by pushing the SELECT button (if equipped).

- **DVD Play Options** - Selecting the DVD Play Options will display the following:
 - Subtitle – Repeatedly pressing SELECT will switch subtitles to different subtitle languages that are available on the disc (if equipped).
 - Audio Stream – Repeatedly pressing SELECT will switch to different audio languages (if supported on the disc) (if equipped).

- Angle – Repeatedly pressing SELECT will change the viewing angle if supported by the DVD disc (if equipped).

NOTE:

- The available selections for each of the above entries varies depending upon the disc.
- These selections can only be made while playing a DVD.
- **VES™ Power** - Allows you to turn VES™ ON and OFF (if equipped).
- **VES™ Lock** - Locks out rear VES™ remote controls (if equipped).
- **VES™ CH1/CH2** - Allows the user to change the mode of either the IR1 or IR2 wireless headphones by pressing the AUDIO/SELECT button (if equipped).

- **Set Home Clock** - Pressing the SELECT button allows you to set the clock. Turn the TUNE/SCROLL control knob to adjust the hours and then press and turn the TUNE/SCROLL control knob to adjust the minutes. Press the TUNE/SCROLL control knob again to save changes.
- **Player Defaults** - Selecting this item will allow the user to scroll through the following items and set defaults according to customer preference.

Menu Language — If Equipped

Selecting this item will allow the user to choose the default startup DVD menu language (effective only if language supported by disc). If you want to select a language not listed, then scroll down and select "other." Enter the four-digit country code using the TUNE/SCROLL control knob to scroll up and down to select the number and then push to select.

Audio Language — If Equipped

Selecting this item allows you to choose a default audio language (effective only if the language is supported by the disc). You can select a language not listed by scrolling down and selecting "other." Enter the country code using the TUNE/SCROLL control knob to scroll up and down to select the number and then push to select.

Subtitle Language — If Equipped

Selecting this item allows you to choose a default subtitle language (effective only if the language is supported by the disc). You can select a language not listed by scrolling down and selecting "other." Enter the country code using the TUNE/SCROLL control knob to scroll up and down to select the number and then push to select.

Subtitles — If Equipped

Selecting this item allows you to choose between subtitle Off or On.

Audio DRC — If Equipped

Selecting this item allows you to limit maximum audio dynamic range. The default is set to "High," and under this setting, dialogues will play at 11 db higher than if the setting is "Normal."

Aspect Ratio — If Equipped

Selecting this item allows you to choose between wide screen, pan scan, and letter box.

AutoPlay — If Equipped

When this is set to On and a DVD video is inserted, it will bypass the DVD menu screen and automatically play the movie. In some rare cases, the DVD player may not auto-play the main title. In such cases, use the MENU button on the remote control to select desired title to play.

NOTE: The user will have to set these defaults before loading a disc. If changes are made to these settings after a disc is loaded, changes will not be effective. Also, the defaults are effective only if the disc supports the customer-preferred settings.

AM and FM Buttons

Press the buttons to select AM or FM mode.

SET Button — To Set the Pushbutton Memory

When you are receiving a station that you wish to commit to pushbutton memory, press the SET button. The symbol SET 1 will now show in the display window. Select the button (1-6) you wish to lock onto this station and press and release that button. If a button is not selected within five seconds after pressing the SET button, the station will continue to play but will not be stored into pushbutton memory.

You may add a second station to each pushbutton by repeating the above procedure with this exception: Press the SET button twice and SET 2 will show in the display window. Each button can be set for SET 1 and SET 2 in both AM and FM. This allows a total of 12 AM, 12 FM, and 12 Satellite (if equipped) stations to be stored into pushbutton memory. The stations stored in SET 2 memory can be selected by pressing the pushbutton twice.

Every time a preset button is used, a corresponding button number will display.

Buttons 1 - 6

These buttons tune the radio to the stations that you commit to pushbutton memory {12 AM, 12 FM, and 12 Satellite (if equipped) stations}.

DISC Button

Pressing the DISC button will allow you to switch from AM/FM modes to Disc modes.

Operation Instructions - (DISC MODE for CD and MP3/WMA Audio Play, DVD-VIDEO)

The radio DVD player and many DVD discs are coded by geographic region. These region codes must match in order for the disc to play. If the region code for the DVD disc does not match the region code for the radio DVD player, it will not play the disc. Customers may take their vehicle to an authorized dealer to change the region code of the player a maximum of five times.

CAUTION!

The radio may shut down during extremely hot conditions. When this occurs, the radio will indicate "Disc Hot" and shut off until a safe temperature is reached. This shutdown is necessary to protect the optics of the DVD player and other radio internal components.

NOTE: The ignition switch must be in the ON or ACC position to operate the radio.

LOAD Button — Loading Compact Disc(s)

Press the LOAD button and the pushbutton with the corresponding number (1-6) where the CD is being loaded. The radio will display PLEASE WAIT and prompt when to INSERT DISC. After the radio displays "INSERT DISC," insert the CD into the player.

Radio display will show "LOADING DISC" when the disc is loading and "READING DISC" when the radio is reading the disc.

CAUTION!

This CD player will accept 4-3/4 in (12 cm) discs only. The use of other sized discs may damage the CD player mechanism.

Eject Button — Ejecting Compact Disc(s)



Press the EJECT button and the pushbutton with the corresponding number (1-6) where the CD was loaded and the disc will unload and move to the entrance for easy removal. Radio display will show "EJECTING DISC" when the disc is being ejected and prompt the user to remove the disc.

Press and hold the EJECT button for five seconds and all CDs will be ejected from the radio.

The disc can be ejected with the radio and ignition OFF.

SEEK Button (CD MODE)

Press the right SEEK button for the next selection on the CD. Press the left SEEK button to return to the beginning of the current selection, or return to the beginning of the previous selection if the CD is within the first second of the current selection. Pressing and holding the SEEK button will allow you to scroll through the tracks faster in CD and MP3/MWA modes.

SCAN Button (CD MODE)

Press the SCAN button to scan through each track on the CD currently playing.

TIME Button (CD MODE)

Press this button to change the display from a large CD playing time display to a small CD playing time display.

RW/FF (CD MODE)

Press and hold FF (Fast Forward) and the CD player will begin to fast forward until FF is released, or RW or another CD button is pressed. The RW (Rewind) button works in a similar manner.

AM or FM Button (CD MODE)

Switches the radio into the AM or FM radio mode.

Notes On Playing MP3/WMA Files

The radio can play MP3/WMA files; however, acceptable MP3/WMA file recording media and formats are limited. When writing MP3/WMA files, pay attention to the following restrictions.

Supported Media (Disc Types)

The MP3/WMA file recording media supported by the radio are CDDA, CD-R, CD-RW, MP3, WMA, DVD Video, DVD-R, DVD-RW, DVD+R, DVD+RW, and CDDA+MP3.

Supported Medium Formats (File Systems)

The medium formats supported by the radio are ISO 9660 Level 1 and Level 2 and includes the Joliet extension. When reading discs recorded using formats other than ISO 9660 Level 1 and Level 2, the radio may fail to read files properly and may be unable to play the file normally. UDF and Apple HFS formats are not supported.

The radio uses the following limits for file systems:

- Maximum number of directory levels: 8
- Maximum number of files: 255
- Maximum number of folders: 100
- Maximum number of characters in file/folder names:
 - Level 1: 12 (including a separator "." and a three-character extension)
 - Level 2: 31 (including a separator "." and a three-character extension)

Multisession disc formats are supported by the radio. Multisession discs may contain combinations of normal CD audio tracks and computer files (including MP3/WMA files). Discs created with an option such as "keep disc open after writing" are most likely multisession discs. The use of multisession for CD audio or MP3/WMA playback may result in longer disc loading times.

If a disc contains multi-formats, such as CD audio and MP3/WMA tracks, the radio will only play the MP3/WMA tracks on that disc.

Supported MP3/WMA File Formats

The radio will recognize only files with the *.MP3/WMA extension as MP3/WMA files. Non-MP3/WMA files named with the *.MP3/WMA extension may cause playback problems. The radio is designed to recognize the file as an invalid MP3/WMA and will not play the file.

When using the MP3/WMA encoder to compress audio data to an MP3/WMA file, the bit rate and sampling frequencies in the following table are supported. In addition, variable bit rates (VBR) are also supported. The majority of MP3/WMA files use a 44.1 kHz sampling rate and a 192, 160, 128, 96 or VBR bit rates.

MPEG Specification	Sampling Frequency (kHz)	Bit Rate (kbps)
MPEG-1 Audio Layer 3	48, 44.1, 32	320, 256, 224, 192, 160, 128, 112, 96, 80, 64, 56, 48
MPEG-2 Audio Layer 3	24, 22.05, 16	160, 128, 144, 112, 96, 80, 64, 56, 48

WMA Specification	Sampling Frequency (kHz)	Bit Rate (kbps)
WMA	44.1 and 48	48, 64, 96, 128, 160, 192 VBR

ID3 Tag information for artist, song title, and album title are supported for ID3 version 1 tags. ID3 version 2 is not supported by the radios.

Playlist files are not supported. MP3 Pro files are not supported.

Playback of MP3/WMA Files

When a medium containing MP3/WMA data is loaded, the radio checks all files on the medium. If the medium contains a lot of folders or files, the radio will take more time to start playing the MP3/WMA files.

Loading times for playback of MP3/WMA files may be affected by the following:

- Media - CD-RW media may take longer to load than CD-R media
- Medium formats - Multisession discs may take longer to load than non-multisession discs
- Number of files and folders - Loading times will increase with more files and folders

To increase the speed of disc loading, it is recommended to use CD-R media and single-session discs. To create a single-session disc, enable the "Disc at Once" option before writing to the disc.

LIST Button (DISC Mode for MP3/WMA Play)

Pressing the LIST button will bring up a list of all folders on the disc. Scrolling up or down the list is done by turning the TUNE/SCROLL control knob. Selecting a folder by pressing the TUNE/SCROLL control knob will begin playing the files contained in that folder (or the next folder in sequence if the selection does not contain playable files).

The folder list will time out after five seconds.

INFO Button (DISC Mode for MP3/WMA Play)

Pressing the INFO button repeatedly will scroll through the following TAG information: Song Title, Artist, File Name, and Folder Name (if available).

Press the INFO button once more to return to "elapsed time" priority mode.

Press and hold the INFO button for three seconds or more and radio will display song titles for each file.

Press and hold the INFO button again for three seconds to return to "elapsed time" display.

Operation Instructions - Auxiliary Mode

The auxiliary (AUX) jack is an audio input jack which allows the user to plug in a portable device such as an MP3/WMA player, cassette player, or microphone and utilize the vehicle's audio system to amplify the source and play through the vehicle speakers.

Pressing the AUX button will change the mode to auxiliary device if the AUX jack is connected.

NOTE: The AUX device must be turned on and the device's volume set to the proper level. If the AUX audio is not loud enough, turn the device's volume up. If the AUX audio sounds distorted, turn the device's volume down.

SEEK Button (Auxiliary Mode)

No function.

SCAN Button (Auxiliary Mode)

No function.

EJECT Button (Auxiliary Mode)

No function.



TIME Button (Auxiliary Mode)

Press the TIME button to change the display from elapsed playing time to time of day. The time of day will display for five seconds.

RW/FF (Auxiliary Mode)

No function.

SET Button (Auxiliary Mode)

No function.

Operating Instructions — Voice Command System (If Equipped)

For the radio, Refer to “Voice Command” in the Uconnect™ User Manual located on the DVD for further details.

Operating Instructions - Uconnect™ Phone (If Equipped)

Refer to “Uconnect™ Phone” in the Uconnect™ User Manual located on the DVD for further details.

Operating Instructions - Video Entertainment System (VES)™ (If Equipped)

Refer to “Video Entertainment System (VES)™” in the Uconnect™ User Manual located on the DVD for further details.

Dolby®

Manufactured under license from Dolby® Laboratories. “Dolby®” and the double-D symbol are trademarks of Dolby® Laboratories.

Macrovision

This product incorporates copyright protection technology that is protected by U.S. patents and other intellectual property rights. Use of this copyright protection technology must be authorized by Macrovision, and is intended for home and other limited viewing uses only, unless otherwise authorized by Macrovision. Reverse engineering or disassembly is prohibited.

DTS™

"DTS™" and "DTS™ 2.0" are trademarks of Digital Theater Systems, Inc.

Uconnect™ Multimedia (Satellite Radio) — If Equipped

Satellite radio uses direct satellite-to-receiver broadcasting technology to provide clear digital sound, coast to coast. The subscription service provider is Sirius Satellite Radio. This service offers over 130 channels of music, sports, news, entertainment, and programming for children, directly from its satellites and broadcasting studios.

NOTE: Sirius service is not available in Hawaii and has limited coverage in Alaska.

System Activation

Sirius Satellite Radio service is pre-activated, and you may begin listening immediately to the one year of audio service that is included with the factory-installed satellite radio system in your vehicle. Sirius will supply a welcome kit that contains general information, including how to setup your on-line listening account. For further information, call the toll-free number 888-539-7474, or visit the Sirius web site at www.sirius.com, or at www.siriuscanada.ca for Canadian residents.

Electronic Serial Number/Sirius Identification Number (ESN/SID)

Please have the following information available when calling:

1. The Electronic Serial Number/Sirius Identification Number (ESN/SID).

2. Your Vehicle Identification Number.

To access the ESN/SID, refer to the following steps:

ESN/SID Access

With the ignition switch in the ON/RUN or ACC position and the radio on, press the SETUP button and scroll using the TUNE/SCROLL control knob until Sirius ID is selected. Press the TUNE/SCROLL control knob and the Sirius ID number will display. The Sirius ID number display will time out in two minutes. Press any button on the radio to exit this screen.

Selecting Uconnect™ Multimedia (Satellite) Mode

Press the SAT button until "SAT" appears in the display. A CD may remain in the radio while in the Satellite radio mode.

Satellite Antenna

To ensure optimum reception, do not place items on the roof around the rooftop antenna location. Metal objects

placed within the line of sight of the antenna will cause decreased performance. Larger luggage items such as bikes should be placed as far rearward as possible, within the loading design of the rack. Do not place items directly on or above the antenna.

Reception Quality

Satellite reception may be interrupted due to one of the following reasons:

- The vehicle is parked in an underground parking structure or under a physical obstacle.
- Dense tree coverage may interrupt reception in the form of short audio mutes.
- Driving under wide bridges or along tall buildings can cause intermittent reception.
- Placing objects over or too close to the antenna can cause signal blockage.

Operating Instructions - Uconnect™ Multimedia (Satellite) Mode

NOTE: The ignition switch must be in the ON/RUN or ACC position to operate the radio.

SEEK Buttons

Press and release the SEEK buttons to search for the next channel in Satellite mode. Press the right switch to seek up and the left switch to seek down. The radio will remain tuned to the new channel until you make another selection. Holding either button will bypass channels without stopping until you release it.

SCAN Button

Pressing the SCAN button causes the tuner to search for the next channel, pausing for eight seconds before continuing to the next. To stop the search, press the SCAN button a second time.

INFO Button

Pressing the INFO button will cycle the display information between Artist, Song Title, and Composer (if available). Also, pressing and holding the INFO button for an additional three seconds will make the radio display the Song Title all of the time (press and hold again to return to normal display).

RW/FF

Pressing the RW (Rewind) or FF (Fast Forward) buttons causes the tuner to search for the next channel in the direction of the arrows.

TUNE Control (Rotary)

Turn the rotary TUNE/SCROLL control knob clockwise to increase or counterclockwise to decrease the channel.

MUSIC TYPE Button

Pressing this button once will turn on the Music Type mode for five seconds. Pressing the MUSIC TYPE button or turning the TUNE/SCROLL control knob within five seconds will allow the program format type to be selected.

Toggle the MUSIC TYPE button again to select the music type.

By pressing the SEEK button when the Music Type function is active, the radio will be tuned to the next channel with the same selected Music Type name.

If a preset button is activated while in the Music Type (Program Type) mode, the Music Type mode will be exited and the radio will tune to the preset channel.

SETUP Button

Pressing the SETUP button allows you to select the following items:

- Display Sirius ID number — Press the AUDIO/SELECT button to display the Sirius ID number. This number is used to activate, deactivate, or change the Sirius subscription.

SET Button – To Set the Pushbutton Memory

When you are receiving a channel that you wish to commit to pushbutton memory, press the SET button. The symbol SET 1 will now show in the display window. Select the button (1-6) you wish to lock onto this channel and press and release that button. If a button is not selected within five seconds after pressing the SET button, the channel will continue to play but will not be stored into pushbutton memory.

You may add a second channel to each pushbutton by repeating the above procedure with this exception: Press the SET button twice and SET 2 will show in the display window. Each button can be set for SET 1 and SET 2. This allows a total of 12 Satellite channels to be stored into pushbutton memory. The channels stored in SET 2 memory can be selected by pressing the pushbutton twice.

Every time a preset button is used, a corresponding button number will display.

Buttons 1 - 6

These buttons tune the radio to the channels that you commit to pushbutton memory (12 Satellite stations).

MEDIA CENTER 730N/430/430N (RHR/RER/RBZ/RHB) CD/DVD/HDD/NAV — IF EQUIPPED

NOTE: The sales code is located on the lower right side of the unit's faceplate.

Refer to your Uconnect™ Multimedia RHR, RER, RBZ or RHB user's manual for detailed operating instructions.

Operating Instructions (Voice Command System) — If Equipped

Refer to "Voice Command" in the Uconnect™ User Manual located on the DVD for further details.

Operating Instructions (Uconnect™ Phone) — If Equipped

Refer to "Uconnect™ Phone" in the Uconnect™ User Manual located on the DVD for further details.

MEDIA CENTER 130 (SALES CODE RES)

NOTE: The radio sales code is located on the lower right side of the radio faceplate.

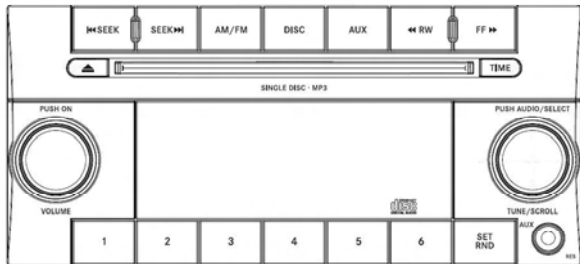

042305232

Media Center 130 (RES)

Operating Instructions — Radio Mode

NOTE: The ignition switch must be in the ON or ACC position to operate the radio.

Power Switch/Volume Control (Rotary)

Push the ON/VOLUME control knob to turn on the radio. Push the ON/VOLUME control knob a second time to turn off the radio.

Electronic Volume Control

The electronic volume control turns continuously (360 degrees) in either direction, without stopping. Turning the ON/VOLUME control knob to the right increases the volume, and to the left decreases it.

When the audio system is turned on, the sound will be set at the same volume level as last played.

SEEK Buttons

Press and release the SEEK buttons to search for the next listenable station in AM/FM mode. Press the right switch to seek up and the left switch to seek down. The radio will remain tuned to the new station until you make another selection. Holding either button will bypass stations without stopping, until you release it.

TIME Button

Press the TIME button to alternate display of the time and radio frequency.

Clock Setting Procedure

1. Press and hold the TIME button until the hours blink.
2. Adjust the hours by turning the right side TUNE/SCROLL control knob.
3. After adjusting the hours, press the right side TUNE/SCROLL control knob to set the minutes. The minutes will begin to blink.

4. Adjust the minutes using the right side TUNE/SCROLL control knob. Press the TUNE/SCROLL control knob to save time change.

5. To exit, press any button/knob, or wait five seconds.

RW/FF

Pressing the RW (Rewind) or FF (Fast Forward) buttons causes the tuner to search for the next frequency in the direction of the arrows. This feature operates in either AM or FM frequencies.

TUNE Control

Turn the rotary TUNE/SCROLL control knob clockwise to increase or counterclockwise to decrease the frequency.

Setting the Tone, Balance, and Fade

Push the rotary TUNE/SCROLL control knob and BASS will display. Turn the TUNE/SCROLL control knob to the right or left to increase or decrease the bass tones.

Push the rotary TUNE/SCROLL control knob a second time and MID will display. Turn the TUNE/SCROLL control knob to the right or left to increase or decrease the mid-range tones.

Push the rotary TUNE/SCROLL control knob a third time and TREBLE will display. Turn the TUNE/SCROLL control knob to the right or left to increase or decrease the treble tones.

Push the rotary TUNE/SCROLL control knob a fourth time and BALANCE will display. Turn the TUNE/SCROLL control knob to the right or left to adjust the sound level from the right or left side speakers.

Push the rotary TUNE/SCROLL control knob a fifth time and FADE will display. Turn the TUNE/SCROLL control knob to the left or right to adjust the sound level between the front and rear speakers.

Push the rotary TUNE/SCROLL control knob again to exit setting tone, balance, and fade.

AM/FM Button

Press the buttons to select either AM or FM mode.

SET/RND Button — To Set the Pushbutton Memory

When you are receiving a station that you wish to commit to pushbutton memory, press the SET/RND button. The symbol SET 1 will now show in the display window. Select the button (1 to 6) you wish to lock onto this station and press and release that button. If a button is not selected within five seconds after pressing the SET/RND button, the station will continue to play but will not be stored into pushbutton memory.

You may add a second station to each pushbutton by repeating the above procedure with this exception: Press the SET/RND button twice and SET 2 will show in the display window. Each button can be set for SET 1 and SET 2 in both AM and FM. This allows a total of 12 AM

and 12 FM stations to be stored into pushbutton memory. The stations stored in SET 2 memory can be selected by pressing the pushbutton twice.

Every time a preset button is used, a corresponding button number will display.

Buttons 1 - 6

These buttons tune the radio to the stations that you commit to pushbutton memory (12 AM and 12 FM stations).

DISC Button

Pressing the DISC button will allow you to switch from AM/FM modes to Disc modes.

Operation Instructions — CD MODE For CD And MP3 Audio Play

NOTE:

- The ignition switch must be in the ON or ACC position to operate the radio.

- This radio is capable of playing compact discs (CD), recordable compact discs (CD-R), rewritable compact discs (CD-RW), compact discs with MP3 tracks and multisession compact discs with CD and MP3 tracks.

Inserting Compact Disc(s)

Gently insert one CD into the CD player with the CD label facing up. The CD will automatically be pulled into the CD player and the CD icon will illuminate on the radio display. If a CD does not go into the slot more than 1.0 in (2.5 cm), a disc may already be loaded and must be ejected before a new disc can be loaded.

If you insert a disc with the ignition ON and the radio ON, the unit will switch from radio to CD mode and begin to play when you insert the disc. The display will show the track number, and index time in minutes and seconds. Play will begin at the start of track 1.

CAUTION!

- This CD player will accept 4-3/4 in (12 cm) discs only. The use of other sized discs may damage the CD player mechanism.
- Do not use adhesive labels. These labels can peel away and jam the player mechanism.
- RES is a single CD player. Do not attempt to insert a second CD if one is already loaded.
- Dual-media disc types (one side is a DVD, the other side is a CD) should not be used, and they can cause damage to the player.

EJECT Button - Ejecting a CD

Press the EJECT button to eject the CD.



If you have ejected a disc and have not removed it within 10 seconds, it will be reloaded. If the CD is not removed, the radio will reinsert the CD but will not play it.

A disc can be ejected with the radio and ignition OFF.

NOTE: Ejecting with the ignition OFF is not allowed on convertible or soft-top models (if equipped).

SEEK Button

Press the right SEEK button for the next selection on the CD. Press the left SEEK button to return to the beginning of the current selection, or return to the beginning of the previous selection if the CD is within the first second of the current selection. Pressing and holding the SEEK button will allow faster scrolling through the tracks in CD and MP3 modes.

TIME Button

Press this button to change the display from a large CD playing time display to a small CD playing time display.

RW/FF

Press and hold the FF (Fast Forward) button and the CD player will begin to fast forward until FF is released, or RW or another CD button is pressed. The RW (Reverse) button works in a similar manner.

AM/FM Button

Press the button to select either AM or FM mode.

SET/RND Button (Random Play Button)

Press this button while the CD is playing to activate Random Play. This feature plays the selections on the compact disc in random order to provide an interesting change of pace.

Press the right SEEK button to move to the next randomly selected track.

Press the RND button a second time to stop Random Play.

Notes on Playing MP3 Files

The radio can play MP3 files; however, acceptable MP3 file recording media and formats are limited. When writing MP3 files, pay attention to the following restrictions.

Supported Media (Disc Types)

The MP3 file recording media supported by the radio are CDDA, CD-R, CD-RW, MP3, and CDDA+MP3.

Supported Medium Formats (File Systems)

The medium formats supported by the radio are ISO 9660 Level 1 and Level 2 and includes the Joliet extension. When reading discs recorded using formats other than ISO 9660 Level 1 and Level 2, the radio may fail to read files properly and may be unable to play the file normally. UDF and Apple HFS formats are not supported.

The radio uses the following limits for file systems:

- Maximum number of folder levels: 8

- Maximum number of files: 255
- Maximum number of folders. (The radio display of file names and folder names is limited. For large numbers of files and/or folders, the radio may be unable to display the file name and folder name, and will assign a number instead. With a maximum number of files, exceeding 20 folders will result in this display. With 200 files, exceeding 50 folders will result in this display.)
- Maximum number of characters in file/folder names:
 - Level 1: 12 (including a separator "." and a three-character extension)
 - Level 2: 31 (including a separator "." and a three-character extension)

Multisession disc formats are supported by the radio. Multisession discs may contain combinations of normal CD audio tracks and computer files (including MP3 files).

Discs created with an option such as "keep disc open after writing" are most likely multisession discs. The use of multisession for CD audio or MP3 playback may result in longer disc loading times.

Supported MP3 File Formats

The radio will recognize only files with the *.MP3 extension as MP3 files. Non-MP3 files named with the *.MP3 extension may cause playback problems. The radio is designed to recognize the file as an invalid MP3 and will not play the file.

When using the MP3 encoder to compress audio data to an MP3 file, the bit rate and sampling frequencies in the following table are supported. In addition, variable bit rates (VBR) are also supported. The majority of MP3 files use a 44.1 kHz sampling rate and a 192, 160, 128, 96 or VBR bit rate.

MPEG Specification	Sampling Frequency (kHz)	Bit Rate (kbps)
MPEG-1 Audio Layer 3	48, 44.1, 32	320, 256, 224, 192, 160, 128, 112, 96, 80, 64, 56, 48, 40, 32
MPEG-2 Audio Layer 3	24, 22.05, 16	160, 128, 144, 112, 96, 80, 64, 56, 48, 40, 32, 24, 16, 8

ID3 Tag information for artist, song title, and album title are supported for version 1 ID3 tags. ID3 version 2 is not supported by the radios.

Playlist files are not supported. MP3 Pro files are not supported.

Playback of MP3 Files

When a medium containing MP3 data is loaded, the radio checks all files on the medium. If the medium contains a lot of folders or files, the radio will take more time to start playing the MP3 files.

Loading times for playback of MP3 files may be affected by the following:

- Media - CD-RW media may take longer to load than CD-R media
- Medium formats - Multisession discs may take longer to load than non-multisession discs
- Number of files and folders - Loading times will increase with more files and folders

To increase the speed of disc loading, it is recommended to use CD-R media and single-session discs. To create a single-session disc, enable the “Disc at Once” option before writing to the disc.

Operation Instructions - Auxiliary Mode

The auxiliary (AUX) jack is an audio input jack, which allows the user to plug in a portable device, such as an MP3 player, or cassette player, and utilize the vehicle's audio system to amplify the source and play through the vehicle speakers.

Pressing the DISC/AUX button will change the mode to auxiliary device if the AUX jack is connected.

NOTE: The AUX device must be turned on and the device's volume set to proper level. If the AUX audio is not loud enough, turn the device's volume up. If the AUX audio sounds distorted, turn the device's volume down.

TIME Button (Auxiliary Mode)

Press this button to change the display to time of day. The time of day will display for five seconds (when ignition is OFF).

MEDIA CENTER 130 WITH SATELLITE RADIO (SALES CODE RES+RSC)

NOTE: The radio sales code is located on the lower right side of the radio faceplate.

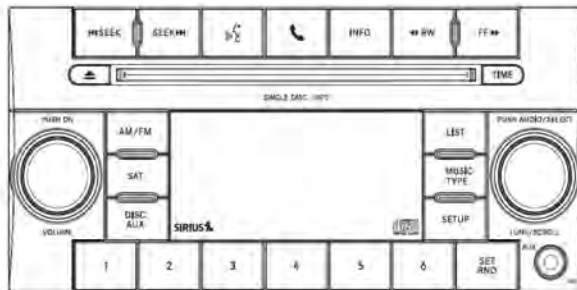

042340030

Media Center 130 (RES/RSC)

Operating Instructions — Radio Mode

NOTE: The ignition switch must be in the ON or ACC position to operate the radio.

Power Switch/Volume Control (Rotary)

Push the ON/VOLUME control knob to turn on the radio. Push the ON/VOLUME control knob a second time to turn off the radio.

Electronic Volume Control

The electronic volume control turns continuously (360 degrees) in either direction without stopping. Turning the ON/VOLUME control knob to the right increases the volume and to the left decreases it.

When the audio system is turned on, the sound will be set at the same volume level as last played.

SEEK Buttons

Press and release the SEEK buttons to search for the next listenable station in AM/FM mode. Press the right switch to seek up and the left switch to seek down. The radio will remain tuned to the new station until you make another selection. Holding either button will bypass stations without stopping until you release it.

Voice Command System (Radio) — If Equipped

Refer to “Voice Command” in “Understanding The Features If Your Vehicle”.

Voice Command Button Uconnect™ Phone — If Equipped

Press this button to operate the Uconnect™ Phone feature (if equipped). Refer to “Uconnect™ Phone” in “Understanding The Features If Your Vehicle”.

If your vehicle is not equipped with or this feature is not available on your vehicle, a “Not Equipped With Uconnect Phone” message will display on the radio screen.

Phone Button Uconnect™ Phone — If Equipped

Press this button to operate the Uconnect™ Phone feature (if equipped). Refer to “Uconnect™ Phone” in “Understanding The Features If Your Vehicle”.

If your vehicle is not equipped with or this feature is not available on your vehicle, a “Not Equipped With Uconnect Phone” message will display on the radio screen.

TIME Button

Press the TIME button to alternate display of the time and radio frequency.

Clock Setting Procedure

1. Press and hold the TIME button until the hours blink.
2. Adjust the hours by turning the right side TUNE/SCROLL control knob.

3. After adjusting the hours, press the right side TUNE/SCROLL control knob to set the minutes. The minutes will begin to blink.

4. Adjust the minutes using the right side TUNE/SCROLL control knob. Press the TUNE/SCROLL control knob to save time change.

5. To exit, press any button/knob or wait five seconds.

The clock can also be set by pressing the SETUP button. For vehicles equipped with satellite radio, press the SETUP button, use the TUNE/SCROLL control to select SET CLOCK, and then follow the above procedure, starting at Step 2. For vehicles not equipped with satellite radio, press the SETUP button and then follow the above procedure, starting at Step 2.

INFO Button

Press the INFO button for an RDS station (one with call letters displayed). The radio will return a Radio Text message broadcast from an FM station (FM mode only).

RW/FF

Pressing the RW (Rewind) or FF (Fast Forward) buttons causes the tuner to search for the next frequency in the direction of the arrows. This feature operates in either AM or FM frequencies.

TUNE Control

Turn the rotary TUNE/SCROLL control knob clockwise to increase or counterclockwise to decrease the frequency.

Setting the Tone, Balance, and Fade

Push the rotary TUNE/SCROLL control knob and BASS will display. Turn the TUNE/SCROLL control knob to the right or left to increase or decrease the bass tones.

Push the rotary TUNE/SCROLL control knob a second time and MID will display. Turn the TUNE/SCROLL control knob to the right or left to increase or decrease the mid-range tones.

Push the rotary TUNE/SCROLL control knob a third time and TREBLE will display. Turn the TUNE/SCROLL control knob to the right or left to increase or decrease the treble tones.

Push the rotary TUNE/SCROLL control knob a fourth time and BALANCE will display. Turn the TUNE/SCROLL control knob to the right or left to adjust the sound level from the right or left side speakers.

Push the rotary TUNE/SCROLL control knob a fifth time and FADE will display. Turn the TUNE/SCROLL control knob to the left or right to adjust the sound level between the front and rear speakers.

Push the rotary TUNE/SCROLL control knob again to exit setting tone, balance, and fade.

MUSIC TYPE Button

Pressing this button once will turn on the Music Type mode for five seconds. Pressing the MUSIC TYPE button or turning the TUNE/SCROLL control knob within five seconds will allow the program format type to be selected. Many radio stations do not currently broadcast Music Type information.

Toggle the MUSIC TYPE button to select the following format types:

Program Type	16-Digit Character Display
No program type or undefined	None
Adult Hits	Adlt Hit
Classical	Classicl
Classic Rock	Cls Rock
College	College
Country	Country
Foreign Language	Language

Program Type	16-Digit Character Display
Information	Inform
Jazz	Jazz
News	News
Nostalgia	Nostalgia
Oldies	Oldies
Personality	Persnlty
Public	Public
Rhythm and Blues	R & B
Religious Music	Rel Musc
Religious Talk	Rel Talk
Rock	Rock
Soft	Soft
Soft Rock	Soft Rck
Soft Rhythm and Blues	Soft R&B
Sports	Sports
Talk	Talk

Program Type	16-Digit Character Display
Top 40	Top 40
Weather	Weather

By pressing the SEEK button when the Music Type icon is displayed, the radio will be tuned to the next frequency station with the same selected Music Type name. The Music Type function only operates when in the FM mode.

If a preset button is activated while in the Music Type (Program Type) mode, the Music Type mode will be exited and the radio will tune to the preset station.

SETUP Button

Pressing the SETUP button allows you to select between the following items:

- **Set Clock** — Pressing the SELECT button will allow you to set the clock. Adjust the hours by turning the TUNE/SCROLL control knob. After adjusting the

hours, press the TUNE/SCROLL control knob to set the minutes. The minutes will begin to blink. Adjust the minutes using the right side TUNE/SCROLL control knob. Press the TUNE/SCROLL control knob to save time change.

AM/FM Button

Press the button to select either AM or FM mode.

SET/RND Button — To Set the Pushbutton Memory

When you are receiving a station that you wish to commit to pushbutton memory, press the SET/RND button. The symbol SET 1 will now show in the display window. Select the button (1–6) you wish to lock onto this station and press and release that button. If a button is not selected within five seconds after pressing the SET/RND button, the station will continue to play but will not be stored into pushbutton memory.

You may add a second station to each pushbutton by repeating the above procedure with this exception: Press the SET/RND button twice and SET 2 will show in the display window. Each button can be set for SET 1 and SET 2 in both AM and FM. This allows a total of 12 AM and 12 FM stations to be stored into pushbutton memory. The stations stored in SET 2 memory can be selected by pressing the pushbutton twice.

Every time a preset button is used, a corresponding button number will display.

Buttons 1 - 6

These buttons tune the radio to the stations that you commit to pushbutton memory (12 AM and 12 FM stations).

DISC/AUX Button

Pressing the DISC/AUX button will allow you to switch from AM/FM modes to DISC/AUX mode.

Operation Instructions — CD MODE for CD and MP3 Audio Play

NOTE:

- The ignition switch must be in the ON or ACC position to operate the radio.
- This radio is capable of playing compact discs (CD), recordable compact discs (CD-R), rewritable compact discs (CD-RW), compact discs with MP3 tracks and multisession compact discs with CD and MP3 tracks.

Inserting Compact Disc(s)

Gently insert one CD into the CD player with the CD label facing up. The CD will automatically be pulled into the CD player and the CD icon will illuminate on the radio display. If a CD does not go into the slot more than 1.0 in (2.5 cm), a disc may already be loaded and must be ejected before a new disc can be loaded.

If you insert a disc with the ignition ON and the radio ON, the unit will switch from radio to CD mode and begin to play when you insert the disc. The display will show the track number, and index time in minutes and seconds. Play will begin at the start of track 1.

CAUTION!

- This CD player will accept 4-3/4 in (12 cm) discs only. The use of other sized discs may damage the CD player mechanism.
- Do not use adhesive labels. These labels can peel away and jam the player mechanism.
- RES is a single CD player. Do not attempt to insert a second CD if one is already loaded.
- Dual-media disc types (one side is a DVD, the other side is a CD) should not be used, and they can cause damage to the player.

EJECT Button - Ejecting a CD

Press the EJECT button to eject the CD.



If you have ejected a disc and have not removed it within 10 seconds, it will be reloaded. If the CD is not removed, the radio will reinsert the CD but will not play it.

A disc can be ejected with the radio and ignition OFF.

NOTE: Ejecting with the ignition OFF is not allowed on convertible or soft-top models (if equipped).

SEEK Button

Press the right SEEK button for the next selection on the CD. Press the left SEEK button to return to the beginning of the current selection, or return to the beginning of the previous selection if the CD is within the first second of the current selection. Pressing and holding the SEEK button will allow faster scrolling through the tracks in CD and MP3 modes.

TIME Button

Press this button to change the display from a large CD playing time display to a small CD playing time display.

RW/FF

Press and hold FF (Fast Forward) and the CD player will begin to fast forward until FF is released or RW or another CD button is pressed. The RW (Reverse) button works in a similar manner.

AM/FM Button

Press the button to select either AM or FM mode.

SET/RND Button (Random Play Button)

Press this button while the CD is playing to activate Random Play. This feature plays the selections on the compact disc in random order to provide an interesting change of pace.

Press the right SEEK button to move to the next randomly selected track.

Press the SET/RND button a second time to stop Random Play.

Notes On Playing MP3 Files

The radio can play MP3 files; however, acceptable MP3 file recording media and formats are limited. When writing MP3 files, pay attention to the following restrictions.

Supported Media (Disc Types)

The MP3 file recording media supported by the radio are CDDA, CD-R, CD-RW, MP3, and CDDA+MP3.

Supported Medium Formats (File Systems)

The medium formats supported by the radio are ISO 9660 Level 1 and Level 2 and includes the Joliet extension. When reading discs recorded using formats other than ISO 9660 Level 1 and Level 2, the radio may fail to read files properly and may be unable to play the file normally. UDF and Apple HFS formats are not supported.

The radio uses the following limits for file systems:

- Maximum number of folder levels: 8
- Maximum number of files: 255
- Maximum number of folders. (The radio display of file names and folder names is limited. For large numbers of files and/or folders, the radio may be unable to display the file name and folder name and will assign a number instead. With a maximum number of files, exceeding 20 folders will result in this display. With 200 files, exceeding 50 folders will result in this display.)

- Maximum number of characters in file/folder names:
 - Level 1: 12 (including a separator "." and a three-character extension)
 - Level 2: 31 (including a separator "." and a three-character extension)

Multisession disc formats are supported by the radio. Multisession discs may contain combinations of normal CD audio tracks and computer files (including MP3 files). Discs created with an option such as "keep disc open after writing" are most likely multisession discs. The use of multisession for CD audio or MP3 playback may result in longer disc loading times.

Supported MP3 File Formats

The radio will recognize only files with the *.MP3 extension as MP3 files. Non-MP3 files named with the *.MP3 extension may cause playback problems. The radio is designed to recognize the file as an invalid MP3 and will not play the file.

When using the MP3 encoder to compress audio data to an MP3 file, the bit rate and sampling frequencies in the following table are supported. In addition, variable bit rates (VBR) are also supported. The majority of MP3 files use a 44.1 kHz sampling rate and a 192, 160, 128, 96 or VBR bit rates.

MPEG Specification	Sampling Frequency (kHz)	Bit Rate (kbps)
MPEG-1 Audio Layer 3	48, 44.1, 32	320, 256, 224, 192, 160, 128, 112, 96, 80, 64, 56, 48, 40, 32
MPEG-2 Audio Layer 3	24, 22.05, 16	160, 128, 144, 112, 96, 80, 64, 56, 48, 40, 32, 24, 16, 8

ID3 Tag information for artist, song title, and album title are supported for version 1 ID3 tags. ID3 version 2 is not supported by the radios.

Playlist files are not supported. MP3 Pro files are not supported.

Playback of MP3 Files

When a medium containing MP3 data is loaded, the radio checks all files on the medium. If the medium contains a lot of folders or files, the radio will take more time to start playing the MP3 files.

Loading times for playback of MP3 files may be affected by the following:

- Media - CD-RW media may take longer to load than CD-R media
- Medium formats - Multisession discs may take longer to load than non-multisession discs
- Number of files and folders - Loading times will increase with more files and folders

To increase the speed of disc loading, it is recommended to use CD-R media and single-session discs. To create a single-session disc, enable the "Disc at Once" option before writing to the disc.

LIST Button (CD Mode for MP3 Play)

Pressing the LIST button will bring up a list of all folders on the disc. Scrolling up or down the list is done by turning the TUNE/SCROLL control knob. Selecting a folder by pressing the TUNE/SCROLL control knob will begin playing the files contained in that folder (or the next folder in sequence if the selection does not contain playable files).

The folder list will time out after five seconds.

INFO Button (CD Mode for MP3 Play)

Pressing the INFO button repeatedly will scroll through the following TAG information: Song Title, Artist, File Name, and Folder Name (if available).

Press the INFO button once more to return to "elapsed time" priority mode.

Press and hold the INFO button for three seconds or more and the radio will display song titles for each file.

Press and hold the INFO button again for three seconds to return to "elapsed time" display.

Operation Instructions - Auxiliary Mode

The auxiliary (AUX) jack is an audio input jack which allows the user to plug in a portable device such as an MP3 player or cassette player and utilize the vehicle's audio system to amplify the source and play through the vehicle speakers.

Pressing the AUX button will change the mode to auxiliary device if the AUX jack is connected.

NOTE: The AUX device must be turned on and the device's volume set to the proper level. If the AUX audio

is not loud enough, turn the device's volume up. If the AUX audio sounds distorted, turn the device's volume down.

TIME Button (Auxiliary Mode)

Press this button to change the display to time of day. The time of day will display for five seconds (when the ignition is OFF).

Uconnect™ Multimedia (Satellite Radio) — If Equipped

Satellite radio uses direct satellite-to-receiver broadcasting technology to provide clear digital sound, coast to coast. The subscription service provider is Sirius Satellite Radio. This service offers over 130 channels of music, sports, news, entertainment, and programming for children, directly from its satellites and broadcasting studios.

NOTE: Sirius service is not available in Hawaii and has limited coverage in Alaska.

System Activation

Sirius Satellite Radio service is pre-activated, and you may begin listening immediately to the one year of audio service that is included with the factory-installed satellite radio system in your vehicle. Sirius will supply a welcome kit that contains general information, including how to setup your on-line listening account. For further information, call the toll-free number 888-539-7474, or visit the Sirius web site at www.sirius.com, or at www.siriuscanada.ca for Canadian residents.

Electronic Serial Number/Sirius Identification Number (ESN/SID)

Please have the following information available when calling:

1. The Electronic Serial Number/Sirius Identification Number (ESN/SID).
2. Your Vehicle Identification Number.

To access the ESN/SID, refer to the following steps:

ESN/SID Access

With the ignition switch in the ON/RUN or ACC position and the radio on, press the SETUP button and scroll using the TUNE/SCROLL control knob until Sirius ID is selected. Press the TUNE/SCROLL control knob and the Sirius ID number will display. The Sirius ID number display will time out in two minutes. Press any button on the radio to exit this screen.

Selecting Uconnect™ Multimedia (Satellite) Mode

Press the SAT button until "SAT" appears in the display. A CD may remain in the radio while in the Satellite radio mode.

Satellite Antenna

To ensure optimum reception, do not place items on the roof around the rooftop antenna location. Metal objects placed within the line of sight of the antenna will cause decreased performance. Larger luggage items such as

bikes should be placed as far rearward as possible, within the loading design of the rack. Do not place items directly on or above the antenna.

Reception Quality

Satellite reception may be interrupted due to one of the following reasons:

- The vehicle is parked in an underground parking structure or under a physical obstacle.
- Dense tree coverage may interrupt reception in the form of short audio mutes.
- Driving under wide bridges or along tall buildings can cause intermittent reception.
- Placing objects over or too close to the antenna can cause signal blockage.

Operating Instructions - Uconnect™ Multimedia (Satellite) Mode

NOTE: The ignition switch must be in the ON/RUN or ACC position to operate the radio.

SEEK Buttons

Press and release the SEEK buttons to search for the next channel in Satellite mode. Press the right switch to seek up and the left switch to seek down. The radio will remain tuned to the new channel until you make another selection. Holding either button will bypass channels without stopping until you release it.

SCAN Button

Pressing the SCAN button causes the tuner to search for the next channel, pausing for eight seconds before continuing to the next. To stop the search, press the SCAN button a second time.

INFO Button

Pressing the INFO button will cycle the display information between Artist, Song Title, and Composer (if available). Also, pressing and holding the INFO button for an additional three seconds will make the radio display the Song Title all of the time (press and hold again to return to normal display).

RW/FF

Pressing the RW (Rewind) or FF (Fast Forward) buttons causes the tuner to search for the next channel in the direction of the arrows.

TUNE Control (Rotary)

Turn the rotary TUNE/SCROLL control knob clockwise to increase or counterclockwise to decrease the channel.

MUSIC TYPE Button

Pressing this button once will turn on the Music Type mode for five seconds. Pressing the MUSIC TYPE button or turning the TUNE/SCROLL control knob within five seconds will allow the program format type to be selected.

Toggle the MUSIC TYPE button again to select the music type.

By pressing the SEEK button when the Music Type function is active, the radio will be tuned to the next channel with the same selected Music Type name.

If a preset button is activated while in the Music Type (Program Type) mode, the Music Type mode will be exited and the radio will tune to the preset channel.

SETUP Button

Pressing the SETUP button allows you to select the following items:

- Display Sirius ID number — Press the AUDIO/SELECT button to display the Sirius ID number. This number is used to activate, deactivate, or change the Sirius subscription.

SET Button – To Set the Pushbutton Memory

When you are receiving a channel that you wish to commit to pushbutton memory, press the SET button. The symbol SET 1 will now show in the display window. Select the button (1-6) you wish to lock onto this channel and press and release that button. If a button is not selected within five seconds after pressing the SET button, the channel will continue to play but will not be stored into pushbutton memory.

You may add a second channel to each pushbutton by repeating the above procedure with this exception: Press the SET button twice and SET 2 will show in the display window. Each button can be set for SET 1 and SET 2. This allows a total of 12 Satellite channels to be stored into pushbutton memory. The channels stored in SET 2 memory can be selected by pressing the pushbutton twice.

Every time a preset button is used, a corresponding button number will display.

Buttons 1 - 6

These buttons tune the radio to the channels that you commit to pushbutton memory (12 Satellite stations).

Operating Instructions - Uconnect™ Phone (If Equipped)

Refer to “Uconnect™ Phone” in “Understanding The Features If Your Vehicle”.

iPod® CONTROL — IF EQUIPPED

NOTE: This section is for sales code RES and REQ/REL/RET radios only with Uconnect™. For sales code RER, RBZ, REN, REP, REW, RB2 or REZ touch-screen radio iPod® control feature, refer to the separate RER, REN, RBZ, RB2 or REZ User’s Manual. iPod® control is available only if equipped as an option with these radios.

This feature allows an iPod® to be plugged into the vehicle’s sound system through a 16-pin connector, using the provided interface cable.

iPod® control supports Mini, 4G, Photo, Nano, 5G iPod® and iPhone® devices. Some iPod® software versions may not fully support the iPod® control features. Please visit Apple’s website for software updates.

NOTE:

- If the radio has a USB port, refer to the appropriate Uconnect Multimedia radio user's manual for iPod or external USB device support capability.
- Connecting an iPod® to the AUX port located in the radio faceplate, plays media, but does not use the iPod® control feature to control the connected device.

Connecting The iPod®

Use the provided connection cable to connect an iPod® to the vehicle's 16-pin connector port (which is located in the glove compartment on some vehicles). Once the iPod® is connected and synchronized to the vehicle's iPod® control system (iPod® may take a few seconds to connect), the iPod® starts charging and is ready for use by pressing radio switches, as described below.

NOTE:

- It may be necessary to remove the connector pin protection cap from the 16-pin connector port, prior to connecting the cable.
- If the iPod® battery is completely discharged, it may not communicate with the iPod® control system until a minimum charge is attained. Leaving the iPod® connected to the iPod® control system may charge it to the required level.

Using This Feature

By using the provided connection cable to connect an iPod® to the vehicle's iPod® control 16-pin connector port:

- The iPod® audio can be played on the vehicle's sound system, providing metadata (artist, track title, album, etc.) information on the radio display.
- The iPod® can be controlled using the radio buttons to Play, Browse, and List the iPod® contents.

- The iPod® battery charges when plugged into the iPod® control connector (if supported by the specific iPod® device)

Controlling The iPod® Using Radio Buttons

To get into the iPod® control mode and access a connected iPod®, press the “AUX” button on the radio faceplate. Once in the iPod® control mode, iPod® audio tracks (if available from iPod®) start playing over the vehicle’s audio system.

Play Mode

When switched to iPod® control mode, the iPod® automatically starts Play mode. In Play mode, use the following buttons on the radio faceplate to control the iPod® and display data:

- Use the TUNE control knob to select the next or previous track.
 - Turning it clockwise (forward) by one click, while playing a track, skips to the next track.
 - Turning it counterclockwise (backward) by one click, during the first two seconds of the track, will jump to the previous track in the list. Turning this button at any other time in the track, will jump to the beginning of the current track.
- Jump backward in the current track by pressing and holding the << **RW** button. Holding the << **RW** button long enough will jump to the beginning of the current track.
- Jump forward in the current track by pressing and holding the **FF** >> button.
- A single press backward << **RW** or forward **FF** >> will jump backward or forward respectively, for five seconds.
- Use the << **SEEK** and **SEEK** >> buttons to jump to the previous or next track. If the << **SEEK** button is pressed during the first two seconds of the track, it will

jump to the previous track in the list; pressing this button at any other time in the track, it will jump to the beginning of the track. Pressing the **SEEK >>** button during play mode, it will jump to the next track in the list.

- While a track is playing, press the **INFO** button to see the associated metadata (artist, track title, album, etc.) for that track. Pressing the **INFO** button again jumps to the next screen of data for that track. Once all screens have been viewed, the last **INFO** button press will go back to the play mode screen on the radio.
- Pressing the **REPEAT** button will change the iPod® mode to repeat the current playing track.
- Press the **SCAN** button to use iPod® scan mode, which will play the first five seconds of each track in the current list and then forward to the next song. To stop **SCAN** mode and start playing the desired track, when it is playing the track, press the **SCAN** button again.

During Scan mode, pressing the << **SEEK** and **SEEK >>** buttons will select the previous and next tracks.

- **RND** button (available on sales code RES radio only): Pressing this button toggles between Shuffle ON and Shuffle OFF modes for the iPod®. If the **RND** icon is showing on the radio display, then the shuffle mode is ON.

List Or Browse Mode

During Play mode, pressing any of the buttons described below, will bring up List mode. List mode enables scrolling through the list of menus and tracks on the iPod®.

- **TUNE** control knob: The **TUNE** control knob functions in a similar manner as the scroll wheel on the iPod®.
- Turning it clockwise (forward) and counterclockwise (backward) scrolls through the lists, displaying

the track detail on the radio display. Once the track to be played is highlighted on the radio display, press the **TUNE** control knob to select and start playing the track. Turning the **TUNE** control knob fast will scroll through the list faster. During fast scroll, a slight delay in updating the information on the radio display may be noticed.

- During all List modes, the iPod® displays all lists in “wrap-around” mode. So if the track is at the bottom of the list, just turn the wheel backwards (counter-clockwise) to get to the track faster.
- In List mode, the radio **PRESET** buttons are used as shortcuts to the following lists on the iPod®.
 - Preset 1 – Playlists
 - Preset 2 – Artists
 - Preset 3 – Albums

- Preset 4 – Genres
- Preset 5 – Audiobooks
- Preset 6 – Podcasts
- Pressing a **PRESET** button will display the current list on the top line and the first item in that list on the second line.
- To Exit List mode without selecting a track, press the same **PRESET** button again to go back to **Play mode**.
- **LIST** button: The **LIST** button will display the top level menu of the iPod®. Turn the **TUNE** control knob to list the top-menu item to be selected and press the **TUNE** control knob. This will display the next sub-menu list item on the iPod® then follow the same steps to go to the desired track in that list. Not all iPod® sub-menu levels are available on this system.

- **MUSIC TYPE** button: The **MUSIC TYPE** button is another shortcut button to the genre listing on your iPod®.

CAUTION!

- Leaving the iPod® (or any supported device) anywhere in the vehicle in extreme heat or cold can alter the operation or damage the device. Follow the device manufacturer's guidelines.
- Placing items on the iPod®, or connections to the iPod® in the vehicle, can cause damage to the device and/or to the connectors.

WARNING!

Do not plug in or remove the iPod® while driving. Failure to follow this warning could result in an accident.

iPod®/USB/MP3 CONTROL — IF EQUIPPED

NOTE: This section is for sales code RES and REQ/REL/RET radios only with Uconnect™. For sales code RBZ/RHB, RHR, RHP, RHW or RB2 touch-screen radio iPod®/USB/MP3 control feature, refer to the separate RBZ/RHB, RHR, RHP, RHW or RB2 User's Manual. iPod®/USB/MP3 control is available only if equipped as an option with these radios.

This feature allows an iPod® or external USB device to be plugged into the USB port, located in the center console or glove compartment.

iPod® control supports Mini, 4G, Photo, Nano, 5G iPod® and iPhone® devices. Some iPod® software versions may not fully support the iPod® control features. Please visit Apple's website for software updates.

NOTE:

- If the radio has a USB port, refer to the appropriate Uconnect™ Multimedia radio User's Manual for iPod® or external USB device support capability.
- Connecting an iPod® or consumer electronic audio device to the AUX port located in the radio faceplate, plays media, but does not use the iPod® /MP3 control feature to control the connected device.

Connecting The iPod® Or External USB Device

Use the connection cable to connect an iPod® or external USB device to the vehicle's USB/AUX connector port which is located in the center console or glove compartment.



044136844

USB/AUX Connector Port

Once the audio device is connected and synchronized to the vehicle's iPod®/USB/MP3 control system (iPod® or external USB device may take a few minutes to connect), the audio device starts charging and is ready for use by pressing radio switches, as described below.

NOTE: If the audio device battery is completely discharged, it may not communicate with the iPod®/USB/MP3 control system until a minimum charge is attained. Leaving the audio device connected to the iPod®/USB/MP3 control system may charge it to the required level.

Using This Feature

By using iPod cable or external USB device to connect to USB port:

- The audio device can be played on the vehicle's sound system, providing metadata (artist, track title, album, etc.) information on the radio display.
- The audio device can be controlled using the radio buttons to Play, Browse, and List the iPod® contents.
- The audio device battery charges when plugged into the USB/AUX connector (if supported by the specific audio device)

Controlling The iPod® Or External USB Device Using Radio Buttons

To get into the iPod®/USB/MP3 control mode and access a connected audio device, either press the "AUX" button on the radio faceplate or press the VR button and say "USB" or "Switch to USB". Once in the iPod®/USB/MP3 control mode, audio tracks (if available from audio device) start playing over the vehicle's audio system.

Play Mode

When switched to iPod®/USB/MP3 control mode, the iPod® or external USB device automatically starts Play mode. In Play mode, the following buttons on the radio faceplate may be used to control the iPod® or external USB device and display data:

- Use the TUNE control knob to select the next or previous track.
 - Turning it clockwise (forward) by one click, while playing a track, skips to the next track or press the VR button and say "Next Track".

- Turning it counterclockwise (backward) by one click, will jump to the previous track in the list or press the VR button and say "Previous Track"
- Jump backward in the current track by pressing and holding the << **RW** button. Holding the << **RW** button long enough will jump to the beginning of the current track.
- Jump forward in the current track by pressing and holding the **FF** >> button.
- A single press backward << **RW** or forward **FF** >> will jump backward or forward respectively, for five seconds.
- Use the << **SEEK** and **SEEK** >> buttons to jump to the previous or next track. Pressing the **SEEK** >> button during play mode will jump to the next track in the list, or press the VR button and say "Next or Previous Track".
- While a track is playing, press the **INFO** button to see the associated metadata (artist, track title, album, etc.) for that track. Pressing the **INFO** button again jumps to the next screen of data for that track. Once all screens have been viewed, the last **INFO** button press will go back to the play mode screen on the radio.
- Pressing the **REPEAT** button will change the audio device mode to repeat the current playing track or press the VR button and say "Repeat ON" or "Repeat Off".
- Press the **SCAN** button to use iPod®/USB/MP3 device scan mode, which will play the first 10 seconds of each track in the current list and then forward to the next song. To stop SCAN mode and start playing the desired track, when it is playing the track, press the **SCAN** button again. During Scan mode, pressing the << **SEEK** and **SEEK** >> buttons will select the previous and next tracks.

- **RND** button (available on sales code RES radio only): Pressing this button toggles between Shuffle ON and Shuffle OFF modes for the iPod® or external USB device, or press the VR button and say "Shuffle ON" or "Shuffle Off". If the **RND** icon is showing on the radio display, then the shuffle mode is ON.

List Or Browse Mode

During Play mode, pressing any of the buttons described below, will bring up List mode. List mode enables scrolling through the list of menus and tracks on the audio device.

- **TUNE** control knob: The **TUNE** control knob functions in a similar manner as the scroll wheel on the audio device or external USB device.
- Turning it clockwise (forward) and counterclockwise (backward) scrolls through the lists, displaying the track detail on the radio display. Once the track to be played is highlighted on the radio display,

press the **TUNE** control knob to select and start playing the track. Turning the **TUNE** control knob fast will scroll through the list faster. During fast scroll, a slight delay in updating the information on the radio display may be noticeable.

- During all List modes, the iPod® displays all lists in "wrap-around" mode. So if the track is at the bottom of the list, just turn the wheel backward (counterclockwise) to get to the track faster.
- In List mode, the radio **PRESET** buttons are used as shortcuts to the following lists on the iPod® or external USB device.
 - Preset 1 – Playlists
 - Preset 2 – Artists
 - Preset 3 – Albums
 - Preset 4 – Genres

- Preset 5 – Audiobooks
- Preset 6 – Podcasts
- Pressing a PRESET button will display the current list on the top line and the first item in that list on the second line.
- To exit List mode without selecting a track, press the same PRESET button again to go back to Play mode.
- LIST button: The LIST button will display the top level menu of the iPod® or external USB device. Turn the TUNE control knob to list the top-menu item to be selected and press the TUNE control knob. This will display the next sub-menu list item on the audio device, then follow the same steps to go to the desired track in that list. Not all iPod® or external USB device sub-menu levels are available on this system.

- MUSIC TYPE button: The MUSIC TYPE button is another shortcut button to the genre listing on your audio device.

CAUTION!

- Leaving the iPod® or external USB device (or any supported device) anywhere in the vehicle in extreme heat or cold can alter the operation or damage the device. Follow the device manufacturer's guidelines.
- Placing items on the iPod® or external USB device, or connections to the iPod® or external USB device in the vehicle, can cause damage to the device and/or to the connectors.

WARNING!

Do not plug in or remove the iPod® or external USB device while driving. Failure to follow this warning could result in an accident.

Bluetooth Streaming Audio (BTSA)

Music can be streamed from your cellular phone to the Uconnect™ phone system.

Controlling BTSA Using Radio Buttons

To get into the BTSA mode, press either “AUX” button on the radio or press the VR button and say “Bluetooth Streaming Audio”.

Play Mode

When switched to BTSA mode, some audio devices can start playing music over the vehicle’s audio system, but some devices require the music to be initiated on the device first, then it will get streamed to the Uconnect™ phone system. Seven devices can be paired to the Uconnect™ phone system, but just one can be selected and played.

Selecting Different Audio Device

1. Press PHONE button to begin.
2. After the “Ready” prompt and the following beep, say “Setup”, then “Select Audio Devices”.
3. Say the name of the audio device or ask the Uconnect™ phone system to list audio devices.

Next Track

Use the SEEK UP button, or press the VR button on the radio and say “Next Track” to jump to the next track music on your cellular phone.

Previous Track

Use the SEEK DOWN button, or press the VR button on the radio and say “Previous Track” to jump to the previous track music on your cellular phone.

Browse

Browsing is not available on a BTSA device. Only the current song that is playing will display info.

**STEERING WHEEL AUDIO CONTROLS —
IF EQUIPPED**

The remote sound system controls are located on the rear surface of the steering wheel. Reach behind the wheel to access the switches.

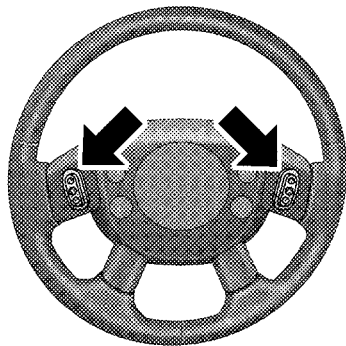

045003761

**Remote Sound System Controls
(Back View Of Steering Wheel)**

The right-hand control is a rocker type switch with a pushbutton in the center. Pressing the top of the switch will increase the volume, and pressing the bottom of the switch will decrease the volume.

The button located in the center of the right-hand control will switch modes to Radio or CD.

The left-hand control is a rocker type switch with a pushbutton in the center. The function of the left-hand control is different depending on which mode you are in.

The following describes the left-hand control operation in each mode.

Radio Operation

Press the top of the switch to SEEK up for the next listenable station. Press the bottom of the switch to SEEK down for the next listenable station.

The button located in the center of the left-hand control will tune to the next preset station that you have programmed in the radio preset pushbuttons.

CD Player

Press the top of the switch once to go to the next track on the CD. Press the bottom of the switch once to go to the beginning of the current track or to the beginning of the previous track, if it is within one second after the current track begins to play.

If you press the switch up or down twice it plays the second track, three times, it will play the third, etc.

The button in the center of the left-hand switch changes CD's on the 6-Disc in-dash CD changer radio. This button does not function for all other radios.

CD/DVD DISC MAINTENANCE

To keep a CD/DVD in good condition, take the following precautions:

1. Handle the disc by its edge; avoid touching the surface.

2. If the disc is stained, clean the surface with a soft cloth, wiping from center to edge.
3. Do not apply paper or tape to the disc; avoid scratching the disc.
4. Do not use solvents such as benzene, thinner, cleaners, or anti-static sprays.
5. Store the disc in its case after playing.
6. Do not expose the disc to direct sunlight.
7. Do not store the disc where temperatures may become too high.

NOTE: If you experience difficulty in playing a particular disc, it may be damaged (i.e., scratched, reflective coating removed, a hair, moisture or dew on the disc) oversized, or have protection encoding. Try a known good disc before considering disc player service.

RADIO OPERATION AND MOBILE PHONES

Under certain conditions, the mobile phone being on in your vehicle can cause erratic or noisy performance from your radio. This condition may be lessened or eliminated by relocating the mobile phone antenna. This condition is not harmful to the radio. If your radio performance does not satisfactorily “clear” by the repositioning of the antenna, it is recommended that the radio volume be turned down or off during mobile phone operation when not using Uconnect™ (if equipped).

CLIMATE CONTROLS

The air conditioning and heating system is designed to make you comfortable in all types of weather.

Manual Heating And Air Conditioning



The Manual Temperature Controls consist of a series of outer rotary dials and inner push knobs.

Blower Control



045607539

Rotate this control to regulate the amount of air forced through the ventilation system in any mode. The blower speed increases as you move the control to the right from the "O" (OFF) position. There are seven blower speeds.

NOTE: For vehicles equipped with Remote Start, the climate controls will not function during Remote Start operation if the blower control is left in the "O" (Off) position.

Temperature Control



045607540

Rotate this control to regulate the temperature of the air inside the passenger compartment. Rotating the dial left into the blue area of the scale indicates cooler temperatures, while rotating right into the red area indicates warmer temperatures.

NOTE: If your air conditioning performance seems lower than expected, check the front of the A/C condenser located in front of the radiator for an accumulation of dirt or insects. Clean with a gentle water spray from behind the radiator and through the condenser. Fabric front fascia protectors may reduce airflow to the condenser, reducing air conditioning performance.

Mode Control (Air Direction)



045607541

Rotate this control to choose from several patterns of air distribution. You can select either a primary mode as identified by the symbols on the control, or a blend of two of these modes. The closer the setting is to a particular symbol, the more air distribution you

receive from that mode.

Panel

 Air is directed through the outlets in the instrument panel. These outlets can be adjusted to direct airflow.

NOTE: The center instrument panel outlets can be aimed so that they are directed toward the rear seat passengers for maximum airflow to the rear.

Bi-Level

 Air is directed through the panel and floor outlets.

NOTE: For all settings, except full cold or full hot, there is a difference in temperature between the upper and lower outlets. The warmer air flows to the floor outlets. This feature gives improved comfort during sunny but cool conditions.

Floor

 Air is directed through the floor outlets with a small amount flowing through the defrost and side window demist outlets.

Mix

 Air is directed through the floor, defrost, and side window demist outlets. This setting works best in cold or snowy conditions that require extra heat to the windshield. This setting is good for maintaining comfort while reducing moisture on the windshield.

Defrost



Air is directed through the windshield and side window demist outlets. Use this mode with maximum blower and temperature settings for best windshield and side window defrosting.

NOTE:

- The air conditioning compressor operates in Mix, Defrost, or a blend of these modes, even if the Air Conditioning (A/C) button is not pressed. This dehumidifies the air to help dry the windshield. To improve fuel economy, use these modes only when necessary.
- For information on operating the Rear Defrost, refer to “Rear Window Features” in “Understanding The Features Of Your Vehicle”.

Recirculation Control



Pressing the Recirculation Control button will put the system in recirculation mode. This can be used when outside conditions such as smoke, odors, dust, or high humidity are present. Activating recirculation will cause the LED in the control button to illuminate.

NOTE:

- Continuous use of the Recirculation mode may make the inside air stuffy and window fogging may occur. Extended use of this mode is not recommended.
- The use of the Recirculation mode in cold or damp weather will cause windows to fog on the inside, because of moisture buildup inside the vehicle. Select the outside air position for maximum defogging.
- The A/C will engage automatically to prevent fogging when the recirculation button is pressed and the mode control is set to panel or panel / floor.

- The A/C can be deselected manually without disturbing the mode control selection.
- When the ignition switch is turned to the LOCK position, the recirculation feature will be cancelled.

Air Conditioning Control



045607557

Press this button to engage the Air Conditioning. A light will illuminate when the Air Conditioning system is engaged. Rotating the dial left into the blue area of the scale indicates cooler temperatures, while rotating right into the red area indicates warmer temperatures.

NOTE: The air conditioning compressor will not engage until the engine has been running for about 10 seconds.

- **MAX A/C**

For maximum cooling use the A/C and recirculation buttons at the same time.

- **ECONOMY MODE**

If economy mode is desired, press the A/C button to turn OFF the indicator light and the A/C compressor. Then, move the temperature control to the desired temperature.

Automatic Temperature Control (ATC) — If Equipped

The Automatic Temperature Control system automatically maintains the climate in the cabin of the vehicle at the comfort levels desired by the driver and passenger.



Automatic Temperature Control

Automatic Operation

Operation of the system is quite simple.

1. Turn the Mode Control knob (on the right) and the Blower Control knob (on the left) to AUTO.

NOTE: The AUTO position performs best for front seat occupants only.



045638695

conditioning, the system will automatically make the adjustment.

2. Dial in the temperature you would like the system to maintain by rotating the Temperature Control knob. Once the comfort level is selected, the system will maintain that level automatically using the heating system. Should the desired comfort level require air

You will experience the greatest efficiency by simply allowing the system to function automatically. Selecting the "O" (OFF) position on the blower control stops the system completely and closes the outside air intake.

The recommended setting for maximum comfort for the average person is 72°F (22°C); however, this may vary.

NOTE:

- The temperature setting can be adjusted at anytime without affecting automatic operation.
- Pressing the Air Conditioning Control button while in AUTO mode will cause the LED in the control button to flash three times and then turn off. This indicates that the system is in AUTO mode and requesting the air conditioning is not necessary.

- If your air conditioning performance seems lower than expected, check the front of the A/C condenser located in front of the radiator for an accumulation of dirt or insects. Clean with a gentle water spray from behind the radiator and through the condenser. Fabric front fascia protectors may reduce airflow to the condenser, reducing air conditioning performance.

Blower Control



045607536

For full automatic operation or for automatic blower operation, turn the knob to the AUTO position. In manual mode there are seven blower speeds that can be individual selected. In off position the blower will shut off.

Manual Operation

This system offers a full complement of manual override features, which consist of Blower Preferred Automatic, Mode Preferred Automatic, or Blower and Mode Preferred Automatic. This means the operator can override the blower, the mode, or both. There is a manual blower range for times when the AUTO setting is not desired. The blower can be set to any fixed blower speed by rotating the Blower Control knob (on the left).

NOTE: Please read the Automatic Temperature Control Operation Chart that follows for details.

Automatic Temperature Control Operation		The system will...				
Operation	How	Blower Control	Mode Control	Air Temperature Control	Air Recirculation Control	A/C Operation
Full Automatic Operation	Set blower knob to Auto. Set mode knob to Auto. Set temperature knobs for comfort.	Automatic	Automatic	Automatic	Automatic but can be overridden.	Automatic
Blower Preferred Automatic	Set blower knob to any desired airflow level other than Auto. Set mode knob to Auto. Set temperature knobs for comfort.	User selectable to any speed.	Automatic	Automatic	Automatic but can be overridden.	Automatic
Mode Preferred Automatic	Set mode knob to any desired air delivery point other than Auto. Set blower knob to Auto. Set temperature knobs for comfort.	Automatic	User selectable to any air delivery point.	Automatic	User selectable outside or recirculated.	User selectable A/C on or off.
Blower and Mode Preferred Automatic	Set blower knob to any desired airflow level other than Auto. Set mode knob to any desired air delivery point other than Auto. Set temperature knobs for comfort.	User selectable to any speed.	User selectable to any air delivery point.	Automatic	User selectable outside or recirculated.	User selectable A/C on or off.

The operator can override the AUTO mode setting to change airflow distribution by rotating the Mode Control knob (on the right) to one of the following positions.

- *Panel*

 Air is directed through the outlets in the instrument panel. These outlets can be adjusted to direct airflow.

NOTE: The center instrument panel outlets can be aimed so that they are directed toward the rear seat passengers for maximum airflow to the rear.

- *Bi-Level*

 Air is directed through the panel and floor outlets.

NOTE: For all settings, except full cold or full hot, there is a difference in temperature between the upper and lower outlets. The warmer air flows to the floor outlets. This feature gives improved comfort during sunny but cool conditions.

- *Floor*

 Air is directed through the floor outlets with a small amount flowing through the defrost and side window demist outlets.

- *Mix*

 Air is directed through the floor, defrost, and side window demist outlets. This setting works best in cold or snowy conditions that require extra heat to the windshield. This setting is good for maintaining comfort while reducing moisture on the windshield.

- *Defrost*

 Air is directed through the windshield and side window demist outlets. Use this mode with maximum blower and temperature settings for best windshield and side window defrosting.

- *Air Conditioner Control*



045638696

Press this button to turn on the air conditioning during manual operation only. When the air conditioning is turned on, cool dehumidified air will flow through the outlets selected with the Mode control dial. Press this button a second time to turn OFF the air conditioning. An LED in the button illuminates when manual compressor operation is selected.

- *Recirculation Control*



The system will automatically control recirculation. However, pressing the Recirculation Control button will put the system in recirculation mode. This can be used when outside conditions such as smoke, odors, dust, or high humidity are present. Activating recirculation will cause the LED in the control button to illuminate.

NOTE:

- When the ignition switch is turned to the LOCK position, the recirculation feature will be cancelled.
- In cold weather, use of the Recirculation mode may lead to excessive window fogging. The Recirculation mode is not allowed in the floor, defrost, or defrost/floor mode in order to improve window clearing. Recirculation will be disabled automatically if these modes are selected.
- Extended use of recirculation may cause the windows to fog. If the interior of the windows begins to fog, press the Recirculation button to return to outside air. Some temp/humidity conditions will cause captured interior air to condense on windows and hamper visibility. For this reason, the system will not allow Recirculation to be selected while in floor, defrost, or defrost/floor mode. Attempting to use the recirculation while in these modes will cause the LED in the control button to blink and then turn off.

- Most of the time, when in Automatic Operation, you can temporarily put the system into Recirculation Mode by pressing the Recirculation button. However, under certain conditions, while in Automatic Mode, the system is blowing air out the defrost vents. When these conditions are present, and the Recirculation button is pressed, the indicator will flash and then turn off. This tells you that you are unable to go into Recirculation Mode at this time. If you would like the system to go into Recirculation Mode, you must first move the Mode knob to Panel, Panel/Floor and then press the Recirculation button. This feature reduces the possibility of window fogging.

Operating Tips

NOTE: Refer to the chart at the end of this section for suggested control settings for various weather conditions.

Summer Operation

The engine cooling system in air-conditioned vehicles must be protected with a high-quality antifreeze coolant to provide proper corrosion protection and to protect against engine overheating. A solution of 50% ethylene glycol antifreeze coolant and 50% water is recommended. Refer to “Maintenance Procedures” in “Maintaining Your Vehicle” for proper coolant selection.

Winter Operation

Use of the air Recirculation Mode during winter months is not recommended because it may cause window fogging.

Vacation Storage

Anytime you store your vehicle, or keep it out of service (i.e., vacation) for two weeks or more, run the air conditioning system at idle for about five minutes in the fresh air and high blower settings. This will ensure adequate system lubrication to minimize the possibility of compressor damage when the system is started again.

Window Fogging

Interior fogging on the windshield can be quickly removed by turning the mode selector to Defrost. The Defrost/Floor mode can be used to maintain a clear windshield and provide sufficient heating. If side window fogging becomes a problem, increase blower speed. Vehicle windows tend to fog on the inside in mild but rainy or humid weather.

NOTE: Recirculate without A/C should not be used for long periods as fogging may occur.

Side Window Demisters

A side window demister outlet is located at each end of the instrument panel. These non-adjustable outlets direct air toward the side windows when the system is in the FLOOR, MIX, or DEFROST mode. The air is directed at the area of the windows through which you view the outside mirrors.











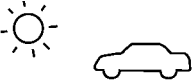









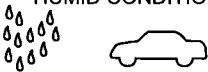

Outside Air Intake

Make sure the air intake, located directly in front of the windshield, is free of obstructions such as leaves. Leaves collected in the air intake may reduce airflow, and if they enter the plenum, they could plug the water drains. In winter months, make sure the air intake is clear of ice, slush, and snow.

A/C Air Filter — If Equipped

The A/C Filter prevents most dust and pollen from entering the cabin. The filter acts on air coming from outside the vehicle and recirculated air within the passenger compartment. Refer to “Maintenance Procedures” in “Maintaining Your Vehicle” for A/C Air Filter service information or see your authorized dealer for service. Refer to “Maintenance Schedules” for filter service intervals.

Control Setting Suggestions for Various Weather Conditions

WEATHER	CONTROL SETTINGS
<p>HOT WEATHER AND VEHICLE INTERIOR IS VERY HOT</p> 	<p>Open the windows, start the vehicle, press the  button to turn recirculate off. Set the Fan control to the high position (full clockwise). Press the A/C button. Set the Mode control at or between  and . Set the temperature control to full cool. After the hot air is pushed from the vehicle press the  button to turn recirculate on and roll up the windows. Once you are comfortable, press the  button to turn recirculate off and adjust the temperature control for comfort.</p>
<p>WARM WEATHER</p> 	<p>Press the  button to turn recirculate off. If it's sunny, set the Mode control at or near  and turn the air conditioning on. If it's cloudy or dark, set the Mode control at or near .</p>
<p>COOL OR COLD HUMID CONDITIONS</p> 	<p>Press the  button to turn recirculate off. If it's sunny, set the Mode control at or between  and  then turn the air conditioning on. If it's cloudy or dark, set the Mode control at or near  and turn the air conditioning on. If the windows begin to fog, set Mode control at or between  and .</p>
<p>COLD DRY CONDITIONS</p> 	<p>Set the Mode control at or near . If it is sunny, you may want more upper air. In this case, set the Mode control at or between  and . In very cold weather, if you need extra heat at the windshield, set the Mode control at or near the .</p>

045606725

STARTING AND OPERATING

CONTENTS

- Starting Procedures 293
 - Manual Transmission – If Equipped 293
 - Automatic Transmission – If Equipped 293
 - Normal Starting 293
 - Extreme Cold Weather
(Below -20°F Or -29°C) 294
 - If Engine Fails To Start 294
 - After Starting 295
- Engine Block Heater — If Equipped 295
- Manual Transmission — If Equipped 296
 - Five-Speed Manual Transmission 296
 - Recommended Shift Speeds 297
 - Downshifting 297
- Automatic Transmission — If Equipped 298
 - Automatic Transmission Ignition Interlock
System 299
 - Brake/Transmission Interlock System 300
 - Gear Ranges 300

■ AutoStick® — If Equipped	302	■ Brake System	311
□ Operation	302	□ Anti-Lock Brake System (ABS)	312
□ General Information	303	■ Electronic Brake Control System	314
■ Driving On Slippery Surfaces	303	□ Anti-Lock Brake System (ABS)	314
□ Acceleration	303	□ Brake Assist System (BAS)	314
□ Traction	304	□ Traction Control System (TCS)	315
■ Driving Through Water	304	□ Hill Start Assist (HSA) – Manual Transmission Only	316
□ Flowing/Rising Water	305	□ Electronic Stability Control (ESC)	317
□ Shallow Standing Water	305	□ ESC Activation/Malfunction Indicator Light And ESC Off Indicator Light	319
■ Power Steering	307	■ Tire Safety Information	320
□ Power Steering Fluid Check	308	□ Tire Markings	320
■ Parking Brake	308	□ Tire Identification Number (TIN)	324

□ Tire Terminology And Definitions	325	□ Tread Wear Indicators	337
□ Tire Loading And Tire Pressure	326	□ Life Of Tire	337
■ Tires — General Information	330	□ Replacement Tires	338
□ Tire Pressure	330	■ Tire Chains	339
□ Tire Inflation Pressures	331	■ Snow Tires	339
□ Tire Pressures For High Speed Operation . . .	333	■ Tire Rotation Recommendations	340
□ Radial Ply Tires	333	■ Tire Pressure Monitoring System (TPMS)	341
□ Spare Tire Matching Original Equipped Tire And Wheel – If Equipped	334	□ Base System	343
□ Compact Spare Tire – If Equipped	334	□ Premium System – If Equipped	345
□ Full Size Spare – If Equipped	335	□ General Information	349
□ Limited-Use Spare – If Equipped	335	■ Fuel Requirements	350
□ Tire Spinning	336	□ 2.0L And 2.4L Engine	350
		□ Reformulated Gasoline	350

- Gasoline/Oxygenate Blends 351
- E-85 Usage In Non-Flex Fuel Vehicles 351
- MMT In Gasoline 352
- Materials Added To Fuel 352
- Fuel System Cautions 352
- Carbon Monoxide Warnings 353
- Adding Fuel 354
 - Fuel Filler Cap (Gas Cap) 354
 - Loose Fuel Filler Cap Message 356
- Vehicle Loading 356
 - Vehicle Certification Label 356
 - Trailer Towing 358
 - Common Towing Definitions 358
 - Installing A Trailer Hitch 361
 - Trailer Hitch Classification 361
 - Trailer Towing Weights
(Maximum Trailer Weight Ratings) 362
 - Trailer And Tongue Weight 363
 - Towing Requirements 364
 - Towing Tips 369
 - Recreational Towing
(Behind Motorhome, Etc.) 370
 - Towing This Vehicle
Behind Another Vehicle 370

STARTING PROCEDURES

Before starting your vehicle, adjust your seat, adjust both inside and outside mirrors, and fasten your seat belts.

WARNING!

Never leave children alone in a vehicle. Leaving unattended children in a vehicle is dangerous for a number of reasons. A child or others could be seriously or fatally injured. Do not leave the key in the ignition. A child could operate power windows, other controls, or move the vehicle.

Manual Transmission – If Equipped

Before starting the engine fully apply the parking brake, press the clutch pedal to the floor, and place the shift lever in NEUTRAL.

NOTE:

- The engine will not start unless the clutch pedal is pressed to the floor.
- If the key will not turn and the steering wheel is locked, rotate the wheel in either direction to relieve pressure on the locking mechanism and then turn the key.

Automatic Transmission – If Equipped

The shift lever must be in the PARK or NEUTRAL position before you can start the engine. Apply the brakes before shifting to any driving gear.

NOTE: You must press the brake pedal before shifting out of PARK.

Normal Starting

Normal starting of either a cold or a warm engine does not require pumping or pressing the accelerator pedal. Simply turn the ignition switch to the START position

and release when the engine starts. If the engine fails to start within 15 seconds, turn the ignition switch to the OFF position, wait 10 to 15 seconds, then repeat the "Normal Starting" procedure.

WARNING!

Do not attempt to push or tow your vehicle to get it started. Vehicles equipped with an automatic transmission cannot be started this way. Unburned fuel could enter the catalytic converter and once the engine has started, ignite and damage the converter and vehicle. If the vehicle has a discharged battery, booster cables may be used to obtain a start from another vehicle. This type of start can be dangerous if done improperly, so follow the procedure carefully. Refer to "Jump Starting" in "What To Do In Emergencies" for further information.

Tip Start Feature

Do not press the accelerator. Turn the ignition switch to the START position and release it as soon as the starter engages. The starter motor will continue to run, and it will disengage automatically when the engine is running. If the engine fails to start, the starter will disengage automatically in 10 seconds. If this occurs, turn the ignition switch to the LOCK position, wait 10 to 15 seconds, then repeat the "Normal Starting" procedure.

Extreme Cold Weather (Below -20°F or -29°C)

To ensure reliable starting at these temperatures, use of an externally powered electric engine block heater (available from your authorized dealer) is recommended.

If Engine Fails To Start

If the engine fails to start after you have followed the "Normal Starting" or "Extreme Cold Weather" procedures, it may be flooded. Push the accelerator pedal all the way to the floor and hold it there. Crank the engine

for no more than 15 seconds. This should clear any excess fuel in case the engine is flooded. Leave the ignition key in the ON position, release the accelerator pedal and repeat the “Normal Starting” procedure.

WARNING!

Never pour fuel or other flammable liquid into the throttle body air inlet opening in an attempt to start the vehicle. This could result in flash fire causing serious personal injury.

CAUTION!

To prevent damage to the starter, do not crank the engine for more than 15 seconds at a time. Wait 10 to 15 seconds before trying again.

After Starting

The idle speed will automatically decrease as the engine warms up.

ENGINE BLOCK HEATER — IF EQUIPPED

The engine block heater warms the engine, and permits quicker starts in cold weather. Connect the cord to a standard 110-115 Volt AC electrical outlet with a grounded, three-wire extension cord.

The engine block heater must be plugged in at least one hour to have an adequate warming effect on the engine.

WARNING!

Remember to disconnect the engine block heater cord before driving. Damage to the 110-115 Volt electrical cord could cause electrocution.

MANUAL TRANSMISSION — IF EQUIPPED**Five-Speed Manual Transmission****WARNING!**

You or others could be injured if you leave the vehicle unattended without having the parking brake fully applied. The parking brake should always be applied when the driver is not in the vehicle, especially on an incline.

Fully press the clutch pedal before you shift gears. As you release the clutch pedal, lightly press the accelerator pedal.

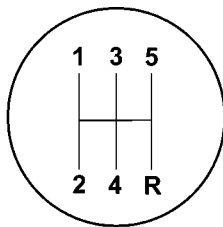

80f7bc4b

Shift Pattern

Use each gear in numerical order, do not skip a gear. Be sure the transmission is in first gear, (not third), when starting from a standing position. Damage to the clutch can result from starting in third gear.

For most city driving, you will find it easier to use only the lower gears. For steady highway driving with light accelerations, fifth gear is recommended.

Never drive with your foot resting on the clutch pedal, and never try to hold the vehicle on a hill with the clutch pedal partially engaged. This will cause abnormal wear on the clutch.

Never shift into REVERSE until the vehicle has come to a complete stop.

NOTE: During cold weather, until the transmission lubricant is warm, you may experience slightly higher shift efforts. This is normal and not harmful to the transmission.

Recommended Shift Speeds

To use your manual transmission for optimal fuel economy, it should be upshifted as listed in the following table.

Manual Transmission Recommended Shift Speeds					
Units in mph (km/h)					
Engine Size	Accel-eration Rate	1 to 2	2 to 3	3 to 4	4 to 5
All En-gines	Accel	14 (23)	23 (37)	29 (47)	45 (72)
	Cruise	12 (19)	18 (29)	25 (40)	32 (52)

Downshifting

Proper downshifting will improve fuel economy and prolong engine life.

CAUTION!

If you skip more than one gear while downshifting or downshift at too high a vehicle speed, you could damage the engine, transmission, or clutch.

To maintain a safe speed and prolong brake life, shift down to second or first gear when descending a steep grade.

When turning a corner or driving up a steep grade, downshift early so that the engine will not be overburdened.

AUTOMATIC TRANSMISSION — IF EQUIPPED

NOTE: The Continuously Variable Automatic Transmission (CVT) changes ratios in a continuous manner. This may sometimes "feel" as if it is slipping, but this is normal and does not harm anything.

CAUTION!

Damage to the transmission may occur if the following precautions are not observed:

- **Shift into PARK only after the vehicle has come to a complete stop.**
- **Shift into or out of REVERSE only after the vehicle has come to a complete stop and the engine is at idle speed.**
- **Do not shift from REVERSE, PARK, or NEUTRAL into any forward gear when the engine is above idle speed.**
- **Before shifting into any gear, make sure your foot is firmly on the brake pedal.**



Shift Lever

NOTE: You **MUST** press and hold the brake pedal down **BEFORE** shifting out of PARK.

WARNING!

It is dangerous to move the shift lever out of PARK or NEUTRAL if the engine speed is higher than idle speed. If your foot is not firmly on the brake pedal, the vehicle could accelerate quickly forward or in reverse. You could lose control of the vehicle and hit someone or something. Only shift into gear when the engine is idling normally and when your right foot is firmly on the brake pedal.

Automatic Transmission Ignition Interlock System

This system prevents the key from being removed unless the shift lever is in PARK. It also prevents shifting out of PARK unless the key is in the ON or START position, and the brake pedal is pressed.

Brake/Transmission Interlock System

Automatic transmission vehicles are equipped with a Brake Transmission Shift Interlock System (BTSI) that holds the shift lever in the PARK position when the ignition switch is in the ON or START position. To move the shift lever out of the PARK position, the ignition switch must be turned to the ON or START position (engine running or not) and the brake pedal must be pressed.

Gear Ranges

DO NOT race the engine when shifting from PARK or NEUTRAL position into another gear range.

PARK

This range supplements the parking brake by locking the transmission. The engine can be started in this range. Never use PARK while the vehicle is in motion. Apply the parking brake when leaving the vehicle in this range. Always apply the parking brake first, and then place the shift lever in the PARK position.

WARNING!

- **Unintended movement of a vehicle could injure those in and near the vehicle. As with all vehicles, you should never exit a vehicle while the engine is running. Before exiting a vehicle, you should always shift the vehicle into PARK, remove the key from the ignition, and apply the parking brake. Once the key is removed from the ignition, the shift lever is locked in the PARK position, securing the vehicle against unwanted movement. Furthermore, you should never leave unattended children inside a vehicle.**

(Continued)

WARNING! (Continued)

- Never leave children alone in a vehicle. Leaving unattended children in a vehicle is dangerous for a number of reasons. A child or others could be seriously or fatally injured. Do not leave the ignition key in the ignition switch. A child could operate power windows, other controls, or move the vehicle.

The following indicators should be used to ensure that you have engaged the shift lever into the PARK position:

- When shifting into PARK firmly move the shift lever all the way forward until it stops.
- Look at the instrument cluster to ensure it is in the PARK position.

CAUTION!

Before moving the shift lever out of PARK, you must turn the ignition from LOCK to ON so the steering wheel and shift lever are released. Otherwise, damage to the steering column or shift lever could result. You must also press the brake pedal.

REVERSE

This range is for moving the vehicle rearward. Use this range only after the vehicle has come to a complete stop.

NEUTRAL

This range is used when the vehicle is standing for prolonged periods with the engine running. The engine may be started in this range. Set the parking brake and shift the transmission into PARK if you must leave the vehicle.

DRIVE

This range is used for most city and highway driving.

AUTOSTICK® — IF EQUIPPED

AutoStick® is a driver-interactive transmission that offers six manual ratio changes to provide you with more control. AutoStick® allows you to maximize engine braking, eliminate undesirable upshifts and downshifts, and improve overall vehicle performance. This system can also provide you with more control during passing, city driving, cold slippery conditions, mountain driving, trailer towing, and many other situations. Automatic ratio changes upward will only occur to protect the Continuously Variable Automatic Transmission (CVT) and/or the engine from overspeed. Changes down will only happen at minimum engine speed to prevent stalling.

Operation

NOTE: AutoStick® is not functional until the CVT warms up in cold weather.

AutoStick® operation is activated in the DRIVE position by moving the shift lever side-to-side. Moving the shift lever to the (+) side will activate AutoStick® and shift up to the next higher manual ratio, unless you are already operating in or near Overdrive, in which case sixth gear ratio will be selected. In like manner, moving the shift lever to (-) will activate AutoStick® and shift to the next lower manual ratio. After AutoStick® is activated, the manual ratio selected is displayed in the transmission ratio display and tipping the shift lever to the (+) or (-) direction will cause an upshift or downshift by one ratio.

AutoStick® Is Deactivated:

- By holding the shift lever to (+) momentarily
- When the shift lever is shifted out of DRIVE
- When in sixth position, touching the shift lever to the right
- When heavy Anti-Lock Brake System (ABS) application is detected

General Information

- If a ratio other than first is selected and the vehicle is brought to a stop, the transmission control logic will automatically select the first gear ratio.
- If a low range is selected and the engine accelerates to the rev limit, the transmission will automatically select the next higher ratio.

- If a downshift would cause the engine to overspeed, that shift will not occur until it is safe for the engine. However, the CVT will stay in the manually selected ratio.
- If the system detects powertrain overheating, the transmission will revert to the automatic shift mode and remain in that mode until the powertrain cools off.
- If the system detects a problem, it will disable the AutoStick® mode and the transmission will return to the automatic mode until the problem is corrected.

DRIVING ON SLIPPERY SURFACES**Acceleration**

Rapid acceleration on snow covered, wet, or other slippery surfaces may cause the driving wheels to pull erratically to the right or left. This phenomenon occurs when there is a difference in the surface traction under the front (driving) wheels.

WARNING!

Rapid acceleration on slippery surfaces is dangerous. Unequal traction can cause sudden pulling of the front wheels. You could lose control of the vehicle and possibly have a collision. Accelerate slowly and carefully whenever there is likely to be poor traction (ice, snow, wet, mud, loose sand, etc.).

Traction

When driving on wet or slushy roads, it is possible for a wedge of water to build up between the tire and road surface. This is hydroplaning and may cause partial or complete loss of vehicle control and stopping ability. To reduce this possibility, the following precautions should be observed:

1. Slow down during rainstorms or when the roads are slushy.

2. Slow down if the road has standing water or puddles.
3. Replace the tires when tread wear indicators first become visible.
4. Keep tires properly inflated.
5. Maintain sufficient distance between your vehicle and the vehicle in front of you to avoid a collision in a sudden stop.

DRIVING THROUGH WATER

Driving through water more than a few inches/centimeters deep will require extra caution to ensure safety and prevent damage to your vehicle.

Flowing/Rising Water

WARNING!

Do not drive on or across a road or path where water is flowing and/or rising (as in storm run-off). Flowing water can wear away the road or path's surface and cause your vehicle to sink into deeper water. Furthermore, flowing and/or rising water can carry your vehicle away swiftly. Failure to follow this warning may result in injuries that are serious or fatal to you, your passengers, and others around you.

Shallow Standing Water

Although your vehicle is capable of driving through shallow standing water, consider the following Caution and Warning before doing so.

CAUTION!

- Always check the depth of the standing water before driving through it. Never drive through standing water that is deeper than the bottom of the tire rims mounted on the vehicle.
- Determine the condition of the road or the path that is under water and if there are any obstacles in the way before driving through the standing water.
- Do not exceed 5 mph (8 km/h) when driving through standing water. This will minimize wave effects.

(Continued)

CAUTION! (Continued)

- Driving through standing water may cause damage to your vehicle's drivetrain components. Always inspect your vehicle's fluids (i.e., engine oil, transmission, axle, etc.) for signs of contamination (i.e., fluid that is milky or foamy in appearance) after driving through standing water. Do not continue to operate the vehicle if any fluid appears contaminated, as this may result in further damage. Such damage is not covered by the New Vehicle Limited Warranty.
- Getting water inside your vehicle's engine can cause it to lock up and stall out, and cause serious internal damage to the engine. Such damage is not covered by the New Vehicle Limited Warranty.

WARNING!

- Driving through standing water limits your vehicle's traction capabilities. Do not exceed 5 mph (8 km/h) when driving through standing water.
- Driving through standing water limits your vehicle's braking capabilities, which increases stopping distances. Therefore, after driving through standing water, drive slowly and lightly press on the brake pedal several times to dry the brakes.
- Getting water inside your vehicle's engine can cause it to lock up and stall out, and leave you stranded.
- Failure to follow these warnings may result in injuries that are serious or fatal to you, your passengers, and others around you.

POWER STEERING

The standard power steering system will give you good vehicle response and increased ease of maneuverability in tight spaces. The system will provide mechanical steering capability if power assist is lost.

If for some reason the power assist is interrupted, it will still be possible to steer your vehicle. Under these conditions, you will observe a substantial increase in steering effort, especially at very low vehicle speeds and during parking maneuvers.

NOTE:

- Increased noise levels at the end of the steering wheel travel are considered normal and do not indicate that there is a problem with the power steering system.

- Upon initial start-up in cold weather, the power steering pump may make noise for a short amount of time. This is due to the cold, thick fluid in the steering system. This noise should be considered normal, and it does not in any way damage the steering system.

WARNING!

Continued operation with reduced power steering assist could pose a safety risk to yourself and others. Service should be obtained as soon as possible.

CAUTION!

Prolonged operation of the steering system at the end of the steering wheel travel will increase the steering fluid temperature and it should be avoided when possible. Damage to the power steering pump may occur.

Power Steering Fluid Check

Checking the power steering fluid level at a defined service interval is not required. The fluid should only be checked if a leak is suspected, abnormal noises are apparent, and/or the system is not functioning as anticipated. Coordinate inspection efforts through an authorized dealer.

CAUTION!

Do not use chemical flushes in your power steering system as the chemicals can damage your power steering components. Such damage is not covered by the New Vehicle Limited Warranty.

WARNING!

Fluid level should be checked on a level surface and with the engine off to prevent injury from moving parts and to ensure accurate fluid level reading. Do not overfill. Use only manufacturer's recommended power steering fluid.

If necessary, add fluid to restore to the proper indicated level. With a clean cloth, wipe any spilled fluid from all surfaces. Refer to "Fluids, Lubricants, and Genuine Parts" in "Maintaining Your Vehicle" for further information.

PARKING BRAKE

Before leaving the vehicle, make sure that the parking brake is fully applied. Also, be certain to leave an automatic transmission in PARK, or manual transmission in REVERSE or first gear.

The parking brake lever is located in the center console. To apply the parking brake, pull the lever up as firmly as possible. To release the parking brake, pull the lever up slightly, press the center button, then lower the lever completely.

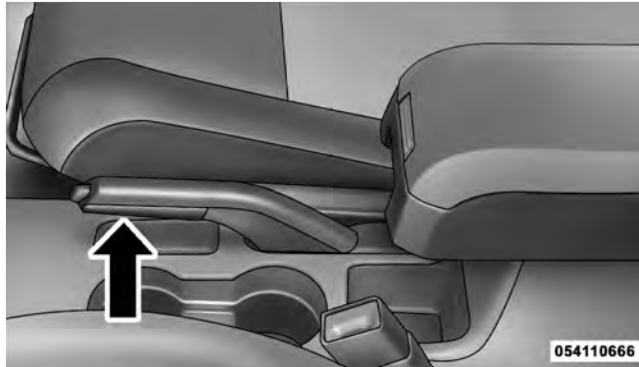

Parking Brake

When the parking brake is applied with the ignition switch in the ON position, the “Brake Warning Light” in the instrument cluster will illuminate.

NOTE:

- When the parking brake is applied and the automatic transmission is placed in gear, the “Brake Warning Light” will flash. If vehicle speed is detected, a chime will sound to alert the driver. Fully release the parking brake before attempting to move the vehicle.
- This light only shows that the parking brake is applied. It does not show the degree of brake application.

When parking on a hill, it is important to turn the front wheels toward the curb on a downhill grade and away from the curb on an uphill grade. For vehicles equipped with an automatic transmission, apply the parking brake before placing the shift lever in PARK, otherwise the load on the transmission locking mechanism may make it

difficult to move the shift lever out of PARK. The parking brake should always be applied whenever the driver is not in the vehicle.

WARNING!

- Never leave children alone in a vehicle. Leaving unattended children in a vehicle is dangerous for a number of reasons. A child or others could be seriously or fatally injured.
- Do not leave the key in the ignition switch. A child could operate power windows, other controls, or move the vehicle.
- Be sure the parking brake is fully disengaged before driving; failure to do so can lead to brake failure and a collision.

(Continued)

WARNING! (Continued)

- Always fully apply the parking brake when leaving your vehicle or it may roll and cause damage or injury. Also, be certain to leave an automatic transmission in PARK, a manual transmission in REVERSE or first gear. Failure to do so may cause the vehicle to roll and cause damage or injury.

CAUTION!

If the "Brake Warning Light" remains on with the parking brake released, a brake system malfunction is indicated. Have the brake system serviced by an authorized dealer immediately.

BRAKE SYSTEM

Your vehicle is equipped with power assisted brakes as standard equipment. In the event power assist is lost for any reason (for example, repeated brake applications with the engine off), the brakes will still function. However, the effort required to brake the vehicle will be much greater than that required with the power system operating.

WARNING!

Riding the brakes can lead to brake failure and possibly a collision. Driving with your foot resting or riding on the brake pedal can result in abnormally high brake temperatures, excessive lining wear, and possible brake damage. You would not have your full braking capacity in an emergency.

If either of the two hydraulic systems lose normal capability, the remaining system will still function with some loss of overall braking effectiveness. This will be evident by increased pedal travel during application and greater pedal force required to slow or stop. In addition, if the malfunction is caused by an internal leak, as the brake fluid in the master cylinder drops, the “Brake Warning Light” will light.

WARNING!

Driving a vehicle with the “Brake Warning Light” on is dangerous. A significant decrease in braking performance or vehicle stability during braking may occur. It will take you longer to stop the vehicle or will make your vehicle harder to control. You could have a collision. Have the vehicle checked immediately.

Anti-Lock Brake System (ABS)

The ABS provides increased vehicle stability and brake performance under most braking conditions. The system automatically “pumps” the brakes during severe braking conditions to prevent wheel lock-up.

WARNING!

- Pumping of the anti-lock brakes will diminish their effectiveness and may lead to a collision. Pumping makes the stopping distance longer. Just press firmly on your brake pedal when you need to slow down or stop.
- The ABS cannot prevent the natural laws of physics from acting on the vehicle, nor can it increase braking or steering efficiency beyond that afforded by the condition of the vehicle brakes and tires or the traction afforded.

(Continued)

WARNING! (Continued)

- The ABS cannot prevent collisions, including those resulting from excessive speed in turns, following another vehicle too closely, or hydroplaning.
- The capabilities of an ABS-equipped vehicle must never be exploited in a reckless or dangerous manner which could jeopardize the user’s safety or the safety of others.



The “ABS Warning Light” monitors the ABS System. The light will come on when the ignition switch is turned to the ON position and may stay on for as long as four seconds.

If the “ABS Warning Light” remains on or comes on while driving, it indicates that the anti-lock portion of the brake system is not functioning and that service is

required. However, the conventional brake system will continue to operate normally if the “Brake Warning Light” is not on.

If the “ABS Warning Light” is on, the brake system should be serviced as soon as possible to restore the benefits of anti-lock brakes. If the “ABS Warning Light” does not come on when the ignition switch is turned to the ON position, have the bulb repaired as soon as possible.

If both the “Brake Warning Light” and the “ABS Warning Light” remain on, the ABS and Electronic Brake Force Distribution (EBD) systems are not functioning. Immediate repair to the ABS is required.

When the vehicle is driven over 7 mph (11 km/h), you may also hear a slight clicking sound as well as some related motor noises. These noises are the system performing its self-check cycle to ensure that the ABS

working properly. This self-check occurs each time the vehicle is started and accelerated past 7 mph (11 km/h).

ABS is activated during braking under certain road or stopping conditions. ABS-inducing conditions can include ice, snow, gravel, bumps, railroad tracks, loose debris, or panic stops.

You may also experience the following when the brake system goes into anti-lock mode:

- the ABS motor running (it may continue to run for a short time after the stop)
- the clicking sound of solenoid valves
- brake pedal pulsations
- a slight drop or fall away of the brake pedal at the end of the stop

These are all normal characteristics of ABS.

WARNING!

The Anti-Lock Brake System (ABS) contains sophisticated electronic equipment that may be susceptible to interference caused by improperly installed or high output radio transmitting equipment. This interference can cause possible loss of Anti-Lock braking capability. Installation of such equipment should be performed by qualified professionals.

All vehicle wheels and tires must be the same size and type and tires must be properly inflated to produce accurate signals for the computer.

ELECTRONIC BRAKE CONTROL SYSTEM

Your vehicle may be equipped with an optional advanced electronic brake control system that includes Anti-Lock Brake System (ABS), Brake Assist System (BAS), Traction Control System (TCS), Hill Start Assist

(HSA), and Electronic Stability Control (ESC). All systems work together to enhance vehicle stability and control in various driving conditions and are commonly referred to as ESC.

Anti-Lock Brake System (ABS)

This system aids the driver in maintaining vehicle control under adverse braking conditions. The system controls hydraulic brake pressure to prevent wheel lockup and help avoid skidding on slippery surfaces during braking. Refer to “Anti-Lock Brake System” in “Starting and Operating” for further information.

Brake Assist System (BAS)

The BAS is designed to optimize the vehicle’s braking capability during emergency braking maneuvers. The system detects an emergency braking situation by sensing the rate and amount of brake application and then applies optimum pressure to the brakes. This can help reduce braking distances. The BAS complements the

Anti-Lock Brake System (ABS). Applying the brakes very quickly results in the best BAS assistance. To receive the benefit of the system, you must apply **continuous** braking pressure during the stopping sequence (do not “pump” the brakes). Do not reduce brake pedal pressure unless braking is no longer desired. Once the brake pedal is released, the BAS is deactivated.

WARNING!

- **The Brake Assist System (BAS) cannot prevent the natural laws of physics from acting on the vehicle, nor can it increase the traction afforded by prevailing road conditions.**
- **The BAS cannot prevent collisions, including those resulting from excessive speed in turns, driving on very slippery surfaces, or hydroplaning.**

(Continued)

WARNING! (Continued)

- **The capabilities of a BAS-equipped vehicle must never be exploited in a reckless or dangerous manner which could jeopardize the user’s safety or the safety of others.**

Traction Control System (TCS)

This system monitors the amount of wheel spin of each of the driven wheels. If wheel spin is detected, brake pressure is applied to the slipping wheel(s) and engine power is reduced to provide enhanced acceleration and stability. A feature of the TCS system functions similar to a limited slip differential and controls the wheel spin across a driven axle. If one wheel on a driven axle is spinning faster than the other, the system will apply the brake of the spinning wheel. This will allow more engine torque to be applied to the wheel that is not spinning. This feature remains active even if TCS and ESC are in

the “Partial Off” mode. Refer to “Electronic Stability Control (ESC)” in this section for further information.

Hill Start Assist (HSA) – Manual Transmission Only

The HSA system is designed to assist the driver when starting a vehicle from a stop on a hill. HSA will maintain the level of brake pressure the driver applied for a short period of time after the driver takes their foot off of the brake pedal. If the driver does not apply the throttle during this short period of time, the system will release brake pressure and the vehicle will roll down the hill. The system will release brake pressure in proportion to amount of throttle applied as the vehicle starts to move in the intended direction of travel.

HSA Activation Criteria

The following criteria must be met in order for HSA to activate:

- Vehicle must be stopped.

- Vehicle must be on a 7% grade or greater hill.
- Gear selection matches vehicle uphill direction (i.e., vehicle facing uphill is in forward gear; vehicle backing uphill is in REVERSE gear).

WARNING!

There may be situations on minor hills (i.e., less than 8%), with a loaded vehicle, or while pulling a trailer, when the system will not activate and slight rolling may occur. This could cause a collision with another vehicle or object. Always remember the driver is responsible for braking the vehicle.

Disabling/Enabling HSA

If you wish to turn on or off the HSA system, it can be done using the Customer Programmable Features in the Electronic Vehicle Information Center (EVIC). Refer to

“Electronic Vehicle Information Center (EVIC)” in “Understanding Your Instrument Panel” for further information.

For vehicles not equipped with the EVIC, perform the following steps:

NOTE: You must complete Steps 1 through 8 within 90 seconds.

1. Center the steering wheel (front wheels pointing straight forward).
2. Shift the transmission into NEUTRAL.
3. Apply the parking brake.
4. Start the engine.
5. Release the clutch pedal.
6. Rotate the steering wheel one-half turn to the left.

7. Press the “ESC Off” switch (located in the lower switch bank below the climate controls) four times within 20 seconds. The “ESC Off Indicator Light” should turn on and turn off two times.

8. Rotate the steering wheel back to center and then an additional half-turn to the right.

9. Turn the ignition switch to the OFF position and then back to the ON position. If the sequence was completed properly, the “ESC Off Indicator Light” will blink several times to confirm HSA is disabled.

10. Repeat these steps if you want to return this feature to its previous setting.

Electronic Stability Control (ESC)

This system enhances directional control and stability of the vehicle under various driving conditions. ESC corrects for over-steering or under-steering of the vehicle by applying the brake of the appropriate wheel to assist in

counteracting the over-steering or under-steering condition. Engine power may also be reduced to help the vehicle maintain the desired path. ESC uses sensors in the vehicle to determine the vehicle path intended by the driver and compares it to the actual path of the vehicle. When the actual path does not match the intended path, ESC applies the brake of the appropriate wheel to assist in counteracting the over-steer or under-steer condition.

- Over-steer - when the vehicle is turning more than appropriate for the steering wheel position.
- Under-steer - when the vehicle is turning less than appropriate for the steering wheel position.

ESC Operating Modes

The ESC system has two available operating modes.

Full On

This is the normal operating mode for ESC. Whenever the vehicle is started the ESC system will be in this “On”

mode. This mode should be used for most driving situations. ESC should only be turned to “Partial Off” for specific reasons as noted below.

Partial Off

This mode is entered by momentarily pressing the “ESC Off” switch. This mode is intended to be used if the vehicle is in deep snow, sand or gravel conditions and more wheel spin than ESC would normally allow is required to gain traction.

To turn ESC on again, momentarily press the “ESC Off” switch. This will restore the normal “ESC On” mode of operation.

NOTE: To improve the vehicle’s traction when driving with snow chains, or starting off in deep snow, sand or gravel, it may be desirable to switch to the “Partial Off” mode by pressing the “ESC Off” switch. Once the situation requiring ESC to be switched to the “Partial Off”

mode is overcome, turn ESC back on by momentarily pressing the “ESC Off” switch. This may be done while the vehicle is in motion.

WARNING!

The Electronic Stability Control (ESC) cannot prevent the natural laws of physics from acting on the vehicle, nor can it increase the traction afforded by prevailing road conditions. ESC cannot prevent accidents, including those resulting from excessive speed in turns, driving on very slippery surfaces, or hydroplaning. Only a safe, attentive, and skillful driver can prevent accidents. The capabilities of an ESC equipped vehicle must never be exploited in a reckless or dangerous manner which could jeopardize the user’s safety or the safety of others.

ESC Activation/Malfunction Indicator Light and ESC OFF Indicator Light



The “ESC Activation/Malfunction Indicator Light” in the instrument cluster will come on when the ignition switch is turned to the ON position. It should go out with the engine running. If the “ESC Activation/Malfunction Indicator Light” comes on continuously with the engine running, a malfunction has been detected in the ESC system. If this light remains on after several ignition cycles, and the vehicle has been driven several miles (kilometers) at speeds greater than 30 mph (48 km/h), see your authorized dealer as soon as possible to have the problem diagnosed and corrected.

The “ESC Activation/Malfunction Indicator Light” (located in the instrument cluster) starts to flash as soon as the tires lose traction and the ESC system becomes active. The “ESC Activation/Malfunction Indicator Light” also flashes when TCS is active. If the “ESC Activation/

Malfunction Indicator Light” begins to flash during acceleration, ease up on the accelerator and apply as little throttle as possible. Be sure to adapt your speed and driving to the prevailing road conditions.

NOTE:

- The “ESC Activation/Malfunction Indicator Light” and the “ESC OFF Indicator Light” come on momentarily each time the ignition switch is turned ON.
- Each time the ignition is turned ON, the ESC system will be ON even if it was turned off previously.
- The ESC system will make buzzing or clicking sounds when it is active. This is normal; the sounds will stop when ESC becomes inactive following the maneuver that caused the ESC activation.



The “ESC OFF Indicator Light” indicates the Electronic Stability Control (ESC) is off.

TIRE SAFETY INFORMATION

Tire Markings

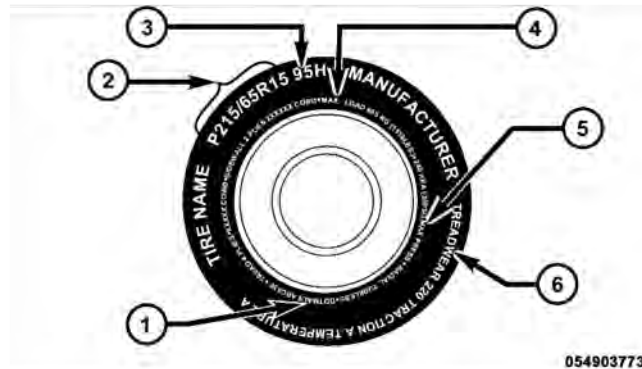

054903773

- 1 — U.S. DOT Safety Standards Code (TIN)
 2 — Size Designation
 3 — Service Description

- 4 — Maximum Load
 5 — Maximum Pressure
 6 — Treadwear, Traction and Temperature Grades

NOTE:

- P (Passenger) - Metric tire sizing is based on U.S. design standards. P-Metric tires have the letter "P" molded into the sidewall preceding the size designation. Example: P215/65R15 95H.
- European-Metric tire sizing is based on European design standards. Tires designed to this standard have the tire size molded into the sidewall beginning with the section width. The letter "P" is absent from this tire size designation. Example: 215/65R15 96H.
- LT (Light Truck) - Metric tire sizing is based on U.S. design standards. The size designation for LT-Metric tires is the same as for P-Metric tires except for the letters "LT" that are molded into the sidewall preceding the size designation. Example: LT235/85R16.
- Temporary spare tires are high-pressure compact spares designed for temporary emergency use only. Tires designed to this standard have the letter "T" molded into the sidewall preceding the size designation. Example: T145/80D18 103M.
- High flotation tire sizing is based on U.S. design standards and it begins with the tire diameter molded into the sidewall. Example: 31x10.5 R15 LT.

Tire Sizing Chart

EXAMPLE:	
Size Designation:	
P	= Passenger car tire size based on U.S. design standards
"...blank..."	= Passenger car tire based on European design standards
LT	= Light truck tire based on U.S. design standards
T	= Temporary spare tire
31	= Overall diameter in inches (in)
215	= Section width in millimeters (mm)
65	= Aspect ratio in percent (%) — Ratio of section height to section width of tire
10.5	= Section width in inches (in)
R	= Construction code — "R" means radial construction — "D" means diagonal or bias construction
15	= Rim diameter in inches (in)

EXAMPLE:**Service Description:**

95 = Load Index

— A numerical code associated with the maximum load a tire can carry

H = Speed Symbol

— A symbol indicating the range of speeds at which a tire can carry a load corresponding to its load index under certain operating conditions

— The maximum speed corresponding to the speed symbol should only be achieved under specified operating conditions (i.e., tire pressure, vehicle loading, road conditions, and posted speed limits)

Load Identification:

"...**blank**..." = Absence of any text on the sidewall of the tire indicates a Standard Load (SL) tire

Extra Load (XL) = Extra load (or reinforced) tire

Light Load = Light load tire

C, D, E = Load range associated with the maximum load a tire can carry at a specified pressure

Maximum Load — Maximum load indicates the maximum load this tire is designed to carry

Maximum Pressure — Maximum pressure indicates the maximum permissible cold tire inflation pressure for this tire

Tire Identification Number (TIN)

The TIN may be found on one or both sides of the tire, however, the date code may only be on one side. Tires with white sidewalls will have the full TIN, including the date code, located on the white sidewall side of the tire.

Look for the TIN on the outboard side of black sidewall tires as mounted on the vehicle. If the TIN is not found on the outboard side, then you will find it on the inboard side of the tire.

EXAMPLE:**DOT MA L9 ABCD 0301**

DOT = Department of Transportation

— This symbol certifies that the tire is in compliance with the U.S. Department of Transportation tire safety standards and is approved for highway use

MA = Code representing the tire manufacturing location (two digits)

L9 = Code representing the tire size (two digits)

ABCD = Code used by the tire manufacturer (one to four digits)

03 = Number representing the week in which the tire was manufactured (two digits)

—03 means the 3rd week.

01 = Number representing the year in which the tire was manufactured (two digits)

—01 means the year 2001

— Prior to July 2000, tire manufacturers were only required to have one number to represent the year in which the tire was manufactured. Example: 031 could represent the 3rd week of 1981 or 1991

Tire Terminology And Definitions

Term	Definition
B-Pillar	The vehicle B-Pillar is a structural member of the body located between the front and rear door (of a four-door vehicle) running from the sill to the roof.
Cold Tire Pressure	Cold tire inflation pressure is defined as the tire pressure after the vehicle has not been driven for at least 3 hours, or driven less than 1 mile (1.6 km) after sitting for a three hour period. Inflation pressure is measured in units of PSI (pounds per square inch) or KPa (kilopascals).
Maximum Inflation Pressure	The maximum inflation pressure is the maximum permissible cold tire inflation pressure for this tire. The max inflation pressure is molded into the sidewall.
Recommended Inflation Pressure	Vehicle manufacturer's recommended tire inflation pressure as shown on the tire placard.
Tire Placard	A paper label permanently attached to the vehicle showing the vehicle's loading capacity, the original equipment tire size and the recommended inflation pressure.

Tire Loading And Tire Pressure

Tire Placard Location

NOTE: The proper cold tire inflation pressure is listed on the driver's side B-Pillar.

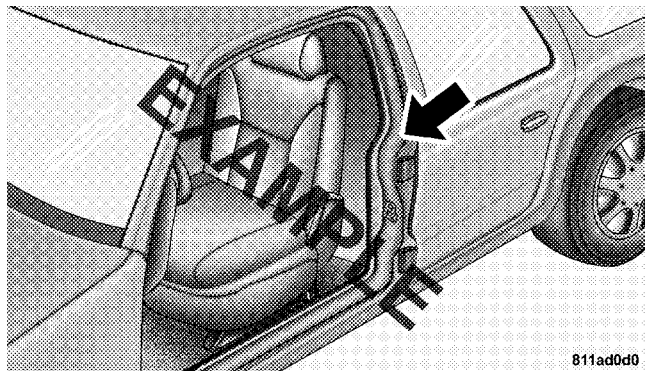

Tire Placard Location

Tire And Loading Information Placard

TIRE AND LOADING INFORMATION

SEATING CAPACITY - TOTAL 5 FRONT 2 REAR 3

THE COMBINED WEIGHT OF OCCUPANTS AND CARGO SHOULD NEVER EXCEED XXX KG OR XXX LBS.

TIRE	FRONT	REAR	SPARE
ORIGINAL TIRE SIZE	P195/70R14	P195/70R14	T125/70D15
COLD TIRE INFLATION PRESSURE	200kPa, 29PSI	200kPa, 29PSI	420kPa, 60PSI

SEE OWNER'S MANUAL FOR ADDITIONAL INFORMATION

4N109268

811b5a9a

Tire and Loading Information Placard

This placard tells you important information about the:

- 1) number of people that can be carried in the vehicle
- 2) total weight your vehicle can carry
- 3) tire size designed for your vehicle
- 4) cold tire inflation pressures for the front, rear, and spare tires.

Loading

The vehicle maximum load on the tire must not exceed the load carrying capacity of the tire on your vehicle. You will not exceed the tire's load carrying capacity if you adhere to the loading conditions, tire size, and cold tire inflation pressures specified on the Tire and Loading Information placard and in the "Vehicle Loading" section of this manual.

NOTE: Under a maximum loaded vehicle condition, gross axle weight ratings (GAWRs) for the front and rear

axles must not be exceeded. For further information on GAWRs, vehicle loading, and trailer towing, refer to "Vehicle Loading" in this section.

To determine the maximum loading conditions of your vehicle, locate the statement "The combined weight of occupants and cargo should never exceed XXX lbs or XXX kg" on the Tire and Loading Information placard. The combined weight of occupants, cargo/luggage and trailer tongue weight (if applicable) should never exceed the weight referenced here.

Steps For Determining Correct Load Limit

1. Locate the statement "The combined weight of occupants and cargo should never exceed XXX lbs or XXX kg" on your vehicle's placard.
2. Determine the combined weight of the driver and passengers that will be riding in your vehicle.

3. Subtract the combined weight of the driver and passengers from XXX lbs or XXX kg.
4. The resulting figure equals the available amount of cargo and luggage load capacity. For example, if “XXX” amount equals 1,400 lbs (635 kg) and there will be five 150 lb (68 kg) passengers in your vehicle, the amount of available cargo and luggage load capacity is 650 lbs (295 kg) (since $5 \times 150 = 750$, and $1400 - 750 = 650$ lbs [295 kg]).
5. Determine the combined weight of luggage and cargo being loaded on the vehicle. That weight may not safely exceed the available cargo and luggage load capacity calculated in Step 4.
6. If your vehicle will be towing a trailer, load from your trailer will be transferred to your vehicle. Consult this manual to determine how this reduces the available cargo and luggage load capacity of your vehicle.

NOTE:

- The following table shows examples on how to calculate total load, cargo/luggage, and towing capacities of your vehicle with varying seating configurations and number and size of occupants. This table is for illustration purposes only and may not be accurate for the seating and load carry capacity of your vehicle.
- For the following example, the combined weight of occupants and cargo should never exceed 865 lbs (392 kg).

Occupants			Combined weight of occupants and cargo from Tire Placard	MINUS	Combined Occupant's weight	=	AVAILABLE Cargo/Luggage and Trailer Tongue Weight
TOTAL	FRONT	REAR					
<u>EXAMPLE 1</u>			↓ 865 lbs	minus	Occupant 1: 200 lbs Occupant 2: 130 lbs Occupant 3: 160 lbs Occupant 4: 100 lbs Occupant 5: 80 lbs TOTAL WEIGHT: 670 lbs	=	↓ 195 lbs
5	2	3					
<u>EXAMPLE 2</u>			865 lbs	minus	Occupant 1: 210 lbs Occupant 2: 180 lbs Occupant 3: 150 lbs TOTAL WEIGHT: 540 lbs	=	325 lbs
3	2	1					
<u>EXAMPLE 3</u>			865 lbs	minus	Occupant 1: 200 lbs Occupant 2: 200 lbs TOTAL WEIGHT: 400 lbs	=	465 lbs
2	2	0					

WARNING!

Overloading of your tires is dangerous. Overloading can cause tire failure, affect vehicle handling, and increase your stopping distance. Use tires of the recommended load capacity for your vehicle. Never overload them.

TIRES — GENERAL INFORMATION**Tire Pressure**

Proper tire inflation pressure is essential to the safe and satisfactory operation of your vehicle. Three primary areas are affected by improper tire pressure:

Safety**WARNING!**

- Improperly inflated tires are dangerous and can cause collisions.
- Under-inflation increases tire flexing and can result in tire over-heating and failure.
- Over-inflation reduces a tire's ability to cushion shock. Objects on the road and chuckholes can cause damage that result in tire failure.
- Unequal tire pressures can cause steering problems. You could lose control of your vehicle.
- Over-inflated or under-inflated tires can affect vehicle handling and can fail suddenly, resulting in loss of vehicle control.

(Continued)

WARNING! (Continued)

- Unequal tire pressures from one side of the vehicle to the other can cause the vehicle to drift to the right or left.
- Always drive with each tire inflated to the recommended cold tire inflation pressure.

Economy

Improper inflation pressures can cause uneven wear patterns to develop across the tire tread. These abnormal wear patterns will reduce tread life resulting in a need for earlier tire replacement. Under-inflation also increases tire rolling resistance and results in higher fuel consumption.

Ride Comfort and Vehicle Stability

Proper tire inflation contributes to a comfortable ride. Over-inflation produces a jarring and uncomfortable ride.

Tire Inflation Pressures

The proper cold tire inflation pressure is listed on the driver's side "B" Pillar.

Some vehicles may have Supplemental Tire Pressure Information for vehicle loads that are less than the maximum loaded vehicle condition. These pressure conditions will be found in the "Supplemental Tire Pressure Information" section of this manual.

The pressure should be checked and adjusted as well as inspecting for signs of tire wear or visible damage at least once a month. Use a good quality pocket-type gauge to check tire pressure. Do not make a visual judgement when determining proper inflation. Radial tires may look properly inflated even when they are under-inflated.

CAUTION!

After inspecting or adjusting the tire pressure, always reinstall the valve stem cap. This will prevent moisture and dirt from entering the valve stem, which could damage the valve stem.

Inflation pressures specified on the placard are always “cold tire inflation pressure.” Cold tire inflation pressure is defined as the tire pressure after the vehicle has not been driven for at least three hours or driven less than 1 mile (1.6 km) after a three hour period. The cold tire inflation pressure must not exceed the maximum inflation pressure molded into the tire sidewall.

Check tire pressures more often if subject to a wide range of outdoor temperatures as tire pressures vary with temperature changes.

Tire pressures change by approximately 1 psi (7 kPa) per 12°F (7°C) of air temperature change. Keep this in mind when checking tire pressure inside a garage, especially in the Winter.

Example: If garage temperature = 68°F (20°C) and the outside temperature = 32°F (0°C) then the cold tire inflation pressure should be increased by 3 psi (21 kPa), which equals 1 psi (7 kPa) for every 12°F (7°C) for this outside temperature condition.

Tire pressure may increase from 2 to 6 psi (13 to 40 kPa) during operation. Do not reduce this normal pressure build up or your tire pressure will be too low.

Tire Pressures For High Speed Operation

The manufacturer advocates driving at safe speeds within posted speed limits. Where speed limits or conditions are such that the vehicle can be driven at high speeds, maintaining correct tire inflation pressure is very important. Increased tire pressure and reduced vehicle loading may be required for high-speed vehicle operation. Refer to original equipment or an authorized tire dealer for recommended safe operating speeds, loading and cold tire inflation pressures.

WARNING!

High speed driving with your vehicle under maximum load is dangerous. The added strain on your tires could cause them to fail. You could have a serious collision. Do not drive a vehicle loaded to the maximum capacity at continuous speeds above 75 mph (120 km/h).

Radial Ply Tires

WARNING!

Combining radial ply tires with other types of tires on your vehicle will cause your vehicle to handle poorly. The instability could cause a collision. Always use radial ply tires in sets of four. Never combine them with other types of tires.

Cuts and punctures in radial tires are repairable only in the tread area because of sidewall flexing. Consult your authorized tire dealer for radial tire repairs.

Spare Tire Matching Original Equipped Tire and Wheel – If Equipped

The spare tire of your vehicle is equivalent in look and function as the original equipment tire and wheel found on the front or rear axle of your vehicle. This spare tire may be used in the tire rotation for your vehicle. If your vehicle has an option for a spare tire matching original equipment tire and wheel, refer to the recommended tire rotation pattern in “Tire Rotation Recommendations” in “Starting and Operating” for further information.

If your vehicle is not equipped with an original equipment tire and wheel as a spare, a non-matching temporary emergency use spare may be equipped with your vehicle. Temporary use spares are engineered to be used only with your vehicle. Your vehicle may be equipped with one of the following types of non-matching temporary use spares; compact, full size, or limited-use.

Do not install more than one non-matching temporary use spare tire/wheel on the vehicle at any given time.

CAUTION!

Because of the reduced ground clearance, do not take your vehicle through an automatic car wash with a compact, full size or limited-use temporary spare installed. Damage to the vehicle may result.

Compact Spare Tire – If Equipped

The compact spare is for temporary emergency use only. You can identify if your vehicle is equipped with a compact spare by looking at the spare tire description on the Tire and Loading Information Placard located on the driver’s side door opening or on the sidewall of the tire. Compact spare tire descriptions begin with the letter “T” or “S” preceding the size designation. Example: T145/80D18 103M.

T, S = Temporary Spare Tire

Since this tire has limited tread life the original equipment tire should be repaired (or replaced) and reinstalled on your vehicle at the first opportunity.

Do not install a wheel cover or attempt to mount a conventional tire on the compact spare wheel, since the wheel is designed specifically for the compact spare. Do not install more than one compact spare tire/wheel on the vehicle at any given time

WARNING!

Compact spares are for temporary emergency use only. With these spares, do not drive more than 50 mph (80 km/h). Temporary use spares have limited tread life. When the tread is worn to the tread wear indicators, the temporary use spare tire needs to be replaced. Be sure to follow the warnings, which apply to your spare. Failure to do so could result in spare tire failure and loss of vehicle control.

Full Size Spare – If Equipped

The full size spare is for temporary emergency use only. This tire may look like the original equipped tire on the front or rear axle of your vehicle, but it is not. This spare tire may have limited tread life. When the tread is worn to the tread wear indicators, the temporary use full size spare tire needs to be replaced. Since it is not the same as your original equipment tire, replace (or repair) the original equipment tire and reinstall on the vehicle at the first opportunity.

Limited-Use Spare – If Equipped

The limited-use spare tire is for temporary emergency use only. This tire is identified by a label located on the limited-use spare wheel. This label contains the driving limitations for this spare. This tire may look like the original equipped tire on the front or rear axle of your vehicle, but it is not. Installation of this limited-use spare tire affects vehicle handling. Since it is not the same as

your original equipment tire, replace (or repair) the original equipment tire and reinstall on the vehicle at the first opportunity.

WARNING!

Limited-use spares are for emergency use only. Installation of this limited-use spare tire affects vehicle handling. With this tire, do not drive more than the speed listed on the limit-use spare wheel. Keep inflated to the cold tire inflation pressure listed on your Tire and Loading Information Placard located on the driver's side door opening. Replace (or repair) the original equipment tire at the first opportunity and reinstall it on your vehicle. Failure to do so could result in loss of vehicle control.

Tire Spinning

When stuck in mud, sand, snow, or ice conditions, do not spin your vehicle's wheels faster than 30 mph (48 km/h) or for longer than 30 seconds continuously without stopping when you are stuck.

Refer to "Freeing A Stuck Vehicle" in "What To Do In Emergencies" for further information.

WARNING!

Fast spinning tires can be dangerous. Forces generated by excessive wheel speeds may cause tire damage or failure. A tire could explode and injure someone. Do not spin your vehicle's wheels faster than 30 mph (48 km/h) or for more than 30 seconds continuously when you are stuck, and do not let anyone near a spinning wheel, no matter what the speed.

Tread Wear Indicators

Tread wear indicators are in the original equipment tires to help you in determining when your tires should be replaced.

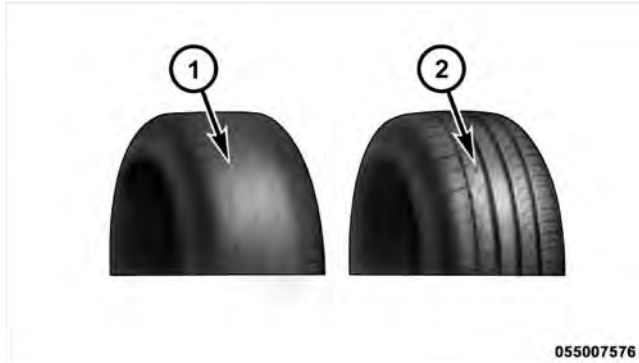

- 1 — Worn Tire
2 — New Tire

These indicators are molded into the bottom of the tread grooves. They will appear as bands when the tread depth becomes 1/16 in (2 mm). When the tread is worn to the tread wear indicators, the tire should be replaced.

Life Of Tire

The service life of a tire is dependent upon varying factors including, but not limited to:

- Driving style
- Tire pressure
- Distance driven

WARNING!

Tires and the spare tire should be replaced after six years, regardless of the remaining tread. Failure to follow this warning can result in sudden tire failure. You could lose control and have a collision resulting in serious injury or death.

Keep dismounted tires in a cool, dry place with as little exposure to light as possible. Protect tires from contact with oil, grease, and gasoline.

Replacement Tires

The tires on your new vehicle provide a balance of many characteristics. They should be inspected regularly for wear and correct cold tire inflation pressure. The manufacturer strongly recommends that you use tires equivalent to the originals in size, quality and performance when replacement is needed. (Refer to the paragraph on "Tread Wear Indicators"). Refer to the "Tire and Loading Information" placard for the size designation of your tire. The service description and load identification will be found on the original equipment tire. Failure to use equivalent replacement tires may adversely affect the safety, handling, and ride of your vehicle. We recommend that you contact your original equipment or an authorized tire dealer with any questions you may have on tire specifications or capability.

WARNING!

- Do not use a tire, wheel size or rating other than that specified for your vehicle. Some combinations of unapproved tires and wheels may change suspension dimensions and performance characteristics, resulting in changes to steering, handling, and braking of your vehicle. This can cause unpredictable handling and stress to steering and suspension components. You could lose control and have a collision resulting in serious injury or death. Use only the tire and wheel sizes with load ratings approved for your vehicle.
- Never use a tire with a smaller load index or capacity other than what was originally equipped on your vehicle. Using a tire with a smaller load index could result in tire overloading and failure. You could lose control and have a collision.

(Continued)

WARNING! (Continued)

- Failure to equip your vehicle with tires having adequate speed capability can result in sudden tire failure and loss of vehicle control.

CAUTION!

Replacing original tires with tires of a different size may result in false speedometer and odometer readings.

TIRE CHAINS

Due to limited clearance, tire chains are not recommended.

CAUTION!

Damage to the vehicle may result if tire chains are used.

SNOW TIRES

Some areas of the country require the use of snow tires during the winter. All season tires can be identified by the M+S designation on the tire sidewall.

If you need snow tires, select tires equivalent in size and type to the original equipment tires. Use snow tires only in sets of four; failure to do so may adversely affect the safety and handling of your vehicle.

Snow tires generally have lower speed ratings than what was originally equipped with your vehicle and should not be operated at sustained speeds over 75 mph (120 km/h). For speeds above 75 mph (120 km/h) refer to original equipment or an authorized tire dealer for recommended safe operating speeds, loading and cold tire inflation pressures.

While studded tires improve performance on ice, skid and traction capability on wet or dry surfaces may be

poorer than that of non-studded tires. Some states prohibit studded tires; therefore, local laws should be checked before using these tire types.

TIRE ROTATION RECOMMENDATIONS

The tires on the front and rear of your vehicle operate at different loads and perform different steering, driving, and braking functions. For these reasons, they wear at unequal rates.

These effects can be reduced by timely rotation of tires. The benefits of rotation are especially worthwhile with aggressive tread designs such as those on all season type tires. Rotation will increase tread life, help to maintain mud, snow and wet traction levels, and contribute to a smooth, quiet ride.

Refer to the "Maintenance Schedule" for the proper maintenance intervals. The reasons for any rapid or unusual wear should be corrected prior to rotation being performed.

The suggested rotation method is the "rearward cross" shown in the following diagram. This rotation pattern does not apply to some directional tires that must not be reversed.

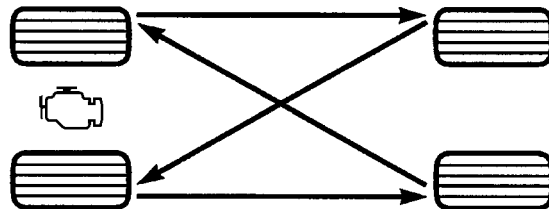

Tire Rotation

TIRE PRESSURE MONITORING SYSTEM (TPMS)

The Tire Pressure Monitor System (TPMS) will warn the driver of a low tire pressure based on the vehicle recommended cold placard pressure.

The tire pressure will vary with temperature by about 1 psi (6.9 kPa) for every 12°F (6.5°C). This means that when the outside temperature decreases, the tire pressure will decrease. Tire pressure should always be set based on “cold inflation tire pressure”. This is defined as the tire pressure after the vehicle has not been driven for at least three hours, or driven less than 1 mile (1.6 km) after a three hour period. The cold tire inflation pressure must not exceed the maximum inflation pressure molded into the tire sidewall. Refer to “Tires – General Information” in “Starting and Operating” for information on how to properly inflate the vehicle’s tires. The tire pressure will also increase as the vehicle is driven - this is normal and there should be no adjustment for this increased pressure.

The TPMS will warn the driver of a low tire pressure if the tire pressure falls below the low-pressure warning limit for any reason, including low temperature effects, or natural pressure loss through the tire.

The TPMS will continue to warn the driver of low tire pressure as long as the condition exists, and will not turn off until the tire pressure is at or above the recommended cold placard pressure. Once the low tire pressure warning (Tire Pressure Monitoring Telltale Light) illuminates, you must increase the tire pressure to the recommended cold placard pressure in order for the Tire Pressure Monitoring Telltale Light to turn off. The system will automatically update and the Tire Pressure Monitoring Telltale Light will turn off once the system receives the updated tire pressures. The vehicle may need to be driven for up to 20 minutes above 15 mph (24 km/h) in order for the TPMS to receive this information.

For example, your vehicle may have a recommended cold (parked for more than three hours) placard pressure of 30 psi (207 kPa). If the ambient temperature is 68°F (20°C) and the measured tire pressure is 27 psi (186 kPa), a temperature drop to 20°F (-7°C) will decrease the tire pressure to approximately 23 psi (158 kPa). This tire pressure is sufficiently low enough to turn ON the Tire Pressure Monitoring Telltale Light. Driving the vehicle may cause the tire pressure to rise to approximately 27 psi (186 kPa), but the Tire Pressure Monitoring Telltale Light will still be ON. In this situation, the Tire Pressure Monitoring Telltale Light will turn OFF only after the tires are inflated to the vehicle's recommended cold placard pressure value.

CAUTION!

- The TPMS has been optimized for the original equipment tires and wheels. TPMS pressures and warnings have been established for the tire size equipped on your vehicle. Undesirable system operation or sensor damage may result when using replacement equipment that is not of the same size, type, and/or style. Aftermarket wheels can cause sensor damage. Do not use aftermarket tire sealants or balance beads if your vehicle is equipped with a TPMS, as damage to the sensors may result.
- After inspecting or adjusting the tire pressure, always reinstall the valve stem cap. This will prevent moisture and dirt from entering the valve stem, which could damage the Tire Pressure Monitoring Sensor.

NOTE:

- The TPMS is not intended to replace normal tire care and maintenance or to provide warning of a tire failure or condition.
- The TPMS should not be used as a tire pressure gauge while adjusting your tire pressure.
- Driving on a significantly under-inflated tire causes the tire to overheat and can lead to tire failure. Under-inflation also reduces fuel efficiency and tire tread life, and may affect the vehicle's handling and stopping ability.
- The TPMS is not a substitute for proper tire maintenance, and it is the driver's responsibility to maintain correct tire pressure using an accurate tire gauge, even if under-inflation has not reached the level to trigger illumination of the Tire Pressure Monitoring Telltale Light.

- Seasonal temperature changes will affect tire pressure, and the TPMS will monitor the actual tire pressure in the tire.

Base System

This is the TPMS warning indicator located in the instrument cluster.

The TPMS uses wireless technology with wheel rim mounted electronic sensors to monitor tire pressure levels. Sensors, mounted to each wheel as part of the valve stem, transmit tire pressure readings to the Receiver Module.

NOTE: It is particularly important for you to check the tire pressure in all of the tires on your vehicle regularly and to maintain the proper pressure.

The TPMS consists of the following components:

- Receiver Module

- Four Tire Pressure Monitoring Sensors
- Tire Pressure Monitoring Telltale Light

Tire Pressure Monitoring Low Pressure Warnings

The Tire Pressure Monitoring Telltale Light will illuminate in the instrument cluster, a LOW TIRE message will be displayed for a minimum of five seconds, and an audible chime will be activated when one or more of the four active road tire pressures are low. Should this occur, you should stop as soon as possible, check the inflation pressure of each tire on your vehicle, and inflate each tire to the vehicle's recommended cold placard pressure value. The system will automatically update and the Tire Pressure Monitoring Light will extinguish and the LOW TIRE message will turn off once the updated tire pressures have been received. The vehicle may need to be driven for up to 20 minutes above 15 mph (24 km/h) to receive this information.

Check TPMS Warnings

The Tire Pressure Monitoring Telltale Light will flash on and off for 75 seconds and remain on solid when a system fault is detected. The system fault will also sound a chime. If the ignition key is cycled, this sequence will repeat providing the system fault still exists. The Tire Pressure Monitoring Telltale Light will turn off when the fault condition no longer exists. A system fault can occur with any of the following scenarios:

1. Jamming due to electronic devices or driving next to facilities emitting the same radio frequencies as the TPM sensors.
2. Installing some form of aftermarket window tinting that affects radio wave signals.
3. Snow or ice around the wheels or wheel housings.
4. Using tire chains on the vehicle.
5. Using wheels/tires not equipped with TPM sensors.

NOTE: Your vehicle is equipped with a compact spare wheel and tire assembly.

1. The compact spare tire does not have a tire pressure monitoring sensor. Therefore, the TPMS will not monitor the tire pressure in the compact spare tire.
2. If you install the compact spare tire in place of a road tire that has a pressure below the low-pressure warning limit, upon the next ignition key cycle, a chime will sound and the Tire Pressure Monitoring Telltale Light and LOW TIRE message will still turn ON due to the low tire.
3. However, after driving the vehicle for up to 20 minutes above 15 mph (24 km/h), the Tire Pressure Monitoring Telltale Light will flash on and off for 75 seconds and then remain on solid.
4. For each subsequent ignition key cycle, a chime will sound and the Tire Pressure Monitoring Telltale Light will flash on and off for 75 seconds and then remain on solid.

5. Once you repair or replace the original road tire and reinstall it on the vehicle in place of the compact spare tire, the TPMS will update automatically and the Tire Pressure Monitoring Telltale Light will turn OFF, as long as no tire pressure is below the low-pressure warning limit in any of the four active road tires. The vehicle may need to be driven for up to 20 minutes above 15 mph (24 km/h) in order for the TPMS to receive this information.

Premium System – If Equipped

The TPMS uses wireless technology with wheel rim mounted electronic sensors to monitor tire pressure levels. Sensors, mounted to each wheel as part of the valve stem, transmit tire pressure readings to the receiver module.

NOTE: It is particularly important for you to check the tire pressure in all of your tires regularly and to maintain the proper pressure.

The TPMS consists of the following components:

- Receiver Module
- Four Tire Pressure Monitoring Sensors
- Three Trigger Modules (mounted in three of the four wheel wells)
- Various Tire Pressure Monitoring System Messages, which display in the Electronic Vehicle Information Center (EVIC)
- Tire Pressure Monitoring Telltale Light

Tire Pressure Monitoring Low Pressure Warnings

The Tire Pressure Monitoring Telltale Light will illuminate in the instrument cluster and an audible chime will be activated when one or more of the four active road tire pressures are low. The audible chime will sound once every ignition cycle for the first condition that it detects.

In addition, the EVIC will display a “LOW TIRE” text message and a graphic of the pressure value(s) with the low tire(s) flashing.

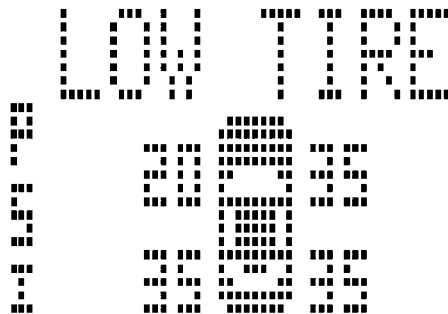

81826bed

Low Tire Pressure Display

Should a low tire condition occur on any of the four active road tire(s), you should stop as soon as possible and inflate all tires that are flashing on the graphic

display to the vehicle's recommended cold placard pressure value. The system will automatically update, the "LOW TIRE" text message will no longer be displayed, the graphic display of the pressure value(s) will stop flashing, and the Tire Pressure Monitoring Light will extinguish once the updated tire pressure(s) have been received. The vehicle may need to be driven for up to 20 minutes above 15 mph (24 km/h) to receive this information.

Check TPMS Message

The Tire Pressure Monitoring Telltale Light will flash on and off for 75 seconds, and remain on solid when a system fault is detected. The system fault will also sound a chime. The EVIC will display a "CHECK TPM SYSTEM" message for a minimum of five seconds. This text message is then followed by a graphic display, with "--" in place of the pressure value(s) indicating which Tire Pressure Monitoring Sensor(s) is not being received.

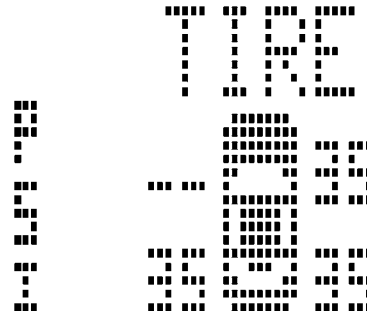

81826bd7

Check TPM System Display

If the ignition key is cycled, this sequence will repeat, providing the system fault still exists. If the system fault no longer exists, the Tire Pressure Monitoring Telltale Light will no longer flash, the "CHECK TPM SYSTEM" text message will not be present, and a pressure value

will be displayed instead of dashes. A system fault can occur with any of the following scenarios:

1. Jamming due to electronic devices or driving next to facilities emitting the same radio frequencies as the TPM sensors.
2. Installing some form of aftermarket window tinting that affects radio wave signals.
3. Snow or ice around the wheels or wheel housings.
4. Using tire chains on the vehicle.
5. Using wheels/tires not equipped with TPM sensors.

The EVIC will also display a "CHECK TPM SYSTEM" message for a minimum of five seconds when a system fault related to an incorrect sensor location fault is detected. In this case, the "CHECK TPM SYSTEM" message is then followed with a graphic display with pressure values still shown. This indicates that the pressure

values are still being received from the TPM sensors but they may not be located in the correct vehicle position. The system still needs to be serviced as long as the "CHECK TPM SYSTEM" message is displayed.

NOTE: Your vehicle is equipped with a compact spare wheel and tire assembly.

1. The compact spare tire does not have a tire pressure monitoring sensor. Therefore, the TPMS will not monitor the tire pressure in the compact spare tire.
2. If you install the compact spare tire in place of a road tire that has a pressure below the low-pressure warning limit, upon the next ignition key cycle, a chime will sound and the Tire Pressure Monitoring Telltale Light will still turn ON due to the low tire. The "LOW TIRE" text message and the graphic with the low tire pressure flashing will be displayed.

3. However, after driving the vehicle for up to 20 minutes above 15 mph (24 km/h), the Tire Pressure Monitoring Telltale Light will flash on and off for 75 seconds and then remain on solid. In addition, the EVIC will display a “CHECK TPM SYSTEM” message for a minimum of five seconds and then display dashes (- -) in place of the pressure values.

4. For each subsequent ignition key cycle, a chime will sound and the Tire Pressure Monitoring Telltale Light will flash on and off for 75 seconds and then remain on solid, and the EVIC will display a “CHECK TPM SYSTEM” message for a minimum of five seconds and then display dashes (- -) in place of the pressure values.

5. Once you repair or replace the original road tire and reinstall it on the vehicle in place of the compact spare tire, the TPMS will update automatically and the Tire Pressure Monitoring Telltale Light will turn OFF, as long as no tire pressure is below the low-pressure warning

limit in any of the four active road tires. The vehicle may need to be driven for up to 20 minutes above 15 mph (24 km/h) in order for the TPMS to receive this information.

General Information

This device complies with Part 15 of the FCC rules and RSS 210 of Industry Canada. Operation is subject to the following conditions:

- This device may not cause harmful interference.
- This device must accept any interference received, including interference that may cause undesired operation.

The tire pressure sensors are covered under one of the following licenses:

United States	KR5S18002015B
Canada.	267T-S180015B

FUEL REQUIREMENTS

2.0L And 2.4L Engine



This engine is designed to meet all emissions regulations and provide excellent fuel economy and performance when using high-quality unleaded “regular” gasoline having an octane rating of 87. The use of premium gasoline is not recommended, as it will not provide any benefit over regular gasoline in these engines.

Light spark knock at low engine speeds is not harmful to your engine. However, continued heavy spark knock at high speeds can cause damage and immediate service is required. Poor quality gasoline can cause problems such as hard starting, stalling, and hesitations. If you experience these symptoms, try another brand of gasoline before considering service for the vehicle.

Over 40 auto manufacturers worldwide have issued and endorsed consistent gasoline specifications (the Worldwide Fuel Charter, WWFC) which define fuel properties necessary to deliver enhanced emissions, performance, and durability for your vehicle. The manufacturer recommends the use of gasolines that meet the WWFC specifications if they are available.

Reformulated Gasoline

Many areas of the country require the use of cleaner burning gasoline referred to as “Reformulated Gasoline.” Reformulated gasoline contains oxygenates and are specifically blended to reduce vehicle emissions and improve air quality.

The manufacturer supports the use of reformulated gasoline. Properly blended reformulated gasoline will provide excellent performance and durability of engine and fuel system components.

Gasoline/Oxygenate Blends

Some fuel suppliers blend unleaded gasoline with oxygenates such as Ethanol. Fuels blended with oxygenates may be used in your vehicle.

CAUTION!

DO NOT use gasoline containing Methanol or gasoline containing more than 10% Ethanol. Use of these blends may result in starting and driveability problems, damage critical fuel system components, cause emissions to exceed the applicable standard, and/or cause the "Malfunction Indicator Light" to illuminate. Pump labels should clearly communicate if a fuel contains greater than 10% Ethanol.

Problems that result from using gasoline containing Methanol or gasoline containing more than 10% Ethanol are not the responsibility of the manufacturer and may not be covered under warranty.

E-85 Usage In Non-Flex Fuel Vehicles

Non-FFV vehicles are compatible with gasoline containing 10% ethanol (E10). Gasoline with higher ethanol content may void the vehicle's warranty.

If a Non-FFV vehicle is inadvertently fueled with E-85 fuel, the engine will have some or all of these symptoms:

- operate in a lean mode
- OBD II "Malfunction Indicator Light" on
- poor engine performance
- poor cold start and cold driveability
- increased risk for fuel system component corrosion

To fix a Non-FFV vehicle inadvertently fueled once with E-85 perform the following:

- change the engine oil and oil filter
- disconnect and reconnect the battery

- drain the fuel tank (see your authorized dealer)

More extensive repairs will be required for prolonged exposure to E-85 fuel.

MMT In Gasoline

MMT is a manganese-containing metallic additive that is blended into some gasoline to increase octane. Gasoline blended with MMT provides no performance advantage beyond gasoline of the same octane number without MMT. Gasoline blended with MMT reduces spark plug life and reduces emissions system performance in some vehicles. The manufacturer recommends that gasoline without MMT be used in your vehicle. The MMT content of gasoline may not be indicated on the gasoline pump, therefore, you should ask your gasoline retailer whether the gasoline contains MMT. It is even more important to look for gasoline without MMT in Canada, because MMT can be used at levels higher than those allowed in the United States. MMT is prohibited in Federal and California reformulated gasoline.

Materials Added To Fuel

All gasoline sold in the United States is required to contain effective detergent additives. Use of additional detergents or other additives is not needed under normal conditions and they would result in additional cost. Therefore, you should not have to add anything to the fuel.

Fuel System Cautions

CAUTION!

Follow these guidelines to maintain your vehicle's performance:

- **The use of leaded gas is prohibited by Federal law. Using leaded gasoline can impair engine performance and damage the emissions control system.**

(Continued)

CAUTION! (Continued)

- An out-of-tune engine or certain fuel or ignition malfunctions can cause the catalytic converter to overheat. If you notice a pungent burning odor or some light smoke, your engine may be out of tune or malfunctioning and may require immediate service. Contact your authorized dealer for service assistance.
- The use of fuel additives, which are now being sold as octane enhancers, is not recommended. Most of these products contain high concentrations of methanol. Fuel system damage or vehicle performance problems resulting from the use of such fuels or additives is not the responsibility of the manufacturer.

NOTE: Intentional tampering with the emissions control system can result in civil penalties being assessed against you.

Carbon Monoxide Warnings**WARNING!**

Carbon monoxide (CO) in exhaust gases is deadly. Follow the precautions below to prevent carbon monoxide poisoning:

- Do not inhale exhaust gases. They contain carbon monoxide, a colorless and odorless gas, which can kill. Never run the engine in a closed area, such as a garage, and never sit in a parked vehicle with the engine running for an extended period. If the vehicle is stopped in an open area with the engine running for more than a short period, adjust the ventilation system to force fresh, outside air into the vehicle.

(Continued)

WARNING! (Continued)

- Guard against carbon monoxide with proper maintenance. Have the exhaust system inspected every time the vehicle is raised. Have any abnormal conditions repaired promptly. Until repaired, drive with all side windows fully open.
- Keep the liftgate closed when driving your vehicle to prevent carbon monoxide and other poisonous exhaust gases from entering the vehicle.

ADDING FUEL**Fuel Filler Cap (Gas Cap)**

The gas cap is behind the fuel filler door, on the left side of the vehicle. If the gas cap is lost or damaged, be sure the replacement cap is for use with this vehicle.

After removing the gas cap, place the gas cap tether cable over a hook on the inside of the fuel door. This keeps the gas cap suspended away from and protects the vehicle's surface.

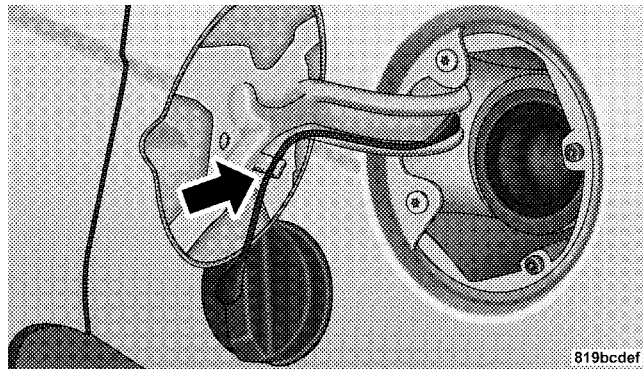
**Fuel Filler Door**

CAUTION!

- Damage to the fuel system or emission control system could result from using an improper fuel tank filler cap (gas cap). A poorly fitting cap could let impurities into the fuel system.
- A poorly fitting gas cap may cause the “Malfunction Indicator Light (MIL)” to turn on.
- To avoid fuel spillage and overfilling, do not “top off” the fuel tank after filling.

WARNING!

- Never have any smoking materials lit in or near the vehicle when the gas cap is removed or the tank is being filled.

(Continued)

WARNING! (Continued)

- Never add fuel when the engine is running. This is in violation of most state and Federal fire regulations and may cause the MIL to turn on.
- A fire may result if gasoline is pumped into a portable container that is inside of a vehicle. You could be burned. Always place gas containers on the ground while filling.

NOTE:

- When the fuel nozzle “clicks” or shuts off, the fuel tank is full.
- Tighten the gas cap about 1/4 turn until you hear one click. This is an indication that cap is properly tightened.
- If the gas cap is not tightened properly, the MIL will come on. Be sure the gas cap is tightened every time the vehicle is refueled.

Loose Fuel Filler Cap Message

If the vehicle diagnostic system determines that the fuel filler cap is loose or improperly installed, a “gASCAP” message will be displayed in the Odometer/Trip Odometer in the instrument cluster. Refer to “Instrument Cluster Description” in “Understanding Your Instrument Panel” for further information. Tighten the fuel filler cap properly and press the odometer/trip odometer RESET button to turn the message off. If the problem continues, the message will appear the next time the vehicle is started. Refer to “Onboard Diagnostic System” in “Maintaining Your Vehicle” for further information.

VEHICLE LOADING

As required by National Highway Traffic Safety Administration regulations, your vehicle has a certification label affixed to the driver’s side door or B-Pillar.

Vehicle Certification Label

Your vehicle has a Vehicle Certification Label attached to the driver’s door B-Pillar.

The label contains the following information:

- Name of manufacturer
- Month and year of manufacture
- Gross Vehicle Weight Rating (GVWR)
- Vehicle Identification Number (VIN)
- Type of Vehicle
- Month, Day and Hour of Manufacture (MDH)

The bar code allows a computer scanner to read the Vehicle Identification Number (VIN).

Gross Vehicle Weight Rating (GVWR)

The GVWR is the total allowable weight of your vehicle. This includes driver, passengers, and cargo. The total load must be limited so that you do not exceed the GVWR.

Tire Size

The tire size on the Vehicle Certification Label represents the actual tire size on your vehicle. Replacement tires must be equal to the load capacity of this tire size.

Rim Size

This is the rim size that is appropriate for the tire size listed.

Inflation Pressure

This is the cold tire inflation pressure for your vehicle, for all loading conditions.

Curb Weight

The curb weight of a vehicle is defined as the total weight of the vehicle with all fluids, including vehicle fuel, at full capacity conditions, and with no occupants or cargo loaded into the vehicle. The front and rear curb weight values are determined by weighing your vehicle on a commercial scale before any occupants or cargo are added.

Overloading

The load carrying components (springs, tires, wheels, etc.) of your vehicle will provide satisfactory service as long as you do not exceed the GVWR.

The best way to figure out the total weight of your vehicle is to weigh it when it is fully loaded and ready for operation. Weigh it on a commercial scale to ensure that it is not over the GVWR.

Overloading can cause potential safety hazards and shorten useful service life. Heavier suspension components do not necessarily increase the vehicle's GVWR.

Loading

To load your vehicle properly, first figure out its empty weight. Store heavier items down low and be sure you distribute their weight as evenly as possible. Stow all loose items securely before driving. Improper weight distribution can have an adverse effect on the way your vehicle steers and handles, and the way the brakes operate.

CAUTION!

Do not load your vehicle any heavier than the GVWR. If you do, parts on your vehicle can break, or it can change the way your vehicle handles. This could cause you to lose control. Also, overloading can shorten the life of your vehicle.

TRAILER TOWING

In this section, you will find safety tips and information on limits to the type of towing you can reasonably do with your vehicle. Before towing a trailer carefully review this information to tow your load as efficiently and safely as possible.

To maintain warranty coverage, follow the requirements and recommendations in this manual concerning vehicles used for trailer towing.

Common Towing Definitions

The following trailer towing related definitions will assist you in understanding the following information:

Gross Vehicle Weight Rating (GVWR)

The GVWR is the total allowable weight of your vehicle. This includes driver, passengers, cargo and tongue weight. The total load must be limited so that you do not

exceed the GVWR. Refer to “Vehicle Loading/Vehicle Certification Label” in “Starting and Operating” for further information.

Gross Trailer Weight (GTW)

The GTW is the weight of the trailer plus the weight of all cargo, consumables and equipment (permanent or temporary) loaded in or on the trailer in its “loaded and ready for operation” condition.

The recommended way to measure GTW is to put your fully loaded trailer on a vehicle scale. The entire weight of the trailer must be supported by the scale.

Gross Combination Weight Rating (GCWR)

The GCWR is the total permissible weight of your vehicle and trailer when weighed in combination.

NOTE: The GCWR rating includes a 150 lbs (68 kg) allowance for the presence of a driver.

Gross Axle Weight Rating (GAWR)

The GAWR is the maximum capacity of the front and rear axles. Distribute the load over the front and rear axles evenly. Make sure that you do not exceed either the front or rear GAWR. Refer to “Vehicle Loading/Vehicle Certification Label” in “Starting and Operating” for further information.

WARNING!

It is important that you do not exceed the maximum front or rear GAWR. A dangerous driving condition can result if either rating is exceeded. You could lose control of the vehicle and have a collision.

Tongue Weight (TW)

The tongue weight is the downward force exerted on the hitch ball by the trailer. In most cases it should not be less than 10% or more than 15% of the trailer load. You must consider this as part of the load on your vehicle.

Frontal Area

The frontal area is the maximum height multiplied by the maximum width of the front of a trailer.

Trailer Sway Control

The trailer sway control is a telescoping link that can be installed between the hitch receiver and the trailer tongue that typically provides adjustable friction associated with the telescoping motion to dampen any unwanted trailer swaying motions while traveling.

Weight-Carrying Hitch

A weight-carrying hitch supports the trailer tongue weight, just as if it were luggage located at a hitch ball or some other connecting point of the truck. These kind of hitches are the most popular on the market today and they are commonly used to tow small- and medium-sized trailers.

Weight-Distributing Hitch

A weight-distributing hitch system works by applying leverage through spring (load) bars. They are typically used for heavier loads, to distribute trailer tongue weight to the tow vehicle's front axle and the trailer axle(s). When used in accordance with the manufacturer's directions, it provides for a more level ride, offering more consistent steering and brake control and thereby enhancing towing safety. The addition of a friction/hydraulic sway control also dampens sway caused by traffic and crosswinds, contributing positively to tow vehicle and trailer stability. Trailer sway control and a weight distributing (load equalizing) hitch are recommended for heavier Tongue Weights (TW) and may be required depending on Vehicle and Trailer configuration/loading to comply with GAWR requirements.

Installing A Trailer Hitch

NOTE: If you install a trailer hitch after you purchase the vehicle, you must install a MOPAR® or equivalent spare tire hold down kit. The kit will allow you to properly secure the spare tire and jack assembly.

WARNING!

Do not operate the vehicle without a properly secured tire and jack assembly. Any loose items may be thrown forward in a collision or hard stop and strike occupants, causing serious or fatal injury.

Trailer Hitch Classification

The following chart provides the industry standard for the maximum trailer weight a given trailer hitch class can tow and should be used to assist you in selecting the correct trailer hitch for your intended towing condition.

Refer to the Trailer Towing Weights (Maximum Trailer Weight Ratings) chart for the Maximum GTW towable for your given drivetrain.

Trailer Hitch Classification Definitions	
Class	Max. Trailer Hitch Industry Standards
Class I - Light Duty	2,000 lbs (907 kg)
Class II - Medium Duty	3,500 lbs (1 587 kg)
Class III - Heavy Duty	5,000 lbs (2 268 kg)
Class IV - Extra Heavy Duty	10,000 lbs (4 540 kg)
Refer to the "Trailer Towing Weights (Maximum Trailer Weight Ratings)" chart for the Maximum Gross Trailer Weight (GTW) towable for your given drivetrain.	

All trailer hitches should be professionally installed on your vehicle.

Trailer Towing Weights (Maximum Trailer Weight Ratings)

The following chart provides the maximum trailer weight ratings towable for your given drivetrain.

Engine/Transmission	Frontal Area	Max. GTW (Gross Trailer Wt.)	Max. Tongue Wt. (See Note)
2.0L Auto/Man	22 sq ft (2.04 sq m)	1,000 lbs (450 kg)	150 lbs (50 kg)
2.4L Auto/Man	22 sq ft (2.04 sq m)	1,000 lbs (450 kg)	150 lbs (50 kg)
2.0L Auto/Man with Trailer Tow Content in Security Group Package (AJB)	22 sq ft (2.04 sq m)	1,500 lbs (680 kg)	225 lbs (136 kg)
2.4L Auto/Man with Trailer Tow Content in Security Group Package (AJB)	32 sq ft (3.0 sq m)	2,000 lbs (907 kg)	300 lbs (136 kg)

Refer to local laws for maximum trailer towing speeds.

NOTE: The trailer tongue weight must be considered as part of the combined weight of occupants and cargo and should never exceed the weight referenced on the Tire and Loading Information placard. Refer to "Tire Safety Information" in "Starting and Operating" for further information.

Trailer And Tongue Weight

Always load a trailer with 60% to 65% of the weight in the front of the trailer. This places 10% to 15% of the GTW on the tow hitch of your vehicle. Loads balanced over the wheels or heavier in the rear can cause the trailer to sway **severely** from side-to-side which will cause loss of control of vehicle and trailer. Failure to load trailers heavier in front is the cause of many trailer collisions.

Never exceed the maximum tongue weight stamped on your bumper or trailer hitch.

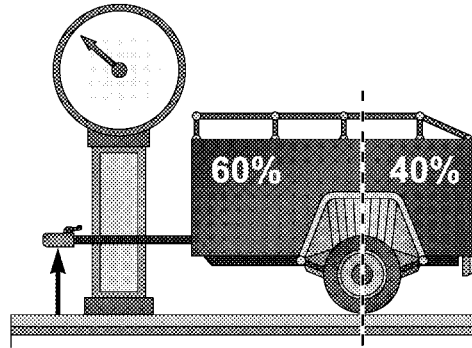

057003767

Consider the following items when computing the weight on the rear axle of the vehicle:

- The tongue weight of the trailer.
- The weight of any other type of cargo or equipment put in or on your vehicle.
- The weight of the driver and all passengers.

NOTE: Remember that everything put into or on the trailer adds to the load on your vehicle. Also, additional factory-installed options, or dealer-installed options, must be considered as part of the total load on your vehicle. Refer to the “Tire and Loading Information Placard” in “Tire Safety Information” for the maximum combined weight of occupants and cargo for your vehicle.

Towing Requirements

To promote proper break-in of your new vehicle drivetrain components, the following guidelines are recommended:

CAUTION!

- Do not tow a trailer at all during the first 500 miles (805 km) the new vehicle is driven. The engine, axle or other parts could be damaged.

(Continued)

CAUTION! (Continued)

- Then, during the first 500 miles (805 km) that a trailer is towed, do not drive over 50 mph (80 km/h) and do not make starts at full throttle. This helps the engine and other parts of the vehicle wear in at the heavier loads.

Perform the maintenance listed in the Maintenance Schedule. Refer to “Maintenance Schedule” for further information. When towing a trailer, never exceed the GAWR or GCWR ratings.

WARNING!

Improper towing can lead to a collision. Follow these guidelines to make your trailer towing as safe as possible:

(Continued)

WARNING! (Continued)

- Make certain that the load is secured in the trailer and will not shift during travel. When trailering cargo that is not fully secured, dynamic load shifts can occur that may be difficult for the driver to control. You could lose control of your vehicle and have a collision.
- When hauling cargo or towing a trailer, do not overload your vehicle or trailer. Overloading can cause a loss of control, poor performance or damage to the brakes, axle, engine, transmission, steering, suspension, chassis structure or tires.
- Safety chains must always be used between your vehicle and trailer. Always connect the chains to the frame or hook retainers of the vehicle hitch. Cross the chains under the trailer tongue and allow enough slack for turning corners.

(Continued)

WARNING! (Continued)

- Vehicles with trailers should not be parked on a grade. When parking, apply the parking brake on the tow vehicle. Put the tow vehicle automatic transmission in PARK. With a manual transmission, shift the transmission into REVERSE. Always block or "chock" the trailer wheels.
- GCWR must not be exceeded.
- Total weight must be distributed between the tow vehicle and the trailer such that the following four ratings are not exceeded:
 1. GVWR
 2. GTW
 3. GAWR
 4. Tongue weight rating for the trailer hitch utilized (this requirement may limit the ability to always achieve the 10% to 15% range of tongue weight as a percentage of total trailer weight).

Towing Requirements – Tires

- Do not attempt to tow a trailer while using a compact spare tire.
- Proper tire inflation pressures are essential to the safe and satisfactory operation of your vehicle. Refer to “Tires – General Information” in “Starting and Operating” for proper tire inflation procedures.
- Check the trailer tires for proper tire inflation pressures before trailer usage.
- Check for signs of tire wear or visible tire damage before towing a trailer. Refer to “Tires – General Information” in “Starting and Operating” for the proper inspection procedure.
- When replacing tires, refer to “Tires – General Information” in “Starting and Operating” for proper tire

replacement procedures. Replacing tires with a higher load carrying capacity will not increase the vehicle’s GVWR and GAWR limits.

Towing Requirements – Trailer Brakes

- Do **not** interconnect the hydraulic brake system or vacuum system of your vehicle with that of the trailer. This could cause inadequate braking and possible personal injury.
- An electronically actuated trailer brake controller is required when towing a trailer with electronically actuated brakes. When towing a trailer equipped with a hydraulic surge actuated brake system, an electronic brake controller is not required.
- Trailer brakes are recommended for trailers over 1,000 lbs (450 kg) and required for trailers in excess of 2,000 lbs (907 kg).

CAUTION!

If the trailer weighs more than 1,000 lbs (450 kg) loaded, it should have its own brakes and they should be of adequate capacity. Failure to do this could lead to accelerated brake lining wear, higher brake pedal effort, and longer stopping distances.

WARNING!

- Do not connect trailer brakes to your vehicle's hydraulic brake lines. It can overload your brake system and cause it to fail. You might not have brakes when you need them and could have a collision.

(Continued)

WARNING! (Continued)

- Towing any trailer will increase your stopping distance. When towing, you should allow for additional space between your vehicle and the vehicle in front of you. Failure to do so could result in a collision.

Towing Requirements – Trailer Lights And Wiring

Whenever you pull a trailer, regardless of the trailer size, stop lights and turn signals on the trailer are required for motoring safety.

The Trailer Tow Package may include a four-pin and seven-pin wiring harness. Use a factory approved trailer harness and connector.

NOTE: Do not cut or splice wiring into the vehicle's wiring harness.

The electrical connections are all complete to the vehicle, but you must mate the harness to a trailer connector. Refer to the following illustrations.

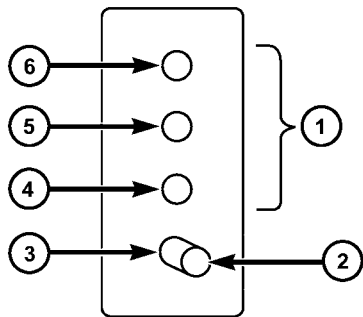

Four-Pin Connector

057003766

- | | |
|-----------------|---------------------|
| 1 — Female Pins | 4 — Park |
| 2 — Male Pin | 5 — Left Stop/Turn |
| 3 — Ground | 6 — Right Stop/Turn |

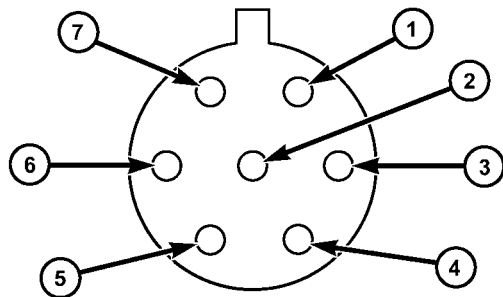

Seven-Pin Connector

057003765

- | | |
|---------------------|--------------------|
| 1 — Battery | 5 — Ground |
| 2 — Backup Lamps | 6 — Left Stop/Turn |
| 3 — Right Stop/Turn | 7 — Running Lamps |
| 4 — Electric Brakes | |

Towing Tips

Before setting out on a trip, practice turning, stopping and backing the trailer in an area away from heavy traffic.

If using a manual transmission vehicle for trailer towing, all starts must be in first gear to avoid excessive clutch slippage.

Electronic Speed Control – If Equipped

- Do not use in hilly terrain or with heavy loads.
- When using the speed control, if you experience speed drops greater than 10 mph (16 km/h), disengage it until you can get back to cruising speed.
- Use speed control in flat terrain and with light loads to maximize fuel efficiency.

Cooling System

To reduce potential for engine and transmission overheating, take the following actions:

– *City Driving*

When stopped for short periods of time, shift the transmission into NEUTRAL and increase the engine idle speed.

– *Highway Driving*

Reduce speed.

– *Air Conditioning*

Turn off temporarily.

RECREATIONAL TOWING (BEHIND MOTORHOME, ETC.)

Towing This Vehicle Behind Another Vehicle

Towing Condition	Wheels OFF the Ground	Manual Transmission	Automatic Transmission
Flat Tow	None	<ul style="list-style-type: none"> • Transmission in NEUTRAL • Key in ACC 	No
Dolly Tow	Front	No	OK
	Rear	No	No
On Trailer	All	OK	OK

NOTE: Vehicles equipped with **manual transmissions** may be recreationally towed (flat towed) at any legal highway speed, for any distance, if the **manual transmission** is in NEUTRAL and the ignition key is in the ACC position.

CAUTION!

- Do not flat tow any vehicle equipped with a automatic transmission. Damage to the drivetrain will result. If these vehicles require towing, make sure all drive wheels are off the ground.
- Front or rear wheel lifts should not be used. Internal damage to the transmission will occur if a front or rear wheel lift is used when recreational towing.

WHAT TO DO IN EMERGENCIES

CONTENTS

■ Hazard Warning Flashers	372	■ Jump-Starting Procedures	381
■ If Your Engine Overheats	372	□ Preparations For Jump-Start	382
■ Automatic Transmission Overheating	373	□ Jump-Starting Procedure	384
■ Jacking And Tire Changing	374	■ Freeing A Stuck Vehicle	386
□ Jack Location	374	■ Shift Lever Override	387
□ Spare Tire Stowage	375	■ Towing A Disabled Vehicle	388
□ Preparations For Jacking	375	□ With Ignition Key	388
□ Jacking Instructions	376	□ Without The Ignition Key	390

HAZARD WARNING FLASHERS

The Hazard Warning flasher switch is located on the instrument panel, below the radio.

 Press the switch to turn on the Hazard Warning flasher. When the switch is activated, all directional turn signals will flash on and off to warn oncoming traffic of an emergency. Press the switch a second time to turn off the Hazard Warning flashers.

This is an emergency warning system and it should not be used when the vehicle is in motion. Use it when your vehicle is disabled and it is creating a safety hazard for other motorists.

When you must leave the vehicle to seek assistance, the Hazard Warning flashers will continue to operate even though the ignition is placed in the OFF position.

NOTE: With extended use the Hazard Warning flashers may wear down your battery.

IF YOUR ENGINE OVERHEATS

In any of the following situations, you can reduce the potential for overheating by taking the appropriate action.

- On the highways — slow down.
- In city traffic — while stopped, place the transmission in NEUTRAL, but do not increase engine idle speed.

NOTE: There are steps that you can take to slow down an impending overheating condition:

- If your air conditioner (A/C) is on, turn it off. The A/C system adds heat to the engine cooling system and turning the A/C off can help remove this heat.
- You can also turn the temperature control to maximum heat, the mode control to floor and the blower control to high. This allows the heater core to act as a supplement to the radiator and aids in removing heat from the engine cooling system.

CAUTION!

Driving with a hot cooling system could damage your vehicle. If the pointer rises to the H (red) mark, the instrument cluster will sound a chime. When safe, pull over and stop the vehicle with the engine at idle. Turn off the air conditioning and wait until the pointer drops back into the normal range. If the pointer remains on the H (red) mark for more than a minute, turn the engine off immediately and call for service.

WARNING!

You or others can be badly burned by hot engine coolant (antifreeze) or steam from your radiator. If you see or hear steam coming from under the hood, do not open the hood until the radiator has had time to cool. Never try to open a cooling system pressure cap when the radiator or coolant bottle is hot.

AUTOMATIC TRANSMISSION OVERHEATING

During sustained high speed driving or trailer towing up long grades on hot days, the automatic transmission oil may become too hot.



If this happens, the transmission overheat indicator light will come on, and the vehicle will slow slightly until the automatic transmission cools down enough to allow a return to the requested speed. If the high speed is maintained, the overheating may reoccur, as before, in a cyclic fashion.

JACKING AND TIRE CHANGING**WARNING!**

- Do not attempt to change a tire on the side of the vehicle close to moving traffic. Pull far enough off the road to avoid the danger of being hit when operating the jack or changing the wheel.
- Being under a jacked-up vehicle is dangerous. The vehicle could slip off the jack and fall on you. You could be crushed. Never put any part of your body under a vehicle that is on a jack.
- Never start or run the engine while the vehicle is on a jack. If you need to get under a raised vehicle, take it to a service center where it can be raised on a lift.

(Continued)

WARNING! (Continued)

- The jack is designed to be used as a tool for changing tires only. The jack should not be used to lift the vehicle for service purposes. The vehicle should be jacked on a firm level surface only. Avoid ice or slippery areas.

Jack Location

The jack and jack-handle are stowed under the load floor in the cargo area.



Spare Tire and Jack Stowage

Spare Tire Stowage

The compact spare tire is stowed under the rear load floor in the cargo area.

Spare Tire Removal

Lift up the load floor cover and remove the hold down.

Preparations For Jacking

1. Park the vehicle on a firm level surface, avoiding ice or slippery areas.

WARNING!

Do not attempt to change a tire on the side of the vehicle close to moving traffic, pull far enough off the road to avoid the danger of being hit when operating the jack or changing the wheel.

2. Turn on the Hazard Warning flasher.
3. Set the parking brake.
4. Place the shift lever in PARK (automatic transmission) or REVERSE (manual transmission).
5. Turn OFF the ignition.



6. Block both the front and rear of the wheel diagonally opposite the jacking position. For example, if changing the right front tire, block the left rear wheel.

NOTE: Passengers should not remain in the vehicle while the vehicle is being jacked.

Jacking Instructions

WARNING!

Carefully follow these tire changing warnings to help prevent personal injury or damage to your vehicle:

(Continued)

WARNING! (Continued)

- Always park on a firm, level surface as far from the edge of the roadway as possible before raising the vehicle.
- Turn on the Hazard Warning flasher.
- Block the wheel diagonally opposite the wheel to be raised.
- Set the parking brake firmly and set an automatic transmission in PARK; a manual transmission in REVERSE.
- Never start or run the engine with the vehicle on a jack.
- Do not let anyone sit in the vehicle when it is on a jack.
- Do not get under the vehicle when it is on a jack.
- Only use the jack in the positions indicated and for lifting this vehicle during a tire change.

(Continued)

WARNING! (Continued)

- If working on or near a roadway, be extremely careful of motor traffic.
- To assure that spare tires, flat or inflated, are securely stowed, spares must be stowed with the valve stem facing the ground.



Jack Warning Label

CAUTION!

Do not attempt to raise the vehicle by jacking on locations other than those indicated in the Jacking Instructions for this vehicle.

NOTE: Refer to “Tires — General Information” in “Starting And Operating” for further information about the spare tire, it’s use, and operation.

1. Remove the scissors jack and lug wrench from the spare wheel as an assembly. Turn the jack screw to the left to loosen the lug wrench and remove the wrench from the jack assembly.

2. Loosen, but do not remove, the wheel nuts by turning them to the left one turn while the wheel is still on the ground.

NOTE: There are front and rear jacking locations on each side of the body. The front locations are outlined by two triangular cutouts, the rear locations by two rectangular cutouts.

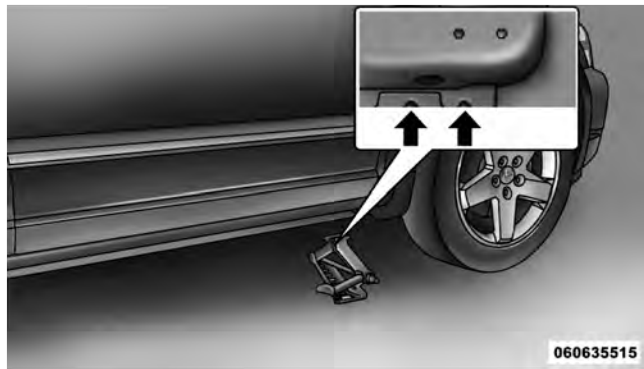

Front Jacking Location



Rear Jacking Location

For vehicles equipped with plastic trim, the plastic has been cut away to expose the jacking locations in the body.

Do not raise the vehicle until you are sure the jack is securely engaged.

3. Turn the jack screw to the left until the jack can be placed under the jacking location. Once the jack is positioned, turn the jack screw to the right until the jack head is properly engaged with the lift area closest to the wheel to be changed.

WARNING!

Raising the vehicle higher than necessary can make the vehicle less stable. It could slip off the jack and hurt someone near it. Raise the vehicle only enough to remove the tire.

4. Using the swivel wrench raise the vehicle by turning the jack screw to the right. Raise the vehicle only until the tire just clears the surface and enough clearance is obtained to install the spare tire. Minimum tire lift provides maximum stability.

5. Remove the wheel nuts and pull the wheel and wheel covers, where applicable, off the hub. Install the spare wheel and wheel nuts with the cone shaped end of the nuts toward the wheel. Lightly tighten the nuts.

WARNING!

To avoid the risk of forcing the vehicle off the jack, do not tighten the wheel nuts fully until the vehicle has been lowered. Failure to follow this warning may result in personal injury.

CAUTION!

Be sure to mount the spare tire with the valve stem facing outward. The vehicle could be damaged if the spare tire is mounted incorrectly.



060633619

Mounting Spare Tire

WARNING!

To avoid possible personal injury, handle the wheel covers with care to avoid contact with any sharp edges.

NOTE: The wheel cover is held on the wheel by the wheel nuts. When reinstalling the original wheel, properly align the wheel cover to the valve stem, place the wheel cover onto the wheel, then install the wheel nuts.

6. Lower the vehicle by turning the jack screw to the left.
7. Finish tightening the nuts. Push down on the wrench while tightening the wheel nuts. Alternate nuts until each nut has been tightened twice. The correct wheel nut torque is 100 ft lbs (135 N·m). If you doubt that you have tightened the nuts correctly, have them checked with a torque wrench by your authorized dealer or service station.

8. Remove the wheel blocks and lower the jack until it is free. Reassemble the lug wrench to the jack assembly and stow it in the spare tire area. Secure the assembly using the means provided.

WARNING!

A loose tire or jack thrown forward in a collision or hard stop could endanger the occupants of the vehicle. Always stow the jack parts and the spare tire in the places provided.

9. Place the deflated (flat) tire in the cargo area, **have the tire repaired or replaced as soon as possible.**

WARNING!

A loose tire thrown forward in a collision or hard stop could injure the occupants in the vehicle. Have the deflated (flat) tire repaired or replaced immediately.

10. Check the spare tire pressure as soon as possible. Correct the tire pressure as required.

JUMP-STARTING PROCEDURES

If your vehicle has a discharged battery it can be jump-started using a set of jumper cables and a battery in another vehicle or by using a portable battery booster pack. Jump-starting can be dangerous if done improperly so please follow the procedures in this section carefully.

NOTE: When using a portable battery booster pack follow the manufacturer's operating instructions and precautions.

CAUTION!

Do not use a portable battery booster pack or any other booster source with a system voltage greater than 12 Volts or damage to the battery, starter motor, alternator or electrical system may occur.

WARNING!

Do not attempt jump-starting if the battery is frozen. It could rupture or explode and cause personal injury.

Preparations For Jump-Start

The battery in your vehicle is located in the front of the engine compartment below the air intake duct. To access the battery remove the air intake duct by turning the two finger screws, located on the radiator support.

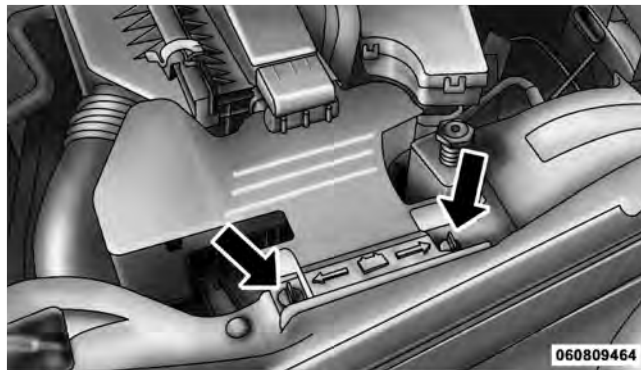

Air Intake Finger Screws

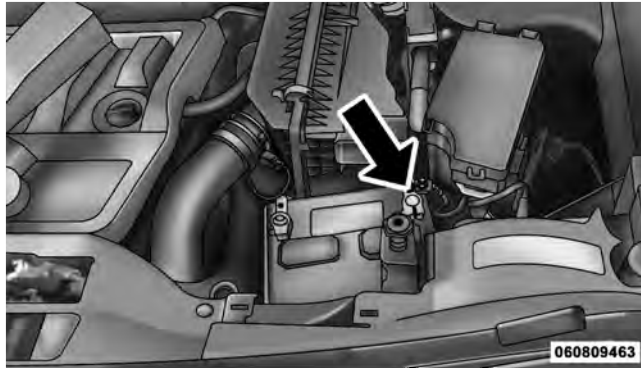

Positive Battery Post

WARNING!

- Take care to avoid the radiator cooling fan whenever the hood is raised. It can start anytime the ignition switch is on. You can be injured by moving fan blades.
- Remove any metal jewelry such as watch bands or bracelets that might make an inadvertent electrical contact. You could be seriously injured.
- Batteries contain sulfuric acid that can burn your skin or eyes and generate hydrogen gas which is flammable and explosive. Keep open flames or sparks away from the battery.

1. Set the parking brake, shift the automatic transmission into PARK and turn the ignition to LOCK.
2. Turn off the heater, radio, and all unnecessary electrical accessories.

3. If using another vehicle to jump-start the battery, park the vehicle within the jumper cables reach, set the parking brake and make sure the ignition is OFF.

WARNING!

Do not allow vehicles to touch each other as this could establish a ground connection and personal injury could result.

Jump-Starting Procedure**WARNING!**

Failure to follow this procedure could result in personal injury or property damage due to battery explosion.

CAUTION!

Failure to follow these procedures could result in damage to the charging system of the booster vehicle or the discharged vehicle.

NOTE: Remove Air Intake before proceeding with this Jump-Starting procedure.

1. Connect the positive (+) end of the jumper cable to the positive (+) post of the discharged vehicle.
2. Connect the opposite end of the positive (+) jumper cable to the positive (+) post of the booster battery.
3. Connect the negative end (-) of the jumper cable to the negative (-) post of the booster battery.

4. Connect the opposite end of the negative (-) jumper cable to a good engine ground (exposed metal part of the discharged vehicle's engine) away from the battery and the fuel injection system.

WARNING!

Do not connect the cable to the negative post (-) of the discharged battery. The resulting electrical spark could cause the battery to explode and could result in personal injury.

5. Start the engine in the vehicle that has the booster battery, let the engine idle a few minutes, and then start the engine in the vehicle with the discharged battery.

Once the engine is started, remove the jumper cables in the reverse sequence:

6. Disconnect the negative (-) jumper cable from the engine ground of the vehicle with the discharged battery.

7. Disconnect the negative end (-) of the jumper cable from the negative (-) post of the booster battery.

8. Disconnect the opposite end of the positive (+) jumper cable from the positive (+) post of the booster battery.

9. Disconnect the positive (+) end of the jumper cable from the positive (+) post of the discharged vehicle.

10. Reinstall the air intake duct.

If frequent jump-starting is required to start your vehicle you should have the battery and charging system inspected at your authorized dealer.

CAUTION!

Accessories that can be plugged into the vehicle power outlets draw power from the vehicle's battery, even when not in use (i.e., cellular phones, etc.). Eventually, if plugged in long enough, the vehicle's battery will discharge sufficiently to degrade battery life and/or prevent the engine from starting.

FREEING A STUCK VEHICLE

If your vehicle becomes stuck in mud, sand or snow, it can often be moved by a rocking motion. Turn your steering wheel right and left to clear the area around the front wheels. Then shift back and forth between DRIVE/1st gear and REVERSE. Using minimal accelerator pedal pressure to maintain the rocking motion, without spinning the wheels, is most effective.

CAUTION!

Racing the engine or spinning the wheels may lead to transmission overheating and failure. Allow the engine to idle with the shift lever in NEUTRAL for at least one minute after every five rocking-motion cycles. This will minimize overheating and reduce the risk of transmission failure during prolonged efforts to free a stuck vehicle.

NOTE: If your vehicle is equipped with Traction Control or Electronic Stability Control (ESC), turn the system OFF before attempting to "rock" the vehicle.

CAUTION!

- When “rocking” a stuck vehicle by moving between DRIVE/1st gear and REVERSE, do not spin the wheels faster than 15 mph (24 km/h), or drivetrain damage may result.
- Revving the engine or spinning the wheels too fast may lead to transmission overheating and failure. It can also damage the tires. Do not spin the wheels above 30 mph (48 km/h) while in gear (no transmission shifting occurring).

WARNING!

Fast spinning tires can be dangerous. Forces generated by excessive wheel speeds may cause damage, or even failure, of the axle and tires. A tire could explode and injure someone. Do not spin your vehicle’s wheels faster than 30 mph (48 km/h) or for longer than 30 seconds continuously without stopping when you are stuck and do not let anyone near a spinning wheel, no matter what the speed.

SHIFT LEVER OVERRIDE

If a malfunction occurs and the shift lever cannot be moved out of the PARK position, you can use the following procedure to temporarily move the shift lever:

1. Firmly set the parking brake.

2. Remove the shift lever override access cover located on the right side of the shift lever housing.



Shift Lever Override Access Cover

3. Turn the ignition switch to the ON/RUN position without starting the engine.
4. Press and maintain firm pressure on the brake pedal.

5. Using a small screwdriver or similar tool, push and hold the override release lever forward.

6. Move the shift lever into the NEUTRAL position.

7. The vehicle may then be started in NEUTRAL.

8. Reinstall the shift lever override access cover.

TOWING A DISABLED VEHICLE

With Ignition Key

Automatic Transmission

- Front Wheel Drive (FWD) vehicles can be towed with the front wheels elevated or on a flatbed truck (all four wheels **OFF** the ground).
- All Wheel Drive (AWD) vehicles must be towed on a flatbed truck (all four wheels **OFF** the ground).

CAUTION!

DO NOT flat tow any vehicle equipped with an automatic transmission. Damage to the drivetrain will result.

Manual Transmission

- Front Wheel Drive (FWD) or All Wheel Drive (AWD) vehicles can be flat towed (all four wheels on the ground) with the transmission in NEUTRAL.
- FWD vehicles can be towed with the front wheels elevated.

- FWD or AWD vehicles can be towed on a flatbed truck (all wheels **OFF** the ground).

All Transmissions

If you must use the accessories (wipers, defroster, etc.) while being towed (wipers, defrosters, etc.), the key must be in the ON position, not the ACC position. Make certain the transmission remains in NEUTRAL.

If the vehicle's battery is discharged, see "Shift Lever Override" in "What To Do In Emergencies" for instructions on shifting the automatic transmission out of the PARK position for towing.

CAUTION!

- If the vehicle being towed requires steering, the ignition switch must be in the ON/RUN or ACC position, not in the LOCK position.
- Do not attempt to use sling-type equipment when towing. When securing the vehicle to a flatbed truck, do not attach to front or rear suspension components. Damage to your vehicle may result from improper towing.

Without The Ignition Key

Special care must be taken when the vehicle is towed with the ignition in the LOCK position. The only approved method of towing without the ignition key is with a flatbed truck. Proper towing equipment is necessary to prevent damage to the vehicle.

MAINTAINING YOUR VEHICLE

CONTENTS

■ Engine Compartment — 2.0L	393	■ Maintenance Procedures	398
■ Engine Compartment — 2.4L	394	□ Engine Oil	399
■ Onboard Diagnostic System — OBD II	395	□ Engine Oil Filter	402
□ Loose Fuel Filler Cap Message	395	□ Engine Air Cleaner Filter	402
■ Emissions Inspection And Maintenance Programs	396	□ Maintenance-Free Battery	403
■ Replacement Parts	397	□ Air Conditioner Maintenance	404
■ Dealer Service	398	□ Body Lubrication	405
		□ Windshield Wiper Blades	406
		□ Adding Washer Fluid	406

392 MAINTAINING YOUR VEHICLE

- Exhaust System 407
- Cooling System 409
- Brake System 415
- Automatic Transmission (CVT) –
If Equipped 417
- Manual Transmission – If Equipped 418
- Appearance Care And Protection From
Corrosion 419
- Fuses 424
 - Integrated Power Module 424
- Vehicle Storage 428
- Replacement Bulbs 429
 - Bulb Replacement 429
 - Front Headlamps, Parking, And Turn Signal
Lamps 429
 - Fog Lamps 430
 - Rear Tail, Turn Signal, And Backup Lamps . . . 431
 - License Lamps 433
 - Center High-Mounted Stoplamp 434
 - Fluid Capacities 435
 - Fluids, Lubricants, And Genuine Parts 436
 - Engine 436
 - Chassis 437

ENGINE COMPARTMENT — 2.0L

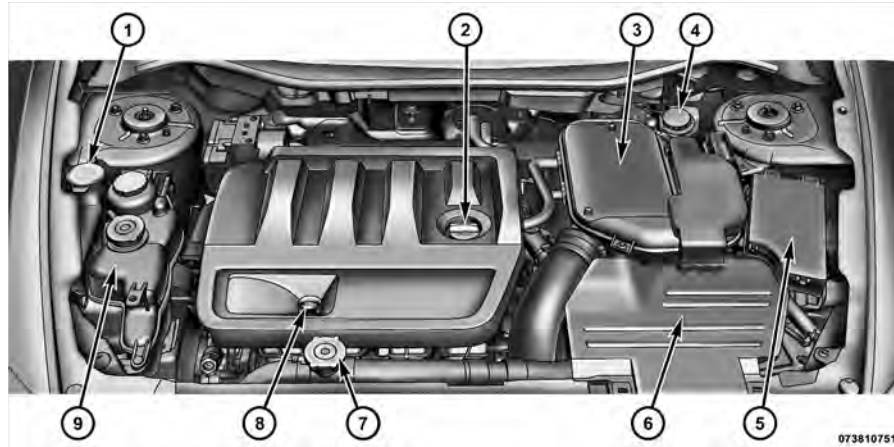

1 — Washer Fluid Reservoir

2 — Engine Oil Fill

3 — Air Cleaner Filter

4 — Brake Fluid Reservoir

5 — Integrated Power Module (Fuses)

6 — Battery (Under Cover)

7 — Coolant Pressure Cap

8 — Engine Oil Dipstick

9 — Engine Coolant Reservoir

ENGINE COMPARTMENT — 2.4L

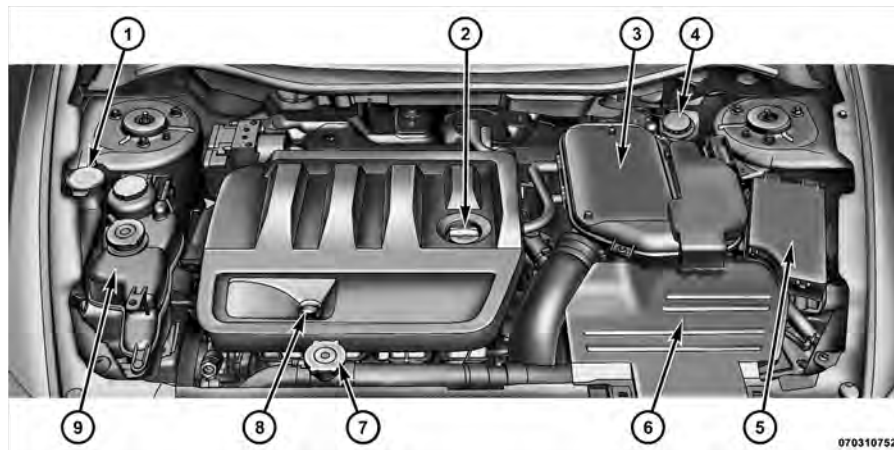

1 — Washer Fluid Reservoir

2 — Engine Oil Fill

3 — Air Cleaner Filter

4 — Brake Fluid Reservoir

5 — Integrated Power Module (Fuses)

6 — Battery (Under Cover)

7 — Coolant Pressure Cap

8 — Engine Oil Dipstick

9 — Engine Coolant Reservoir

ONBOARD DIAGNOSTIC SYSTEM — OBD II

Your vehicle is equipped with a sophisticated onboard diagnostic system called OBD II. This system monitors the performance of the emissions, engine, and automatic transmission control systems. When these systems are operating properly, your vehicle will provide excellent performance and fuel economy, as well as engine emissions well within current government regulations.

If any of these systems require service, the OBD II system will turn on the “Malfunction Indicator Light” (MIL). It will also store diagnostic codes and other information to assist your service technician in making repairs. Although your vehicle will usually be drivable and not need towing, see your authorized dealer for service as soon as possible.

CAUTION!

- **Prolonged driving with the MIL on could cause further damage to the emission control system. It could also affect fuel economy and drivability. The vehicle must be serviced before any emissions tests can be performed.**
- **If the MIL is flashing while the engine is running, severe catalytic converter damage and power loss will soon occur. Immediate service is required.**

Loose Fuel Filler Cap Message

After fuel is added, the vehicle diagnostic system can determine if the fuel filler cap is possibly loose or improperly installed. A “gASCAP” message will be displayed in the instrument cluster. Tighten the gas cap until a “clicking” sound is heard. This is an indication that the gas cap is properly tightened. Press the trip odometer RESET button to turn off the message. If the problem

persists, the message will appear the next time the vehicle is started. This might indicate a damaged cap. If the problem is detected twice in a row, the system will turn on the MIL. Resolving the problem will turn the MIL light off.

EMISSIONS INSPECTION AND MAINTENANCE PROGRAMS

In some localities, it may be a legal requirement to pass an inspection of your vehicle's emissions control system. Failure to pass could prevent vehicle registration.



For states that require an Inspection and Maintenance (I/M), this check verifies the "Malfunction Indicator Light (MIL)" is functioning and is not on when the engine is running, and that the OBD II system is ready for testing.

Normally, the OBD II system will be ready. The OBD II system may **not** be ready if your vehicle was recently serviced, recently had a dead battery or a battery replacement. If the OBD II system should be determined not ready for the I/M test, your vehicle may fail the test.

Your vehicle has a simple ignition key-actuated test, which you can use prior to going to the test station. To check if your vehicle's OBD II system is ready, you must do the following:

1. Turn the ignition switch to the ON position, but do not crank or start the engine.
2. If you crank or start the engine, you will have to start this test over.
3. As soon as you turn the ignition switch to the ON position, you will see the MIL symbol come on as part of a normal bulb check.

4. Approximately 15 seconds later, one of two things will happen:

a. The MIL will flash for about 10 seconds and then return to being fully illuminated until you turn OFF the ignition or start the engine. This means that your vehicle's OBD II system is **not ready** and you should **not** proceed to the I/M station.

b. The MIL will not flash at all and will remain fully illuminated until you turn OFF the ignition or start the engine. This means that your vehicle's OBD II system is **ready** and you can proceed to the I/M station.

If your OBD II system is **not ready**, you should see your authorized dealer or repair facility. If your vehicle was recently serviced or had a battery failure or replacement, you may need to do nothing more than drive your vehicle as you normally would in order for your OBD II

system to update. A recheck with the above test routine may then indicate that the system is now ready.

Regardless of whether your vehicle's OBD II system is ready or not, if the MIL is illuminated during normal vehicle operation you should have your vehicle serviced before going to the I/M station. The I/M station can fail your vehicle because the MIL is on with the engine running.

REPLACEMENT PARTS

Use of genuine MOPAR® parts for normal/scheduled maintenance and repairs is highly recommended to ensure the designed performance. Damage or failures caused by the use of non-MOPAR® parts for maintenance and repairs will not be covered by the manufacturer's warranty.

DEALER SERVICE

Your authorized dealer has the qualified service personnel, special tools, and equipment to perform all service operations in an expert manner. Service Manuals are available which include detailed service information for your vehicle. Refer to these Service Manuals before attempting any procedure yourself.

NOTE: Intentional tampering with emissions control systems may void your warranty and could result in civil penalties being assessed against you.

WARNING!

You can be badly injured working on or around a motor vehicle. Only do service work for which you have the knowledge and the proper equipment. If you have any doubt about your ability to perform a service job, take your vehicle to a competent mechanic.

MAINTENANCE PROCEDURES

The pages that follow contain the **required** maintenance services determined by the engineers who designed your vehicle.

Besides those maintenance items specified in the fixed maintenance schedule, there are other components which may require servicing or replacement in the future.

CAUTION!

- Failure to properly maintain your vehicle or perform repairs and service when necessary could result in more costly repairs, damage to other components or negatively impact vehicle performance. Immediately have potential malfunctions examined by an authorized Chrysler Group LLC dealership or qualified repair center.

(Continued)

CAUTION! (Continued)

- **Your vehicle has been built with improved fluids that protect the performance and durability of your vehicle and also allow extended maintenance intervals. Do not use chemical flushes in these components as the chemicals can damage your engine, transmission, power steering or air conditioning. Such damage is not covered by the New Vehicle Limited Warranty. If a flush is needed because of component malfunction, use only the specified fluid for the flushing procedure.**

Engine Oil**Checking Oil Level**

To assure proper engine lubrication, the engine oil must be maintained at the correct level. Check the oil level at regular intervals, such as every fuel stop. The best time to check the engine oil level is about five minutes after a

fully warmed engine is shut off. Do not check oil level before starting the engine after it has sat overnight. Checking engine oil level when the engine is cold will give you an incorrect reading.

Checking the oil while the vehicle is on level ground and about five minutes after a fully warmed engine is shut off, will improve the accuracy of the oil level readings. Maintain the oil level between the range markings on the dipstick. The range markings will consist of a crosshatch zone that says SAFE or a crosshatch zone that says MIN at the low end of the range and MAX at the high end of the range. Adding 1 qt (1L) of oil when the reading is at the low end of the indicated range will result in the oil level at the full end of the indicator range.

CAUTION!

Do not overfill the engine. Overfilling the engine will cause oil aeration, which can lead to loss of oil pressure and an increase in oil temperature. This could damage your engine. Also, be sure the oil fill cap is replaced and tightened after adding oil.

Change Engine Oil

The oil change indicator system will remind you that it is time to take your vehicle in for scheduled maintenance. Refer to the “Maintenance Schedule” for further information.

NOTE: Under no circumstances should oil change intervals exceed 8,000 miles (13 000 km) or six months, whichever occurs first.

Engine Oil Selection

For best performance and maximum protection for all engines under all types of operating conditions, the manufacturer recommends engine oils that are API Certified and meet the requirements of Chrysler Material Standard MS-6395.

American Petroleum Institute (API) Engine Oil Identification Symbol

This symbol means that the oil has been certified by the American Petroleum Institute (API). The manufacturer only recommends API Certified engine oils.

CAUTION!

Do not use chemical flushes in your engine oil as the chemicals can damage your engine. Such damage is not covered by the New Vehicle Limited Warranty.

Engine Oil Viscosity (SAE Grade)

SAE 5W-20 engine oil is recommended for all operating temperatures. This engine oil improves low temperature starting and vehicle fuel economy. Your engine oil filler cap also states the recommended engine oil viscosity grade for your engine.

Lubricants which do not have both the engine oil certification mark and the correct SAE viscosity grade number should not be used.

The engine oil filler cap also shows the recommended engine oil viscosity for your engine. For information on

engine oil filler cap location, refer to “Engine Compartment” in “Maintaining Your Vehicle” for further information.

Synthetic Engine Oils

You may use synthetic engine oils provided the recommended oil quality requirements are met, and the recommended maintenance intervals for oil and filter changes are followed.

Materials Added To Engine Oils

Do not add any supplemental materials, other than leak detection dyes, to your engine oil. Engine oil is an engineered product and its performance may be impaired by supplemental additives.

Disposing Of Used Engine Oil And Oil Filters

Care should be taken in disposing of used engine oil and oil filters from your vehicle. Used oil and oil filters, indiscriminately discarded, can present a problem to the environment. Contact your authorized dealer, service

station, or governmental agency for advice on how and where used oil and oil filters can be safely discarded in your area.

Engine Oil Filter

The engine oil filter should be replaced with a new filter at every engine oil change.

Engine Oil Filter Selection

All of this manufacturer's engines have a full-flow type disposable oil filter. Use a filter of this type for replacement. The quality of replacement filters varies considerably. Only high quality filters should be used to assure most efficient service. MOPAR® engine oil filters are high quality oil filters and are recommended.

Engine Air Cleaner Filter

Refer to the "Maintenance Schedule" for the proper maintenance intervals.

WARNING!

The air induction system (air cleaner, hoses, etc) can provide a measure of protection in the case of engine backfire. Do not remove the air induction system (air cleaner, hoses, etc.) unless such removal is necessary for repair or maintenance. Make sure that no one is near the engine compartment before starting the vehicle with the air induction system (air cleaner, hoses, etc.) removed. Failure to do so can result in serious personal injury.

Engine Air Cleaner Filter Selection

The quality of replacement engine air cleaner filters varies considerably. Only high quality filters should be used to assure most efficient service. MOPAR® engine air cleaner filters are a high quality filter and are recommended.

Maintenance-Free Battery

Your vehicle is equipped with a maintenance-free battery. You will never have to add water, nor is periodic maintenance required.

WARNING!

- Battery fluid is a corrosive acid solution and can burn or even blind you. Do not allow battery fluid to contact your eyes, skin, or clothing. Do not lean over a battery when attaching clamps. If acid splashes in eyes or on skin, flush the area immediately with large amounts of water. Refer to "Jump-Starting Procedures" in "What To Do In Emergencies" for further information.

(Continued)

WARNING! (Continued)

- Battery gas is flammable and explosive. Keep flame or sparks away from the battery. Do not use a booster battery or any other booster source with an output greater than 12 Volts. Do not allow cable clamps to touch each other.
- Battery posts, terminals, and related accessories contain lead and lead compounds. Wash hands after handling.
- The battery in this vehicle has a vent hose that should not be disconnected and should only be replaced with a battery of the same type (vented).

CAUTION!

- It is essential when replacing the cables on the battery that the positive cable is attached to the positive post and the negative cable is attached to the negative post. Battery posts are marked positive (+) and negative (-) and are identified on the battery case. Cable clamps should be tight on the terminal posts and free of corrosion.
- If a “fast charger” is used while the battery is in the vehicle, disconnect both vehicle battery cables before connecting the charger to the battery. Do not use a “fast charger” to provide starting voltage.

Air Conditioner Maintenance

For best possible performance, your air conditioner should be checked and serviced by an authorized dealer at the start of each warm season. This service should include cleaning of the condenser fins and a performance test. Drive belt tension should also be checked at this time.

CAUTION!

Do not use chemical flushes in your air conditioning system as the chemicals can damage your air conditioning components. Such damage is not covered by the New Vehicle Limited Warranty.

WARNING!

- Use only refrigerants and compressor lubricants approved by the manufacturer for your air conditioning system. Some unapproved refrigerants are flammable and can explode, injuring you. Other unapproved refrigerants or lubricants can cause the system to fail, requiring costly repairs. Refer to Warranty Information Book, located on the DVD, for further warranty information.
- The air conditioning system contains refrigerant under high pressure. To avoid risk of personal injury or damage to the system, adding refrigerant or any repair requiring lines to be disconnected should be done by an experienced repairman.

Refrigerant Recovery And Recycling

R-134a air conditioning refrigerant is a hydrofluorocarbon (HFC) that is endorsed by the Environmental

Protection Agency and is an ozone-saving product. However, the manufacturer recommends that air conditioning service be performed by authorized dealers or other service facilities using recovery and recycling equipment.

NOTE: Use only manufacturer approved A/C system sealers, stop leak products, seal conditioners, compressor oil, or refrigerants.

Body Lubrication

Locks and all body pivot points, including such items as seat tracks, door hinge pivot points and rollers, liftgate, tailgate, sliding doors and hood hinges, should be lubricated periodically with a lithium based grease, such as MOPAR® Spray White Lube or equivalent to assure quiet, easy operation and to protect against rust and wear. Prior to the application of any lubricant, the parts concerned should be wiped clean to remove dust and grit; after lubricating excess oil and grease should be removed. Particular attention should also be given to

hood latching components to ensure proper function. When performing other underhood services, the hood latch, release mechanism and safety catch should be cleaned and lubricated.

The external lock cylinders should be lubricated twice a year, preferably in the Fall and Spring. Apply a small amount of a high quality lubricant, such as MOPAR® Lock Cylinder Lubricant or equivalent directly into the lock cylinder.

Windshield Wiper Blades

Clean the rubber edges of the wiper blades and the windshield periodically with a sponge or soft cloth and a mild, nonabrasive cleaner or use the washer solvent. This will remove accumulations of salt, waxes or road film and help reduce streaking and smearing.

Operation of the wipers on dry glass for long periods may cause deterioration of the wiper blades. Always use washer fluid when using the wipers to remove salt or dirt

from a dry windshield. Avoid using the wiper blades to remove frost or ice from the windshield. Make sure that they are not frozen to the glass before turning them on to avoid damaging the blade. Keep the blade rubber out of contact with petroleum products such as engine oil, gasoline, etc.

NOTE: Life expectancy of wiper blades varies depending on geographical area and frequency of use. Poor performance of blades may be present with chattering, marks, water lines or wet spots. If any of these conditions are present, clean the wiper blades or replace as necessary.

Adding Washer Fluid

The windshield washer fluid reservoir is located in the engine compartment (right rear side), and the fluid level should be checked at regular intervals. Fill the reservoir with windshield washer solvent (not engine coolant (antifreeze)).

WARNING!

Commercially available windshield washer solvents are flammable. They could ignite and burn you. Care must be exercised when filling or working around the washer solution.

Exhaust System

The best protection against carbon monoxide entry into the vehicle body is a properly maintained engine exhaust system.

If you notice a change in the sound of the exhaust system; or if the exhaust fumes can be detected inside the vehicle; or when the underside or rear of the vehicle is damaged; have an authorized technician inspect the complete exhaust system and adjacent body areas for broken, damaged, deteriorated, or mispositioned parts. Open seams or loose connections could permit exhaust fumes to seep

into the passenger compartment. In addition, inspect the exhaust system each time the vehicle is raised for lubrication or oil change. Replace as required.

WARNING!

- Exhaust gases can injure or kill. They contain carbon monoxide (CO), which is colorless and odorless. Breathing it can make you unconscious and can eventually poison you. To avoid breathing CO, refer to "Safety Tips/Exhaust Gas" in "Things To Know Before Starting Your Vehicle" for further information.
- A hot exhaust system can start a fire if you park over materials that can burn. Such materials might be grass or leaves coming into contact with your exhaust system. Do not park or operate your vehicle in areas where your exhaust system can contact anything that can burn.

CAUTION!

- The catalytic converter requires the use of unleaded fuel only. Leaded gasoline will destroy the effectiveness of the catalyst as an emissions control device and may seriously reduce engine performance and cause serious damage to the engine.
- Damage to the catalytic converter can result if your vehicle is not kept in proper operating condition. In the event of engine malfunction, particularly involving engine misfire or other apparent loss of performance, have your vehicle serviced promptly. Continued operation of your vehicle with a severe malfunction could cause the converter to overheat, resulting in possible damage to the converter and vehicle.

Under normal operating conditions, the catalytic converter will not require maintenance. However, it is important to keep the engine properly tuned to assure proper catalyst operation and prevent possible catalyst damage.

NOTE: Intentional tampering with emissions control systems can result in civil penalties being assessed against you.

In unusual situations involving grossly malfunctioning engine operation, a scorching odor may suggest severe and abnormal catalyst overheating. If this occurs, stop the vehicle, turn off the engine and allow it to cool. Service, including a tune-up to manufacturer's specifications, should be obtained immediately.

To minimize the possibility of catalytic converter damage:

- Do not shut off the engine or interrupt the ignition, when the transmission is in gear and the vehicle is in motion.
- Do not try to start the engine by pushing or towing the vehicle.
- Do not idle the engine with any spark plug wires disconnected or removed, such as when diagnostic testing, or for prolonged periods during very rough idle or malfunctioning operating conditions.

Cooling System

WARNING!

- **When working near the radiator cooling fan, disconnect the fan motor lead or turn the ignition switch to the OFF position. The fan is temperature controlled and can start at any time the ignition switch is in the ON position.**
- **You or others can be badly burned by hot engine coolant (antifreeze) or steam from your radiator. If you see or hear steam coming from under the hood, do not open the hood until the radiator has had time to cool. Never try to open a cooling system pressure cap when the radiator is hot.**

Coolant Checks

Check engine coolant (antifreeze) protection every 12 months (before the onset of freezing weather, where applicable). If the engine coolant (antifreeze) is dirty or rusty in appearance, the system should be drained, flushed and refilled with fresh engine coolant (antifreeze). Check the front of the A/C condenser for any accumulation of bugs, leaves, etc. If dirty, clean by gently spraying water from a garden hose vertically down the face of the condenser.

Check the coolant recovery bottle tubing for brittle rubber, cracking, tears, cuts and tightness of the connection at the bottle and radiator. Inspect the entire system for leaks.

Cooling System – Drain, Flush, And Refill

Refer to the “Maintenance Schedule” for the proper maintenance intervals.

If the engine coolant (antifreeze) is dirty or contains a considerable amount of sediment, clean and flush with a reliable cooling system cleaner. Follow with a thorough rinsing to remove all deposits and chemicals. Properly dispose of old engine coolant (antifreeze).

Selection Of Coolant

Refer to “Fluids, Lubricants, and Genuine Parts” in “Maintaining Your Vehicle” for further information.

CAUTION!

- **Mixing of engine coolant (antifreeze) other than specified Hybrid Organic Additive Technology (HOAT) engine coolant (antifreeze), may result in engine damage and may decrease corrosion protection. If a non-HOAT engine coolant (antifreeze) is introduced into the cooling system in an emergency, it should be replaced with the specified engine coolant (antifreeze) as soon as possible.**
- **Do not use water alone or alcohol based engine coolant (antifreeze) products. Do not use additional rust inhibitors or antirust products, as they may not be compatible with the radiator engine coolant and may plug the radiator.**
- **This vehicle has not been designed for use with Propylene Glycol based engine coolant (antifreeze). Use of Propylene Glycol based engine coolant (antifreeze) is not recommended.**

Adding Coolant

Your vehicle has been built with an improved engine coolant (antifreeze) that allows extended maintenance intervals. This engine coolant (antifreeze) can be used up to five years or 104,000 miles (169 000 km) before replacement. To prevent reducing this extended maintenance period, it is important that you use the same engine coolant (antifreeze) throughout the life of your vehicle.

Please review these recommendations for using Hybrid Organic Additive Technology (HOAT) engine coolant (antifreeze). When adding engine coolant (antifreeze):

- The manufacturer recommends using MOPAR® Antifreeze/Coolant 5 Year/100,000 Mile Formula HOAT (Hybrid Organic Additive Technology) or equivalent.

- Mix a minimum solution of 50% HOAT engine coolant and distilled water. Use higher concentrations (not to exceed 70%) if temperatures below -34°F (-37°C) are anticipated.
- Use only high purity water such as distilled or deionized water when mixing the water/engine coolant (antifreeze) solution. The use of lower quality water will reduce the amount of corrosion protection in the engine cooling system.

Please note that it is the owner's responsibility to maintain the proper level of protection against freezing according to the temperatures occurring in the area where the vehicle is operated.

NOTE: Mixing engine coolant (antifreeze) types will decrease the life of the engine coolant (antifreeze) and will require more frequent coolant changes.

Cooling System Pressure Cap

The cap must be fully tightened to prevent loss of engine coolant (antifreeze) and to ensure that engine coolant (antifreeze) will return to the radiator from the coolant recovery bottle.

The cap should be inspected and cleaned if there is any accumulation of foreign material on the sealing surfaces.

WARNING!

- The warning words “DO NOT OPEN HOT” on the cooling system pressure cap are a safety precaution. Never add engine coolant (antifreeze) when the engine is overheated. Do not loosen or remove the cap to cool an overheated engine. Heat causes pressure to build up in the cooling system. To prevent scalding or injury, do not remove the pressure cap while the system is hot or under pressure.
- Do not use a pressure cap other than the one specified for your vehicle. Personal injury or engine damage may result.

Disposal Of Used Engine Coolant

Used ethylene glycol-based engine coolant (antifreeze) is a regulated substance requiring proper disposal. Check with your local authorities to determine the disposal

rules for your community. To prevent ingestion by animals or children do not store ethylene glycol-based engine coolant (antifreeze) in open containers or allow it to remain in puddles on the ground. If ingested by a child or pet, seek emergency assistance immediately. Clean up any ground spills immediately.

Coolant Level

The coolant bottle provides a quick visual method for determining that the coolant level is adequate. With the engine idling and warm to normal operating temperature, the level of the engine coolant (antifreeze) in the bottle should be between the “ADD” and “FULL” lines shown on the bottle.

The radiator normally remains completely full, so there is no need to remove the radiator cap unless checking for the coolant freeze point or replacing the engine coolant (antifreeze). Advise your service attendant of this. As

long as the engine operating temperature is satisfactory, the coolant bottle need only be checked once a month.

When additional engine coolant (antifreeze) is needed to maintain the proper level, it should be added to the coolant bottle. Do not overfill.

Points To Remember

NOTE: When the vehicle is stopped after a few miles/kilometers of operation, you may observe vapor coming from the front of the engine compartment. This is normally a result of moisture from rain, snow, or high humidity accumulating on the radiator and being vaporized when the thermostat opens, allowing hot engine coolant (antifreeze) to enter the radiator.

If an examination of your engine compartment shows no evidence of radiator or hose leaks, the vehicle may be safely driven. The vapor will soon dissipate.

- Do not overfill the coolant recovery bottle.

- Check the coolant freeze point in the radiator and in the coolant recovery bottle. If engine coolant (antifreeze) needs to be added, the contents of the coolant recovery bottle must also be protected against freezing.
- If frequent engine coolant (antifreeze) additions are required, or if the level in the coolant recovery bottle does not drop when the engine cools, the cooling system should be pressure tested for leaks.
- Maintain engine coolant (antifreeze) concentration at 50% HOAT engine coolant (antifreeze) (minimum) and distilled water for proper corrosion protection of your engine which contains aluminum components.
- Make sure that the radiator and coolant recovery bottle overflow hoses are not kinked or obstructed.
- Keep the front of the radiator clean. If your vehicle is equipped with air conditioning, keep the front of the condenser clean.

- Do not change the thermostat for Summer or Winter operation. If replacement is ever necessary, install **ONLY** the correct type thermostat. Other designs may result in unsatisfactory engine coolant (antifreeze) performance, poor gas mileage, and increased emissions.

Brake System

In order to assure brake system performance, all brake system components should be inspected periodically. Refer to the “Maintenance Schedule” for the proper maintenance intervals.

WARNING!

Riding the brakes can lead to brake failure and possibly a collision. Driving with your foot resting or riding on the brake pedal can result in abnormally high brake temperatures, excessive lining wear, and possible brake damage. You would not have your full braking capacity in an emergency.

Brake Master Cylinder

The fluid level in the master cylinder should be checked when performing under hood services, or immediately if the “Brake Warning Light” is on.

Be sure to clean the top of the master cylinder area before removing the cap. If necessary, add fluid to bring the fluid level up to the requirements described on the brake fluid reservoir. Fluid level can be expected to fall as the brake pads wear. The brake fluid level should be checked when the pads are replaced. However, low fluid level may be caused by a leak and a checkup may be needed.

NOTE: If your vehicle is equipped with a **manual transmission**, the brake fluid reservoir supplies fluid to both the brake system and the clutch release system. The two systems are separated in the reservoir, and a leak in one system will not affect the other system. The **manual transmission** clutch release system should not require fluid replacement during the life of the vehicle. If the

brake fluid reservoir is low and the brake system does not indicate any leaks or other problems, it may be a result of a leak in the hydraulic clutch release system. See your local authorized dealer for service.

Use only manufacturer's recommended brake fluid. Refer to "Fluids, Lubricants, and Genuine Parts" in "Maintaining Your Vehicle" for further information.

WARNING!

- Use only manufacturer's recommended brake fluid. Refer to "Fluids, Lubricants, and Genuine Parts" in "Maintaining Your Vehicle" for further information. Using the wrong type of brake fluid can severely damage your brake system and/or impair its performance. The proper type of brake fluid for your vehicle is also identified on the original factory installed hydraulic master cylinder reservoir.

(Continued)

WARNING! (Continued)

- To avoid contamination from foreign matter or moisture, use only new brake fluid or fluid that has been in a tightly closed container. Keep the master cylinder reservoir cap secured at all times. Brake fluid in an open container absorbs moisture from the air resulting in a lower boiling point. This may cause it to boil unexpectedly during hard or prolonged braking, resulting in sudden brake failure. This could result in a collision.
- Overfilling the brake fluid reservoir can result in spilling brake fluid on hot engine parts, causing the brake fluid to catch fire. Brake fluid can also damage painted and vinyl surfaces, care should be taken to avoid its contact with these surfaces.

(Continued)

WARNING! (Continued)

- Do not allow petroleum based fluid to contaminate the brake fluid. Brake seal components could be damaged, causing partial or complete brake failure. This could result in a collision.

CAUTION!

Use of improper brake fluids will affect overall clutch system performance. Improper brake fluids may damage the clutch system resulting in loss of clutch function and the ability to shift the transmission.

Automatic Transmission (CVT) – If Equipped**Selection Of Lubricant**

It is important that the proper lubricant is used in the transmission to assure optimum transmission performance. Use only the manufacturer's recommended transmission fluid which has been formulated with special metal to metal friction coefficient additives to provide the proper steel belt traction on the drive and driven pulleys. Refer to "Fluids, Lubricants, and Genuine Parts" in "Maintaining Your Vehicle" for further information.

CAUTION!

- Do not use chemical flushes in your transmission as the chemicals can damage your transmission components. Such damage is not covered by the New Vehicle Limited Warranty.

(Continued)

CAUTION! (Continued)

- Using a transmission fluid other than the manufacturer's recommended fluid will cause belt slip and result in a complete transmission failure! Refer to "Fluids, Lubricants, and Genuine Parts" in "Maintaining Your Vehicle" for further information.

Special Additives

Do not add any materials (other than leak detection dyes) to Continuously Variable Transmission (CVT) Fluid (CVTF+4®). CVTF+4® is an engineered product and its performance may be impaired by supplemental additives.

Fluid Level Check

The fluid level in the automatic transmission should be checked only by a trained technician.

Fluid And Filter Changes

Refer to the "Maintenance Schedule" for the proper maintenance intervals.

Manual Transmission – If Equipped**Lubricant Selection**

Use only the manufacturers recommended transmission fluid. Refer to "Fluids, Lubricants, and Genuine Parts" in "Maintaining Your Vehicle" for further information.

Fluid Level Check

Check the fluid level by removing the fill plug. The fluid level should be between the bottom of the fill hole and a point not more than 3/16 in (4.7 mm) below the bottom of the hole.

Add fluid, if necessary, to maintain the proper level.

Frequency Of Fluid Change

Under normal operating conditions, the fluid installed at the factory will give satisfactory lubrication for the life of

the vehicle. Fluid changes are not necessary unless lubricant has become contaminated with water.

NOTE: If contaminated with water, the fluid should be changed immediately.

Appearance Care And Protection From Corrosion

Protection Of Body And Paint From Corrosion

Vehicle body care requirements vary according to geographic locations and usage. Chemicals that make roads passable in snow and ice and those that are sprayed on trees and road surfaces during other seasons, are highly corrosive to the metal in your vehicle. Outside parking, which exposes your vehicle to airborne contaminants, road surfaces on which the vehicle is operated, extreme hot or cold weather and other extreme conditions will have an adverse effect on paint, metal trim, and underbody protection.

The following maintenance recommendations will enable you to obtain maximum benefit from the corrosion resistance built into your vehicle.

What Causes Corrosion?

Corrosion is the result of deterioration or removal of paint and protective coatings from your vehicle.

The most common causes of corrosion are:

- Road salt, dirt and moisture accumulation.
- Stone and gravel impact.
- Insects, tree sap and tar.
- Salt in the air near sea coast localities.
- Atmospheric fallout/industrial pollutants.

Washing

- Wash your vehicle regularly. Always wash your vehicle in the shade using MOPAR® Car Wash or a mild car wash soap, and rinse the panels completely with clear water.
- If insects, tar or other similar deposits have accumulated on your vehicle, use MOPAR® Super Kleen Bug and Tar Remover or equivalent to remove.
- Use a high quality cleaner wax, such as MOPAR® Cleaner Wax or equivalent to remove road film, stains and to protect your paint finish. Take care never to scratch the paint.
- Avoid using abrasive compounds and power buffing that may diminish the gloss or thin out the paint finish.

CAUTION!

- Do not use abrasive or strong cleaning materials such as steel wool or scouring powder, which will scratch metal and painted surfaces.
- Use of power washers exceeding 1,200 psi (8 274 kPa) can result in damage or removal of paint and decals.

Special Care

- If you drive on salted or dusty roads or if you drive near the ocean, hose off the undercarriage at least once a month.
- It is important that the drain holes in the lower edges of the doors, rocker panels and trunk be kept clear and open.

- If you detect any stone chips or scratches in the paint, touch them up immediately. The cost of such repairs is considered the responsibility of the owner.
- If your vehicle is damaged due to a collision or similar cause which destroys the paint and protective coating, have your vehicle repaired as soon as possible. The cost of such repairs is considered the responsibility of the owner.
- If you carry special cargo such as chemicals, fertilizers, de-icer salt, etc., be sure that such materials are well packaged and sealed.
- If a lot of driving is done on gravel roads, consider mud or stone shields behind each wheel.
- Use MOPAR® Touch Up Paint or equivalent on scratches as soon as possible. Your authorized dealer has touch up paint to match the color of your vehicle.

Wheel And Wheel Trim Care

All wheels and wheel trim, especially aluminum and chrome-plated wheels, should be cleaned regularly with a mild soap and water to prevent corrosion. To remove heavy soil, use MOPAR® Wheel Cleaner or select a nonabrasive, non-acidic cleaner. Do not use scouring pads, steel wool, a bristle brush or metal polishes. Only MOPAR® cleaners or equivalent are recommended. Do not use oven cleaner. Avoid automatic car washes that use acidic solutions or harsh brushes that may damage the wheels' protective finish.

Stain Repel Fabric Cleaning Procedure – If Equipped

Stain Repel seats may be cleaned in the following manner:

- Remove as much of the stain as possible by blotting with a clean, dry towel.
- Blot any remaining stain with a clean, damp towel.

- For tough stains, apply MOPAR® Total Clean or a mild soap solution to a clean, damp cloth and remove the stain. Use a fresh, damp towel to remove soap residue.
- For grease stains, apply MOPAR® Multi-Purpose Cleaner or a high quality cleaner, to a clean, damp cloth and remove the stain. Use a fresh, damp towel to remove soap residue.
- Do not use any harsh solvents or any other form of protectants on Stain Repel products.

Interior Care

Use MOPAR® Total Clean or equivalent to clean fabric upholstery and carpeting.

Use MOPAR® Total Clean or equivalent to clean vinyl upholstery.

MOPAR® Total Clean or equivalent is specifically recommended for leather upholstery.

Your leather upholstery can be best preserved by regular cleaning with a damp, soft cloth. Small particles of dirt can act as an abrasive and damage the leather upholstery and should be removed promptly with a damp cloth. Stubborn soils can be removed easily with a soft cloth and MOPAR® Total Clean or equivalent. Care should be taken to avoid soaking your leather upholstery with any liquid. Please do not use polishes, oils, cleaning fluids, solvents, detergents, or ammonia based cleaners to clean your leather upholstery. Application of a leather conditioner is not required to maintain the original condition.

WARNING!

Do not use volatile solvents for cleaning purposes. Many are potentially flammable, and if used in closed areas, they may cause respiratory harm.

Cleaning Headlights

Your vehicle has plastic headlights that are lighter and less susceptible to stone breakage than glass headlights.

Plastic is not as scratch resistant as glass and, therefore, different lens cleaning procedures must be followed.

To minimize the possibility of scratching the lenses and reducing light output, avoid wiping with a dry cloth. To remove road dirt, wash with a mild soap solution followed by rinsing.

Do not use abrasive cleaning components, solvents, steel wool or other aggressive material to clean the lenses.

Glass Surfaces

All glass surfaces should be cleaned on a regular basis with MOPAR® Glass Cleaner or any commercial household-type glass cleaner. Never use an abrasive type cleaner. Use caution when cleaning the inside rear window equipped with electric defrosters or the right rear quarter window equipped with the radio antenna. Do not use scrapers or other sharp instruments which may scratch the elements. When cleaning the rearview mirror, spray cleaner on the towel or rag that you are using. Do not spray cleaner directly on the mirror.

Instrument Panel Cover

The instrument panel cover has a low glare surface which minimizes reflections on the windshield. Do not use protectants or other products which may cause undesirable reflections. Use soap and warm water to restore the low glare surface.

Instrument Panel Bezels

CAUTION!

When installing hanging air fresheners in your vehicle, read the installation instructions carefully. Some air fresheners will damage the finish of painted or decorated parts if allowed to directly contact any surface.

Cleaning Plastic Instrument Cluster Lenses

The lenses in front of the instruments in this vehicle are molded in clear plastic. When cleaning the lenses, care must be taken to avoid scratching the plastic.

1. Clean with a wet, soft rag. A mild soap solution may be used, but do not use high alcohol content or abrasive cleaners. If soap is used, wipe clean with a clean, damp rag.
2. Dry with a soft cloth.

Seat Belt Maintenance

Do not bleach, dye or clean the seat belts with chemical solvents or abrasive cleaners. This will weaken the fabric. Sun damage can also weaken the fabric.

If the seat belts need cleaning, use a mild soap solution or lukewarm water. Do not remove the seat belts from the car to wash them. Dry with a soft cloth.

Replace the seat belts if they appear frayed or worn or if the buckles do not work properly.

FUSES

Integrated Power Module

The Integrated Power Module is located in the engine compartment near the air cleaner assembly. This center contains cartridge fuses and mini-fuses. A label that identifies each component may be printed on the inside of the cover. Refer to “Engine Compartment” in “Maintaining Your Vehicle” for further information.

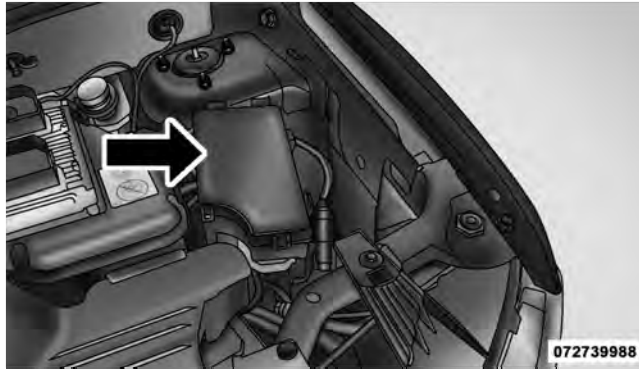

Integrated Power Module

Cavity	Cartridge Fuse	Mini-Fuse	Description
1	Empty		Empty
2		15 Amp Lt Blue	AWD/4WD Control Module

Cavity	Cartridge Fuse	Mini-Fuse	Description
3		10 Amp Red	Rear Center Brake Light Switch
4		10 Amp Red	Ignition Switch/ Occupant Classification Module
5		20 Amp Yellow	Trailer Tow
6		10 Amp Red	Power Mirror/ Steering Control Satellite Radio/Hands-Free Phone
7		30 Amp Green	Ignition Off Draw
8		30 Amp Green	Ignition Off Draw
9	40 Amp Green		Power Seats

Cavity	Cartridge Fuse	Mini-Fuse	Description
10		20 Amp Yellow	Power Locks/Interior Lighting
11		15 Amp Lt Blue	Power Outlet
12		20 Amp Yellow	115V AC Inverter
13		20 Amp Yellow	Cigar Lighter
14		10 Amp Red	Instrument Cluster
15	40 Amp Green		Radiator Fan
16		15 Amp Lt Blue	Dome Lamp/ Sunroof/Rear Wiper Motor
17		10 Amp Red	Wireless Control Module

Cavity	Cartridge Fuse	Mini-Fuse	Description
18	40 Amp Green		Auto Shutdown Relay
19		20 Amp Yellow	Radio Amplifiers
20		15 Amp Lt Blue	Radio
21		10 Amp Red	Intrusion Module/ Siren – If Equipped
22		10 Amp Red	Heating, AC/ Compass
23		15 Amp Lt Blue	Auto Shutdown Relay
24		15 Amp Lt Blue	Power Sunroof
25		10 Amp Red	Heated Mirror – If Equipped

Cavity	Cartridge Fuse	Mini-Fuse	Description
26		15 Amp Lt Blue	Auto Shutdown Relay
27		10 Amp Red	Airbag Control Module
28		10 Amp Red	Airbag Control Module/Occupant Classification Module
29			Hot Car (No Fuse Required)
30		20 Amp Yellow	Heated Seat – If Equipped
31		10 Amp Red	Headlamp Washer – If Equipped
32	30 Amp Pink		Auto Shutdown Relay

Cavity	Cartridge Fuse	Mini-Fuse	Description
33		10 Amp Red	J1962 Conn/ Powertrain Control Module
34	30 Amp Pink		Antilock Brake Valve
35	40 Amp Green		Antilock Brake Pump
36	30 Amp Pink		Headlamp/Washer Control/Smart Glass – If Equipped
37		25 Amp Natural	Diesel Fuel Heater – If Equipped

CAUTION!

- When installing the IPM cover, it is important to ensure the cover is properly positioned and fully latched. Failure to do so may allow water to get into the IPM, and possibly result in an electrical system failure.
- When replacing a blown fuse, it is important to use only a fuse having the correct amperage rating. The use of a fuse with a rating other than indicated may result in a dangerous electrical system overload. If a properly rated fuse continues to blow, it indicates a problem in the circuit that must be corrected.

VEHICLE STORAGE

If you will not be using your vehicle for more than 21 days, you may want to take steps to preserve your battery.

- Disengage the mini-fuse in the Power Distribution Center labeled IOD (Ignition Off-Draw).
- Or disconnect the negative cable from the battery.
- Anytime you store your vehicle, or keep it out of service (i.e., vacation) for two weeks or more, run the air conditioning system at idle for about five minutes in the fresh air and high blower setting. This will ensure adequate system lubrication to minimize the possibility of compressor damage when the system is started again.

REPLACEMENT BULBS

All the inside bulbs are brass or glass wedge base. Aluminum base bulbs are not approved and should not be used for replacement.

LIGHT BULBS – Interior	Bulb Number
Front Header Lamp	T578
Center Dome Lamp	T578
Rear Cargo/Flashlight	8–A35LF

LIGHTS BULBS – Exterior	Bulb Number
Low Beam/High Beam Headlamp	H13
Front Park/Turn Signal/Side Marker Lamp . . .	3157AK
Front Fog Lamp	PSX24W
Center High-Mounted Stop Lamp (CHMSL)	LED Assembly
Rear Tail/Stop Lamp	3157
Rear Turn Signal Lamp	3757AK
Backup Lamp	921 W16W
License Lamp	W5W

BULB REPLACEMENT

Front Headlamps, Parking, and Turn Signal Lamps

NOTE: The headlamp bulb can be accessed from under the hood without the removal of the inner fender well. It will be necessary to remove the inner fender well to service the park/turn signal bulb that is located toward the outboard side of the head lamp unit.

1. Disconnect and isolate the negative battery cable.
2. Working in the appropriate wheel well, loosen the front of the splash shield, but do not fully remove it.

3. Looking up through the front wheel well, locate the bulb which needs replacing. The headlamp bulb is the inboard bulb and the park/turn signal bulb is the outboard bulb.

4. Disconnect the bulb electrical connector.

5. Grasp the bulb, twist 1/4 turn counterclockwise and pull straight out of front lamp unit.

Fog Lamps

CAUTION!

Do not contaminate the bulb glass by touching it with your fingers or by allowing it to contact other oily surfaces. Shortened bulb life will result.

1. Disconnect and isolate the negative battery cable.

2. Remove the front wheel and tire on the same side of the vehicle as the fog lamp being serviced. Refer to "Jacking and Tire Changing" in "What To Do In Emergencies" for further information.

3. Remove the three screws that secure the outboard side of the front wheel house splash shield to the front fascia.

4. Remove the push pin fastener that secures the inboard side of the splash shield to the front end sheet metal.

5. Remove the two push pin fasteners that secure the forward edge of the splash shield to the front fascia closure panel.

6. Fold the front of the splash shield rearward far enough to access the back of the front fascia.
7. From behind the front fascia disconnect the engine compartment wire harness connector from the front fog lamp bulb connector receptacle.
8. Firmly grasp the bulb by the two latch features and squeeze them together to unlock the bulb from the back of the front fog lamp housing.
9. Pull the bulb straight out from the keyed opening in the housing.

Rear Tail, Turn Signal, and Backup Lamps

1. Remove the two push-pins from the tail lamp housing.

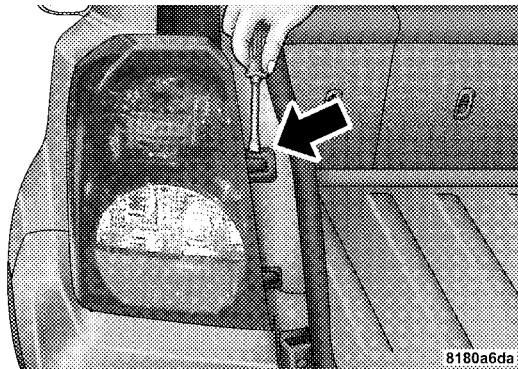

2. Grasp the tail lamp and pull firmly to disengage the lamp from the aperture panel.

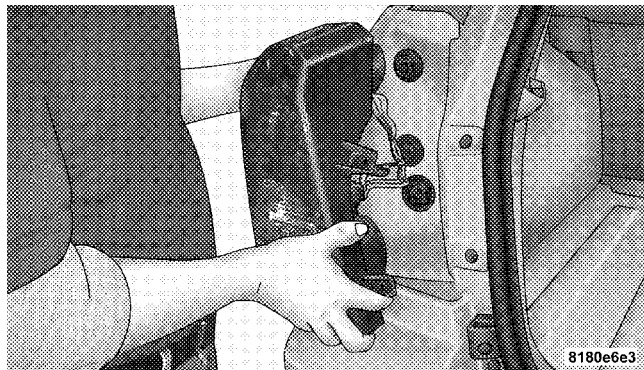

NOTE: It is not necessary to completely remove the tail lamp unit. Once loosened from the quarter panel, there should be enough room to service any of the bulbs.

3. Disconnect the electrical connector from the bulb.

4. Twist and remove socket from the lamp.

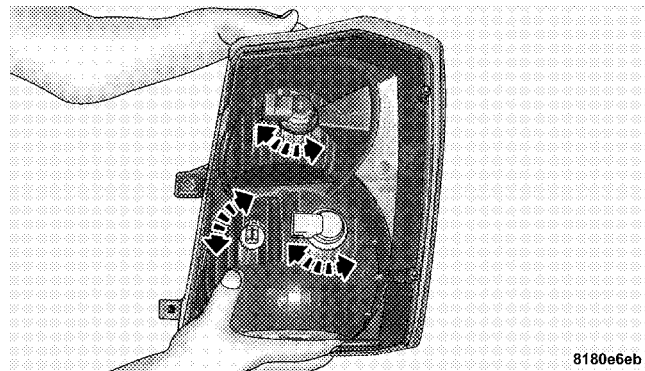

5. Remove the bulb from the socket and replace.

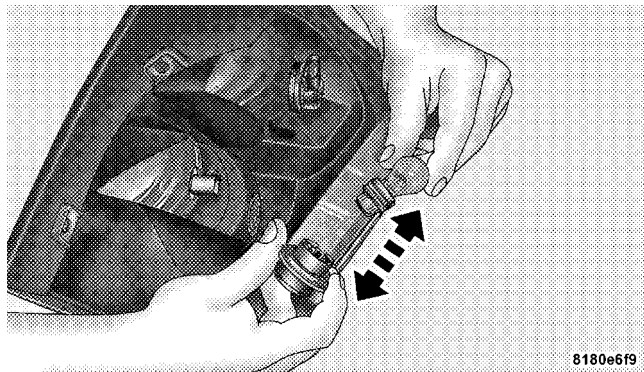

License Lamps

1. Using a trim stick or equivalent, gently pry on the side of the license plate lamp to release it from the liftgate.

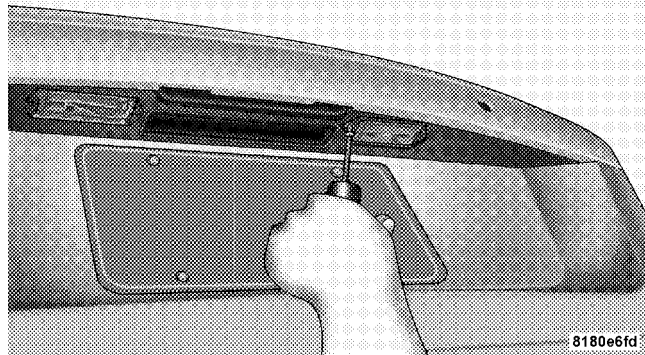

2. Rotate the socket 1/4 turn counterclockwise and remove from the lamp.

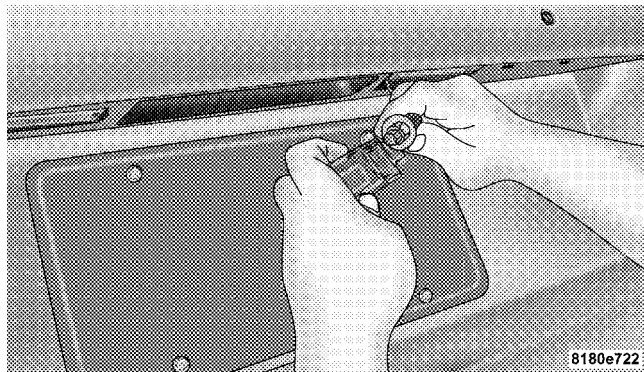

3. Pull the bulb from the socket.

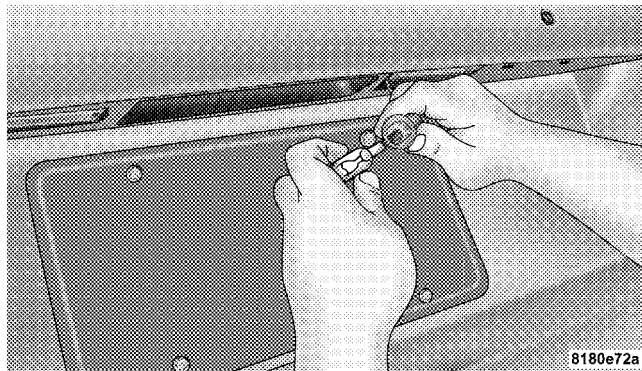

Center High-Mounted Stoplamp

The lamp is an LED assembly. See your authorized dealer for replacement.

FLUID CAPACITIES

	U.S.	Metric
Fuel (Approximate)	13.6 Gallons	51.5 Liters
Engine Oil with Filter		
2.0L and 2.4L Engine (SAE 5W-20, API Certified)	4.5 Quarts	4.26 Liters
Cooling System *		
2.0L and 2.4L Engine (MOPAR® Engine Coolant/Antifreeze 5 Year/100,000 Mile Formula or equivalent)	7.2 Quarts	6.8 Liters
* Includes heater and coolant recovery bottle filled to MAX level.		

FLUIDS, LUBRICANTS, AND GENUINE PARTS**Engine**

Component	Fluid, Lubricant, or Genuine Part
Engine Coolant	MOPAR® Antifreeze/Coolant 5 Year/100,000 Mile Formula HOAT (Hybrid Organic Additive Technology) or equivalent.
Engine Oil	Use API Certified SAE 5W-20 Engine Oil, meeting the requirements of Chrysler Material Standard MS-6395. Refer to your engine oil filler cap for correct SAE grade.
Engine Oil Filter	MOPAR® Engine Oil Filter or equivalent.
Spark Plugs	ZFR5F-11 (Gap 0.043 in [1.1 mm])
Fuel Selection	87 Octane

Chassis

Component	Fluid, Lubricant, or Genuine Part
Automatic Transmission (CVT) – If Equipped	MOPAR® CVTF + 4®
Manual Transmission – If Equipped	MOPAR® ATF+4® Automatic Transmission Fluid or equivalent licensed ATF+4® product.
Brake Master Cylinder	MOPAR® DOT 3, SAE J1703 should be used. If DOT 3, SAE J1703 brake fluid is not available, then DOT 4 is acceptable. Use only recommended brake fluids or equivalent.
Power Steering Reservoir	MOPAR® Power Steering Fluid +4, MOPAR® ATF+4® Automatic Transmission Fluid or equivalent licensed ATF+4® product.

MAINTENANCE SCHEDULES

CONTENTS

■	Maintenance Schedule	440
□	Required Maintenance Intervals	442

MAINTENANCE SCHEDULE

The Scheduled Maintenance services listed in this manual must be done at the times or mileages specified to protect your vehicle warranty and ensure the best vehicle performance and reliability. More frequent maintenance may be needed for vehicles in severe operating conditions, such as dusty areas and very short trip driving. Inspection and service should also be done anytime a malfunction is suspected.

The oil change indicator system will remind you that it is time to take your vehicle in for scheduled maintenance.

On Electronic Vehicle Information Center (EVIC) equipped vehicles, "Oil Change Required" will be displayed in the EVIC and a single chime will sound, indicating that an oil change is necessary.

On Non-EVIC equipped vehicles, "Change Oil" will flash in the instrument cluster odometer and a single chime will sound, indicating that an oil change is necessary.

Based on engine operation condition, the oil change indicator message will illuminate; this means that service is required for your vehicle. Have your vehicle serviced as soon as possible, within the next 500 miles (805 km).

NOTE:

- The oil change indicator message will not monitor the time since the last oil change. Change your vehicle's oil if it has been six months since your last oil change and even if the oil change indicator message is NOT illuminated.
- Change your engine oil more often if you drive your vehicle off-road for an extended period of time.
- Under no circumstances should oil change intervals exceed 8,000 miles (13 000 km) or six months, whichever comes first.

Your authorized dealer will reset the oil change indicator message after completing the scheduled oil change. If a scheduled oil change is performed by someone other than your authorized dealer, the message can be reset by referring to the steps described under “Electronic Vehicle Information Center (EVIC)/Oil Change Required” in “Understanding Your Instrument Panel” or under “Instrument Cluster Description/Odometer/Trip Odometer” in “Understanding Your Instrument Panel” for further information.

At Each Stop For Fuel

- Check the engine oil level about five minutes after a fully warmed engine is shut off. Checking the oil level while the vehicle is on level ground will improve the accuracy of the oil level reading. Add oil only when the level is at or below the ADD or MIN mark.
- Check the windshield washer solvent and add if required.

Once A Month

- Check the tire pressure and look for unusual wear or damage.
- Inspect the battery and clean and tighten the terminals as required.
- Check the fluid levels of coolant reservoir, brake master cylinder, power steering and transmission and add as needed.
- Check all lights and other electrical items for correct operation.

At Each Oil Change

- Change the engine oil filter.
- Inspect the brake hoses and lines.
- Check the manual transmission fluid level.

CAUTION!

Failure to perform the required maintenance items may result in damage to the vehicle.

Required Maintenance Intervals

Refer to the Maintenance Schedules on the following pages for the required maintenance intervals.

8,000 Miles (13,000 km) or 6 Months Maintenance Service Schedule

- Change the engine oil and engine oil filter.
- Rotate the tires, rotate at the first sign of irregular wear, even if it occurs before 8,000 miles (13 000 km).

Odometer Reading Date

Repair Order # Dealer Code

Signature, Authorized Service Center

16,000 Miles (26,000 km) or 12 Months Maintenance Service Schedule

- Change the engine oil and engine oil filter.
- Rotate the tires, rotate at the first sign of irregular wear, even if it occurs before 16,000 miles (26 000 km).
- If using your vehicle for any of the following: Dusty or off-road conditions. Inspect the engine air cleaner filter; replace if necessary.
- Replace the air conditioning filter.
- Inspect the brake linings, replace if necessary.
- Inspect exhaust system. Perform the first inspection at 16,000 miles (26 000 km) or 12 months.
- Inspect the front suspension, tie rod ends and boot seals for cracks or leaks and all parts for damage, wear, improper looseness or end play; replace if necessary.

Odometer Reading Date

Repair Order # Dealer Code

Signature, Authorized Service Center

24,000 Miles (39,000 km) or 18 Months Maintenance Service Schedule

- Change the engine oil and engine oil filter.
- Rotate the tires, rotate at the first sign of irregular wear, even if it occurs before 24,000 miles (39 000 km).
- Inspect the CV joints.
- Inspect exhaust system.

 Odometer Reading Date

 Repair Order # Dealer Code

 Signature, Authorized Service Center

32,000 Miles (52,000 km) or 24 Months Maintenance Service Schedule

- Change the engine oil and engine oil filter.
- Rotate the tires, rotate at the first sign of irregular wear, even if it occurs before 32,000 miles (52 000 km).
- Replace the engine air cleaner filter.
- Replace the spark plugs.
- Replace the air conditioning filter.
- Adjust parking brake on vehicles equipped with four-wheel disc brakes.
- Inspect the brake linings, replace if necessary.
- Inspect the front suspension, tie rod ends and boot seals for cracks or leaks and all parts for damage, wear, improper looseness or end play; replace if necessary.

 Odometer Reading Date

 Repair Order # Dealer Code

 Signature, Authorized Service Center

40,000 Miles (65,000 km) or 30 Months Maintenance Service Schedule

- Change the engine oil and engine oil filter.
- Rotate the tires, rotate at the first sign of irregular wear, even if it occurs before 40,000 miles (65 000 km).

Odometer Reading Date

Repair Order # Dealer Code

Signature, Authorized Service Center

48,000 Miles (78,000 km) or 36 Months Maintenance Service Schedule

- Change the engine oil and engine oil filter.
- Rotate the tires, rotate at the first sign of irregular wear, even if it occurs before 48,000 miles (78 000 km).
- If using your vehicle for any of the following: Dusty or off-road conditions. Inspect the engine air cleaner filter; replace if necessary.
- Replace the air conditioning filter.
- Inspect the brake linings, replace if necessary.
- Inspect the CV joints.
- Inspect exhaust system.
- Inspect the front suspension, tie rod ends and boot seals for cracks or leaks and all parts for damage, wear, improper looseness or end play; replace if necessary.
- Change the manual transmission fluid if using your vehicle for any of the following: trailer towing, heavy loading, taxi, police, delivery service (commercial service), off-road, desert operation or more than 50% of your driving is at sustained speeds during hot weather, above 90°F (32°C).

Odometer Reading Date

Repair Order # Dealer Code

Signature, Authorized Service Center

56,000 Miles (91,000 km) or 42 Months Maintenance Service Schedule

- Change the engine oil and engine oil filter.
- Rotate the tires, rotate at the first sign of irregular wear, even if it occurs before 56,000 miles (91 000 km).

 Odometer Reading Date

 Repair Order # Dealer Code

 Signature, Authorized Service Center

64,000 Miles (104,000 km) or 48 Months Maintenance Service Schedule

- Change the engine oil and engine oil filter.
- Rotate the tires, rotate at the first sign of irregular wear, even if it occurs before 64,000 miles (104 000 km).
- Replace the engine air cleaner filter.
- Replace the air conditioning filter.
- Inspect the brake linings; replace if necessary.
- Replace the spark plugs.
- Adjust parking brake on vehicles equipped with four-wheel disc brakes.
- Change the automatic transmission fluid and filter if using your vehicle for any of the following: police, taxi, fleet, or frequent trailer towing.
- Inspect the front suspension, tie rod ends and boot seals for cracks or leaks and all parts for damage, wear, improper looseness or end play; replace if necessary.

 Odometer Reading Date

 Repair Order # Dealer Code

 Signature, Authorized Service Center

72,000 Miles (117,000 km) or 54 Months Maintenance Service Schedule

- Change the engine oil and engine oil filter.
- Rotate the tires, rotate at the first sign of irregular wear, even if it occurs before 72,000 miles (117 000 km).
- Inspect the CV joints.
- Inspect exhaust system.

Odometer Reading Date

Repair Order # Dealer Code

Signature, Authorized Service Center

80,000 Miles (130,000 km) or 60 Months Maintenance Service Schedule

- Change the engine oil and engine oil filter.
- Rotate the tires, rotate at the first sign of irregular wear, even if it occurs before 80,000 miles (130 000 km).
- If using your vehicle for any of the following: Dusty or off-road conditions. Inspect the engine air cleaner filter; replace if necessary.
- Replace the air conditioning filter.
- Flush and replace the engine coolant if not done at 104,000 miles (169 000 km).
- Inspect the brake linings, replace if necessary.
- Inspect the front suspension, tie rod ends and boot seals for cracks or leaks and all parts for damage, wear, improper looseness or end play; replace if necessary.

Odometer Reading Date

Repair Order # Dealer Code

Signature, Authorized Service Center

**88,000 Miles (143,000 km) or
66 Months Maintenance
Service Schedule**

- Change the engine oil and engine oil filter.
- Rotate the tires, rotate at the first sign of irregular wear, even if it occurs before 88,000 miles (143 000 km).

Odometer Reading Date

Repair Order # Dealer Code

Signature, Authorized Service Center

96,000 Miles (156,000 km) or 72 Months Maintenance Service Schedule

- Change the engine oil and engine oil filter.
- Rotate the tires, rotate at the first sign of irregular wear, even if it occurs before 96,000 miles (156 000 km).
- Replace the engine air cleaner filter.
- Replace the spark plugs.
- Inspect and replace PCV valve if necessary.†
- Replace the air conditioning filter.
- Adjust parking brake on vehicles equipped with four-wheel disc brakes.
- Inspect the brake linings, replace if necessary.
- Inspect the CV joints.
- Inspect exhaust system.
- Inspect the front suspension, tie rod ends and boot seals for cracks or leaks and all parts for damage, wear, improper looseness or end play; replace if necessary.
- Change the manual transmission fluid if using your vehicle for any of the following: trailer towing, heavy loading, taxi, police, delivery service (commercial service), off-road, desert operation or more than 50% of your driving is at sustained speeds during hot weather, above 90°F (32°C).

_____ Date

_____ Dealer Code

_____ Signature, Authorized Service Center

104,000 Miles (169,000 km) or 78 Months Maintenance Service Schedule

- Change the engine oil and engine oil filter.
- Rotate the tires, rotate at the first sign of irregular wear, even if it occurs before 104,000 miles (169 000 km).
- Flush and replace engine coolant at 104,000 miles (169,00 km) or 60 months (whichever occurs first).

Odometer Reading Date

Repair Order # Dealer Code

Signature, Authorized Service Center

112,000 Miles (182,000 km) or 84 Months Maintenance Service Schedule

- Change the engine oil and engine oil filter.
- Rotate the tires, rotate at the first sign of irregular wear, even if it occurs before 112,000 miles (182 000 km).
- If using your vehicle for any of the following: Dusty or off-road conditions. Inspect the engine air cleaner filter; replace if necessary.
- Replace the air conditioning filter.
- Inspect the brake linings, replace if necessary.
- Inspect the front suspension, tie rod ends and boot seals for cracks or leaks and all parts for damage, wear, improper looseness or end play; replace if necessary.

Odometer Reading Date

Repair Order # Dealer Code

Signature, Authorized Service Center

120,000 Miles (195,000 km) or 90 Months Maintenance Service Schedule

- Change the engine oil and engine oil filter.
- Rotate the tires, rotate at the first sign of irregular wear, even if it occurs before 120,000 miles (195 000 km).
- Inspect the CV joints.
- Inspect exhaust system.
- Change the automatic transmission fluid and filter(s).
- Replace the accessory drive belt(s).

Odometer Reading Date

Repair Order # Dealer Code

Signature, Authorized Service Center

128,000 Miles (208,000 km) or 96 Months Maintenance Service Schedule

- Change the engine oil and engine oil filter.
- Rotate the tires, rotate at the first sign of irregular wear, even if it occurs before 128,000 miles (208 000 km).
- Replace the engine air cleaner filter.
- Replace the spark plugs.
- Replace the air conditioning filter.
- Adjust parking brake on vehicles equipped with four-wheel disc brakes.
- Inspect the brake linings, replace if necessary.
- Inspect the front suspension, tie rod ends and boot seals for cracks or leaks and all parts for damage, wear, improper looseness or end play; replace if necessary.

Odometer Reading Date

Repair Order # Dealer Code

Signature, Authorized Service Center

136,000 Miles (221,000 km) or 102 Months Maintenance Service Schedule

- Change the engine oil and engine oil filter.
- Rotate the tires, rotate at the first sign of irregular wear, even if it occurs before 136,000 miles (221 000 km).

Odometer Reading Date

Repair Order # Dealer Code

Signature, Authorized Service Center

144,000 Miles (234,000 km) or 108 Months Maintenance Service Schedule

- Change the engine oil and engine oil filter.
- Rotate the tires, rotate at the first sign of irregular wear, even if it occurs before 144,000 miles (234 000 km).
- If using your vehicle for any of the following: Dusty or off-road conditions. Inspect the engine air cleaner filter; replace if necessary.
- Replace the air conditioning filter.
- Inspect the brake linings, replace if necessary.
- Inspect the CV joints.
- Inspect exhaust system.
- Inspect the front suspension, tie rod ends and boot seals for cracks or leaks and all parts for damage, wear, improper looseness or end play; replace if necessary.
- Change the manual transmission fluid if using your vehicle for any of the following: trailer towing, heavy loading, taxi, police, delivery service (commercial service), off-road, desert operation or more than 50% of your driving is at sustained speeds during hot weather, above 90°F (32°C).

Odometer Reading Date

Repair Order # Dealer Code

Signature, Authorized Service Center

**152,000 Miles (247,000 km) or
114 Months Maintenance
Service Schedule**

- Change the engine oil and engine oil filter.
- Rotate the tires, rotate at the first sign of irregular wear, even if it occurs before 152,000 miles (247 000 km).

Odometer Reading

Date

Repair Order #

Dealer Code

Signature, Authorized Service Center

454 MAINTENANCE SCHEDULES

† This maintenance is recommended by the manufacturer to the owner, but is not required to maintain emissions warranty.

WARNING!

- You can be badly injured working on or around a motor vehicle. Do only service work for which you have the knowledge and the right equipment. If you have any doubt about your ability to perform a service job, take your vehicle to a competent mechanic.
- Failure to properly inspect and maintain your vehicle could result in a component malfunction and effect vehicle handling and performance. This could cause an accident.

IF YOU NEED CONSUMER ASSISTANCE

CONTENTS

■ Suggestions For Obtaining Service For Your Vehicle.	457	□ Customer Assistance For The Hearing Or Speech Impaired (TDD/TTY)	459
□ Prepare For The Appointment	457	□ Service Contract	459
□ Prepare A List	457	■ Warranty Information	460
□ Be Reasonable With Requests	457	■ MOPAR® Parts	460
■ If You Need Assistance	457	■ Reporting Safety Defects	460
□ Chrysler Group LLC Customer Center	458	□ In The 50 United States And Washington, D.C.	460
□ Chrysler Canada Inc. Customer Center	458	□ In Canada	461
□ In Mexico Contact	458	■ Publication Order Forms	461

■ Department Of Transportation Uniform Tire	
Quality Grades	463
□ Treadwear	463
□ Traction Grades	463
□ Temperature Grades	464

SUGGESTIONS FOR OBTAINING SERVICE FOR YOUR VEHICLE

Prepare For The Appointment

If you're having warranty work done, be sure to have the right papers with you. Take your warranty folder. All work to be performed may not be covered by the warranty. Discuss additional charges with the service manager. Keep a maintenance log of your vehicle's service history. This can often provide a clue to the current problem.

Prepare A List

Make a written list of your vehicle's problems or the specific work you want done. If you've had an accident or work done that is not on your maintenance log, let the service advisor know.

Be Reasonable With Requests

If you list a number of items and you must have your vehicle by the end of the day, discuss the situation with

the service advisor and list the items in order of priority. At many authorized dealers, you may obtain a rental vehicle at a minimal daily charge. If you need a rental, it is advisable to make these arrangements when you call for an appointment.

IF YOU NEED ASSISTANCE

The manufacturer and its authorized dealers are vitally interested in your satisfaction. We want you to be happy with our products and services.

Warranty service must be done by an authorized dealer. We strongly recommend that you take the vehicle to an authorized dealer. They know your vehicle the best, and are most concerned that you get prompt and high quality service. The manufacturer's authorized dealers have the facilities, factory-trained technicians, special tools, and the latest information to ensure the vehicle is fixed correctly and in a timely manner.

This is why you should always talk to an authorized dealer's service manager first. Most matters can be resolved with this process.

- If for some reason you are still not satisfied, talk to the general manager or owner of the authorized dealership. They want to know if you need assistance.
- If an authorized dealership is unable to resolve the concern, you may contact the manufacturer's customer center.

Any communication to the manufacturer's customer center should include the following information:

- Owner's name and address
- Owner's telephone number (home and office)
- Authorized dealership name
- Vehicle Identification Number (VIN)
- Vehicle delivery date and mileage

Chrysler Group LLC Customer Center

P.O. Box 21-8004

Auburn Hills, MI 48321-8004

Phone: (800) 423-6343

Chrysler Canada Inc. Customer Center

P.O. Box 1621

Windsor, Ontario N9A 4H6

Phone: (800) 465-2001 English / (800) 387-9983 French

In Mexico contact:

Av. Prolongacion Paseo de la Reforma, 1240

Sante Fe C.P. 05109

Mexico, D. F.

In Mexico City: 5081-7568

Outside Mexico City: 1-800-505-1300

Customer Assistance For The Hearing Or Speech Impaired (TDD/TTY)

To assist customers who have hearing difficulties, the manufacturer has installed special TDD (Telecommunication Devices for the Deaf) equipment at its customer center. Any hearing or speech impaired customer, who has access to a TDD or a conventional teletypewriter (TTY) in the United States, can communicate with the manufacturer by dialing 1-800-380-CHRY.

Canadian residents with hearing difficulties that require assistance can use the special needs relay service offered by Bell Canada. For TTY teletypewriter users, dial 711 and for Voice callers, dial 1 800 855-0511 to connect with a Bell Relay Service operator.

Service Contract

You may have purchased a service contract for a vehicle to help protect you from the high cost of unexpected repairs after the manufacturer's New Vehicle Limited Warranty expires. The manufacturer stands behind only

the manufacturer's service contracts. If you purchased a manufacturer's service contract, you will receive Plan Provisions and an Owner Identification Card in the mail within three weeks of the vehicle delivery date. If you have any questions about the service contract, call the manufacturer's Service Contract National Customer Hotline at 1-800-521-9922 (Canadian residents, call (800) 465-2001 English / (800) 387-9983 French).

The manufacturer will not stand behind any service contract that is not the manufacturer's service contract. It is not responsible for any service contract other than the manufacturer's service contract. If you purchased a service contract that is not a manufacturer's service contract, and you require service after the manufacturer's New Vehicle Limited Warranty expires, please refer to the contract documents, and contact the person listed in those documents.

We appreciate that you have made a major investment when you purchased the vehicle. An authorized dealer has also made a major investment in facilities, tools, and training to assure that you are absolutely delighted with the ownership experience. You'll be pleased with their sincere efforts to resolve any warranty issues or related concerns.

WARNING!

Engine exhaust, some of its constituents, and certain vehicle components contain, or emit, chemicals known to the State of California to cause cancer and birth defects, or other reproductive harm. In addition, certain fluids contained in vehicles and certain products of component wear contain, or emit, chemicals known to the State of California to cause cancer and birth defects, or other reproductive harm.

WARRANTY INFORMATION

See the Warranty Information Booklet, located on the DVD, for the terms and provisions of Chrysler Group LLC warranties applicable to this vehicle and market.

MOPAR® PARTS

MOPAR® fluids, lubricants, parts, and accessories are available from an authorized dealer. They are recommended for your vehicle in order to help keep the vehicle operating at its best.

REPORTING SAFETY DEFECTS

In the 50 United States and Washington, D.C.

If you believe that your vehicle has a defect that could cause a crash or cause injury or death, you should immediately inform the National Highway Traffic Safety Administration (NHTSA) in addition to notifying the manufacturer.

If NHTSA receives similar complaints, it may open an investigation, and if it finds that a safety defect exists in a group of vehicles, it may order a recall and remedy campaign. However, NHTSA cannot become involved in individual problems between you, your authorized dealer, and the manufacturer.

To contact NHTSA, you may either call the Auto Safety Hotline toll free at 1-888-327-4236 (TTY: 1-800-424-9153), or go to <http://www.safercar.gov>; or write to: Administrator, NHTSA, 1200 New Jersey Avenue, SE., West Building, Washington, D.C. 20590. You can also obtain other information about motor vehicle safety from <http://www.safercar.gov>.

In Canada

If you believe that your vehicle has a safety defect, you should contact the Customer Service Department immediately. Canadian customers who wish to report a safety defect to the Canadian government should contact Transport Canada, Motor Vehicle Defect Investigations and Recalls at 1-800-333-0510 or go to <http://www.tc.gc.ca/roadsafety/>

PUBLICATION ORDER FORMS

To order the following manuals, you may use either the website or the phone numbers listed below. Visa, Mastercard, American Express, and Discover orders are accepted. If you prefer mailing your payment, please call for an order form.

NOTE: A street address is required when ordering manuals (no P.O. Boxes).

- *Service Manuals*

These comprehensive Service Manuals provide the information that students and professional technicians need in diagnosing/troubleshooting, problem solving, maintaining, servicing, and repairing Chrysler Group LLC vehicles. A complete working knowledge of the vehicle, system, and/or components is written in straightforward language with illustrations, diagrams, and charts.

- *Diagnostic Procedure Manuals*

Diagnostic Procedure Manuals are filled with diagrams, charts and detailed illustrations. These practical manuals make it easy for students and technicians to find and fix problems on computer-controlled vehicle systems and features. They show exactly how to find and correct problems the first time, using step-by-step troubleshooting and drivability procedures, proven diagnostic tests and a complete list of all tools and equipment.

- *Owner's Manuals*

These Owner's Manuals have been prepared with the assistance of service and engineering specialists to acquaint you with specific Chrysler Group LLC vehicles. Included are starting, operating, emergency and maintenance procedures as well as specifications, capabilities and safety tips.

Call toll free at:

- 1-800-890-4038 (U.S.)
- 1-800-387-1143 (Canada)

Or

Visit us on the Worldwide Web at:

- www.techauthority.com

DEPARTMENT OF TRANSPORTATION UNIFORM TIRE QUALITY GRADES

The following tire grading categories were established by the National Highway Traffic Safety Administration. The specific grade rating assigned by the tire's manufacturer in each category is shown on the sidewall of the tires on your vehicle.

All passenger car tires must conform to Federal safety requirements in addition to these grades.

Treadwear

The Treadwear grade is a comparative rating, based on the wear rate of the tire when tested under controlled conditions on a specified government test course. For example, a tire graded 150 would wear one and one-half times as well on the government course as a tire graded 100. The relative performance of tires depends upon the actual conditions of their use, however, and may depart

significantly from the norm due to variations in driving habits, service practices, and differences in road characteristics and climate.

Traction Grades

The Traction grades, from highest to lowest, are AA, A, B, and C. These grades represent the tire's ability to stop on wet pavement, as measured under controlled conditions on specified government test surfaces of asphalt and concrete. A tire marked C may have poor traction performance.

WARNING!

The traction grade assigned to this tire is based on straight-ahead braking traction tests, and does not include acceleration, cornering, hydroplaning, or peak traction characteristics.

Temperature Grades

The temperature grades are A (the highest), B, and C, representing the tire's resistance to the generation of heat and its ability to dissipate heat, when tested under controlled conditions on a specified indoor laboratory test wheel. Sustained high temperature can cause the material of the tire to degenerate and reduce tire life, and excessive temperature can lead to sudden tire failure. The grade C corresponds to a level of performance, which all passenger car tires must meet under the Federal Motor Vehicle Safety Standard No. 109. Grades B and A represent higher levels of performance on the laboratory test wheel, than the minimum required by law.

WARNING!

The temperature grade for this tire is established for a tire that is properly inflated and not overloaded. Excessive speed, under-inflation, or excessive loading, either separately or in combination, can cause heat buildup and possible tire failure.

INDEX

- ABS (Anti-Lock Brake System) 312
- Adding Engine Coolant (Antifreeze) 411
- Adding Fuel 354
- Adding Washer Fluid 406
- Additives, Fuel 352
- Air Cleaner, Engine (Engine Air Cleaner Filter) . . . 402
- Air Conditioner Maintenance 404
- Air Conditioning 275
- Air Conditioning Controls 275
- Air Conditioning Filter 286
- Air Conditioning Refrigerant 404,405
- Air Conditioning System 275,279,404
- Air Conditioning, Operating Tips 287
- Air Pressure, Tires 331
- Airbag 59,69
- Airbag Deployment 70
- Airbag Light 67,73,86,193
- Airbag Maintenance 72
- Airbag, Side 63,66,69
- Airbag, Window (Side Curtain) 64,66,69
- Alarm Light 200
- Alarm System (Security Alarm) 17
- Alterations/Modifications, Vehicle 7
- Antenna, Satellite Radio 232,257
- Anti-Lock Brake System (ABS) 312
- Anti-Lock Warning Light 203
- Anti-Theft Security Alarm (Theft Alarm) 17
- Antifreeze (Engine Coolant) 410,435,436
- Capacities 435
- Disposal 413
- Appearance Care 419
- Assistance Towing 111
- Automatic Dimming Mirror 94
- Automatic Door Locks 29,30
- Automatic Temperature Control (ATC) 279
- Automatic Transaxle 12,293,373,417
- Fluid Level Check 418
- Overheating 373

Selection Of Lubricant	417	Warning Light	194
Special Additives	418	Brake, Parking	308
Automatic Transmission	298	Brake/Transmission Interlock	300
Gear Ranges	300	Brakes	311,415
Autostick	302	Break-In Recommendations, New Vehicle	84
B-Pillar Location	326	Bulb Replacement	429
Battery	403	Bulbs, Light	88,429
Keyless Transmitter Replacement (RKE)	23	Capacities, Antifreeze (Engine Coolant)	435
Belts, Seat	86	Capacities, Fluid	435
Beverage Cooler	182	Caps, Filler	
Body Mechanism Lubrication	405	Fuel	354
Brake Assist System	314	Oil (Engine)	394,401
Brake Fluid	437	Power Steering	308
Brake System	311,415	Car Washes	420
Anti-Lock (ABS)	312,314	Carbon Monoxide Warning	85,353
Master Cylinder	415	Cargo Area Cover	176
Parking	308	Cargo Area Features	175

Cargo Compartment		
Light	175	
Cargo Light	175	
Cargo Load Floor	178	
Cargo Tie-Downs	179	
Cellular Phone	97,274	
Center High Mounted Stop Light	434	
Chains, Tire	339	
Changing A Flat Tire	374	
Chart, Tire Sizing	322	
Check Engine Light (Malfunction Indicator Light)	202,396	
Checking Your Vehicle For Safety	84	
Checks, Safety	84	
Child Restraint	74	
Child Restraint Tether Anchors	78	
Child Safety Locks	31	
Child Seat	79	
Clean Air Gasoline	350	
Cleaning		
Wheels	421	
Climate Control	274	
Clock	218,237,246	
Clutch	415	
Clutch Fluid	415	
Coin Holder	174	
Compact Disc (CD) Maintenance	273	
Compact Spare Tire	334	
Connector		
UCI	260,265	
Universal Consumer Interface (UCI)	260,265	
Console	174	
Contract, Service	459	
Coolant (Antifreeze)	435,436	
Cooler, Beverage	182	
Cooling System	409	
Adding Coolant (Antifreeze)	411	
Coolant Level	410,413	

- Disposal of Used Coolant 413
- Drain, Flush, and Refill 410
- Inspection 413
- Points to Remember 412,414
- Pressure Cap 412
- Selection of Coolant (Antifreeze) 410
- Corrosion Protection 419
- Cruise Light 198
- Cupholders 174
- Customer Assistance 457

- Data Recorder, Event 73
- Dealer Service 398
- Defroster, Rear Window 181
- Defroster, Windshield 87,277,283
- Delay (Intermittent) Wipers 153
- Diagnostic System, Onboard 395
- Dimmer Switch, Headlight 149

- Dipsticks
 - Power Steering 308
- Disposal
 - Antifreeze (Engine Coolant) 413
 - Engine Oil 401
- Door Locks 27
- Door Locks, Automatic 29
- Door Opener, Garage 158
- Downshifting 297
- Driver's Seat Back Tilt 137
- Driving
 - On Slippery Surfaces 303
 - Through Flowing, Rising, or Shallow Standing Water 304
- Electric Remote Mirrors 95
- Electrical Power Outlets 168
- Electronic Brake Control System
 - Anti-Lock Brake System 314

Brake Assist System	314	Oil	399,435,436
Electronic Stability Program	317	Oil Change Interval	400
Traction Control System	315	Oil Filler Cap	394,401
Electronic Speed Control (Cruise Control)	155	Oil Filter	436
Electronic Stability Program (ESP)	317	Oil Selection	400
Electronic Vehicle Information Center (EVIC)	205	Oil Synthetic	401
Emergency, In Case of		Overheating	372
Jacking	374	Temperature Gauge	191
Jump Starting	381	Enhanced Accident Response Feature	70
Towing	388	Ethanol	351
Emission Control System Maintenance	396	Event Data Recorder	73
Engine	394	Exhaust Gas Caution	36,85,353
Block Heater	295	Exhaust System	85,407
Break-In Recommendations	84	Exterior Lights	88
Checking Oil Level	399	Filler Location Fuel	192
Cooling	409	Filters	
Exhaust Gas Caution	85,353	Air Cleaner	402
Fuel Requirements	350	Air Conditioning	286
Jump Starting	381		

Engine Oil	402,436	Fuel	350,436
Flashers	372	Adding	354
Hazard Warning	372	Additives	352
Turn Signal	88,199,431	Capacity	435
Flooded Engine Starting	294	Clean Air	350
Fluid Capacities	435	Ethanol	351
Fluid Leaks	88	Filler Cap (Gas Cap)	192,354
Fluid Level Checks		Filler Door (Gas Cap)	192
Automatic Transaxle	418	Gasoline	350
Power Steering	308	Gauge	192
Fluid, Brake	437	Light	192
Fluids	436	Materials Added	352
Fluids, Lubricants and Genuine Parts	436	Methanol	351
Fog Lights	148,200,430	Octane Rating	350
Folding Rear Seat	142	Requirements	350
Folding Rear Seat (Sedan)	142	Tank Capacity	435
Freeing A Stuck Vehicle	386	Fuel System Caution	355
Front Position Light	429	Fueling	354
		Fuses	424

Garage Door Opener (HomeLink®)	158	Hands-Free Phone (Uconnect™)	97
Gas Cap (Fuel Filler Cap)	354,356,395	Hazard	
Gasoline (Fuel)	435	Driving Through Flowing, Rising, or	
Gasoline, Clean Air	350	Shallow Standing Water	304
Gasoline, Reformulated	350	Hazard Warning Flasher	372
Gauges		Headlights	429
Coolant Temperature	191	Cleaning	423
Fuel	192	High Beam	149
Odometer	196	High Beam/Low Beam Select Switch	149
Tachometer	195	Passing	149
Gear Ranges	300	Replacing	429
Gear Select Lever Override	387	Switch	146
General Information	17,127,349	Heated Mirrors	96
General Maintenance	398	Heated Seats	134
Glass Cleaning	423	Heater	275
Glove Compartment	182	Heater, Engine Block	295
Gross Axle Weight Rating	359	Hill Start Assist	316
Gross Vehicle Weight Rating	357,358		

Hitches	Introduction	4
Trailer Towing	Jack Location	374
HomeLink® (Garage Door Opener) Transmitter	Jack Operation	374,376
Hood Release	Jacking Instructions	376
Ignition	Jump Starting	381
Key	Key-In Reminder	14
Ignition Key Removal	Key, Programming	16
Immobilizer (Sentry Key)	Key, Replacement	15
Infant Restraint	Key, Sentry (Immobilizer)	14
Information Center, Vehicle	Keyless Entry System (Sedan)	18
Inside Rearview Mirror	Keys	12
Instrument Cluster	Lane Change and Turn Signals	431
Instrument Panel and Controls	Lap/Shoulder Belts	41
Instrument Panel Cover	Latches	88
Instrument Panel Lens Cleaning	Hood	144
Integrated Power Module (Fuses)	Lead Free Gasoline	350
Interior Appearance Care		
Intermittent Wipers (Delay Wipers)		

Leaks, Fluid	88	Fog	148,200,430
Life of Tires	337	Headlight Switch	146
Liftgate (Sedan)	35	Headlights	146
Liftgate Window Wiper/Washer	180	High Beam Indicator	204
Light Bulbs	88,429	Instrument Cluster	146
Lights	88,146	License	433
Airbag	67,73,86,193	Lights On Reminder	147
Alarm	200	Low Fuel	192
Anti-Lock	203	Malfunction Indicator (Check Engine)	202
Back-Up	431	Map Reading	150
Brake Assist Warning	319	Oil Pressure	193
Brake Warning	194	Seat Belt Reminder	193
Bulb Replacement	429	Security Alarm (Theft Alarm)	18,200
Cargo	175	Service Engine Soon (Malfunction Indicator)	202
Center Mounted Stop	434	Theft Alarm (Security Alarm)	200
Dimmer Switch, Headlight	146	Tire Pressure Monitoring (TPMS)	201
Electronic Stability Program (ESP) Indicator	319	Traction Control	319
Engine Temperature Warning	193	Turn Signal	88,146,148,431
Exterior	88		

Voltage	192	Fluid Level Check	418
Warning (Instrument Cluster Description) . . .	191	Frequency of Fluid Change	418
Loading Vehicle	356,358	Lubricant Selection	418
Capacities	358	Manual, Service	461
Tires	326	Map/Reading Lights	150
Locks		Master Cylinder (Brakes)	415
Child Protection	31	Methanol	351
Door	27	Mirrors	93
Power Door	28	Automatic Dimming	94
Lubrication, Body	405	Electric Powered	95
Lumbar Support	136	Heated	96
		Outside	95
Maintenance Free Battery	403	Rearview	93
Maintenance Procedures	398	Vanity	96
Maintenance Schedule	440	Modifications/Alterations, Vehicle	7
Maintenance, General	398	Monitor, Tire Pressure System	341
Malfunction Indicator Light (Check Engine) . .	202,396	Mopar Parts	397,460
Manual Transaxle	293,296,418	MTBE/ETBE	351
Downshifting	297	Multi-Function Control Lever	146

New Vehicle Break-In Period	84	Onboard Diagnostic System	395,396
Occupant Restraints	66,70	Opener, Garage Door (HomeLink®)	158
Occupant Restraints (Sedan)	37,63,64,66,69	Operator Manual (Owner's Manual)	4
Octane Rating, Gasoline (Fuel)	350	Overheating, Engine	191,372
Odometer	196	Owner's Manual (Operator Manual)	4,461
Trip	196,198	Paint Care	419
Oil Change Indicator	197	Panic Alarm	22
Oil, Engine	399,435	Parking Brake	308
Capacity	435	Passing Light	149
Change Interval	400	Personal Settings	210
Checking	399	Pets	83
Disposal	401	Phone, Cellular	97
Filter	402	Phone, Hands-Free (Uconnect™)	97
Identification Logo	400	Placard, Tire and Loading Information	326
Materials Added to	401	Power	
Recommendation	400,435	Door Locks	28
Synthetic	401	Mirrors	95
Viscosity	401	Outlet (Auxiliary Electrical Outlet)	168

Steering	307,308	Recreational Towing	370
Sunroof	165	Reformulated Gasoline	350
Windows	33	Refrigerant	405
Power Steering Fluid	437	Reminder, Seat Belt	57
Pregnant Women and Seat Belts	59	Remote Control	
Preparation for Jacking	375	Door Locks	18
Pretensioners		Security Alarm	17
Seat Belts	52	Remote Keyless Entry (Sedan)	18
Programmable Electronic Features	210	Remote Sound System (Radio) Controls	272
Radial Ply Tires	333	Remote Starting System	24
Radio Operation	274	Replacement Bulbs	429
Rear Fog Lights	431	Replacement Keys	15
Rear Liftgate (Sedan)	35	Replacement Parts	397
Rear Seat, Folding	142	Replacement Tires	338
Rear Window Defroster	181	Reporting Safety Defects	460
Rear Window Features	180	Resetting Oil Change Indicator	197
Rear Wiper/Washer	180	Restraints, Child	74,79
Recorder, Event Data	73	Restraints, Infant	75
		Retractable Cargo Area Cover	176

Rotation, Tires	340	Pretensioners	52
Safety Checks Inside Vehicle	86	Rear Seat	41
Safety Checks Outside Vehicle	88	Seat Belts (Sedan)	37
Safety Defects, Reporting	460	Seats	132
Safety Information, Tire	320	Adjustment	135
Safety Tips	84	Heated	134
Safety, Exhaust Gas	85	Lumbar Support	136
Satellite Radio Antenna	232,257	Rear Folding	142
Schedule, Maintenance	440	Rear Folding (Sedan)	142
Seat Belt Maintenance	424	Seatback Release	137
Seat Belt Reminder	57	Tilting	137
Seat Belts	86	Security Alarm (Theft Alarm)	17
Adjustable Shoulder Belt	46	Selection of Oil	400
Adjustable Upper Shoulder Anchorage	46	Sentry Key (Immobilizer)	14
And Pregnant Women	59	Sentry Key Programming	16
Child Restraint	74	Sentry Key Replacement	15
Front Seat	41	Service Assistance	457
Inspection	86	Service Contract	459

Service Engine Soon Light (Malfunction Indicator)	202	Speedometer and Odometer	189
Service Manuals	461	Starting	293
Setting the Clock	218,237,246	Automatic Transmission	293
Settings, Personal	210	Engine Fails to Start	294
Shift Lever Override	387	Manual Transmission	293
Shift Speeds, Manual Transaxle	297	Remote	24
Shoulder Belts	41	Starting Procedures	293
Side Airbag	69	Steering	
Side Window Demisters (Defrosters)	286	Power	307,308
Signals, Turn	88,199,431	Tilt Column	154
Slippery Surfaces, Driving On	303	Steering Wheel Audio Controls	272
Snow Chains (Tire Chains)	339	Steering Wheel Mounted Sound	
Snow Tires	339	System Controls	272
Spare Tire	334,335,375	Storage	428
Specifications		Storage, Vehicle	285
Oil	400	Stuck, Freeing	386
Speed Control (Cruise Control)	155,198	Sun Roof	165
Speedometer	192	Sun Visor Extension	97
		Supplemental Restraint System - Airbag	59

Synthetic Engine Oil	401	Chains	339
System, Remote Starting	24	Changing	374
Tachometer	195	Compact Spare	334
Taillights	431	General Information	330
Temperature Control, Automatic (ATC)	279	High Speed	333
Temperature Gauge, Engine Coolant	191,373	Inflation Pressures	331
Tether Anchor, Child Restraint	78	Jacking	374
Theft Alarm (Security Alarm)	17	Life of Tires	337
Theft System (Security Alarm)	17	Load Capacity	326,327
Tie Down Hooks, Cargo	179	Pressure Monitor System (TPMS)	341
Tilt Steering Column	154	Pressure Warning Light	201
Tire and Loading Information Placard	326	Quality Grading	463
Tire Identification Number (TIN)	324	Radial	333
Tire Markings	320	Replacement	338
Tire Safety Information	320	Rotation	340
Tires	88,330,463	Safety	320,330
Aging (Life of Tires)	337	Sizes	322
Air Pressure	330	Snow Tires	339
		Spare Tire	375

Spinning	336	Transaxle	
Tread Wear Indicators	337	Automatic	12,293,417
Tongue Weight/Trailer Weight	363	Autostick	302
Towing	358	Manual	293,296
24-Hour Towing Assistance	111	Selection of Lubricant	417
Disabled Vehicle	388	Transmission	
Guide	362	Automatic	298
Recreational	370	Range Indicator	196
Weight	362	Transmitter Battery Service	
Towing Assistance	111	(Remote Keyless Entry)	23
Traction	304	Transmitter, Garage Door Opener (HomeLink®) . .	158
Trailer Towing	358	Transporting Pets	83
Cooling System Tips	369	Tread Wear Indicators	337
Hitches	361	Trip Odometer	196
Minimum Requirements	364	Trip Odometer Reset Button	198
Trailer and Tongue Weight	363	Turn Signals	148,199,431
Wiring	367	UCI Connector	260,265
Trailer Towing Guide	362	Uconnect™ (Hands-Free Phone)	97
Trailer Weight	362		

- Understanding Your Instrument Panel 188
- Uniform Tire Quality Grades 463
- Universal Consumer Interface
(UCI) Connector 260,265
- Universal Transmitter 158
- Unleaded Gasoline 350
-
- Vanity Mirrors 96
- Vehicle Certification Label 356
- Vehicle Identification Number (VIN) 6
- Vehicle Loading 327,356,358
- Vehicle Modifications/Alterations 7
- Vehicle Storage 285,428
- Vehicle Theft Alarm (Security Alarm) 17
- Voice Recognition System (VR) 127
-
- Warning Lights
(Instrument Cluster Description) 191
- Warnings and Cautions 6
-
- Warranty Information 460
- Washer
 Adding Fluid 406
- Washers, Windshield 153
- Washing Vehicle 420
- Water
 Driving Through 304
- Wheel and Wheel Trim 421
- Wheel and Wheel Trim Care 421
- Wind Buffeting 167
- Window Fogging 286
- Windows 33
 Power 33
- Windshield Defroster 87,277,283
- Windshield Washers 151,153
- Windshield Wipers 151,406
- Wipers, Intermittent 153

INSTALLATION OF RADIO TRANSMITTING EQUIPMENT

Special design considerations are incorporated into this vehicle's electronic system to provide immunity to radio frequency signals. Mobile two-way radios and telephone equipment must be installed properly by trained personnel. The following must be observed during installation.

The positive power connection should be made directly to the battery and fused as close to the battery as possible. The negative power connection should be made to body sheet metal adjacent to the negative battery connection. This connection should not be fused.

Antennas for two-way radios should be mounted on the roof or the rear area of the vehicle. Care should be used in mounting antennas with magnet bases. Magnets may affect the accuracy or operation of the compass on vehicles so equipped.

The antenna cable should be as short as practical and routed away from the vehicle wiring when possible. Use only fully shielded coaxial cable.

Carefully match the antenna and cable to the radio to ensure a low Standing Wave Ratio (SWR).

Mobile radio equipment with output power greater than normal may require special precautions.

All installations should be checked for possible interference between the communications equipment and the vehicle's electronic systems.



STICK WITH THE SPECIALISTS®

Chrysler Group LLC

11PM491-126-AE



Fifth Edition

Printed in U.S.A.