

# 2013 Chevrolet Volt Owner Manual

<b>In Brief</b> .....	1-1	<b>Storage</b> .....	4-1	<b>Climate Controls</b> .....	8-1
Instrument Panel .....	1-2	Storage Compartments .....	4-1	Climate Control Systems .....	8-1
Initial Drive Information .....	1-4	Additional Storage Features .....	4-4	Air Vents .....	8-8
Vehicle Features .....	1-16	<b>Instruments and Controls</b> .....	5-1	<b>Driving and Operating</b> .....	9-1
Battery and Efficiency .....	1-18	Instrument Panel Overview .....	5-3	Driving Information .....	9-2
Performance and Maintenance .....	1-23	Controls .....	5-5	Starting and Operating .....	9-16
<b>Keys, Doors, and Windows</b> .....	2-1	Warning Lights, Gauges, and Indicators .....	5-8	Electric Vehicle Operating Modes .....	9-21
Keys and Locks .....	2-1	Information Displays .....	5-27	Engine Exhaust .....	9-26
Doors .....	2-13	Vehicle Messages .....	5-43	Electric Drive Unit .....	9-27
Vehicle Security .....	2-14	Vehicle Personalization .....	5-51	Brakes .....	9-29
Exterior Mirrors .....	2-16	Universal Remote System .....	5-59	Ride Control Systems .....	9-32
Interior Mirrors .....	2-17	<b>Lighting</b> .....	6-1	Cruise Control .....	9-35
Windows .....	2-18	Exterior Lighting .....	6-1	Object Detection Systems .....	9-38
<b>Seats and Restraints</b> .....	3-1	Interior Lighting .....	6-4	Charging .....	9-47
Head Restraints .....	3-2	Lighting Features .....	6-5	Fuel .....	9-55
Front Seats .....	3-3	<b>Infotainment System</b> .....	7-1	Towing .....	9-60
Rear Seats .....	3-7	Introduction .....	7-1	Conversions and Add-Ons .....	9-60
Safety Belts .....	3-9				
Airbag System .....	3-16				
Child Restraints .....	3-29				

# 2013 Chevrolet Volt Owner Manual

---

<b>Vehicle Care</b> .....	10-1	<b>Technical Data</b> .....	12-1
General Information .....	10-2	Vehicle Identification .....	12-1
Vehicle Checks .....	10-5	Vehicle Data .....	12-2
Headlamp Aiming .....	10-26	<b>Customer Information</b> .....	13-1
Bulb Replacement .....	10-27	Customer Information .....	13-1
Electrical System .....	10-30	Reporting Safety Defects .....	13-12
Wheels and Tires .....	10-39	Vehicle Data Recording and	
Jump Starting .....	10-68	Privacy .....	13-13
Towing .....	10-73	<b>OnStar</b> .....	14-1
Appearance Care .....	10-77	OnStar Overview .....	14-1
<b>Service and Maintenance</b> ...	11-1	OnStar Services .....	14-2
General Information .....	11-1	OnStar Additional	
Maintenance Schedule .....	11-2	Information .....	14-5
Special Application		<b>Index</b> .....	i-1
Services .....	11-8		
Additional Maintenance			
and Care .....	11-8		
Recommended Fluids,			
Lubricants, and Parts .....	11-12		
Maintenance Records .....	11-14		



The names, logos, emblems, slogans, vehicle model names, and vehicle body designs appearing in this manual including, but not limited to, GM, the GM logo, CHEVROLET, the CHEVROLET Emblem, VOLT, and the VOLT logo are trademarks and/or service marks of General Motors LLC, its subsidiaries, affiliates, or licensors.

This manual describes features that may or may not be on your specific vehicle either because they are options that you did not purchase or due to changes subsequent to the printing of this owner manual. Please refer to the purchase documentation relating to your

specific vehicle to confirm each of the features found on your vehicle. For vehicles first sold in Canada, substitute the name “General Motors of Canada Limited” for Chevrolet Motor Division wherever it appears in this manual.

Keep this manual in the vehicle for quick reference.

## Canadian Vehicle Owners

### Propriétaires Canadiens

A French language manual can be obtained from your dealer, at [www.helminc.com](http://www.helminc.com), or from:

On peut obtenir un exemplaire de ce guide en français auprès du concessionnaire ou à l'adresse suivante:

Helm, Incorporated  
Attention: Customer Service  
47911 Halyard Drive  
Plymouth, MI 48170

## Using this Manual

To quickly locate information about the vehicle, use the Index in the back of the manual. It is an alphabetical list of what is in the manual and the page number where it can be found.

## Danger, Warnings, and Cautions

Warning messages found on vehicle labels and in this manual describe hazards and what to do to avoid or reduce them.

**Danger** indicates a hazard with a high level of risk which will result in serious injury or death.

**Warning** or **Caution** indicates a hazard that could result in injury or death.

### WARNING

These mean there is something that could hurt you or other people.

**Notice:** This means there is something that could result in property or vehicle damage. This would not be covered by the vehicle's warranty.



A circle with a slash through it is a safety symbol which means "Do Not," "Do not do this," or "Do not let this happen."

## Symbols

The vehicle has components and labels that use symbols instead of text. Symbols are shown along with the text describing the operation or information relating to a specific component, control, message, gauge, or indicator.

 : This symbol is shown when you need to see your owner manual for additional instructions or information.

 : This symbol is shown when you need to see a service manual for additional instructions or information.

### Vehicle Symbol Chart

Here are some additional symbols that may be found on the vehicle and what they mean. For more information on the symbol, refer to the Index.

 : Airbag Readiness Light

 : Air Conditioning

 : Antilock Brake System (ABS)

 : Audio Steering Wheel Controls or OnStar®

 : Brake System Warning Light

 : Charge Port Door

 : Charging System (12-Volt Battery)

 : Cruise Control

 : Electric Parking Brake

 : Electronic Stability Control (ESC)

 : Engine Coolant Temperature

 : Exterior Lamps

 : Fault

 : First Responder

 : Fuel Gauge

 : Fuses

 : Headlamp High/Low-Beam Changer

 : High Voltage

 : LATCH System Child Restraints

 : Leaf

 : Malfunction Indicator Lamp

 : Oil Pressure

 : Power

 : Remote Vehicle Start

 : Safety Belt Reminders

 : StabiliTrak<sup>®</sup> Disable

 : Tire Pressure Monitor

 : Traction Control System (TCS)  
Disable

 **READY** : Vehicle Ready

 : Windshield Washer Fluid



## In Brief

### Instrument Panel

Instrument Panel ..... 1-2

### Initial Drive Information

Initial Drive Information ..... 1-4

Remote Keyless Entry (RKE)

System ..... 1-4

Remote Start ..... 1-4

Door Locks ..... 1-5

Windows ..... 1-7

Seat Adjustment ..... 1-7

Heated Seats ..... 1-8

Head Restraint Adjustment .... 1-9

Safety Belts ..... 1-10

Passenger Sensing

System ..... 1-10

Mirror Adjustment ..... 1-10

Steering Wheel

Adjustment ..... 1-11

Interior Lighting ..... 1-12

Exterior Lighting ..... 1-12

Windshield Wiper/Washer .... 1-13

Climate Controls ..... 1-14

### Vehicle Features

Steering Wheel Controls ..... 1-16

Cruise Control ..... 1-16

Infotainment System ..... 1-17

Power Outlets ..... 1-17

Universal Remote System ... 1-17

### Battery and Efficiency

High Voltage Safety

Information ..... 1-18

Charging ..... 1-18

Fueling ..... 1-22

Total Vehicle Range ..... 1-23

Regenerative Braking ..... 1-23

Service ..... 1-23

### Performance and Maintenance

Traction Control

System (TCS) ..... 1-23

Electronic Stability

Control (ESC) ..... 1-24

Tire Pressure Monitor ..... 1-24

Tire Sealant and

Compressor Kit ..... 1-24

Engine Oil Life System ..... 1-24

Driving for Better Energy

Efficiency ..... 1-25

Roadside Assistance

Program ..... 1-27

OnStar® ..... 1-27

## Instrument Panel

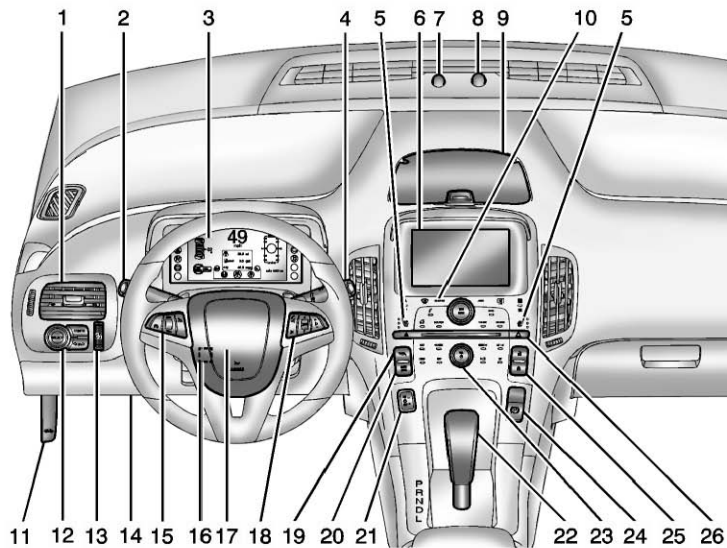



1. *Air Vents on page 8-8.*
2. *Turn and Lane-Change Lever. See Turn and Lane-Change Signals on page 6-3.*  
*Exterior Lamp Controls on page 6-1.*  
*Pedestrian Friendly Alert on page 5-6.*
3. *Instrument Cluster on page 5-8.*  
*Driver Information Center (DIC) Display. See Driver Information Center (DIC) on page 5-41.*
4. *Windshield Wiper/Washer on page 5-6.*
5. *Heated Front Seats on page 3-5 (If Equipped).*
6. *Center Stack Display on page 5-27.*
7. *Charging Status Indicator. See Charging Status Feedback on page 9-49.*
8. *Light Sensor. See Daytime Running Lamps (DRL) on page 6-2.*
9. *Instrument Panel Storage on page 4-1.*
10. *Automatic Climate Control System on page 8-1.*
11. *Hood Release. See Hood on page 10-6.*
12. *Driver Information Center (DIC) Controls. See Driver Information Center (DIC) on page 5-41.*
13. *Instrument Panel Illumination Control on page 6-4.*
14. *Data Link Connector (DLC) (Out of View). See Malfunction Indicator Lamp on page 5-17.*
15. *Cruise Control on page 9-35.*
16. *Steering Wheel Adjustment on page 5-5.*
17. *Horn on page 5-6.*
18. *Steering Wheel Controls on page 5-5 (If Equipped).*
19. *Leaf Button. See Center Stack Display on page 5-27.*
20. *DRIVE MODE Button. See Driver Selected Operating Modes on page 9-22.*
21. *Power Button on page 9-16.*
22. *Shift Lever. See Electric Drive Unit on page 9-27.*
23. *Infotainment on page 7-1.*  
*Navigation System (If Equipped). See the navigation system manual.*
24. *Electric Parking Brake on page 9-30.*
25. *Power Door Locks on page 2-11.*
26. *Hazard Warning Flashers on page 6-3.*

### Initial Drive Information

This section provides a brief overview about some of the important features that may or may not be on your specific vehicle.

For more detailed information, refer to each of the features which can be found later in this owner manual.

### Remote Keyless Entry (RKE) System

The RKE transmitter may work up to 60 m (195 ft) away from the vehicle.







Press the key release button to extend the key. The key can be used for all locks.

 : Press once to unlock the driver door. Press a second time within five seconds to unlock all doors.

 : Press to lock all doors.

Lock and unlock feedback can be personalized. See *Vehicle Personalization* on page 5-51.

 : Press and release to initiate vehicle locator. Press and hold for three seconds to sound the panic alarm. Press again to cancel the panic alarm.

 : Press and release  and then immediately press and hold  to start the vehicle's heating or air conditioning systems and rear window defogger from outside the vehicle using the RKE transmitter. See *Remote Start* on page 2-8.

 : Press to open the charge port door. See *Plug-In Charging* on page 9-47.



See *Keys* on page 2-1 and *Remote Keyless Entry (RKE) System Operation* on page 2-2.

### Remote Start

Use remote start to heat or cool the interior when the vehicle is plugged in to maximize electric range by utilizing electricity from the electrical outlet. The engine may start to support the climate control

operation. Normal operation of the system will return after the vehicle has been turned on.



### Activating the Remote Start

1. Aim the RKE transmitter at the vehicle.
2. Press and release  on the RKE transmitter; the doors will lock.
3. Immediately, press and hold  until the turn signal lamps flash, or for approximately two seconds. Pressing  again during a remote start will turn the feature off.

After entering the vehicle during a remote start, press the POWER  button on the center stack with the brake pedal applied to operate as normal.

### Canceling Remote Start

To cancel a remote start, do any of the following:

- Aim the RKE transmitter at the vehicle and press and hold  until the parking lamps turn off.
- Turn on the hazard warning flashers.
- Press the POWER  button on the center stack, with the brake pedal applied, then press the POWER  button again to turn the vehicle off.

See *Remote Start* on page 2-8.

## Door Locks

### Keyless Access



When the Remote Keyless Entry (RKE) transmitter is within 1 m (3 ft) of the driver door, the door can be locked and unlocked by pressing the door handle button. When unlocking from the driver door, the first press will unlock only that door; press again within five seconds to unlock all passenger doors. See *Remote Keyless Entry (RKE) System Operation* on page 2-2.

## 1-6 In Brief

### Remote Keyless Entry (RKE)

The RKE transmitter must be within 60 m (195 ft) of the vehicle.

 : Press to unlock.

 : Press to lock.

See *Remote Keyless Entry (RKE) System Operation* on page 2-2.

### Key

To unlock or lock the door, turn the key left or right.

### Inside the Vehicle

Push down on the door lock knob to lock that door. Pull once on the door handle to unlock the door and again to open the door. Press the power door lock switch to lock or unlock all doors. See *Door Locks* on page 2-10 and *Power Door Locks* on page 2-11.

### Power Door Locks

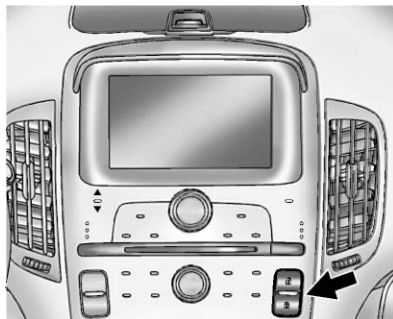

The power door lock switches are on the center stack.

 : Press to unlock.

 : Press to lock.

See *Power Door Locks* on page 2-11.

### Hatch

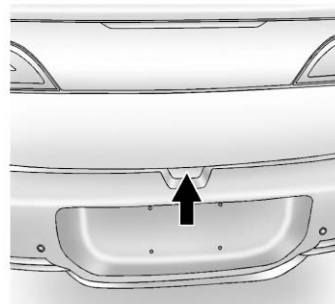

**Keyless Access:** To open the hatch with the vehicle locked, the RKE transmitter must be within 1 m (3 ft) of the trunk. Press the button on the underside of the hatch and lift up. See *Remote Keyless Entry (RKE) System Operation* on page 2-2.

**Remote Keyless Entry (RKE):** To open the hatch with the vehicle locked, the RKE transmitter must be within 60 m (195 ft) of the vehicle. Unlock the vehicle with the RKE

transmitter, then press the button on the underside of the hatch and lift. See *Hatch* on page 2-13.

## Windows

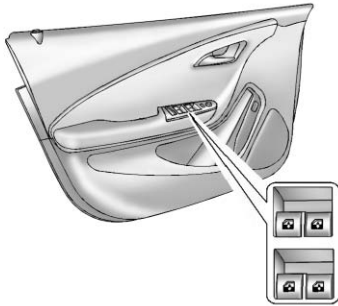

The power window switches are on the driver door armrest. Each passenger door has a switch that controls only that window.

Press the front of the switch to lower the window. Pull the switch up to raise it.

The driver and passenger windows have an express-down feature and the driver window has express-up.

See *Power Windows* on page 2-18.

## Remote Window Operation



The vehicle may have remote operating windows that will open all the windows from outside the vehicle by pressing and holding  on the Remote Keyless Entry (RKE) transmitter.

This feature can be disabled by a dealer technician.

See *Power Windows* on page 2-18.

## Seat Adjustment

### Seat Position

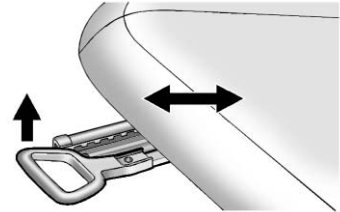

To adjust the seat position:

1. Pull the handle at the front of the seat cushion to unlock it.
2. Move the seat forward or rearward and release the handle.
3. Try to move the seat back and forth to be sure it is locked in place.

See *Seat Adjustment* on page 3-3.

## 1-8 In Brief

### Height Adjustment

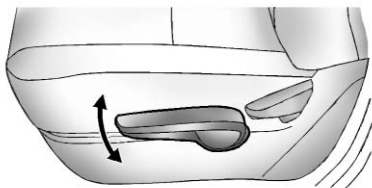

Move the lever up or down to raise or lower the seat.

See “Seat Height Adjuster” under *Seat Adjustment* on page 3-3.

### Reclining Seatbacks

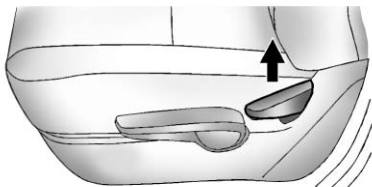

To recline the seatback:

1. Lift the lever.
2. Move the seatback to the desired position, and then release the lever to lock the seatback in place.
3. Push and pull on the seatback to make sure it is locked.

To return the seatback to the upright position:



1. Lift the lever fully without applying pressure to the seatback, and the seatback will return to the upright position.
2. Push and pull on the seatback to make sure it is locked.

See *Reclining Seatbacks* on page 3-4.

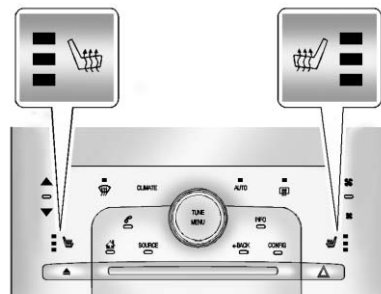
### Heated Seats



If available, the controls are on the center stack. To operate, the vehicle must be on.

Press  or  to heat the driver or passenger seat cushion and seatback.

Press the button once for the highest setting. With each press of the button, the heated seat will change to the next lower setting,

and then the off setting. Three lights indicate the highest setting and one light the lowest.

See *Heated Front Seats on page 3-5*.

### Auto Heated Seats

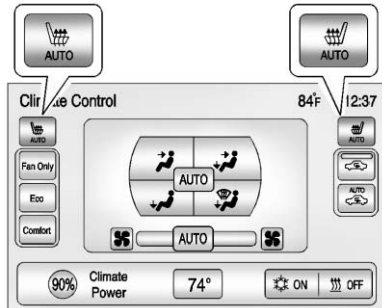

If available, the controls can be accessed while the vehicle is on by pressing the CLIMATE button on the center stack.

Press the touch screen AUTO or AUTO button. The button color will change to green when this feature is on.

When the vehicle is on, this feature will automatically activate the heated seats at the level required by the vehicle's interior temperature. The active high, medium, low, or off heated seat level will be indicated by the manual heated seat button lights on the center stack. Use the touch screen buttons or the manual heated seat buttons on the center stack to turn auto heated seats off.

See *Heated Front Seats on page 3-5*.

The heated seats can also be programmed to come on during a remote start. See *Vehicle Personalization on page 5-51*.

## Head Restraint Adjustment

Do not drive until the head restraints for all occupants are installed and adjusted properly.

To achieve a comfortable seating position, change the seatback recline angle as little as necessary while keeping the seat and the head restraint height in the proper position.

See *Head Restraints on page 3-2* and *Seat Adjustment on page 3-3*.

### Safety Belts

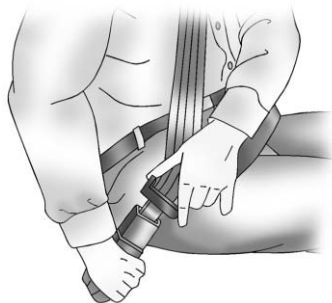

Refer to the following sections for important information on how to use safety belts properly:

- *Safety Belts on page 3-9.*
- *How to Wear Safety Belts Properly on page 3-10.*
- *Lap-Shoulder Belt on page 3-11.*
- *Lower Anchors and Tethers for Children (LATCH System) on page 3-37.*

### Passenger Sensing System



#### United States



#### Canada

The passenger sensing system will turn off the front outboard passenger frontal airbag and knee airbag under certain conditions. No other airbag is affected by the passenger sensing system. See *Passenger Sensing System on page 3-23.*

The passenger airbag status indicator lights on the overhead console when the vehicle is started. See *Passenger Airbag Status Indicator on page 5-16.*

### Mirror Adjustment

#### Exterior

Mirrors can be folded inward toward the vehicle to prevent damage when going through an automatic car wash. Push the mirror outward to return it to the original position.

See *Folding Mirrors on page 2-16.*



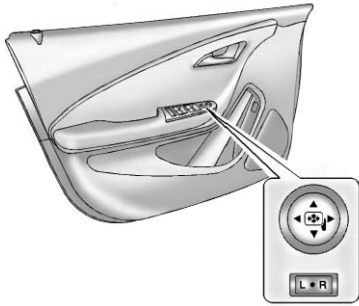

Controls for the outside power mirrors are on the driver door.

To adjust a mirror:

1. Move the selector switch to L (Left) or R (Right) to choose the driver or passenger mirror.
2. Press the arrows on the control pad to move each mirror in the desired direction.
3. Return the selector switch to the center position.

See *Power Mirrors* on page 2-16.

When the rear window defogger is activated, the heated mirrors, if equipped, will also come on. See *Heated Mirrors* on page 2-17.

## Interior

### Adjustment

Hold the rearview mirror in the center and move it to view the area behind the vehicle.

### Manual Rearview Mirror

For vehicles with a manual rearview mirror, push the tab forward for daytime use and pull it for nighttime use to avoid glare from the headlamps from behind. See *Manual Rearview Mirror* on page 2-17.

### Automatic Dimming Rearview Mirror

For vehicles with an automatic dimming rearview mirror, the mirror will automatically reduce the glare from the headlamps from behind. The dimming feature comes on

when the vehicle is started. See *Automatic Dimming Rearview Mirror* on page 2-17.

## Steering Wheel Adjustment

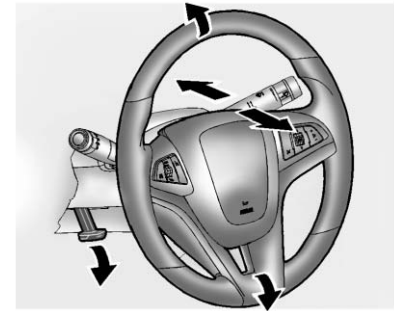

To adjust the steering wheel:

1. Pull the lever down.
2. Move the steering wheel up or down.
3. Pull or push the steering wheel closer or away from you.

## 1-12 In Brief

4. Pull the lever up to lock the steering wheel in place.

Do not adjust the steering wheel while driving.

### Interior Lighting

#### Dome Lamps

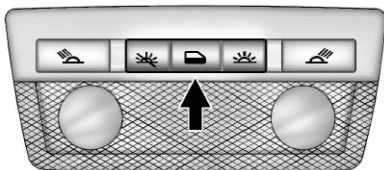

The dome lamp controls are in the overhead console.

To operate, press the following buttons:

 : Press to turn on the dome lamps.

 : Press to turn the lamps on automatically when a door is opened.



 : Press to turn the lamps off, even when a door is open.

#### Reading Lamps

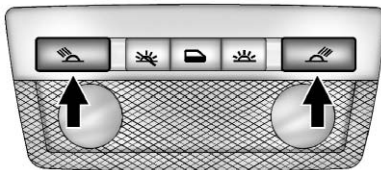
There are front and rear reading lamps.



The front reading lamps are in the overhead console.

  : Press to turn each lamp on or off.

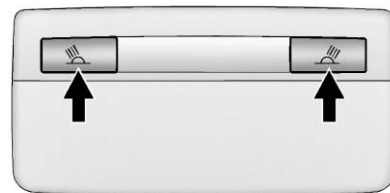

The rear reading lamps are in the headliner.

For more information on interior lighting, see *Instrument Panel Illumination Control* on page 6-4.

### Exterior Lighting



The exterior lamp control is on the turn signal lever.

There are four positions.

☐ : Turns the exterior lamps off.

**AUTO:** Turns the exterior lamps on and off automatically depending on the exterior light.

☐ : Turns on the parking lamps, together with the sidemarker lamps, taillamps, license plate lamps, and instrument panel lights.

☐ : Turns on the headlamps, together with the parking lamps, sidemarker lamps, taillamps, license plate lamps, and instrument panel lights.

See:

- *Exterior Lamp Controls on page 6-1*
- *Daytime Running Lamps (DRL) on page 6-2*

## Windshield Wiper/Washer

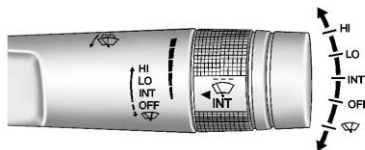

With the ignition in ACC/ACCESSORY or ON/RUN/START, move the lever to select the wiper speed.

**HI:** Use for fast wipes.

**LO:** Use for slow wipes.

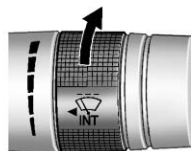

**INT:** Move the lever up to INT for intermittent wipes, then turn the INT band up for more frequent wipes or down for less frequent wipes.

**OFF:** Use to turn the wipers off.

☐ : For a single wipe, briefly move the lever down. For several wipes, hold the lever down.

☐ : Pull the lever toward you to spray windshield washer fluid and activate the wipers.

See *Windshield Wiper/Washer on page 5-6*.

### Climate Controls

Heating, cooling, and ventilation can be controlled by using the climate control buttons and the climate touch screen.

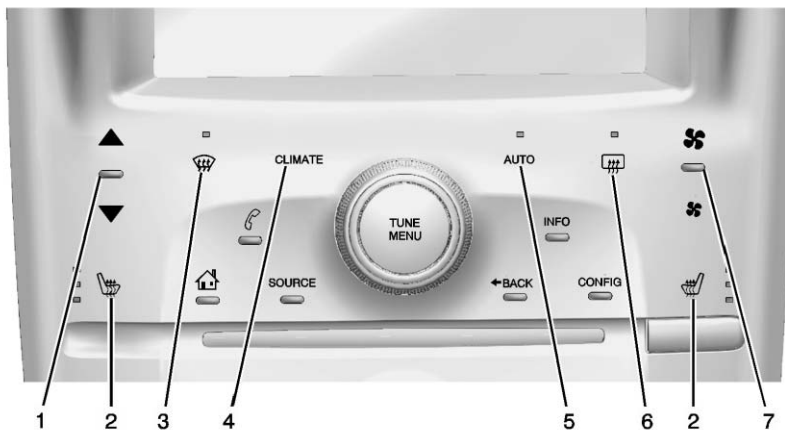

**Climate Control Buttons**

- |                                      |                               |
|--------------------------------------|-------------------------------|
| 1. Temperature Control               | 4. Climate                    |
| 2. Driver and Passenger Heated Seats | 5. Auto (Automatic Operation) |
| 3. Defrost                           | 6. Rear Window Defogger       |

### 7. Manual Fan Control

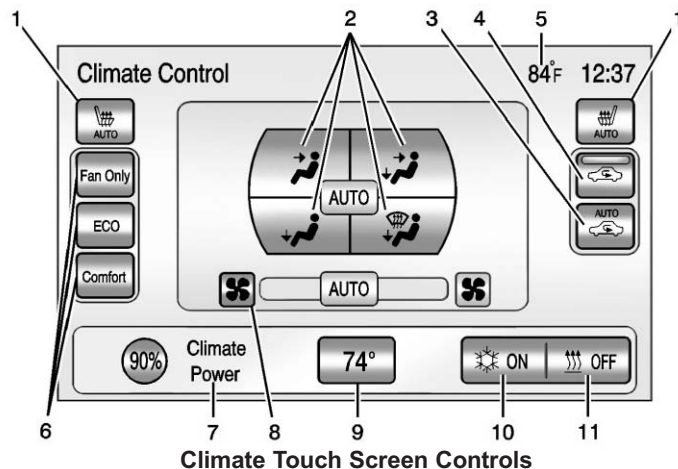

See *Automatic Climate Control System* on page 8-1.



Auto heated seats are selected using the climate control touch screen. See *Heated Front Seats* on page 3-5.



- |   |  |
|---|--|
| 1. Driver and Passenger Auto Heated Seats | 6. Climate Modes: Fan Only, ECO, Comfort |
| 2. Air Delivery Mode Controls             | 7. Climate Power Gauge                   |
| 3. Auto Recirculation                     | 8. Manual Fan Control                    |
| 4. Manual Recirculation                   | 9. Temperature Setting Display           |
| 5. Outside Air Temperature Display        | 10. Air Conditioning Indicator           |
|   | 11. Heat Status Indicator                |

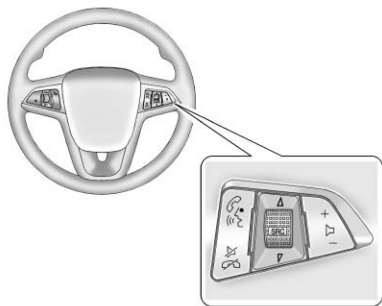

## Vehicle Features



### Steering Wheel Controls



 /  : Press to interact with the phone or navigation system.

 /  : Press to mute. Press again to turn the sound on. Press to reject an incoming call, or to end a current call.

 **SRC**  : Use to select a radio band or audio source.

Use  or  to select the next or previous favorite radio station, CD track, DVD track/chapter, or MP3 track.

Press SRC to change between radio and CD or DVD.

Press and hold SRC to interact with the navigation system.

+  -: Press + to increase or - to decrease the volume.

See *Steering Wheel Controls* on page 5-5.

### Cruise Control

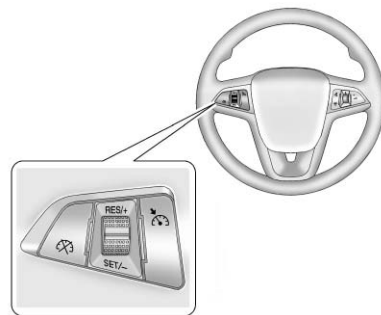

The cruise control buttons are on the steering wheel.

 : Press to turn the cruise control system on and off. An indicator light will turn on or off in the instrument cluster.

 : Press to disengage cruise control without erasing the set speed from memory.

**RES/+**: Move the thumbwheel up to resume to a previously set speed or to accelerate.

**SET/-:** Move the thumbwheel down to set a speed and activate cruise control or to make the vehicle decelerate.

See *Cruise Control* on page 9-35.

## Infotainment System

See the infotainment manual for information on the radio, audio players, phone, navigation system, and voice or speech recognition. There is also information on settings and downloadable applications (if equipped).

## Power Outlets

The accessory power outlets can be used to plug in electrical equipment, such as a cell phone or MP3 player.

There are three accessory power outlets:

- Inside the front of the center floor console.
- On the rear of the center floor console.

- Inside the instrument panel storage area.

The power outlets supply power while the vehicle is on, or if the vehicle is in Retained Accessory Power (RAP). See *Retained Accessory Power (RAP)* on page 9-19.

Remove the cover to access and replace when not in use.

See *Power Outlets* on page 5-7.

## Universal Remote System



This system provides a way to replace up to three remote control transmitters used to activate devices such as garage door openers, security systems, and home automation devices.

Read the instructions completely before attempting to program the Universal Remote system. Because of the steps involved, it may be helpful to have another person available to assist with programming the Universal Remote system.

See *Universal Remote System* on page 5-59.

## Battery and Efficiency

### High Voltage Safety Information

 **WARNING**

Exposure to high voltage can cause shock, burns, and even death. The high voltage components in the vehicle can only be serviced by technicians with special training.

High voltage components are identified by labels. Do not remove, open, take apart, or modify these components. High voltage cable or wiring has orange covering. Do not probe, tamper with, cut, or modify high voltage cable or wiring.

This vehicle has a high voltage battery and a standard 12-volt battery.

If the vehicle is in a crash, the sensing system may shut down the high voltage system. When this occurs, the high voltage battery is disconnected and the vehicle will not start. The SERVICE VEHICLE SOON message in the Driver Information Center (DIC) will be displayed. Before the vehicle can be operated again, it must be serviced at your dealer.

See *Battery on page 10-22* for important safety information. If an airbag has inflated, see *What Will You See after an Airbag Inflates? on page 3-21*.

Only a trained service technician with the proper knowledge and tools should inspect, test, or replace the high voltage battery. See your dealer if the high voltage battery needs service.

See *Battery on page 10-22*.

## Charging

The high voltage battery can be charged using a household electrical outlet. When using a 120-volt AC electrical outlet, it will take approximately 10 hours to charge the vehicle with the 12 amp AC current setting or 16 hours using the default 8 amp AC current setting. When using a 240-volt charging station, it will take approximately four hours to charge the vehicle. Charge times will vary with outside temperature. There are three ways to program how the vehicle is charged. See *Programmable Charging on page 5-29* for more information.

This section explains the process for charging the high voltage battery. Do not allow the vehicle to remain in temperature extremes for long periods without being driven or plugged in. It is recommended that the vehicle be plugged in when



temperatures are below 0°C (32°F) and above 32°C (90°F) to maximize high voltage battery life.

The charging system may run fans and pumps that result in sounds from the vehicle while it is turned off. Additional unexpected clicking sounds may be caused by the electrical devices used while charging.

While the charge cord is plugged into the vehicle, the vehicle cannot be driven.

## Charging

### Start Charge

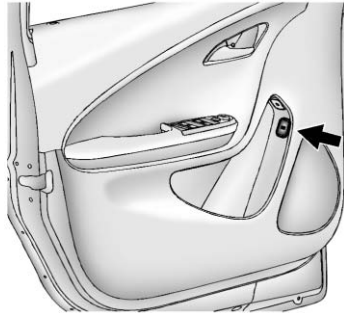

1. The charge port door release button is on the driver door inner trim panel. With the vehicle in P (Park), press the button for one second and release to open the charge port door. The charge port door can also be opened using the RKE transmitter. See *Remote Keyless Entry (RKE) System Operation* on page 2-2.

In cold weather conditions, ice may form around the charge port door. The charge port door may not open on the first attempt. Remove ice from the area and repeat attempting to open the charge port door.



2. Open the rear hatch, lift the load support floor covering (1), and remove the charge cord (2). It is located near the tire sealant and compressor kit (3). Pull up on the charge cord handle (4) to release it from the handle clip.

Lift the charge cord up and rearward to remove it from the vehicle. The vehicle plug (2) is stored as shown.

3. Plug the charge cord into the electrical outlet. See *Electrical Requirements for Battery Charging on page 9-54*. Verify the charge cord status. See the charge cord user guide for more information. See *Charge Cord on page 9-53*. Select the appropriate charge level using the Select Charge Level Preference screen on the center stack. See “Charge Level Selection” under *Programmable Charging on page 5-29*.

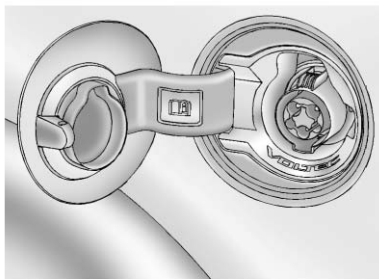

4. Plug in the vehicle plug of the charge cord into the charge port on the vehicle. Verify that the charging status indicator illuminates on top of the instrument panel and a horn chirp occurs. See *Charging Status Feedback on page 9-49* for more information.
5. To arm the charge cord theft alert, lock the vehicle with the RKE transmitter. To disable this feature, see “Charge Cord Theft Alert” in *Vehicle Personalization on page 5-51*.

### End Charge

1. Unlock the vehicle with the RKE transmitter to disarm the charge cord theft alert.

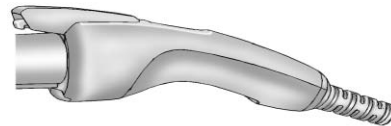

2. Unplug the vehicle plug of the charge cord from the vehicle.
3. Close the charge port door by pressing firmly in the center to latch properly.
4. Unplug the charge cord from the electrical outlet.
5. Place the charge cord into the storage compartment.

## Charge Cord

See *Radio Frequency Statement on page 13-15* for information regarding Part 15 of the Federal Communications Commission (FCC) rules and Industry Canada Standards RSS-GEN/210/220/310.

A portable charge cord used to charge the vehicle high voltage battery is stored under the rear luggage compartment.

### Important Information About Portable Electric Vehicle Charging

- Charging an electric vehicle can stress a building's electrical system more than a typical household appliance.
- Before you plug in to any electrical outlet, have a qualified electrician inspect and verify the electrical system (electrical outlet, wiring, junctions, and protection devices) for heavy-duty service at a 12 amp continuous load.

- Electrical outlets may wear out with normal usage or be damaged over time, making them unsuitable for electric vehicle charging.
- Check the electrical outlet/plug while charging and discontinue use if the electrical outlet/plug is hot, then have the electrical outlet serviced by a qualified electrician.
- When outdoors, plug into an electrical outlet that is weather-proof while in use.
- Mount the charging cord to reduce strain on the electrical outlet/plug.

### WARNING

Improper use of portable electric vehicle charge cords may cause a fire, electrical shock, or burns, and may result in damage to property, serious injury, or death.

(Continued)

### WARNING (Continued)

- Do not use extension cords, multi-outlet power strips, splitters, grounding adaptors, surge protectors, or similar devices.
- Do not use an electrical outlet that is worn or damaged, or one that will not hold the plug firmly in place.
- Do not use an electrical outlet that is not properly grounded.
- Do not use an electrical outlet that is on a circuit with other electrical loads.

See the charge cord user guide.

### Charge Cord Status Indicators

See "Charge Cord Status Indicators" in the charge cord user guide.

### Charge Level Selection

Charge level selection can be made using the Select Charge Level Preference screen on the center stack. See “Charge Level Selection” under *Programmable Charging* on page 5-29.

#### **WARNING**

Using a charge level that exceeds the electrical circuit or electrical outlet capacity may start a fire or damage the electrical circuit. Use the lowest charge level until a qualified electrician inspects your electrical circuit capacity. Use the lowest charge level if the electrical circuit or electrical outlet capacity is not known.

### Fueling

The fuel system on this vehicle requires a refueling process to control evaporative emissions. To refuel the vehicle:

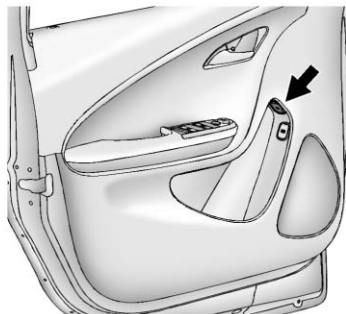

1. Press the fuel door button on the driver door for one second. A WAIT TO REFUEL message displays on the Driver Information Center.



2. When the READY TO REFUEL message displays, the fuel door on the passenger side will unlock. Push the rearward edge of the fuel door in and release to open the door.
3. Turn the fuel cap counterclockwise to remove. While refueling, hang the fuel cap tether from the hook on the inside of the fuel door. Complete refueling within 30 minutes of pushing the fuel door button on the driver door. If refueling more than 30 minutes, push the fuel door button again.
4. After refueling, reinstall the fuel cap by turning it clockwise until it clicks. Close the fuel door.

See *Filling the Tank* on page 9-57.

## Total Vehicle Range



Total vehicle range is the remaining distance the vehicle can be driven combining the electric range and fuel range.

See *Driving for Better Energy Efficiency* on page 9-2.

## Regenerative Braking

Regenerative braking takes some of the energy from the moving vehicle and turns it back into electrical energy. This energy is then stored in

the high voltage battery system, contributing to increased energy efficiency.

See *Regenerative Braking* on page 9-32.

## Service

### ⚠ WARNING

Never try to do your own service on high voltage components. You can be injured and the vehicle can be damaged if you try to do your own service work. Service and repair of these high voltage components should only be performed by a trained service technician with the proper knowledge and tools. See *Doing Your Own Service Work* on page 10-5.

## Performance and Maintenance

### Traction Control System (TCS)



The TCS limits wheel spin. The system turns on automatically every time the vehicle is on.

- To turn off traction control, press and release the TCS/ESC button, located on the overhead console.  illuminates and the appropriate DIC message is displayed. See *Ride Control System Messages* on page 5-48.
- Press and release the TCS/ESC button again to turn on traction control.

For more information, see *Traction Control System (TCS)* on page 9-32.

### Electronic Stability Control (ESC)

The Electronic Stability Control system called StabiliTrak assists with directional control of the vehicle in difficult driving conditions. The system turns on automatically every time the vehicle is on.

- To turn off both traction control and StabiliTrak, press and hold the TCS/ESC button located on the overhead console, until  and  illuminate in the instrument cluster and the appropriate DIC message is displayed. See *Ride Control System Messages on page 5-48*.
- Press and release the TCS/ESC button to turn on both systems.

For more information, see *Electronic Stability Control (ESC) on page 9-34*.

### Tire Pressure Monitor

This vehicle may have a Tire Pressure Monitor System (TPMS).



The low tire pressure warning light alerts to a significant loss in pressure of one of the vehicle's tires. If the warning light comes on, stop as soon as possible and inflate the tires to the recommended pressure shown on the Tire and Loading Information label. See *Vehicle Load Limits on page 9-11*. The warning light will remain on until the tire pressure is corrected.

The low tire pressure warning light may come on in cool weather when the vehicle is first started, and then turn off as the vehicle is driven. This may be an early indicator that the

tire pressures are getting low and the tires need to be inflated to the proper pressure.

The TPMS does not replace normal monthly tire maintenance. Maintain the correct tire pressures.

See *Tire Pressure Monitor System on page 10-47*.

### Tire Sealant and Compressor Kit

This vehicle has a tire sealant and compressor kit that can be used to seal small punctures in the tread area of the tire. Significant sidewall damage will require the tire to be replaced.

See *Tire Sealant and Compressor Kit on page 10-60* for complete operating information.

### Engine Oil Life System

The engine oil life system calculates engine oil life based on vehicle use and displays the CHANGE ENGINE OIL SOON message when it is time

to change the engine oil and filter. The oil life system should be reset to 100% only following an oil change.

### Resetting the Oil Life System

1. Use the SELECT knob to select OIL LIFE on the DIC menu.
2. Press SELECT to start the OIL LIFE reset procedure.
3. The DIC menu will display “Are you sure that you want to reset?” Use SELECT to choose YES to reset oil life or NO to exit and return to the previous menu.
4. If YES is selected, the DIC menu will display RESET OIL LIFE for a short time and then 100% OIL LIFE will be displayed when OIL LIFE is successfully reset.

See *Engine Oil Life System* on page 10-12.

## Driving for Better Energy Efficiency

Use the following tips to help maximize energy efficiency and range.

### Driving Style

#### Efficiency Gauge (Instrument Cluster)

The ball indicator should be kept green and in the center of the gauge.

Inefficient acceleration is indicated when the ball turns yellow and travels above the center of the gauge.

Aggressive braking is indicated when the ball turns yellow and travels below the center of the gauge.

#### Acceleration/Braking/Coasting

Avoid unnecessary rapid accelerations and decelerations.

Electric range is maximized at 80 km/h (50 mph) and below. Higher speeds use more energy and can significantly reduce electric range.

Use cruise control when appropriate.

Plan ahead for decelerations and coast whenever possible. For example, do not rush to traffic signals.

Do not shift to N (Neutral) to coast. The vehicle recovers energy while coasting and braking in D (Drive) or L (Low).

#### Drive Mode and PRNDL Selection

Use Normal Mode when possible.

Sport Mode provides more responsive acceleration than Normal Mode but can reduce efficiency.

Use Mountain Mode prior to climbing long, steep grades in mountainous areas. Be sure to engage Mountain Mode before starting to climb. Mountain Mode

reduces electric range and power but may be needed to maintain speeds above 96 km/h (60 mph) when climbing grades of 5% or greater.

Use L (Low) in heavy stop-and-go traffic or when traveling downhill. L (Low) requires less brake pedal application and provides a controlled, efficient way to slow the vehicle down.

### Climate Setting

Using the heat and air conditioning systems decreases the energy available for electric driving.

Optimal energy efficiency is achieved with the heat, air conditioning, and fan turned off.

Less energy is used at low fan speeds. When using the fan:

- Fan Only is the most energy efficient climate setting as long as  is not selected.

- ECO is for moderate air conditioning and heater operation and is the next most energy efficient setting as long as  is not selected.
- Comfort provides the most comfort but is the least energy efficient.

Use the auto heated seat feature instead of climate settings. Heating the seat uses less energy than heating the vehicle interior.

Use remote start to heat or cool the interior when the vehicle is plugged in to maximize the electric range by utilizing electricity from the electrical outlet.

Engine Assisted Heating operation, if equipped, can be personalized. See *Vehicle Personalization on page 5-51* for more information.

In hot weather, avoid parking in direct sunlight or use sunshades inside the vehicle.

Turn off the front and rear window defog/defrost when they are no longer needed.

Avoid driving with the windows open at highway speeds.

### Vehicle Charging/Maintenance

#### Charging

Keep the vehicle plugged in, even when fully charged, to keep the battery temperature ready for the next drive. This is important when outside temperatures are extremely hot or cold.

#### Maintenance

Always keep the tires properly inflated and the vehicle properly aligned.

The weight of excess cargo in the vehicle affects efficiency and range. Avoid carrying more than is needed.

If fuel is not regularly used, consider keeping the fuel tank only one-third full. Excess fuel weight impacts efficiency and range.



Use premium fuel.

Avoid unnecessary use of electrical accessories. Power used for functions other than propelling the vehicle will reduce EV range.

Using a rooftop carrier will reduce efficiency due to additional weight and drag.

## Roadside Assistance Program

U.S.: 1-888-811-1926

TTY Users (U.S. Only):  
1-888-889-2438

Canada: 1-800-268-6800

As the owner of a new Chevrolet, you are automatically enrolled in the Roadside Assistance program. This program provides security and convenience in the event of an on-road failure or emergency situation. Service is provided 24 hours a day, 365 days a year for the 5 year/160 000 km (100,000 mi) coverage period.

See *Roadside Assistance Program* on page 13-5.

## OnStar®

If equipped, this vehicle has a comprehensive, in-vehicle system that can connect to a live Advisor for Emergency, Security, Navigation, Connection, and Diagnostic Services. See *OnStar Overview* on page 14-1.



# Keys, Doors, and Windows

## Keys and Locks

- Keys ..... 2-1
- Remote Keyless Entry (RKE) System ..... 2-2
- Remote Keyless Entry (RKE) System Operation ..... 2-2
- Remote Start ..... 2-8
- Door Locks ..... 2-10
- Power Door Locks ..... 2-11
- Delayed Locking ..... 2-11
- Automatic Door Locks ..... 2-12
- Lockout Protection ..... 2-12
- Safety Locks ..... 2-12

## Doors

- Hatch ..... 2-13

## Vehicle Security

- Vehicle Security ..... 2-14
- Vehicle Alarm System ..... 2-14
- Immobilizer ..... 2-15
- Immobilizer Operation ..... 2-15

## Exterior Mirrors

- Convex Mirrors ..... 2-16
- Power Mirrors ..... 2-16
- Folding Mirrors ..... 2-16
- Heated Mirrors ..... 2-17

## Interior Mirrors

- Manual Rearview Mirror ..... 2-17
- Automatic Dimming Rearview Mirror ..... 2-17

## Windows

- Windows ..... 2-18
- Power Windows ..... 2-18
- Sun Visors ..... 2-20

# Keys and Locks

## Keys

 **WARNING**

Leaving children in a vehicle with a Remote Keyless Entry (RKE) transmitter is dangerous and children or others could be seriously injured or killed. They could operate the power windows or other controls or make the vehicle move. The windows will function with the RKE transmitter in the vehicle, and children or others could be caught in the path of a closing window. Do not leave children in a vehicle with an RKE transmitter.

The key that is part of the RKE transmitter can be used for all locks.

## 2-2 Keys, Doors, and Windows



- Press the key release button on the RKE transmitter to extend the key.
- Press the key release button and fold the key blade to retract the key.

The key has a bar-coded key tag that the dealer or qualified locksmith can use to make new keys. Store this information in a safe place, not in the vehicle.

See your dealer if a replacement key or an additional key is needed.

If it becomes difficult to turn the key in a vehicle lock, inspect the key blade for debris. Periodically clean with a brush or pick.

If locked out of the vehicle, call the Roadside Assistance Center. See *Roadside Assistance Program on page 13-5*. With an active OnStar subscription, an OnStar Advisor may remotely unlock the vehicle. See *OnStar Overview on page 14-1*.

### Remote Keyless Entry (RKE) System

See *Radio Frequency Statement on page 13-15* for information regarding Part 15 of the Federal Communications Commission (FCC) rules and Industry Canada Standards RSS-GEN/210/220/310.

If there is a decrease in the RKE operating range:

- Check the distance. The transmitter may be too far from the vehicle.

- Check the location. Other vehicles or objects may be blocking the signal.
- Check the transmitter's battery. See "Battery Replacement" later in this section.
- If the transmitter is still not working correctly, see your dealer or a qualified technician for service.

### Remote Keyless Entry (RKE) System Operation

The RKE transmitter functions may work up to 60 m (195 ft) away from the vehicle.

Other conditions, such as those previously stated, can impact the performance of the transmitter.



**U (Unlock):** Press once to unlock the driver door. Press a second time within five seconds to unlock all doors.

The hazard warning lamps will flash twice each time the button is pressed and the anti-theft alarm system will be disarmed. See *Vehicle Alarm System on page 2-14*.

On vehicles with remote operating windows, pressing and holding **U** will open all of the vehicle's

windows. See *Power Windows on page 2-18*. This feature can be disabled by a dealer technician.

**L (Lock):** Press to lock all doors. The hazard warning lamps will flash once and the anti-theft alarm system will be armed. See *Vehicle Alarm System on page 2-14*.

If the driver door is open when **L** is pressed, all doors lock and then the driver door will unlock if the Unlocked Door Anti Lock Out feature is enabled through the vehicle personalization. See "Unlocked Door Anti Lock Out" under *Vehicle Personalization on page 5-51*. This may vary based on vehicle personalization.

**S (Panic Alarm):** Press and release one time to initiate vehicle locator. The exterior lamps flash and the horn chirps three times. Press and hold for three seconds to sound the panic alarm. The horn sounds and the turn signals flash for 30 seconds. Press again to cancel the panic alarm.

**R (Remote Start):** Press and release **L** and then immediately press and hold **R** to start the vehicle's heating or air conditioning systems and rear window defogger from outside the vehicle using the RKE transmitter. See *Remote Start on page 2-8*.

The vehicle may have auto heated seats, which can be programmed to come on when the vehicle is remotely started. See *Vehicle Personalization on page 5-51*. Also see "Auto Heated Seats" under *Heated Front Seats on page 3-5*.

**C (Charge Port Door):** Press to open the charge port door. See *Plug-In Charging on page 9-47*.

### Keyless Access Operation

To lock and unlock the doors and access the hatch, the RKE transmitter should be within 1 m (3 ft) of the door or hatch.

## 2-4 Keys, Doors, and Windows

---

The keyless access can be programmed to unlock all doors on the first lock/unlock press from the driver door. See *Vehicle Personalization* on page 5-51.

### Keyless Unlocking/Locking from the Driver Door

When the doors are locked and the RKE transmitter is within 1 m (3 ft) of the driver door handle, pressing the lock/unlock button on the driver door handle will unlock the driver door. If the lock/unlock button is pressed again within five seconds, all passenger doors will unlock.



**Driver Side Shown, Passenger Similar**

Pressing the lock/unlock button will cause all doors to lock if any of the following occur:

- It has been more than five seconds since the first lock/unlock button press.
- Two lock/unlock button presses were used to unlock all doors.
- Any vehicle door has opened and all doors are now closed.

### Keyless Unlocking/Locking from Passenger Doors

When the doors are locked and the RKE transmitter is within 1 m (3 ft) of the door handle, pressing the lock/unlock button on that door handle will unlock all doors. Pressing the lock/unlock button will cause all doors to lock if any of the following occur:

- After the lock/unlock button was used to unlock all doors.
- After any vehicle door has opened and all doors are now closed.

### Passive Locking

This feature allows you to select whether the doors automatically lock during normal vehicle exit. When the vehicle is turned off and all doors are closed, the vehicle will determine how many RKE transmitters remain in the vehicle interior. If at least one RKE

transmitter has been removed from the interior of the vehicle, the doors will lock after eight seconds.

Temporarily disable the locking feature by pressing and holding the power door switch for several seconds with a door open. Passive locking will then remain disabled until the door switch is pressed, or until the vehicle is turned on.

To customize whether the doors automatically lock when exiting the vehicle, see “Remote Locking, Unlocking, Starting” under Vehicle Personalization.

### Keyless Hatch Opening

Press the button on the underside of the hatch and lift up to open if the RKE transmitter is within range and the doors are locked. If the doors are unlocked, the transmitter is not required to open the hatch.

### Programming Transmitters to the Vehicle

Only RKE transmitters programmed to this vehicle will work. If a transmitter is lost or stolen, a replacement can be purchased and programmed through your dealer. When the replacement transmitter is programmed to this vehicle, all remaining transmitters must also be reprogrammed. Any lost or stolen transmitters will no longer work once the new transmitter is programmed. Each vehicle can have up to eight transmitters matched to it.

### Programming with a Recognized Transmitter

A new transmitter can be programmed to the vehicle when there is one recognized transmitter. For vehicles sold in Canada, two recognized transmitters are required to program a new transmitter. To program, the vehicle must be off

and all of the transmitters, both currently recognized and new, must be in the vehicle.

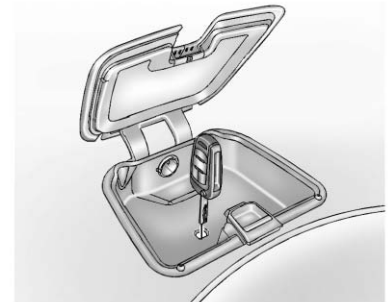

1. Place the recognized transmitter(s) in the cupholder.
2. Insert the vehicle key of the new transmitter into the key lock cylinder on the outside of the driver door and turn the key to the unlock position five times within 10 seconds.

The Driver Information Center (DIC) displays READY FOR REMOTE #2, 3, 4 OR 5.



## 2-6 Keys, Doors, and Windows

---

3. Remove the rubber mat in the instrument panel storage. Extend the key blade on the new transmitter and insert the key blade into the transmitter slot.
4. Press and hold the POWER  button on the center stack for two seconds. When the transmitter is programmed, the DIC will show that it is ready to program the next transmitter.
5. Remove the transmitter from the transmitter slot and press  on the transmitter.

To program additional transmitters, repeat Steps 3–5.

When all additional transmitters are programmed, press and hold the POWER  button for 10 seconds to exit programming mode.

### Programming without a Recognized Transmitter

Non-Canadian (U.S.) owners are permitted to program a new transmitter to their vehicle when a recognized transmitter is not available. The Canadian regulations require that Canadian owners see their dealer for programming new transmitters when two recognized transmitters are not available. If there are no currently recognized transmitters available, follow this procedure to program up to five transmitters. This procedure will take approximately 30 minutes to complete. The vehicle must be off and all of the transmitters must be in the vehicle.

1. Insert the vehicle key of the transmitter into the key lock cylinder on the outside of the driver door and turn the key to the unlock position five times within 10 seconds.

The Driver Information Center (DIC) displays REMOTE LEARN PENDING, PLEASE WAIT.

2. Wait for 10 minutes until the DIC displays PRESS START BUTTON TO LEARN and then press the POWER  button on the center stack.

The DIC display will again show REMOTE LEARN PENDING, PLEASE WAIT.

3. Repeat Step 2 two more times. After the third time, all previously known transmitters will no longer work with the vehicle. Remaining transmitters can be programmed during the next steps.

The DIC display should now show READY FOR REMOTE #1.





4. Remove the rubber mat in the instrument panel storage. Extend the key blade on the new transmitter and insert the key blade into the transmitter slot.
5. Press and hold the POWER  button for two seconds. When the transmitter is programmed, the DIC will show that it is ready to program the next transmitter.

6. Remove the transmitter from the transmitter slot and press  on the transmitter.

To program additional transmitters, repeat Steps 4–6.

When all additional transmitters are programmed, press and hold the POWER  button for 10 seconds to exit programming mode.

### Starting the Vehicle with a Low Transmitter Battery

If the transmitter battery is weak, the DIC may display NO REMOTE DETECTED when you try to start the vehicle. The REPLACE BATTERY IN REMOTE KEY message may also be displayed at this time.

To start the vehicle:

1. Open the instrument panel storage and remove the rubber mat.



2. Extend the key blade and place the blade into the slot.
3. With the vehicle in P (Park) or N (Neutral), press the brake pedal and the POWER  button on the center stack. See *Power Button on page 9-16*.

Replace the transmitter battery as soon as possible.

## 2-8 Keys, Doors, and Windows

---

### Battery Replacement

**Notice:** When replacing the battery, do not touch any of the circuitry on the transmitter. Static from your body could damage the transmitter.

To replace the battery:

1. Extend the key blade and open the battery cover on the back of the unit.
2. Remove the used battery. Avoid touching the circuit board to other components.
3. Insert the new battery, positive side facing down toward the base.
4. Reassemble the battery cover.
5. Check the operation of the transmitter with the vehicle.

### Remote Start

This feature starts the heating or air conditioning systems and rear window defogger from outside the vehicle. Use remote start to heat or



cool the interior when the vehicle is plugged in to maximize the electric range by utilizing electricity from the electrical outlet. Normal operation of the system will return after the vehicle has been turned on.

**(R) (Remote Start):** This button is on the RKE transmitter.

During remote start:

- The climate control system will typically default to the last climate settings. If the fan is off or if Fan Only was selected, the air conditioning or heat will turn on as needed. See *Automatic Climate Control System on page 8-1*.
- If the vehicle has heated seats, and this feature has been enabled through vehicle personalization, the heated seats will turn on during colder outside temperatures. See “Remote Start Heated Seats” under *Heated Front Seats on page 3-5* and “Remote Start

Auto Heated Seats” under *Vehicle Personalization on page 5-51*.

- The rear defogger will turn on during colder outside temperatures.
- Selecting  during colder outside temperatures before shutting the vehicle off will help windshield clearing.
- Shutting the vehicle off in ECO Mode without  selected will minimize the impact to electric range. Shutting the vehicle off in other modes will maximize heating or air conditioning.
- The engine may start to provide energy for heating and cooling, independent of the vehicle being plugged in or completely charged. Engine Assisted Heating operation, if available, can be personalized. See “Engine Assisted Heating” under *Vehicle Personalization on page 5-51*.

- Vehicle range may decrease if the vehicle is not plugged into an electrical outlet. If the vehicle is plugged in, much of the energy needed to support this feature will be provided from the electrical outlet, not from the high voltage battery.



Laws in some communities may restrict the use of features that remotely start the engine. For example, some laws may require a person using the remote start feature to have the vehicle in view when doing so. Check local regulations for any requirements on remote starting of vehicles.

The RKE transmitter range may be less while the vehicle is running.

Other conditions can affect the performance of the transmitter. See *Remote Keyless Entry (RKE) System on page 2-2*.

### Activating the Remote Start

To heat or cool the passenger compartment using remote start:

1. Aim the RKE transmitter at the vehicle.
2. Press and release  on the RKE transmitter; the doors will lock.
3. Immediately, press and hold  until the turn signal lamps flash, or for approximately two seconds. Pressing  again during a remote start will turn the feature off.

Remote start will automatically shut off after 10 minutes unless a time extension is done.

While the remote start is active, the parking lamps will turn on and remain on.

After entering the vehicle during a remote start, press the POWER  button on the center stack with the brake pedal applied to operate as normal.

The remote start can be initiated two separate times between driving. For each remote start, the passenger compartment will be heated or cooled for 10 minutes.

### Extending the Time



To extend the time of the first remote start, repeat the steps for activating remote start. Remote start can only be extended one time between driving.

### Canceling Remote Start

To cancel a remote start, do any of the following:

- Aim the RKE transmitter at the vehicle and press and hold  until the parking lamps turn off.
- Turn on the hazard warning flashers.

## 2-10 Keys, Doors, and Windows

- Press the POWER  button on the center stack, with the brake pedal applied, then press the POWER  button again to turn the vehicle off.

### Conditions in Which Remote Start May Not Work

Conditions in which a remote start may not occur include:

- An open hood.
- Vehicle propulsion system fault conditions, including an emission control system malfunction.
- High voltage battery fault conditions.

A second remote start or extension will not occur if the fuel level is low.

During a remote start, conditions in which a remote start may be canceled include:

- Vehicle propulsion system or high voltage battery fault conditions.

- Low engine oil pressure.
- Engine coolant temperature that is too high.

### Door Locks

#### WARNING

Unlocked doors can be dangerous.

- Passengers, especially children, can easily open the doors and fall out of a moving vehicle. The chance of being thrown out of the vehicle in a crash is increased if the doors are not locked. So, all passengers should wear safety belts properly and the doors should be locked whenever the vehicle is driven.
- Young children who get into unlocked vehicles may be unable to get out. A child can

(Continued)

#### WARNING (Continued)

be overcome by extreme heat and can suffer permanent injuries or even death from heat stroke. Always lock the vehicle whenever leaving it.

- Outsiders can easily enter through an unlocked door when slowing or stopping the vehicle. Lock the doors to help prevent this from happening.

### Keyless Access



When the Remote Keyless Entry (RKE) transmitter is within 1 m (3 ft) of the driver door, the door can be locked and unlocked by pressing the door handle button. When unlocking from the driver door, the first press will unlock only that door; press again within five seconds to unlock all passenger doors. See *Remote Keyless Entry (RKE) System Operation* on page 2-2.

### Key

To unlock or lock the door, turn the key left or right.

### Inside the Vehicle

Push down on the door lock knob to lock that door. Pull once on the door handle to unlock the door and again to open the door. Press the power door lock switch to lock or unlock all doors. See *Power Door Locks* on page 2-11.

### Power Door Locks

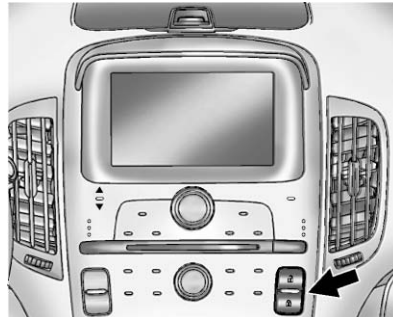

The power door lock switches are on the center stack.

 **(Unlock):** Press to unlock the doors.

 **(Lock):** Press to lock the doors.

### Delayed Locking

This vehicle may have a delayed locking feature. If delayed locking is enabled, a chime will sound to indicate a door or hatch is open when the doors are locked with the power door lock switch. The doors will automatically lock and the theft-deterrent system will arm after all doors are closed and five seconds have passed. Press the lock button again to make the doors lock immediately. Press the unlock switch to cancel the delayed lock operation. To enable this feature, see “Power Door Locks” in *Vehicle Personalization* on page 5-51. To arm and disarm the theft-deterrent system, see *Vehicle Alarm System* on page 2-14.

## 2-12 Keys, Doors, and Windows

### Automatic Door Locks

#### Automatic Door Lock

The doors are programmed to automatically lock when the shift lever is moved out of P (Park).

The automatic door lock feature cannot be disabled.

#### Automatic Door Unlock

The doors can be programmed to automatically unlock when the shift lever is moved into P (Park). See “Power Door Locks” in *Vehicle Personalization* on page 5-51.

### Lockout Protection



If the power door lock switch is pressed when the driver door is open and the vehicle is on, all the doors will lock and then the driver door will unlock.



This feature can also be enabled to function when the vehicle is off. To enable this feature, see “Unlocked Door Anti Lock Out” in *Vehicle Personalization* on page 5-51.

### Safety Locks



The rear door safety locks prevent passengers from opening the rear doors from inside the vehicle.

Press   to activate the rear door safety locks. The indicator light comes on when activated.

Press   again to deactivate the safety locks.

If an inside rear door handle is pulled when the safety lock is activated, that door will remain locked and the indicator light may

flash. Release the handle, then deactivate the safety locks to allow the door to open from the inside handle.

## Doors

### Hatch

#### WARNING

Exhaust gases can enter the vehicle if it is driven in Extended Range Mode with the hatch open, or with any objects that pass through the seal between the body and the hatch. Engine exhaust contains carbon monoxide (CO) which cannot be seen or smelled. It can cause unconsciousness and even death.

If the vehicle must be driven in Extended Range Mode with the hatch open:

- Do not operate in Mountain Mode if driving with the hatch open.
- Close all of the windows.

(Continued)

#### WARNING (Continued)

- Fully open the air outlets on the instrument panel.
- Adjust the climate control system to a setting that brings in only outside air and set the fan speed to the highest setting. See *Automatic Climate Control System* on page 8-1.

For more information about carbon monoxide, see *Engine Exhaust* on page 9-26.

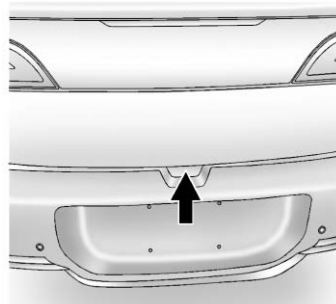

**Keyless Access:** To open the hatch with the vehicle locked, the RKE transmitter must be within 1 m (3 ft) of the trunk. Press the button on the underside of the hatch and lift up. See *Remote Keyless Entry (RKE) System Operation* on page 2-2.

## 2-14 Keys, Doors, and Windows

**Remote Keyless Entry (RKE):** To open the hatch with the vehicle locked, the RKE transmitter must be within 60 m (195 ft) of the vehicle. Unlock the vehicle with the RKE transmitter, then press the button on the underside of the hatch and lift.

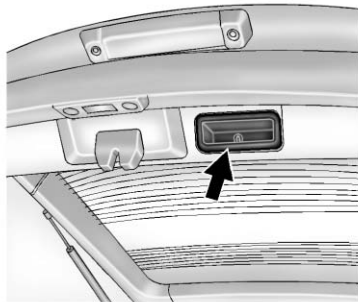

Use the inside pull handle to lower and close the hatch.

Always close the hatch before driving. Do not press the button while closing the hatch; it will unlatch again.

### Vehicle Security

This vehicle has theft-deterrent features; however, they do not make the vehicle impossible to steal.

### Vehicle Alarm System

This vehicle has an anti-theft alarm system.

#### Arming the System

To arm the system, close all of the windows and doors and then:

- Press  on the RKE transmitter.
- Or, lock the vehicle using the power door lock switch in the center stack if Unlocked Door Anti Lock Out is turned off. See “Unlocked Door Anti Lock Out” under *Vehicle Personalization on page 5-51*.

The alarm automatically arms after about 30 seconds.

Pressing  on the RKE transmitter a second time will bypass the 30-second delay and immediately arm the system.

#### Disarming the System



To disarm the system, press  on the RKE transmitter, or if the vehicle has the keyless access system, approach the vehicle with the RKE transmitter.

#### Turning off the System Alarm

If there is an attempt to open the doors, hatch, or hood without first pressing  on the RKE transmitter, the system alarm will be activated. The exterior lamps will flash and the horn will sound, if equipped, for about 30 seconds.



To turn off the system alarm:

- Press  on the RKE transmitter.
- Or, start the vehicle by pressing POWER  on the center stack with the brake pedal applied and the RKE transmitter in the vehicle.

### Charge Cord Theft Alert

To arm or disarm the charge cord theft alert, lock or unlock the vehicle with the RKE transmitter.

If there is an attempt to remove the charge cord while the vehicle is locked, the system alarm will be activated. To turn off the system alarm, press  on the RKE transmitter.

This feature may be disabled through the vehicle personalization. See “Charge Cord Theft Alert” under *Vehicle Personalization on page 5-51*.

### Immobilizer

See *Radio Frequency Statement on page 13-15* for information regarding Part 15 of the Federal Communications Commission (FCC) rules and Industry Canada Standards RSS-GEN/210/220/310.

### Immobilizer Operation

This vehicle has a passive theft-deterrent system. The system does not have to be manually armed or disarmed.

The vehicle is automatically immobilized when the vehicle is turned off.

The system is automatically disarmed when the vehicle is started with a valid RKE transmitter in the vehicle. The RKE transmitter uses electronic coding that matches an immobilizer control unit in the vehicle and automatically disarms the system. Only a correct transmitter can be used to turn the vehicle on.



The security light in the instrument cluster comes on if there is a problem with arming or disarming the theft-deterrent system.

When trying to start the vehicle, the security light comes on briefly when the vehicle is turned on.

If the vehicle does not start and the security light stays on, there is a problem with the system. Attempt to turn the vehicle off and try it again.

Do not leave the RKE transmitter in the vehicle.

### Exterior Mirrors

#### Convex Mirrors

**⚠ WARNING**

A convex mirror can make things, like other vehicles, look farther away than they really are. If you cut too sharply into the right lane, you could hit a vehicle on the right. Check the inside mirror or glance over your shoulder before changing lanes.

The passenger side mirror is convex shaped. A convex mirror's surface is curved so more can be seen from the driver seat.

#### Power Mirrors

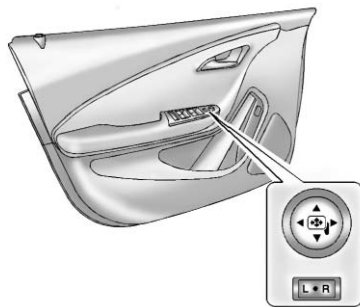

Controls for the outside power mirrors are on the driver door.

To adjust a mirror:

1. Move the selector switch to L (Left) or R (Right) to choose the driver or passenger mirror.
2. Press the arrows on the control pad to move each mirror in the desired direction.
3. Return the selector switch to the center position.

#### Folding Mirrors

##### Manual Folding Mirrors

The mirrors can be folded inward toward the vehicle to prevent damage when going through an automatic car wash. Push the mirror outward to return it to the original position.

##### Power Folding Mirrors

1. If the vehicle is equipped with power folding mirrors, move the selector switch to ● to deselect the mirror.
2. Press the down arrow to fold the mirrors.
3. Press the down arrow again to unfold the mirrors.

## Heated Mirrors

The vehicle may have heated mirrors.

 **(Rear Window Defogger):**  
Press to heat the outside rearview mirrors. See “Rear Window Defogger” under *Automatic Climate Control System on page 8-1*.

## Interior Mirrors

### Manual Rearview Mirror

To adjust the inside rearview mirror, hold the rearview mirror in the center and move it to view the area behind the vehicle.

For vehicles with a manual rearview mirror, push the tab forward for daytime use and pull it for nighttime use to avoid glare from the headlamps from behind.

### Automatic Dimming Rearview Mirror

To adjust the inside rearview mirror, hold the rearview mirror in the center and move it to view the area behind the vehicle.

For vehicles with an automatic dimming rearview mirror, the mirror will automatically reduce the glare from the headlamps from behind. The dimming feature comes on when the vehicle is started.

### Cleaning the Mirror

Do not spray glass cleaner directly on the mirror. Use a soft towel dampened with water.

### Windows

#### WARNING

Never leave a child, a helpless adult, or a pet alone in a vehicle, especially with the windows closed in warm or hot weather. They can be overcome by the extreme heat and suffer permanent injuries or even death from heat stroke.



The vehicle aerodynamics are designed to improve fuel economy performance. This may result in a pulsing sound when either rear window is down and the front windows are up. To reduce the sound, open either a front window or the sunroof, if equipped.

### Power Windows

#### WARNING

Children could be seriously injured or killed if caught in the path of a closing window. Never leave the Remote Keyless Entry (RKE) transmitter in a vehicle with children. When there are children in the rear seat, use the window lockout switch to prevent operation of the windows. See *Keys on page 2-1*.

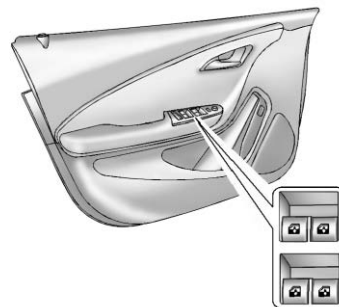

The window switches on the driver door control all windows in the vehicle. Each passenger door has a switch that controls only that window.

Press the front of the switch to open the window. Pull the switch up to close it.

The power windows work when the vehicle is on, or when Retained Accessory Power (RAP) is active. See *Retained Accessory Power (RAP) on page 9-19*.

### Express-Down/Up Windows

Windows with an express-down or up feature allow the window to be lowered or raised without holding the switch. The driver window has express-down and up; the passenger and rear windows have only express-down.

Pull a window switch up or push it down all the way, release it, and the window goes up or down automatically. Stop the window by pushing or pulling the switch.

### Express Window Anti-Pinch Feature

If any object is in the path of the window when the express-up is active, the window will stop at the obstruction and auto-reverse to a preset factory position. Weather conditions such as severe icing may also cause the window to auto-reverse. The window will return to normal operation once the obstruction or condition is removed.

### Express Window Anti-Pinch Override

In an emergency, the anti-pinch feature can be overridden in a supervised mode. Hold the window switch all the way up to the second position. The window will rise for as long as the switch is held. Once the switch is released, the express mode is reactivated.

In this mode, the window can still close on an object in its path. Use care when using the override mode.

### Programming the Power Windows

Programming the power windows may be necessary if the 12-volt battery has been disconnected or discharged.

To program the window:

1. Close all doors with the vehicle on, or when Retained Accessory Power (RAP) is active. See *Retained Accessory Power (RAP)* on page 9-19.

2. Pull the window switch to completely close the window. Continue to hold the window switch two seconds after the window is closed.
3. Repeat for each window.

### Remote Window Operation

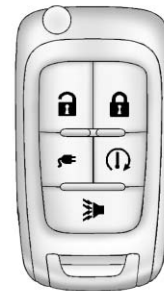

The vehicle may have remote operating windows that will open all the windows from outside the vehicle by pressing and holding  on the Remote Keyless Entry (RKE) transmitter.

## 2-20 Keys, Doors, and Windows

---

This feature can be disabled by a dealer technician.

### Window Lockout



The rear window lockout switch is on the driver door. This feature prevents the rear passenger windows from operating, except from the driver position.

Press  to activate the rear window lockout switch. The indicator light comes on when activated.

Press  again to deactivate the lockout switch.

### Sun Visors

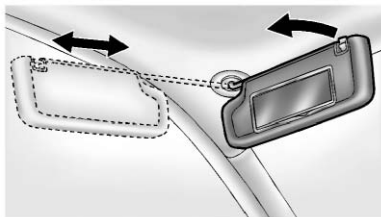

Pull the sun visor down to block glare. Detach the sun visor from the center mount to pivot to the side window, or to extend along the rod, if available.

# Seats and Restraints

## Head Restraints

Head Restraints ..... 3-2

## Front Seats

Seat Adjustment ..... 3-3

Reclining Seatbacks ..... 3-4

Heated Front Seats ..... 3-5

## Rear Seats

Rear Seats ..... 3-7

## Safety Belts

Safety Belts ..... 3-9

How to Wear Safety Belts

Properly ..... 3-10

Lap-Shoulder Belt ..... 3-11

Safety Belt Use During

Pregnancy ..... 3-14

Safety Belt Extender ..... 3-14

Safety System Check ..... 3-15

Safety Belt Care ..... 3-15

Replacing Safety Belt System

Parts after a Crash ..... 3-15

## Airbag System

Airbag System ..... 3-16

Where Are the Airbags? .... 3-18

When Should an Airbag

Inflate? ..... 3-20

What Makes an Airbag

Inflate? ..... 3-21

How Does an Airbag

Restrain? ..... 3-21

What Will You See after an

Airbag Inflates? ..... 3-21

Passenger Sensing

System ..... 3-23

Servicing the Airbag-Equipped

Vehicle ..... 3-27

Adding Equipment to the

Airbag-Equipped Vehicle ... 3-27

Airbag System Check ..... 3-28

Replacing Airbag System

Parts after a Crash ..... 3-29

## Child Restraints

Older Children ..... 3-29

Infants and Young

Children ..... 3-31

Child Restraint Systems .... 3-34

Where to Put the Restraint ... 3-35

Lower Anchors and Tethers

for Children (LATCH

System) ..... 3-37

Replacing LATCH System

Parts After a Crash ..... 3-43

Securing Child Restraints

(Rear Seat) ..... 3-43

Securing Child Restraints

(Front Passenger Seat) .... 3-46

## 3-2 Seats and Restraints

### Head Restraints

#### WARNING

With head restraints that are not installed and adjusted properly, there is a greater chance that occupants will suffer a neck/spinal injury in a crash. Do not drive until the head restraints for all occupants are installed and adjusted properly.

#### Front Seats

The vehicle's front seats have adjustable head restraints in the outboard seating positions.



Adjust the head restraint so that the top of the restraint is at the same height as the top of the occupant's head. This position reduces the chance of a neck injury in a crash.

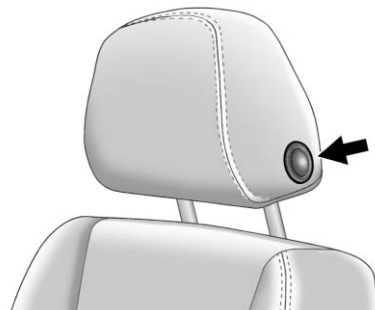

To raise or lower the head restraint, press the button located on the side of the head restraint and pull up or push the head restraint down and release the button.

Pull and push on the head restraint after the button is released to make sure that it is locked in place.

The front seat outboard head restraints are not designed to be removed.



### Rear Seats

The vehicle's rear seats have adjustable head restraints in the outboard seating positions.

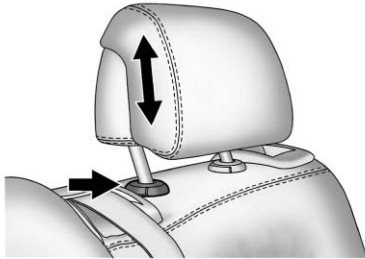

The height of the head restraint can be adjusted. Pull the head restraint up to raise it. Try to move the head restraint to make sure that it is locked in place.

To lower the head restraint, press the button, located on the top of the seatback, and push the head restraint down. Try to move the head restraint after the button is released to make sure that it is locked in place.

If you are installing a child restraint in the rear seat, see “Securing a Child Restraint Designed for the LATCH System” under *Lower Anchors and Tethers for Children (LATCH System)* on page 3-37.

### Front Seats

#### Seat Adjustment

**⚠ WARNING**

You can lose control of the vehicle if you try to adjust a driver seat while the vehicle is moving. Adjust the driver seat only when the vehicle is not moving.

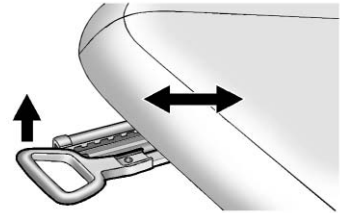

To adjust the seat position:

1. Pull the handle at the front of the seat cushion to unlock it.

## 3-4 Seats and Restraints

2. Move the seat forward or rearward and release the handle.
3. Try to move the seat back and forth to be sure it is locked in place.

### Seat Height Adjuster

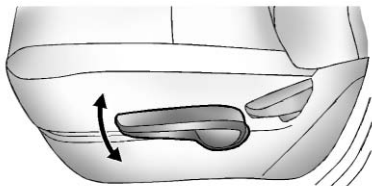

Move the lever up or down to raise or lower the seat.

### Reclining Seatbacks

#### WARNING

If either seatback is not locked, it could move forward in a sudden stop or crash. That could cause injury to the person sitting there. Always push and pull on the seatbacks to be sure they are locked.

To recline the seatback:

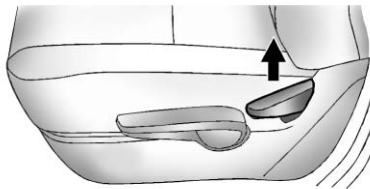

1. Lift the lever.

2. Move the seatback to the desired position, and then release the lever to lock the seatback in place.
3. Push and pull on the seatback to make sure it is locked.

To return the seatback to the upright position:

1. Lift the lever fully without applying pressure to the seatback, and the seatback returns to the upright position.
2. Push and pull on the seatback to make sure it is locked.

#### WARNING

Sitting in a reclined position when the vehicle is in motion can be dangerous. Even when buckled up, the safety belts cannot do their job.

(Continued)

**WARNING (Continued)**

The shoulder belt will not be against your body. Instead, it will be in front of you. In a crash, you could go into it, receiving neck or other injuries.

The lap belt could go up over your abdomen. The belt forces would be there, not at your pelvic bones. This could cause serious internal injuries.

For proper protection when the vehicle is in motion, have the seatback upright. Then sit well back in the seat and wear the safety belt properly.



Do not have a seatback reclined if the vehicle is moving.

**Heated Front Seats****⚠ WARNING**

If you cannot feel temperature change or pain to the skin, the seat heater may cause burns. To reduce the risk of burns, people with such a condition should use care when using the seat heater, especially for long periods of time. Do not place anything on the seat that insulates against heat, such as a blanket, cushion, cover, or similar item. This may cause the seat heater to overheat. An overheated seat heater may cause a burn or may damage the seat.

## 3-6 Seats and Restraints

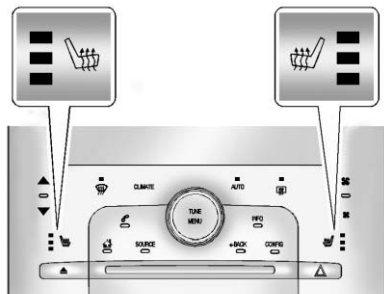

### Navigation System Shown, Base System Similar

If available, the controls are on the center stack. To operate, the vehicle must be on.

Press or to heat the driver or passenger seat cushion and seatback.

Press the button once for the highest setting. With each press of the button, the heated seat will change to the next lower setting, and then the off setting. Three lights indicate the highest setting and one light the lowest.

### Auto Heated Seats

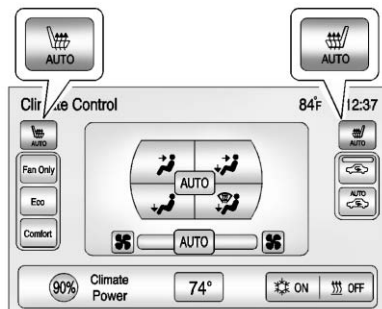

If available, the controls can be accessed while the vehicle is on by pressing the CLIMATE button on the center stack.

Press the touch screen AUTO or AUTO button. The button color will change to green when this feature is on.

When the vehicle is on, this feature will automatically activate the heated seats at the level required by the vehicle's interior temperature.

The active high, medium, low, or off heated seat level will be indicated by the manual heated seat button lights on the center stack. Use the touch screen buttons or the manual heated seat buttons on the center stack to turn auto heated seats off.

If the passenger seat is unoccupied, the auto heated seats feature will not activate that seat.

The auto heated seats feature can be programmed to always be enabled when the vehicle is on. See *Vehicle Personalization on page 5-51*.

### Remote Start Heated Seats

When it is cold outside, the heated seats can be programmed to turn on automatically during a remote vehicle start. Unless the auto heated seats feature is available and enabled, the heated seats will be canceled when the vehicle is turned on. If the vehicle has auto heated seats and the feature is enabled, the seat heating level will automatically change to the level

required by the vehicle's interior temperature when the vehicle is turned on.

The indicator lights on the heated seat buttons do not turn on during a remote start.

The temperature performance of an unoccupied seat may be reduced. This is normal.

The heated seats will not turn on during a remote start unless the heated seats feature is enabled in the vehicle personalization menu. See *Vehicle Personalization on page 5-51*.

## Rear Seats

### Folding the Seatback

 **WARNING**

If either seatback is not locked, it could move forward in a sudden stop or crash. That could cause injury to the person sitting there. Always push and pull on the seatbacks to be sure they are locked.

 **WARNING**

A safety belt that is improperly routed, not properly attached, or twisted will not provide the protection needed in a crash. The person wearing the belt could be seriously injured. After raising the rear seatback, always check to be  
(Continued)

**WARNING (Continued)**

sure that the safety belts are properly routed and attached, and are not twisted.

To fold the seatback down:

**Notice:** Folding a rear seat with the safety belts still fastened may cause damage to the seat or the safety belts. Always unbuckle the safety belts and return them to their normal stowed position before folding a rear seat.

## 3-8 Seats and Restraints

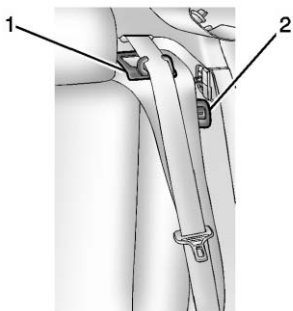

1. Safety Belt Guide
2. Safety Belt Storage Clip

1. Remove the safety belt from the safety belt guide (1) and place it in the storage clip (2).

The safety belt should remain in the storage clip while the seatback is in the folded position.

2. Pull the seatback release lever to unlock the seatback.

A tab near the lever raises when the seatback is unlocked.

3. Fold the seatback forward.

### Raising the Seatback

**Notice:** Damage to the safety belt or seatback locking mechanism can occur if the safety belt is caught between the rear seatback and the seatback locking mechanism. The safety belt must be out of the way when the rear seat is raised to the upright, locked position. If the safety belt is damaged, see your dealer and have it replaced.

To raise the seatback:

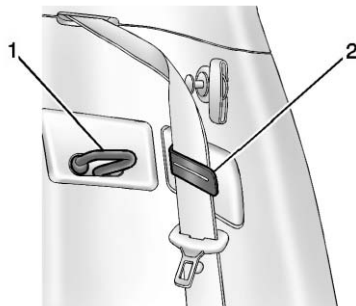

1. Seatback Locking Mechanism

### 2. Safety Belt Storage Clip

1. Make sure the safety belt is in the storage clip (2) before raising the seatback.

The safety belt should not cross the seatback locking mechanism (1) when raising the seatback.

2. Raise the seatback and push it rearward to lock it into place.

A tab near the seatback release lever retracts when the seatback is locked.

3. Push and pull the top of the seatback to be sure it is locked into position.

4. Return the safety belt to the safety belt guide after raising the seatback.

Keep the seat in the upright, locked position when not in use.

## Safety Belts

This section of the manual describes how to use safety belts properly. It also describes some things not to do with safety belts.

### WARNING

Do not let anyone ride where a safety belt cannot be worn properly. In a crash, if you or your passenger(s) are not wearing safety belts, injuries can be much worse than if you are wearing safety belts. You can be seriously injured or killed by hitting things inside the vehicle harder or by being ejected from the vehicle. In addition, anyone who is not buckled up can strike other passengers in the vehicle.

It is extremely dangerous to ride in a cargo area, inside or outside of a vehicle. In a collision, passengers riding in these areas

(Continued)

### WARNING (Continued)

are more likely to be seriously injured or killed. Do not allow passengers to ride in any area of the vehicle that is not equipped with seats and safety belts.

Always wear a safety belt, and check that all passenger(s) are restrained properly too.

This vehicle has indicators as a reminder to buckle the safety belts. See *Safety Belt Reminders* on page 5-14.

## Why Safety Belts Work

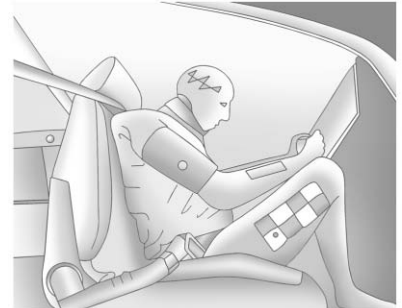

When riding in a vehicle, you travel as fast as the vehicle does. If the vehicle stops suddenly, you keep going until something stops you. It could be the windshield, the instrument panel, or the safety belts!

When you wear a safety belt, you and the vehicle slow down together. There is more time to stop because you stop over a longer distance and, when worn properly, your strongest bones take the forces from the

## 3-10 Seats and Restraints

safety belts. That is why wearing safety belts makes such good sense.

### Questions and Answers About Safety Belts

**Q: Will I be trapped in the vehicle after a crash if I am wearing a safety belt?**

**A:** You *could* be — whether you are wearing a safety belt or not. Your chance of being conscious during and after a crash, so you *can* unbuckle and get out, is *much* greater if you are belted.

**Q: If my vehicle has airbags, why should I have to wear safety belts?**

**A:** Airbags are supplemental systems only; so they work *with* safety belts — not instead of them. Whether or not an airbag is provided, all occupants still have to buckle up to get the most protection.

Also, in nearly all states and in all Canadian provinces, the law requires wearing safety belts.

### How to Wear Safety Belts Properly

This section is only for people of adult size.

There are special things to know about safety belts and children. And there are different rules for smaller children and infants. If a child will be riding in the vehicle, see *Older Children on page 3-29* or *Infants and Young Children on page 3-31*. Follow those rules for everyone's protection.

It is very important for all occupants to buckle up. Statistics show that unbelted people are hurt more often in crashes than those who are wearing safety belts.

There are important things to know about wearing a safety belt properly.

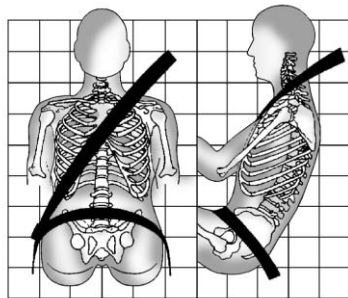

- Sit up straight and always keep your feet on the floor in front of you.
- Always use the correct buckle for your seating position.
- Wear the lap part of the belt low and snug on the hips, just touching the thighs. In a crash, this applies force to the strong pelvic bones and you would be less likely to slide under the lap belt. If you slid under it, the belt would apply force on your abdomen. This could cause serious or even fatal injuries.



- Wear the shoulder belt over the shoulder and across the chest. These parts of the body are best able to take belt restraining forces. The shoulder belt locks if there is a sudden stop or crash.

**⚠ WARNING**

You can be seriously injured, or even killed, by not wearing your safety belt properly.

- Never allow the lap or shoulder belt to become loose or twisted.
- Never wear the shoulder belt under both arms or behind your back.
- Never route the lap or shoulder belt over an armrest.

### Lap-Shoulder Belt

All seating positions in the vehicle have a lap-shoulder belt.

The following instructions explain how to wear a lap-shoulder belt properly.

1. If the seat has a safety belt guide, and the safety belt is not routed through the guide, slide the edge of the belt webbing through the opening on the guide. Be sure the belt is not twisted.
2. Adjust the seat, if the seat is adjustable, so you can sit up straight. To see how, see “Seats” in the Index.
3. Pick up the latch plate and pull the belt across you. Do not let it get twisted.

The lap-shoulder belt may lock if you pull the belt across you very quickly. If this happens, let the belt go back slightly to unlock it. Then pull the belt across you more slowly.

If the shoulder portion of a passenger belt is pulled out all the way, the child restraint locking feature may be engaged. If this happens, let the belt go back all the way and start again.



4. Push the latch plate into the buckle until it clicks. Pull up on the latch plate to make sure it is secure. If the belt is not long enough, see *Safety Belt Extender on page 3-14*.

## 3-12 Seats and Restraints

Position the release button on the buckle so that the safety belt could be quickly unbuckled if necessary.

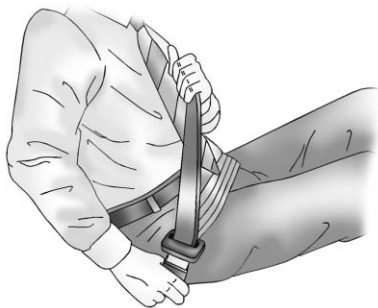

5. To make the lap part tight, pull up on the shoulder belt.

It may be necessary to pull stitching on the safety belt through the latch plate to fully tighten the lap belt on smaller occupants.

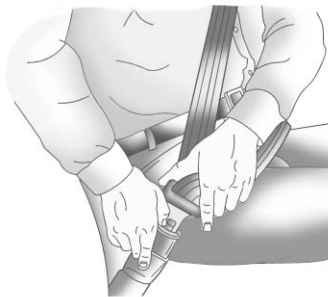

To unlatch the belt, push the button on the buckle. The belt should return to its stowed position.

Before a door is closed, be sure the safety belt is out of the way. If a door is slammed against a safety belt, damage can occur to both the safety belt and the vehicle.

### Safety Belt Pretensioners

This vehicle has safety belt pretensioners for front outboard occupants. Although the safety belt pretensioners cannot be seen, they are part of the safety belt assembly.

They can help tighten the safety belts during the early stages of a moderate to severe frontal, near frontal, or rear crash if the threshold conditions for pretensioner activation are met.

And, if the vehicle has side impact airbags, safety belt pretensioners can help tighten the safety belts in a side crash or a rollover event.

Pretensioners work only once. If the pretensioners activate in a crash, they need to be replaced, and other new parts for the vehicle's safety belt system may be required. See *Replacing Safety Belt System Parts after a Crash on page 3-15*.

### Rear Safety Belt Comfort Guides

This vehicle may have rear safety belt comfort guides. If not, they are available through your dealer. The guides may provide added safety belt comfort for older children who have outgrown booster seats and for some adults. When installed and

properly adjusted, the comfort guide positions the belt away from the neck and head.

There is one guide, if equipped, for each outside passenger position in the rear seat. When using a comfort guide, remove the safety belt from the seat-mounted guide before using the comfort guide. To install a comfort guide to the safety belt:

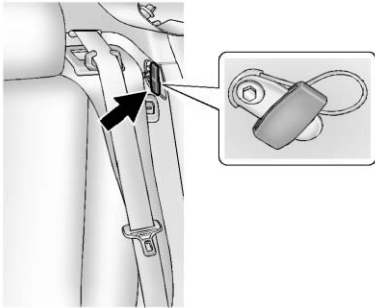

1. Remove the guide from its storage clip on the interior body trim next to the rear seat.

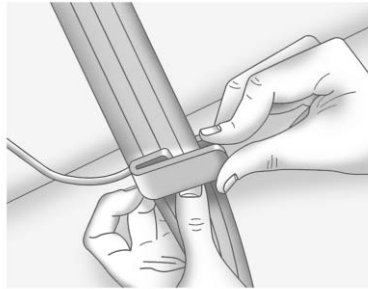

2. Place the guide over the belt, and insert the two edges of the belt into the slots of the guide.

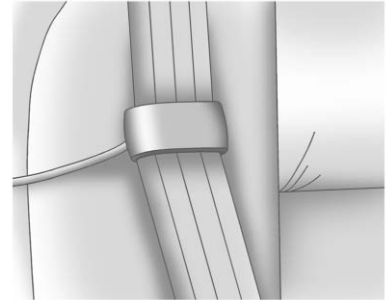

3. The belt should not be twisted and it should lie flat. The elastic cord must be under the belt and the guide on top.

**⚠ WARNING**

A safety belt that is not properly worn may not provide the protection needed in a crash. The person wearing the belt could be seriously injured. The shoulder belt should go over the shoulder

(Continued)

## 3-14 Seats and Restraints

### WARNING (Continued)

and across the chest. These parts of the body are best able to take belt restraining forces.

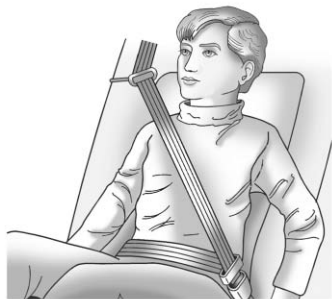

4. Buckle and position the safety belt as described previously in this section. Make sure that the shoulder belt crosses the shoulder.

To remove and store the comfort guide, squeeze the belt edges together so that the safety belt can

be removed from the guide. Slide the guide back into its storage clip located on the interior body trim next to the side of the seatback.

### Safety Belt Use During Pregnancy

Safety belts work for everyone, including pregnant women. Like all occupants, they are more likely to be seriously injured if they do not wear safety belts.



A pregnant woman should wear a lap-shoulder belt, and the lap portion should be worn as low as possible, below the rounding, throughout the pregnancy.

The best way to protect the fetus is to protect the mother. When a safety belt is worn properly, it is more likely that the fetus will not be hurt in a crash. For pregnant women, as for anyone, the key to making safety belts effective is wearing them properly.

### Safety Belt Extender

If the vehicle's safety belt will fasten around you, you should use it.

But if a safety belt is not long enough, your dealer will order you an extender. When you go in to order it, take the heaviest coat you will wear, so the extender will be long enough for you. To help avoid personal injury, do not let someone else use it, and use it only for the seat it is made to fit. The extender has been designed for adults. Never

use it for securing child seats. To wear it, attach it to the regular safety belt. See the instruction sheet that comes with the extender.

### Safety System Check

Now and then, check that the safety belt reminder light, safety belts, buckles, latch plates, retractors, and anchorages are all working properly. Look for any other loose or damaged safety belt system parts that might keep a safety belt system from doing its job. See your dealer to have it repaired. Torn or frayed safety belts may not protect you in a crash. They can rip apart under impact forces. If a belt is torn or frayed, get a new one right away.

Make sure the safety belt reminder light is working. See *Safety Belt Reminders on page 5-14*.

Keep safety belts clean and dry. See *Safety Belt Care on page 3-15*.

### Safety Belt Care

Keep belts clean and dry.

#### WARNING

Do not bleach or dye safety belts. It may severely weaken them. In a crash, they might not be able to provide adequate protection. Clean safety belts only with mild soap and lukewarm water.

### Replacing Safety Belt System Parts after a Crash

#### WARNING

A crash can damage the safety belt system in the vehicle. A damaged safety belt system may not properly protect the person using it, resulting in serious injury or even death in a

(Continued)

#### WARNING (Continued)

crash. To help make sure the safety belt systems are working properly after a crash, have them inspected and any necessary replacements made as soon as possible.

After a minor crash, replacement of safety belts may not be necessary. But the safety belt assemblies that were used during any crash may have been stressed or damaged. See your dealer to have the safety belt assemblies inspected or replaced.

New parts and repairs may be necessary even if the safety belt system was not being used at the time of the crash.

Have the safety belt pretensioners checked if the vehicle has been in a crash, or if the airbag readiness light stays on after you start the vehicle or while you are driving. See *Airbag Readiness Light* on page 5-15.

### Airbag System

The vehicle has the following airbags:

- A frontal airbag for the driver.
- A frontal airbag for the front outboard passenger.
- A knee airbag for the driver.
- A knee airbag for the front outboard passenger.
- A seat-mounted side impact airbag for the driver.
- A seat-mounted side impact airbag for the front outboard passenger.
- A roof-rail airbag for the driver and the passenger seated directly behind the driver.
- A roof-rail airbag for the front outboard passenger and the passenger seated directly behind the front outboard passenger.

All of the airbags in the vehicle will have the word AIRBAG embossed in the trim or on an attached label near the deployment opening.

For frontal airbags, the word AIRBAG is on the center of the steering wheel for the driver and on the instrument panel for the front outboard passenger.

For knee airbags, the word AIRBAG is on the lower part of the instrument panel.

For seat-mounted side impact airbags, the word AIRBAG is on the side of the seatback closest to the door.

For roof-rail airbags, the word AIRBAG is on the ceiling or trim.

Airbags are designed to supplement the protection provided by safety belts. Even though today's airbags are also designed to help reduce the risk of injury from the force of an inflating bag, all airbags must inflate very quickly to do their job.

Here are the most important things to know about the airbag system:

 **WARNING**

You can be severely injured or killed in a crash if you are not wearing your safety belt, even with airbags. Airbags are designed to work with safety belts, not replace them. Also, airbags are not designed to inflate in every crash. In some crashes safety belts are the only restraint. See *When Should an Airbag Inflate?* on page 3-20.

Wearing your safety belt during a crash helps reduce the chance of hitting things inside the vehicle or being ejected from it. Airbags are “supplemental restraints” to the safety belts. Everyone in the vehicle should wear a safety belt properly, whether or not there is an airbag for that person.

 **WARNING**

Because airbags inflate with great force and faster than the blink of an eye, anyone who is up against, or very close to any airbag when it inflates can be seriously injured or killed. Do not sit unnecessarily close to any airbag, as you would be if sitting on the edge of the seat or leaning forward. Safety belts help keep you in position before and during a crash. Always wear a safety belt, even with airbags. The driver should sit as far back as possible while still maintaining control of the vehicle.

Occupants should not lean on or sleep against the door or side windows in seating positions with seat-mounted side impact airbags and/or roof-rail airbags.

 **WARNING**

Children who are up against, or very close to, any airbag when it inflates can be seriously injured or killed. Airbags plus lap-shoulder belts offer protection for adults and older children, but not for young children and infants. Neither the vehicle's safety belt system nor its airbag system is designed for them. Young children and infants need the protection that a child restraint system can provide. Always secure children properly in the vehicle. To read how, see *Older Children* on page 3-29 or *Infants and Young Children* on page 3-31.



There is an airbag readiness light on the instrument cluster, which shows the airbag symbol. The system checks the airbag electrical system for malfunctions. The light tells you if there is an electrical problem. See *Airbag Readiness Light* on page 5-15 for more information.

### Where Are the Airbags?

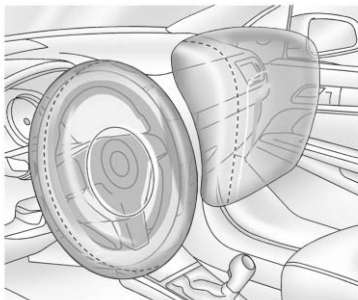

The driver frontal airbag is in the center of the steering wheel.

The front outboard passenger frontal airbag is in the passenger side instrument panel.

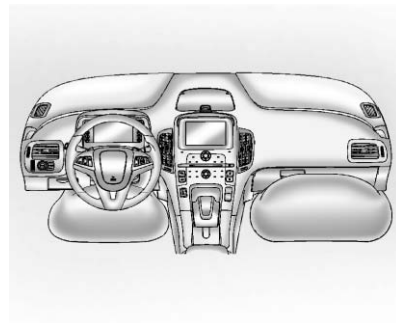

The driver knee airbag is below the steering column. The front outboard passenger knee airbag is below the glove box.





**Driver Side Shown, Passenger Side Similar**

The driver and front outboard passenger seat-mounted side impact airbags are in the side of the seatbacks closest to the door.



**Driver Side Shown, Passenger Side Similar**

The roof-rail airbags for the driver, front outboard passenger, and second row outboard passengers are in the ceiling above the side windows.

**⚠ WARNING**

If something is between an occupant and an airbag, the airbag might not inflate properly or it might force the object into

(Continued)

**WARNING (Continued)**

that person causing severe injury or even death. The path of an inflating airbag must be kept clear. Do not put anything between an occupant and an airbag, and do not attach or put anything on the steering wheel hub or on or near any other airbag covering.

Do not use seat accessories that block the inflation path of a seat-mounted side impact airbag.

Never secure anything to the roof of a vehicle with roof-rail airbags by routing a rope or tie-down through any door or window opening. If you do, the path of an inflating roof-rail airbag will be blocked.

### When Should an Airbag Inflate?

Frontal airbags are designed to inflate in moderate to severe frontal or near frontal crashes to help reduce the potential for severe injuries, mainly to the driver's or front outboard passenger's head and chest. However, they are only designed to inflate if the impact exceeds a predetermined deployment threshold. Deployment thresholds are used to predict how severe a crash is likely to be in time for the airbags to inflate and help restrain the occupants.

Whether the frontal airbags will or should inflate is not based primarily on how fast the vehicle is traveling. It depends on what you hit, the direction of the impact, and how quickly the vehicle slows down.

Frontal airbags may inflate at different crash speeds depending on whether the vehicle hits an object straight on or at an angle, and

whether the object is fixed or moving, rigid or deformable, narrow or wide.

Thresholds can also vary with specific vehicle design.

Frontal airbags are not intended to inflate during vehicle rollovers, in rear impacts, or in many side impacts.

In addition the vehicle has dual-stage frontal airbags. Dual-stage airbags adjust the restraint according to crash severity.

The vehicle has electronic frontal sensors, which help the sensing system distinguish between a moderate frontal impact and a more severe frontal impact. For moderate frontal impacts, dual-stage airbags inflate at a level less than full deployment. For more severe frontal impacts, full deployment occurs.

Frontal knee airbags are single-stage airbags and designed to inflate in moderate to severe

frontal or near frontal impacts that exceed a predetermined deployment threshold.

The vehicle has seat-mounted side impact airbags and roof-rail airbags. See *Airbag System* on page 3-16. Seat-mounted side impact and roof-rail airbags are intended to inflate in moderate to severe side crashes. In addition, these roof-rail airbags are intended to inflate during a rollover or in a severe frontal impact. Seat-mounted side impact and roof-rail airbags will inflate if the crash severity is above the system's designed threshold level. The threshold level can vary with specific vehicle design.

Roof-rail airbags are not intended to inflate in rear impacts. A seat-mounted side impact airbag is intended to inflate on the side of the vehicle that is struck. Both roof-rail airbags will inflate when either side of the vehicle is struck or the sensing system predicts that the vehicle is about to roll over on its side, or in a severe frontal impact.

In any particular crash, no one can say whether an airbag should have inflated simply because of the vehicle damage or repair costs.

## What Makes an Airbag Inflate?

In a deployment event, the sensing system sends an electrical signal triggering a release of gas from the inflator. Gas from the inflator fills the airbag causing the bag to break out of the cover. The inflator, the airbag, and related hardware are all part of the airbag module.

For airbag location, see *Where Are the Airbags?* on page 3-18.

## How Does an Airbag Restrain?

In moderate to severe frontal or near frontal collisions, even belted occupants can contact the steering wheel or the instrument panel. In

moderate to severe side collisions, even belted occupants can contact the inside of the vehicle.

Airbags supplement the protection provided by safety belts by distributing the force of the impact more evenly over the occupant's body.

Rollover capable roof-rail airbags are designed to help contain the head and chest of occupants in the outboard seating positions in the first and second rows. The rollover capable roof-rail airbags are designed to help reduce the risk of full or partial ejection in rollover events, although no system can prevent all such ejections.

But airbags would not help in many types of collisions, primarily because the occupant's motion is not toward those airbags. See *When Should an Airbag Inflate?* on page 3-20.

Airbags should never be regarded as anything more than a supplement to safety belts.

## What Will You See after an Airbag Inflates?

After the frontal airbags and seat-mounted side impact airbags inflate, they quickly deflate, so quickly that some people may not even realize an airbag inflated. Roof-rail airbags may still be at least partially inflated for some time after they inflate. Some components of the airbag module may be hot for several minutes. For location of the airbags, see *Where Are the Airbags?* on page 3-18.

The parts of the airbag that come into contact with you may be warm, but not too hot to touch. There may be some smoke and dust coming from the vents in the deflated airbags. Airbag inflation does not prevent the driver from seeing out of the windshield or being able to steer the vehicle, nor does it prevent people from leaving the vehicle.

## 3-22 Seats and Restraints

### WARNING

When an airbag inflates, there may be dust in the air. This dust could cause breathing problems for people with a history of asthma or other breathing trouble. To avoid this, everyone in the vehicle should get out as soon as it is safe to do so. If you have breathing problems but cannot get out of the vehicle after an airbag inflates, then get fresh air by opening a window or a door. If you experience breathing problems following an airbag deployment, you should seek medical attention.

The vehicle has a feature that may automatically unlock the doors, turn on the interior lamps and hazard warning flashers, and shut off the fuel system after the airbags inflate.

You can lock the doors, and turn off the interior lamps and hazard warning flashers by using the controls for those features.

### WARNING

A crash severe enough to inflate the airbags may have also damaged important functions in the vehicle, such as the fuel system, brake and steering systems, etc. Even if the vehicle appears to be drivable after a moderate crash, there may be concealed damage that could make it difficult to safely operate the vehicle.

Use caution if attempting to restart the vehicle after a crash has occurred.

In many crashes severe enough to inflate the airbag, windshields are broken by vehicle deformation.

Additional windshield breakage may also occur from the front outboard passenger airbag.

- Airbags are designed to inflate only once. After an airbag inflates, you will need some new parts for the airbag system. If you do not get them, the airbag system will not be there to help protect you in another crash. A new system will include airbag modules and possibly other parts. The service manual for the vehicle covers the need to replace other parts.
- The vehicle has a crash sensing and diagnostic module which records information after a crash. See *Vehicle Data Recording and Privacy on page 13-13* and *Event Data Recorders on page 13-14*.
- Let only qualified technicians work on the airbag systems. Improper service can mean that

an airbag system will not work properly. See your dealer for service.

## Passenger Sensing System

The vehicle has a passenger sensing system for the front outboard passenger position. The passenger airbag status indicator will light on the overhead console when the vehicle is started.



**United States**



**Canada**

The words ON and OFF or the symbol for on and off will be visible during the system check. When the system check is complete, either the word ON or OFF, or the symbol for on and off will be visible. See *Passenger Airbag Status Indicator on page 5-16*.

The passenger sensing system turns off the front outboard passenger frontal airbag and knee airbag, under certain conditions. No other airbag is affected by the passenger sensing system.

The passenger sensing system works with sensors that are part of the front outboard passenger seat. The sensors are designed to detect the presence of a properly seated occupant and determine if the front

outboard passenger frontal airbag and knee airbag should be allowed to inflate or not.

According to accident statistics, children are safer when properly secured in a rear seat in a correct child restraint for their weight and size.

We recommend that children be secured in a rear seat, including: an infant or a child riding in a rear-facing child restraint; a child riding in a forward-facing child seat; an older child riding in a booster seat; and children, who are large enough, using safety belts.

Never put a rear-facing child seat in the front. This is because the risk to the rear-facing child is so great, if the airbag inflates.

## 3-24 Seats and Restraints

### WARNING

A child in a rear-facing child restraint can be seriously injured or killed if the passenger frontal airbag inflates. This is because the back of the rear-facing child restraint would be very close to the inflating airbag. A child in a forward-facing child restraint can be seriously injured or killed if the passenger frontal airbag inflates and the passenger seat is in a forward position.

Even if the passenger sensing system has turned off the front outboard passenger airbag(s), no system is fail-safe. No one can guarantee that an airbag will not inflate under some unusual circumstance, even though the airbag(s) are off.

(Continued)

### WARNING (Continued)

Secure rear-facing child restraints in a rear seat, even if the airbag(s) are off. If you secure a forward-facing child restraint in the front outboard passenger seat, always move the seat as far back as it will go. It is better to secure the child restraint in a rear seat.

The passenger sensing system is designed to turn off the front outboard passenger airbag and knee airbag if:

- The front outboard passenger seat is unoccupied.
- The system determines that an infant is present in a child restraint.
- A front outboard passenger takes his/her weight off of the seat for a period of time.

- Or, if there is a critical problem with the airbag system or the passenger sensing system.

When the passenger sensing system has turned off the front outboard passenger frontal airbag and knee airbag, the off indicator will light and stay lit to remind you that the airbags are off. See *Passenger Airbag Status Indicator* on page 5-16.

The passenger sensing system is designed to turn on the front outboard passenger frontal airbag and knee airbag anytime the system senses that a person of adult size is sitting properly in the front outboard passenger seat.

When the passenger sensing system has allowed the airbags to be enabled, the on indicator will light and stay lit as a reminder that the airbags are active.

For some children, including children in child restraints, and for very small adults, the passenger sensing system may or may not turn

off the front outboard passenger frontal airbag and knee airbag, depending upon the person's seating posture and body build. Everyone in the vehicle who has outgrown child restraints should wear a safety belt properly — whether or not there is an airbag for that person.

 **WARNING**

If the airbag readiness light ever comes on and stays on, it means that something may be wrong with the airbag system. To help avoid injury to yourself or others, have the vehicle serviced right away. See *Airbag Readiness Light* on page 5-15 for more information, including important safety information.

**If the On Indicator Is Lit for a Child Restraint**

If a child restraint has been installed and the on indicator is lit:

1. Turn the vehicle off.
2. Remove the child restraint from the vehicle.
3. Remove any additional items from the seat such as blankets, cushions, seat covers, seat heaters, or seat massagers.
4. Reinstall the child restraint following the directions provided by the child restraint manufacturer and refer to *Securing Child Restraints (Front Passenger Seat)* on page 3-46 or *Securing Child Restraints (Rear Seat)* on page 3-43.
5. If, after reinstalling the child restraint and restarting the vehicle, the on indicator is still lit, turn the vehicle off. Then slightly recline the vehicle seatback and adjust the seat cushion, if adjustable, to make sure that the vehicle seatback is not pushing the child restraint into the seat cushion.  
  
Also make sure the child restraint is not trapped under the vehicle head restraint. If this happens, adjust the head restraint. See *Head Restraints* on page 3-2.
6. Restart the vehicle.  
  
The passenger sensing system may or may not turn off the airbags for a child in a child restraint depending upon the child's seating posture and body build. It is better to secure a child restraint in a rear seat.

### If the Off Indicator Is Lit for an Adult-Size Occupant



If a person of adult size is sitting in the front outboard passenger seat, but the off indicator is lit, it could be because that person is not sitting properly in the seat. Use the following steps to allow the system to detect that person and enable the front outboard passenger frontal airbag and knee airbag:

1. Turn the vehicle off.

2. Remove any additional material from the seat, such as blankets, cushions, seat covers, seat heaters, seat massagers, a laptop, or other electronic devices.
3. Place the seatback in the fully upright position.
4. Have the person sit upright in the seat, centered on the seat cushion, with legs comfortably extended.
5. Restart the vehicle and have the person remain in this position for two to three minutes after the on indicator is lit.

### Additional Factors Affecting System Operation

Safety belts help keep the passenger in position on the seat during vehicle maneuvers and braking, which helps the passenger sensing system maintain the passenger airbag status. See “Safety Belts” and “Child Restraints”

in the Index for additional information about the importance of proper restraint use.

A thick layer of additional material, such as a blanket or cushion, or aftermarket equipment such as seat covers, seat heaters, and seat massagers can affect how well the passenger sensing system operates. We recommend that you not use seat covers or other aftermarket equipment except when approved by GM for your specific vehicle. See *Adding Equipment to the Airbag-Equipped Vehicle* on page 3-27 for more information about modifications that can affect how the system operates.

A wet seat can affect the performance of the passenger sensing system. Here is how:

- The passenger sensing system may turn off the passenger frontal airbag and passenger knee airbag when liquid is soaked into the seat. If this happens, the off indicator will be



lit, and the airbag readiness light on the instrument panel will also be lit.

- Liquid pooled on the seat that has not soaked in may make it more likely that the passenger sensing system will turn on the passenger frontal airbag and passenger knee airbag while a child restraint or child occupant is on the seat. If the passenger frontal airbag and passenger knee airbag are turned on, the on indicator will be lit.

If the passenger seat gets wet, dry the seat immediately. If the airbag readiness light is lit, do not install a child restraint or allow anyone to occupy the seat. See *Airbag Readiness Light* on page 5-15 for important safety information.

The on indicator may be lit if an object, such as a briefcase, handbag, grocery bag, laptop, or other electronic device, is put on

an unoccupied seat. If this is not desired, remove the object from the seat.

 **WARNING**

Stowing of articles under the passenger seat or between the passenger seat cushion and seatback may interfere with the proper operation of the passenger sensing system.

### Servicing the Airbag-Equipped Vehicle

Airbags affect how the vehicle should be serviced. There are parts of the airbag system in several places around the vehicle. Your dealer and the service manual have information about servicing the vehicle and the airbag system. To purchase a service manual, see *Service Publications Ordering Information* on page 13-11.

 **WARNING**

For up to 10 seconds after the vehicle is turned off and the 12-volt battery is disconnected, an airbag can still inflate during improper service. You can be injured if you are close to an airbag when it inflates. Avoid yellow connectors. They are probably part of the airbag system. Be sure to follow proper service procedures, and make sure the person performing work for you is qualified to do so.

### Adding Equipment to the Airbag-Equipped Vehicle

Adding accessories that change the vehicle's frame, bumper system, height, front end, or side sheet metal may keep the airbag system from working properly.

## 3-28 Seats and Restraints

---

The operation of the airbag system can also be affected by changing or moving any parts of the front seats, safety belts, airbag sensing and diagnostic module, steering wheel, instrument panel, roof-rail airbag modules, ceiling or pillar garnish trim, overhead console, front sensors, side impact sensors, rollover sensor module, or airbag wiring.

Your dealer and the service manual have information about the location of the airbag sensors, sensing and diagnostic module, and airbag wiring.

In addition, the vehicle has a passenger sensing system that includes sensors as part of the front outboard passenger seat. The passenger sensing system may not operate properly if the original seat trim is replaced with non-GM covers, upholstery, or trim; or with GM covers, upholstery, or trim designed for a different vehicle. Any object, such as an aftermarket seat heater or a comfort-enhancing pad

or device, installed under or on top of the seat fabric, could also interfere with the operation of the passenger sensing system. This could either prevent proper deployment of the passenger airbag(s) or prevent the passenger sensing system from properly turning off the passenger airbag(s). See *Passenger Sensing System* on page 3-23.

If the vehicle has rollover roof-rail airbags, see *Different Size Tires and Wheels* on page 10-55 for additional important information.

If your vehicle needs to be modified because you have a disability and you have questions about whether the modifications will affect the vehicle's airbag system, or if you have questions about whether the airbag system will be affected if the vehicle is modified for any other reason, call Customer Assistance. See *Customer Assistance Offices* on page 13-3.

### Airbag System Check

The airbag system does not need regularly scheduled maintenance or replacement. Make sure the airbag readiness light is working. See *Airbag Readiness Light* on page 5-15.

**Notice:** If an airbag covering is damaged, opened, or broken, the airbag may not work properly. Do not open or break the airbag coverings. If there are any opened or broken airbag covers, have the airbag covering and/or airbag module replaced. For the location of the airbags, see *Where Are the Airbags?* on page 3-18. See your dealer for service.

## Replacing Airbag System Parts after a Crash

### WARNING

A crash can damage the airbag systems in the vehicle. A damaged airbag system may not work properly and may not protect you and your passenger(s) in a crash, resulting in serious injury or even death. To help make sure the airbag systems are working properly after a crash, have them inspected and any necessary replacements made as soon as possible.

If an airbag inflates or the vehicle has been in a crash, the sensing system may shut down the high voltage system. When this occurs, the high voltage battery is disconnected and the vehicle will not start. The SERVICE VEHICLE SOON message in the Driver

Information Center (DIC) will be displayed. Before the vehicle can be operated again, it must be serviced at your dealer.

If an airbag inflates, you will need to replace airbag system parts. See your dealer for service.

If the airbag readiness light stays on after the vehicle is started or comes on when you are driving, the airbag system may not work properly. Have the vehicle serviced right away. See *Airbag Readiness Light on page 5-15* for more information.

## Child Restraints

### Older Children

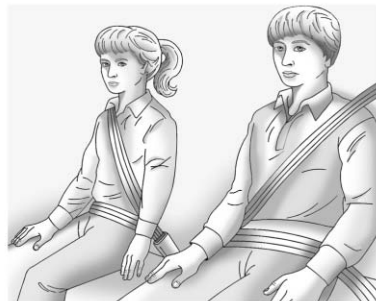

Older children who have outgrown booster seats should wear the vehicle safety belts.

## 3-30 Seats and Restraints

The manufacturer instructions that come with the booster seat state the weight and height limitations for that booster. Use a booster seat with a lap-shoulder belt until the child passes the fit test below:

- Sit all the way back on the seat. Do the knees bend at the seat edge? If yes, continue. If no, return to the booster seat.
- Buckle the lap-shoulder belt. Does the shoulder belt rest on the shoulder? If yes, continue. If no, try using the rear safety belt comfort guide. See “Rear Safety Belt Comfort Guides” under *Lap-Shoulder Belt on page 3-11*. If the shoulder belt still does not rest on the shoulder, then return to the booster seat.
- Does the lap belt fit low and snug on the hips, touching the thighs? If yes, continue. If no, return to the booster seat.

- Can proper safety belt fit be maintained for the length of the trip? If yes, continue. If no, return to the booster seat.

**Q: What is the proper way to wear safety belts?**

- A:** An older child should wear a lap-shoulder belt and get the additional restraint a shoulder belt can provide. The shoulder belt should not cross the face or neck. The lap belt should fit snugly below the hips, just touching the top of the thighs. This applies belt force to the child’s pelvic bones in a crash. It should never be worn over the abdomen, which could cause severe or even fatal internal injuries in a crash.

Also see “Rear Safety Belt Comfort Guides” under *Lap-Shoulder Belt on page 3-11*.

According to accident statistics, children and infants are safer when properly restrained in a child restraint system or infant restraint system secured in a rear seating position.

In a crash, children who are not buckled up can strike other people who are buckled up, or can be thrown out of the vehicle. Older children need to use safety belts properly.

 **WARNING**

Never allow more than one child to wear the same safety belt. The safety belt cannot properly spread the impact forces. In a crash, they can be crushed together and seriously injured. A safety belt must be used by only one person at a time.

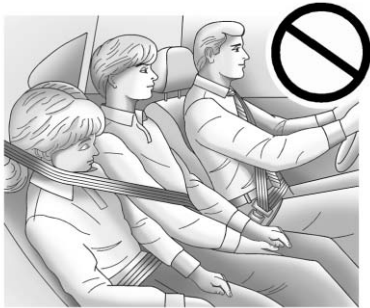

**⚠ WARNING**

Never allow a child to wear the safety belt with the shoulder belt behind their back. A child can be seriously injured by not wearing the lap-shoulder belt properly. In a crash, the child would not be restrained by the shoulder belt. The child could move too far forward increasing the chance of head and neck injury. The child might also slide under the lap

(Continued)

**WARNING (Continued)**

belt. The belt force would then be applied right on the abdomen. That could cause serious or fatal injuries. The shoulder belt should go over the shoulder and across the chest.



### Infants and Young Children

Everyone in a vehicle needs protection! This includes infants and all other children. Neither the distance traveled nor the age and size of the traveler changes the need, for everyone, to use safety restraints. In fact, the law in every state in the United States and in every Canadian province says children up to some age must be restrained while in a vehicle.

**⚠ WARNING**

Children can be seriously injured or strangled if a shoulder belt is wrapped around their neck and the safety belt continues to tighten. Never leave children unattended in a vehicle and never allow children to play with the safety belts.

## 3-32 Seats and Restraints

Airbags plus lap-shoulder belts offer protection for adults and older children, but not for young children and infants. Neither the vehicle's safety belt system nor its airbag system is designed for them. Every time infants and young children ride in vehicles, they should have the protection provided by appropriate child restraints.

Children who are not restrained properly can strike other people, or can be thrown out of the vehicle.

### WARNING

Never hold an infant or a child while riding in a vehicle. Due to crash forces, an infant or a child will become so heavy it is not possible to hold it during a crash. For example, in a crash at only 40 km/h (25 mph), a 5.5 kg (12 lb) infant will suddenly become a 110 kg (240 lb) force on a person's

(Continued)

### WARNING (Continued)

arms. An infant should be secured in an appropriate restraint.



### WARNING

Children who are up against, or very close to, any airbag when it inflates can be seriously injured or killed. Never put a rear-facing

(Continued)

### WARNING (Continued)

child restraint in the right front seat. Secure a rear-facing child restraint in a rear seat. It is also better to secure a forward-facing child restraint in a rear seat. If you must secure a forward-facing child restraint in the right front seat, always move the front passenger seat as far back as it will go.



**Q: What are the different types of add-on child restraints?**

**A:** Add-on child restraints, which are purchased by the vehicle owner, are available in four basic types. Selection of a particular restraint should take into consideration not only the child's weight, height, and age but also whether or not the restraint will be compatible with the motor vehicle in which it will be used.

For most basic types of child restraints, there are many different models available. When purchasing a child restraint, be sure it is designed to be used in a motor vehicle. If it is, the restraint will have a label saying that it meets federal motor vehicle safety standards.

The restraint manufacturer instructions that come with the restraint state the weight and height limitations for a particular child restraint. In addition, there

are many kinds of restraints available for children with special needs.

**⚠ WARNING**

To reduce the risk of neck and head injury during a crash, infants need complete support. In a crash, if an infant is in a rear-facing child restraint, the crash forces can be distributed across the strongest part of an infant's body, the back and shoulders. Infants should always be secured in rear-facing child restraints.

**⚠ WARNING**

A young child's hip bones are still so small that the vehicle's regular safety belt may not remain low on the hip bones, as it should. Instead, it may settle up around the child's abdomen. In a crash, the belt would apply force on a body area that is unprotected by any bony structure. This alone could cause serious or fatal injuries. To reduce the risk of serious or fatal injuries during a crash, young children should always be secured in appropriate child restraints.

**Child Restraint Systems**

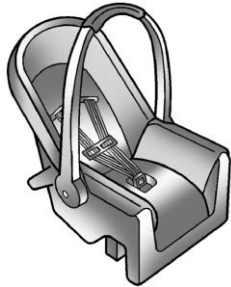

**Rear-Facing Infant Seat**

A rear-facing infant seat provides restraint with the seating surface against the back of the infant.

The harness system holds the infant in place and, in a crash, acts to keep the infant positioned in the restraint.



**Forward-Facing Child Seat**

A forward-facing child seat provides restraint for the child's body with the harness.

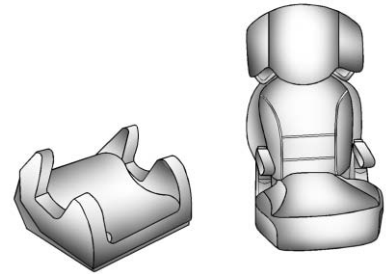

**Booster Seats**

A booster seat is a child restraint designed to improve the fit of the vehicle's safety belt system. A booster seat can also help a child to see out the window.



## Securing an Add-On Child Restraint in the Vehicle

### WARNING

A child can be seriously injured or killed in a crash if the child restraint is not properly secured in the vehicle. Secure the child restraint properly in the vehicle using the vehicle safety belt or LATCH system, following the instructions that came with that child restraint and the instructions in this manual.

To help reduce the chance of injury, the child restraint must be secured in the vehicle. Child restraint systems must be secured in vehicle seats by lap belts or the lap belt portion of a lap-shoulder belt, or by the LATCH system. See *Lower Anchors and Tethers for Children (LATCH System)* on page 3-37.

Children can be endangered in a crash if the child restraint is not properly secured in the vehicle.

When securing an add-on child restraint, refer to the instructions that come with the restraint which may be on the restraint itself or in a booklet, or both, and to this manual. The child restraint instructions are important, so if they are not available, obtain a replacement copy from the manufacturer.

Keep in mind that an unsecured child restraint can move around in a collision or sudden stop and injure people in the vehicle. Be sure to properly secure any child restraint in the vehicle — even when no child is in it.

In some areas, Certified Child Passenger Safety Technicians (CPSTs) are available to inspect and demonstrate how to correctly use and install child restraints. In the U.S., refer to the National Highway Traffic Safety Administration (NHTSA) website to

locate the nearest child safety seat inspection station. For CPST availability in Canada, check with Transport Canada or the Provincial Ministry of Transportation office.

## Securing the Child within the Child Restraint

### WARNING

A child can be seriously injured or killed in a crash if the child is not properly secured in the child restraint. Secure the child properly following the instructions that came with that child restraint.

## Where to Put the Restraint

According to accident statistics, children and infants are safer when properly restrained in a child restraint system or infant restraint system secured in a rear seating position.

## 3-36 Seats and Restraints

We recommend that children and child restraints be secured in a rear seat, including: an infant or a child riding in a rear-facing child restraint; a child riding in a forward-facing child seat; an older child riding in a booster seat; and children, who are large enough, using safety belts.

A label on the sun visor says, "Never put a rear-facing child restraint in the front." This is because the risk to the rear-facing child is so great, if the airbag deploys.

### **WARNING**

A child in a rear-facing child restraint can be seriously injured or killed if the right front passenger airbag inflates. This is because the back of the rear-facing child restraint would be very close to the inflating airbag. A child in a forward-facing child restraint can be seriously

(Continued)

### **WARNING (Continued)**

injured or killed if the right front passenger airbag inflates and the passenger seat is in a forward position.

Even if the passenger sensing system has turned off the right front passenger airbag(s), no system is fail-safe. No one can guarantee that an airbag will not deploy under some unusual circumstance, even though the airbag(s) are turned off.

Secure rear-facing child restraints in a rear seat, even if the airbag(s) are off. If you secure a forward-facing child restraint in the right front seat, always move the front passenger seat as far back as it will go. It is better to secure the child restraint in a rear seat.

(Continued)

### **WARNING (Continued)**

See *Passenger Sensing System* on page 3-23 for additional information.

When securing a child restraint in a rear seating position, study the instructions that came with the child restraint to make sure it is compatible with this vehicle.

Child restraints and booster seats vary considerably in size, and some may fit in certain seating positions better than others. Always make sure the child restraint is properly secured.

Depending on where you place the child restraint and the size of the child restraint, you may not be able to access adjacent safety belt assemblies or LATCH anchors for additional passengers or child restraints. Adjacent seating positions should not be used if the

child restraint prevents access to or interferes with the routing of the safety belt.

Wherever a child restraint is installed, be sure to secure the child restraint properly.

Keep in mind that an unsecured child restraint can move around in a collision or sudden stop and injure people in the vehicle. Be sure to properly secure any child restraint in the vehicle — even when no child is in it.

## Lower Anchors and Tethers for Children (LATCH System)

The LATCH system secures a child restraint during driving or in a crash. LATCH attachments on the child restraint are used to attach the child restraint to the anchors in the vehicle. This system is designed to make installation of a child restraint easier.

Make sure that a LATCH-compatible child restraint is properly installed using the anchors, or use the vehicle's safety belts to secure the restraint, following the instructions that came with that restraint, and also the instructions in this manual. When installing a child restraint with a top tether, you must also use either the lower anchors or the safety belts to properly secure the child restraint. A child restraint must never be attached using only the top tether and anchor.

In order to use the LATCH system in your vehicle, you need a child restraint that has LATCH attachments. The child restraint manufacturer will provide you with instructions on how to use the child restraint and its attachments. The following explains how to attach a child restraint with these attachments in the vehicle.

Not all vehicle seating positions or child restraints have lower anchors and attachments or top tether anchors and attachments.

## Lower Anchors

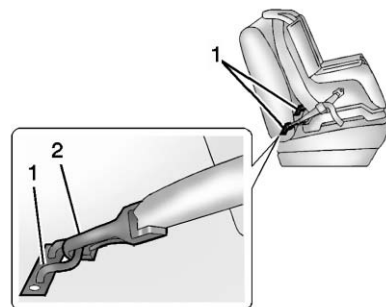

Lower anchors (1) are metal bars built into the vehicle. There are two lower anchors for each LATCH seating position that will accommodate a child restraint with lower attachments (2).

## 3-38 Seats and Restraints

### Top Tether Anchor

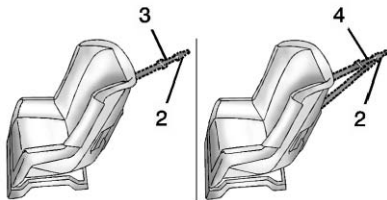

A top tether (3, 4) anchors the top of the child restraint to the vehicle. A top tether anchor is built into the vehicle. The top tether attachment (2) on the child restraint connects to the top tether anchor in the vehicle in order to reduce the forward movement and rotation of the child restraint during driving or in a crash.

The child restraint may have a single tether (3) or a dual tether (4). Either will have a single attachment (2) to secure the top tether to the anchor.

Some child restraints that have a top tether are designed for use with or without the top tether being attached. Others require the top tether always to be attached. Be sure to read and follow the instructions for the child restraint. In Canada, the law requires that forward-facing child restraints have a top tether, and that the tether be attached. Be sure to read and follow the instructions for your child restraint.

### Lower Anchor and Top Tether Anchor Locations

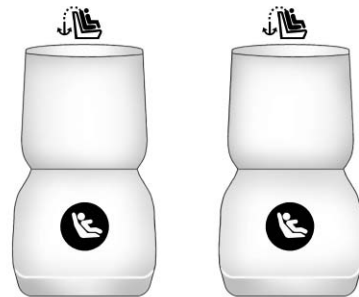

#### Rear Seat

 **(Top Tether Anchor):** Seating positions with top tether anchors.

 **(Lower Anchor):** Seating positions with two lower anchors.



To assist in locating the lower anchors, each seating position with lower anchors has two labels, near the crease between the seatback and the seat cushion.



To assist in locating the top tether anchors, the top tether anchor symbol is near the top tether anchor.

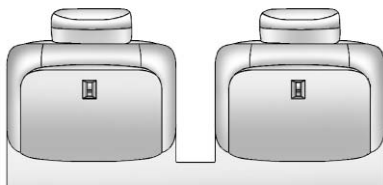

### Top Tether Anchors

The top tether anchors for outboard rear seating positions are on the back of the rear seatback. Be sure to use an anchor on the same side of the vehicle as the seating position where the child restraint will be placed.

Do not secure a child restraint in a position without a top tether anchor if a national or local law requires that the top tether be attached, or if the instructions that come with the child restraint say that the top tether must be attached.

According to accident statistics, children and infants are safer when properly restrained in a child

restraint system or infant restraint system secured in a rear seating position. See *Where to Put the Restraint* on page 3-35 for additional information.

### Securing a Child Restraint Designed for the LATCH System

#### WARNING

If a LATCH-type child restraint is not attached to anchors, the child restraint will not be able to protect the child correctly. In a crash, the child could be seriously injured or killed. Install a LATCH-type child restraint properly using the anchors, or use the vehicle safety belts to secure the restraint, following the instructions that came with the child restraint and the instructions in this manual.

### WARNING

Do not attach more than one child restraint to a single anchor. Attaching more than one child restraint to a single anchor could cause the anchor or attachment to come loose or even break during a crash. A child or others could be injured. To reduce the risk of serious or fatal injuries during a crash, attach only one child restraint per anchor.

### WARNING

Children can be seriously injured or strangled if a shoulder belt is wrapped around their neck and the safety belt continues to tighten. Buckle any unused safety belts behind the child restraint so children cannot reach them. Pull the shoulder belt all the way out

(Continued)

### WARNING (Continued)

of the retractor to set the lock, if the vehicle has one, after the child restraint has been installed.

**Notice:** Do not let the LATCH attachments rub against the vehicle's safety belts. This may damage these parts. If necessary, move buckled safety belts to avoid rubbing the LATCH attachments.

**Do not fold the empty rear seat with a safety belt buckled. This could damage the safety belt or the seat. Unbuckle and return the safety belt to its stowed position, before folding the seat.**

If you need to secure more than one child restraint in the rear seat, see *Where to Put the Restraint on page 3-35*.

This system is designed to make the installation of child restraints easier. When using lower anchors,

do not use the vehicle's safety belts. Instead, use the vehicle's anchors and child restraint attachments to secure the restraints. Some restraints also use another vehicle anchor to secure a top tether.

1. Attach and tighten the lower attachments to the lower anchors. If the child restraint does not have lower attachments or the desired seating position does not have lower anchors, secure the child restraint with the top tether and the safety belts. Refer to your child restraint manufacturer instructions and the instructions in this manual.
  - 1.1. Find the lower anchors for the desired seating position.
  - 1.2. Put the child restraint on the seat.

If the head restraint interferes with the proper installation of the child restraint, the head restraint

may be removed. See “Head Restraint Removal and Reinstallation” at the end of this section.

- 1.3. Attach and tighten the lower attachments on the child restraint to the lower anchors.
2. If the child restraint manufacturer recommends that the top tether be attached, attach and tighten the top tether to the top tether anchor, if equipped. Refer to the child restraint instructions and the following steps:
  - 2.1. Find the top tether anchor on the back of the rear seatback.

- 2.2. Route, attach, and tighten the top tether according to your child restraint instructions and the following instructions:

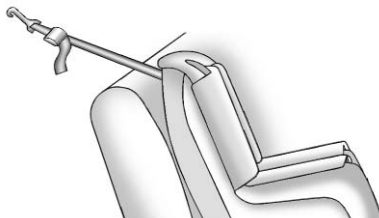

If the position you are using does not have a headrest or head restraint, or the headrest or head restraint has been removed, and you are using a single tether, route the tether over the seatback.

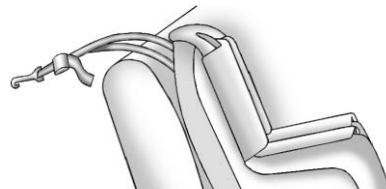

If the position you are using does not have a headrest or head restraint, or the headrest or head restraint has been removed, and you are using a dual tether, route the tether over the seatback.

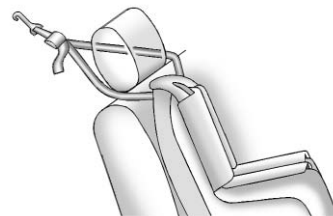

## 3-42 Seats and Restraints

If the rear outboard seating position you are using has an adjustable head restraint and you are using a dual tether, route the tether around the head restraint.

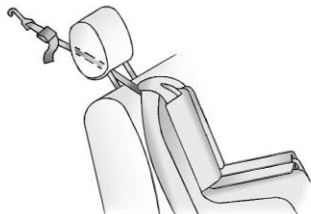

If the rear outboard seating position you are using has an adjustable head restraint and you are using a single tether, raise the head restraint and route the tether under the head restraint and in between the head restraint posts.

3. Before placing a child in the child restraint, make sure it is securely held in place. To check, grasp the child restraint at the LATCH path and attempt to move it side to side and back and forth. There should be no more than 2.5 cm (1 in) of movement for proper installation.

### Head Restraint Removal and Reinstallation

The rear outboard head restraints can be removed if they interfere with the proper installation of the child restraint.

To remove the head restraint:

1. Partially fold the seatback forward. See *Rear Seats on page 3-7* for additional information.

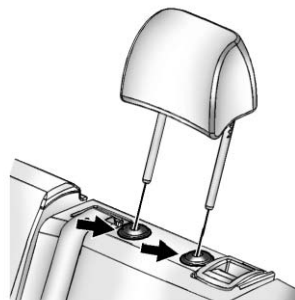

2. Press both buttons on the head restraint posts at the same time, and pull up on the head restraint.
3. Store the head restraint in the cargo area of the vehicle.
4. When the child restraint is removed, reinstall the head restraint before the seating position is used.



**⚠ WARNING**

With head restraints that are not installed and adjusted properly, there is a greater chance that occupants will suffer a neck/spinal injury in a crash. Do not drive until the head restraints for all occupants are installed and adjusted properly.

To reinstall the head restraint:

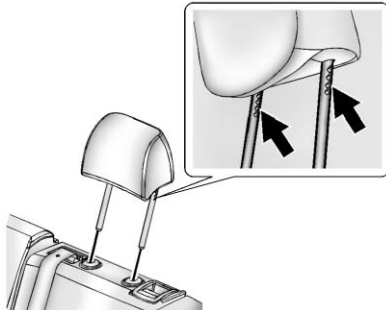

1. Insert the head restraint posts into the holes in the top of the seatback. The notches on the posts must face the driver side of the vehicle.
2. Push the head restraint down. If necessary, press the height adjustment release button to further lower the head restraint. See *Head Restraints on page 3-2*.
3. Try to move the head restraint to make sure that it is locked in place.

**Replacing LATCH System Parts After a Crash**

**⚠ WARNING**

A crash can damage the LATCH system in the vehicle. A damaged LATCH system may not properly secure the child restraint, resulting in serious injury or even  
(Continued)

**WARNING (Continued)**

death in a crash. To help make sure the LATCH system is working properly after a crash, see your dealer to have the system inspected and any necessary replacements made as soon as possible.

If the vehicle has the LATCH system and it was being used during a crash, new LATCH system parts may be needed.

New parts and repairs may be necessary even if the LATCH system was not being used at the time of the crash.

**Securing Child Restraints (Rear Seat)**

When securing a child restraint in a rear seating position, study the instructions that came with the child restraint to make sure it is compatible with this vehicle.

## 3-44 Seats and Restraints

If the child restraint has the LATCH system, see *Lower Anchors and Tethers for Children (LATCH System)* on page 3-37 for how and where to install the child restraint using LATCH. If a child restraint is secured in the vehicle using a safety belt and it uses a top tether, see *Lower Anchors and Tethers for Children (LATCH System)* on page 3-37 for top tether anchor locations.

Do not secure a child seat in a position without a top tether anchor if a national or local law requires that the top tether be anchored, or if the instructions that come with the child restraint say that the top strap must be anchored.

If the child restraint does not have the LATCH system, you will be using the safety belt to secure the child restraint in this position. Be sure to follow the instructions that came with the child restraint. Secure the child in the child restraint when and as the instructions say.

If more than one child restraint needs to be installed in the rear seat, be sure to read *Where to Put the Restraint* on page 3-35.

1. Put the child restraint on the seat.

If the head restraint interferes with the proper installation of the child restraint, the head restraint may be removed. See “Head Restraint Removal and Reinstallation” under *Lower Anchors and Tethers for Children (LATCH System)* on page 3-37.

2. Remove the safety belt from the guide on the seatback by sliding the webbing through the opening on the guide. Do not secure the child restraint with the safety belt routed through the guide.
3. Pick up the latch plate, and run the lap and shoulder portions of the vehicle’s safety belt through or around the restraint. The child restraint instructions will show you how.

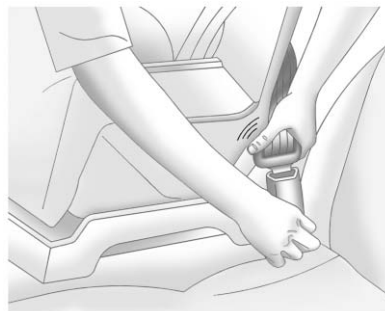

4. Push the latch plate into the buckle until it clicks.

Position the release button on the buckle so that the safety belt could be quickly unbuckled if necessary.



5. Pull the shoulder belt all the way out of the retractor to set the lock. When the retractor lock is set, the belt can be tightened but not pulled out of the retractor.

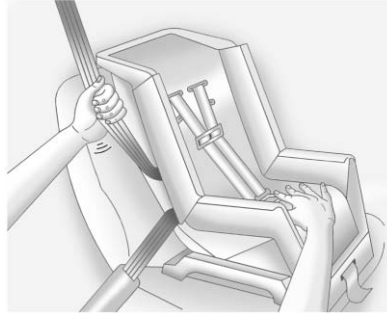

6. To tighten the belt, push down on the child restraint, pull the shoulder portion of the belt to tighten the lap portion of the belt, and feed the shoulder belt back into the retractor. When installing a forward-facing child restraint, it may be helpful to use your knee to push down on the child restraint as you tighten the belt.

Try to pull the belt out of the retractor to make sure the retractor is locked. If the retractor is not locked, repeat Steps 5 and 6.

7. If the child restraint has a top tether, follow the child restraint manufacturer's instructions regarding the use of the top tether. See *Lower Anchors and Tethers for Children (LATCH System)* on page 3-37 for more information.
8. Before placing a child in the child restraint, make sure it is securely held in place. To check, grasp the child restraint at the safety belt path and attempt to move it side to side and back and forth. When the child restraint is properly installed, there should be no more than 2.5 cm (1 in) of movement.

To remove the child restraint, unbuckle the vehicle safety belt and let it return to the stowed position. If the top tether is attached to a top tether anchor, disconnect it. If the head restraint was removed, reinstall it before the seating position is used. See "Head Restraint Removal and Reinstallation" under *Lower Anchors*

## 3-46 Seats and Restraints

and Tethers for Children (LATCH System) on page 3-37 for additional information on installing the head restraint properly.

If the seat has a safety belt guide, return the safety belt into the guide on the seatback by sliding the webbing through the opening on the guide.

### Securing Child Restraints (Front Passenger Seat)

This vehicle has airbags. A rear seat is a safer place to secure a forward-facing child restraint. See *Where to Put the Restraint on page 3-35*.

In addition, the vehicle has a passenger sensing system which is designed to turn off the right front passenger frontal airbag and passenger knee airbag under certain conditions. See *Passenger Sensing System on page 3-23* and *Passenger Airbag Status Indicator*

on page 5-16 for more information, including important safety information.

A label on the sun visor says, "Never put a rear-facing child seat in the front." This is because the risk to the rear-facing child is so great, if the airbag deploys.

#### WARNING

A child in a rear-facing child restraint can be seriously injured or killed if the right front passenger airbag inflates. This is because the back of the rear-facing child restraint would be very close to the inflating airbag. A child in a forward-facing child restraint can be seriously injured or killed if the right front passenger airbag inflates and the passenger seat is in a forward position.

(Continued)

#### WARNING (Continued)

Even if the passenger sensing system has turned off the right front passenger airbag(s), no system is fail-safe. No one can guarantee that an airbag will not deploy under some unusual circumstance, even though the airbag(s) are turned off.

Secure rear-facing child restraints in a rear seat, even if the airbag(s) are off. If you secure a forward-facing child restraint in the right front seat, always move the front passenger seat as far back as it will go. It is better to secure the child restraint in a rear seat.

See *Passenger Sensing System on page 3-23* for additional information.

If the child restraint has the LATCH system, see *Lower Anchors and Tethers for Children (LATCH System)* on page 3-37 for how and where to install the child restraint using LATCH. If a child restraint is secured using a safety belt and it uses a top tether, see *Lower Anchors and Tethers for Children (LATCH System)* on page 3-37 for top tether anchor locations.

Do not secure a child seat in a position without a top tether anchor if a national or local law requires that the top tether be anchored, or if the instructions that come with the child restraint say that the top strap must be anchored.

In Canada, the law requires that forward-facing child restraints have a top tether, and that the tether be attached.

You will be using the lap-shoulder belt to secure the child restraint in this position. Follow the instructions that came with the child restraint.

1. Move the seat as far back as it will go before securing the forward-facing child restraint.

When the passenger sensing system has turned off the right front passenger frontal airbag and passenger knee airbag, the off indicator on the passenger airbag status indicator should light and stay lit when you start the vehicle. See *Passenger Airbag Status Indicator* on page 5-16.

2. Put the child restraint on the seat.
3. Pick up the latch plate, and run the lap and shoulder portions of the vehicle's safety belt through or around the restraint. The child restraint instructions will show you how.

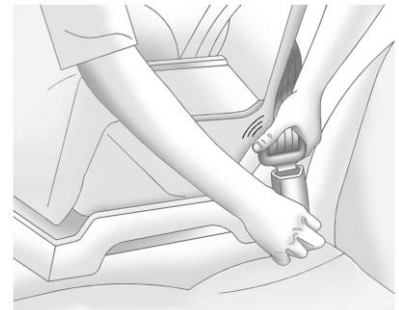

4. Push the latch plate into the buckle until it clicks.

Position the release button on the buckle so that the safety belt could be quickly unbuckled if necessary.

## 3-48 Seats and Restraints



5. Pull the shoulder belt all the way out of the retractor to set the lock. When the retractor lock is set, the belt can be tightened but not pulled out of the retractor.

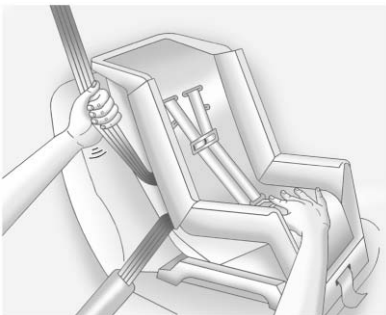

6. To tighten the belt, push down on the child restraint, pull the shoulder portion of the belt to tighten the lap portion of the belt, and feed the shoulder belt back into the retractor. When installing a forward-facing child restraint, it may be helpful to use your knee to push down on the child restraint as you tighten the belt.

Try to pull the belt out of the retractor to make sure the retractor is locked. If the retractor is not locked, repeat Steps 5 and 6.

7. Before placing a child in the child restraint, make sure it is securely held in place. To check, grasp the child restraint at the safety belt path and attempt to move it side to side and back and forth. When the child restraint is properly installed, there should be no more than 2.5 cm (1 in) of movement.

If the airbags are off, the off indicator in the passenger airbag status indicator will come on and stay on when the vehicle is started.

If a child restraint has been installed and the on indicator is lit, see "If the On Indicator Is Lit for a Child Restraint" under *Passenger Sensing System* on page 3-23 for more information.

To remove the child restraint, unbuckle the vehicle safety belt and let it return to the stowed position.

## Storage

### Storage Compartments

Instrument Panel Storage . . . . .	4-1
Glove Box . . . . .	4-1
Floor Console Storage . . . . .	4-1
Umbrella Storage . . . . .	4-4

### Additional Storage Features

Cargo Cover . . . . .	4-4
-----------------------	-----

## Storage Compartments

### Instrument Panel Storage

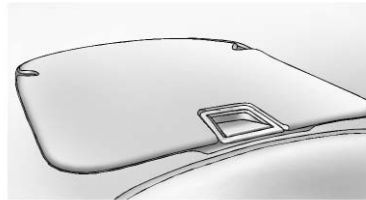

There is a storage compartment on top of the instrument panel that includes an auxiliary power outlet.

Inside is a transmitter slot for the Remote Keyless Entry (RKE) transmitter. See *Remote Keyless Entry (RKE) System Operation* on page 2-2.

### Glove Box

Open the glove box by lifting up on the lever.

## Floor Console Storage

### Front Console

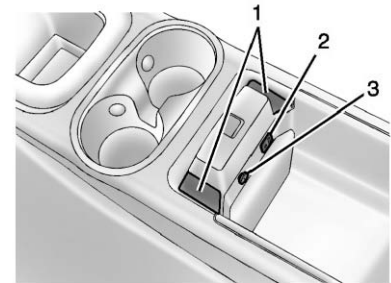

In the armrest storage area there is an auxiliary jack (2) and auxiliary power outlet (3). Cords from accessories can be routed through the pass-thru (1) on each side. See “Auxiliary Devices” in the infotainment manual.

## 4-2 Storage

### Rear Console

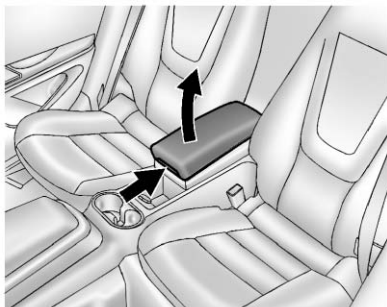

Lift the handle to access the storage area.

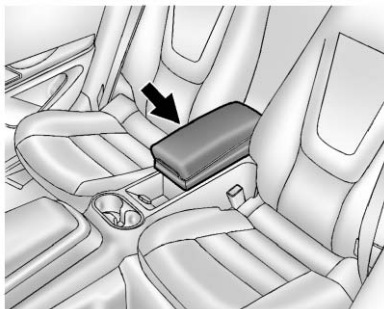

The armrest storage bin is removable.

### **WARNING**

An unsecured armrest storage bin could strike people in a sudden stop or turn, or in a crash. Store the armrest storage bin securely or remove it from the vehicle.

### Removal

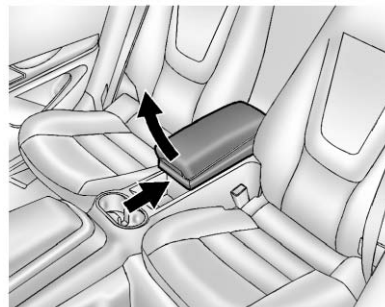

To remove the armrest storage bin, push the button and lift the armrest storage bin up.



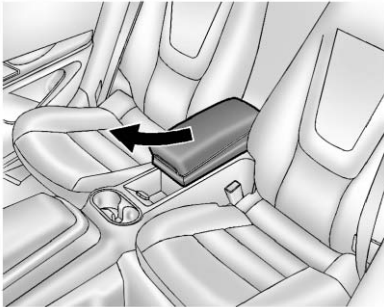

Move the armrest storage bin forward to release it from the rear bracket.

### Installation

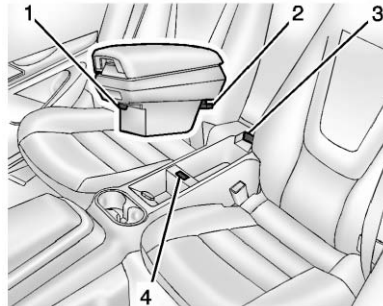

To install the armrest storage bin, align the bracket (2) on the rear of the armrest storage bin into the slot (3) on the rear console and push the armrest down until the latch (1) locks into the opening (4).

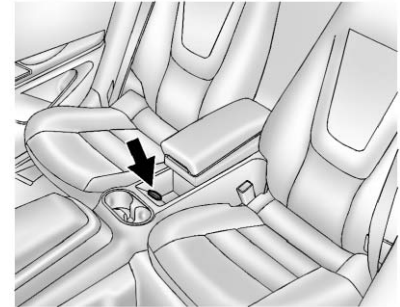

### Removable Armrest Storage Bin Shown

The console also has an auxiliary power outlet. See "Auxiliary Devices" in the infotainment manual.

## 4-4 Storage

---

### Umbrella Storage



Slide an umbrella into the opening on either the driver or passenger door.

### Additional Storage Features

#### Cargo Cover

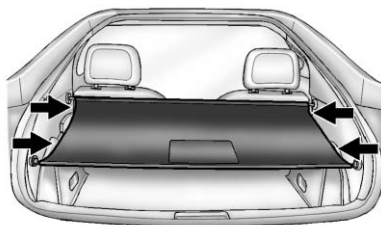

There is a cover for the rear cargo area. Use the four cargo cover loops to hook the cover to the side panels.

# Instruments and Controls

## Instrument Panel Overview

Instrument Panel Overview .... 5-3

## Controls

Steering Wheel Adjustment ... 5-5  
 Steering Wheel Controls ..... 5-5  
 Horn ..... 5-6  
 Pedestrian Friendly Alert ..... 5-6  
 Windshield Wiper/Washer ..... 5-6  
 Power Outlets ..... 5-7

## Warning Lights, Gauges, and Indicators

Warning Lights, Gauges, and Indicators ..... 5-8  
 Instrument Cluster ..... 5-8  
 Speedometer ..... 5-12  
 Odometer ..... 5-12  
 Trip Odometer ..... 5-13  
 Compass ..... 5-13  
 Battery Gauge (High Voltage) ..... 5-13  
 Fuel Gauge ..... 5-13  
 Driver Efficiency Gauge ..... 5-14

Total Vehicle Range ..... 5-14  
 Safety Belt Reminders ..... 5-14  
 Airbag Readiness Light ..... 5-15  
 Passenger Airbag Status Indicator ..... 5-16  
 Charging System Light (12-Volt Battery) ..... 5-17  
 Malfunction Indicator Lamp ..... 5-17  
 Brake System Warning Light ..... 5-20  
 Electric Parking Brake Light ..... 5-20  
 Service Electric Parking Brake Light ..... 5-20  
 Antilock Brake System (ABS) Warning Light ..... 5-21  
 Sport Mode Light ..... 5-21  
 Mountain Mode Light ..... 5-21  
 Hold Mode Light ..... 5-22  
 Lane Departure Warning (LDW) Light ..... 5-22  
 Forward Collision Alert (FCA) Warning Light ..... 5-22  
 Traction Off Light ..... 5-22  
 StabiliTrak® OFF Light ..... 5-23  
 Traction Control System (TCS)/StabiliTrak® Light .... 5-23

Engine Coolant Temperature Warning Light ..... 5-23  
 Tire Pressure Light ..... 5-24  
 Engine Oil Pressure Light .... 5-24  
 Low Fuel Warning Light ..... 5-25  
 Security Light ..... 5-25  
 Vehicle Ready Light ..... 5-25  
 High-Beam On Light ..... 5-25  
 Lamps On Reminder ..... 5-25  
 Cruise Control Light ..... 5-26  
 Door, Hood, or Hatch Open Light ..... 5-26

## Information Displays

Center Stack Display ..... 5-27  
 Power Flows ..... 5-27  
 Programmable Charging .... 5-29  
 Energy Information ..... 5-39  
 Clock ..... 5-40  
 Driver Information Center (DIC) ..... 5-41

## Vehicle Messages

Vehicle Messages ..... 5-43  
 Battery and Charging Messages ..... 5-43  
 Brake System Messages .... 5-44  
 Cruise Control Messages .... 5-44  
 Door Ajar Messages ..... 5-44

## 5-2 Instruments and Controls

---

Drive Mode Messages .....	5-45
Electric Drive Unit Messages .....	5-45
Engine Cooling System Messages .....	5-45
Engine Oil Messages .....	5-45
Fuel System Messages .....	5-46
Key and Lock Messages .....	5-46
Lamp Messages .....	5-47
Object Detection System Messages .....	5-47
Propulsion Power Messages .....	5-48
Ride Control System Messages .....	5-48
Airbag System Messages .....	5-49
Security Messages .....	5-49
Service Vehicle Messages ...	5-49
Starting the Vehicle Messages .....	5-50
Tire Messages .....	5-50
Vehicle Reminder Messages .....	5-51
Vehicle Speed Messages .....	5-51

### **Vehicle Personalization**

Vehicle Personalization .....	5-51
-------------------------------	------

### **Universal Remote System**

Universal Remote System ...	5-59
Universal Remote System Programming .....	5-59
Universal Remote System Operation .....	5-62

## Instrument Panel Overview

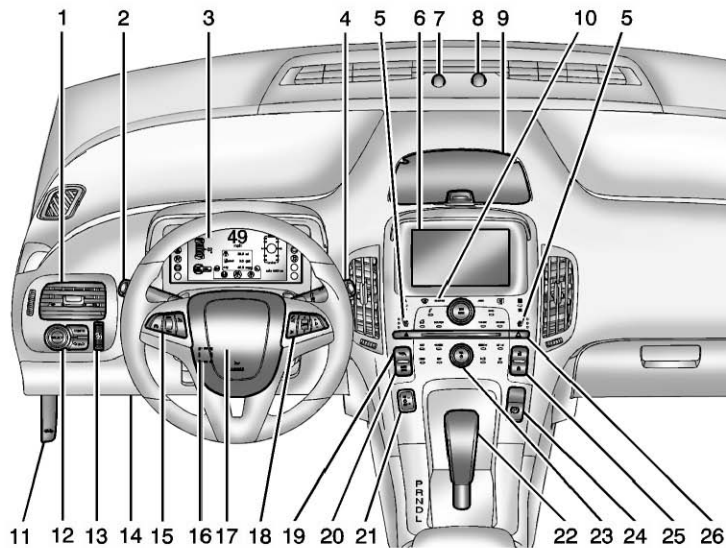

## 5-4 Instruments and Controls

---

1. *Air Vents on page 8-8.*
2. *Turn and Lane-Change Lever. See Turn and Lane-Change Signals on page 6-3.*  
*Exterior Lamp Controls on page 6-1.*  
*Pedestrian Friendly Alert on page 5-6.*
3. *Instrument Cluster on page 5-8.*  
*Driver Information Center (DIC) Display. See Driver Information Center (DIC) on page 5-41.*
4. *Windshield Wiper/Washer on page 5-6.*
5. *Heated Front Seats on page 3-5 (If Equipped).*
6. *Center Stack Display on page 5-27.*
7. *Charging Status Indicator. See Charging Status Feedback on page 9-49.*
8. *Light Sensor. See Daytime Running Lamps (DRL) on page 6-2.*
9. *Instrument Panel Storage on page 4-1.*
10. *Automatic Climate Control System on page 8-1.*
11. *Hood Release. See Hood on page 10-6.*
12. *Driver Information Center (DIC) Controls. See Driver Information Center (DIC) on page 5-41.*
13. *Instrument Panel Illumination Control on page 6-4.*
14. *Data Link Connector (DLC) (Out of View). See Malfunction Indicator Lamp on page 5-17.*
15. *Cruise Control on page 9-35.*
16. *Steering Wheel Adjustment on page 5-5.*
17. *Horn on page 5-6.*
18. *Steering Wheel Controls on page 5-5 (If Equipped).*
19. *Leaf Button. See Center Stack Display on page 5-27.*
20. *DRIVE MODE Button. See Driver Selected Operating Modes on page 9-22.*
21. *Power Button on page 9-16.*
22. *Shift Lever. See Electric Drive Unit on page 9-27.*
23. *Infotainment on page 7-1.*  
*Navigation System (If Equipped). See the navigation manual.*
24. *Electric Parking Brake on page 9-30.*
25. *Power Door Locks on page 2-11.*
26. *Hazard Warning Flashers on page 6-3.*

## Controls

### Steering Wheel Adjustment

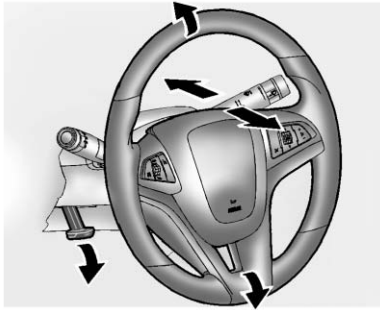

To adjust the steering wheel:

1. Pull the lever down.
2. Move the steering wheel up or down.
3. Pull or push the steering wheel closer or away from you.
4. Pull the lever up to lock the steering wheel in place.

Do not adjust the steering wheel while driving.

### Steering Wheel Controls

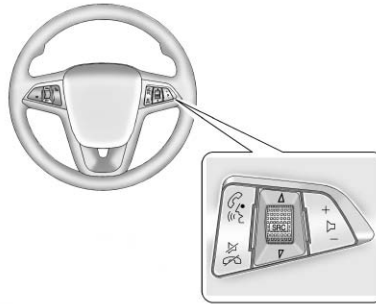

For vehicles with audio steering wheel controls, some audio controls can be adjusted at the steering wheel.

**(Push to Talk):** For vehicles with an OnStar, Bluetooth, or navigation system (if equipped), press to interact with those systems.

See *OnStar Overview on page 14-1* and “Bluetooth” in the Infotainment Manual.

**(End Call/Mute):** Press to silence the vehicle speakers only. Press again to turn the sound on. For vehicles with OnStar or Bluetooth systems, press to reject an incoming call, or to end a current call.

**SRC** **(Rotary Control):** Turn or to select a radio band or audio source.

Turn or to select the next or previous favorite radio station, CD track, DVD track/chapter, or MP3 track.

Press SRC to change between radio and CD or DVD.

Press and hold SRC to interact with the navigation system.

**+ - (Volume):** Press + to increase the volume; press - to decrease the volume.

## 5-6 Instruments and Controls

### Horn

Press near the horn symbol to sound the horn.

The pedestrian friendly alert provides momentary soft-note horn sound. See *Pedestrian Friendly Alert on page 5-6* for more information.

### Pedestrian Friendly Alert

Use this feature to alert people who may not hear your vehicle approaching.

The pedestrian friendly alert is only available when the vehicle is not in P (Park).

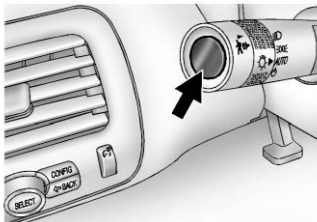

To use the pedestrian friendly alert:

Momentarily push the  button on the end of the turn signal lever, and a soft-note alert will momentarily sound.

Repeat for additional activations of the pedestrian friendly alert.

### Windshield Wiper/Washer

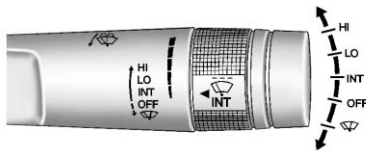

The windshield wiper/washer lever is on the side of the steering column. With the ignition in ACC/ACCESSORY or ON/RUN/START, move the windshield wiper lever to select the wiper speed.

**HI:** Use for fast wipes.

**LO:** Use for slow wipes.

**INT: (Intermittent Wipes):** Move the lever up to INT for intermittent wipes, then turn the  INT band up for more frequent wipes or down for less frequent wipes.

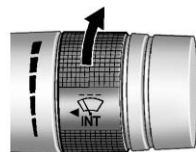

**OFF:** Use to turn the wipers off.

 **(Mist):** For a single wipe, briefly move the lever down. For several wipes, hold the lever down.

Clear snow and ice from the wiper blades and windshield before using them. If frozen to the windshield, carefully loosen or thaw them. Damaged blades should be replaced. See *Wiper Blade Replacement on page 10-25*.

Heavy snow or ice can overload the wiper motor.



## Wiper Parking

If the ignition is turned to LOCK/OFF while the wipers are on LO, HI, or INT, they will immediately stop.

If the windshield wiper lever is then moved to off before the driver door is opened or within 10 minutes, the wipers will restart and move to the base of the windshield.

If the ignition is turned to LOCK/OFF while the wipers are performing wiper due to windshield washing, the wipers continue to run until they reach the base of the windshield.

↓  **(Windshield Washer):** Pull the windshield wiper lever toward you to spray windshield washer fluid and activate the wipers. The wipers will continue until the lever is released or the maximum wash time is reached. When the lever is released, additional wipes may occur depending on how long the windshield washer had been activated. See *Washer Fluid* on

page 10-19 for information on filling the windshield washer fluid reservoir.

### WARNING

In freezing weather, do not use the washer until the windshield is warmed. Otherwise the washer fluid can form ice on the windshield, blocking your vision.

## Power Outlets

The accessory power outlets can be used to plug in electrical equipment, such as a cell phone or MP3 player.

There are three accessory power outlets:

- Inside the front of the floor console.
- On the rear of the floor console.
- Inside the instrument panel storage area.

The power outlets supply power while the vehicle is on, or if the vehicle is in Retained Accessory Power (RAP). See *Retained Accessory Power (RAP)* on page 9-19.

Remove the cover to access.

Certain accessory plugs may not be compatible with the accessory power outlet and could overload vehicle or adapter fuses. If a problem is experienced, see your dealer.

When adding electrical equipment, be sure to follow the installation instructions included with the equipment. See *Add-On Electrical Equipment* on page 9-60.

**Notice:** Hanging heavy equipment from the power outlet can cause damage not covered by the vehicle warranty. The power outlets are designed for accessory power plugs only, such as cell phone charge cords.

### Warning Lights, Gauges, and Indicators

Warning lights and gauges can signal that something is wrong before it becomes serious enough to cause an expensive repair or replacement. Paying attention to the warning lights and gauges could prevent injury.

Warning lights come on when there could be a problem with a vehicle function. Some warning lights come on briefly when the propulsion system is started to indicate they are working.

Gauges can indicate when there could be a problem with a vehicle function. Often gauges and warning lights work together to indicate a problem with the vehicle.

When one of the warning lights comes on and stays on while driving, or when one of the gauges shows there may be a problem,

check the section that explains what to do. Waiting to do repairs can be costly and even dangerous.

### Instrument Cluster

The instrument cluster displays a preview of information that includes electric range, charging, odometer, and battery status. This happens upon entry when the driver door is opened, and following the welcome animation, before starting the vehicle.

A CHARGING OVERRIDE/INTERRUPTION OCCURRED message may display on the lower left of the screen to indicate that a charging override or interruption has occurred due to one or more of the following events:

- Override of the charge settings by the owner using OnStar.
- Unintended interruption of AC power at the vehicle's charge port.

- Interruption of charging by the utility company using OnStar as authorized by the vehicle owner.

The following screens may appear, depending on the status.

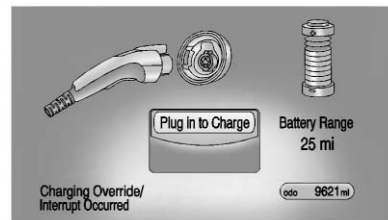

This screen indicates that the charge cord is not connected. Plug the charge cord in to charge the vehicle.

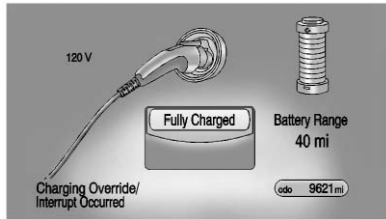

This screen indicates that the charge cord is connected and charging is complete.

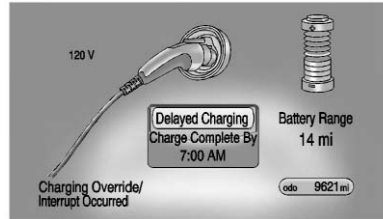

This screen indicates that charging is programmed to be delayed with an estimated completion time of 7:00 a.m.

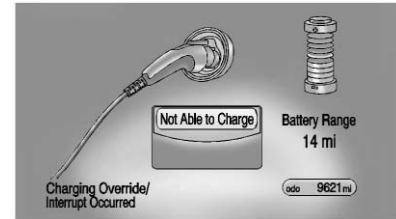

This screen indicates that the charge cord is connected, but the vehicle cannot be charged.

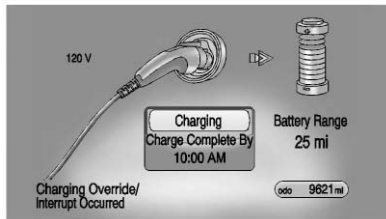

This screen indicates that charging is active and the estimated charge completion time is 10:00 a.m.

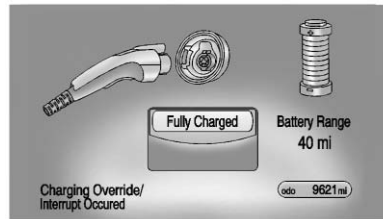

This screen indicates that the vehicle is fully charged and the charge cord is not connected.

## 5-10 Instruments and Controls

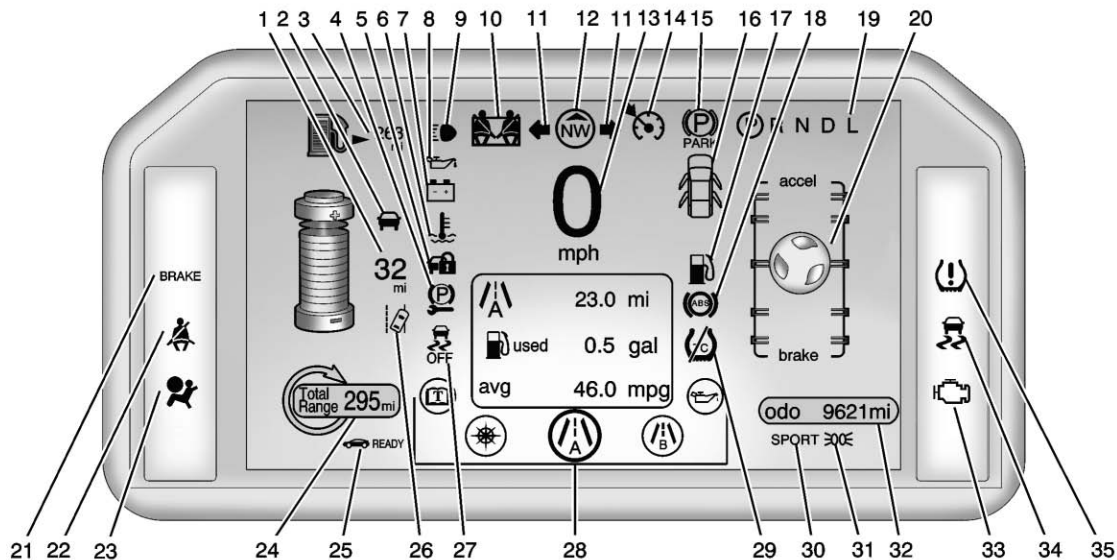

Complete Cluster with Enhanced Configuration in Electric Mode, Canada Similar

- |   |   |   |
|---|---|---|
| <ol style="list-style-type: none"> <li>1. <i>Battery Gauge (High Voltage) on page 5-13.</i></li> <li>2. <i>Forward Collision Alert (FCA) Warning Light on page 5-22.</i></li> <li>3. <i>Fuel Gauge on page 5-13.</i></li> <li>4. <i>Service Electric Parking Brake Light on page 5-20.</i></li> <li>5. <i>Security Light on page 5-25.</i></li> <li>6. <i>Engine Coolant Temperature Warning Light on page 5-23.</i></li> <li>7. <i>Charging System Light (12-Volt Battery) on page 5-17.</i></li> <li>8. <i>Engine Oil Pressure Light on page 5-24.</i></li> <li>9. <i>High-Beam On Light on page 5-25.</i></li> <li>10. <i>Second Row Passenger Safety Belt Reminder Light. See <i>Safety Belt Reminders</i> on page 5-14.</i></li> <li>11. <i>Turn and Lane-Change Signals on page 6-3.</i></li> <li>12. <i>Compass on page 5-13.</i></li> </ol> | <ol style="list-style-type: none"> <li>13. <i>Speedometer on page 5-12.</i></li> <li>14. <i>Cruise Control Light on page 5-26.</i></li> <li>15. <i>Electric Parking Brake Light on page 5-20.</i></li> <li>16. <i>Door, Hood, or Hatch Open Light on page 5-26.</i></li> <li>17. <i>Low Fuel Warning Light on page 5-25.</i></li> <li>18. <i>Antilock Brake System (ABS) Warning Light on page 5-21.</i></li> <li>19. <i>Electric Drive Unit Positions. See <i>Electric Drive Unit</i> on page 9-27.</i></li> <li>20. <i>Driver Efficiency Gauge on page 5-14.</i></li> <li>21. <i>Brake System Warning Light on page 5-20.</i></li> <li>22. <i>Driver Safety Belt Reminder Light. See <i>Safety Belt Reminders</i> on page 5-14.</i></li> <li>23. <i>Airbag Readiness Light on page 5-15.</i></li> </ol> | <ol style="list-style-type: none"> <li>24. <i>Total Vehicle Range on page 5-14.</i></li> <li>25. <i>Vehicle Ready Light on page 5-25.</i></li> <li>26. <i>Lane Departure Warning (LDW) Light on page 5-22.</i></li> <li>27. <i>StabiliTrak<sup>®</sup> OFF Light on page 5-23.</i></li> <li>28. <i>Driver Information Center (DIC) on page 5-41.</i></li> <li>29. <i>Traction Off Light on page 5-22.</i></li> <li>30. <i>Sport Mode Light on page 5-21, Mountain Mode Light on page 5-21, and Hold Mode Light on page 5-22.</i></li> <li>31. <i>Lamps On Reminder on page 5-25.</i></li> <li>32. <i>Odometer on page 5-12.</i></li> <li>33. <i>Malfunction Indicator Lamp on page 5-17.</i></li> <li>34. <i>Traction Control System (TCS)/StabiliTrak<sup>®</sup> Light on page 5-23.</i></li> </ol> |
|---|---|---|

## 5-12 Instruments and Controls

35. *Tire Pressure Light on page 5-24.*

### Instrument Cluster Display Configurations

There are two instrument cluster display configurations to choose from. Press CONFIG to the left of the steering wheel to change the configuration. See *Driver Information Center (DIC) on page 5-41.*

Choose either the Simple or Enhanced Configuration display.



**Simple Configuration in Electric Mode**

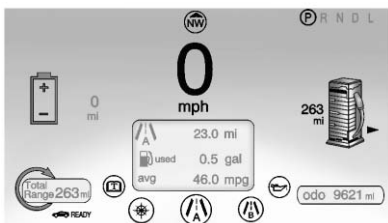

**Simple Configuration in Extended Range Mode**

The Enhanced Configuration displays the Driver Efficiency Gauge.



**Enhanced Configuration in Electric Mode**



**Enhanced Configuration in Extended Range Mode**

### Speedometer

The speedometer shows the vehicle speed in both kilometers per hour (km/h) and miles per hour (mph). The DIC menu can be used to change the units.

See *Driver Information Center (DIC) on page 5-41.*

### Odometer

The odometer shows how far the vehicle has been driven, in either kilometers or miles.

## Trip Odometer

The trip odometer is within the Driver Information Center. See *Driver Information Center (DIC) on page 5-41* for more information.

## Compass

The vehicle has a compass display in the instrument cluster above the speedometer. The compass receives its heading and other information from the Global Positioning System (GPS) antenna and vehicle speed information.

The compass system has automatic calibration and zone adjustment features.

Avoid covering the GPS antenna for long periods of time with objects that may interfere with the antenna's ability to receive a satellite signal. See "Multi-Band Antenna" in the infotainment manual. The compass system is designed to operate for a certain number of miles or degrees of turn before needing a signal from

the GPS satellites. The compass system will automatically determine when a GPS signal is restored and provide a heading.

## Battery Gauge (High Voltage)



This indicator displays the high voltage battery charge level.

When this indicator is displayed in the foreground, the vehicle is operating in Electric Mode. The number next to the indicator displays an estimate of how far the vehicle can be driven while in this mode.

See *Electric Mode on page 9-21*.

## Fuel Gauge



This indicator displays the fuel level. When this indicator is in the foreground, the vehicle is operating in Extended Range Mode.

The number next to the indicator displays an estimate of how far the vehicle can be driven while in this mode.

See *Extended Range Mode on page 9-21*.

## 5-14 Instruments and Controls

### Driver Efficiency Gauge



This gauge is a guide to driving in an efficient manner by keeping the ball green and in the center of the gauge. The leaves stop spinning when the vehicle stops or when the ball travels away from the center of the gauge.

See *Driving for Better Energy Efficiency on page 9-2*.

**accel:** If the ball turns yellow and travels above the center of the gauge, acceleration is too aggressive to optimize efficiency.

**brake:** If the ball turns yellow and travels below the center of the gauge, braking is too aggressive to optimize efficiency.

### Total Vehicle Range



Total vehicle range is the remaining distance the vehicle can be driven combining the electric range and fuel range.

See *Driving for Better Energy Efficiency on page 9-2*.

### Safety Belt Reminders

#### Driver Safety Belt Reminder Light

There is a driver safety belt reminder light on the instrument panel cluster.



When the vehicle is started, this light flashes and a chime may come on to remind the driver to fasten their safety belt. Then the light stays on solid until the belt is buckled. This cycle may continue several times if the driver remains or becomes unbuckled while the vehicle is moving.

If the driver safety belt is already buckled, neither the light nor the chime comes on.



## Passenger Safety Belt Reminder Light

There is a passenger safety belt reminder light near the passenger airbag status indicator. See *Passenger Sensing System* on page 3-23.



When the vehicle is started, this light flashes and a chime may come on to remind the front passenger to fasten their safety belt. Then the light stays on solid until the belt is buckled. This cycle may continue several times if the front passenger remains or becomes unbuckled while the vehicle is moving.

If the front passenger safety belt is buckled, neither the chime nor the light comes on.

The front passenger safety belt warning light and chime may turn on if an object is put on the seat such as a briefcase, handbag, grocery bag, laptop, or other electronic device. To turn off the warning light and/or chime, remove the object from the seat or buckle the safety belt.

## Second Row Passenger Safety Belt Reminder Light



Second row seating positions monitored for safety belt use are represented by a colored symbol on the instrument panel cluster indicating safety belt status.

When the vehicle is started, two safety belt symbols come on and stay on for several seconds to alert the driver that passengers may

need to fasten their safety belts. After the passenger safety belt is buckled, the corresponding safety belt symbol in the instrument cluster turns green. If a safety belt is not initially buckled, the instrument cluster displays a gray safety belt symbol.

While the vehicle is moving, if a second row passenger who was previously buckled becomes unbuckled, the corresponding safety belt symbol will change to flashing red for several seconds and a chime may sound.

## Airbag Readiness Light

This light shows if there is an electrical problem with the airbag system. The system check includes the airbag sensor(s), passenger sensing system, the pretensioners, the airbag modules, the wiring, and the crash sensing and diagnostic module. For more information on the airbag system, see *Airbag System* on page 3-16.



The airbag readiness light comes on for several seconds when the vehicle is started. If the light does not come on then, have it fixed immediately.

### **WARNING**

If the airbag readiness light stays on after the vehicle is started or comes on while driving, it means the airbag system might not be working properly. The airbags in the vehicle might not inflate in a crash, or they could even inflate without a crash. To help avoid injury, have the vehicle serviced right away.

If there is a problem with the airbag system, a Driver Information Center (DIC) message may also come on. See *Airbag System Messages on page 5-49*.

### **Passenger Airbag Status Indicator**

The vehicle has a passenger sensing system. See *Passenger Sensing System on page 3-23* for important safety information. The passenger airbag status indicator is in the overhead console.



#### **United States**



#### **Canada**

When the vehicle is started, the passenger airbag status indicator will light ON and OFF, or the symbol for on and off, for several seconds as a system check. Then, after several more seconds, the status indicator will light either ON or OFF, or the on or off symbol, to let you know the status of the front outboard passenger frontal airbag and knee airbag.

If the word ON or the on symbol is lit on the passenger airbag status indicator, it means that the front outboard passenger frontal airbag and knee airbag are allowed to inflate.

If the word OFF or the off symbol is lit on the airbag status indicator, it means that the passenger sensing

system has turned off the front outboard passenger frontal airbag and knee airbag.

If, after several seconds, both status indicator lights remain on, or if there are no lights at all, there may be a problem with the lights or the passenger sensing system. See your dealer for service.

### **WARNING**

If the airbag readiness light ever comes on and stays on, it means that something may be wrong with the airbag system. To help avoid injury to yourself or others, have the vehicle serviced right away. See *Airbag Readiness Light on page 5-15* for more information, including important safety information.

## Charging System Light (12-Volt Battery)

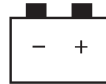

The charging system light comes on briefly when the vehicle is in ON/RUN, as a check to show the light is working.

If the light stays on, or comes on while driving, there could be a problem with the electrical charging system. Have it checked by your dealer. Driving while this light is on could drain the 12-volt battery.

If a short distance must be driven with the light on, be sure to turn off all accessories, such as the radio.

## Malfunction Indicator Lamp

A computer system called OBD II (On-Board Diagnostics-Second Generation) monitors operation of the vehicle. It ensures that emissions are at acceptable levels for the life of the vehicle, helping to maintain a clean environment. The malfunction indicator lamp comes on when the vehicle is placed in Service Only Mode, as a check to show it is working. If it does not, have the vehicle serviced by your dealer. See *Power Button on page 9-16* for more information.



If the malfunction indicator lamp comes on, while the engine is in ON/RUN, this indicates that the

## 5-18 Instruments and Controls

---

OBD II system has detected a problem and diagnosis and service might be required.

Malfunctions often are indicated by the system before any problem is apparent. Being aware of the light can prevent more serious damage to the vehicle. This system also assists the dealer technician in correctly diagnosing any malfunction.

**Notice:** If the vehicle is continually driven with this light on, the emission controls might not work as well, the vehicle fuel economy might not be as good, and the engine might not run as smoothly. This could lead to costly repairs that might not be covered by the vehicle warranty.

**Notice:** Modifications made to the engine, electric drive unit, exhaust, intake, or fuel system of the vehicle or the replacement of the original tires with other than those of the same Tire Performance Criteria (TPC) can

**affect the vehicle emission controls and can cause this light to come on. Modifications to these systems could lead to costly repairs not covered by the vehicle warranty. This could also result in a failure to pass a required Emission Inspection/Maintenance test. See *Accessories and Modifications on page 10-2.***

This light comes on during a malfunction in one of two ways:

**Light Flashing:** A misfire condition has been detected. A misfire increases vehicle emissions and could damage the emission control system on the vehicle. Diagnosis and service might be required.

The following can prevent more serious damage to the vehicle:

- Reduce vehicle speed.
- Avoid hard accelerations.
- Avoid steep uphill grades.

If the light continues to flash, find a safe place to stop and park the vehicle. Turn the vehicle off and wait at least 10 seconds before driving the vehicle again. If the light begins to flash again, follow the previous steps and see your dealer for service as soon as possible.

**Light On Steady:** An emission control system malfunction has been detected on the vehicle. Diagnosis and service might be required.

The following may correct an emission control system malfunction:

- Check that the fuel cap is fully installed. The diagnostic system can determine if the fuel cap has been left off or improperly installed. A loose or missing fuel cap allows fuel to evaporate into the atmosphere. A few driving trips with the cap properly installed should turn the light off.

- Check that good quality fuel is used. Poor fuel quality causes the engine not to run as efficiently as designed and may cause stalling after start-up or misfiring. These conditions might go away once the engine is warmed up.

If one or more of these conditions occurs, change the fuel brand used. It may require at least one full tank of the proper fuel to turn the light off.

If none of the above have made the light turn off, your dealer can check the vehicle. The dealer has the proper test equipment and diagnostic tools to fix any mechanical or electrical problems that might have developed.

### Emissions Inspection and Maintenance Programs

Depending on where you live, your vehicle may be required to participate in an emission control system inspection and maintenance program. For the inspection, the

emission system test equipment will likely connect to the vehicle's Data Link Connector (DLC).

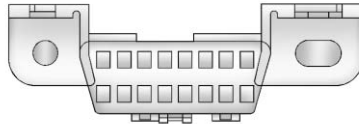

The DLC is under the instrument panel to the left of the steering wheel. See your dealer if assistance is needed.

The vehicle may not pass inspection if:

- The malfunction indicator lamp is on while the vehicle is in ON/RUN, or if the vehicle is placed in Service Only Mode and the malfunction indicator lamp does not come on. See your dealer for assistance in verifying proper operation of the malfunction indicator lamp.

- The OBD II (On-Board Diagnostics) system determines that critical emission control systems have not been completely diagnosed by the system. If this were to occur, the vehicle would be considered not ready for inspection. This can happen if the 12-volt battery has recently been replaced or run down.

The diagnostic system is designed to evaluate critical emission control systems during normal driving. This can take several days of driving. If this has been done and the vehicle still does not pass the inspection for lack of OBD II system readiness, your dealer can prepare the vehicle for inspection.

### Brake System Warning Light

The vehicle brake system consists of two hydraulic circuits. If one circuit is not working, the remaining circuit can still work to stop the vehicle. For normal braking performance, both circuits need to be working.

If the warning light comes on, there is a brake problem. Have the brake system inspected right away.



**BRAKE**

**Metric**

**English**

This light comes on briefly when the vehicle is turned on. If it does not come on then, have it fixed so it will be ready to warn if there is a problem.

If the light comes on and stays on, there is a base brake problem.

#### **WARNING**

The brake system might not be working properly if the brake system warning light is on. Driving with the brake system warning light on can lead to a crash. If the light is still on after the vehicle has been pulled off the road and carefully stopped, have the vehicle towed for service.

### Electric Parking Brake Light



This status light comes on when the parking brake is applied. If the light flashes and stays on after the

parking brake is released, or while driving, there is a problem with the electric parking brake system.

If the light does not come on, or remains flashing, see your dealer.

See *Electric Parking Brake* on page 9-30 for more information.

### Service Electric Parking Brake Light



The service electric parking brake light should come on briefly when the vehicle is in ON/RUN. If it does not come on, have it fixed so it will be ready to warn if there is a problem.

If this light stays on, there is a problem with a system on the vehicle that is causing the parking

brake system to work at a reduced level. The vehicle can still be driven, but should be taken to a dealer as soon as possible. See *Electric Parking Brake* on page 9-30. If a message displays in the Driver Information Center (DIC), see *Brake System Messages* on page 5-44.

## Antilock Brake System (ABS) Warning Light



This light should come on briefly when the vehicle is in ON/RUN. If it does not come on, have the vehicle serviced by your dealer.

If the ABS warning light stays on longer than a few seconds after the vehicle is in ON/RUN, or comes on

and stays on while driving, try resetting the system. To reset the system:

1. While driving, pull over when it is safe to do so.
2. Place the vehicle in P (Park).
3. Turn the vehicle off.
4. Restart the vehicle.

If the ABS warning light remains on after resetting the system or comes on again while driving, the vehicle needs service. If the ABS warning light is on, but the regular brake system warning light is not on, the antilock brakes are not working properly, but the regular brakes are still functioning. Have the vehicle serviced right away. If both brake lights are on, the vehicle does not have antilock brakes, and there is a problem with the regular brakes as well. Have the vehicle towed for service. See *Towing the Vehicle* on page 10-73.

## Sport Mode Light

SPORT

This light comes on when Sport Mode is selected. See “Sport Mode” in *Driver Selected Operating Modes* on page 9-22 for more information.

## Mountain Mode Light

MOUNTAIN

This light comes on when Mountain Mode is selected. See “Mountain Mode” in *Driver Selected Operating Modes* on page 9-22 for more information.

### Hold Mode Light

HOLD

This light comes on when Hold Mode is selected. See “Hold Mode” in *Driver Selected Operating Modes* on page 9-22 for more information.

### Lane Departure Warning (LDW) Light



This light briefly comes on amber while starting the vehicle. If it does not, have the vehicle serviced by your dealer. If the system is working normally, the light then turns off.

This light comes on green when the system is on and ready to operate. When the system determines that the vehicle is leaving its lane without using the turn signal, this light will change to amber and flash.

See *Lane Departure Warning (LDW)* on page 9-44.

### Forward Collision Alert (FCA) Warning Light



The vehicle ahead light comes on green when a vehicle is detected ahead. It changes to amber when following another vehicle too closely.

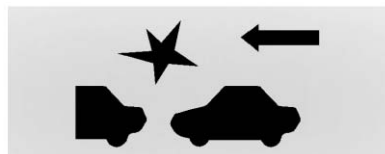

The forward collision alert comes on and warns when a vehicle is being rapidly approached.

See *Forward Collision Alert (FCA) System* on page 9-38 for more information.

### Traction Off Light



This light comes on briefly while starting the engine. If it does not, have the vehicle serviced by your dealer. If the system is working normally, the indicator light then turns off.



The traction off light comes on when the Traction Control System (TCS) has been turned off by pressing and releasing the TCS/ESC button.

This light and the StabiliTrak OFF light come on when StabiliTrak is turned off.

If the TCS is off, wheel spin is not limited. Adjust driving accordingly.

### StabiliTrak<sup>®</sup> OFF Light



This light comes on briefly while starting the engine. If it does not, have the vehicle serviced by your dealer.

This light comes on when the StabiliTrak system is turned off. If StabiliTrak is off, Traction Control System (TCS) is also off.

If the TCS is off, the system does not assist in controlling the vehicle. Turn on the TCS and the StabiliTrak systems and the warning light turns off.

### Traction Control System (TCS)/StabiliTrak<sup>®</sup> Light



This light comes on briefly while starting the vehicle.

If it does not, have the vehicle serviced by your dealer. If the system is working normally the indicator light then goes off.

If the light comes on and stays on while driving, there could be a problem with the TCS/StabiliTrak system and the vehicle might need

service. When this warning light is on, the TCS/StabiliTrak system is off and does not limit wheel spin.

The light flashes if the system is active and is working to assist the driver with directional control of the vehicle in difficult driving conditions.

### Engine Coolant Temperature Warning Light



The engine coolant temperature warning light comes on briefly when the vehicle is started.

If it does not, have the vehicle serviced by your dealer. If the system is working normally, the indicator light then goes off.

## 5-24 Instruments and Controls

If the light comes on and stays on while driving, the vehicle may have a problem with the cooling system. Stop and turn off the vehicle to avoid damage to the engine. A warning chime sounds when this light is on.

See *Engine Overheating on page 10-19* for more information.

### Tire Pressure Light



For vehicles with the Tire Pressure Monitor System (TPMS), this light comes on briefly when the vehicle is in ON/RUN. It provides information about tire pressures and the TPMS.

#### When the Light is On Steady

This indicates that one or more of the tires are significantly underinflated.

A message in the Driver Information Center (DIC) may also display. See *Tire Messages on page 5-50*. Stop as soon as possible, and inflate the tires to the pressure value shown on the Tire and Loading Information Label. See *Tires on page 10-39*.

#### When the Light Flashes First and Then is On Steady

This indicates that there may be a problem with the Tire Pressure Monitor System. The light flashes for about one minute and stays on steady until the vehicle is in OFF. This sequence repeats each time the vehicle is in ON/RUN. See *Tire Pressure Monitor System on page 10-47*.

### Engine Oil Pressure Light

**Notice:** Lack of proper engine oil maintenance can damage the engine. Driving with the engine oil low can also damage the engine. The repairs would not be covered by the vehicle warranty.

**Check the oil level as soon as possible. Add oil if required, but if the oil level is within the operating range and the oil pressure is still low, have the vehicle serviced. Always follow the maintenance schedule for changing engine oil.**



The oil pressure light should come on briefly as the vehicle is started. If it does not come on have the vehicle serviced by your dealer.

If the light comes on and stays on, it means that oil is not flowing through the engine properly. The vehicle could be low on oil and might have some other system problem. See your dealer.

## Low Fuel Warning Light



The low fuel warning light comes on briefly when the vehicle is started.

This light also comes on when the fuel level is low. When fuel is added, the light should go off. If it does not, have the vehicle serviced.

## Security Light



The immobilizer light should come on briefly as the engine is started. If it does not come on, have the

vehicle serviced by your dealer. If the system is working normally, the indicator light turns off.

If the light stays on and the engine does not start, there could be a problem with the theft-deterrent system. See *Immobilizer Operation* on page 2-15.

## Vehicle Ready Light



The vehicle ready light comes on whenever the vehicle is ready to be driven.

## High-Beam On Light



The high-beam on light comes on when the high-beam headlamps are in use.

See *Headlamp High/Low-Beam Changer* on page 6-1 for more information.

## Lamps On Reminder



This light comes on when the parking lamps, headlamps, or taillamps are on.

## Cruise Control Light



The cruise control light comes on when the cruise control is turned on and turns green when cruise control is engaged.

See *Cruise Control* on page 9-35 for more information.

## Door, Hood, or Hatch Open Light

If a door, hood, or hatch is not completely closed, a light comes on together with a graphic in the Driver Information Center (DIC).

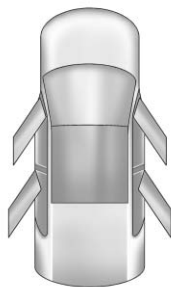

**Door(s) Open**

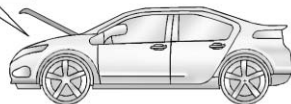
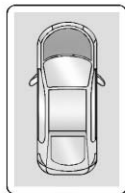

**Hood Open**

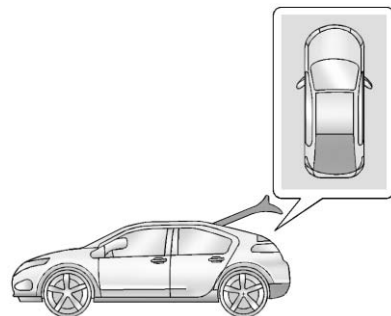

**Hatch Open**

The DIC indicates when a door, the hood, or the hatch is open. The light displays the open area as shaded.

The DIC and the light both display when the vehicle is moving. Only the light displays if the vehicle is stopped.

## Information Displays

### Center Stack Display

The center stack screen displays Charging, Power Flow, and Energy Information. See the information that follows.

Climate Control, Infotainment, and Vehicle Personalization information also displays in this screen. For more information on these systems, see:

- *Automatic Climate Control System on page 8-1.*
- The infotainment system manual.
- *Vehicle Personalization on page 5-51.*

The center stack controls only need a light touch to operate and work best with bare hands. The controls will work with most gloves although they may take longer to respond. Use the finger pad rather than the

finger tip to minimize response time. If the controls are not responding, remove the gloves.

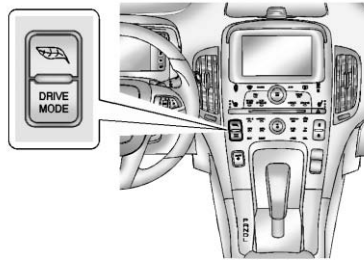

To view the Power Flow, Charging, and Energy Information, press the  button on the center stack.

### Power Flows

To view the Power Flow screens, press the  button on the center stack and then press the Power Flow button at the top of the touch screen. The Power Flow screens indicate the current system

operating condition. The screens show the energy flow between the engine, electric drive unit, and high voltage battery. These components will be highlighted when they are active.

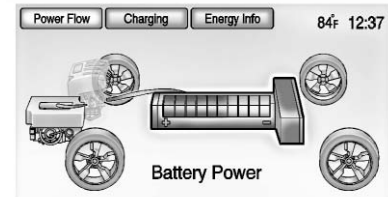

Battery Power - Battery is active with energy flowing to the wheels.

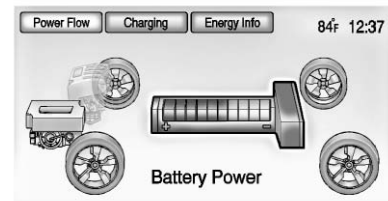

## 5-28 Instruments and Controls

Battery Power - Vehicle is stationary in electric mode and no power is flowing to the wheels.

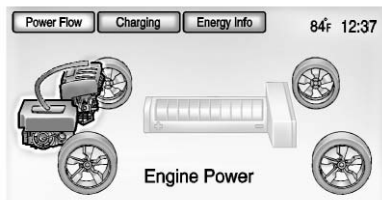

Engine Power - Engine is active with energy flowing to the wheels.

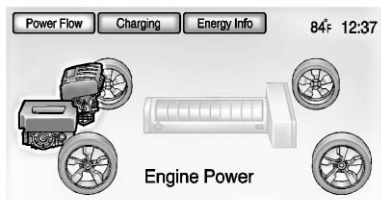

Engine Power - Vehicle is stationary in extended range mode and no power is flowing to the wheels.

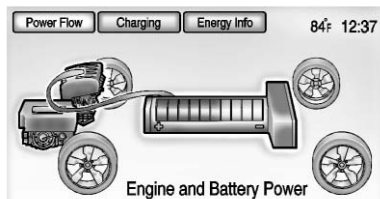

Engine and Battery Power - Both the engine and battery are active with energy flowing to the wheels.

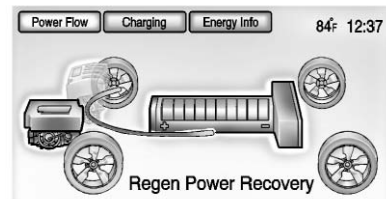
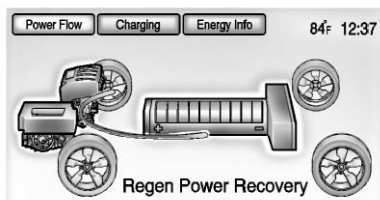

Regen Power Recovery - Power from the wheels returns to the battery during regenerative braking or coasting.

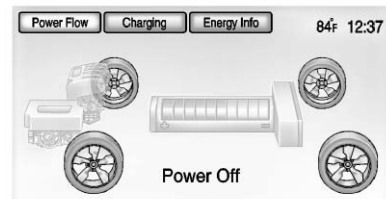

Power Off - No power is flowing to the wheels.

## Programmable Charging

### Important Information About Portable Electric Vehicle Charging

- Charging an electric vehicle can stress a building's electrical system more than a typical household appliance.
- Before you plug in to any electrical outlet, have a qualified electrician inspect and verify the electrical system (electrical outlet, wiring, junctions, and protection devices) for heavy-duty service at a 12 amp continuous load.
- Electrical outlets may wear out with normal usage or be damaged over time, making them unsuitable for electric vehicle charging.
- Check the electrical outlet/plug while charging and discontinue use if the electrical outlet/plug is hot, then have the electrical outlet serviced by a qualified electrician.

- When outdoors, plug into an electrical outlet that is weather-proof while in use.
- Mount the charging cord to reduce strain on the electrical outlet/plug.

### WARNING

Improper use of portable electric vehicle charge cords may cause a fire, electrical shock, or burns, and may result in damage to property, serious injury, or death.

- Do not use extension cords, multi-outlet power strips, splitters, grounding adaptors, surge protectors, or similar devices.
- Do not use an electrical outlet that is worn or damaged, or one that will not hold the plug firmly in place.
- Do not use an electrical outlet that is not properly grounded.

(Continued)

### WARNING (Continued)

- Do not use an electrical outlet that is on a circuit with other electrical loads.

See the charge cord user guide.

### Programmable Charge Modes

This vehicle has three programmable charge modes. To view the current charge mode status in the center stack display, press the  button on the center stack and then press the Charging button at the top of the touch screen.

The current charge mode status can also be viewed in a temporary pop-up in the center stack display by pressing the charge port door release button on the driver door.

The Charge Start and Charge Complete time estimations are also displayed on the screen. These estimations are most accurate when the vehicle is plugged in and in moderate temperature conditions.

## 5-30 Instruments and Controls

Also, to get an accurate time estimate, the vehicle uses an internal clock for programmable charging, not the clock in the center stack.

### Charge Mode Status

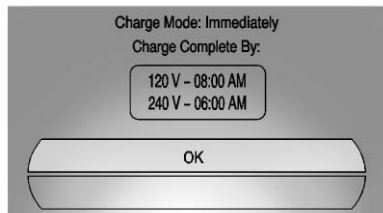
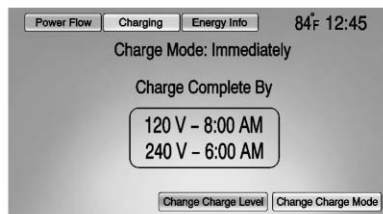

**Immediately:** The vehicle starts charging as soon as it is connected to an electrical outlet. See *Plug-In Charging* on page 9-47.

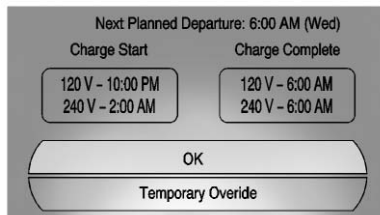
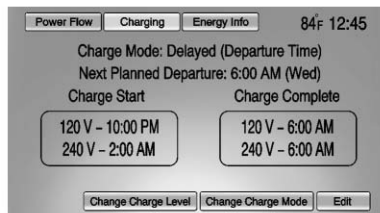

**Delayed Departure Time:** The vehicle estimates the charging start time considering the programmed departure time for the current day of

the week. Charging begins at the start time and is complete by the departure time only if sufficient time is allowed after the charge cord is plugged in.

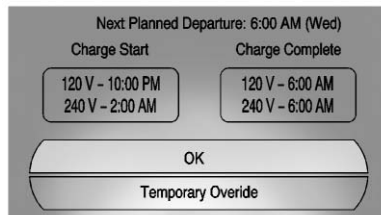
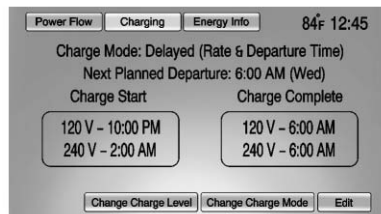

**Delayed Rate and Departure Time:** The vehicle estimates the charging start time based on the



utility rate schedule, utility rate preference, and the programmed departure time for the current day of the week. The vehicle will charge during the least expensive rate periods to achieve a full battery charge by the departure time. Electrical rate information from the utility company for the charging location is required for this mode.

Also, if the selected electric rate settings result in a very long charge completion time, the vehicle will start charging immediately upon plug-in. For example, if the electric rate table is set up with all “Peak” rates and the rate preference is to charge during “Off-Peak” rates only, then the vehicle will start charging immediately upon plug-in.

### Charge Level Selection

The Charge Level Preference setting allows the customer to select their vehicle’s charge level so it matches the capability of their charging location. If the vehicle consistently stops charging after

plugging in, or if a circuit breaker continues to trip, reducing to a lower Charge Level Preference may resolve the issue.

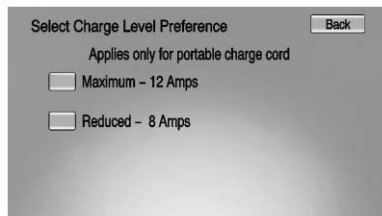

The Charge Level Preference should be configured to match the electrical current rating for the electrical outlet that the charge cord is connected to. The Charge Level Preference settings are:

- Maximum: Limits AC current to 12 Amps
- Reduced: Limits AC current to 8 Amps

Exact current levels may vary from the values shown in this manual. Please check the vehicle for the current available levels.

The Charge Level Preference setting can be changed at any time while the center stack display is operable.

For some vehicles, the Charge Level Preference must be updated prior to the vehicle being charged and the Charge Level Preference will reset to a default value when the vehicle is shifted from P (Park).

### WARNING

Using a charge level that exceeds the electrical circuit or electrical outlet capacity may start a fire or damage the electrical circuit. Use the lowest charge level until a qualified electrician inspects your electrical circuit capacity. Use the lowest charge level if the electrical circuit or electrical outlet capacity is not known.

## 5-32 Instruments and Controls

### Charge Mode Selection

From the Charge Mode Status screen, press Change Charge Mode.

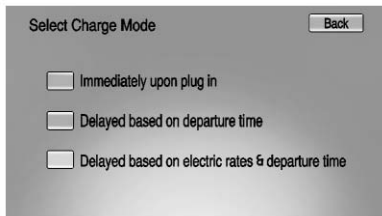

Select one option:

- Immediately upon plug in.
- Delayed based on departure time.
- Delayed based on electric rates & departure time.

### Departure Time Entry

From the Delayed Charge Mode Status screen, press Edit to change the departure time for each day of the week to match your personal schedule.

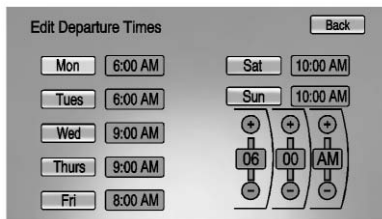

1. Press the day to change.
2. Press + or - to change the hours and minutes.
3. Press + or - to change AM or PM.
4. Press Back to store changes and return to the previous screen.

### Charge Rate Selection

From the Delayed Rate and Departure Time Charge Mode Status screen, press Edit.

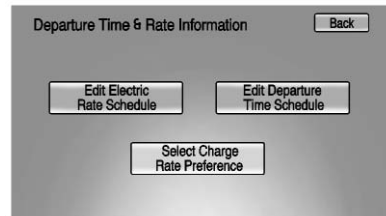

Select one of the following:

- Edit Electric Rate Schedule.
- Edit Departure Time Schedule. See “Departure Time Entry.”
- Select Charge Rate Preference.

## Charge Rate Preference Selection

From the Departure Time & Rate Information screen, press Select Charge Rate Preference.

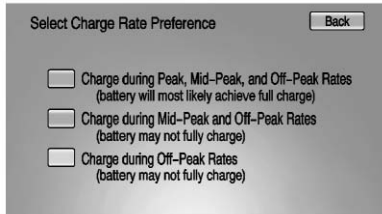

Press one of the following options to select the Charge Rate Preference:

- Charge during Peak, Mid-Peak, and Off-Peak Rates: The vehicle can charge during any rate period to satisfy the next planned departure time. However, it will select when to charge to minimize the total cost of the charge.
- Charge during Mid-Peak and Off-Peak Rates: The vehicle will charge during Off-Peak and/or

Mid-Peak rate periods only and will select when to charge to minimize the total cost of the charge.

- Charge during Off-Peak Rates: The vehicle will only charge during Off-Peak rate periods.

Charging begins at the start time and is complete by the departure time only if sufficient time is allowed after the charge cord is plugged in. For example, if the vehicle is plugged in for only one hour prior to the departure time, and the battery is completely discharged, the vehicle will not be fully charged by the departure time regardless of the rate selection.

Also, if the selected electric rate settings result in a very long charge completion time, the vehicle will start charging immediately upon plug-in. For example, if the electric rate table is set up with all “Peak” rates and the rate preference is to

charge during “Off-Peak” rates only, then the vehicle will start charging immediately upon plug-in.

## Electric Rate Plan Selection

Electric rates, or cost per unit, may vary based on time, weekday/weekend, and season. During the day when the demand for electricity is high, the rates are usually higher and called Peak rates. At night when the demand for electricity is low, the rates are usually lower and called Off-Peak rates. In some areas, a Mid-Peak rate is offered.

Contact the utility company to obtain the rate schedule for your area. The summer and winter start dates must be established to use a summer/winter schedule.

From the Departure Time & Rate Information screen, press Edit Electric Rate Schedule.

## 5-34 Instruments and Controls

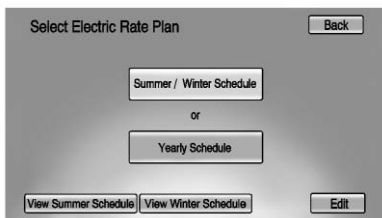

To edit the Summer/Winter Schedule:

1. Press Summer/Winter Schedule.
2. Press Edit.

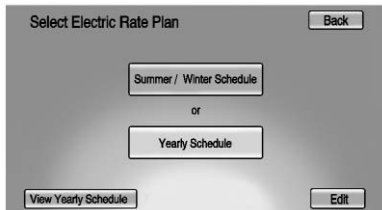

To edit the Yearly Schedule:

1. Press Yearly Schedule.
2. Press Edit.

### Summer/Winter Schedule Start Date Entering

From the Select Electric Rate Plan screen, press Summer/Winter Schedule then press Edit.

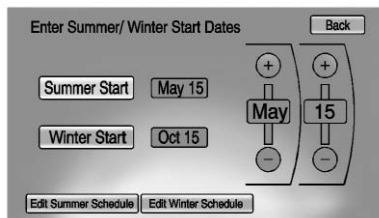

1. Press Summer Start.
2. Press + or - to set the month and day for the start of summer.
3. Press Winter Start.
4. Press + or - to set the month and day for the start of winter.
5. Press Edit Summer Schedule or Edit Winter Schedule to edit the daily electric rate schedule.

### Electric Rate Schedule Editing

From the Enter Summer/Winter Start Dates screen, press Edit Summer Schedule or Edit Winter Schedule.

From the Select Electric Rate Plan screen, press Yearly Schedule and then press Edit.

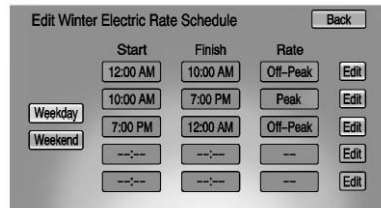
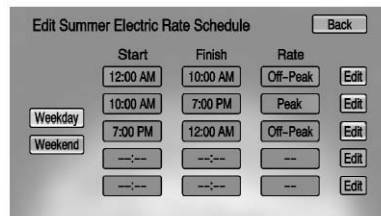

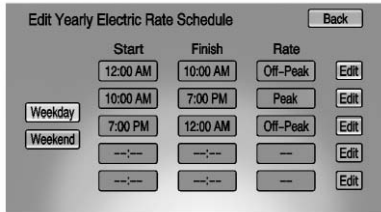

1. Press Weekday or Weekend.
2. Press Edit next to the row to be changed.
  - Weekdays are Monday through Friday and use the same rate schedule.
  - Weekends are Saturday and Sunday and use the same rate schedule.

Both weekday and weekend schedules must be set. The rate schedule only applies for a 24-hour period, starting at 12:00 AM and ending at 12:00 AM. There can be five rate changes for each day; not all must be used.

The finish times must be consecutive. If a finish time does not follow a start time, the error message displays “An invalid entry was found in the data entered. Please re-enter data.”

### Electric Rate Finish Time Editing

From the Edit (Summer, Winter, or Yearly) Electric Rate Schedule screen, press Edit next to the row to change.

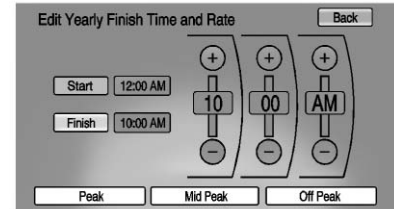
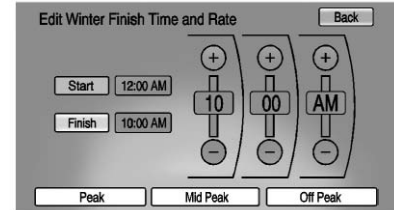
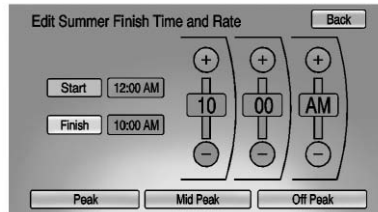

1. Press + or - to adjust the time.
2. Press Peak, Mid-Peak, or Off-Peak to select the electric rate.
3. Press the Back button to store changes.

Only the finish time can be edited. The start time is automatically populated in the rate table.

## 5-36 Instruments and Controls

### Electric Rate Schedule Viewing

From the Select Electric Rate Plan screen, press View (Summer, Winter, or Yearly) Schedule.

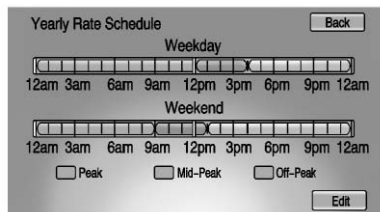
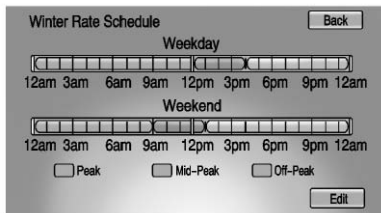
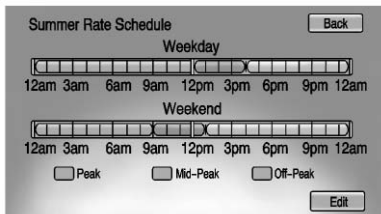

### Temporary Charge Mode Override and Cancel

Programmed Delayed Charge Modes can be temporarily overridden to an Immediate Charge Mode for one charge cycle. Also, the next planned departure time can be temporarily overridden for one charge cycle. In addition to the in-vehicle overrides via the center stack, there are other ways to temporarily override a Delayed Charge Mode. See *Plug-In Charging on page 9-47*.

### Temporary Override of a Delayed Charge Mode

To temporarily override a Delayed Charge Mode to Immediate Charge Mode from inside the vehicle:

1. Press the charge port door release button on the driver door to view the Charge Mode Status pop-up in the center stack display.

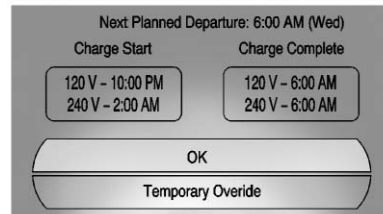

2. Press Temporary Override.

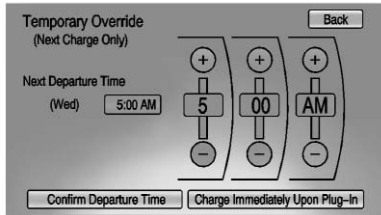

3. Press Charge Immediately Upon Plug-In to temporarily override to an Immediate Charge Mode.

The Temporary Charge Mode Status screen will automatically display the revised charge complete time.

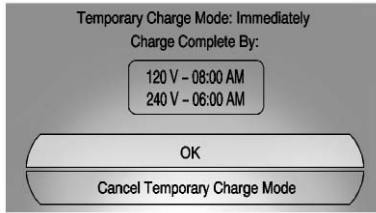
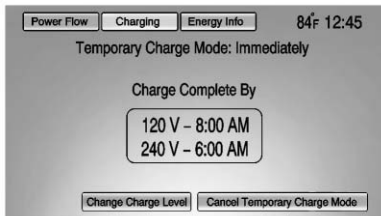

To cancel the temporary override to Immediate, from the Temporary Charge Mode Status screen or pop-up, press Cancel Temporary Charge Mode on the bottom of the touch screen.

### Temporary Override of the Next Planned Departure Time

To temporarily override the Next Planned Departure Time from inside the vehicle:

1. Press the charge port door release button on the driver door to view the Charge Mode Status pop-up in the center stack display.
2. Press Temporary Override.

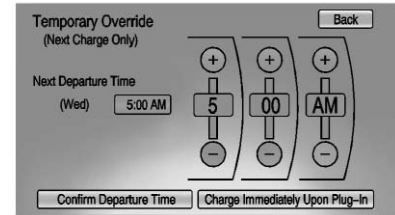

3. Press the + or – button to change the Next Departure Time.
4. Press Confirm Departure Time to temporarily override the Next Planned Departure Time.

The Temporary Charge Mode Status screen will automatically display the revised charge complete time.

The Temporary Departure time can only be updated for the same day as the original Next Planned Departure Time. Also, the vehicle will not accept a Temporary Departure Time that is before the present time of day.

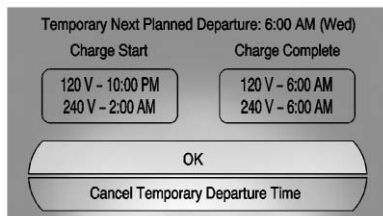
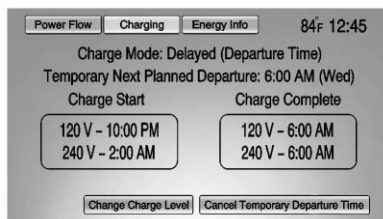

To cancel the temporary override of the Next Planned Departure Time, from the Temporary Charge Mode Status screen or pop-up, press Cancel Temporary Departure Time on the bottom of the touch screen.

### Charging Override/Interruption Pop-Up

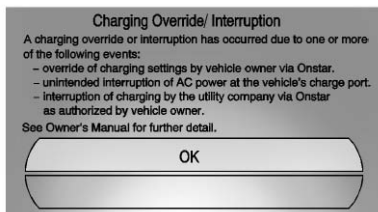

The Charging Override/Interruption pop-up will appear if any of the following conditions occur:

- The charging settings have been modified via OnStar through the website or the Mobile App. For example, the Departure Time Tables, the Rate Tables, or the Charge Mode were updated using the customer website (available in select regions).
- There was an unintended loss of AC power during the plug-in charge event. For example,

there was a power outage or the charge cord was unplugged from the wall.

- The charge process was interrupted by the utility company via OnStar as authorized by the vehicle owner (available in select regions).

For more information see *Utility Interruption of Charging* on page 9-54.

### Programmable Charging Disabled

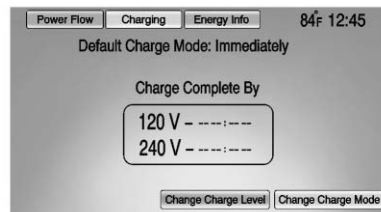



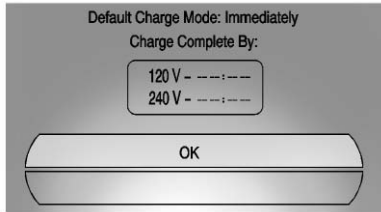

When the Programmable Charging system is disabled, the Default Charge Mode Status screen and the pop-up will display “- :- -” for the Charge Complete Time. The Programmable Charging system will be disabled if the Charge Complete Time cannot be confidently estimated. If the Programmable Charging system is consistently disabled, see your dealer for details.

## Energy Information

To view the Energy Usage, Energy Efficiency, and Efficiency Tips, press the  button on the center stack

and then press the Energy Info button at the top of the touch screen.

### Energy Usage

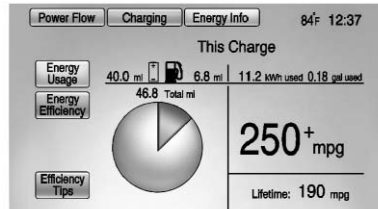

The Energy Usage screen displays information for the total of all drive cycles since the last time the high voltage battery was fully charged. This includes distance traveled in Electric Mode, distance traveled in Extended Range Mode, total distance traveled, electric energy used from the battery, total fuel used, and average fuel economy. There are maximum limits to some of the values that can be displayed. When these values are replaced with dashes, the value limits have

been reached. To reset these values, the high voltage battery will need to be fully recharged. The circle graph also represents the percentage of distance traveled using Electric Mode versus Extended Range Mode. The Lifetime Fuel Economy is a total over the life of the vehicle and can only be reset by the dealer.

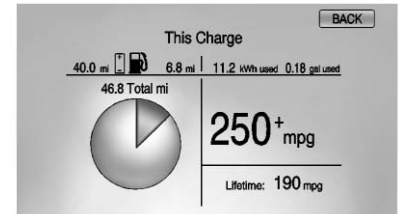

The Energy Usage information will also appear automatically on power off when Retained Accessory Power is active. This automatic pop-up can be disabled through vehicle personalization. See “Energy Summary Exit Pop-up” under *Vehicle Personalization* on page 5-51.

### Energy Efficiency

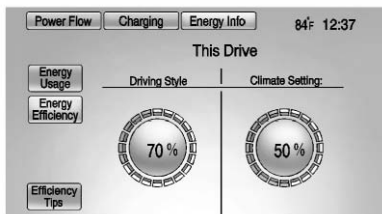

The Energy Efficiency screen is accessed by pressing Energy Efficiency on the Energy Usage screen. This screen displays the energy efficiency over the drive cycle based on driving style and climate settings. Driving in a more efficient manner will result in a higher percentage displayed for driving style. Minimizing the use of the climate control system will result in a higher percentage displayed for climate setting.

### Efficiency Tips

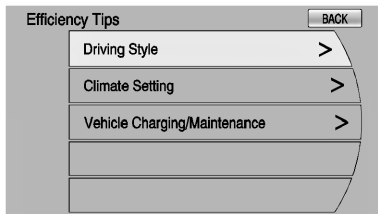

The Efficiency Tips screen is accessed by pressing Efficiency Tips from the Energy Usage or Energy Efficiency screen. This screen provides a guide on how to improve energy usage to increase fuel economy and range.

### Clock

The clock is in the center stack display.

To set the time:

1. Press the TP (Time Program) button to go directly to the time setting page, or press the CONFIG button and select Time

from the list. Turn the TUNE/MENU knob to scroll through the available setup features. Press the TUNE/MENU knob or press the Time screen button to display other options within that feature.

2. Press + or – to increase or decrease the Hours and Minutes displayed on the clock.

**12/24 HR Format:** Press the 12 HR screen button for standard time; press the 24 HR screen button for military time.

**Day + or Day –:** Press the Day + or Day – display buttons to increase or decrease the day.

**Display:** Press Display to turn the display of the time on the screen on or off.

## Driver Information Center (DIC)



The DIC display is in the instrument cluster. The DIC displays information about the vehicle. It also displays warning messages if a system problem is detected. See *Vehicle Messages on page 5-43*.

### DIC Operation and Displays

View the DIC displays by pressing the DIC buttons to the left of the steering wheel. The DIC displays trip, fuel, and warning messages if a system problem is detected.

### DIC Controls

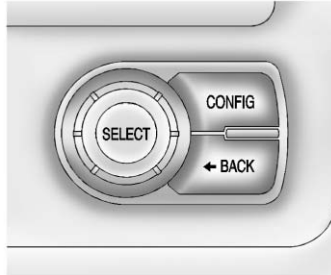

**CONFIG:** Press to select either the Simple or Enhanced instrument cluster configuration display.

**← BACK:** Press to return to the previous screen, exit a screen, or return to the main menu. Press ← BACK to minimize the DIC menu display.

**SELECT:** Press the center of the knob to select the highlighted item. Turn the knob to scroll through the menu items.

### DIC Menu Items

At the main DIC menu:

1. Turn the SELECT knob to scroll through the possible DIC menus.
2. Press the center of the SELECT knob when a menu item is highlighted to enter that menu.
3. Continue to turn and press the SELECT knob to scroll through and select the available menu items:

: Trip A

: Trip B

: Oil Life

: Tire Pressure

: Vehicle Messages

: Units

: Tutorial Mode

: Power Gauge

: Following Distance Indication

: Turn-by-Turn

## 5-42 Instruments and Controls

---

### Trip A and Trip B

The trip displays show fuel used, average fuel economy, and distance traveled since the last trip reset.

Reset the trip data by pressing and holding the SELECT button when either Trip A or Trip B is displayed.

### Oil Life

This displays the percentage of remaining oil life. The lower the percentage, the closer the vehicle is to needing an oil change.

When the oil life is depleted, the CHANGE ENGINE OIL SOON message displays. Change the oil as soon as possible. Additional maintenance is also recommended in the Maintenance Schedule. See *Maintenance Schedule on page 11-2* and *Engine Oil on page 10-9*.

The oil life must be reset after each oil change. Avoid accidental resetting of the Engine Oil Life System. It cannot be reset accurately until the next oil change.

To reset the Engine Oil Life System, see *Engine Oil Life System on page 10-12*. The system is reset when 100% displays.

### Tire Pressure

The display will show a vehicle with the approximate pressures of all four tires. Tire pressure is displayed in either kilopascals (kPa) or in pounds per square inch (psi).

If a low or high tire pressure is detected, a message is displayed advising to check the tire pressure in the specified tire. See *Tire Pressure on page 10-46* and *Tire Messages on page 5-50*.

If the tire pressure display shows dashes instead of a value, there may be a problem with the vehicle. See your dealer for service.

### Vehicle Messages

Turn the SELECT knob to scroll through any active warning messages. Press SELECT to review the messages.

### Units

Turn the SELECT knob to change the unit display to METRIC or US when the display is active. Press SELECT to confirm the setting. This will change the displays on the cluster and DIC to either metric or English (US) measurements.

### Tutorial Mode

Select this menu item to view a screen that explains some of the unique features of the cluster or the Open Source Software information for the cluster.

Tutorial mode is only available when the vehicle is in P (Park).

### Power Gauge

Select this menu item the power gauge.

The power gauge informs the driver of the total power coming from the engine or battery to operate the vehicle. When in Regen mode, this

gauge will inform the driver of the amount of power being restored to the battery from the vehicle.

### **Following Distance Indication**

Select this menu item to adjust the following distance indication. See "Following Distance Indication" under *Forward Collision Alert (FCA) System* on page 9-38 for more information.

### **Turn-by-Turn**

Select this menu item to view the OnStar or Navigation System Turn-by-Turn guidance. See the infotainment manual.

## **Vehicle Messages**

Messages displayed in the DIC indicate the status of the vehicle or some action that may be needed to correct a condition. Multiple messages may display one after the other.

Messages that do not require immediate action can be acknowledged and cleared by pressing the SELECT knob. The messages requiring immediate action cannot be cleared until that action is performed. All messages should be taken seriously. Clearing the messages does not correct the problem.

## **Battery and Charging Messages**

### **BATTERY SAVER ACTIVE**

This message displays when the vehicle has detected that the 12-volt battery voltage has dropped and vehicle features are being disabled.

The 12-volt battery saver system starts reducing certain features trying to save the charge of the 12-volt battery. Turn off unnecessary features to allow the battery to recharge.

### **BATTERY TOO COLD, PLUG IN TO WARM**

This message displays during extremely cold temperatures, when the vehicle will not start until the high voltage battery is warm enough.

Plug the vehicle in and make sure the power button is off to allow the charging system to warm the high voltage battery, then the vehicle can be started.

### **CHARGE CORD CONNECTED**

This message displays when the charge cord is connected to the vehicle. The vehicle cannot be shifted out of P (Park) with the charge cord connected.

### **CHARGE DOOR OPEN**

This message displays when the charge door is open and the vehicle is shifted out of P (Park).

### **LOW BATTERY**

This message displays when the 12-volt battery voltage is low. See *Battery on page 10-22*.

### **SERVICE BATTERY CHARGING SYSTEM**

This message displays when there is a fault in the 12-volt battery charging system. Take the vehicle to your dealer for service.

### **SERVICE HIGH VOLTAGE CHARGING SYSTEM**

This message displays when there is a problem with the high voltage charging system. See your dealer for service.

## **Brake System Messages**

### **BRAKE FLUID LOW**

This message displays when the brake fluid level is low. See *Brake Fluid on page 10-21*.

### **RELEASE PARKING BRAKE**

This message displays if the electric parking brake is on while the vehicle is in motion. Release it before attempting to drive. See *Electric Parking Brake on page 9-30*.

### **SERVICE BRAKE ASSIST**

This message displays when there is a problem with the brake boost system. When this message displays, the brake pedal may be harder to push and the stopping distance may be longer. Take the vehicle to your dealer for service.

### **SERVICE PARKING BRAKE**

This message displays when there is a problem with the parking brake. Take the vehicle to your dealer for service.

## **STEP ON BRAKE TO RELEASE PARK BRAKE**

This message displays when attempting to release the electric parking brake without the brake pedal applied. See *Electric Parking Brake on page 9-30*.

## **Cruise Control Messages**

### **CRUISE SET TO XXX**

This message displays when the cruise control is set and shows the speed it was set to. See *Cruise Control on page 9-35*.

## **Door Ajar Messages**

### **DOOR(S) OPEN, HOOD OPEN, HATCH OPEN**

A symbol will appear on the display showing the area that is open. See *Door, Hood, or Hatch Open Light on page 5-26*.

## Drive Mode Messages

### HOLD MODE NOT AVAILABLE

This message displays when in Hold Mode and the mode becomes unavailable. See “Hold Mode” under *Driver Selected Operating Modes* on page 9-22.

### MOUNTAIN MODE NOT AVAILABLE

This message displays when in Mountain Mode and the mode becomes unavailable. See “Mountain Mode” under *Driver Selected Operating Modes* on page 9-22.

### SPORT MODE NOT AVAILABLE

This message displays when in Sport Mode and the mode becomes unavailable. See “Sport Mode” under *Driver Selected Operating Modes* on page 9-22.

## Electric Drive Unit Messages

### SHIFT TO PARK

This message displays when the vehicle should be shifted to P (Park). This may appear when attempting to turn off the vehicle when it is not in P (Park).

## Engine Cooling System Messages

### ENGINE OVERHEATED — REDUCE SPEED

This message displays when the engine coolant temperature or engine oil is too hot. Reduce speed and allow the vehicle to cool down.

### ENGINE OVERHEATED — TURN VEHICLE OFF

This message displays and a continuous chime sounds if the engine cooling system reaches unsafe temperatures for operation.

Stop and turn off the vehicle as soon as it is safe to do so to avoid severe damage. This message clears when the engine has cooled to a safe operating temperature.

### ENGINE RUNNING DUE TO TEMPERATURE

This message displays when the high voltage battery is charged but the engine has to come on because of the outside temperature or high voltage battery temperature.

## Engine Oil Messages

### CHANGE ENGINE OIL SOON

This message displays when the engine oil needs to be changed. After changing the engine oil, the Engine Oil Life System must be reset. See *Engine Oil Life System* on page 10-12 and *Driver Information Center (DIC)* on page 5-41 for information on how to reset the system. See *Engine Oil* on page 10-9 and *Maintenance Schedule* on page 11-2.

### **OIL PRESSURE LOW — TURN VEHICLE OFF**

This message displays if low oil pressure levels occur. Stop the vehicle as soon as safely possible and do not operate it until the cause of the low oil pressure has been corrected. Check the oil as soon as possible and have the vehicle serviced by your dealer.

### **Fuel System Messages**

#### **CLOSE FUEL DOOR**

This message displays when the fuel door is open and the vehicle is moving.

#### **ENGINE NOT AVAILABLE ADD FUEL**

This message displays when the engine is not available due to running out of fuel. The vehicle can continue to be driven in Electric Mode until the battery is depleted, but will have reduced acceleration.

When this message is displayed, refuel the vehicle. See *Out of Fuel/Engine Unavailable* on page 9-24.

#### **FUEL LEVEL LOW**

This message displays when the vehicle is low on fuel. Refuel as soon as possible.

#### **READY TO REFUEL**

This message displays when the fuel system is depressurized and the vehicle can be refueled.

#### **TIGHTEN GAS CAP**

This message displays when the fuel cap is not on tight. Tighten the fuel cap.

#### **WAIT TO REFUEL**

This message displays when the fuel system is pressurized and you must wait to refuel the vehicle.



### **Key and Lock Messages**

When programming new Remote Keyless Entry (RKE) transmitters, DIC messages display. See *Remote Keyless Entry (RKE) System Operation* on page 2-2.

#### **NO REMOTE DETECTED**

This message displays when the RKE transmitter is not detected while attempting to start the vehicle. The transmitter battery may be weak. See “Starting the Vehicle with a Low Transmitter Battery” under *Remote Keyless Entry (RKE) System Operation* on page 2-2.

#### **NO REMOTE DETECTED, PRESS BRAKE TO RESTART**

This message displays if the RKE transmitter is no longer detected in the vehicle. Press the brake pedal and the POWER  button to restart the vehicle, or press the POWER  button without pressing the brake pedal to turn the vehicle off. If the



vehicle is turned off and a valid transmitter is not available, the vehicle will not restart.

### **REMINDER: KEY LEFT IN VEHICLE**

This message displays when leaving the vehicle with the RKE transmitter still inside.

### **REPLACE BATTERY IN REMOTE KEY**

This message displays when the battery in the RKE transmitter needs to be replaced.

### **SERVICE KEYLESS START SYSTEM**

This message displays when the keyless start system needs service. Take the vehicle to your dealer.

## **Lamp Messages**

### **AUTOMATIC LIGHT CONTROL ON OR OFF**

A message will display when the automatic light control has been turned on or off.

### **CHECK LAMP or LAMP FAILURE**

Depending on the lamp, one of these messages may display. See *Bulb Replacement on page 10-27*.

### **TURN SIGNAL ON**

This message displays if the turn signal has been left on. Turn off the turn signal.

## **Object Detection System Messages**

### **FORWARD COLLISION ALERT OFF**

If your vehicle has the Forward Collision Alert (FCA) system, this message may display if the FCA

system cannot activate due to a temporary condition. See *Forward Collision Alert (FCA) System on page 9-38*.

### **FRONT CAMERA BLOCKED, CLEAN WINDSHIELD**

This message displays when the Lane Departure Warning (LDW) and Forward Collision Alert (FCA) systems are disabled because the camera view is blocked and cannot operate properly. It may also activate during heavy rain or due to road spray. To clean the system, clean the outside of the windshield area in front of the LDW/FCA camera sensor.

### **LANE DEPARTURE SYSTEM UNAVAILABLE**

If your vehicle has the Lane Departure Warning (LDW) system, this message may display if the LDW system cannot activate due to a temporary condition. See *Lane Departure Warning (LDW) on page 9-44* for more information.

### **PARK ASSIST OFF**

This message displays when the parking assist system has been turned off or when there is a temporary condition causing the system to be disabled. See *Ultrasonic Parking Assist* on page 9-40.

### **SERVICE FRONT CAMERA**

This message displays when the Lane Departure Warning (LDW) and Forward Collision Alert (FCA) systems are disabled and need service. See your dealer.

### **SERVICE PARKING ASSIST**

This message displays if there is a problem with the parking assist system. Do not use this system to help you park. See *Ultrasonic Parking Assist* on page 9-40 for more information.

### **Propulsion Power Messages**

#### **PROPULSION POWER IS REDUCED**

This message displays when the propulsion power is reduced and can affect the ability to accelerate. If this message is on, but there is no reduction in performance, proceed to your destination. The performance may be reduced the next time the vehicle is driven. The vehicle may be driven at a reduced speed while this message is on, but maximum acceleration and speed may be reduced. If this message stays on when the malfunction indicator lamp is on, the vehicle should be taken to your dealer for service as soon as possible.

This message can display when driving in mountainous terrain without using Mountain Mode or by not entering Mountain Mode soon enough to build a sufficient battery charge reserve before climbing

steep grades. This is normal operation to protect the high voltage battery. Only if both the PROPULSION POWER IS REDUCED message and the malfunction indicator lamp are on should the vehicle be taken to the dealer for service.

While climbing the grade with this message displayed, the vehicle speed may be reduced until the engine can recover the battery state of charge to a normal level. See "Mountain Mode" under *Driver Selected Operating Modes* on page 9-22.

### **Ride Control System Messages**

#### **LOW TRACTION**

This message displays when the Antilock Brake System (ABS) is active and is working to assist the driver with control of the vehicle in difficult driving conditions.

**SERVICE STABILITRAK**

This message displays when there is a problem detected with the StabiliTrak system. The vehicle is safe to drive, but the StabiliTrak system is not operational. See *Electronic Stability Control (ESC)* on page 9-34 for information on resetting the system.

**SERVICE TRACTION CONTROL**

This message displays when there is a problem detected with the Traction Control System (TCS). The vehicle is safe to drive, but the TCS is not operational. See *Traction Control System (TCS)* on page 9-32 for information on resetting the system.

**STABILITRAK OFF**

This message displays when StabiliTrak is turned off. Adjust your driving accordingly.

**TRACTION CONTROL OFF**

This message displays when the Traction Control System (TCS) is turned off. Adjust your driving accordingly.

**TRACTION CONTROL ON**

This message displays when the Traction Control System (TCS) is turned on.

**Airbag System Messages****SERVICE AIRBAG**

This message displays if there is a problem with the airbag system. Take the vehicle to your dealer for service.

**Security Messages****SERVICE THEFT ALARM**

This message displays if there is a problem with the alarm. See your dealer for service.

**SERVICE THEFT DETERRENT SYSTEM**

This message displays if there is a problem with the theft-deterrent system. See your dealer for service.

**Service Vehicle Messages****ENGINE MAINTENANCE XXX% COMPLETE**

This message displays when the Engine Maintenance Mode is running. See “Engine Maintenance Mode” under *Maintenance Modes* on page 9-25.

**ENGINE NOT AVAILABLE SERVICE SOON**

This message displays when the engine is not available due to a malfunction that will not allow the engine to start. The vehicle can continue to be driven in Electric Mode until the battery is depleted, but will have reduced acceleration. When this message is displayed, the vehicle should be taken to your

dealer for service as soon as possible. See *Out of Fuel/Engine Unavailable* on page 9-24.

### **SERVICE AC SYSTEM**

This message displays if there is a problem with the air conditioning system. Take the vehicle to your dealer for service.

### **SERVICE HEATER SOON**

This message displays if there is a problem with the heater system. Take the vehicle to your dealer for service.

### **SERVICE POWER STEERING**

This message displays if there is a problem with the power steering system. Take the vehicle to your dealer for service.

### **SERVICE VEHICLE SOON**

This message displays if there is a problem with the vehicle. Take the vehicle to your dealer for service.

Depending on the severity of a crash, this message may come on along with the airbag readiness light.

### **Starting the Vehicle Messages**

#### **PRESS BRAKE TO START VEHICLE**

This message displays when attempting to start the vehicle without first pressing the brake pedal.

#### **PRESS BUTTON AGAIN TO TURN OFF**

This message displays as a reminder to press the POWER  button to turn the vehicle off when an attempt is made to turn off the vehicle while it is in motion.

### **Tire Messages**

#### **SERVICE TIRE MONITOR SYSTEM**

This message displays if there is a problem with the Tire Pressure Monitor System (TPMS). See *Tire Pressure Monitor Operation* on page 10-48.

#### **TIRE LEARNING ACTIVE**

This message displays when the system is learning new tires. See *Tire Pressure Monitor Operation* on page 10-48.

#### **TIRE LOW ADD AIR TO TIRE**

This message displays when the pressure in one or more of the tires is low.

This message also displays LEFT FRONT, RIGHT FRONT, LEFT REAR, or RIGHT REAR to indicate the location of the low tire.

The low tire pressure warning light will also come on. See *Tire Pressure Light* on page 5-24.

If a tire pressure message appears on the DIC, stop as soon as you can. Inflate the tires by adding air until the tire pressure is equal to the values shown on the Tire and Loading Information label. See *Tires on page 10-39*, *Vehicle Load Limits on page 9-11*, and *Tire Pressure on page 10-46*.

You can receive more than one tire pressure message at a time. The DIC also shows the tire pressure values. See *Driver Information Center (DIC) on page 5-41*.

## Vehicle Reminder Messages

### ICE POSSIBLE DRIVE WITH CARE

This message is displayed when ice conditions are possible.

## Vehicle Speed Messages

### SPEED LIMITED TO XXX

This message displays when the vehicle speed is limited.

## Vehicle Personalization

The Vehicle Personalization features can be accessed by using either the infotainment controls or the touch screen in the center stack display. See “Overview” in the infotainment manual.

### Using the Infotainment Controls

Use the CONFIG, TUNE/MENU knob, and ◀ BACK buttons on the center stack to select personalization features.

**CONFIG (Configure):** Press to scroll through the available menus across the top of the touch screen display.

### TUNE/MENU Knob

- Press to enter, select, or activate a highlighted menu option.
- Turn to highlight a menu option.

## 5-52 Instruments and Controls

- Press to turn a system setting on or off.

### ◀ BACK

- Press to exit a menu.
- Press to return to a previous screen.

### Submenus

An arrow on the right-hand edge of the menu indicates that it has a submenu with other options.

### Selecting a Menu Option

1. Turn the TUNE/MENU knob to highlight the function.
2. Press the TUNE/MENU knob to select the highlighted option. A checkmark next to the option indicates the selected option.

### Turning a Function On or Off

1. Turn the TUNE/MENU knob to highlight the function.

2. Press the TUNE/MENU knob to turn the function on or off. A checkmark next to the function indicates that the function is on.

### Using the Touch Screen

Use the touch screen icons and menus on the center stack display to select personalization features.

△ : Touch to scroll up.

▽ : Touch to scroll down.

**Back:** Touch Back in the upper right corner of the display to return to the previous menu.

### Submenus

An arrow on the right-hand edge of the menu indicates that it has a submenu with other options.

### Selecting a Menu Option

Touch any one of the available menu options on the touch screen to select the option. A checkmark next to the option indicates the selected option.

### Turning a Function On or Off

Touch the screen where the available function is listed to turn it on or off. A checkmark next to the function indicates that the function is on.

### Entering the Personalization Menu

Press CONFIG. The Configuration Settings menu will display.

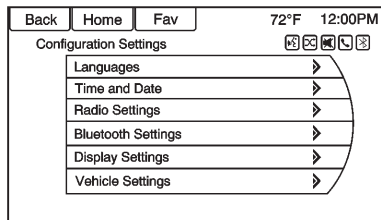

### Languages

This allows the selection of a language:

1. Press the Languages menu on the touch screen.

2. Select English, French, or Spanish.
3. Press Back to return to the previous menu.

### Vehicle Settings

Press the Vehicle Settings menu on the touch screen.

The Vehicle Settings menu may include:

- Climate and Air Quality
- Comfort and Convenience
- Lighting
- Power Door Locks
- Remote Locking, Unlocking, Starting
- Return to Factory Settings

### Climate and Air Quality

Select the Climate and Air Quality menu to display:

- Auto Fan Speed
- Auto Heated Seats
- Remote Start Auto Heated Seats

- Auto Defog
- Engine Assisted Heating
- Engine Assisted Heating (Plugged-In)

### Auto Fan Speed

This feature sets the automatic fan speed to maintain the desired interior temperature. Select a blower setting:

**High:** Increased speed.

**Medium:** Moderate speed.

**Low:** Reduced speed.

To select the auto fan speed:

1. Press the Vehicle Settings menu.
2. Select Climate and Air Quality.
3. Select Auto Fan Speed.
4. Select the fan speed.
5. Press Back to return to the previous menu.

### Auto Heated Seats

When enabled, the auto heated seat buttons on the touch screen will be highlighted. This feature will automatically activate heated seats at the level required by the interior temperature. The auto heated seats can be turned off by using the heated seat buttons on the center stack.

To turn the auto heated seats on or off:

1. Press the Vehicle Settings menu.
2. Select Climate and Air Quality.
3. Turn the auto heated seats feature on or off.
4. Press Back to return to the previous menu.

### Remote Start Auto Heated Seats

When on, this feature will turn the heated seats on when using remote start.

## 5-54 Instruments and Controls

---

To turn the remote start auto heated seats on or off:

1. Press the Vehicle Settings menu.
2. Select Climate and Air Quality.
3. Turn the remote start auto heated seats feature on or off.
4. Press Back to return to the previous menu.

### Auto Defog

When on and high humidity is detected, the climate control system will adjust the outside air, air conditioner, or heat to decrease fogging. The fan speed may increase. When high humidity is no longer detected, the system will return to previous operation.

To turn the auto defog on or off:

1. Press the Vehicle Settings menu.
2. Select Climate and Air Quality.
3. Turn the auto defog feature on or off.

4. Press Back to return to the previous menu.

### Engine Assisted Heating

If equipped, this feature selects the outside temperature level at which the engine may run to assist heating in Electric Mode. A change in selection will not take affect until after the vehicle is first powered down.

The Engine Assisted Heating options are:

- At Cold Outside Temperatures, below approximately 2°C (35°F).
- At Very Cold Outside Temperatures, below approximately -10°C (15°F).

To select the outside temperature level at which the engine may run to assist heating in electric mode:

1. Press the Vehicle Settings menu.
2. Select Climate and Air Quality.
3. Select Engine Assisted Heating.

4. Select the temperature level.
5. Press Back to return to the previous menu.

### Engine Assisted Heating (Plugged-In)

If equipped, this feature turns on or off the ability for the engine to run to help heat the vehicle when it is plugged in. A change in setting will not take affect until after the vehicle is first powered down.

The Engine Assisted Heating (Plugged-In) options are:

- On
- Off

To turn the Engine Assisted Heating (Plugged-In) on or off:

1. Press the Vehicle Settings menu.
2. Select Climate and Air Quality.
3. Turn the engine assisted heating (Plugged-In) feature on or off.
4. Press Back to return to the previous menu.



## Comfort and Convenience

Select the Comfort and Convenience menu and the following will be displayed:

- Chime Volume
- Button Chime
- Energy Summary Exit Pop-up
- Charge Cord Theft Alert
- Charge Power Loss Alert

### Chime Volume

This allows the selection of the chime volume level to be either normal or high.

To select the chime volume level:

1. Press the Vehicle Settings menu.
2. Select Comfort and Convenience.
3. Select Chime Volume.
4. Select the volume level.
5. Press Back to return to the previous menu.

### Button Chime

This allows a tone to be heard when a selection is made using the infotainment system.

To turn the button chime on or off:

1. Press the Vehicle Settings menu.
2. Select Comfort and Convenience.
3. Turn the button chime feature on or off.
4. Press Back to return to the previous menu.

### Energy Summary Exit Pop-up

This allows the energy summary exit pop-up to be turned on or off:

1. Press the Vehicle Settings menu.
2. Select Comfort and Convenience.
3. Turn the energy summary exit pop-up feature on or off.

4. Press Back to return to the previous menu.

### Charge Cord Theft Alert

This allows the charge cord theft alert to be turned on or off:

1. Press the Vehicle Settings menu.
2. Select Comfort and Convenience.
3. Turn the charge cord theft alert feature on or off.
4. Press Back to return to the previous menu.

### Charge Power Loss Alert

This allows the charge power loss alert to be turned on or off:

1. Press the Vehicle Settings menu.
2. Select Comfort and Convenience.
3. Turn the charge power loss alert feature on or off.

## 5-56 Instruments and Controls

---

4. Press Back to return to the previous menu.

### Lighting

Select the Lighting menu and the following will be displayed:

- Exit Lighting
- Vehicle Locator Lights

### Exit Lighting

This allows the selection of how long the exterior lamps stay on when leaving the vehicle and it is dark outside.

The available options are:

- OFF
- 30 seconds
- 1 minute
- 2 minutes

To select the length of time the exterior lamps will remain on:

1. Press the Vehicle Settings menu.
2. Select Lighting.

3. Select Exit Lighting.
4. Select the length of time the exterior lamps will remain on.
5. Press Back to return to the previous menu.

### Vehicle Locator Lights

This allows the vehicle locator lights to be turned on or off. When on, the headlamps, parking lamps, taillamps, license plate lamps, and back-up lamps will illuminate when  is pressed on the RKE transmitter.

To turn the vehicle locator lights on or off:

1. Press the Vehicle Settings menu.
2. Select Lighting.
3. Select Vehicle Locator Lights.
4. Turn the vehicle locator lights on or off.
5. Press Back to return to the previous menu.

### Power Door Locks

Select Power Door Locks and the following will be displayed:

- Auto Door Unlock
- Unlocked Door Anti Lock Out
- Delayed Door Lock

### Auto Door Unlock

This allows selection of which doors will automatically unlock when the vehicle is shifted into P (Park).

The available options are:

- All Doors
- Driver Door
- OFF

To select how the doors will automatically unlock:

1. Press the Vehicle Settings menu.
2. Select Power Door Locks.
3. Select Auto Door Unlock.
4. Select how the doors will automatically unlock.

5. Press Back to return to the previous menu.

**Unlocked Door Anti Lock Out**

When on, this feature will keep the driver door from locking until the door is closed. If this feature is turned on, the Delayed Door Lock menu will not be available.

To turn the unlocked door anti lock out feature on or off:

1. Press the Vehicle Settings menu.
2. Select Power Door Locks.
3. Select Unlocked Door Anti Lock Out.
4. Turn the unlocked door anti lock out feature on or off.
5. Press Back to return to the previous menu.

**Delayed Door Lock**

When on, this feature will delay the locking of the doors. To override the delay, press the power door lock switch on the center stack.

To turn the delayed door lock feature on or off:

1. Press the Vehicle Settings menu.
2. Select Power Door Locks.
3. Select Delayed Door Lock.
4. Turn the delayed door lock feature on or off.
5. Press Back to return to the previous menu.

**Remote Locking, Unlocking, Starting**

Select Remote Locking, Unlocking, Starting and the following will be displayed:

- Remote Lock Feedback
- Remote Unlock Light Feedback
- Door Unlock or Remote Door Unlock
- Remote Left in Vehicle Reminder
- Passive Door Unlock
- Passive Door Lock

**Remote Lock Feedback**

This allows selection of what feedback is provided when unlocking the vehicle with the RKE transmitter.

The available options are:

- Lights and Horn
- Lights Only
- Horn Only
- OFF

To select the remote lock feedback:

1. Press the Vehicle Settings menu.
2. Select Remote Locking, Unlocking, Starting.
3. Select Remote Lock Feedback.
4. Select the remote feedback.
5. Press Back to return to the previous menu.

### Remote Unlock Light Feedback

When on, the exterior lamps will flash when unlocking the vehicle with the RKE transmitter.

To turn the remote unlock light feedback feature on or off:

1. Press the Vehicle Settings menu.
2. Select Remote Locking, Unlocking, Starting.
3. Select Remote Unlock Light Feedback.
4. Turn the remote unlock light feedback feature on or off.
5. Press Back to return to the previous menu.

### Door Unlock or Remote Door Unlock



This allows selection of which doors will unlock when pressing  on the RKE transmitter.

The available options are:

- All Doors

- Driver Door

If All Doors is selected, all doors will be unlocked.

If Driver Door is selected, only the driver door will be unlocked on the first press of . All doors will be unlocked on the second press of  within five seconds of the prior press.

To select how the doors will unlock with the RKE transmitter:

1. Press the Vehicle Settings menu.
2. Select Remote Locking, Unlocking, Starting.
3. Select Door Unlock or Remote Door Unlock.
4. Select how the doors will unlock.
5. Press Back to return to the previous menu.

### Remote Left in Vehicle Reminder

When on, the horn will chirp rapidly three times if an RKE transmitter is left in the vehicle.

To turn the remote left in vehicle reminder feature on or off:

1. Press the Vehicle Settings menu.
2. Select Remote Locking, Unlocking, Starting.
3. Select Remote Left in Vehicle Reminder.
4. Turn the remote left in vehicle reminder feature on or off.
5. Press Back to return to the previous menu.

### Passive Door Unlock

This allows selection of which doors are unlocked by pressing the button on the outside door handle.

The available options are:

- All Doors
- Driver Door

To select how the doors will unlock:

1. Press the Vehicle Settings menu.

2. Select Remote Locking, Unlocking, Starting.
3. Select Passive Door Unlock.
4. Select which doors to unlock.
5. Press Back to return to the previous menu.

### Passive Door Lock

This allows passive locking to be turned on or off and select what type of feedback.

The available options are:

- Off
- On
- On with Active Horn Chirp

To select doors locking feedback:

1. Press the Vehicle Settings menu.
2. Select Remote Locking, Unlocking, Starting.
3. Select Passive Door Lock.
4. Select On, Off, or On with Active Horn Chirp.

5. Press Back to return to the previous menu.

### Return to Factory Settings

This returns all of the vehicle personalization settings to the factory settings.

1. Press the Vehicle Settings menu.
2. Select Return to Factory Settings.
3. Select Yes or No.
4. Press Back to return to the previous menu.

## Universal Remote System

See *Radio Frequency Statement on page 13-15* for information regarding Part 15 of the Federal Communications Commission (FCC) rules and Industry Canada Standards RSS-GEN/210/220/310.

### Universal Remote System Programming



If the vehicle has this feature, you will see these buttons with one indicator light next to them in the overhead console.

This system provides a way to replace up to three remote control transmitters used to activate

devices such as garage door openers, security systems, and home automation devices.

Do not use the Universal Remote system with any garage door opener that does not have the stop and reverse feature. This includes any garage door opener model manufactured before April 1, 1982.

Read the instructions completely before attempting to program the Universal Remote system. Because of the steps involved, it may be helpful to have another person available to assist with programming the Universal Remote system.

Keep the original hand-held transmitter for use in other vehicles as well as for future Universal Remote system programming. It is also recommended that upon the sale of the vehicle, the programmed Universal Remote system buttons be erased for security purposes. See "Erasing Universal Remote System Buttons" later in this section.

When programming a garage door, park outside of the garage. Park directly in line with and facing the garage door opener motor-head or gate motor-head. Be sure that people and objects are clear of the garage door or gate being programmed.

It is recommended that a new battery be installed in the hand-held transmitter for quicker and more accurate transmission of the radio-frequency signal.

### **Programming the Universal Remote System**

For questions or help programming the Universal Remote system, call 1-800-355-3515 or go to [www.homelink.com](http://www.homelink.com).

Programming a garage door opener involves time-sensitive actions, so read the entire procedure before starting. Otherwise, the device will time out and the procedure will have to be repeated.

To program up to three devices:

1. Hold the end of the hand-held transmitter about 3 to 8 cm (1 to 3 in) away from the Universal Remote system buttons while keeping the indicator light in view. The hand-held transmitter was supplied by the manufacturer of the garage door opener receiver (motor-head unit).
2. At the same time, press and hold both the hand-held transmitter button and one of the three Universal Remote system buttons to be used to operate the garage door. Do not release the Universal Remote system button or the hand-held transmitter button until the indicator light changes from a slowly to a rapidly flashing light. You now may release both buttons.

Some entry gates and garage door openers may require substitution of Step 2 with the

procedure noted in “Gate Operator and Canadian Programming” later in this section.

3. Press and hold for five seconds the newly trained Universal Remote system button (the button selected in Step 2) while observing the indicator light and garage door activation.

- If the indicator light stays on continuously or the garage door starts to move when the Universal Remote system button is pressed and released, then the programming is complete. There is no need to continue programming Steps 4–6.
- If the Universal Remote system indicator light blinks rapidly for two seconds, then turns to a constant light and the garage door

does not move, continue with programming Steps 4–6.

It may be helpful to have another person assist with the remaining Steps 4–6.

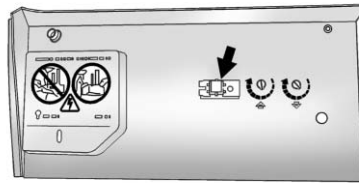

**“Learn” or “Smart” Button**

4. After Steps 1–3 have been completed, locate the “Learn” or “Smart” button inside the garage on the garage door opener receiver (motor-head unit). The name and color of the button may vary by manufacturer.

5. Firmly press and release the “Learn” or “Smart” button. After pressing this button, you will have 30 seconds to complete Step 6.
6. Immediately return to the vehicle. Firmly press and hold for two seconds the Universal Remote system button, selected in Step 2 to control the garage door, and then release it. If the garage door does not move or the lamp on the garage door opener receiver (motor-head unit) does not flash, press and hold the same button a second time for two seconds, then release it. Again, if the door does not move or the garage door lamp does not flash, press and hold the same button a third time for two seconds, then release.

The Universal Remote system should now activate the garage door.

To program the remaining two Universal Remote system buttons, begin with Step 1 of "Programming the Universal Remote System."

### **Gate Operator and Canadian Programming**

If you have questions or need help programming the Universal Remote system, call 1-800-355-3515 or go to [www.homelink.com](http://www.homelink.com).

Canadian radio-frequency laws require transmitter signals to time out or quit after several seconds of transmission. This may not be long enough for the Universal Remote system to pick up the signal during programming. Similarly, some U.S. gate operators are manufactured to time out in the same manner.

If you live in Canada, or you are having difficulty programming a gate operator or garage door opener by using the "Programming the Universal Remote System" procedures, regardless of where you live, replace Step 2 under "Programming the Universal Remote System" with the following:

Continue to press and hold the Universal Remote system button while you press and release every two seconds (cycle) the hand-held transmitter button until the frequency signal has been successfully accepted by the Universal Remote system. The Universal Remote system indicator light will flash slowly at first and then rapidly. Proceed with Step 3 under "Programming the Universal Remote System" to complete.

### **Universal Remote System Operation**

#### **Using the Universal Remote System**

Press and hold the appropriate Universal Remote system button for at least half of a second. The indicator light will come on while the signal is being transmitted.

#### **Erasing Universal Remote System Buttons**

All programmed buttons should be erased when the vehicle is sold or the lease ends.

To erase all programmed buttons on the Universal Remote system device:

1. Press and hold down the two outside buttons until the indicator light begins to flash. This should take about 10 seconds.
2. Release both buttons.



### **Reprogramming a Single Universal Remote System Button**

To reprogram any of the three Universal Remote system buttons:

1. Press and hold the desired Universal Remote system button. Do not release the button.
2. The indicator light will begin to flash after 20 seconds. Without releasing the button, proceed with Step 1 under "Programming the Universal Remote System."

If you have questions or need help programming the Universal Remote system, call 1-800-355-3515 or go to [www.homelink.com](http://www.homelink.com). You may also call the customer assistance phone number under *Customer Assistance Offices* on page 13-3.



## Lighting

### Exterior Lighting

Exterior Lamp Controls .....	6-1
Headlamp High/Low-Beam Changer .....	6-1
Flash-to-Pass .....	6-2
Daytime Running Lamps (DRL) .....	6-2
Automatic Headlamp System .....	6-2
Hazard Warning Flashers .....	6-3
Turn and Lane-Change Signals .....	6-3

### Interior Lighting

Instrument Panel Illumination Control .....	6-4
Dome Lamps .....	6-4
Reading Lamps .....	6-4

### Lighting Features

Entry Lighting .....	6-5
Exit Lighting .....	6-5
Battery Power Protection .....	6-5

## Exterior Lighting

### Exterior Lamp Controls



The exterior lamp control is on the turn signal lever.

There are four positions.

**OFF** (Off): Turns the exterior lamps off.

**AUTO (Automatic Headlamps)**: Turns the exterior lamps on and off automatically depending on the exterior light.

**Parking Lamps**: Turns on the parking lamps together with the following:

- Sidemarkers Lamps
- Taillamps

- License Plate Lamps
- Instrument Panel Lights

**Headlamps**: Turns on the headlamps, together with the previously listed lamps and lights.

### Headlamp High/Low-Beam Changer

**Headlamp High/Low-Beam Changer**: Push the turn signal lever away from you and release, to turn the high beams on. To return to low beams, push the lever again or pull it toward you and release.



This indicator light turns on in the instrument cluster when the high-beam headlamps are on.

## 6-2 Lighting

### Flash-to-Pass

The flash-to-pass feature works with the low beams or Daytime Running Lamps (DRL) on or off.

To flash the high beams, pull the turn signal lever toward you momentarily and then release it.

### Daytime Running Lamps (DRL)

The DRL system comes on in daylight when the following conditions are met:

- The vehicle is on.
- The exterior lamp control is in the automatic position.
- The electric drive unit is not in P (Park).
- The light sensor determines it is daytime.

Fully functional DRL are required on all vehicles first sold in Canada.

When the DRL are on, the taillamps, sidemarker lamps, instrument panel lights, and other lamps will not be on. The instrument cluster will be lit.

When the exterior lamp control is turned to the headlamp position, the low-beam headlamps come on. The other lamps that come on with the headlamps will also come on.

When the vehicle is on and you are stopped, the DRL can be turned off by moving the shift lever to P (Park). The DRL will stay off until the shift lever is moved out of the P (Park) position.

The regular headlamp system should be turned on when needed.

### Automatic Headlamp System

When the exterior lamp control is set to AUTO and it is dark enough outside, the headlamps come on automatically.

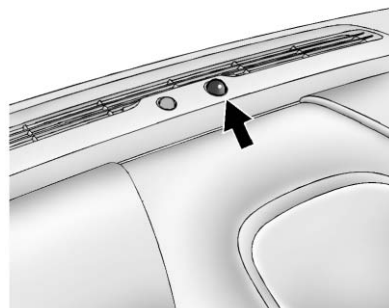

There is a light sensor on top of the instrument panel. Do not cover the sensor, otherwise the headlamps will come on when they are not needed.



The system may also turn on the headlamps when driving through a parking garage or tunnel.

When it is bright enough outside, the headlamps will turn off or may change to Daytime Running Lamps (DRL).

The automatic headlamp system turns off when the exterior lamp control is turned to  or the ignition is off.

### Lights On with Wipers

If the windshield wipers are activated in daylight with the engine on, and the exterior lamp control is in AUTO, the headlamps, parking lamps, and other exterior lamps come on. The transition time for the lamps coming on varies based on wiper speed. When the wipers are not operating, these lamps turn off.

Move the exterior lamp control to  or  to disable this feature.

### Hazard Warning Flashers

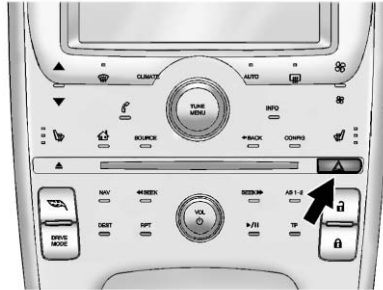

 (**Hazard Warning Flasher**): Press this button to make the front and rear turn signal lamps flash on and off. This warns others that you are having trouble.

Press  again to turn the flashers off.

### Turn and Lane-Change Signals

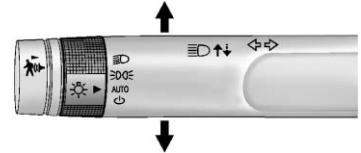

Move the lever all the way up or down to signal a turn.

An arrow on the instrument cluster will flash in the direction of the turn or lane change.

Raise or lower the lever until the arrow starts to flash to signal a lane change. Hold it there until the lane change is complete. If the lever is moved momentarily to the lane change position, the arrow will flash three times.

The lever returns to its starting position when it is released.

## 6-4 Lighting

If after signaling a turn or lane change, the arrow flashes rapidly or does not come on, a signal bulb may be burned out.

Have any burned out bulbs replaced. If a bulb is not burned out, check the fuse. See *Instrument Panel Fuse Block (Left Side)* on page 10-34 or *Instrument Panel Fuse Block (Right Side)* on page 10-35.

### Interior Lighting

#### Instrument Panel Illumination Control

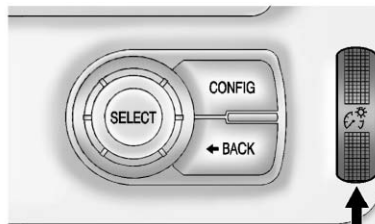

The brightness of the instrument panel cluster display, infotainment display and controls, steering wheel controls, and all other illuminated controls, as well as feature status indicators can be adjusted.

The thumbwheel is on the instrument panel beside the steering column.

Move the thumbwheel up or down to brighten or dim the lights.

### Dome Lamps

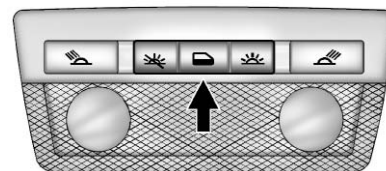

The dome lamp controls are in the overhead console.

To operate, press the following buttons:

 **(On):** Press to turn on the dome lamps.

 **(Door):** Press to turn the lamps on automatically when a door is opened.



 **(Off):** Press to turn the lamps off, even when a door is open.

### Reading Lamps

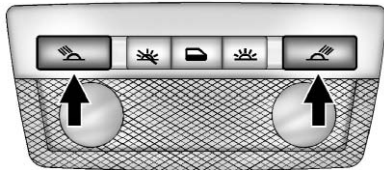
There are front and rear reading lamps.



The front reading lamps are in the overhead console.

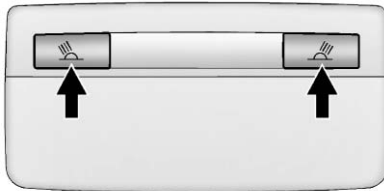

 or  : Press to turn each lamp on or off.



The rear reading lamps are in the headliner.

## Lighting Features

### Entry Lighting

The headlamps, parking lamps, taillamps, back-up lamps, and the interior lights turn on briefly when the Remote Keyless Entry (RKE) transmitter  is pressed. The lights turn off immediately when the POWER  button is pressed or automatically after a brief period.

### Exit Lighting

The headlamps, parking lamps, taillamps, back-up lamps, and license plate lamps come on when the vehicle is turned off and the driver door is opened. Some interior lights also come on when the vehicle is turned off. The exterior lamps and interior lights remain on after the door is closed for a brief period and then turn off.

The exit lighting feature can be changed. See *Vehicle Personalization* on page 5-51.

### Battery Power Protection

The battery saver feature is designed to protect the vehicle's 12-volt battery.

If the exterior lamps or any interior lamp is left on and the vehicle is turned off, the battery rundown protection system automatically turns the lamps off after about 10 minutes.





# **Infotainment System**

## **Introduction**

Infotainment ..... 7-1

## **Introduction**

### **Infotainment**

Your vehicle has an infotainment system. See the infotainment manual.



## Climate Controls

### Climate Control Systems

Automatic Climate Control  
System ..... 8-1

### Air Vents

Air Vents ..... 8-8

## Climate Control Systems

### Automatic Climate Control System

The climate control buttons and the touch screen are used to adjust the heating, cooling, and ventilation.

The vehicle may require the use of an auxiliary heat source under certain cold conditions. This provides additional heating and defrost capability obtained by running the engine, even if the high voltage battery is adequately charged. Under these conditions, the engine will start and use fuel. Make sure there is fuel in the tank.

Do not allow the vehicle to remain in extreme temperatures for long periods without being driven or being plugged in.

## 8-2 Climate Controls

---

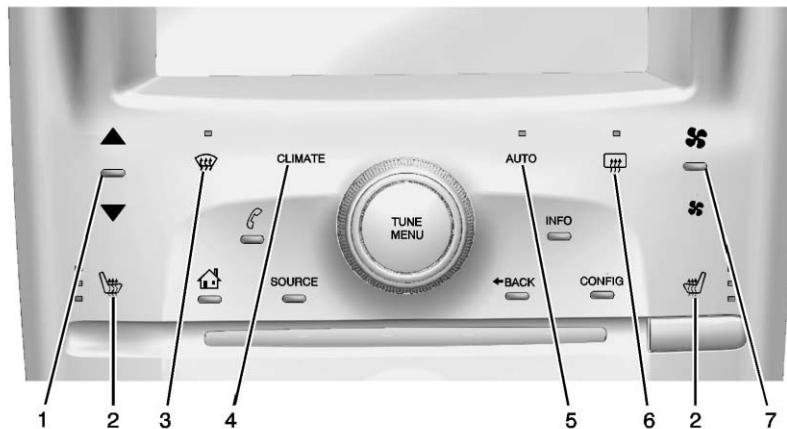

**Climate Control Buttons**

- |                                      |                               |
|--------------------------------------|-------------------------------|
| 1. Temperature Control               | 5. Auto (Automatic Operation) |
| 2. Driver and Passenger Heated Seats | 6. Rear Window Defogger       |
| 3. Defrost                           | 7. Manual Fan Control         |
| 4. Climate                           |                               |

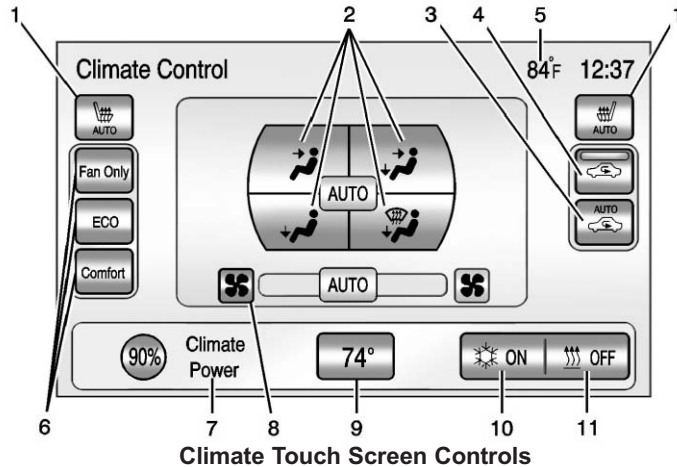

Climate Touch Screen Controls

- |  |  |
|--|--|
| <ol style="list-style-type: none"> <li>1. Driver and Passenger Auto Heated Seats</li> <li>2. Air Delivery Mode Controls</li> <li>3. Auto Recirculation</li> <li>4. Manual Recirculation</li> <li>5. Outside Air Temperature Display</li> </ol> | <ol style="list-style-type: none"> <li>6. Climate Modes: Fan Only, ECO, Comfort</li> <li>7. Climate Power Gauge</li> <li>8. Manual Fan Control</li> <li>9. Temperature Setting Display</li> <li>10. Air Conditioning Indicator</li> <li>11. Heat Status Indicator</li> </ol> |
|--|--|

### Climate Control Touch Screen

The climate mode, fan, air delivery, recirculation, and auto heated seats are controlled by pressing the CLIMATE button on the center stack and viewing information in the center stack display.

### Climate Mode Operation

There are three climate mode settings: Fan Only, ECO, and Comfort. These settings adjust the impact the climate control system has on the vehicle's electric range or fuel economy.

To select a climate mode:

1. Press CLIMATE on the center stack.
2. Press the climate mode button on the touch screen. The climate mode will be lit.

**Fan Only Mode:** The air conditioning and electric heat are turned off. As long as  is not selected, the climate control settings

## 8-4 Climate Controls

may not have a noticeable effect on the vehicle electric range and fuel economy.

When in Fan Only mode, the AUTO indicator light will be off. When AUTO is selected in Fan Only mode, the mode will change to either ECO or Comfort.

When in Fan Only mode, the air conditioning system may turn on automatically if the high voltage battery is being cooled. The climate control system could blow cold air. This is normal. To prevent cold air from blowing into the interior, turn off the fan control and select the vent mode and manual recirculation mode, and close the air vents.

When in Fan Only mode, if Auto Defog is enabled, the air conditioning and electric heat may turn on when high humidity conditions exist. See “Climate and Air Quality” under *Vehicle Personalization* on page 5-51 for

more information on the Auto Defog selection. The air conditioning may also run if  is selected.

**ECO Mode:** The air conditioning and electric heat are controlled to balance comfort with fuel economy. As long as  is not selected, the vehicle electric range or fuel economy will decrease less than in Comfort mode, but will result in moderate comfort.

**Comfort Mode:** The air conditioning and electric heat are controlled to reach the best comfort level based on the temperature setting selected. In this mode, vehicle electric range or fuel economy will decrease depending on the amount of energy required to reach the best comfort levels.



**Climate Power Gauge**

When the climate mode is changed, the Climate Power gauge displays the impact that user setting changes have on energy consumption. The higher the reading, the more energy is being used.



**Air Conditioning/Heat Status Indicators**

The air conditioning/heat status displays when the air conditioning or electric heat is being used.

The air conditioning and electric heat could be on at the same time when dehumidification is required in ECO or Comfort modes.

In Fan Only mode, occasionally the air conditioning and/or heating status will be on if the Auto Defog function is enabled and high humidity is detected. See “Climate and Air Quality” under *Vehicle Personalization on page 5-51*, for details on enabling or disabling the Auto Defog function.

The air conditioning may also run if  is selected, regardless of the climate mode.

### Automatic Operation

The system automatically controls the fan speed, air delivery mode, and recirculation to heat or cool the vehicle to the selected temperature.

When the AUTO indicator light is on, the system is in full automatic operation. If the air delivery mode,

fan speed, or recirculation setting is adjusted, the AUTO indicator turns off and the selected settings display.

For automatic operation:

1. Press AUTO.
2. Set the temperature. An initial setting of 23°C (74°F) is recommended. Allow the system time to stabilize. Adjust the temperature as needed.

### ▲ / ▼ (Temperature Control):

Press to increase or decrease the temperature.

**Auto Defog:** The system will monitor high humidity inside the vehicle. When high humidity is detected, the climate control system may adjust to outside air supply and turn on the air conditioner or the heater. The fan speed may slightly increase to help prevent fogging. When high humidity is no longer detected, the system will return to its prior operation. To turn Auto

Defog off or on, see “Climate and Air Quality” under *Vehicle Personalization on page 5-51*.

### Manual Operation

 **(Fan Control):** Press the fan control buttons or the touch screen fan control, to increase or decrease the fan speed. The fan speed setting displays. Pressing either button cancels automatic fan control and the fan can be controlled manually. Press AUTO to return to automatic operation. Press the fan down button repeatedly to turn off the fan and the climate control system.

If the fan is manually turned off while in ECO or Comfort mode, the display will automatically change to Fan Only mode. When the fan is turned back on either by manually increasing fan speed or pressing the AUTO button, the climate mode will revert back to ECO or Comfort mode.

## 8-6 Climate Controls

**Air Delivery Mode Control:** Press CLIMATE to select the Climate touch screen. Press the air delivery mode touch screen button to change the direction of the airflow. The selected air delivery mode button is lit. Pressing any of the air delivery buttons cancels automatic air delivery control and the direction of the airflow can be controlled manually. Press AUTO to return to automatic operation.



To change the current mode, select one of the following:

 **(Vent):** Air is directed to the instrument panel outlets.

 **(Bi-Level):** Air is divided between the instrument panel outlets and the floor outlets.

 **(Floor):** Air is directed to the floor outlets.

 **(Defog):** Air is directed to the windshield and floor outlets. Clears the windows of fog or moisture.

 **(Defrost):** Air is directed to the windshield. The windshield is cleared of fog or frost more quickly. Selecting  will disable automatic control and the AUTO button indicator will not be lit.

Selecting  again will return to the previous climate settings.

For best results, clear all snow and ice from the windshield before defrosting.



If  is selected in Fan Only or ECO mode, air conditioning or electric heat may turn on and have a noticeable effect on vehicle electric range and fuel economy.



**AUTO**  **(Auto Recirculation):** Press to allow the system to automatically choose the air supply mode for best performance in terms of comfort, efficiency, and defogging. Air is recirculated or outside air is pulled into the vehicle. The touch screen button is lit.

 **(Manual Recirculation):** Press to alternate between recirculating air inside the vehicle or pulling in outside air. When selected, the touch screen button lights up to indicate that air is being recirculated. This helps to quickly cool the air inside the vehicle or prevent outside air and odors from entering.



Pressing this button cancels automatic recirculation. Press AUTO or AUTO  to return to automatic operation; recirculation runs automatically as needed.



Manual recirculation mode is not available when in Defrost or Defog modes.

 /  **(Manual Heated Seats):** If available, the controls are on the center stack. To operate, the vehicle must be on.

Press  or  to heat the driver or passenger seat cushion and seatback. For more information, see *Heated Front Seats on page 3-5*.



 **AUTO**/  **AUTO (Auto Heated Seats)**: If available, the controls are on the touch screen on the center stack.

Press the touch screen  **AUTO** or  **AUTO** button. The button color will change to green when this feature is on. When the vehicle is on, this feature will automatically activate the heated seats at the level required by the vehicle's interior temperature. The active high, medium, low, or off heated seat level will be indicated by the manual heated seat button lights on the center stack. Use the touch screen buttons or the manual heated seat buttons on the center stack to turn auto heated seats off. For more information, see *Heated Front Seats on page 3-5*.

### Rear Window Defogger

 **(Rear Window Defogger)**: Press to turn the rear window defogger on or off.

The rear window defogger turns off automatically after about five minutes. If turned on again, it runs for about five minutes before turning off. The defogger can also be turned off by turning the vehicle off.

For vehicles with heated outside rearview mirrors, they turn on when the rear window defogger button is on and help to clear fog or frost from the surface of the mirror. See *Heated Mirrors on page 2-17*.

**Notice: Do not try to clear frost or other material from the inside of the front windshield and rear window with a razor blade or anything else that is sharp. This may damage the rear window defogger grid and affect the radio's ability to pick up stations clearly. The repairs would not be covered by the vehicle warranty.**

**Remote Start:** For vehicles with this feature, the climate control system may be started by using the Remote Keyless Entry (RKE) transmitter. The climate control system will default to an appropriate heating or cooling mode. See *Remote Start on page 2-8*.

The rear window defogger turns on if it is cold outside.

### Compressor

The vehicle has an electric powered air conditioning compressor. This allows for continuous air conditioning and/or high voltage battery cooling operation, without running the engine.

The compressor operating speed is not tied to the engine speed, so some noise may be heard from the compressor, especially when air conditioning use is high and the engine has turned off. This is normal.

## 8-8 Climate Controls

---

### Sensors

#### Solar Sensor

The solar sensor is on top of the instrument panel, near the windshield, where it monitors solar intensity.

The climate control system uses the sensor information to adjust the temperature, fan speed, recirculation, and air delivery mode for best comfort.

Do not cover the sensor; otherwise the automatic climate control system may not work properly.

#### Humidity Sensor

The humidity sensor is near the base of the inside rearview mirror. The climate control system uses the sensor information to adjust the temperature and recirculation for best comfort.

#### Outside Air Temperature Sensor

The outside air temperature sensor is located behind the front grille of the vehicle. The vehicle uses the sensor information to display outside air temperature. The climate control system uses the information to adjust the climate system operation.

### Air Vents

Use the louvers on the air vents to change the direction of the airflow.

Use the thumbwheels near each vent to open and close off the airflow.

#### Operation Tips

- Keep all outlets open whenever possible for best system performance.
- Keep the path under all seats clear of objects to help circulate the air inside the vehicle more effectively.
- Use of non-GM approved hood deflectors can adversely affect the performance of the system.
- Do not attach any devices to the air vent slats, this restricts airflow and may cause damage to the air vents.

# Driving and Operating

## Driving Information

Driving for Better Energy	
Efficiency .....	9-2
Distracted Driving .....	9-4
Defensive Driving .....	9-4
Drunk Driving .....	9-5
Control of a Vehicle .....	9-5
Braking .....	9-5
Steering .....	9-5
Off-Road Recovery .....	9-6
Loss of Control .....	9-7
Driving on Wet Roads .....	9-7
Highway Hypnosis .....	9-8
Hill and Mountain Roads .....	9-8
Winter Driving .....	9-9
If the Vehicle Is Stuck .....	9-11
Vehicle Load Limits .....	9-11

## Starting and Operating

New Vehicle Break-In .....	9-16
Power Button .....	9-16
Starting and Stopping the Vehicle .....	9-17
Retained Accessory Power (RAP) .....	9-19
Shifting Into Park .....	9-19
Shifting out of Park .....	9-20
Parking over Things That Burn .....	9-20

## Electric Vehicle Operating Modes

System Operation .....	9-21
Electric Mode .....	9-21
Extended Range Mode .....	9-21
Driver Selected Operating Modes .....	9-22
Out of Fuel/Engine Unavailable .....	9-24
Maintenance Modes .....	9-25

## Engine Exhaust

Engine Exhaust .....	9-26
Running the Vehicle While Parked .....	9-27

## Electric Drive Unit

Electric Drive Unit .....	9-27
---------------------------	------

## Brakes

Antilock Brake System (ABS) .....	9-29
Electric Parking Brake .....	9-30
Regenerative Braking .....	9-32

## Ride Control Systems

Traction Control System (TCS) .....	9-32
Electronic Stability Control (ESC) .....	9-34

## Cruise Control

Cruise Control .....	9-35
----------------------	------

## Object Detection Systems

Forward Collision Alert (FCA) System .....	9-38
Ultrasonic Parking Assist .....	9-40
Rear Vision Camera (RVC) .....	9-42
Lane Departure Warning (LDW) .....	9-44

## 9-2 Driving and Operating

---

### Charging

Plug-In Charging .....	9-47
Delayed Charging Override .....	9-49
Charging Status Feedback .....	9-49
Charge Cord .....	9-53
Utility Interruption of Charging .....	9-54
Electrical Requirements for Battery Charging .....	9-54

### Fuel

Fuel .....	9-55
Gasoline Specifications .....	9-56
California Fuel Requirements .....	9-56
Fuels in Foreign Countries ...	9-56
Fuel Additives .....	9-56
Filling the Tank .....	9-57
Filling a Portable Fuel Container .....	9-59

### Towing

General Towing Information .....	9-60
-------------------------------------	------

### Conversions and Add-Ons

Add-On Electrical Equipment .....	9-60
--------------------------------------	------

## Driving Information

### Driving for Better Energy Efficiency

Use the following tips to help maximize energy efficiency and range.

### Driving Style

#### Efficiency Gauge (Instrument Cluster)

The ball indicator should be kept green and in the center of the gauge.

Inefficient acceleration is indicated when the ball turns yellow and travels above the center of the gauge.

Aggressive braking is indicated when the ball turns yellow and travels below the center of the gauge.

#### Acceleration/Braking/Coasting

Avoid unnecessary rapid accelerations and decelerations.

Electric range is maximized at 80 km/h (50 mph) and below. Higher speeds use more energy and can significantly reduce electric range.

Use cruise control when appropriate.

Plan ahead for decelerations and coast whenever possible. For example, do not rush to traffic signals.

Do not shift to N (Neutral) to coast. The vehicle recovers energy while coasting and braking in D (Drive) or L (Low).

### Drive Mode and PRNDL Selection

Use Normal Mode when possible.

Sport Mode provides more responsive acceleration than Normal Mode but can reduce efficiency.

Use Mountain Mode prior to climbing long, steep grades in mountainous areas. Be sure to engage Mountain Mode before starting to climb. Mountain Mode

reduces electric range and power but may be needed to maintain speeds above 96 km/h (60 mph) when climbing grades of 5% or greater.

Use L (Low) in heavy stop-and-go traffic or when traveling downhill. L (Low) requires less brake pedal application and provides a controlled, efficient way to slow the vehicle down.

### **Climate Setting**

Using the heat and air conditioning systems decreases the energy available for electric driving.

Optimal energy efficiency is achieved with the heat, air conditioning, and fan turned off.

Less energy is used at low fan speeds. When using the fan:

- Fan Only is the most energy efficient climate setting as long as  is not selected.

- ECO is for moderate air conditioning and heater operation and is the next most energy efficient setting as long as  is not selected.
- Comfort provides the most comfort but is the least energy efficient.

Use the auto heated seat feature instead of climate settings. Heating the seat uses less energy than heating the vehicle interior.

Use remote start to heat or cool the interior when the vehicle is plugged in to maximize the electric range by utilizing electricity from the electrical outlet.

Engine Assisted Heating operation, if equipped, can be personalized.

In hot weather, avoid parking in direct sunlight or use sunshades inside the vehicle.

Turn off the front and rear window defog/defrost when they are no longer needed.

Avoid driving with the windows open at highway speeds.

See *Vehicle Personalization on page 5-51*.

## **Vehicle Charging/Maintenance**

### **Charging**

Keep the vehicle plugged in, even when fully charged, to keep the battery temperature ready for the next drive. This is important when outside temperatures are extremely hot or cold.

### **Maintenance**

Always keep the tires properly inflated and the vehicle properly aligned.

The weight of excess cargo in the vehicle affects efficiency and range. Avoid carrying more than is needed.

If fuel is not regularly used, consider keeping the fuel tank only one-third full. Excess fuel weight impacts efficiency and range.

Use premium fuel.

## 9-4 Driving and Operating

Avoid unnecessary use of electrical accessories. Power used for functions other than propelling the vehicle will reduce EV range.

Using a rooftop carrier will reduce efficiency due to additional weight and drag.

### Distracted Driving

Distraction comes in many forms and can take your focus from the task of driving. Exercise good judgment and do not let other activities divert your attention away from the road. Many local governments have enacted laws regarding driver distraction. Become familiar with the local laws in your area.

To avoid distracted driving, always keep your eyes on the road, hands on the wheel, and mind on the drive.

- Do not use a phone in demanding driving situations. Use a hands-free method to place or receive necessary phone calls.

- Watch the road. Do not read, take notes, or look up information on phones or other electronic devices.
- Designate a front seat passenger to handle potential distractions.
- Become familiar with vehicle features before driving, such as programming favorite radio stations and adjusting climate control and seat settings. Program all trip information into any navigation device prior to driving.
- Wait until the vehicle is parked to retrieve items that have fallen to the floor.
- Stop or park the vehicle to tend to children.
- Keep pets in an appropriate carrier or restraint.
- Avoid stressful conversations while driving, whether with a passenger or on a cell phone.

### WARNING

Taking your eyes off the road too long or too often could cause a crash resulting in injury or death. Focus your attention on driving.

Refer to the infotainment section for more information on using that system, including pairing and using a cell phone.

If equipped, refer to the navigation manual for information on that system, including pairing and using a cell phone.

### Defensive Driving

Defensive driving means “always expect the unexpected.” The first step in driving defensively is to wear the safety belt. See *Safety Belts on page 3-9*.

- Assume that other road users (pedestrians, bicyclists, and other drivers) are going to be

careless and make mistakes. Anticipate what they might do and be ready.

- Allow enough following distance between you and the driver in front of you.
- Focus on the task of driving.

## Drunk Driving

Death and injury associated with drinking and driving is a global tragedy.

### WARNING

Drinking and then driving is very dangerous. Your reflexes, perceptions, attentiveness, and judgment can be affected by even a small amount of alcohol. You can have a serious — or even fatal — collision if you drive after drinking.

(Continued)

### WARNING (Continued)

Do not drink and drive or ride with a driver who has been drinking. Ride home in a cab; or if you are with a group, designate a driver who will not drink.

## Control of a Vehicle

Braking, steering, and accelerating are important factors in helping to control a vehicle while driving.

### Braking

Braking action involves perception time and reaction time. Deciding to push the brake pedal is perception time. Actually doing it is reaction time.

Average driver reaction time is about three-quarters of a second. In that time, a vehicle moving at 100 km/h (60 mph) travels 20 m (66 ft), which could be a lot of distance in an emergency.

Helpful braking tips to keep in mind include:

- Keep enough distance between you and the vehicle in front of you.
- Avoid needless heavy braking.
- Keep pace with traffic.

If propulsion is disabled while the vehicle is being driven, brake normally but do not pump the brakes. If the brakes are pumped, the pedal could get harder to push down. If propulsion stops, there will still be some power brake assist but it will be used when the brake is applied. Once the power assist is used up, it can take longer to stop and the brake pedal will be harder to push.

### Steering

#### Electric Power Steering

The vehicle has electric power steering. It does not have power steering fluid. Regular maintenance is not required.

## 9-6 Driving and Operating

If power steering assist is lost due to a system malfunction, the vehicle can be steered, but may require increased effort. See your dealer if there is a problem.

If the steering wheel is turned until it reaches the end of its travel and is held against that position for an extended period of time, power steering assist may be reduced.

Normal use of the power steering assist should return when the system cools down.

See specific vehicle steering messages under *Service Vehicle Messages on page 5-49*.

See your dealer if there is a problem.

### Curve Tips

- Take curves at a reasonable speed.
- Reduce speed before entering a curve.
- Maintain a reasonable steady speed through the curve.
- Wait until the vehicle is out of the curve before accelerating gently into the straightaway.

### Steering in Emergencies

- There are some situations when steering around a problem may be more effective than braking.
- Holding both sides of the steering wheel allows you to turn 180 degrees without removing a hand.
- The Antilock Brake System (ABS) allows steering while braking.

### Off-Road Recovery

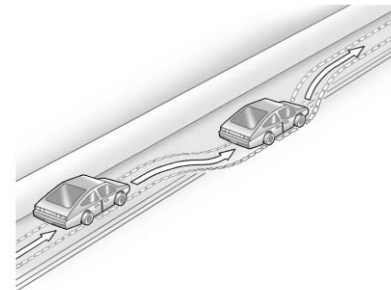

The vehicle's right wheels can drop off the edge of a road onto the shoulder while driving. Follow these tips:

1. Ease off the accelerator and then, if there is nothing in the way, steer the vehicle so that it straddles the edge of the pavement.
2. Turn the steering wheel about one-eighth of a turn, until the right front tire contacts the pavement edge.



- Turn the steering wheel to go straight down the roadway.

## Loss of Control

### Skidding

There are three types of skids that correspond to the vehicle's three control systems:

- Braking Skid — wheels are not rolling.
- Steering or Cornering Skid — too much speed or steering in a curve causes tires to slip and lose cornering force.
- Acceleration Skid — too much throttle causes the driving wheels to spin.

Defensive drivers avoid most skids by taking reasonable care suited to existing conditions, and by not overdriving those conditions. But skids are always possible.

If the vehicle starts to slide, follow these suggestions:

- Ease your foot off the accelerator pedal and steer the way you want the vehicle to go. The vehicle may straighten out. Be ready for a second skid if it occurs.
- Slow down and adjust your driving according to weather conditions. Stopping distance can be longer and vehicle control can be affected when traction is reduced by water, snow, ice, gravel, or other material on the road. Learn to recognize warning clues — such as enough water, ice, or packed snow on the road to make a mirrored surface — and slow down when you have any doubt.
- Try to avoid sudden steering, acceleration, or braking, including reducing vehicle speed by shifting to a lower gear. Any sudden changes could cause the tires to slide.

Remember: Antilock brakes help avoid only the braking skid.

## Driving on Wet Roads

Rain and wet roads can reduce vehicle traction and affect your ability to stop and accelerate. Always drive slower in these types of driving conditions and avoid driving through large puddles and deep-standing or flowing water.

### WARNING

Wet brakes can cause crashes. They might not work as well in a quick stop and could cause pulling to one side. You could lose control of the vehicle.

After driving through a large puddle of water or a car/vehicle wash, lightly apply the brake pedal until the brakes work normally.

(Continued)

### WARNING (Continued)

Flowing or rushing water creates strong forces. Driving through flowing water could cause the vehicle to be carried away. If this happens, you and other vehicle occupants could drown. Do not ignore police warnings and be very cautious about trying to drive through flowing water.

### Hydroplaning

Hydroplaning is dangerous. Water can build up under the vehicle's tires so they actually ride on the water. This can happen if the road is wet enough and you are going fast enough. When the vehicle is hydroplaning, it has little or no contact with the road.

There is no hard and fast rule about hydroplaning. The best advice is to slow down when the road is wet.

### Other Rainy Weather Tips

Besides slowing down, other wet weather driving tips include:

- Allow extra following distance.
- Pass with caution.
- Keep windshield wiping equipment in good shape.
- Keep the windshield washer fluid reservoir filled.
- Have good tires with proper tread depth. See *Tires on page 10-39*.
- Turn off cruise control.

### Highway Hypnosis

Always be alert and pay attention to your surroundings while driving. If you become tired or sleepy, find a safe place to park the vehicle and rest.

Other driving tips include:

- Keep the vehicle well ventilated.
- Keep the interior temperature cool.

- Keep your eyes moving — scan the road ahead and to the sides.
- Check the rearview mirror and vehicle instruments often.

### Hill and Mountain Roads

Driving on steep hills or through mountains is different than driving on flat or rolling terrain. See “Mountain Mode” under *Driver Selected Operating Modes on page 9-22*. Tips for driving in these conditions include:

- Keep the vehicle serviced and in good shape.
- Check all fluid levels and brakes, tires, cooling system, and electric drive unit.
- Keep the vehicle in gear when going down steep or long hills.

**⚠ WARNING**

Coasting downhill in N (Neutral) or with the vehicle turned off is dangerous. The brakes will have to do all the work of slowing down the vehicle and could become too hot. Hot brakes may not be able to slow the vehicle enough to maintain speed and control. You could crash. Always have the vehicle running and in gear (preferably LOW range) when going downhill. This will allow the electric drive unit to assist in slowing and maintaining speed.

- Stay in your own lane. Do not swing wide or cut across the center of the road. Drive at speeds that let you stay in your own lane.
- Top of hills: Be alert — something could be in your lane (stalled car, accident).

- Pay attention to special road signs (falling rocks area, winding roads, long grades, passing or no-passing zones) and take appropriate action.

**Winter Driving****Driving on Snow or Ice**

Drive carefully when there is snow or ice between the tires and the road, creating less traction or grip. Wet ice can occur at about 0°C (32°F) when freezing rain begins to fall, resulting in even less traction. Avoid driving on wet ice or in freezing rain until roads can be treated with salt or sand.

Drive with caution, whatever the condition. Accelerate gently so traction is not lost. Accelerating too quickly causes the wheels to spin and makes the surface under the tires slick, so there is even less traction.

Try not to break the fragile traction. If you accelerate too fast, the drive wheels will spin and polish the surface under the tires even more.

The Antilock Brake System (ABS) improves vehicle stability during hard stops on slippery roads, but apply the brakes sooner than when on dry pavement.

Allow greater following distance on any slippery road and watch for slippery spots. Icy patches can occur on otherwise clear roads in shaded areas. The surface of a curve or an overpass can remain icy when the surrounding roads are clear. Avoid sudden steering maneuvers and braking while on ice.

Turn off cruise control on slippery surfaces.

## 9-10 Driving and Operating

### Blizzard Conditions

Being stuck in snow can be a serious situation. Stay with the vehicle unless there is help nearby. If possible, use the Roadside Assistance Program. To get help and keep everyone in the vehicle safe:

- Turn on the hazard warning flashers.
- Tie a red cloth to an outside mirror.

#### **WARNING**

Snow can trap engine exhaust under the vehicle. This may cause exhaust gases to get inside. Engine exhaust contains carbon monoxide (CO) which cannot be seen or smelled. It can cause unconsciousness and even death.

(Continued)

#### **WARNING (Continued)**

If the vehicle is stuck in the snow:

- Clear away snow from around the base of the vehicle, especially any that is blocking the exhaust pipe.
- Check again from time to time to be sure snow does not collect there.
- Open a window about 5 cm (2 in) on the side of the vehicle that is away from the wind to bring in fresh air.
- Fully open the air outlets on or under the instrument panel.

(Continued)

#### **WARNING (Continued)**

- Adjust the climate control system to a setting that circulates the air inside the vehicle and set the fan speed to the highest setting. See “Climate Control Systems” in the Index.

For more information about carbon monoxide, see *Engine Exhaust* on page 9-26.

To conserve energy, run the vehicle for only short periods as needed to warm the vehicle and then shut the vehicle off and close the window most of the way to save heat. Repeat this until help arrives but only when you feel really uncomfortable from the cold. Moving about to keep warm also helps.

If it takes some time for help to arrive, start the vehicle. The engine may start to charge the 12-volt battery. Turn off unnecessary accessories to conserve energy.

## If the Vehicle Is Stuck

Slowly and cautiously spin the wheels to free the vehicle when stuck in sand, mud, ice, or snow.

The Traction Control System (TCS) must be turned off by pressing the TCS/ESC button. Traction control is not completely off, but will only engage if the maneuver can cause damage to the electric drive unit.

### WARNING

If the vehicle's tires spin at high speed, they can explode, and you or others could be injured. The vehicle can overheat, causing an engine compartment fire or other

(Continued)

### WARNING (Continued)

damage. Spin the wheels as little as possible and avoid going above 56 km/h (35 mph).

## Rocking the Vehicle to Get it Out

Turn the steering wheel left and right to clear the area around the front wheels. Shift back and forth between R (Reverse) and a forward gear, spinning the wheels as little as possible. The Traction Control System prevents the tires from spinning at high speeds. To prevent electric drive unit wear, wait until the wheels stop spinning before shifting gears. Release the accelerator pedal while shifting, and press lightly on the accelerator pedal when the electric drive unit is in gear. Slowly spinning the wheels in the forward and reverse directions

causes a rocking motion that could free the vehicle. If that does not get the vehicle out after a few tries, it might need to be towed out. If the vehicle does need to be towed out, see *Towing the Vehicle on page 10-73*.

## Vehicle Load Limits

It is very important to know how much weight the vehicle can carry. This weight is called the vehicle capacity weight and includes the weight of all occupants, cargo, and all nonfactory-installed options. Two labels on the vehicle show how much weight it was designed to carry, the Tire and Loading Information label and the Certification label.

### WARNING

Do not load the vehicle any heavier than the Gross Vehicle Weight Rating (GVWR), or either the maximum front or rear Gross Axle Weight Rating (GAWR). This can cause systems to break and change the way the vehicle handles. This could cause loss of control and a crash. Overloading can also shorten the life of the vehicle.

### Tire and Loading Information Label

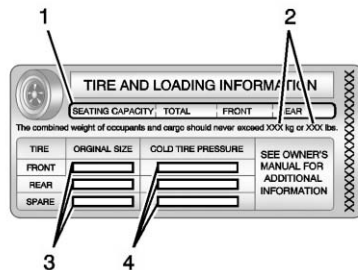

#### Label Example

A vehicle-specific Tire and Loading Information label is attached to the center pillar (B-pillar). With the driver door open, the label is attached below the door lock post. The Tire and Loading Information label shows the number of occupant seating positions (1),

and the maximum vehicle capacity weight (2) in kilograms and pounds.

The Tire and Loading Information label also shows the tire size of the original equipment tires (3) and the recommended cold tire inflation pressures (4). For more information on tires and inflation see *Tires on page 10-39* and *Tire Pressure on page 10-46*.

There is also important loading information on the Certification label. It tells you the Gross Vehicle Weight Rating (GVWR) and the Gross Axle Weight Rating (GAWR) for the front and rear axle; see "Certification Label" later in this section.

### Steps for Determining Correct Load Limit

1. Locate the statement “The combined weight of occupants and cargo should never exceed XXX kg or XXX lbs” on your vehicle's placard.
2. Determine the combined weight of the driver and passengers that will be riding in your vehicle.
3. Subtract the combined weight of the driver and passengers from XXX kg or XXX lbs.
4. The resulting figure equals the available amount of cargo and luggage load capacity. For example, if the “XXX” amount equals 1400 lbs and there will be five 150 lb passengers in your vehicle, the amount of available cargo

and luggage load capacity is 650 lbs (1400 – 750 (5 x 150) = 650 lbs).

5. Determine the combined weight of luggage and cargo being loaded on the vehicle. That weight may not safely exceed the available cargo and luggage load capacity calculated in Step 4.
6. If your vehicle will be towing a trailer, the load from your trailer will be transferred to your vehicle. Consult this manual to determine how this reduces the available cargo and luggage load capacity of your vehicle.

The vehicle is neither designed nor intended to tow a trailer.

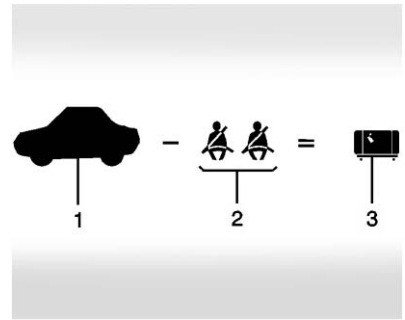

#### Example 1

1. Vehicle Capacity Weight for Example 1 = 453 kg (1,000 lbs).
2. Subtract Occupant Weight @ 68 kg (150 lbs) × 2 = 136 kg (300 lbs).
3. Available Occupant and Cargo Weight = 317 kg (700 lbs).

## 9-14 Driving and Operating

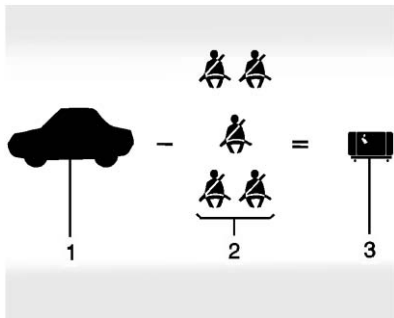

**Example 2**

1. Vehicle Capacity Weight for Example 2 = 453 kg (1,000 lbs).
2. Subtract Occupant Weight @ 68 kg (150 lbs) × 5 = 340 kg (750 lbs).
3. Available Cargo Weight = 113 kg (250 lbs).

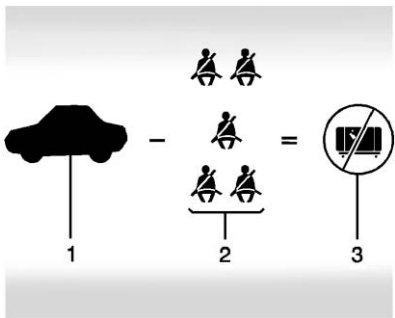

**Example 3**

1. Vehicle Capacity Weight for Example 3 = 453 kg (1,000 lbs).
2. Subtract Occupant Weight @ 91 kg (200 lbs) × 5 = 453 kg (1,000 lbs).
3. Available Cargo Weight = 0 kg (0 lbs).

Refer to the vehicle's Tire and Loading Information label for specific information about the vehicle's capacity weight and

seating positions. The combined weight of the driver, passengers, and cargo should never exceed the vehicle's capacity weight.

### Certification Label

DATE	GVWR	GAWR FRT	GAWR RR
<input type="text"/>	<input type="text"/>	<input type="text"/>	<input type="text"/>
THIS VEHICLE CONFORMS TO ALL APPLICABLE U.S. FEDERAL MOTOR VEHICLE SAFETY, BUMPER, AND THEFT PREVENTION STANDARDS IN EFFECT ON THE DATE OF MANUFACTURE SHOWN ABOVE.			
<input type="text"/>	TYPE: <input type="text"/>		

### Label Example

A vehicle-specific Certification label is found on the center pillar (B-pillar). The label shows the gross weight capacity of the vehicle. This is the Gross Vehicle Weight Rating (GVWR) and includes the weight of the vehicle, all occupants, fuel, and



cargo. Never exceed the GVWR for the vehicle, or the Gross Axle Weight Rating (GAWR) for either the front or rear axle.

Spread out heavy loads equally on both sides of the vehicle. See “Steps for Determining Correct Load Limit” earlier in this section.

 **WARNING**

Do not load the vehicle any heavier than the Gross Vehicle Weight Rating (GVWR), or either the maximum front or rear Gross Axle Weight Rating (GAWR). This can cause systems to break and change the way the vehicle handles. This could cause loss of control and a crash. Overloading can also shorten the life of the vehicle.

If you put things inside the vehicle — like suitcases, tools, packages, or anything else — they will go as fast as the vehicle goes. If you have to stop or turn quickly, or if there is a crash, they will keep going.

 **WARNING**

Things inside the vehicle can strike and injure people in a sudden stop or turn, or in a crash.

- Put things in the cargo area of the vehicle. In the cargo area, put them as far forward as possible. Try to spread the weight evenly.

(Continued)

**WARNING (Continued)**

- Never stack heavier things, like suitcases, inside the vehicle so that some of them are above the tops of the seats.
- Do not leave an unsecured child restraint in the vehicle.
- Secure loose items in the vehicle.
- Do not leave a seat folded down unless needed.

## Starting and Operating



### New Vehicle Break-In

**Notice:** The vehicle does not require a break-in period. Vehicle break-in is performed during manufacturing.

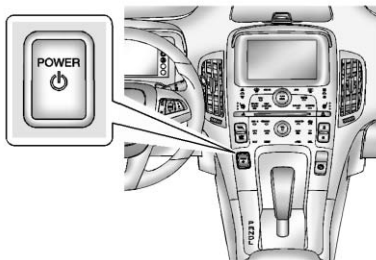
### Power Button



The vehicle has an electronic push-button start. The POWER  button light flashes when the driver

door is open and the vehicle is not on. The flashing light will eventually time out. The POWER  button light is on steady when in ON/RUN power mode. When the vehicle is turned off, the POWER  button light will turn off.

The Remote Keyless Entry (RKE) transmitter must be in the vehicle for the system to operate. If the vehicle will not start, place the RKE transmitter in the transmitter slot. See *Remote Keyless Entry (RKE) System Operation* on page 2-2.

**ON/RUN:** This position is for starting and driving. With the vehicle off, and the brake pedal applied, pressing the POWER  button once will place the vehicle in ON/RUN. When the READY light is on in the instrument cluster, the vehicle is ready to be driven. This could take up to 15 seconds at extremely cold temperatures. See *Vehicle Ready Light* on page 5-25. The engine will only start if needed. If the vehicle did not start, the instrument cluster

will display a screen with inactive fuel and battery gauges. See *Starting and Stopping the Vehicle* on page 9-17.

### Service Only Mode

This power mode is available for service and diagnostics, and to verify the proper operation of the malfunction indicator lamp as may be required for emission inspection purposes. With the vehicle off, and the brake pedal not applied, pressing and holding the POWER  button for more than five seconds will place the vehicle in Service Only Mode. The instruments and audio systems will operate as they do in ON/RUN, but the vehicle will not be able to be driven. The propulsion system will not start in Service Only Mode. Push the button again to turn the vehicle off.

**Notice:** Service Only Mode will discharge the 12-volt battery. Do not use Service Only Mode for an extended period, or the vehicle may not start.

**STOPPING THE VEHICLE/OFF:**

To turn the vehicle off, push the POWER  button with the vehicle in P (Park). Retained Accessory Power (RAP) will remain active until the driver door is opened. See *Retained Accessory Power (RAP) on page 9-19*. When turning off the vehicle, if the vehicle is not in P (Park), the vehicle will go to ACC/ACCESSORY and display the message SHIFT TO PARK in the Driver Information Center (DIC). See *Electric Drive Unit Messages on page 5-45*.

If the vehicle must be shut off in an emergency:

1. Brake using a firm and steady pressure. Do not pump the brakes repeatedly. This may deplete power assist, requiring increased brake pedal force.
2. Shift the vehicle to N (Neutral). This can be done while the vehicle is moving. After shifting

to N (Neutral), firmly apply the brakes and steer the vehicle to a safe location.

3. Come to a complete stop, shift to P (Park), and turn the vehicle off by pushing the POWER  button.
4. Set the parking brake. See *Electric Parking Brake on page 9-30*.

 **WARNING**

Turning off the vehicle while moving may disable the airbags. While driving, only shut the propulsion system off in an emergency.

If the vehicle cannot be pulled over, and must be shut off while driving, press and hold the POWER  button for longer than two seconds, or press twice in five seconds.

**Starting and Stopping the Vehicle****Starting Procedure**

Move the shift lever to P (Park) or N (Neutral). The propulsion system will not start in any other position.

**Notice:** Do not try to shift to P (Park) if the vehicle is moving or the electric drive unit could be damaged. Shift to P (Park) only when the vehicle is stopped.

**Notice:** If you add electrical parts or accessories, you could change the way the vehicle operates. Any resulting damage would not be covered by the vehicle warranty. See *Add-On Electrical Equipment on page 9-60*.

The Remote Keyless Entry (RKE) transmitter must be in the vehicle. Press the brake pedal and push and release the POWER  button.

If the RKE transmitter is not in the vehicle or something is interfering with the transmitter, a message

## 9-18 Driving and Operating

displays in the Driver Information Center (DIC). See *Key and Lock Messages* on page 5-46.

If the vehicle will not start due to a low RKE transmitter battery, the vehicle can still be driven. See “Starting the Vehicle with a Low Transmitter Battery” in *Remote Keyless Entry (RKE) System Operation* on page 2-2.



A Welcome, Ready, and Good-bye audio message will be heard in the vehicle and animated on the instrument cluster when opening the

driver door upon entry, when the vehicle is ready to be driven, and when the vehicle is turned off.

The instrument cluster displays an active fuel or battery gauge, along with an audio startup cue, when the vehicle is ready to be driven. This could take up to 15 seconds at extremely cold temperatures. The engine will only start if needed. If the vehicle did not start, the instrument cluster will display a screen with inactive fuel and battery gauges. See *Starting and Stopping the Vehicle* on page 9-17.

### Restarting Procedure

If the vehicle must be restarted while it is still moving, move the shift lever to N (Neutral) and press the POWER  button twice without pressing the brake pedal. The propulsion system will not restart in any other position.

Computers determine when the engine needs to run. The engine may start, if required, when the propulsion system is on. Some vehicle conditions that force the engine to run:

- There are cold ambient temperatures.
- The hood is open or not completely latched.
- The high voltage battery has a low charge.
- The engine is needed to maintain the high voltage battery temperature.
- The engine needs to run for maintenance.

See *Maintenance Modes* on page 9-25.

A chime will sound if the driver door is opened while the vehicle is in ON/RUN. Always press the POWER  button to turn the vehicle off before exiting.

## Stopping Procedure

For information on how to turn the vehicle off, see *Power Button on page 9-16*.

## Retained Accessory Power (RAP)

The following features will operate for up to 10 minutes or until the driver door is opened:

- Audio System
- Accessory Power Outlets

Power windows will operate for up to 10 minutes or until any door is opened.

## Shifting Into Park

1. Hold the brake pedal down and set the parking brake. See *Electric Parking Brake on page 9-30*.
2. Move the shift lever into P (Park) by pushing the lever all the way toward the front of the vehicle.

3. Turn the vehicle off.

## Leaving the Vehicle with the Propulsion System On

### WARNING

It can be dangerous to leave the vehicle with the propulsion system running. It could overheat and catch fire.

It is dangerous to get out of the vehicle if the shift lever is not fully in P (Park) with the parking brake firmly set. The vehicle can roll.

Do not leave the vehicle when the propulsion system is running. If you have left the propulsion system running, the vehicle can move suddenly. You or others could be injured. To be sure the vehicle will not move, even when you are on fairly level ground, always set the parking brake and

(Continued)

### WARNING (Continued)

move the shift lever to P (Park). See *Shifting Into Park on page 9-19*.

If you have to leave the vehicle with the propulsion system on, be sure the vehicle is in P (Park) and the parking brake is firmly set before you leave it. After you have moved the shift lever into P (Park), hold down the regular brake pedal. See if you can move the shift lever away from P (Park) without first pulling it toward you. If you can, it means that the shift lever was not fully locked into P (Park).

### Torque Lock

Torque lock is when the weight of the vehicle puts too much force on the parking pawl in the electric drive unit. This happens when parking on a hill and shifting the electric drive unit into P (Park) is not done properly and then it is difficult to

## 9-20 Driving and Operating

shift out of P (Park). To prevent torque lock, set the parking brake and then shift into P (Park).

If torque lock does occur, your vehicle may need to be pushed uphill by another vehicle to relieve the parking pawl pressure, so you can shift out of P (Park).

### Shifting out of Park

To shift out of P (Park), the vehicle must be in ON/RUN, the brake pedal must be applied, and the charge cord must be unplugged.

The vehicle has an electronic shift lock release system. The shift lock release is designed to:

- Prevent the vehicle from turning off unless the shift lever is in P (Park).
- Prevent moving the shift lever out of P (Park), unless the vehicle is in ON/RUN, the brake pedal is applied, and the charge cord is unplugged.

Parking the vehicle in extreme cold for several days without the charge cord connected may cause the electric drive unit to be locked in P (Park) until the propulsion system has warmed sufficiently.

The shift lock is always functional except in the case of an uncharged or low charged 12-volt battery (less than 9 volts).

If the vehicle has an uncharged 12-volt battery or a 12-volt battery with low voltage, try charging or jump starting the 12-volt battery. See *Battery on page 10-22* or *Jump Starting on page 10-68*.

If the console shift lever cannot be moved out of P (Park):

1. Apply and maintain the regular brakes.
2. Turn the vehicle on using the POWER  button. See *Power Button on page 9-16*.
3. Let up on the shift lever and make sure the shift lever is pushed all the way into P (Park).

4. Press the shift lever button.
5. Move the shift lever into the desired gear.

If you still cannot move the shift lever from P (Park), see your dealer or a professional towing service.

### Parking over Things That Burn



Things that can burn could touch hot exhaust parts under the vehicle and ignite. Do not park over papers, leaves, dry grass, or other things that can burn.

## Electric Vehicle Operating Modes

### System Operation

This vehicle is an Extended Range Electric Vehicle (EREV). It uses an electric propulsion system to drive the vehicle at all times. Electricity is the vehicle's primary source of energy, while gasoline is the secondary source.

The vehicle has two modes of operation: Electric and Extended Range. In both modes, the vehicle is propelled by its electric drive unit. It converts electrical energy into mechanical energy to drive the wheels. The vehicle's performance remains the same in either mode. See *Driving for Better Energy Efficiency on page 9-2*.

### Electric Mode

In Electric Mode, the vehicle does not use fuel or produce tailpipe emissions. During this primary

mode, the vehicle is powered by electrical energy stored in the high voltage battery. The vehicle can operate in this mode until the battery has reached a low charge.

There are some conditions when the battery charge is high enough to provide Electric Mode operation, but the engine still runs. They are:

- Cold ambient temperatures.
- Hot or cold high voltage battery temperatures.
- The hood being open or not completely closed and latched.
- Certain high voltage battery fault conditions.
- Engine Maintenance Mode or Fuel Maintenance Mode being run.

### Extended Range Mode

When the vehicle reaches the end of its electric range, it switches to Extended Range Mode (ERM). In this secondary mode, electricity is

produced by the fuel-powered engine. This secondary source of electric power extends the vehicle range. Operation will continue in ERM until the vehicle can be plugged in to recharge the high voltage battery and restore Electric Mode.

The high voltage battery will continue to provide some power and work together with the engine to provide peak performance when it is required, such as driving up a steep incline or for high acceleration maneuvers. The battery will not be charged nor will electric vehicle range be restored by the engine.

In either Electric Mode or Extended Range Mode, when the hood is open, the engine will run without turning off if the vehicle is on. The high voltage battery is neither charged nor discharged when this occurs.

In either Electric Mode or Extended Range Mode, if there is a high voltage battery fault, the engine may

## 9-22 Driving and Operating

run without turning off to generate needed electricity. The malfunction indicator lamp will turn on. See *Malfunction Indicator Lamp on page 5-17*.

### Driver Selected Operating Modes

While driving in Electric or Extended Range Mode, additional operating modes can be selected.

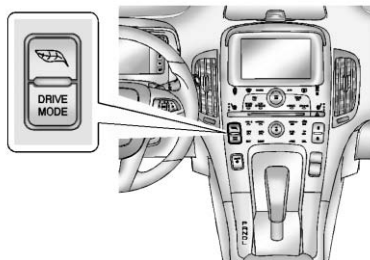

Press the DRIVE MODE button to display selectable drive modes in the Driver Information Center (DIC). Continue pressing to scroll through the modes.

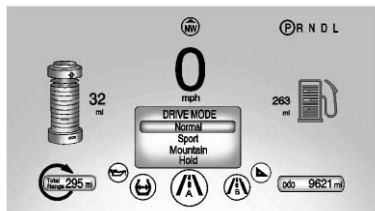

Highlight either the Mountain, Sport, or Hold Mode, then release the DRIVE MODE button. After three seconds, the new drive mode will become active.

Pressing the DRIVE MODE button again will return to Normal Mode, and become active after three seconds.

At next start, the vehicle will default to Normal Mode. Drive modes can then be selected again as desired.

During some conditions, certain drive modes may be unavailable. The unavailable mode is grayed out in the DIC menu and cannot be selected.

If in Sport, Mountain, or Hold Mode, the mode may become unavailable and the vehicle will return to Normal Mode. The indicator light goes off and a DIC message displays. See *Propulsion Power Messages on page 5-48*.

### Sport Mode

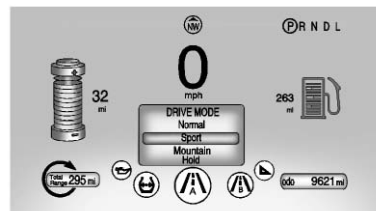



Sport Mode provides more responsive acceleration than Normal Mode, but can reduce efficiency. Use Normal Mode whenever possible.

Press the DRIVE MODE button to select Sport Mode.

Press the DRIVE MODE button again to return to Normal Mode and it becomes active after three seconds.

The Sport light comes on when Sport Mode is selected. See *Sport Mode Light* on page 5-21.

Each time the vehicle is started, it will return to Normal Mode.

## Mountain Mode

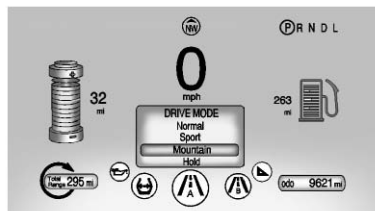

Mountain Mode should be selected at the beginning of a trip before climbing steep, uphill grades and when expecting to drive in very hilly or mountainous terrain. This mode maintains a reserve electrical charge of the high voltage battery to provide better grade climbing performance. While driving in Mountain Mode, the vehicle will have less responsive acceleration.

Mountain Mode will not change normal vehicle braking performance for steep downhill grades. See *Hill and Mountain Roads* on page 9-8 and *Electric Drive Unit* on page 9-27.

Press the DRIVE MODE button to select Mountain Mode. If steep hill driving is expected, it is recommended to select Mountain Mode at least 20 minutes before driving on steep grades. This will allow the vehicle time to build a sufficient battery charge reserve.

If Mountain Mode is not selected for these conditions, propulsion power may be reduced and the engine speed may increase. See *Propulsion Power Messages* on page 5-48.

The engine may run when Mountain Mode is selected, depending on high voltage battery charge, to build reserve battery charge for uphill climbs. If Mountain Mode is entered with a sufficient battery charge reserve, the battery charge reserve will appear grayed out and any battery charge reserve still unused upon exiting Mountain Mode will return to normal appearance.

## 9-24 Driving and Operating

Press the Drive Mode button again to return to Normal Mode and it becomes active after three seconds.

The Mountain light comes on when Mountain Mode is selected. See *Mountain Mode Light on page 5-21*.

Each time the vehicle is started, it will return to Normal Mode to maintain a smaller battery charge reserve for normal driving.

### Hold Mode

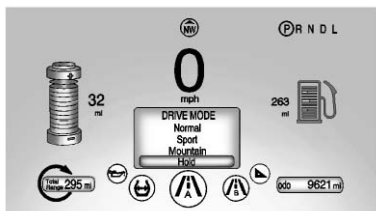

Hold Mode is only available when the vehicle is in Electric Mode. This mode places the remaining battery charge into a reserve for the driver to use as desired. Selecting this

mode transitions the vehicle to Extended Range Mode to maintain the battery charge reserve.

Upon exiting Hold Mode, the reserved battery charge becomes available again and the vehicle returns to Electric Mode. If the transition is from Hold Mode directly to Mountain Mode, the electric range displayed adjusts for the Mountain Mode charge reserve.

Hold Mode will not change normal vehicle acceleration or braking performance.

Press the DRIVE MODE button to select Hold Mode.

Press the DRIVE MODE button again to return to Normal Mode and it becomes active after three seconds.

The Hold light comes on when Hold Mode is selected. See *Hold Mode Light on page 5-22*.

Each time the vehicle is started, it will return to Normal Mode.

### Out of Fuel/Engine Unavailable

If the vehicle runs out of fuel, or the engine will not start due to a malfunction, the vehicle can continue to be driven in Electric Mode. The vehicle will have less responsive acceleration. DIC messages indicate reduced propulsion power, that the engine is not available, and the need for fuel or service.

Once the vehicle is refueled, or the malfunction is corrected, the engine will start the next time the vehicle is turned on to perform a self test, and DIC messages will not be displayed. Once the engine starts successfully, normal operation will continue in either Electric or Extended Range Mode. The engine will stop running after the self test is completed, and based on the current mode of operation. See *Fuel System Messages on page 5-46* and *Service Vehicle Messages on page 5-49*.

## Maintenance Modes

### Engine Maintenance Mode (EMM)

Engine Maintenance Mode (EMM) runs the engine to keep it in good working condition after approximately six weeks of no or very limited engine operation. EMM will force the engine to run, even if there is a charge to power the vehicle. When EMM is needed, the EMM Request screen appears on the center stack display at vehicle start.

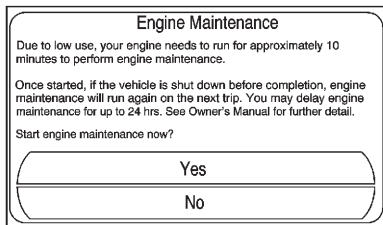

If Yes is selected, EMM will begin. The engine will run for a set amount of time without turning off. During

EMM, a DIC message displays to show the EMM percentage complete.

If No is selected, the EMM Request screen will appear when the vehicle is next started. The EMM request can be delayed for only one day.

If the EMM request was delayed for one day, EMM will automatically start the engine at the next vehicle start. An EMM Notification screen will appear in the center stack display.

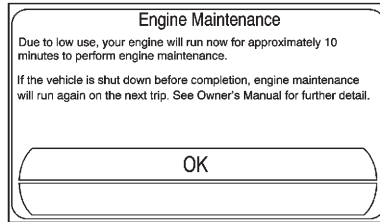

If the vehicle shuts off during EMM, it will restart the next time the vehicle is driven. A message displays to indicate that EMM is active.

If EMM is required and the fuel level is low, EMM may eventually empty the fuel tank if fuel is not added. This will result in reduced, or no power. An adequate fuel level must be maintained in the vehicle to keep it operational. See *Propulsion Power Messages on page 5-48*.

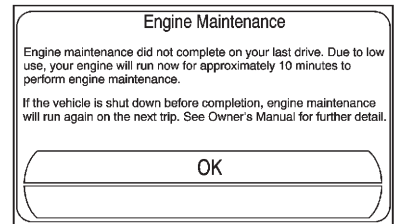

### Fuel Maintenance Mode (FMM)

Fuel Maintenance Mode (FMM) tracks average fuel age. Old fuel can cause engine problems. If low engine usage causes average fuel age to exceed approximately one year, FMM will run the engine to use up the old fuel. The engine will run until enough fresh fuel is added to bring the average fuel age into an

## 9-26 Driving and Operating

acceptable range. Allowing more old fuel to be used up by FMM and adding a larger amount of fresh fuel will maximize the length of time before another fuel maintenance mode is needed. During FMM the engine may turn on and off.

When FMM is needed, the FMM Request screen appears on the center stack display at vehicle start.

**Fuel Maintenance**

Your fuel usage has been so low that the fuel is becoming stale. The engine must run to burn this fuel. Add fresh fuel when fuel level is half a tank or less.

You may delay fuel maintenance for up to 24 hrs. See Owner's Manual for further detail.

Start fuel maintenance now?

Yes

No

If Yes is selected, FMM will begin. FMM will automatically continue at each vehicle start until fresh fuel is added.

If No is selected, the FMM Request screen will appear when the vehicle is next started. The FMM request can be delayed for only one day.

If the FMM request was delayed for one day, FMM will start at the next vehicle start and display the FMM Notification screen on the center stack display.

If FMM is required and the fuel level is low, FMM may eventually empty the fuel tank if fuel is not added. This will result in reduced, or no power. An adequate fuel level must be maintained in the vehicle to keep it operational. See *Propulsion Power Messages on page 5-48*.

**Fuel Maintenance**

Your fuel usage has been so low that the fuel is becoming stale. The engine will run now to burn this fuel. Add fresh fuel when fuel level is half a tank or less. See Owner's Manual for further detail.

OK

## Engine Exhaust

### **WARNING**

Engine exhaust contains carbon monoxide (CO) which cannot be seen or smelled. Exposure to CO can cause unconsciousness and even death.

Exhaust may enter the vehicle if:

- The engine is running in Extended Range Mode in areas with poor ventilation (parking garages, tunnels, or deep snow that may block underbody airflow or tail pipes).
- The exhaust smells or sounds strange or different.
- The exhaust system leaks due to corrosion or damage.
- The vehicle exhaust system has been modified, damaged, or improperly repaired.

(Continued)

**WARNING (Continued)**

- There are holes or openings in the vehicle body from damage or aftermarket modifications that are not completely sealed.

If unusual fumes are detected or if it is suspected that exhaust is coming into the vehicle:

- Drive it only with the windows completely down.
- Have the vehicle repaired immediately.

Never park with the engine running in Extended Range Mode in an enclosed area such as a garage or a building that has no fresh air ventilation.

**Running the Vehicle While Parked**

It is better not to park with the propulsion system running.

If the vehicle is left with the propulsion system running, follow the proper steps to be sure the vehicle will not move. See *Shifting Into Park* on page 9-19 and *Engine Exhaust* on page 9-26.

**Electric Drive Unit**

The vehicle uses an electric drive unit.

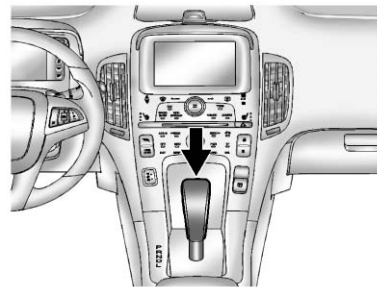

**P (Park):** This position locks the front wheels. It is the best position to use when starting the propulsion system because the vehicle cannot move easily.

### WARNING

It is dangerous to get out of the vehicle if the shift lever is not fully in P (Park) with the parking brake firmly set. The vehicle can roll.

Do not leave the vehicle when the propulsion system is running. If you have left the propulsion system running, the vehicle can move suddenly. You or others could be injured. To be sure the vehicle will not move, even when you are on fairly level ground, always set the parking brake and move the shift lever to P (Park). See *Shifting Into Park on page 9-19*.

Make sure the shift lever is fully in P (Park) before starting the propulsion system. The vehicle has an electric drive unit shift lock control system. The regular brake must be fully applied first and then the shift lever button pressed before

shifting from P (Park) when the vehicle is in ON/RUN. If you cannot shift out of P (Park), ease pressure on the shift lever, then push the shift lever all the way into P (Park) as you maintain brake application. Then press the shift lever button and move the shift lever into another gear. See *Shifting out of Park on page 9-20*.

**R (Reverse):** Use this gear to back up.

**Notice:** Shifting to R (Reverse) while the vehicle is moving forward could damage the electric drive unit. The repairs would not be covered by the vehicle warranty. Shift to R (Reverse) only after the vehicle is stopped.

To rock the vehicle back and forth to get out of snow, ice, or sand without damaging the electric drive unit, see *If the Vehicle Is Stuck on page 9-11*.

**N (Neutral):** In this position, the propulsion system does not connect with the wheels.

**D (Drive):** This position is for normal driving. It provides the best fuel economy. If more power is needed for passing, and the vehicle is:

- Going less than 56 km/h (35 mph), push the accelerator pedal about halfway down.
- Going about 56 km/h (35 mph) or more, push the accelerator all the way down.

**Notice:** If the vehicle seems to accelerate slowly or not respond when you go faster, and you continue to drive the vehicle that way, you could damage the electric drive unit. Have the vehicle serviced right away.

**L (Low):** This position reduces vehicle speed without using the brakes. You can use L (Low) on hills. It can help control vehicle speed going down steep mountain roads along with using the brakes off and on. You can use L (Low) on very steep hills, in deep snow, or in mud.

**Notice:** Spinning the tires or holding the vehicle in one place on a hill using only the accelerator pedal may damage the electric drive unit. The repair will not be covered by the vehicle warranty. If you are stuck, do not spin the tires. When stopping on a hill, use the brakes to hold the vehicle in place.

## Brakes

### Antilock Brake System (ABS)

This vehicle has the Antilock Brake System (ABS), an advanced electronic braking system that helps prevent a braking skid.

When propulsion is active and the vehicle begins to drive away, ABS checks itself. A momentary motor or clicking noise might be heard while this test is going on, and it might even be noticed that the brake pedal moves a little. This is normal.



If there is a problem with ABS, this warning light stays on. See *Antilock Brake System (ABS) Warning Light* on page 5-21.

If driving safely on a wet road and it becomes necessary to slam on the brakes and continue braking to avoid a sudden obstacle, a computer senses that the wheels are slowing down. If one of the wheels is about to stop rolling, the computer will separately work the brakes at each wheel.

ABS can change the brake pressure to each wheel, as required, faster than any driver could. This can help the driver steer around the obstacle while braking hard.

As the brakes are applied, the computer keeps receiving updates on wheel speed and controls braking pressure accordingly.

Remember: ABS does not change the time needed to get a foot up to the brake pedal or always decrease stopping distance. If you get too close to the vehicle in front of you, there will not be enough time to apply the brakes if that vehicle

## 9-30 Driving and Operating

suddenly slows or stops. Always leave enough room up ahead to stop, even with ABS.

### Using ABS

Do not pump the brakes. Just hold the brake pedal down firmly and let ABS work. You might hear the ABS pump or motor operating and feel the brake pedal pulsate, but this is normal.

### Braking in Emergencies

ABS allows the driver to steer and brake at the same time. In many emergencies, steering can help more than even the very best braking.

## Electric Parking Brake

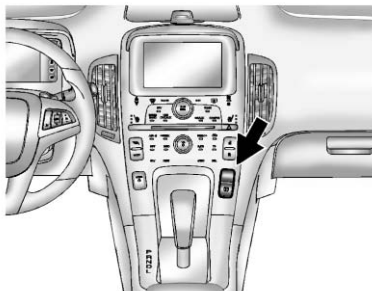

The vehicle has an Electric Parking Brake (EPB). The (P) switch is on the center stack. The EPB can always be activated, even if the vehicle is off. To prevent draining the 12-volt battery, avoid repeated cycles of the EPB system when the vehicle is off.

In case of insufficient electrical power, the EPB cannot be applied or released.

Before leaving the vehicle, check the Electric Parking Brake Light to ensure the parking brake is applied.

### EPB Apply

The EPB can be applied anytime the vehicle is stopped. The EPB is applied by momentarily lifting up on the (P) switch. Once fully applied, the Electric Parking Brake Light will be on. While the brake is being applied, the Electric Parking Brake Light will flash until full apply is reached. If the light does not come on, or remains flashing, have the vehicle serviced. Do not drive the vehicle if the Electric Parking Brake Light is flashing. See your dealer.

If the EPB is applied while the vehicle is in motion, a chime will sound, and the DIC message RELEASE PARKING BRAKE will be displayed. The vehicle will decelerate as long as the switch is held in the up position. Releasing the (P) switch during the deceleration will release the parking



brake. If the (P) switch is held in the up position until the vehicle comes to a stop, the EPB will remain applied.

If the Electric Parking Brake Light flashes continuously, the EPB is only partially applied or released, or there is a problem with the EPB. The DIC message SERVICE PARKING BRAKE will be displayed. If this light flashes continuously, release the EPB, and attempt to apply it again. If this light continues to flash, do not drive the vehicle. See your dealer.

If the Service Electric Parking Brake Light is on, the EPB has detected a system problem and is operating with reduced functionality. To apply the EPB when this light is on, lift up on the (P) switch and hold it in the up position. Full application of the parking brake by the EPB system may take a longer period of time than normal when this light is on. Continue to hold the (P) switch until the Electric Parking Brake Light

remains on. If the Service Electric Parking Brake Light is on, see your dealer.

If the EPB fails to apply, the rear wheels should be blocked to prevent vehicle movement.

For maximum EPB force when parking on a hill, pull the EPB switch twice.

### EPB Release

To release the EPB, place the vehicle in ON/RUN, apply and hold the brake pedal, and push down momentarily on the (P) switch. If attempting to release the EPB without the brake pedal applied, a chime will sound, and the DIC message STEP ON BRAKE TO RELEASE PARK BRAKE will be displayed. The EPB is released when the Electric Parking Brake Light is off.

If the Service Electric Parking Brake Light is on, the EPB has detected a system problem, and is operating with reduced functionality. To

release the EPB when this light is on, push down on the (P) switch and hold it in the down position. EPB release may take a longer period of time than normal when this light is on. Continue to hold the (P) switch until the Electric Parking Brake Light is off. If the light is on, see your dealer.

**Notice: Driving with the parking brake on can overheat the brake system and cause premature wear or damage to brake system parts. Make sure that the parking brake is fully released and the Electric Parking Brake Light is off before driving.**

### Automatic EPB Release

The EPB will automatically release if the vehicle is running, placed into gear, and an attempt is made to drive away. Avoid rapid acceleration when the EPB is applied, to preserve parking brake lining life.

See *Electric Parking Brake Light* on page 5-20, *Service Electric Parking Brake Light* on page 5-20, and *Brake System Messages* on page 5-44.

### Regenerative Braking

Regenerative braking takes some of the energy from the moving vehicle and turns it back into electrical energy. This energy is then stored back into the high voltage battery system, contributing to increased energy efficiency.

The hydraulic disc brakes work with the regenerative braking to ensure effective braking, such as when a high braking demand is requested.

The braking system is computer controlled and blends the regenerative braking with the conventional hydraulic disc brakes to meet any requirements for deceleration. The controller interprets the braking request and uses regenerative braking, conventional hydraulic braking, or a

combination of both as necessary. Because the controller applies the hydraulic brakes through its high pressure accumulator, you may occasionally hear the motor-driven pump when it recharges the system. This is normal.

See *Warning Lights, Gauges, and Indicators* on page 5-8 and *Driver Information Center (DIC)* on page 5-41. In the event of a controller problem, the brake pedal may be harder to push and the stopping distance may be longer.

## Ride Control Systems

### Traction Control System (TCS)

The vehicle has a Traction Control System (TCS) that limits wheel spin. The system operates if it senses that one or both of the drive wheels are slipping or beginning to lose traction. When this happens, the system brakes the spinning wheel(s) and/or reduces power to limit wheel spin.

The system may be heard or felt while it is working, but this is normal.

To assist with directional control of the vehicle, TCS automatically comes on whenever the vehicle is turned on. To limit wheel spin, especially in slippery road conditions, the system should always be left on. But, TCS can be turned off if needed.

When the vehicle is started and begins to move, the system performs several diagnostic checks to ensure there are no problems.

The system may be heard or felt while it is working. This is normal and does not mean there is a problem with the vehicle. The system should initialize before the vehicle reaches 32 km/h (20 mph). In some cases, it may take approximately 3.2 km (2 mi) of driving before the system initializes.

The TCS may activate on dry or rough roads or under conditions such as heavy acceleration while turning or abrupt changes in output from the electric drive unit. When this happens, a reduction in acceleration may be noticed, or a noise or vibration may be heard. This is normal.

 flashes to indicate that TCS is active. See *Traction Control System (TCS)/StabiliTrak® Light* on page 5-23.

If there is a problem detected with TCS, SERVICE TRACTION CONTROL is displayed on the Driver Information Center (DIC). See *Ride Control System Messages* on page 5-48. When this message is displayed and  comes on and stays on, the vehicle is safe to drive but the system is not operational. Driving should be adjusted accordingly.

If  comes on and stays on, reset the system:

1. Stop the vehicle.
2. Turn the engine off and wait 15 seconds.
3. Start the engine.

If  still comes on and stays on, the vehicle needs service.

**Notice:** Do not repeatedly brake or accelerate heavily when TCS is off. The vehicle's driveline could be damaged.

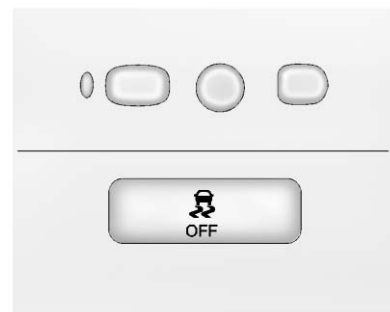

TCS can be turned off by pressing and releasing the TCS/ESC button on the overhead console. When TCS is turned off,  comes on, and the appropriate DIC message also displays. See *Ride Control System Messages* on page 5-48. With TCS turned off, the system does not limit wheel spin. Driving should be adjusted accordingly. See *Traction Off Light* on page 5-22.

Press and release the TCS/ESC button again to turn the system back on.

## 9-34 Driving and Operating

---

It may be necessary to turn the system off if the vehicle gets stuck in sand, mud, or snow and rocking the vehicle is required. See *If the Vehicle Is Stuck* on page 9-11 for more information. See also *Winter Driving* on page 9-9 for information on using TCS when driving in snowy or icy conditions.

Adding non-GM accessories can affect the vehicle performance. See *Accessories and Modifications* on page 10-2.

### Electronic Stability Control (ESC)

The vehicle has an Electronic Stability Control system called StabiliTrak. It is an advanced computer-controlled system that assists with directional control of the vehicle in difficult driving conditions.

StabiliTrak comes on automatically whenever the vehicle is turned on. To assist with directional control of the vehicle, the system should always be left on.

The system may be heard or felt while it is working, but this is normal.

StabiliTrak activates when the computer senses a difference between the intended path and the direction the vehicle is actually traveling. StabiliTrak selectively applies braking pressure to the vehicle brakes to help steer the vehicle in the intended direction.

When the vehicle is started and begins to move, the system performs several diagnostic checks to ensure there are no problems. The system may be heard or felt while it is working. This is normal and does not mean there is a problem with the vehicle. The system should initialize before the vehicle reaches 32 km/h (20 mph). In some cases, it may take approximately 3.2 km (2 mi) of driving before the system initializes.

When StabiliTrak activates,  flashes on the instrument cluster. This also occurs when traction

control is activated. This is normal. Continue to steer the vehicle in the intended direction. A noise may be heard or vibration may be felt in the brake pedal. This is normal. Continue to steer the vehicle in the intended direction. See *Traction Control System (TCS)/StabiliTrak® Light* on page 5-23.



If a problem is detected with StabiliTrak, SERVICE STABILITRAK is displayed on the Driver Information Center (DIC). See *Ride Control System Messages* on page 5-48. When this message is displayed and  comes on and stays on, the vehicle is safe to drive but the system is not operational. Driving should be adjusted accordingly.

If  comes on and stays on, reset the system:

1. Stop the vehicle.
2. Turn the engine off and wait 15 seconds.
3. Start the engine.

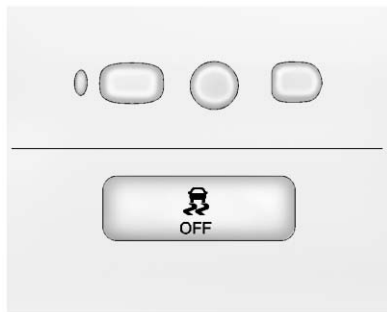
If  still comes on and stays on, the vehicle needs service.



- To turn off both StabiliTrak and TCS, press and hold the TCS/ESC button on the overhead console, until  and  illuminate and the appropriate DIC message is displayed. See *Ride Control System Messages on page 5-48*.

When StabiliTrak is turned off, the system will not assist with directional control of the vehicle or limit wheel spin. Driving should be adjusted accordingly. See *StabiliTrak<sup>®</sup> OFF Light on page 5-23*.

- Press and release the TCS/ESC button again to turn the system back on.

If cruise control is being used when StabiliTrak activates, cruise control will automatically disengage. Press the cruise control button to reengage when road conditions allow. See *Cruise Control on page 9-35*.

## Cruise Control

The cruise control lets the vehicle maintain a speed of about 40 km/h (25 mph) or more without keeping your foot on the accelerator. Cruise control does not work at speeds below 40 km/h (25 mph).

With the Traction Control System (TCS) or Electronic Stability Control (ESC), the system may begin to limit wheel spin while you are using cruise control. If this happens, the cruise control will automatically disengage. See *Traction Control System (TCS) on page 9-32* or *Electronic Stability Control (ESC) on page 9-34*. If a collision alert occurs when cruise control is activated, cruise control is disengaged. See *Forward Collision Alert (FCA) System on page 9-38*. When road conditions allow you to safely use it again, the cruise control can be turned back on.

### **WARNING**

Cruise control can be dangerous where you cannot drive safely at a steady speed. So, do not use the cruise control on winding roads or in heavy traffic.

Cruise control can be dangerous on slippery roads. On such roads, fast changes in tire traction can cause excessive wheel slip, and you could lose control. Do not use cruise control on slippery roads.



 **(On/Off):** Press to turn the cruise control system on and off. An indicator light will turn on or off in the instrument cluster.

 **(Cancel):** Press to disengage cruise control without erasing the set speed from memory.

**RES/+ (Resume/Accel):** Move the thumbwheel up to resume to a previously set speed or to accelerate.

**SET/- (Set/Coast):** Move the thumbwheel down to set a speed and activate cruise control or to make the vehicle decelerate.

### **Setting Cruise Control**

If the cruise button is on when not in use, it could get bumped and go into cruise when not desired. Keep the cruise control button off when cruise is not being used.

To set a speed:

1. Press  to turn cruise control on.
2. Get up to the speed desired.
3. Move the thumbwheel down toward SET/- and release it. The desired set speed briefly appears in the instrument cluster.
4. Take your foot off the accelerator pedal.

When the brakes are applied, the cruise control shuts off.

### Resuming a Set Speed

If the cruise control is set at a desired speed and then the brakes are applied, the cruise control is disengaged without erasing the set speed from memory. Once the vehicle speed is about 40 km/h (25 mph) or greater, move the thumbwheel up toward RES/+ briefly and then release it. The vehicle returns to the previously set speed and stays there.

### Increasing Speed While Using Cruise Control

If the cruise control system is already activated:

- Move the thumbwheel up toward RES/+ and hold it until the vehicle accelerates to the desired speed, then release it.
- To increase the speed in small amounts, move the thumbwheel up toward RES/+ briefly and then release it. Each time this is done, the vehicle goes about 1 km/h (1 mph) faster.

### Reducing Speed While Using Cruise Control

If the cruise control system is already activated:

- Move the thumbwheel toward SET/- and hold until the desired lower speed is reached, then release it.
- To slow down in very small amounts, move the thumbwheel toward SET/- briefly. Each time this is done, the vehicle goes about 1 km/h (1 mph) slower.

### Passing Another Vehicle While Using Cruise Control

Use the accelerator pedal to increase vehicle speed. When you take your foot off the pedal, the vehicle will slow down to the previously set cruise control speed.



### Using Cruise Control on Hills

How well the cruise control works on hills depends upon the vehicle speed, load, and the steepness of the hills. When going up steep hills,

you might have to step on the accelerator pedal to maintain the vehicle speed. When going downhill, you might have to brake or shift to a lower gear to maintain the vehicle speed. When the brakes are applied the cruise control is disengaged.

### Ending Cruise Control

There are three ways to end cruise control:

- Step lightly on the brake pedal; when cruise control disengages, the indicator light will not be lit.
- Press .
- Press  to turn the cruise control system off completely. The cruise control cannot be resumed.

### Erasing Speed Memory

The cruise control set speed is erased from memory if  is pressed or if the vehicle is turned off.

## Object Detection Systems

### Forward Collision Alert (FCA) System

The Forward Collision Alert (FCA) system may help to avoid or reduce the harm caused by front-end crashes. FCA provides a flashing visual alert and beeps when approaching a vehicle directly ahead too quickly. FCA also provides a visual alert if following another vehicle much too closely. The FCA symbol is in the instrument cluster.

The forward-looking FCA camera sensor is on the windshield ahead of the rearview mirror. FCA detects vehicles within a distance of approximately 60 m (197 ft) and operates at speeds above 40 km/h (25 mph).

#### WARNING

FCA is a warning system and does not apply the brakes. When approaching a slower-moving or stopped vehicle ahead too rapidly, or when following a vehicle too closely, FCA may not provide a warning with enough time to help avoid a crash. FCA does not warn of pedestrians, animals, signs, guardrails, bridges, construction barrels, or other objects. Be ready to take action and apply the brakes. For more information, see *Defensive Driving on page 9-4*.

#### Detecting the Vehicle Ahead



The green vehicle ahead indicator will appear when a vehicle is detected ahead. Whenever this indicator does not appear, FCA will not respond. The indicator may disappear on curves, highway exit ramps, or hills, or due to poor visibility. The FCA system will not detect another vehicle ahead until it is completely in the driving lane.

#### WARNING

FCA does not provide a warning to help avoid a crash, unless it detects a vehicle. FCA may not detect a vehicle ahead if the FCA sensor is blocked by dirt, snow, or ice, or if the windshield is damaged. It may also not detect a vehicle on winding or hilly roads, or in conditions that can limit visibility such as fog, rain, or snow, or if the headlamps or windshield are not cleaned or in

(Continued)



**WARNING (Continued)**

proper condition. Keep the windshield, headlamps, and FCA sensors clean and in good repair.

**Tailgating Alert**

The vehicle ahead indicator will change to amber if following the vehicle ahead much too close.

**Collision Alert**



When your vehicle approaches another vehicle too rapidly, the red FCA display will appear and sound several beeps. When this occurs, the brake system prepares for driver braking to occur more rapidly. Continue to apply the brake pedal as the driving situation dictates.

**Selecting the Alert Timing**

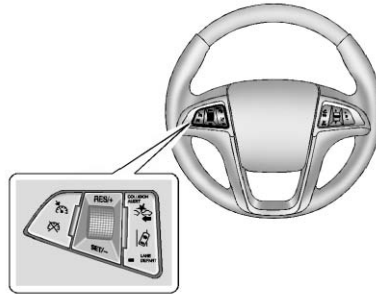

The Collision Alert control is on the steering wheel. Press COLLISION ALERT to set the alert timing to far, medium, near or off. The first button press shows the current control setting on the DIC. Additional button presses will change this setting. The chosen setting will remain until it is changed and will affect both the Collision Alert and the Tailgating Alert features. The timing of both alerts will vary based on vehicle speed. The faster the vehicle speed, the further away the alert will occur.

Consider traffic and weather conditions when selecting the alert timing. The range of selectable alert timing may not be appropriate for all drivers and driving conditions.

**Following Distance Indication**

The following distance indication displays the distance to a moving vehicle in front. When a vehicle is detected ahead at speeds over 40 km/h (25 mph), the distance is indicated in seconds on the Driver Information Center (DIC). See *Driver Information Center (DIC) on page 5-41*. The minimum distance is 0.5 seconds away. If there is no vehicle ahead, or the vehicle ahead is out of range, dashes will be displayed.

**Unnecessary Alerts**

FCA may sometimes set unnecessary alerts to turning vehicles, vehicles in other lanes, objects that are not vehicles,

## 9-40 Driving and Operating

or shadows. These alerts are normal operation and the vehicle does not need service.

### Other Messages

There are messages that may appear on the Driver Information Center (DIC) in the instrument cluster to provide information about FCA. See *Object Detection System Messages on page 5-47*.

### Cleaning the System

If the FCA system does not seem to operate properly, clean the outside of the windshield area in front of the camera sensor before considering taking the vehicle in for service.

### Ultrasonic Parking Assist

If available, the Ultrasonic Front and Rear Parking Assist (UFRPA) or Ultrasonic Rear Parking Assist (URPA) system assists the driver with parking and avoiding objects. At speeds less than 8 km/h (5 mph), the system detects objects up to 2.5 m (8 ft) behind the vehicle, and

at least 25 cm (10 in) off the ground. If the vehicle has the UFRPA system, it also detected objects 1.2 m (4 ft) in front of the vehicle.

#### WARNING

The parking assist system does not detect children, pedestrians, bicyclists, animals, or objects located below the bumper or that are too close or too far from the vehicle. It is not available at speeds greater than 8 km/h (5 mph). To prevent injury, death, or vehicle damage, even with parking assist, always check the area around the vehicle and check all mirrors before moving forward or backing.

### How the System Works

When the vehicle is shifted into R (Reverse) the sensors are automatically turned on. After the vehicle is shifted out of R (Reverse), the rear sensors are turned off and

the front sensors (if equipped) stay on until the vehicle is above a speed of 8 km/h (5 mph). For the front park assist system to be active again without shifting into R (Reverse), the park assist button in the overhead console must be pressed. See "Turning the System On and Off" later in this section.

When the vehicle is in N (Neutral), the system may be active. If the vehicle is in a car wash, the sensors may detect objects in the car wash. See "Turning the System On and Off" later in this section to turn the system off.

For vehicles with UFRPA, high-toned beeps from the front speakers are for objects detected near the front bumper. Low-toned beeps from the rear speakers are for objects detected near the rear bumper. The interval between the beeps becomes shorter as the vehicle gets closer to the obstacle. When the distance is less than 30 cm (12 in) the beeping is a continuous tone for five seconds.

To be detected, objects must be at least 25 cm (10 in) off the ground and below hatch level. Objects must also be within 1.2 m (4 ft) in front of the vehicle and 2.5 m (8 ft) from the rear bumper. This distance may be less during warmer or humid weather.

### Objects Detected by Both the Front and Rear Sensors (If Equipped)

In general, if objects are detected at the same time near both the front and rear bumpers while backing up, the beeps only sound to indicate that objects are close to the rear bumper.

However, if an object comes within 0.3 m (1 ft) of the front bumper while the vehicle is backing up and at the same time there is another object further than 0.3 m (1 ft) from the rear bumper, then the beeps only sound to indicate the object that is closer to the front bumper.

### Turning the System On and Off

The system can be turned on and off by pressing the park assist button located in the overhead console.



The indicator light next to the park assist button lights up when the system is on and turns off when it has been disabled.

When the system is off, PARK ASSIST OFF displays on the Driver Information Center (DIC). The message disappears after a short period of time.

The system defaults to the on setting each time the vehicle is started.

### When the System Does Not Seem to Work Properly

The following messages may be displayed on the DIC:

**SERVICE PARKING ASSIST:** If this message occurs, check the following conditions:

- The ultrasonic sensors are not clean. Keep the vehicle's bumpers free of mud, dirt, snow, ice, and slush. For cleaning instructions, see *Exterior Care* on page 10-77.
- The park assist sensors are covered by frost or ice. Frost or ice can form around and behind the sensors and may not always be seen; this can occur after washing the vehicle in cold weather. The message may not clear until the frost or ice has melted.

If the above conditions do not exist, take the vehicle to your dealer to repair the system.

**PARK ASSIST OFF:** If the system does not activate due to a temporary condition, the message displays on the DIC. This can occur under the following conditions:

- The driver has disabled the system.
- An object was hanging out of the hatch during the last drive cycle. Once the object is removed, the system will return to normal operation.
- An object or cover is attached to the front of the vehicle.
- The bumper is damaged. Take the vehicle to your dealer to repair the system.
- Other conditions, such as vibrations from a jackhammer or the compression of air brakes on a very large truck, are affecting system performance.

### Rear Vision Camera (RVC)

The vehicle may have a Rear Vision Camera (RVC) system. Read this entire section before using it.

The RVC system can assist the driver when backing up by displaying a view of the area behind the vehicle.

#### WARNING

The RVC system does not display children, pedestrians, bicyclists, animals, or any other object located outside the camera's field of view, below the bumper, or under the vehicle. Perceived distances may be different from actual distances. Do not back the vehicle using only the RVC screen, during longer, higher speed backing maneuvers, or where there could be cross traffic. Failure to use proper care

(Continued)

#### WARNING (Continued)

before backing may result in injury, death, or vehicle damage. Always check behind and around the vehicle before backing.

#### How the System Works

When the vehicle is shifted into R (Reverse), the image of the area behind the vehicle appears in the center stack display. The previous screen displays when the vehicle is shifted out of R (Reverse) after approximately 10 seconds.

To cancel the delay, do one of the following:

- Press a button on the infotainment system.
- Shift into P (Park).
- Reach a vehicle speed of 8 km/h (5 mph).

### Turning the Rear Vision Camera System On or Off

To turn the RVC system on or off:

1. Shift into P (Park).
2. Press the CONFIG button on the center stack.
3. Select Display.
4. Select Camera. When a checkmark appears next to Camera, then the RVC system is on.

### Symbols

The navigation system may have a feature that lets the driver view symbols on the navigation screen while using the RVC. The Ultrasonic Front and Rear Parking Assist (UFRPA) or Ultrasonic Rear Parking Assist (URPA) system must not be disabled to use the caution symbols. The error message REAR PARKING ASSIST SYMBOLS UNAVAILABLE may display if parking assist has been disabled and the symbols

have been turned on. See *Ultrasonic Parking Assist* on page 9-40.

The symbols appear and may cover an object when viewing the navigation screen when an object is detected by the parking assist system.

To turn the symbols on or off:

1. Shift into P (Park).
2. Press the CONFIG button on the center stack.
3. Select Display.
4. Select Symbols. When a checkmark appears next to Symbols, symbols will appear.

### Rear Vision Camera Error Messages

**SERVICE REAR VISION CAMERA SYSTEM:** If this message appears in the center stack display, the system is not receiving information it requires from other vehicle systems.

If any other problem occurs or if a problem persists, see your dealer.

### Rear Vision Camera Location

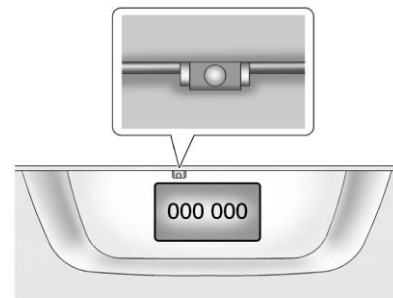

The RVC is located above the license plate.

The area displayed by the camera is limited.

It does not display objects that are close to either corner or under the bumper and can vary depending on vehicle orientation or road conditions. The distance of the image that appears on the screen is different from the actual distance.

## 9-44 Driving and Operating

The following illustration shows the field of view that the camera provides.

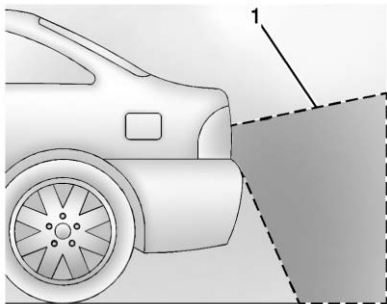

1. View displayed by the camera.

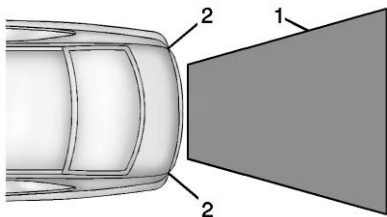

1. View displayed by the camera.

2. Corner of the rear bumper.

### When the System Does Not Seem To Work Properly

The RVC system may not work properly or display a clear image if:

- The RVC is turned off. See “Turning the Rear Vision Camera System On or Off” earlier in this section.
- It is dark.
- The sun or the beam of headlamps is shining directly into the camera lens.
- Ice, snow, mud, or anything else has built up on the camera lens. Clean the lens, rinse it with water, and wipe it with a soft cloth.
- The back of the vehicle was in an accident. The position and mounting angle of the camera can change or the camera can be affected. Be sure to have the

camera and its position and mounting angle checked at your dealer.

### Lane Departure Warning (LDW)

For vehicles with this feature, read the entire section before using it.

#### **WARNING**

The LDW system is an aid to help the vehicle stay in the driving lane. It does not steer the vehicle. The LDW system may not:

- Provide enough time to avoid a crash.
- Detect lane markings under bad weather conditions or if the windshield is dirty.
- Detect lane markings and will not detect road edges.

(Continued)

**WARNING (Continued)**

- Warn that the vehicle is crossing a lane marking if the system does not detect the lane marking.

If LDW only detects lane markings on one side of the road, it will only warn you when departing the lane on the side where it has detected a lane marker. Even with LDW, always keep your attention on the road and maintain proper vehicle position within the lane, or vehicle damage, injury, or death could occur. Always keep the windshield clean and do not use LDW in bad weather conditions.

When the vehicle crosses a detected lane marking, the LDW indicator will flash and three beeps will sound. LDW will not warn if the turn signal is on or if a sharp maneuver is made.

**How the System Works**

The LDW camera sensor is on the windshield ahead of the rearview mirror.

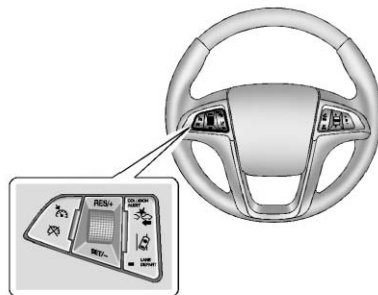

To turn LDW on and off, press the LANE DEPART button on the steering wheel. The control indicator will light when LDW is on.



When the vehicle is started, the LDW indicator on the instrument panel will come on briefly.

LDW operates at speeds of 56 km (35 mph) or greater. If LDW is on, the LDW indicator will appear green if the system detects a left or right lane marking. This indicator will change to amber, flash, and three chimes will sound if the vehicle crosses a detected lane marking without using the turn signal.

To change the volume of the warning chime, see "Chime Volume" under *Vehicle Personalization on page 5-51* for more information.

### When the System Does Not Seem To Work Properly

If the LDW symbol does not appear:

- The lane markings on the road may not be seen.
- The camera sensor may be blocked by dirt, snow or ice.
- The windshield may be damaged.
- The weather may be limiting visibility.

This is normal operation; the vehicle does not need service. Clean the windshield.

#### **WARNING**

If the LDW camera sensor is blocked by dirt, snow, or ice, or if the headlamps are not cleaned or properly aimed, or if the windshield is dirty or damaged, it may not detect the lanes ahead. LDW may not help avoid a crash

(Continued)

#### **WARNING (Continued)**

under these conditions. Keep the headlamps cleaned and properly aimed and the windshield clean.

LDW warnings may occasionally occur due to tar marks, shadows, cracks in the road, or other road imperfections. This is normal system operation, the vehicle does not need service.

#### **LDW Messages**

##### **FRONT CAMERA BLOCKED, CLEAN WINDSHIELD:**

This message may appear because the front camera is blocked and cannot operate properly. It may also activate during heavy rain or due to road spray.

##### **LANE DEPARTURE SYSTEM UNAVAILABLE:**

This message may appear if LDW does not activate due to a temporary condition.

**SERVICE FRONT CAMERA:** This message may appear to indicate that LDW is not working properly. If this message remains on after continued driving, the system needs service. Take the vehicle to your dealer.



## Charging

### Plug-In Charging

This section explains the process for charging the vehicle's high voltage battery. Do not allow the vehicle to remain in temperature extremes for long periods without being driven or plugged in. It is recommended that the vehicle be plugged in when temperatures are below 0°C (32°F) and above 32°C (90°F) to maximize high voltage battery life.

When using a 120-volt AC electrical outlet, it will take approximately 10 hours to charge the vehicle with the 12 amp AC current setting or 16 hours using the default 8 amp AC current setting. When using a 240-volt charging station, it will take approximately four hours to charge the vehicle. Charge times will vary with outside temperature.

The charging system may run fans and pumps that result in sounds from the vehicle while it is turned

off. Additional unexpected clicking sounds may be caused by the electrical devices used while charging.

While the charge cord is plugged into the vehicle, the vehicle cannot be driven.

### Charging

#### Start Charge

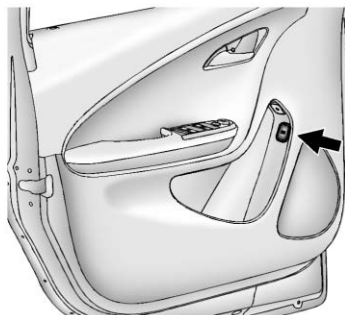

1. The charge port door release button is on the driver door inner trim panel. With the vehicle in P (Park), press the button for one second and release to open

the charge port door. The charge port door can also be opened using the RKE transmitter. See *Remote Keyless Entry (RKE) System Operation* on page 2-2.

In cold weather conditions, ice may form around the charge port door. The charge port door may not open on the first attempt. Remove ice from the area and repeat attempting to open the charge port door.



2. Open the rear hatch, lift the load support floor covering (1), and remove the charge cord (4). It is

near the tire sealant and compressor kit (3). Pull up on the charge cord handle (4) to release it from the handle clip. Lift the charge cord up and rearward to remove it from the vehicle. The vehicle plug (2) is stored as shown.

3. Plug the charge cord into the electrical outlet. See *Electrical Requirements for Battery Charging* on page 9-54. Verify the charge cord status. See the charge cord user guide. See *Charge Cord* on page 9-53. Select the appropriate charge level using the Select Charge Level Preference screen on the center stack. See "Charge Level Selection" under *Programmable Charging* on page 5-29.

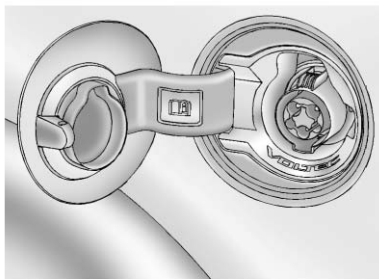

4. Plug in the vehicle plug of the charge cord into the charge port on the vehicle. Verify that the charging status indicator illuminates on top of the instrument panel and a horn chirp occurs. See *Charging Status Feedback* on page 9-49.
5. To arm the charge cord theft alert, lock the vehicle with the RKE transmitter. To disable this feature, see "Charge Cord Theft Alert" in *Vehicle Personalization* on page 5-51.

### End Charge

1. Unlock the vehicle with the RKE transmitter to disarm the charge cord theft alert.

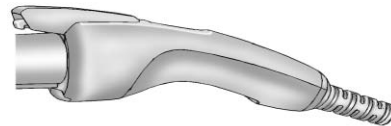

2. Unplug the vehicle plug of the charge cord from the vehicle.
3. Close the charge port door by pressing firmly in the center to latch properly.
4. Unplug the charge cord from the electrical outlet.
5. Place the charge cord into the storage compartment.

## Delayed Charging Override

To temporarily override a delayed charge event, unplug the charge cord from the charge port and then plug it back in within five seconds. A single horn chirp will sound and charging will begin immediately.

To cancel a temporary override, unplug the charge cord, wait for 10 seconds, and then plug the charge cord back in. A double horn chirp will sound and charging will be delayed.

See “Programmable Charging” in *Programmable Charging* on page 5-29 for advanced charge scheduling options.

## Charging Status Feedback



The vehicle has a Charging Status Indicator (CSI) at the center of the instrument panel near the windshield. When the vehicle is plugged in and the vehicle power is off, the CSI indicates the following:

- Solid Green – Vehicle is plugged in. Battery is not fully charged. Battery is charging.

- Long Flashing Green – Vehicle is plugged in. Battery is not fully charged. Battery charging is delayed.
- Short Flashing Green – Vehicle is plugged in. Battery is fully charged.
- Solid Yellow – Vehicle is plugged in. It is normal for the CSI to turn yellow for a few seconds after plugging in a compatible charge cord. The solid yellow may be extended depending on the vehicle and if there is a total utility interruption via OnStar. See “Utility Interruption of Charging” later in this section. This may also indicate that the charging system has detected a fault and will not charge the battery. See “Charge Cord Status Indicators” in the charge cord user guide.

The system may be thermally conditioning the battery during any of the states above, requiring electrical energy to be transferred to the vehicle.

## 9-50 Driving and Operating

---

If the vehicle is plugged in and vehicle power is on, the CSI will be on solid green. The same is true during a remote start if the vehicle is plugged in.



If the vehicle is plugged in and the CSI is off, a total utility interruption using OnStar or a charging fault has been detected. See “Utility Interruption of Charging” or “Charge Cord Status Indicators” in the charge cord user guide.

This chart indicates vehicle feedback when the charge cord is plugged in.

<b>Charging Status Indicator</b>	<b>Sound</b>	<b>Action/Reason</b>
Solid Green	One horn chirp	Charging has begun.
Long Flashing Green	Two horn chirps	Charging is delayed by Programmable Charging or, if the vehicle is equipped accordingly, by a total utility interruption via OnStar. Charging will begin later. See <i>Utility Interruption of Charging on page 9-54</i> .
Short Flashing Green	None	Charging is complete.
Yellow (Upon Plug-in)	None	Charge cord is OK and vehicle is not yet charging.
Yellow (For Extended Time Period after Plug-in)	None	Charge cord is OK, but the vehicle is not charging. This may be due to a total utility interruption via Onstar and charging will begin later. See <i>Utility Interruption of Charging on page 9-54</i> or <i>Malfunction Indicator Lamp on page 5-17</i> .
Solid Green or Long Flashing Green	Four horn chirps	Insufficient time to fully charge by departure time.
None (Upon Plug-in)	None	Charge cord connection should be checked.

## 9-52 Driving and Operating

---

Charging Status Indicator	Sound	Action/Reason
None (After Green or Yellow CSI Indication Observed)	None	Charge cord connection should be checked. If connection is good, this may be due to a total utility interruption via OnStar and charging will begin later. See <i>Utility Interruption of Charging</i> on page 9-54 or <i>Malfunction Indicator Lamp</i> on page 5-17.
None	Repeated horn chirps To disable this feature, see “Charge Power Loss Alert” in <i>Vehicle Personalization</i> on page 5-51. To stop this alert, do one of the following: <ul style="list-style-type: none"><li>• Unplug the charge cord.</li><li>• Press  on the RKE.</li><li>• Press and hold  on the RKE, then press again to stop the panic alarm.</li><li>• Press the horn pad.</li></ul>	Electricity was interrupted before charging was complete.

## Charge Cord

See *Radio Frequency Statement on page 13-15* for information regarding Part 15 of the Federal Communications Commission (FCC) rules and Industry Canada Standards RSS-GEN/210/220/310.

A portable charge cord used to charge the vehicle high voltage battery is stored under the rear luggage compartment.

### Important Information About Portable Electric Vehicle Charging

- Charging an electric vehicle can stress a building's electrical system more than a typical household appliance.
- Before you plug in to any electrical outlet, have a qualified electrician inspect and verify the electrical system (electrical outlet, wiring, junctions, and protection devices) for heavy-duty service at a 12 amp continuous load.

- Electrical outlets may wear out with normal usage or be damaged over time, making them unsuitable for electric vehicle charging.
- Check the electrical outlet/plug while charging and discontinue use if the electrical outlet/plug is hot, then have the electrical outlet serviced by a qualified electrician.
- When outdoors, plug into an electrical outlet that is weather-proof while in use.
- Mount the charging cord to reduce strain on the electrical outlet/plug.

### WARNING

Improper use of portable electric vehicle charge cords may cause a fire, electrical shock, or burns, and may result in damage to property, serious injury, or death.

- Do not use extension cords, multi-outlet power strips, splitters, grounding adaptors, surge protectors, or similar devices.
- Do not use an electrical outlet that is worn or damaged, or one that will not hold the plug firmly in place.
- Do not use an electrical outlet that is not properly grounded.
- Do not use an electrical outlet that is on a circuit with other electrical loads.

See the charge cord user guide.

### Charge Cord Status Indicators

See “Charge Cord Status Indicators” in the charge cord user guide.

### Charge Level Selection

Charge level selection can be made using the Select Charge Level Preference screen on the center stack. See “Charge Level Selection” under *Programmable Charging* on page 5-29.

#### **WARNING**

Using a charge level that exceeds the electrical circuit or electrical outlet capacity may start a fire or damage the electrical circuit. Use the lowest charge level until a qualified electrician inspects your electrical circuit capacity. Use the lowest charge level if the electrical circuit or electrical outlet capacity is not known.

### Utility Interruption of Charging

For participating customers, this vehicle will respond to remote requests via OnStar to limit or completely block electrical power grid usage for brief time periods. A utility interruption of charging may increase vehicle charge time.

When electrical grid power is completely blocked, the vehicle will delay charging until the utility interruption has expired. The vehicle should be left plugged in so that, when the utility interruption expires, the vehicle can automatically begin charging.

Changing the charge mode to Immediate or performing a delayed charging override will not disable a utility interruption.

A pop-up will be displayed in the center stack display during the key cycle following any utility interruption. See “Charge Override/

Interruption Pop-up” under *Programmable Charging* on page 5-29.

Text will be displayed on the instrument cluster indicating that a utility interruption has occurred. See *Instrument Cluster* on page 5-8.

### Electrical Requirements for Battery Charging

This vehicle is capable of being charged with standard vehicle charging equipment complying to:

- SAE J1772
- IEC 61851-1
- IEC 61851-22
- IEC 62196-1
- IEC 62196-2

The following are the minimum requirements for circuits used to charge this vehicle:

- 120 volts/15 amp
- 240 volts/20 amp



Charging equipment with a rating of at least 240V/20Amp will provide the fastest charging time to recharge the high voltage battery. 240V/40Amp circuits provide flexibility for future vehicle charging needs. Always follow your charging equipment installation instructions. Contact your dealer for more information.

**Notice: Do not use portable or stationary backup generating equipment to charge the vehicle. This may cause damage to the vehicle's charging system. Only charge the vehicle from utility supplied power.**

## Fuel

Use of the recommended fuel is an important part of the proper maintenance of this vehicle. To help keep the engine clean and maintain optimum vehicle performance, we recommend the use of gasoline advertised as TOP TIER Detergent Gasoline.

Look for the TOP TIER label on the fuel pump to ensure gasoline meets enhanced detergency standards developed by auto companies. A list of marketers providing TOP TIER Detergent Gasoline can be found at [www.toptiergas.com](http://www.toptiergas.com). TOP TIER gasoline is only available in the U.S. and Canada.



Use premium unleaded gasoline with a posted octane rating of 91 or higher. If the octane is less than 91, you could damage the engine. If heavy knocking is heard when using gasoline rated at 91 octane or higher, the engine needs service.

### Use of Seasonal Fuels

Use summer and winter fuels in the appropriate season. Driving or starting could be affected if the incorrect fuel is used. Drive the vehicle with the engine running until the fuel is a half tank or less, then refuel with the current seasonal fuel.

### Gasoline Specifications

At a minimum, gasoline should meet ASTM specification D 4814. Some gasolines contain an octane-enhancing additive called methylcyclopentadienyl manganese tricarbonyl (MMT). We recommend against the use of gasolines containing MMT. See *Fuel Additives* on page 9-56.

### California Fuel Requirements

If the vehicle is certified to meet California Emissions Standards, it is designed to operate on fuels that meet California specifications. See the underhood emission control label. If this fuel is not available in states adopting California Emissions Standards, the vehicle will operate satisfactorily on fuels meeting federal specifications, but emission control system performance might be affected. The malfunction indicator lamp could turn on and the vehicle might fail a smog-check test.

See *Malfunction Indicator Lamp* on page 5-17. If this occurs, return to your authorized dealer for diagnosis. If it is determined that the condition is caused by the type of fuel used, repairs might not be covered by the vehicle warranty.

### Fuels in Foreign Countries

If planning to drive in countries outside the U.S. or Canada, the proper fuel might be hard to find. Check regional auto club or fuel retail brand websites for availability in the country where driving. Never use leaded gasoline, fuel containing methanol, or any other fuel not recommended. Costly repairs caused by use of improper fuel would not be covered by the vehicle warranty.

### Fuel Additives

To provide cleaner air, all gasolines in the United States are now required to contain additives that

help prevent engine and fuel system deposits from forming, allowing the emission control system to work properly. In most cases, nothing should have to be added to the fuel. However, some gasolines contain only the minimum amount of additive required to meet U.S. Environmental Protection Agency regulations. To help keep fuel injectors and intake valves clean and avoid problems due to dirty injectors or valves, look for gasoline that is advertised as TOP TIER Detergent Gasoline. Look for the TOP TIER label on the fuel pump to ensure gasoline meets enhanced detergency standards developed by the auto companies. A list of marketers providing TOP TIER Detergent Gasoline can be found at [www.toptiergas.com](http://www.toptiergas.com).

For customers who do not use TOP TIER Detergent Gasoline regularly, one bottle of Fuel System Treatment PLUS, part number 88861013, added to the fuel tank at every engine oil change, can help clean

deposits from fuel injectors and intake valves. GM Fuel System Treatment PLUS is the only gasoline additive recommended by General Motors. It is available at your dealer.

Gasolines containing oxygenates, such as ethers and ethanol, and reformulated gasolines might be available in your area. We recommend that you use these gasolines, if they comply with the specifications described earlier. However, E85 (85% ethanol) and other fuels containing more than 15% ethanol must not be used in vehicles that were not designed for those fuels.

**Notice:** This vehicle was not designed for fuel that contains methanol. Do not use fuel containing methanol. It can corrode metal parts in the fuel system and also damage plastic and rubber parts. That damage would not be covered under the vehicle warranty.

Some gasolines that are not reformulated for low emissions can contain an octane-enhancing additive called methylcyclopentadienyl manganese tricarbonyl (MMT); ask the attendant where you buy gasoline whether the fuel contains MMT. We recommend against the use of such gasolines. Fuels containing MMT can reduce spark plug life and affect emission control system performance. The malfunction indicator lamp might turn on. If this occurs, return to your dealer for service.

## Filling the Tank

### WARNING

Fuel vapors and fuel fires burn violently and can cause injury or death.

- To help avoid injuries to you and others, read and follow all the instructions on the fuel pump island.
- Turn off the engine when refueling.
- Keep sparks, flames, and smoking materials away from fuel.
- Do not leave the fuel pump unattended.
- Do not reenter the vehicle while pumping fuel.
- Keep children away from the fuel pump and never let children pump fuel.

(Continued)

### WARNING (Continued)

- Fuel can spray out if the fuel cap is opened too quickly. This spray can happen if the tank is nearly full, and is more likely in hot weather. Open the fuel cap slowly and wait for any hiss noise to stop then unscrew the cap all the way

The fuel system on this vehicle requires a refueling process to control evaporative emissions. To refuel the vehicle:

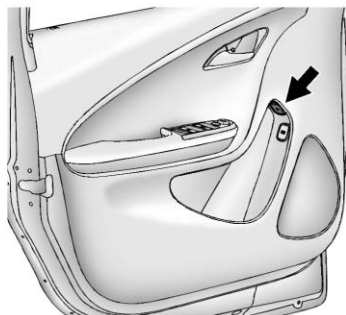

1. Press the fuel door button on the driver door for one second. A WAIT TO REFUEL message displays on the Driver Information Center.



2. When the READY TO REFUEL message displays, the fuel door on the passenger side will unlock. Push the rearward edge of the fuel door in and release to open the door.
3. Turn the fuel cap counterclockwise to remove. While refueling, hang the fuel cap tether from the hook on the inside of the fuel door. Complete refueling within 30 minutes of pushing the fuel door button on the driver door. If refueling more than 30 minutes, push the fuel door button again.
4. After refueling, reinstall the fuel cap by turning it clockwise until it clicks. Close the fuel door.

Do not top off or overfill the tank and wait a few seconds before removing the nozzle. Clean fuel from painted surfaces as soon as possible. See *Exterior Care* on page 10-77.

 **WARNING**

If a fire starts while you are refueling, do not remove the nozzle. Shut off the flow of fuel by shutting off the pump or by notifying the station attendant. Leave the area immediately.

**Notice:** If a new fuel cap is needed, be sure to get the right type of cap from your dealer. The wrong type of fuel cap might not fit properly, might cause the malfunction indicator lamp to light, and could damage the fuel tank and emissions system. See *Malfunction Indicator Lamp* on page 5-17.

## Filling a Portable Fuel Container

 **WARNING**

Filling a portable fuel container while it is in the vehicle can cause fuel vapors that can ignite either by static electricity or other means. You or others could be badly burned and the vehicle could be damaged. Always:

- Use approved fuel containers.
- Remove the container from the vehicle, trunk, or pickup bed before filling.
- Place the container on the ground.
- Place the nozzle inside the fill opening of the container before dispensing fuel, and

(Continued)

**WARNING (Continued)**

keep it in contact with the fill opening until filling is complete.

- Fill the container no more than 95% full to allow for expansion.
- Do not smoke, light matches, or use lighters while pumping fuel.
- Avoid using cell phones or other electronic devices.

## Towing

### General Towing Information

The vehicle is neither designed nor intended to tow a trailer or another vehicle.

For information on towing a disabled vehicle, see *Towing the Vehicle on page 10-73*. For information on towing the vehicle behind another vehicle such as a motor home, see *Recreational Vehicle Towing on page 10-76*.

## Conversions and Add-Ons

### Add-On Electrical Equipment

**Notice:** Some electrical equipment can damage the vehicle or cause components to not work and would not be covered by the warranty. Always check with your dealer before adding electrical equipment.

Add-on equipment can drain the vehicle's 12-volt battery, even if the vehicle is not operating.

When adding electrical equipment, it should only be connected using the accessory power outlets. The maximum power that can be supplied by one accessory power outlet or spread across all three is 200 watts or 15 amps. Exceeding 200 watts or 15 amps may cause erratic vehicle operation. See *Power Outlets on page 5-7*.

The vehicle has an airbag system. Before attempting to add anything electrical to the vehicle, see *Servicing the Airbag-Equipped Vehicle on page 3-27* and *Adding Equipment to the Airbag-Equipped Vehicle on page 3-27*.

# Vehicle Care

## General Information

General Information .....	10-2
California Proposition 65 Warning .....	10-2
California Perchlorate Materials Requirements ....	10-2
Accessories and Modifications .....	10-2
Lifting the Vehicle .....	10-3

## Vehicle Checks

Doing Your Own Service Work .....	10-5
Hood .....	10-6
Engine Compartment Overview .....	10-8
Engine Oil .....	10-9
Engine Oil Life System .....	10-12
Engine Air Cleaner/Filter .....	10-12
Cooling System (Engine) ...	10-14
Cooling System (High Voltage Battery) .....	10-15
Cooling System (Power Electronics and Charger Modules) .....	10-16
Engine Coolant .....	10-16

Engine Overheating .....	10-19
Washer Fluid .....	10-19
Brakes .....	10-20
Brake Fluid .....	10-21
Battery .....	10-22
Electric Drive Unit Shift Lock Control Function Check ...	10-24
Park Brake and P (Park) Mechanism Check .....	10-25
Wiper Blade Replacement .....	10-25

## Headlamp Aiming

Headlamp Aiming .....	10-26
-----------------------	-------

## Bulb Replacement

Bulb Replacement .....	10-27
Halogen Bulbs .....	10-27
LED Lighting .....	10-27
Headlamps .....	10-27
Back-Up Lamps .....	10-28
License Plate Lamp .....	10-29
Replacement Bulbs .....	10-29

## Electrical System

High Voltage Devices and Wiring .....	10-30
Electrical System Overload .....	10-30

Engine Compartment Fuse Block .....	10-31
Instrument Panel Fuse Block (Left Side) .....	10-34
Instrument Panel Fuse Block (Right Side) .....	10-35
Rear Compartment Fuse Block .....	10-38

## Wheels and Tires

Tires .....	10-39
All-Season Tires .....	10-40
Winter Tires .....	10-41
Summer Tires .....	10-41
Tire Sidewall Labeling .....	10-41
Tire Designations .....	10-42
Tire Terminology and Definitions .....	10-43
Tire Pressure .....	10-46
Tire Pressure Monitor System .....	10-47
Tire Pressure Monitor Operation .....	10-48
Tire Inspection .....	10-51
Tire Rotation .....	10-52
When It Is Time for New Tires .....	10-53
Buying New Tires .....	10-53

## 10-2 Vehicle Care

---

Different Size Tires and Wheels .....	10-55
Uniform Tire Quality Grading .....	10-56
Wheel Alignment and Tire Balance .....	10-57
Wheel Replacement .....	10-57
Tire Chains .....	10-59
If a Tire Goes Flat .....	10-59
Tire Sealant and Compressor Kit .....	10-60
Storing the Tire Sealant and Compressor Kit .....	10-67
<b>Jump Starting</b>	
Jump Starting .....	10-68
<b>Towing</b>	
Towing the Vehicle .....	10-73
Recreational Vehicle Towing .....	10-76
<b>Appearance Care</b>	
Exterior Care .....	10-77
Interior Care .....	10-80
Floor Mats .....	10-83

### General Information

For service and parts needs, visit your dealer. You will receive genuine GM parts and GM-trained and supported service people.

Genuine GM parts have one of these marks:

---



---



---



### California Proposition 65 Warning

Most motor vehicles, including this one, contain and/or emit chemicals known to the State of California to

cause cancer and birth defects or other reproductive harm. Engine exhaust, many parts and systems, many fluids, and some component wear by-products contain and/or emit these chemicals.

### California Perchlorate Materials Requirements

Certain types of automotive applications, such as airbag initiators, safety belt pretensioners, and lithium batteries contained in Remote Keyless Entry transmitters, may contain perchlorate materials. Special handling may be necessary. For additional information, see [www.dtsc.ca.gov/hazardouswaste/perchlorate](http://www.dtsc.ca.gov/hazardouswaste/perchlorate).

### Accessories and Modifications

Adding non-dealer accessories or making modifications to the vehicle can affect vehicle performance and safety, including such things as airbags, braking, stability, ride and



handling, emissions systems, aerodynamics, durability, and electronic systems like antilock brakes, traction control, and stability control. These accessories or modifications could even cause malfunction or damage not covered by the vehicle warranty.

Damage to vehicle components resulting from modifications or the installation or use of non-GM certified parts, including control module or software modifications, is not covered under the terms of the vehicle warranty and may affect remaining warranty coverage for affected parts.

GM Accessories are designed to complement and function with other systems on the vehicle. See your dealer to accessorize the vehicle using genuine GM Accessories installed by a dealer technician.

Also, see *Adding Equipment to the Airbag-Equipped Vehicle on page 3-27*.

## Lifting the Vehicle

This vehicle can be lifted with a hoist or a service jack. Do not use any other type of jack to lift the vehicle.

### Lifting the Vehicle with a Hoist

This vehicle can be lifted with a hoist at the four locations, as illustrated.

**Notice:** Lifting the vehicle improperly can damage the vehicle and result in costly repairs not covered by the warranty.

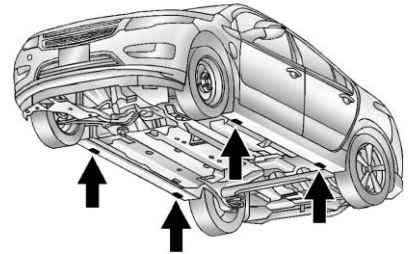

The front lifting points can be accessed from either side of the vehicle, behind the front tires.

The rear lifting points can be accessed from either side of the vehicle, in front of the rear tires.

## 10-4 Vehicle Care

### Lifting the Vehicle with a Service Jack

#### WARNING

Lifting a vehicle can cause an injury. The vehicle can slip off the jack and roll over you or other people. You and they could be badly injured. Find a level place to lift your vehicle. To help prevent the vehicle from moving:

1. Set the parking brake firmly.
2. Put the shift lever in P (Park).
3. Turn off the vehicle.

To be even more certain the vehicle will not move, put blocks in front of and behind the wheels.

#### WARNING

Getting under a vehicle when it is lifted on a jack is dangerous. If the vehicle slips off the jack, you could be badly injured or killed. Never get under a vehicle when it is supported only by a jack.

#### WARNING

Raising the vehicle with the jack improperly positioned can damage the vehicle or the vehicle may fall and cause you or others injury.

When using a jack to lift the vehicle, follow the instructions that came with the jack and be sure to use the correct lifting points to avoid damaging the vehicle.

**Notice:** Lifting the vehicle improperly can cause damage and result in costly repairs not covered by the warranty. To lift the vehicle properly, use this procedure.

**For additional information, see your dealer and the service manual.**

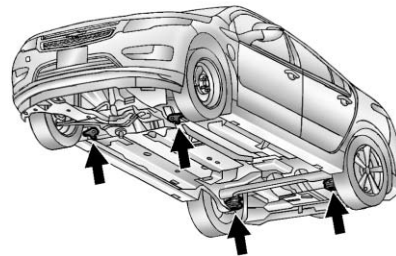

There are four points where the vehicle can be lifted with a service jack.

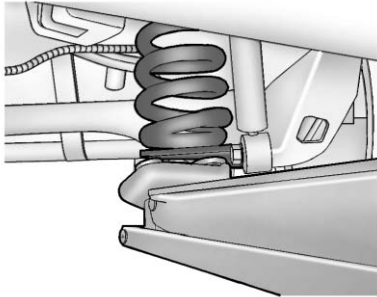

When lifting the vehicle from the rear, place the service jack directly under the spring seat.

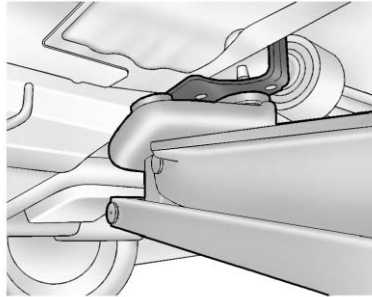

When lifting the vehicle from the front, place the service jack directly under the cradle mount. Ramps may be needed under the front tires to provide the necessary clearance for certain service jacks in this location.

For more information, see *Doing Your Own Service Work* on page 10-5.

## Vehicle Checks

### Doing Your Own Service Work

#### WARNING

Never try to do your own service on high voltage battery components. You can be injured and the vehicle can be damaged if you try to do your own service work. Service and repair of these high voltage battery components should only be performed by a trained dealer technician with the proper knowledge and tools.

Exposure to high voltage can cause shock, burns, and even death. The high voltage components in the vehicle can only be serviced by technicians with special training.

(Continued)

## 10-6 Vehicle Care

### WARNING (Continued)

High voltage components are identified by labels. Do not remove, open, take apart, or modify these components. High voltage cable or wiring has orange covering. Do not probe, tamper with, cut, or modify high voltage cable or wiring.

### ⚠ WARNING

It can be dangerous to work on your vehicle if you do not have the proper knowledge, service manual, tools, or parts. Always follow owner manual procedures and consult the service manual for your vehicle before doing any service work.

If doing some of your own service work, use the proper service manual. It tells you much more

about how to service the vehicle than this manual can. To order the proper service manual, see *Service Publications Ordering Information on page 13-11*.

This vehicle has an airbag system. Before attempting to do your own service work, see *Airbag System Check on page 3-28*.

Keep a record with all parts receipts and list the mileage and the date of any service work performed. See *Maintenance Records on page 11-14*.

**Notice:** Even small amounts of contamination can cause damage to vehicle systems. Do not allow contaminants to contact the fluids, reservoir caps, or dipsticks.

## Hood

To open the hood:

1. Turn the vehicle off before opening the hood. If the vehicle is on, the engine will start when

the hood is opened. See *Electric Mode on page 9-21* and *Extended Range Mode on page 9-21*.



2. Pull the release handle with this symbol. It is below the instrument panel to the left of the steering wheel.

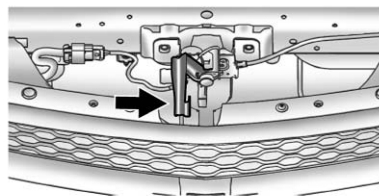

3. Go to the front of the vehicle and locate the secondary release lever under the front center of

the hood. Push the secondary hood release lever to the right to disengage.

4. Lift the hood and release the hood prop rod from its retainer above the radiator support. Place the prop rod securely into the slotted retainer in the hood.

To close the hood:

1. Before closing the hood, check that all filler caps are properly installed. Then, lift the hood to relieve pressure on the hood prop.
2. Remove the hood prop from the slotted retainer in the hood and return it to its retainer above the radiator support. The prop rod must lock into place when returning it to the retainer to prevent hood damage.

3. Lower the hood 20 cm (8 in) above the vehicle and release it so it fully latches. Check to make sure the hood is firmly closed. Repeat the process if necessary.

## Engine Compartment Overview

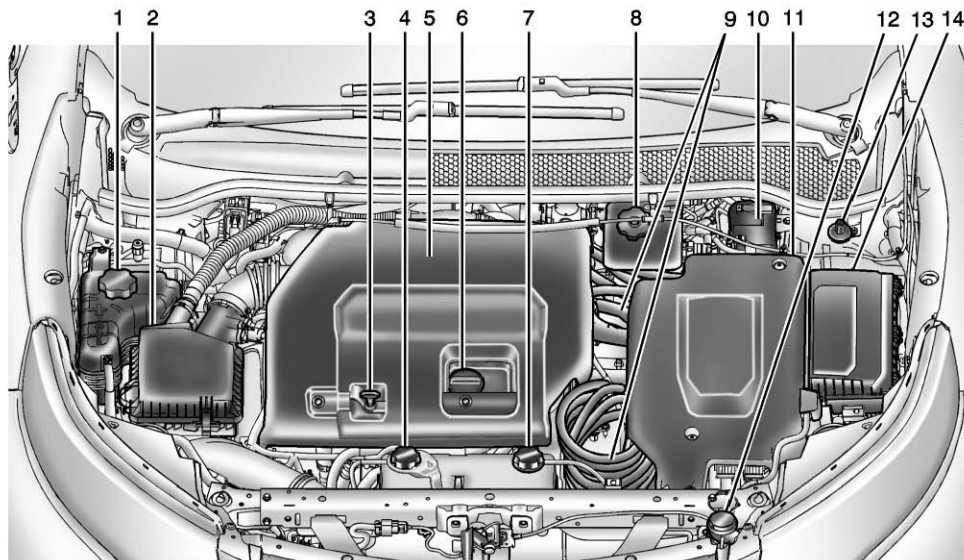

1. Engine Coolant Surge Tank and Pressure Cap. See *Engine Coolant* on page 10-16.
2. *Engine Air Cleaner/Filter* on page 10-12.
3. Engine Oil Dipstick. See *Engine Oil* on page 10-9.
4. High Voltage Battery Coolant Reservoir and Pressure Cap. See *Cooling System (Engine)* on page 10-14 or *Cooling System (High Voltage Battery)* on page 10-15 or *Cooling System (Power Electronics and Charger Modules)* on page 10-16.
5. Engine Cover.
6. Engine Oil Fill Cap. See *Engine Oil* on page 10-9.
7. Power Electronics Coolant Reservoir and Pressure Cap. See *Cooling System (Engine)* on page 10-14 or *Cooling System (High Voltage Battery)* on page 10-15 or *Cooling System (Power Electronics and Charger Modules)* on page 10-16.
8. Brake Fluid Reservoir. See “Brake Fluid” under *Brakes* on page 10-20.
9. High Voltage Cables (Orange Color).
10. Remote Positive (+) Terminal. See *Jump Starting* on page 10-68.
11. Power Electronics Module.
12. Windshield Washer Fluid Reservoir. See “Adding Washer Fluid” under *Washer Fluid* on page 10-19.
13. Remote Negative (-) Terminal. See *Jump Starting* on page 10-68.
14. *Engine Compartment Fuse Block* on page 10-31.

## Engine Oil

To ensure proper engine performance and long life, careful attention must be paid to engine oil. Following these simple, but important steps will help protect your investment:

- Always use engine oil approved to the proper specification and of the proper viscosity grade. See “Selecting the Right Engine Oil” in this section.
- Check the engine oil level regularly and maintain the proper oil level. See “Checking Engine Oil” and “When to Add Engine Oil” in this section.
- Change the engine oil at the appropriate time. See *Engine Oil Life System* on page 10-12.
- Always dispose of engine oil properly. See “What to Do with Used Oil” in this section.

### Checking Engine Oil

It is a good idea to check the engine oil level at each fuel fill. In order to get an accurate reading, the vehicle must be on level ground. The engine oil dipstick handle is a loop. See *Engine Compartment Overview* on page 10-8 for the location of the engine oil dipstick.

Obtaining an accurate oil level reading is essential:

1. If the engine has been running recently, turn off the engine and allow several minutes for the oil to drain back into the oil pan. Checking the oil level too soon after engine shutoff will not provide an accurate oil level reading.

#### **WARNING**

The engine oil dipstick handle may be hot; it could burn you. Use a towel or glove to touch the dipstick handle.

2. Pull out the dipstick and clean it with a paper towel or cloth, then push it back in all the way. Remove it again, keeping the tip down, and check the level.

### When to Add Engine Oil

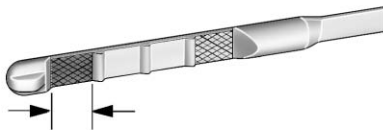

If the oil is below the cross-hatched area at the tip of the dipstick, add 1 L (1 qt) of the recommended oil and then recheck the level. See "Selecting the Right Engine Oil" in this section for an explanation of what kind of oil to use. For engine oil crankcase capacity, see *Capacities and Specifications* on page 12-2.

**Notice:** Do not add too much oil. Oil levels above or below the acceptable operating range shown on the dipstick are harmful

to the engine. If you find that you have an oil level above the operating range, i.e., the engine has so much oil that the oil level gets above the cross-hatched area that shows the proper operating range, the engine could be damaged. You should drain out the excess oil or limit driving of the vehicle and seek a service professional to remove the excess amount of oil.

See *Engine Compartment Overview* on page 10-8 for the location of the engine oil fill cap.

Add enough oil to put the level somewhere in the proper operating range. Push the dipstick all the way back in when through.

### Selecting the Right Engine Oil

Selecting the right engine oil depends on both the proper oil specification and viscosity grade. See *Recommended Fluids and Lubricants* on page 11-12.



## Specification

Use and ask for licensed engine oils with the dexos1<sup>®</sup> approved certification mark. Engine oils meeting the requirements for the vehicle should have the dexos1 approved certification mark. This certification mark indicates that the oil has been approved to the dexos1 specification.



**Notice:** Failure to use the recommended engine oil or equivalent can result in engine damage not covered by the vehicle warranty. Check with your dealer or service provider on whether the oil is approved to the dexos1 specification.

## Viscosity Grade

SAE 5W-30 is the best viscosity grade for the vehicle. Do not use other viscosity grade oils such as SAE 10W-30, 10W-40, or 20W-50.

**Cold Temperature Operation:** In an area of extreme cold, where the temperature falls below  $-29^{\circ}\text{C}$  ( $-20^{\circ}\text{F}$ ), an SAE 0W-30 oil may be used. An oil of this viscosity grade will provide easier cold starting for the engine at extremely low temperatures. When selecting an oil of the appropriate viscosity grade, always select an oil of the correct specification. See "Specification" earlier in this section for more information.

## Engine Oil Additives/Engine Oil Flushes

Do not add anything to the oil. The recommended oils with the dexos1 certification and displaying the dexos1 certification mark are all that is needed for good performance and engine protection.

Engine oil system flushes are not recommended and could cause engine damage not covered by the vehicle warranty.

## What to Do with Used Oil

Used engine oil contains certain elements that can be unhealthy for your skin and could even cause cancer. Do not let used oil stay on your skin for very long. Clean your skin and nails with soap and water, or a good hand cleaner. Wash or properly dispose of clothing or rags containing used engine oil. See the manufacturer's warnings about the use and disposal of oil products.

Used oil can be a threat to the environment. If you change your own oil, be sure to drain all the oil from the filter before disposal. Never dispose of oil by putting it in the trash or pouring it on the ground, into sewers, or into streams or bodies of water. Recycle it by taking it to a place that collects used oil.

### Engine Oil Life System

#### When to Change Engine Oil

This vehicle has a computer system that indicates when to change the engine oil and filter. This is based on a combination of factors which include engine revolutions, engine temperature, and miles driven. Based on driving conditions, the mileage at which an oil change is indicated can vary considerably. For the oil life system to work properly, the system must be reset every time the oil is changed.

When the system has calculated that oil life has been diminished, it indicates that an oil change is necessary. A CHANGE ENGINE OIL SOON message comes on. Change the oil as soon as possible within the next 1 000 km (600 mi). It is possible that, if driving under the best conditions, the oil life system might indicate that an oil change is not necessary for up to two years. The engine oil and filter must be changed at least once

every two years and, at this time, the system must be reset. Your dealer has trained service people who will perform this work and reset the system. It is also important to check the oil regularly over the course of an oil drain interval and keep it at the proper level.

If the system is ever reset accidentally, the oil must be changed at 5 000 km (3,000 mi) since the last oil change. Remember to reset the oil life system whenever the oil is changed.

#### How to Reset the Engine Oil Life System

Reset the system whenever the engine oil is changed so that the system can calculate the next engine oil change. To reset the system:

1. Use the SELECT knob to select OIL LIFE on the DIC menu.
2. Press SELECT to start the OIL LIFE reset procedure.

3. The DIC menu will display "Are you sure that you want to reset?" Use SELECT to choose YES to reset oil life or NO to exit and return to the previous menu.
4. If YES is selected, the DIC menu will display RESET OIL LIFE for a short time and then 100% OIL LIFE will be displayed when OIL LIFE is successfully reset.

If the CHANGE ENGINE OIL SOON message comes back on when the vehicle is started, the engine oil life system has not reset. Repeat the procedure.

### Engine Air Cleaner/Filter

See *Engine Compartment Overview* on page 10-8 for the location of the engine air cleaner/filter.

#### When to Inspect the Engine Air Filter

Inspect the air filter at the scheduled maintenance intervals and replace it at the first oil change after each 80 000 km (50,000 mi) interval. See

*Maintenance Schedule on page 11-2 for more information. If driving in dusty/dirty conditions, inspect the air filter at each engine oil change.*

### How to Inspect the Engine Air Filter

To inspect the air filter, remove it from the engine air cleaner/filter assembly and lightly shake to release loose dust and dirt. If the air filter remains covered with dirt, a new air filter is required.

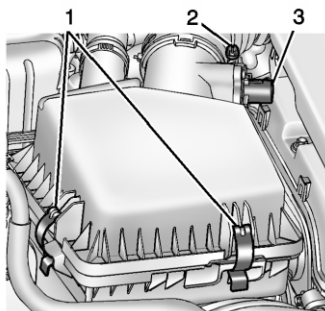

1. Retaining Clips

2. Air Duct Clamp
3. Electrical Connector

To inspect or replace the air filter:

1. Open the hood. See *Hood on page 10-6*.
2. Locate the engine air cleaner/filter assembly on the passenger side of the engine compartment. See *Engine Compartment Overview on page 10-8*.
3. Disconnect the air duct by loosening the air duct clamp (2).
4. Disconnect the electrical connector (3).
5. Lift the retaining clips (1) from the engine air cleaner/filter assembly.
6. Turn and tilt the air cleaner cover slightly upward and slide it out. Remove the air filter.

### How to Reinstall the Engine Air Filter

1. Install the air filter into the engine air cleaner/filter assembly. The outer air filter seal must be fitted properly in the engine air cleaner/filter assembly.
2. Replace the air cleaner cover by lowering it to meet the bottom of the engine air cleaner/filter assembly. Place the retaining clips (1) on the engine air cleaner/filter assembly and secure. The rear tabs must be secured into the lower portion of the air cleaner.
3. Reconnect the air duct and tighten the air duct clamp (2).
4. Reconnect the electrical connector (3).

### WARNING

Operating the engine with the air cleaner/filter off can cause you or others to be burned. The air cleaner not only cleans the air; it helps to stop flames if the engine backfires. Use caution when working on the engine and do not drive with the air cleaner/filter off.

**Notice:** If the air cleaner/filter is off, dirt can easily get into the engine, which could damage it. Always have the air cleaner/filter in place when you are driving.

### Cooling System (Engine)

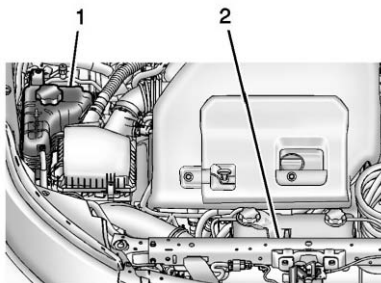

1. Engine Coolant Surge Tank and Pressure Cap
2. Engine Cooling Fans (Out of View)

### WARNING

The electric fans under the hood can start up even when the engine is not running and can cause injury. Keep hands, clothing, and tools away from any underhood electric fan.

If the coolant inside the coolant surge tank is boiling, do not do anything else until it cools down. The vehicle should be parked on a level surface.

The coolant level should be up to the cold fill line. If it is not, there might be a leak at the radiator hoses, heater hoses, radiator, water pump, or somewhere else in the cooling system.

### WARNING

Heater and radiator hoses, and other engine parts, can be very hot. Do not touch them. If you do, you can be burned.

Do not run the vehicle if there is a leak. If you run the engine, it could lose all coolant. That could cause an engine fire, and you could be burned. Get any leak fixed before you drive the vehicle.

If there seems to be no leak, with the engine on, check to see if the cooling fans are running. If the cooling fans are running, the engine is overheating, the fans should be running. If it is not, the vehicle needs service. Turn off the vehicle.

## Cooling System (High Voltage Battery)

During vehicle operation and also during charging, the high voltage battery cells in the vehicle are kept within a normal operating temperature range. If the temperature rises above this temperature, the battery cooling system turns on the air conditioning compressor and cools the coolant until the correct temperature is reached. If the temperature falls below this temperature, a high voltage heater, located in the battery, heats the coolant until the correct temperature is reached.

### What to Use

The high voltage battery coolant reservoir in the vehicle is filled with a 50/50 mixture of DEX-COOL™ engine coolant and deionized water. If using this mixture, nothing else needs to be added.

The coolant needs to be replaced at the appropriate interval. See *Maintenance Schedule on page 11-2*.

### Checking Coolant

The vehicle must be on a level surface when checking the coolant level.

The high voltage battery coolant reservoir is located in the engine compartment. See *Engine Compartment Overview on page 10-8*.

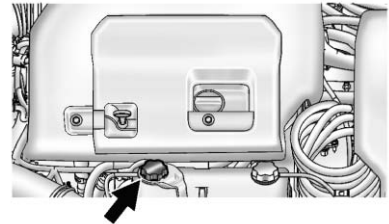

Check to see if coolant is visible in the high voltage battery coolant reservoir. If coolant is visible but the coolant level is below the cold fill line, there could be a leak in the cooling system.

The high voltage battery coolant should only be serviced by a qualified technician.

### Cooling System (Power Electronics and Charger Modules)

The power electronics and charger modules are cooled using the same coolant loop.

The power electronics and charger modules in the vehicle are kept below a maximum temperature. If the temperature rises above this temperature, the electric cooling fans will turn on and cool the coolant until the correct temperature is reached.

#### What to Use

The power electronics and charger modules coolant reservoir in the vehicle is filled with a 50/50 mixture of DEX-COOL engine coolant and deionized water. If using this mixture, nothing else needs to be added.

The coolant needs to be replaced at the appropriate interval. See *Maintenance Schedule on page 11-2*.

#### Checking Coolant

The vehicle must be on a level surface when checking the coolant level.

The power electronics and charger modules coolant reservoir is located in the engine compartment. See *Engine Compartment Overview on page 10-8*.

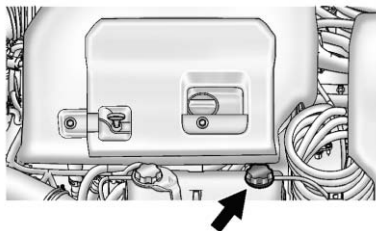

Check to see if coolant is visible in the power electronics and charger modules coolant reservoir. If coolant is visible but the coolant level is below the cold fill line, there could be a leak in the cooling system.

The power electronics and charger modules coolant should only be serviced by a qualified technician.

### Engine Coolant

The engine cooling system in the vehicle is filled with DEX-COOL engine coolant. The coolant needs to be replaced every 5 years or 240 000 km (150,000 mi), whichever occurs first.

The following explains the cooling system and how to check and add coolant when it is low. If there is a problem with engine overheating, see *Engine Overheating on page 10-19*.

## What to Use

### WARNING

Adding only plain water or some other liquid to the cooling system can be dangerous. Plain water and other liquids, can boil before the proper coolant mixture will. The coolant warning system is set for the proper coolant mixture. With plain water or the wrong mixture, the engine could get too hot but you would not get the overheat warning. The engine could catch fire and you or others could be burned. Use a 50/50 mixture of deionized water and DEX-COOL coolant.

Use a 50/50 mixture of deionized water and DEX-COOL coolant. If using this mixture, nothing else needs to be added. This mixture:

- Gives freezing protection down to  $-37^{\circ}\text{C}$  ( $-34^{\circ}\text{F}$ ), outside temperature.

- Gives boiling protection up to  $129^{\circ}\text{C}$  ( $265^{\circ}\text{F}$ ), engine temperature.
- Protects against rust and corrosion.
- Will not damage aluminum parts.
- Helps keep the proper engine temperature.

**Notice: If an improper coolant mixture is used, the engine could overheat and be badly damaged. The repair cost would not be covered by the vehicle warranty. Too much water in the mixture can freeze and crack the engine, radiator, heater core, and other parts.**

Never dispose of engine coolant by putting it in the trash, pouring it on the ground, or into sewers, streams, or bodies of water. Have the coolant changed by an authorized service center, familiar with legal requirements regarding used coolant disposal. This will help protect the environment and your health.

## Checking Coolant

The vehicle must be on a level surface when checking the coolant level.

Check to see if coolant is visible in the coolant surge tank. If the coolant inside the coolant surge tank is boiling, do not do anything else until it cools down. If coolant is visible but the coolant level is not at or above the cold fill mark, add a 50/50 mixture of deionized water and DEX-COOL coolant at the coolant surge tank, but be sure the cooling system is cool before this is done. See *Engine Overheating on page 10-19* for more information.

The coolant reservoir is located on the passenger side of the engine compartment. See *Engine Compartment Overview on page 10-8* for more information on location.

## 10-18 Vehicle Care

The coolant level should be at or above the cold fill line on the coolant surge tank. If it is not, there could be a leak in the cooling system.

### How to Add Coolant to the Coolant Surge Tank

#### WARNING

You can be burned if you spill coolant on hot engine parts. Coolant contains ethylene glycol and it will burn if the engine parts are hot enough. Do not spill coolant on a hot engine.

**Notice:** This vehicle has a specific coolant fill procedure. Failure to follow this procedure could cause the engine to overheat and be severely damaged.

#### WARNING

The electric fans under the hood can start up even when the engine is not running and can cause injury. Keep hands, clothing, and tools away from any underhood electric fan.

#### WARNING

Steam and scalding liquids from a hot cooling system can blow out and burn you badly. They are under pressure, and if you turn the surge tank pressure cap — even a little — they can come out at high speed. Never turn the cap when the cooling system, including the surge tank pressure cap, is hot. Wait for the cooling system and surge tank pressure cap to cool if you ever have to turn the pressure cap.

If coolant is needed, add the proper DEX-COOL coolant mixture at the coolant surge tank.



The coolant surge tank pressure cap can be removed when the cooling system, including the surge tank pressure cap and upper radiator hose, is no longer hot.

1. Turn the pressure cap slowly counterclockwise. If a hiss is heard, wait for that to stop. A hiss means there is still some pressure left.
2. Keep turning the cap and remove it.



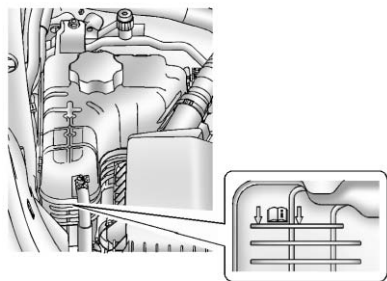

3. Fill the coolant surge tank with the proper mixture to the cold fill line.
4. Replace the pressure cap. Be sure the pressure cap is hand-tight and fully seated.

**Notice:** If the pressure cap is not tightly installed, coolant loss and possible engine damage may occur. Be sure the cap is properly and tightly secured.

## Engine Overheating

The vehicle has an indicator to warn of engine overheating.

If the decision is made not to lift the hood when this warning appears, get service help right away. See *Roadside Assistance Program* on page 13-5.

If the decision is made to lift the hood, make sure the vehicle is parked on a level surface.

Then check to see if the engine cooling fans are running. If the engine is overheating, the fans should be running. If they are not, do not continue to run the vehicle and have the vehicle serviced.

**Notice:** Engine damage from running the engine without coolant is not covered by the warranty.

## Washer Fluid

### What to Use

When adding windshield washer fluid to the vehicle, be sure to read the manufacturer's instructions before use. If operating the vehicle in an area where the temperature may fall below freezing, use a fluid that has sufficient protection against freezing.

### Adding Washer Fluid

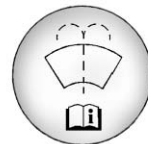

Open the cap with the washer symbol on it. Add washer fluid until the tank is full. See *Engine Compartment Overview* on page 10-8 for reservoir location.

### Notice

- **When using concentrated washer fluid, follow the manufacturer instructions for adding water.**
- **Do not mix water with ready-to-use washer fluid. Water can cause the solution to freeze and damage the washer fluid tank and other parts of the washer system.**
- **Fill the washer fluid tank only three-quarters full when it is very cold. This allows for fluid expansion if freezing occurs, which could damage the tank if it is completely full.**
- **Do not use engine coolant (antifreeze) in the windshield washer. It can damage the windshield washer system and paint.**

### Brakes

This vehicle has disc brakes. Disc brake pads have built-in wear indicators that make a high-pitched warning sound when the brake pads are worn and new pads are needed. The sound can come and go or be heard all the time the vehicle is moving, except when applying the brake pedal firmly.

#### **WARNING**

The brake wear warning sound means that soon the brakes will not work well. That could lead to a crash. When the brake wear warning sound is heard, have the vehicle serviced.

**Notice:** Continuing to drive with worn-out brake pads could result in costly brake repair.

Some driving conditions or climates can cause a brake squeal when the brakes are first applied or lightly applied. This does not mean something is wrong with the brakes.

Properly torqued wheel nuts are necessary to help prevent brake pulsation. When tires are rotated, inspect brake pads for wear and evenly tighten wheel nuts in the proper sequence to torque specifications in *Capacities and Specifications on page 12-2*.

Brake linings should always be replaced as complete axle sets.

### Brake Pedal Travel

See your dealer if the brake pedal does not return to normal height, or if there is a rapid increase in pedal travel. This could be a sign that brake service might be required.

### Brake Adjustment

Every time the brakes are applied, with or without the vehicle moving, the brakes adjust for wear.

## Replacing Brake System Parts

The braking system on a vehicle is complex. Its many parts have to be of top quality and work well together if the vehicle is to have really good braking. The vehicle was designed and tested with top-quality brake parts. When parts of the braking system are replaced, be sure to get new, approved replacement parts. If this is not done, the brakes might not work properly. For example, installing disc brake pads that are wrong for the vehicle, can change the balance between the front and rear brakes — for the worse. The braking performance expected can change in many other ways if the wrong replacement brake parts are installed.

## Brake Fluid



The brake master cylinder reservoir is filled with DOT 3 brake fluid as indicated on the reservoir cap. See *Engine Compartment Overview on page 10-8* for the location of the reservoir.

There are only two reasons why the brake fluid level in the reservoir might go down:

- The brake fluid level goes down because of normal brake lining wear. When new linings are installed, the fluid level goes back up.
- A fluid leak in the brake hydraulic system can also cause a low fluid level. Have the brake

hydraulic system fixed, since a leak means that sooner or later the brakes will not work well.

Do not top off the brake fluid. Adding fluid does not correct a leak. If fluid is added when the linings are worn, there will be too much fluid when new brake linings are installed. Add or remove brake fluid, as necessary, only when work is done on the brake hydraulic system.

### WARNING

If too much brake fluid is added, it can spill on the engine and burn, if the engine is hot enough. You or others could be burned, and the vehicle could be damaged. Add brake fluid only when work is done on the brake hydraulic system.

When the brake fluid falls to a low level, the brake warning light comes on. See *Brake System Warning Light on page 5-20*.

## 10-22 Vehicle Care

### Checking Brake Fluid

Check brake fluid by looking at the brake fluid reservoir. See *Engine Compartment Overview* on page 10-8.

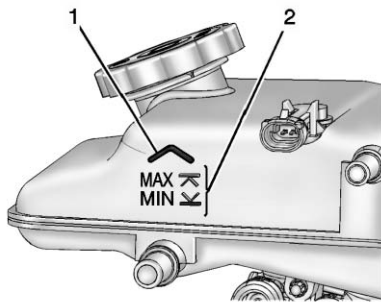

With the vehicle not running for at least one minute, the maximum fluid level (1) is at the top of the reservoir body. With the vehicle running, the fluid level should be in the proper operating range (2) between the MIN and MAX marks. If it is not, have the brake hydraulic system checked to see if there is a leak.

After work is done on the brake hydraulic system, make sure the level, with the vehicle running, is in the proper operating range (2) between the MIN and MAX marks.

### What to Add

Use only new DOT 3 brake fluid from a sealed container. See *Recommended Fluids and Lubricants* on page 11-12.

Always clean the brake fluid reservoir cap and the area around the cap before removing it. This helps keep dirt from entering the reservoir.

### WARNING

With the wrong kind of fluid in the brake hydraulic system, the brakes might not work well. This could cause a crash. Always use the proper brake fluid.

### Notice

- Using the wrong fluid can badly damage brake hydraulic system parts. For example, just a few drops of mineral-based oil, such as engine oil, in the brake hydraulic system can damage brake hydraulic system parts so badly that they will have to be replaced. Do not let someone put in the wrong kind of fluid.
- If brake fluid is spilled on the vehicle's painted surfaces, the paint finish can be damaged. Be careful not to spill brake fluid on the vehicle. If you do, wash it off immediately.

### Battery

This vehicle has a high voltage battery and a standard 12-volt battery.

If the vehicle is in a crash, the sensing system may shut down the high voltage system. When this occurs, the high voltage battery is disconnected and the vehicle will not start. The SERVICE VEHICLE SOON message in the Driver Information Center (DIC) will be displayed. Before the vehicle can be operated again, it must be serviced at your dealer.

See "If a Crash Occurs" under *Collision Damage Repair* on page 13-9 for additional information. If an airbag has inflated, see *What Will You See after an Airbag Inflates?* on page 3-21.

Only a trained service technician with the proper knowledge and tools should inspect, test, or replace the high voltage battery. See your dealer if the high voltage battery needs service. The dealer has information on how to recycle the high voltage battery. There is also information available at <http://www.recyclemybattery.com>.

Keep the vehicle plugged in, even when fully charged, to keep the high voltage battery temperature ready for the next drive. This is important when outside temperatures are extremely hot or cold.

A vehicle cover, which can reduce sun loading on the vehicle and improve high voltage battery life, is available from your dealer.

Refer to the replacement number shown on the original battery label when a new 12-volt battery is needed. The vehicle has an Absorbed Glass Mat (AGM) 12-volt battery. Installation of a standard 12-volt battery will result in reduced 12-volt battery life.

When using a 12-volt battery charger on the 12-volt AGM battery, some chargers have an AGM battery setting on the charger. If available, use the AGM setting on the charger, to limit charge voltage to 14.8 volts.

### WARNING

Battery posts, terminals, and related accessories contain lead and lead compounds, chemicals known to the State of California to cause cancer and reproductive harm. Wash hands after handling.

## Vehicle Storage

### WARNING

12-volt batteries have acid that can burn you and gas that can explode. You can be badly hurt if you are not careful. See *Jump Starting* on page 10-68 for tips on working around a battery without getting hurt.

### Up to four weeks

- Plug in the high voltage battery charge cord if temperatures will exceed 35°C (95°F) and keep the 12-volt battery cables connected.

### Four weeks to 12 months

- Discharge the high voltage battery until two or three bars remain on the battery range indicator (Battery symbol) on the instrument cluster.
- Do not plug in the high voltage battery charge cord.
- Remove the black negative (-) cable from the 12-volt battery and attach a trickle charger to the battery terminals or keep the 12-volt battery cables connected and trickle charge from the underhood remote positive (+) and negative (-) terminals. See *Jump Starting on page 10-68* for the location of these terminals.

**Notice:** The vehicle is equipped with an AGM/VRLA 12-volt battery, which can be damaged by using the incorrect type of trickle charger. An AGM/VRLA-compatible charger must be used, with the appropriate setting selected. Follow the trickle charger manufacturer instructions.

### Reconnecting the 12-Volt Black Negative Cable

With the 12-volt black negative (-) cable disconnected, the hatch cannot be opened by pressing the hatch release button. If the hatch is closed and latched, reopen it:

1. Use the door key to open the driver door.
2. Manually unlock and open one of the rear doors.
3. Lower one of the rear seatbacks.
4. Pull the load floor cover forward to access and reconnect the 12-volt battery black negative (-) cable.

5. After the cable has been connected, open the hatch and then tighten the cable.

After the battery cable is reconnected, it is possible that the vehicle may not operate in Electric Mode. If this happens, the high voltage battery may need to be charged.

## Electric Drive Unit Shift Lock Control Function Check

### WARNING

When you are doing this inspection, the vehicle could move suddenly. If the vehicle moves, you or others could be injured.

1. Before starting this check, be sure there is enough room around the vehicle. It should be parked on a level surface.

2. Firmly apply the parking brake. See *Electric Parking Brake* on page 9-30.

Be ready to apply the regular brake immediately if the vehicle begins to move.

3. With the vehicle off and the brake not applied, press and hold the POWER  button for more than five seconds to place the vehicle in Service Only Mode. See *Power Button* on page 9-16. Without applying the regular brake, try to move the shift lever out of P (Park) with normal effort. If the shift lever moves out of P (Park), contact your dealer for service.

## Park Brake and P (Park) Mechanism Check

### WARNING

When you are doing this check, the vehicle could begin to move. You or others could be injured and property could be damaged. Make sure there is room in front of the vehicle in case it begins to roll. Be ready to apply the regular brake at once should the vehicle begin to move.

Park on a fairly steep hill, with the vehicle facing downhill. Keeping your foot on the regular brake, set the electric parking brake.

- To check the electric parking brake's holding ability: With the propulsion system active and the electric drive unit in N (Neutral), slowly remove foot pressure from the regular brake pedal. Do this until the vehicle is held by the electric parking brake only.

- To check the P (Park) mechanism's holding ability: With the propulsion system active, shift to P (Park). Then release the electric parking brake followed by the regular brake.

Contact your dealer if service is required.

## Wiper Blade Replacement

Windshield wiper blades should be inspected for wear and cracking. See the *Maintenance Schedule* on page 11-2.

Replacement blades come in different types and are removed in different ways. For proper type and length, see *Maintenance Replacement Parts* on page 11-13.

**Notice:** Allowing the wiper arm to touch the windshield when no wiper blade is installed could damage the windshield. Any damage that occurs would not be

**covered by your warranty. Do not allow the wiper arm to touch the windshield.**

To replace the windshield wiper blade:

1. Pull the windshield wiper assembly away from the windshield.

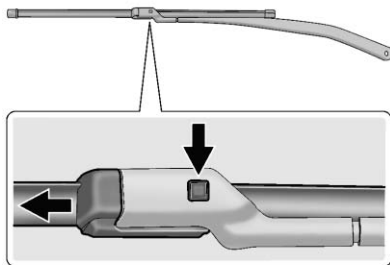

2. Press the button in the middle of the wiper arm connector, and pull the wiper blade away from the arm connector.
3. Remove the wiper blade.

4. Reverse Steps 1–3 for wiper blade replacement.

## Headlamp Aiming

Headlamp aim has been preset and should need no further adjustment.

If the vehicle is damaged in a crash, the headlamp aim may be affected. If adjustment to the headlamps is necessary, see your dealer.



## Bulb Replacement

For the proper type of replacement bulbs, see *Replacement Bulbs* on page 10-29.

For any bulb-changing procedure not listed in this section, contact your dealer.

## Halogen Bulbs

**⚠ WARNING**

Halogen bulbs have pressurized gas inside and can burst if you drop or scratch the bulb. You or others could be injured. Be sure to read and follow the instructions on the bulb package.

## LED Lighting

This vehicle has several LED lamps. For replacement of any LED lighting assembly, contact your dealer.

## Headlamps

### Driver Side Headlamps

To replace the high/low-beam headlamp:

1. Open the hood. See *Hood* on page 10-6.

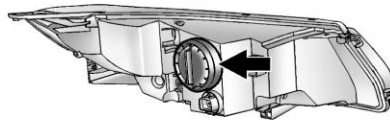

2. Remove the cover from the back of the headlamp assembly by turning it counterclockwise.
3. Remove the bulb socket from the headlamp assembly by turning it counterclockwise.
4. Remove the bulb from the socket.
5. Install the new bulb in the socket.

6. Install the bulb socket by turning it clockwise.
7. Install the cover in the back of the headlamp assembly by turning it clockwise.

### Passenger Side Headlamps

To replace the high/low-beam headlamp:

1. Open the hood. See *Hood* on page 10-6.

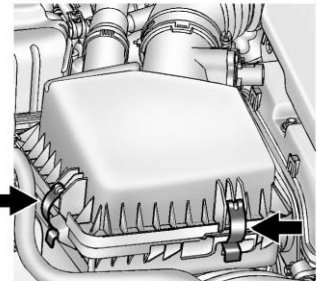

2. Remove the air cleaner cover. See *Engine Air Cleaner/Filter* on page 10-12.

3. Remove the air cleaner assembly by pulling up to release the rear two retention posts from the securing grommets. Then pull it forward to remove the remaining retention post from the securing grommet.

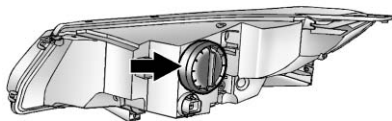

4. Remove the cover from the back of the headlamp assembly by turning it counterclockwise.
5. Remove the bulb from the headlamp assembly by turning it counterclockwise.
6. Disconnect the bulb from the wiring harness connector.
7. Install the new bulb in the headlamp assembly by turning it clockwise.

8. Reconnect the wiring harness connector.
9. Install the cover on the back of the headlamp assembly by turning it clockwise.
10. Install the air cleaner assembly by lowering the three retention posts into the grommets.
11. Install the engine air cleaner/filter assembly cover. See *Engine Air Cleaner/Filter* on page 10-12.

### Back-Up Lamps

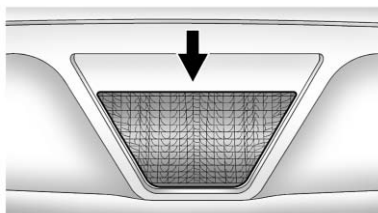

The back-up lamp is in the rear fascia.

To replace a bulb:

1. Remove the three inboard screws from the aero panel located under the rear fascia.
2. Push up on the aero panel to locate the bulb socket.
3. Turn the bulb socket counterclockwise to remove it from the bulb assembly.
4. Pull the bulb from the bulb socket.
5. Push a new bulb straight into the bulb socket.
6. Reinstall the bulb socket by lining up the tabs in the lamp assembly and turn it clockwise to lock it into place.
7. Replace the three inboard screws from the aero panel.

## License Plate Lamp

To replace one of these bulbs:

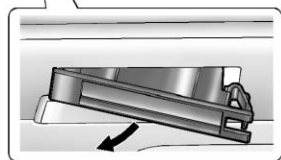

1. Press the spring clip on the right end of the lamp assembly to the left to unlock the lamp assembly.
2. Pull down on the lamp assembly to remove it from the fascia.

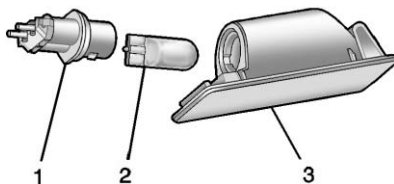

3. Turn the bulb socket (1) counterclockwise to remove it from the lamp assembly (3).
4. Pull the bulb (2) straight out of the bulb socket (1).
5. Push the replacement bulb straight into the bulb socket (1) and turn the bulb socket (1) clockwise to install it into the lamp assembly (3).
6. Reinstall the lamp assembly (3) into the fascia by inserting the left side first.

7. Push the spring clip side into place.

## Replacement Bulbs

Exterior Lamp	Bulb Number
Back-Up Lamps	3157K
High/Low-Beam Headlamps	HIR2 (9012)
License Plate Lamps	W5W LL

For replacement bulbs not listed here, contact your dealer.

## Electrical System

### High Voltage Devices and Wiring

 **WARNING**

Exposure to high voltage can cause shock, burns, and even death. The high voltage components in the vehicle can only be serviced by technicians with special training.

High voltage components are identified by labels. Do not remove, open, take apart, or modify these components. High voltage cable or wiring has orange covering. Do not probe, tamper with, cut, or modify high voltage cable or wiring.

### Electrical System Overload

The vehicle has fuses and circuit breakers to protect against an electrical system overload.

When the current electrical load is too heavy, the circuit breaker opens and closes, protecting the circuit until the current load returns to normal or the problem is fixed. This greatly reduces the chance of circuit overload and fire caused by electrical problems.

Fuses and circuit breakers protect the following in the vehicle:

- Headlamp Wiring
- Windshield Wiper Motor
- Power Windows and other Power Accessories

Replace a bad fuse with a new one of the identical size and rating.

If there is a problem on the road and a fuse needs to be replaced, the same amperage fuse can be

borrowed. Choose some feature of the vehicle that is not needed to use and replace it as soon as possible.

### Headlamp Wiring

An electrical overload may cause the lamps to go on and off, or in some cases to remain off. Have the headlamp wiring checked right away if the lamps go on and off or remain off.

### Windshield Wipers

If the wiper motor overheats due to heavy snow or ice, the windshield wipers will stop until the motor cools and the wiper control is turned off. After removal of the blockage, the wiper motor will restart when the control is then moved to the desired operating position.

Although the circuit is protected from electrical overload, overload due to heavy snow or ice, may cause wiper linkage damage. Always clear ice and heavy snow from the windshield before using the windshield wipers.

If the overload is caused by an electrical problem and not snow or ice, be sure to get it fixed.

## Engine Compartment Fuse Block

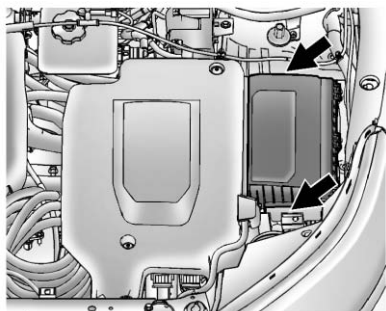

To open the fuse block cover, press the clips at the front and back and rotate the cover up to the side.

**Notice:** Spilling liquid on any electrical component on the vehicle may damage it. Always keep the covers on any electrical component.

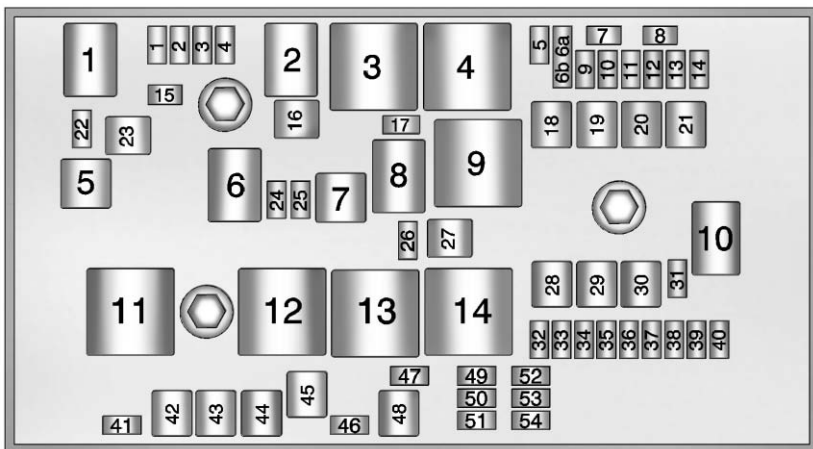

Engine Compartment Fuse Block

A fuse puller is in the engine compartment fuse block.

The vehicle may not be equipped with all of the fuses, relays, and features shown.

Mini Fuses	Usage
1	Engine Control Module – Switched Power
2	Emissions
3	Not Used

## 10-32 Vehicle Care

Mini Fuses	Usage
4	Ignition Coils/ Injectors
5	Not Used
6a	Empty
6b	Rear Defogger
7	Empty
8	Empty
9	Heated Mirrors
10	Air Conditioning Control Module
11	Traction Power Inverter Module – Battery
12	Not Used
13	Cabin Heater Pump and Valve
14	Not Used

Mini Fuses	Usage
15	Traction Power Inverter Module and Transmission Control Module – Battery
17	Engine Control Module – Battery
22	Left High -Beam Headlamp
24	Empty
25	Empty
26	Not Used
31	Not Used
32	Run/Crank – Sensing Diagnostic Module (SDM), Instrument Cluster, Passenger Airbag Display, Automatic Dimming Inside Rearview Mirror (If Equipped)

Mini Fuses	Usage
33	Run/Crank for Vehicle Integration Control Module
34	Vehicle Integration Control Module – Battery
35	Not Used
36	Power Electronics Coolant Pump
37	Cabin Heater Control Module
38	Rechargeable Energy Storage System (High Voltage Battery) Coolant Pump
39	Rechargeable Energy Storage System (High Voltage Battery) Control Module
40	Front Windshield Washer

Mini Fuses	Usage
41	Right High-Beam Headlamp
46	Empty
47	Empty
49	Empty
50	Run/Crank – Rear Vision Camera, Accessory Power Module
51	Run/Crank for ABS/ Rechargeable Energy Storage System (High Voltage Battery)
52	Engine Control Module/ Transmission Control Module – Run/Crank
53	Traction Power Inverter Module – Run/Crank

Mini Fuses	Usage
54	Run/Crank – Fuel System Control Module, Air Conditioning Control Module, On Board Charger

J-Case Fuses	Usage
16	AIR Solenoid (PZEV Only)
18	Empty
19	Power Window – Front
20	Empty
21	Antilock Brake System Electronic Control Unit
23	Charge Port Door
27	AIR Pump (PZEV Only)
28	Empty

J-Case Fuses	Usage
29	Empty
30	Antilock Brake System Motor
42	Cooling Fan – Right
43	Front Wipers
44	Charger
45	Empty
48	Cooling Fan – Left

Mini Relays	Usage
3	Powertrain
4	Heated Mirrors
7	Empty
9	AIR Pump (PZEV Only)
11	Empty
12	Empty
13	Empty

## 10-34 Vehicle Care

Mini Relays	Usage
14	Run/Crank

Micro Relays	Usage
1	Empty
2	AIR Solenoid (PZEV Only)
6	Empty
8	Empty
10	Empty

Ultra Micro Relays	Usage
5	Charge Port Door

### Instrument Panel Fuse Block (Left Side)

The left instrument panel fuse block is on the left side end of the instrument panel. To access the fuses, open the fuse panel door by pulling out.

To reinstall the door, insert the bottom tab first, then push the door back into its original location.

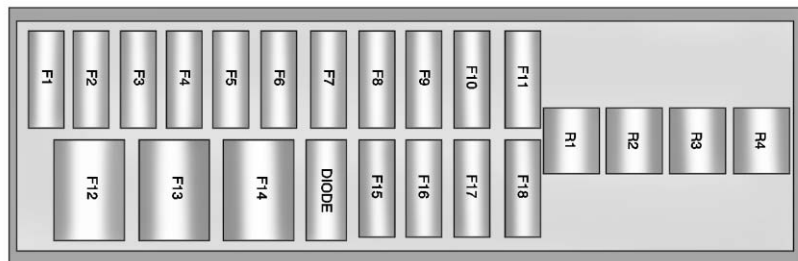

Instrument Panel Fuse Block

A fuse puller is in the engine compartment fuse block.

The vehicle may not be equipped with all of the fuses, relays, and features shown.

Fuses	Usage
F1	Power Outlet – Top of IP Storage Bin
F2	Radio
F3	Instrument Cluster



Fuses	Usage
F4	Infotainment Display
F5	Heating, Ventilation & Air Conditioning/ Integrated Center Stack Switches
F6	Airbag (Sensing Diagnostic Module/ Passenger Sensing Module)
F7	Data Link Connector, Left (Primary)
F8	Empty
F9	OnStar
F10	Body Control Module 1/Body Control Module Electronics/Keyless Entry/Power Moding/ Center High Mounted Stoplamp/ License Plate Lamps/Left Daytime Running Lamp/Left

Fuses	Usage
	Parking Lamps/ Hatch Release Relay Control/ Washer Pump Relay Control/Switch Indicator Lights
F11	Body Control Module 4/Left Headlamp
F12	Empty
F13	Empty
F14	Empty
F15	Power Outlet (Inside Floor Console/Rear of Floor Console)
F16	Empty
F17	Empty
F18	Empty

Relays	Usage
R1	Retained Accessory Power Relay for Power Outlets
R2	Empty
R3	Empty
R4	Empty

Diodes	Usage
DIODE	Empty

### Instrument Panel Fuse Block (Right Side)

The right instrument panel fuse block is on the right side end of the instrument panel. To access the fuses, open the fuse panel door by pulling out.

To reinstall the door, insert the bottom tab first, then push the door back into its original location.

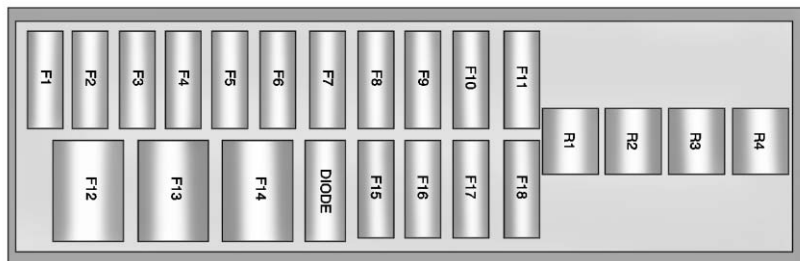
**Instrument Panel Fuse Block**

A fuse puller is in the engine compartment fuse block.

The vehicle may not be equipped with all of the fuses, relays, and features shown.

Fuses	Usage
F1	Steering Wheel Switch Backlighting
F2	Empty
F3	Empty

Fuses	Usage
F4	Body Control Module 3/Right Headlamp
F5	Body Control Module 2/Body Control Module Electronics/Hatch Lamp/Right Daytime Running Lamp/Shifter Lock/Switch Backlighting

Fuses	Usage
F6	Body Control Module 5/Retained Accessory Power Relay Control/Right Front Turn Signal Lamp/Left Rear Stop and Turn Signal Lamp/Right Parking Lamps/Remote PRNDL
F7	Body Control Module 6/Map Lights/Courtesy Lights/Back-up Lamp
F8	Body Control Module 7/Left Front Turn Signal/Right Rear Stop and Turn Signal Lamp/Child Security Lock Relay Control
F9	Body Control Module 8/Locks

<b>Fuses</b>	<b>Usage</b>
F10	Data Link Connector, Right (Secondary)
F11	Universal Garage Door Opener (If Equipped)
F12	Blower Motor
F13	Empty
F14	Empty
F15	Empty
F16	Empty
F17	Empty
F18	Empty

<b>Relays</b>	<b>Usage</b>
R1	Empty
R2	Empty
R3	Empty
R4	Child Lockout Relay

<b>Diodes</b>	<b>Usage</b>
DIODE	Empty

## Rear Compartment Fuse Block

The rear compartment fuse block is on the left side of the rear compartment behind a removable cover. Open the latch to remove the cover and access the fuse block.



A fuse puller is in the engine compartment fuse block.

The vehicle may not have all of the fuses, relays, and features shown.

Fuses	Usage
F1	Empty

Fuses	Usage
F2	Fuel System Control Module
F3	Passive Start/ Passive Entry Module
F4	Heated Seats (If Equipped)
F5	Driver Door Switches (Outside Rearview Mirror/ Charge Port Door Release/Refuel Request/Driver Window Switch)
F6	Fuel (Diurnal Valve and Evap. Leak Check Module)
F7	Accessory Power Module Cooling Fan
F8	Amplifier (If Equipped)
F9	Empty

Fuses	Usage
F10	Regulated Voltage Control/Ultrasonic Front and Rear Parking Assist (If Equipped)
F11	Horn
F12	Rear Power Windows
F13	Electric Parking Brake
F14	Rear Defog (Upper Grid)
F15	Empty
F16	Hatch Release
F17	Empty
F18	Empty

Relays	Usage
R1	Rear Defog (Upper Grid)
R2	Hatch Release
R3	Empty
R4	Empty
R5	Empty
R6	Empty
R7/R8	Horn

Diodes	Usage
DIODE	Empty

## Wheels and Tires

### Tires

Every new GM vehicle has high-quality tires made by a leading tire manufacturer. See the warranty manual for information regarding the tire warranty and where to get service. For additional information refer to the tire manufacturer.

#### WARNING

- Poorly maintained and improperly used tires are dangerous.
- Overloading the tires can cause overheating as a result of too much flexing. There could be a blowout

(Continued)

**WARNING (Continued)**

and a serious crash. See *Vehicle Load Limits on page 9-11*.

- Underinflated tires pose the same danger as overloaded tires. The resulting crash could cause serious injury. Check all tires frequently to maintain the recommended pressure. Tire pressure should be checked when the tires are cold.
- Overinflated tires are more likely to be cut, punctured, or broken by a sudden impact — such as when hitting a pothole. Keep tires at the recommended pressure.

(Continued)

**WARNING (Continued)**

- Worn or old tires can cause a crash. If the tread is badly worn, replace them.
- Replace any tires that have been damaged by impacts with potholes, curbs, etc.
- Improperly repaired tires can cause a crash. Only the dealer or an authorized tire service center should repair, replace, dismount, and mount the tires.
- Do not spin the tires in excess of 56 km/h (35 mph) on slippery surfaces such as snow, mud, ice, etc. Excessive spinning may cause the tires to explode.

**All-Season Tires**

This vehicle may come with all-season tires. These tires are designed to provide good overall performance on most road surfaces and weather conditions. Original equipment tires designed to GM's specific tire performance criteria have a TPC specification code molded onto the sidewall. Original equipment all-season tires can be identified by the last two characters of this TPC code, which will be "MS."

Consider installing winter tires on the vehicle if frequent driving on snow or ice-covered roads is expected. All-season tires provide adequate performance for most winter driving conditions, but they may not offer the same level of traction or performance as winter tires on snow or ice-covered roads. See *Winter Tires on page 10-41*.

## Winter Tires

This vehicle was not, originally, equipped with winter tires. Winter tires are designed for increased traction on snow and ice-covered roads. Consider installing winter tires on the vehicle if frequent driving on snow or ice-covered roads is expected. See your dealer for details regarding winter tire availability and proper tire selection. Also, see *Buying New Tires* on page 10-53.

With winter tires, there may be decreased dry road traction, increased road noise, and shorter tread life. After changing to winter tires, be alert for changes in vehicle handling and braking.

If using winter tires:

- Use tires of the same brand and tread type on all four wheel positions.

- Use only radial ply tires of the same size, load range, and speed rating as the original equipment tires.

Winter tires with the same speed rating as the original equipment tires may not be available for H, V, W, Y, and ZR speed rated tires. If winter tires with a lower speed rating are chosen, never exceed the tire's maximum speed capability.

## Summer Tires

This vehicle may come with high performance summer tires. These tires have a special tread and compound that are optimized for maximum dry and wet road performance. This special tread and compound will decrease performance in cold climates, and on ice and snow. We recommend installing winter tires on the vehicle if frequent driving in cold temperatures or on snow or ice covered roads is expected. See *Winter Tires* on page 10-41.

## Tire Sidewall Labeling

Useful information about a tire is molded into its sidewall. The examples show a typical passenger tire sidewall.

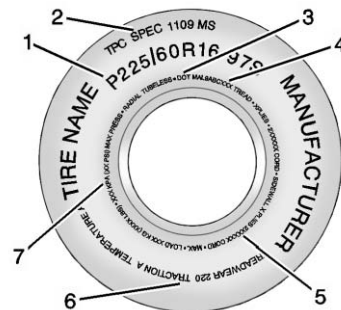

### Passenger (P-Metric) Tire Example

**(1) Tire Size:** The tire size is a combination of letters and numbers used to define a particular tire's width, height, aspect ratio, construction type, and service description. See the "Tire Size" illustration later in this section for more detail.

### (2) TPC Spec (Tire Performance Criteria Specification):

Original equipment tires designed to GM's specific tire performance criteria have a TPC specification code molded onto the sidewall. GM's TPC specifications meet or exceed all federal safety guidelines.

### (3) DOT (Department of Transportation):

The Department of Transportation (DOT) code indicates that the tire is in compliance with the U.S. Department of Transportation Motor Vehicle Safety Standards.

### DOT Tire Date of

**Manufacture:** The last four digits of the TIN indicate the tire manufactured date. The first two digits represent the week (01-52) and the last two digits, the year. For example, the third

week of the year 2010 would have a four-digit DOT date of 0310.

### (4) Tire Identification Number (TIN):

The letters and numbers following the DOT code are the Tire Identification Number (TIN). The TIN shows the manufacturer and plant code, tire size, and date the tire was manufactured. The TIN is molded onto both sides of the tire, although only one side may have the date of manufacture.

**(5) Tire Ply Material:** The type of cord and number of plies in the sidewall and under the tread.

### (6) Uniform Tire Quality Grading (UTQG):

Tire manufacturers are required to grade tires based on three performance factors: treadwear, traction, and temperature

resistance. For more information see *Uniform Tire Quality Grading on page 10-56*.

**(7) Maximum Cold Inflation Load Limit:** Maximum load that can be carried and the maximum pressure needed to support that load.

## Tire Designations

### Tire Size

The following is an example of a typical passenger vehicle tire size.

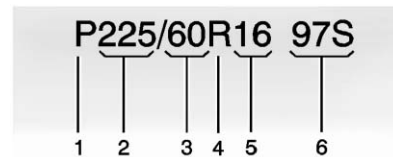

### (1) Passenger (P-Metric) Tire:

The United States version of a metric tire sizing system. The letter P as the first character in



the tire size means a passenger vehicle tire engineered to standards set by the U.S. Tire and Rim Association.

**(2) Tire Width:** The three-digit number indicates the tire section width in millimeters from sidewall to sidewall.

**(3) Aspect Ratio:** A two-digit number that indicates the tire height-to-width measurements. For example, if the tire size aspect ratio is 60, as shown in item 3 of the illustration, it would mean that the tire's sidewall is 60 percent as high as it is wide.

**(4) Construction Code:** A letter code is used to indicate the type of ply construction in the tire. The letter R means radial ply construction; the letter D means diagonal or bias ply construction; and the letter B means belted-bias ply construction.

**(5) Rim Diameter:** Diameter of the wheel in inches.

**(6) Service Description:** These characters represent the load index and speed rating of the tire. The load index represents the load carrying capacity a tire is certified to carry. The speed rating is the maximum speed a tire is certified to carry a load.

### Tire Terminology and Definitions

**Air Pressure:** The amount of air inside the tire pressing outward on each square inch of the tire. Air pressure is expressed in kPa (kilopascal) or psi (pounds per square inch).

**Accessory Weight:** The combined weight of optional accessories. Some examples of optional accessories are, electric

drive unit, power steering, power brakes, power windows, power seats, and air conditioning.

**Aspect Ratio:** The relationship of a tire's height to its width.

**Belt:** A rubber coated layer of cords that is located between the plies and the tread. Cords may be made from steel or other reinforcing materials.

**Bead:** The tire bead contains steel wires wrapped by steel cords that hold the tire onto the rim.

**Bias Ply Tire:** A pneumatic tire in which the plies are laid at alternate angles less than 90 degrees to the centerline of the tread.

**Cold Tire Pressure:** The amount of air pressure in a tire, measured in kPa (kilopascal) or psi (pounds per square inch)

before a tire has built up heat from driving. See *Tire Pressure* on page 10-46.

**Curb Weight:** The weight of a motor vehicle with standard and optional equipment including the maximum capacity of fuel, oil, and coolant, but without passengers and cargo.

**DOT Markings:** A code molded into the sidewall of a tire signifying that the tire is in compliance with the U.S. Department of Transportation (DOT) Motor Vehicle Safety Standards. The DOT code includes the Tire Identification Number (TIN), an alphanumeric designator which can also identify the tire manufacturer, production plant, brand, and date of production.

**GVWR:** Gross Vehicle Weight Rating. See *Vehicle Load Limits* on page 9-11.

**GAWR FRT:** Gross Axle Weight Rating for the front axle. See *Vehicle Load Limits* on page 9-11.

**GAWR RR:** Gross Axle Weight Rating for the rear axle. See *Vehicle Load Limits* on page 9-11.

**Intended Outboard Sidewall:** The side of an asymmetrical tire, that must always face outward when mounted on a vehicle.

**Kilopascal (kPa):** The metric unit for air pressure.

**Light Truck (LT-Metric) Tire:** A tire used on light duty trucks and some multipurpose passenger vehicles.

**Load Index:** An assigned number ranging from 1 to 279 that corresponds to the load carrying capacity of a tire.

**Maximum Inflation Pressure:** The maximum air pressure to which a cold tire can be inflated. The maximum air pressure is molded onto the sidewall.

**Maximum Load Rating:** The load rating for a tire at the maximum permissible inflation pressure for that tire.

**Maximum Loaded Vehicle Weight:** The sum of curb weight, accessory weight, vehicle capacity weight, and production options weight.

**Normal Occupant Weight:** The number of occupants a vehicle is designed to seat multiplied by 68 kg (150 lbs). See *Vehicle Load Limits* on page 9-11.

**Occupant Distribution:** Designated seating positions.

**Outward Facing Sidewall:** The side of an asymmetrical tire that has a particular side that faces

outward when mounted on a vehicle. The side of the tire that contains a whitewall, bears white lettering, or bears manufacturer, brand, and/or model name molding that is higher or deeper than the same moldings on the other sidewall of the tire.

**Passenger (P-Metric) Tire:** A tire used on passenger cars and some light duty trucks and multipurpose vehicles.

**Recommended Inflation Pressure:** Vehicle manufacturer's recommended tire inflation pressure as shown on the tire placard. See *Tire Pressure on page 10-46* and *Vehicle Load Limits on page 9-11*.

**Radial Ply Tire:** A pneumatic tire in which the ply cords that extend to the beads are laid at 90 degrees to the centerline of the tread.

**Rim:** A metal support for a tire and upon which the tire beads are seated.

**Sidewall:** The portion of a tire between the tread and the bead.

**Speed Rating:** An alphanumeric code assigned to a tire indicating the maximum speed at which a tire can operate.

**Traction:** The friction between the tire and the road surface. The amount of grip provided.

**Tread:** The portion of a tire that comes into contact with the road.

**Treadwear Indicators:** Narrow bands, sometimes called wear bars, that show across the tread

of a tire when only 1.6 mm (1/16 in) of tread remains. See *When It Is Time for New Tires on page 10-53*.

**UTQGS (Uniform Tire Quality Grading Standards):** A tire information system that provides consumers with ratings for a tire's traction, temperature, and treadwear. Ratings are determined by tire manufacturers using government testing procedures. The ratings are molded into the sidewall of the tire. See *Uniform Tire Quality Grading on page 10-56*.

**Vehicle Capacity Weight:** The number of designated seating positions multiplied by 68 kg (150 lbs) plus the rated cargo load. See *Vehicle Load Limits on page 9-11*.

**Vehicle Maximum Load on the Tire:** Load on an individual tire due to curb weight, accessory weight, occupant weight, and cargo weight.

**Vehicle Placard:** A label permanently attached to a vehicle showing the vehicle's capacity weight and the original equipment tire size and recommended inflation pressure. See "Tire and Loading Information Label" under *Vehicle Load Limits on page 9-11*.

### Tire Pressure

Tires need the correct amount of air pressure to operate effectively.

**Notice:** Neither tire underinflation nor overinflation is good. Underinflated tires, or tires that do not have enough air, can result in:

- Tire overloading and overheating which could lead to a blowout.
- Premature or irregular wear.
- Poor handling.
- Reduced fuel economy.

Overinflated tires, or tires that have too much air, can result in:

- Unusual wear.
- Poor handling.
- Rough ride.
- Needless damage from road hazards.

The Tire and Loading Information label on the vehicle indicates the original equipment tires and the correct cold tire inflation pressures. The recommended pressure is the minimum air pressure needed to support the vehicle's maximum load carrying capacity.

For additional information regarding how much weight the vehicle can carry, and an example of the Tire and Loading Information label, see *Vehicle Load Limits on page 9-11*. How the vehicle is loaded affects vehicle handling and ride comfort. Never load the vehicle with more weight than it was designed to carry.

### When to Check

Check the tires once a month or more.

## How to Check

Use a good quality pocket-type gauge to check the tire pressure. Proper tire inflation cannot be determined by looking at the tire. Check the tire inflation pressure when the tires are cold, meaning the vehicle has not been driven for at least three hours or no more than 1.6 km (1 mi).

Remove the valve cap from the tire valve stem. Press the tire gauge firmly onto the valve to get the pressure measurement. If the cold tire inflation pressure matches the recommended pressure on the Tire and Loading Information label, no further adjustment is necessary.

If the inflation pressure is low, add air until the recommended pressure is reached. If the inflation pressure is high, press on the metal stem in the center

of the tire valve to release air. Re-check the tire pressure with the tire gauge.

Return the valve caps on the valve stems to keep out dirt and moisture and prevent leaks.

## Tire Pressure Monitor System

The Tire Pressure Monitor System (TPMS) uses radio and sensor technology to check tire pressure levels. The TPMS sensors monitor the air pressure in your tires and transmit tire pressure readings to a receiver located in the vehicle.

Each tire, including the spare (if provided), should be checked monthly when cold and inflated to the inflation pressure recommended by the vehicle manufacturer on the vehicle placard or tire inflation pressure label. (If your vehicle has tires of a different size than the size indicated on the vehicle placard or

tire inflation pressure label, you should determine the proper tire inflation pressure for those tires.)

As an added safety feature, your vehicle has been equipped with a tire pressure monitoring system (TPMS) that illuminates a low tire pressure telltale when one or more of your tires is significantly under-inflated.

Accordingly, when the low tire pressure telltale illuminates, you should stop and check your tires as soon as possible, and inflate them to the proper pressure. Driving on a significantly under-inflated tire causes the tire to overheat and can lead to tire failure. Under-inflation also reduces fuel efficiency and tire tread life, and may affect the vehicle's handling and stopping ability.

Please note that the TPMS is not a substitute for proper tire maintenance, and it is the driver's responsibility to maintain correct tire pressure, even if under-inflation has

not reached the level to trigger illumination of the TPMS low tire pressure telltale.

Your vehicle has also been equipped with a TPMS malfunction indicator to indicate when the system is not operating properly. The TPMS malfunction indicator is combined with the low tire pressure telltale. When the system detects a malfunction, the telltale will flash for approximately one minute and then remain continuously illuminated. This sequence will continue upon subsequent vehicle start-ups as long as the malfunction exists.

When the malfunction indicator is illuminated, the system may not be able to detect or signal low tire pressure as intended. TPMS malfunctions may occur for a variety of reasons, including the installation of replacement or alternate tires or wheels on the vehicle that prevent the TPMS from functioning properly. Always check the TPMS malfunction telltale after replacing one or more tires or wheels on your vehicle to

ensure that the replacement or alternate tires and wheels allow the TPMS to continue to function properly.

See *Tire Pressure Monitor Operation* on page 10-48.

### **Federal Communications Commission (FCC) Rules and with Industry Canada Standards**

See *Radio Frequency Statement on page 13-15* for information regarding Part 15 of the Federal Communications Commission (FCC) Rules and with Industry Canada Standards RSS-GEN/210/220/310.

### **Tire Pressure Monitor Operation**

This vehicle may have a Tire Pressure Monitor System (TPMS). The TPMS is designed to warn the driver when a low tire pressure condition exists. TPMS sensors are mounted onto each tire and wheel assembly. The TPMS sensors

monitor the air pressure in the tires and transmit the tire pressure readings to a receiver located in the vehicle.



When a low tire pressure condition is detected, the TPMS illuminates the low tire pressure warning light located on the instrument cluster. If the warning light comes on, stop as soon as possible and inflate the tires to the recommended pressure shown on the Tire Loading and Information label. See *Vehicle Load Limits* on page 9-11.

A message to check the pressure in a specific tire displays in the Driver Information Center (DIC). The low tire pressure warning light and the DIC warning message come on at each drive cycle until the tires are inflated to the correct inflation

pressure. Using the DIC, tire pressure levels can be viewed. For additional information and details about the DIC operation and displays see *Driver Information Center (DIC) on page 5-41*.

The low tire pressure warning light may come on in cool weather when the vehicle is first started, and then turn off as the vehicle is driven. This could be an early indicator that the air pressure is getting low and needs to be inflated to the proper pressure.

A Tire and Loading Information label shows the size of the original equipment tires and the correct inflation pressure for the tires when they are cold. See *Vehicle Load Limits on page 9-11*, for an example of the Tire and Loading Information label and its location. Also see *Tire Pressure on page 10-46*.

The TPMS can warn about a low tire pressure condition but it does not replace normal tire maintenance. See *Tire Inspection*

*on page 10-51, Tire Rotation on page 10-52, and Tires on page 10-39.*

**Notice: Tire sealant materials are not all the same. A non-approved tire sealant could damage the TPMS sensors. TPMS sensor damage caused by using an incorrect tire sealant is not covered by the vehicle warranty. Always use only the GM-approved tire sealant available through your dealer or included in the vehicle.**

Factory-installed Tire Inflator Kits use a GM-approved liquid tire sealant. Using non-approved tire sealants could damage the TPMS sensors. See *Tire Sealant and Compressor Kit on page 10-60* for information regarding the inflator kit materials and instructions.

## TPMS Malfunction Light and Message

The TPMS will not function properly if one or more of the TPMS sensors are missing or inoperable. When the system detects a malfunction, the low tire pressure warning light flashes for about one minute and then stays on for the remainder of the vehicle on/off cycle. A DIC warning message also displays. The malfunction light and DIC warning message come on at each vehicle on/off cycle until the problem is corrected. Some of the conditions that can cause these to come on are:

- One of the road tires has been replaced with the spare tire, if the vehicle has one. The spare tire does not have a TPMS sensor. The malfunction light and DIC message should go off after the road tire is replaced and the sensor matching process is performed

successfully. See "TPMS Sensor Matching Process" later in this section.

- The TPMS sensor matching process was started but not completed or not completed successfully after rotating the tires. The DIC message and malfunction light should go off once the TPMS sensor matching process is performed successfully. See "TPMS Sensor Matching Process" later in this section.
- One or more TPMS sensors are missing or damaged. The DIC message and the malfunction light should go off when the TPMS sensors are installed and the sensor matching process is performed successfully. See your dealer for service.
- Replacement tires or wheels do not match the original equipment tires or wheels. Tires and wheels other than those recommended

could prevent the TPMS from functioning properly. See *Buying New Tires on page 10-53*.

- Operating electronic devices or being near facilities using radio wave frequencies similar to the TPMS could cause the TPMS sensors to malfunction.

If the TPMS is not functioning properly, it cannot detect or signal a low tire condition. See your dealer for service if the TPMS malfunction light and DIC message come on and stay on.

### **TPMS Sensor Matching Process**

Each TPMS sensor has a unique identification code. The identification code needs to be matched to a new tire/wheel position after rotating the vehicle's tires or replacing one or more of the TPMS sensors. Also, the TPMS sensor matching process should be performed after replacing a spare tire with a road tire containing the TPMS sensor. The malfunction light and the DIC

message should go off at the next drive cycle. The sensors are matched to the tire/wheel positions, using a TPMS relearn tool, in the following order: driver side front tire, passenger side front tire, passenger side rear tire, and driver side rear. See your dealer for service or to purchase a relearn tool.

There are two minutes to match the first tire/wheel position, and five minutes overall to match all four tire/wheel positions. If it takes longer, the matching process stops and must be restarted.

Follow the TPMS sensor matching process:

1. Set the parking brake.
2. Put the vehicle in ON/RUN and place the vehicle in P (Park).
3. If the DIC display is minimized, press the SELECT knob to maximize it.
4. Use the SELECT knob to scroll to the Tire Pressure display screen.



5. Press and hold the SELECT knob for five seconds to begin the sensor matching process.  
A message displays confirming to begin the process.
6. Use the SELECT knob to select YES with the highlighted selection, and press the SELECT knob again to confirm the selection.  
The horn sounds twice to signal the receiver is in relearn mode and the TIRE LEARNING ACTIVE message displays on the DIC screen.
7. Start with the driver side front tire.
8. Place the relearn tool against the tire sidewall, near the valve stem. Then press the button to activate the TPMS sensor. A horn chirp confirms that the sensor identification code has been matched to this tire and wheel position.

9. Proceed to the passenger side front tire, and repeat the procedure in Step 8.
10. Proceed to the passenger side rear tire, and repeat the procedure in Step 8.
11. Proceed to the driver side rear tire, and repeat the procedure in Step 8. The horn sounds two times to indicate the sensor identification code has been matched to the driver side rear tire, and the TPMS sensor matching process is no longer active. The TIRE LEARNING ACTIVE message on the DIC display screen goes off.
12. Turn the vehicle off.
13. Set all four tires to the recommended air pressure level as indicated on the Tire and Loading Information label.

## Tire Inspection

We recommend that the tires, including the spare tire, if the vehicle has one, be inspected for signs of wear or damage at least once a month.

Replace the tire if:

- The indicators at three or more places around the tire can be seen.
- There is cord or fabric showing through the tire's rubber.
- The tread or sidewall is cracked, cut, or snagged deep enough to show cord or fabric.
- The tire has a bump, bulge, or split.

## 10-52 Vehicle Care

- The tire has a puncture, cut, or other damage that cannot be repaired well because of the size or location of the damage.

### Tire Rotation

Tires should be rotated every 12 000 km (7,500 mi). The first rotation is the most important. See *Maintenance Schedule* on page 11-2.

Tires are rotated to achieve a more uniform wear for all tires.

Anytime unusual wear is noticed, rotate the tires as soon as possible, check for proper tire inflation pressure, and check for damaged tires or wheels. If the unusual wear continues after the rotation, check the wheel alignment. See *When It Is Time for New Tires* on page 10-53 and *Wheel Replacement* on page 10-57.

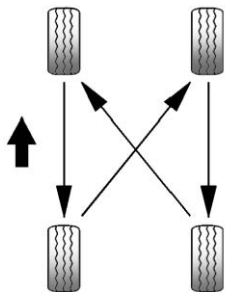

Use this rotation pattern when rotating the tires.

Adjust the front and rear tires to the recommended inflation pressure on the Tire and Loading Information label after the tires have been rotated. See *Tire Pressure* on page 10-46 and *Vehicle Load Limits* on page 9-11.

Reset the Tire Pressure Monitor System. See *Tire Pressure Monitor Operation* on page 10-48.

Check that all wheel nuts are properly tightened. See “Wheel Nut Torque” under *Capacities and Specifications* on page 12-2.

#### WARNING

Rust or dirt on a wheel, or on the parts to which it is fastened, can make wheel nuts become loose after a time. The wheel could come off and cause a crash. When changing a wheel, remove any rust or dirt from places where the wheel attaches to the vehicle. In an emergency, a cloth or a paper towel can be used, however, use a scraper or wire brush to remove all rust or dirt.

Lightly coat the center of the wheel hub with wheel bearing grease after a wheel change or

tire rotation to prevent corrosion or rust build-up. Do not get grease on the flat wheel mounting surface or on the wheel nuts or bolts.

## When It Is Time for New Tires

Factors such as maintenance, temperatures, driving speeds, vehicle loading, and road conditions affect the wear rate of the tires.

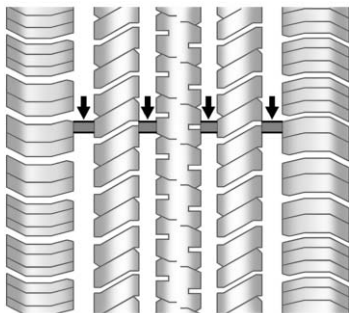

Treadwear indicators are one way to tell when it is time for new tires.

Treadwear indicators appear when the tires have only 1.6 mm (1/16 in) or less of tread remaining. See *Tire Inspection on page 10-51* and *Tire Rotation on page 10-52*.

The rubber in tires ages over time. This also applies to the spare tire, if the vehicle has one, even if it is never used. Multiple factors including temperatures, loading conditions, and inflation pressure maintenance affect how fast aging takes place. GM recommends that tires, including the spare if equipped, be replaced after six years, regardless of tread wear. The tire manufacturer date is the last four digits of the DOT Tire Identification Number (TIN) which is molded into one side of the tire sidewall. The first two digits represent the week (01–52) and the last two digits, the year. For example, the third week of the year 2010 would have a four-digit DOT date of 0310.

## Vehicle Storage

Tires age when stored normally mounted on a parked vehicle. Park a vehicle that will be stored for at least a month in a cool, dry, clean area away from direct sunlight to slow aging. This area should be free of grease, gasoline, or other substances that can deteriorate rubber.

Parking for an extended period can cause flat spots on the tires that may result in vibrations while driving. When storing a vehicle for at least a month, remove the tires or raise the vehicle to reduce the weight from the tires.

## Buying New Tires

GM has developed and matched specific tires for the vehicle. The original equipment tires installed were designed to meet General Motors Tire Performance Criteria Specification (TPC Spec) system rating. When

replacement tires are needed, GM strongly recommends buying tires with the same TPC Spec rating.

GM's exclusive TPC Spec system considers over a dozen critical specifications that impact the overall performance of the vehicle, including brake system performance, ride and handling, traction control, and tire pressure monitoring performance. GM's TPC Spec number is molded onto the tire's sidewall near the tire size. If the tires have an all-season tread design, the TPC spec number will be followed by MS, for mud and snow. See *Tire Sidewall Labeling on page 10-41*.

GM recommends replacing worn tires in complete sets of four. Uniform tread depth on all tires will help to maintain the performance of the vehicle.

Braking and handling performance may be adversely affected if all the tires are not replaced at the same time. If proper rotation and maintenance have been done, all four tires should wear out at about the same time. See *Tire Rotation on page 10-52* for information on proper tire rotation. However, if it is necessary to replace only one axle set of worn tires, place the new tires on the rear axle.

Winter tires with the same speed rating as the original equipment tires may not be available for H, V, W, Y, and ZR speed rated tires. Never exceed the winter tire's maximum speed capability when using winter tires with a lower speed rating.

### WARNING

Tires could explode during improper service. Attempting to mount or dismount a tire could cause injury or death. Only your dealer or authorized tire service center should mount or dismount the tires.

### WARNING

Mixing tires of different sizes, brands, or types may cause loss of control of the vehicle, resulting in a crash or other vehicle damage. Use the correct size, brand, and type of tire on all wheels.

**⚠ WARNING**

Using bias-ply tires on the vehicle may cause the wheel rim flanges to develop cracks after many miles of driving. A tire and/or wheel could fail suddenly and cause a crash. Use only radial-ply tires with the wheels on the vehicle.

If the vehicle tires must be replaced with a tire that does not have a TPC Spec number, make sure they are the same size, load range, speed rating, and construction (radial) as the original tires.

Vehicles that have a tire pressure monitoring system could give an inaccurate low-pressure warning if non-TPC Spec rated tires are installed. See *Tire Pressure Monitor System* on page 10-47.

The Tire and Loading Information Label indicates the original equipment tires on the vehicle. See *Vehicle Load Limits* on page 9-11, for the label location and more information about the Tire and Loading Information label.

**Different Size Tires and Wheels**

If wheels or tires are installed that are a different size than the original equipment wheels and tires, vehicle performance, including its braking, ride and handling characteristics, stability, and resistance to rollover may be affected. If the vehicle has electronic systems such as antilock brakes, rollover airbags, traction control, electronic stability control, or All-Wheel Drive, the performance of these systems can also be affected.

**⚠ WARNING**

If different sized wheels are used, there may not be an acceptable level of performance and safety if tires not recommended for those wheels are selected. This increases the chance of a crash and serious injury. Only use GM specific wheel and tire systems developed for the vehicle, and have them properly installed by a GM certified technician.

See *Buying New Tires* on page 10-53 and *Accessories and Modifications* on page 10-2.

## Uniform Tire Quality Grading

Quality grades can be found where applicable on the tire sidewall between tread shoulder and maximum section width. For example:

### Treadwear 200 Traction AA Temperature A

The following information relates to the system developed by the United States National Highway Traffic Safety Administration (NHTSA), which grades tires by treadwear, traction, and temperature performance. This applies only to vehicles sold in the United States. The grades are molded on the sidewalls of most passenger car tires. The Uniform Tire Quality Grading (UTQG) system does not apply to deep tread, winter tires, compact spare tires, tires with

nominal rim diameters of 10 to 12 inches (25 to 30 cm), or to some limited-production tires.

While the tires available on General Motors passenger cars and light trucks may vary with respect to these grades, they must also conform to federal safety requirements and additional General Motors Tire Performance Criteria (TPC) standards.

All Passenger Car Tires Must Conform to Federal Safety Requirements In Addition To These Grades.

### Treadwear

The treadwear grade is a comparative rating based on the wear rate of the tire when tested under controlled conditions on a specified government test course. For example, a tire

graded 150 would wear one and one-half (1½) times as well on the government course as a tire graded 100. The relative performance of tires depends upon the actual conditions of their use, however, and may depart significantly from the norm due to variations in driving habits, service practices and differences in road characteristics and climate.

### Traction – AA, A, B, C

The traction grades, from highest to lowest, are AA, A, B, and C. Those grades represent the tire's ability to stop on wet pavement as measured under controlled conditions on specified government test surfaces of asphalt and concrete. A tire marked C may have poor traction performance. Warning: The traction grade assigned to this tire is based on

straight-ahead braking traction tests, and does not include acceleration, cornering, hydroplaning, or peak traction characteristics.

### **Temperature – A, B, C**

The temperature grades are A (the highest), B, and C, representing the tire's resistance to the generation of heat and its ability to dissipate heat when tested under controlled conditions on a specified indoor laboratory test wheel. Sustained high temperature can cause the material of the tire to degenerate and reduce tire life, and excessive temperature can lead to sudden tire failure. The grade C corresponds to a level of performance which all passenger car tires must meet under the Federal Motor Safety Standard No. 109. Grades B and A represent higher levels of

performance on the laboratory test wheel than the minimum required by law. Warning: The temperature grade for this tire is established for a tire that is properly inflated and not overloaded. Excessive speed, underinflation, or excessive loading, either separately or in combination, can cause heat buildup and possible tire failure.

### **Wheel Alignment and Tire Balance**

The tires and wheels were aligned and balanced at the factory to provide the longest tire life and best overall performance. Adjustments to wheel alignment and tire balancing will not be necessary on a regular basis. However, check the alignment if there is unusual tire wear or if the vehicle is pulling to one side or the other. If the vehicle vibrates when driving on a smooth

road, the tires and wheels might need to be rebalanced. See your dealer for proper diagnosis.

### **Wheel Replacement**

Replace any wheel that is bent, cracked, or badly rusted or corroded. If wheel nuts keep coming loose, the wheel, wheel bolts and wheel nuts should be replaced. If the wheel leaks air, replace it. Some aluminum wheels can be repaired. See your dealer if any of these conditions exist.

Your dealer will know the kind of wheel that is needed.

Each new wheel should have the same load-carrying capacity, diameter, width, offset and be mounted the same way as the one it replaces.

Replace wheels, wheel bolts, wheel nuts, or Tire Pressure Monitor System (TPMS) sensors with new GM original equipment parts.

 **WARNING**

Using the wrong replacement wheels, wheel bolts, or wheel nuts can be dangerous. It could affect the braking and handling of the vehicle. Tires can lose air, and cause loss of control, causing a crash. Always use the correct wheel, wheel bolts, and wheel nuts for replacement.

**Notice:** The wrong wheel can also cause problems with bearing life, brake cooling, speedometer or odometer calibration, headlamp aim, bumper height, vehicle ground clearance, and tire clearance to the body and chassis.

 **WARNING**

Rust or dirt on a wheel, or on the parts to which it is fastened, can make wheel nuts become loose after a time. The wheel could come off and cause a crash. When changing a wheel, remove any rust or dirt from places where the wheel attaches to the vehicle. In an emergency, a cloth or a paper towel can be used, however, use a scraper or wire brush to remove all rust or dirt.

 **WARNING**

Never use oil or grease on studs or the threads of the wheel nuts. The wheel nuts might come loose and the wheel could fall off, causing a crash.

 **WARNING**

Incorrect wheel nuts or improperly tightened wheel nuts can cause the wheel to become loose and even come off. This could lead to a crash. Be sure to use the correct wheel nuts. If you have to replace them, be sure to get new GM original equipment wheel nuts.

**Notice:** Improperly tightened wheel nuts can lead to brake pulsation and rotor damage. To avoid expensive brake repairs, evenly tighten the wheel nuts in the proper sequence and to the proper torque specification.



## Used Replacement Wheels

### WARNING

Replacing a wheel with a used one is dangerous. How it has been used or how far it has been driven may be unknown. It could fail suddenly and cause a crash. When replacing wheels, use a new GM original equipment wheel.

## Tire Chains

### WARNING

Do not use tire chains. There is not enough clearance. Tire chains used on a vehicle without the proper amount of clearance can cause damage to the brakes, suspension, or other vehicle

(Continued)

### WARNING (Continued)

parts. The area damaged by the tire chains could cause loss of control and a crash.

Use another type of traction device only if its manufacturer recommends it for the vehicle's tire size combination and road conditions. Follow that manufacturer's instructions. To avoid vehicle damage, drive slow and readjust or remove the traction device if it contacts the vehicle. Do not spin the wheels. If traction devices are used, install them on the front tires.

## If a Tire Goes Flat

This vehicle has a tire sealant and compressor kit. See *Tire Sealant and Compressor Kit on page 10-60*. There is no spare tire, no tire changing equipment, and no place to store a tire.

To properly lift this vehicle, see *Lifting the Vehicle on page 10-3*.

It is unusual for a tire to blowout while driving, especially if the tires are maintained properly. See *Tires on page 10-39*. If air goes out of a tire, it is much more likely to leak out slowly. But if there ever is a blowout, here are a few tips about what to expect and what to do:

If a front tire fails, the flat tire will create a drag that pulls the vehicle toward that side. Take your foot off the accelerator pedal and grip the steering wheel firmly. Steer to maintain lane position, and then gently brake to a stop, well off the road, if possible.

A rear blowout, particularly on a curve, acts much like a skid and may require the same correction as used in a skid. Stop pressing the accelerator pedal and steer to straighten the vehicle. It may be very bumpy and noisy. Gently brake to a stop, well off the road, if possible.

### WARNING

Driving on a flat tire will cause permanent damage to the tire. Re-inflating a tire after it has been driven on while severely underinflated or flat may cause a blowout and a serious crash. Never attempt to re-inflate a tire that has been driven on while severely underinflated or flat. Have your dealer or an authorized tire service center repair or replace the flat tire as soon as possible.

If a tire goes flat, avoid further tire and wheel damage by driving slowly to a level place and stopping, well off the road, if possible.

1. Turn on the hazard warning flashers. See *Hazard Warning Flashers* on page 6-3.
2. Set the parking brake firmly.

3. Put the shift lever in P (Park). See *Shifting Into Park* on page 9-19.
4. Turn off the engine.
5. Inspect the flat tire.

If the tire has been separated from the wheel, has damaged sidewalls, or has a puncture larger than 6 mm (¼ in), the tire is too severely damaged for the tire sealant and compressor kit to be effective. See *Roadside Assistance Program* on page 13-5.

If the tire has a puncture less than 6 mm (¼ in) in the tread area of the tire, see *Tire Sealant and Compressor Kit* on page 10-60.

## Tire Sealant and Compressor Kit

### WARNING

Running the engine in Extended Range Mode in an enclosed area with poor ventilation is dangerous. Engine exhaust may enter the vehicle. Engine exhaust contains carbon monoxide (CO) which cannot be seen or smelled. It can cause unconsciousness and even death. Never run the engine in Extended Range Mode in an enclosed area that has no fresh air ventilation. For more information, see *Engine Exhaust* on page 9-26.

**⚠ WARNING**

Overinflating a tire could cause the tire to rupture and you or others could be injured. Be sure to read and follow the tire sealant and compressor kit instructions and inflate the tire to its recommended pressure. Do not exceed the recommended pressure.

**⚠ WARNING**

Storing the tire sealant and compressor kit or other equipment in the passenger compartment of the vehicle could cause injury. In a sudden stop or collision, loose equipment could strike someone. Store the tire sealant and compressor kit in its original location.

If this vehicle has a tire sealant and compressor kit, there may not be a spare tire, tire changing equipment, and on some vehicles there may not be a place to store a tire.

The tire sealant and compressor can be used to temporarily seal punctures up to 6 mm (0.25 in) in the tread area of the tire. It can also be used to inflate an underinflated tire.

If the tire has been separated from the wheel, has damaged sidewalls, or has a large puncture, the tire is too severely damaged for the tire sealant and compressor kit to be effective. See *Roadside Assistance Program* on page 13-5.

Read and follow all of the tire sealant and compressor kit instructions.

The kit includes:

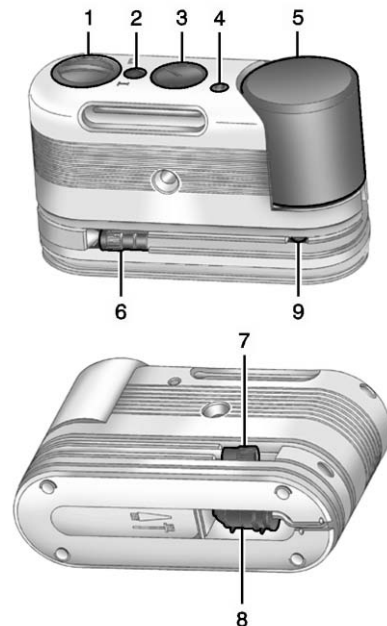

1. Selector Switch (Sealant/Air or Air Only)

## 10-62 Vehicle Care

2. On/Off Button
3. Pressure Gauge
4. Pressure Deflation Button (If equipped)
5. Tire Sealant Canister
6. Sealant/Air Hose (Clear)
7. Air Only Hose (Black)
8. Power Plug
9. Canister Release Button (Under Sealant/Air Hose)

### Tire Sealant

Read and follow the safe handling instructions on the label adhered to the sealant canister.

Check the tire sealant expiration date on the sealant canister. The sealant canister should be replaced before its expiration date.

Replacement sealant canisters are available at your local dealer. See "Removal and Installation of the Sealant Canister" following.

There is only enough sealant to seal one tire. After usage, the sealant canister and sealant/air hose assembly must be replaced. See "Removal and Installation of the Sealant Canister" following.

### Using the Tire Sealant and Compressor Kit to Temporarily Seal and Inflate a Punctured Tire

Follow the directions closely for correct sealant usage.

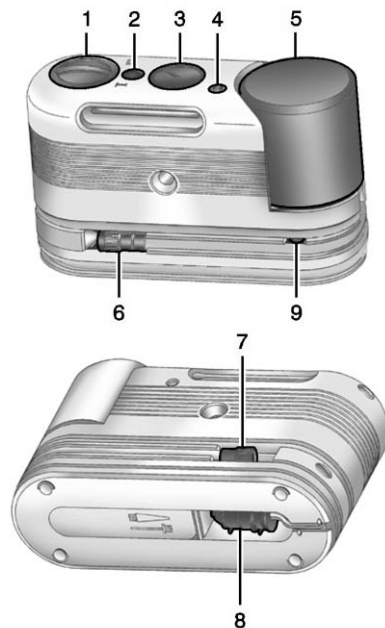

When using the tire sealant and compressor kit during cold temperatures, warm the kit in a

heated environment for five minutes. This will help to inflate the tire faster.

If a tire goes flat, avoid further tire and wheel damage by driving slowly to a level place. Turn on the hazard warning flashers. See *Hazard Warning Flashers* on page 6-3.

See *If a Tire Goes Flat* on page 10-59 for other important safety warnings.

Do not remove any objects that have penetrated the tire.

1. Remove the tire sealant and compressor kit from its storage location. See *Storing the Tire Sealant and Compressor Kit* on page 10-67.
2. Unwrap the sealant/air hose (6) and the power plug (8).
3. Place the kit on the ground.

Make sure the tire valve stem is positioned close to the ground so the hose will reach it.

4. Remove the valve stem cap from the flat tire by turning it counterclockwise.
5. Attach the sealant/air hose (6) onto the tire valve stem. Turn it clockwise until it is tight.
6. Plug the power plug (8) into the accessory power outlet in the vehicle. Unplug all items from other accessory power outlets. See *Power Outlets* on page 5-7.

If the vehicle has an accessory power outlet, do not use the cigarette lighter.

If the vehicle only has a cigarette lighter, use the cigarette lighter.

Do not pinch the power plug cord in the door or window.

7. Start the vehicle. The vehicle must be running while using the air compressor.
8. Press and turn the selector switch (1) counterclockwise to the Sealant + Air position.

9. Press the on/off button (2) to turn the tire sealant and compressor kit on.

The compressor will inject sealant and air into the tire.

The pressure gauge (3) will initially show a high pressure while the compressor pushes the sealant into the tire. Once the sealant is completely dispersed into the tire, the pressure will quickly drop and start to rise again as the tire inflates with air only.

10. Inflate the tire to the recommended inflation pressure using the pressure gauge (3). The recommended inflation pressure can be found on the Tire and Loading Information label. See *Tire Pressure* on page 10-46.

The pressure gauge (3) may read higher than the actual tire pressure while the compressor is on. Turn the compressor off to get an accurate pressure

## 10-64 Vehicle Care

---

reading. The compressor may be turned on/off until the correct pressure is reached.

**Notice:** If the recommended pressure cannot be reached after approximately 25 minutes, the vehicle should not be driven farther. The tire is too severely damaged and the tire sealant and compressor kit cannot inflate the tire. Remove the power plug from the accessory power outlet and unscrew the inflating hose from the tire valve. See *Roadside Assistance Program on page 13-5*.

11. Press the on/off button (2) to turn the tire sealant and compressor kit off.

The tire is not sealed and will continue to leak air until the vehicle is driven and the sealant is distributed in the tire; therefore, Steps 12–18 must be done immediately after Step 11.

Be careful while handling the tire sealant and compressor kit as it could be warm after usage.

12. Unplug the power plug (8) from the accessory power outlet in the vehicle.
13. Turn the sealant/air hose (6) counterclockwise to remove it from the tire valve stem.
14. Replace the tire valve stem cap.
15. Replace the sealant/air hose (6), and the power plug (8) back in their original location.



16. If the flat tire was able to inflate to the recommended inflation pressure, remove the

maximum speed label from the sealant canister (5) and place it in a highly visible location.

Do not exceed the speed on this label until the damaged tire is repaired or replaced.

17. Return the equipment to its original storage location in the vehicle.
18. Immediately drive the vehicle 8 km (5 mi) to distribute the sealant in the tire.
19. Stop at a safe location and check the tire pressure. Refer to Steps 1–11 under “Using the Tire Sealant and Compressor Kit without Sealant to Inflate a Tire (Not Punctured).”

If the tire pressure has fallen more than 68 kPa (10 psi) below the recommended inflation pressure, stop driving the vehicle. The tire is too severely damaged and the tire

sealant cannot seal the tire. See *Roadside Assistance Program* on page 13-5.

If the tire pressure has not dropped more than 68 kPa (10 psi) from the recommended inflation pressure, inflate the tire to the recommended inflation pressure.

20. Wipe off any sealant from the wheel, tire, and vehicle.
21. Dispose of the used sealant canister (5) and sealant/air hose (6) assembly at a local dealer or in accordance with local state codes and practices.
22. Replace it with a new canister available from your dealer.
23. After temporarily sealing a tire using the tire sealant and compressor kit, take the vehicle to an authorized dealer within a 161 km (100 mi) of driving to have the tire repaired or replaced.

### Using the Tire Sealant and Compressor Kit without Sealant to Inflate a Tire (Not Punctured)

To use the air compressor to inflate a tire with air only and not sealant:

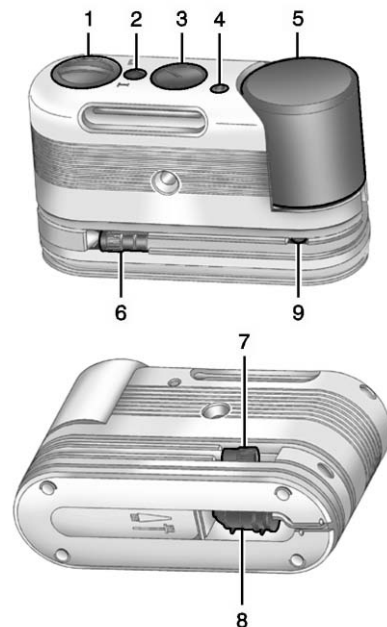

## 10-66 Vehicle Care

---

If a tire goes flat, avoid further tire and wheel damage by driving slowly to a level place. Turn on the hazard warning flashers. See *Hazard Warning Flashers* on page 6-3.

See *If a Tire Goes Flat* on page 10-59 for other important safety warnings.

1. Remove the tire sealant and compressor kit from its storage location. See *Storing the Tire Sealant and Compressor Kit* on page 10-67.
2. Unwrap the air only hose (7) and the power plug (8).
3. Place the kit on the ground.  
Make sure the tire valve stem is positioned close to the ground so the hose will reach it.
4. Remove the tire valve stem cap from the flat tire by turning it counterclockwise.
5. Attach the air only hose (7) onto the tire valve stem by turning it clockwise until it is tight.

6. Plug the power plug (8) into the accessory power outlet in the vehicle. Unplug all items from other accessory power outlets. See *Power Outlets* on page 5-7.

If the vehicle has an accessory power outlet, do not use the cigarette lighter.

If the vehicle only has a cigarette lighter, use the cigarette lighter.

Do not pinch the power plug cord in the door or window.

7. Start the vehicle. The vehicle must be running while using the air compressor.
8. Press and turn the selector switch (1) clockwise to the Air Only position.
9. Press the on/off button (2) to turn the compressor on.  
The compressor will inflate the tire with air only.

10. Inflate the tire to the recommended inflation pressure using the pressure gauge (3). The recommended inflation pressure can be found on the Tire and Loading Information label. See *Tire Pressure* on page 10-46.

The pressure gauge (3) may read higher than the actual tire pressure while the compressor is on. Turn the compressor off to get an accurate reading. The compressor may be turned on/off until the correct pressure is reached.

If you inflate the tire higher than the recommended pressure you can adjust the excess pressure by pressing the pressure deflation button (4), if equipped, until the proper pressure reading is reached. This option is only functional when using the air only hose (7).



11. Press the on/off button (2) to turn the tire sealant and compressor kit off.  
Be careful while handling the tire sealant and compressor kit as it could be warm after usage.
12. Unplug the power plug (8) from the accessory power outlet in the vehicle.
13. Disconnect the air only hose (7) from the tire valve stem by turning it counterclockwise, and replace the tire valve stem cap.
14. Replace the air only hose (7) and the power plug (8) and cord back in their original locations.
15. Place the equipment in the original storage location in the vehicle.

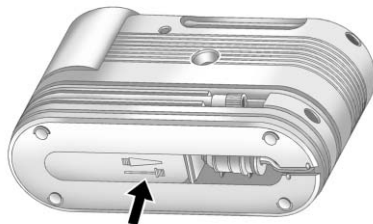

The tire sealant and compressor kit has an accessory adapter located in a compartment on the bottom of its housing that may be used to inflate air mattresses, balls, etc.

### Removal and Installation of the Sealant Canister

To remove the sealant canister:

1. Unwrap the sealant hose.
2. Press the canister release button (9).
3. Pull up and remove the canister.

4. Replace with a new canister which is available from your dealer.
5. Push the new canister into place.

### Storing the Tire Sealant and Compressor Kit

To access the tire sealant and compressor kit:

1. Open the hatch. See *Hatch* on page 2-13.
2. Lift the cover.

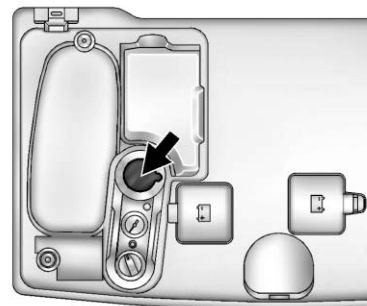

3. Remove the tire sealant and compressor kit.

To store the tire sealant and compressor kit, reverse the steps.

## **Jump Starting**

Jump starting is connecting jumper cables between the two vehicles to enable vehicle starting. If the Volt or another vehicle has a run-down 12-volt battery, it can be jump started using good condition jumper cables. There are different procedures depending on if the Volt has a run-down battery or another vehicle has a run-down battery. Read the appropriate procedures that follow.

### **WARNING**

The high voltage battery cannot be jump started either with another vehicle or battery charger. Personal injury, death, or damage to the vehicle could result.

### **WARNING**

Batteries are dangerous and can cause injury. Batteries contain acid and can explode or ignite. They contain electricity that can burn. Follow the exact steps provided or injuries could occur.

Using an open flame near a battery can cause battery gas to explode; you or others could be hurt. Battery acid can cause blindness.

Be sure the battery in the other vehicle has enough water. Add water if the level is low. A low water level could cause explosive gas to be present.

Battery fluid contains acid that can burn. If battery fluid gets in eyes or on skin; flush with water and get medical help immediately.

**⚠ WARNING**

Electric fans can start up even when the engine is not running and can cause injury. Keep hands, clothing, and tools away from any underhood electric fans.

**Notice:** Ignoring these steps could result in costly damage to the vehicle that would not be covered by the warranty.

**Trying to start the vehicle by pushing or pulling it will not work, and it could damage the vehicle.**

**Jump Starting the Volt**

If the Volt will not start, the 12-volt battery may be run down. To jump start the Volt use the underhood remote positive (+) and negative (-) terminals.

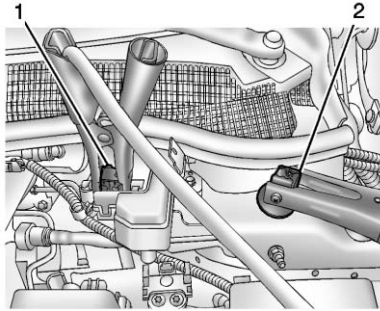

1. Remote Positive (+) Terminal
  2. Remote Negative (-) Terminal
1. The other vehicle used to jump start the Volt must have a 12-volt battery with a negative ground system.

**Notice:** Only use a vehicle that has a 12-volt system with a negative ground for jump starting. If the other vehicle does not have a 12-volt system with a negative ground, both vehicles can be damaged.

2. Park both vehicles close enough so that the jumper cables can reach both vehicles' positive (+) and negative (-) terminals. The vehicles must not touch each other. It could cause an unwanted ground connection that could damage both vehicles' electrical systems.

Put both vehicles in P (Park) for an automatic transmission or electric drive unit. For a manual transmission, place the vehicle in Neutral and set the parking brake.

**Notice:** If any accessories are left on or plugged in during the jump starting procedure, they could be damaged. The repairs would not be covered by the vehicle warranty. Whenever possible, turn off or unplug all accessories on either vehicle when jump starting the vehicle.

3. Turn off the ignition on the other vehicle. Turn off the radio, all lamps, and accessories that are

## 10-70 Vehicle Care

---

not needed in both vehicles. Unplug accessories from the cigarette lighter or the accessory power outlets. This avoids sparks and helps save both batteries and accessories.

4. Locate the positive (+) and negative (-) terminals on the other vehicle.
5. Open the hood to locate the positive (+) and negative (-) terminals on your Volt. Open the access cover for the remote positive (+) terminal (1). The remote negative (-) terminal (2) for the Volt is a stud marked GND (-) on the driver side of the engine compartment.
6. Check that the jumper cables do not have loose or missing insulation or a shock could result and the vehicles could be damaged.

Before connecting the jumper cables, here are some basic things to know. Positive (+) jumper cable goes to positive (+)

battery terminal or a remote positive (+) terminal if available. Negative (-) jumper cable goes to negative (-) battery terminal or a remote negative (-) terminal if available. Do not connect positive (+) to negative (-) or there will be a short that may damage the battery and other parts of the vehicle.

**Notice: If the jumper cables are connected or removed in the wrong order, electrical shorting may occur and damage the vehicle. The repairs would not be covered by the vehicle warranty. Always connect and remove the jumper cables in the correct order, making sure that the cables do not touch each other or other metal.**

### Connecting the Jumper Cables

1. Connect the red positive (+) jumper cable to the remote positive (+) terminal (1) of your Volt. Do not let the other end of the cable touch metal.
2. Connect the other end of the red positive (+) jumper cable to the positive (+) terminal of the other vehicle.
3. Connect the black negative (-) jumper cable to the negative (-) battery terminal of the other vehicle battery. Do not let the other end touch anything until the next step.
4. Connect the other end of the black negative (-) jumper cable to the remote negative (-) terminal (2) of your Volt.
5. Push the POWER ⏻ button to start. This will wake up the electronics on the Volt. After the instrument cluster initializes, the Volt will use power from the high voltage battery to charge the 12-volt battery. The jumper cables can then be disconnected. If the Volt does not start, call your dealer or Roadside Assistance. See *Roadside Assistance Program* on page 13-5.

### Disconnecting the Jumper Cables

1. Disconnect the black negative (-) jumper cable from the Volt. Do not let the other end of the cable touch anything until after the next step.
2. Disconnect the black negative (-) jumper cable from the other vehicle with the good battery.
3. Disconnect the red positive (+) jumper cable from the other vehicle. Do not let the other end of the cable touch anything until after the next step.
4. Disconnect the red positive (+) jumper cable from the Volt.
5. Return the positive (+) and negative (-) terminal covers to their original positions.

### Jump Starting Another Vehicle

When using the Volt to jump start another vehicle with a run-down battery, jumper cables are connected directly to the positive (+)

and negative (-) terminals on the 12-volt battery in the rear cargo area. Do not use the remote terminals under the hood. This could cause a fuse to overload in the Volt.

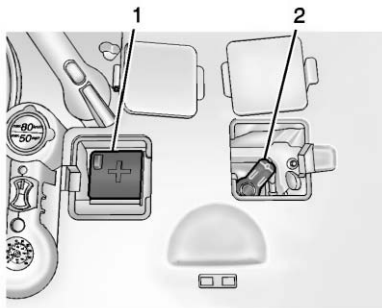

1. Positive (+) Terminal
2. Negative (-) Terminal

1. Check the other vehicle. It must have a 12-volt battery with a negative ground system.

**Notice:** Only use a vehicle that has a 12-volt system with a negative ground for jump

**starting. If the other vehicle does not have a 12-volt system with a negative ground, both vehicles can be damaged.**

2. Park both vehicles close enough so that the jumper cables can reach both vehicles' positive (+) and negative (-) terminals. The vehicles must not touch each other. It could cause an unwanted ground connection that could damage both vehicles' electrical systems.

Put both vehicles in P (Park) for an automatic transmission or electric drive unit. For a manual transmission, place the vehicle in Neutral and set the parking brake.

**Notice:** If any accessories are left on or plugged in during the jump starting procedure, they could be damaged. The repairs would not be covered by the vehicle warranty. Whenever possible,

**turn off or unplug all accessories on either vehicle when jump starting the vehicle.**

3. Turn off both vehicles. Turn off the radio, all lamps, and accessories that are not needed in both vehicles. Unplug accessories from the cigarette lighter or the accessory power outlets. This avoids sparks and helps save both batteries and accessories.
4. Locate the positive (+) and negative (-) terminals on the vehicle with the run-down battery.
5. Locate the positive (+) and negative (-) battery terminals on the Volt. The access cover is under the load floor access cover in the rear cargo area. Open the access covers for the positive (+) terminal (1) and the negative (-) terminal (2).

6. Check that the jumper cables do not have loose or missing insulation or a shock could result and the vehicles could be damaged.

Before connecting the jumper cables, here are some basic things to know. Positive (+) jumper cable goes to positive (+) battery terminal or a remote positive (+) terminal if available. Negative (-) jumper cable goes to remote negative (-) terminal if available, or a heavy, unpainted metal engine part or a solid engine ground on the vehicle with the run-down battery.

Do not connect positive (+) to negative (-) or there will be a short that may damage the battery or other parts of the vehicle. Do not connect the negative (-) cable to the negative (-) terminal on the run-down battery because this can cause sparks.

**Notice:** If the jumper cables are connected or removed in the wrong order, electrical shorting may occur and damage the vehicle. The repairs would not be covered by the vehicle warranty. Always connect and remove the jumper cables in the correct order, making sure that the cables do not touch each other or other metal.

### Connecting the Jumper Cables

1. Connect the red positive (+) jumper cable to the positive (+) terminal of the other vehicle with the run-down battery. Use a remote positive (+) terminal if available. Do not let the other end touch metal.
2. Connect the other end of the red positive (+) jumper cable to the positive (+) battery terminal of the Volt.

3. Connect the black negative (-) jumper cable to the negative (-) battery terminal of the Volt. Do not let the other end touch anything until the next step.
4. Make the final connection to a heavy, unpainted metal engine part or to the remote negative (-) terminal on the other vehicle with the run-down battery.
5. Press the POWER  button to start the Volt. This will wake up the electronics on the Volt. The engine will only start if it is needed.
6. Try to start the other vehicle that had the run-down battery. If it will not start after a few tries, it probably needs service.

### Disconnecting the Jumper Cables

1. Disconnect the black negative (-) jumper cable from the other vehicle that had the run-down battery. Do not let the other end of the cable touch anything until after the next step.
2. Disconnect the black negative (-) jumper cable from the Volt.
3. Disconnect the red positive (+) jumper cable from the Volt. Do not let the other end of the cable touch anything until after the next step.
4. Disconnect the red positive (+) jumper cable from the other vehicle.
5. Return the positive (+) and negative (-) terminal covers to their original positions.

## Towing

### Towing the Vehicle

**Notice:** Incorrectly towing a disabled vehicle may cause damage to the vehicle. The disabled vehicle should be towed on a flatbed car carrier. Use care when there is low ground clearance and/or special equipment.

**Attempting to pull the vehicle onto a flatbed without following the proper steps could damage the vehicle.**

Consult your dealer or a professional towing service if the disabled vehicle must be towed. See *Roadside Assistance Program on page 13-5*.

To load a vehicle onto a flatbed carrier:

1. The vehicle must be on a flat surface.

## 10-74 Vehicle Care

2. The front tires must be properly inflated. If necessary, move a rear tire to the front to replace a flat or damaged tire.

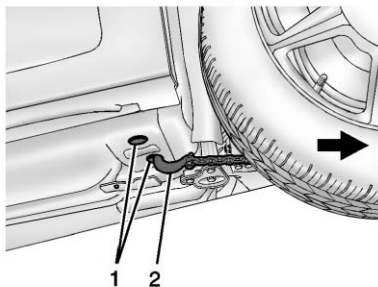

3. Place the tow chain hooks (2) into one of the torque box openings (1) behind the front wheels.

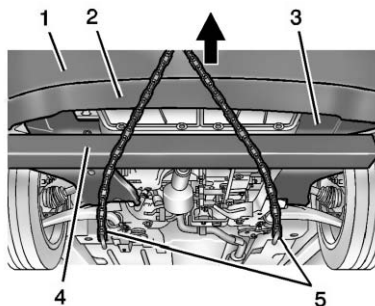

4. Place a 1.2 m (4 ft) X 102 mm (4 in) X 102 mm (4 in) wood beam (4) under the front cradle crossmember (3), and on top of both tow chains (5) to ensure the tow chains do not come into contact with the front fascia (1).

Try to minimize the contact of the chains with the flexible air dam (2).

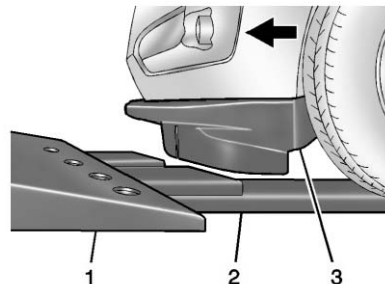

5. Ramps (2) are required for the front fascia (3) to clear the flatbed (1). The ramp height should be approximately 102 mm (4 in). Lower the flatbed onto the set of ramps.

**Notice:** If ramps are not used, the front fascia will come into contact with the flatbed and may cause damage. Always use ramps.

6. After the front tires are on the flatbed adjust the flatbed upward to provide additional clearance between the air dam, fascia, and flatbed.



7. When the fascia has enough clearance to clear the flatbed, lower the flatbed, and finish pulling the vehicle onto the flatbed.

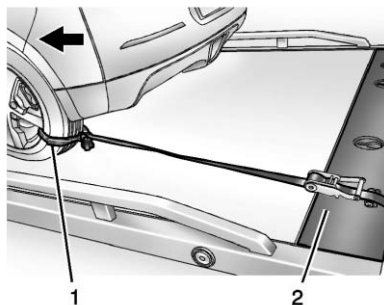

8. Secure the vehicle to the flatbed (2) using nonabrasive straps (1) through all four wheel openings and secure the straps to the flatbed (2).

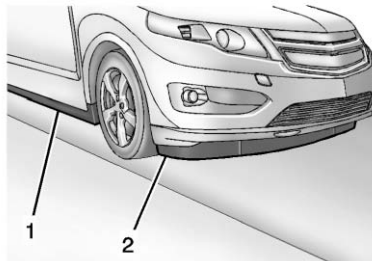

If the vehicle is parked off the shoulder of the road, at an angle that it cannot be pulled onto a flatbed, a hook/chain can be placed into either of the front torque box openings to pull the vehicle onto a flat surface. Make sure that the chains do not come in contact with the rocker panel (1) or the front fascia (2).

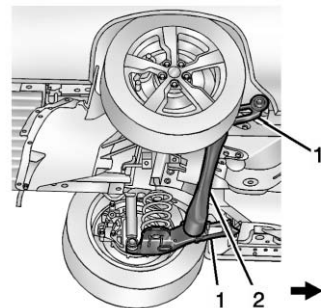

**Notice:** When using tow straps to move the vehicle, damage may occur if the tow straps contact the rear fascia. Do not let the tow straps contact the rear fascia.

If you cannot access the front torque box openings, wrap a tow strap through one, or both of the rear trailing arms (1) between the bushing and torque tube, and pull the vehicle onto a flat surface. Do not wrap the tow strap around the rear torque tube (2).

## Recreational Vehicle Towing

Recreational vehicle towing refers to towing the vehicle behind another vehicle such as a motor home. The two most common types of recreational vehicle towing are known as dinghy towing and dolly towing. Dinghy towing is towing the vehicle with all four wheels on the ground. Dolly towing is towing the vehicle with two wheels on the ground and two wheels up on a device known as a dolly.

Here are some important things to consider before recreational vehicle towing:

- The towing capacity of the towing vehicle. Read the tow vehicle manufacturer's recommendations.
- How far the vehicle can be towed. Some vehicles have restrictions on how far and how long they can tow.

- Whether the vehicle has the proper towing equipment. See your dealer or trailering professional for additional advice and equipment recommendations.
- Is the vehicle ready to be towed. Just as preparing the vehicle for a long trip, make sure the vehicle is prepared to be towed.

### Dinghy Towing

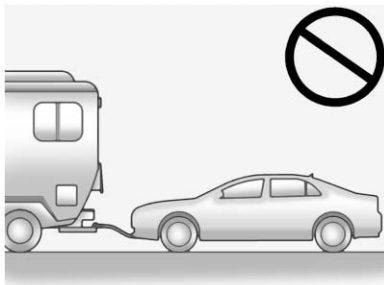

**Notice:** If the vehicle is towed with all four wheels on the ground, the drive unit could be

**damaged. Repairs would not be covered by the vehicle warranty. Do not tow the vehicle with all four wheels on the ground.**

The vehicle was not designed to be towed with all four wheels on the ground. If the vehicle must be towed, a dolly should be used. See “Dolly Towing” that follows for more information.

### Dolly Towing from the Front

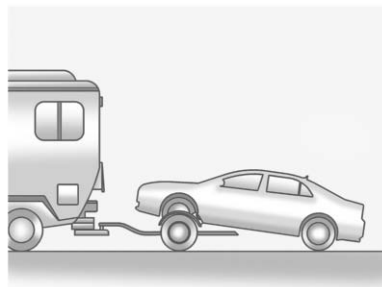

The vehicle can be towed from the front using a dolly. To tow the vehicle using a dolly, follow these steps:

1. Attach the dolly to the tow vehicle following the dolly manufacturer's instructions.
2. Drive the front wheels onto the dolly.
3. Put the shift lever in P (Park).
4. Set the parking brake and remove the key.
5. Clamp the steering wheel in a straight-ahead position with a clamping device designed for towing.
6. Secure the vehicle to the dolly.
7. Release the parking brake.
8. Check for adequate rear fascia to ground clearance.

### Dolly Towing from the Rear

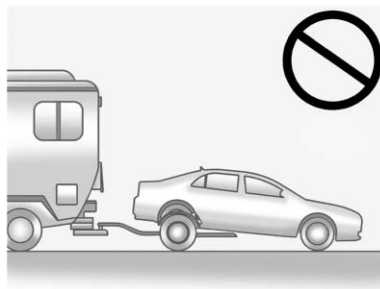

**Notice:** Towing the vehicle from the rear, with the front wheels on the ground, could damage the drive unit, and front fascia. Do not tow the vehicle from the rear with the front wheels on the ground.

## Appearance Care

### Exterior Care

#### Washing the Vehicle

To preserve the vehicle's finish, wash it often and out of direct sunlight.

**Notice:** Do not use petroleum-based, acidic, or abrasive cleaning agents as they can damage the vehicle's paint, metal, or plastic parts. If damage occurs, it would not be covered by the vehicle's warranty. Approved cleaning products can be obtained from your dealer. Follow all manufacturer directions regarding correct product usage, necessary safety precautions, and appropriate disposal of any vehicle care product.

**Notice:** Avoid using high-pressure washes closer than 30 cm (12 in) to the surface of the vehicle. Use of power washers

**exceeding 8,274 kPa (1,200 psi) can result in damage or removal of paint and decals.**

Rinse the vehicle well, before washing and after, to remove all cleaning agents completely. If they are allowed to dry on the surface, they could stain.

Dry the finish with a soft, clean chamois or an all-cotton towel to avoid surface scratches and water spotting.

### Finish Care

Application of aftermarket clearcoat sealant/wax materials is not recommended. If painted surfaces are damaged, see your dealer to have the damage assessed and repaired. Foreign materials such as calcium chloride and other salts, ice melting agents, road oil and tar, tree sap, bird droppings, chemicals from industrial chimneys, etc., can damage the vehicle's finish if they remain on painted surfaces. Wash the vehicle as soon as possible.

If necessary, use non-abrasive cleaners that are marked safe for painted surfaces to remove foreign matter.

Occasional hand waxing or mild polishing should be done to remove residue from the paint finish. See your dealer for approved cleaning products.

Do not apply waxes or polishes to uncoated plastic, vinyl, rubber, decals, simulated wood, or flat paint as damage can occur.

**Notice: Machine compounding or aggressive polishing on a basecoat/clearcoat paint finish may damage it. Use only non-abrasive waxes and polishes that are made for a basecoat/clearcoat paint finish on the vehicle.**

To keep the paint finish looking new, keep the vehicle garaged or covered whenever possible.

### Protecting Exterior Bright Metal Parts

Regularly clean bright metal parts with water or chrome polish on chrome or stainless steel trim, if necessary.

For aluminum, never use auto or chrome polish, steam, or caustic soap to clean. A coating of wax, rubbed to high polish, is recommended for all bright metal parts.

### Front Air Deflector

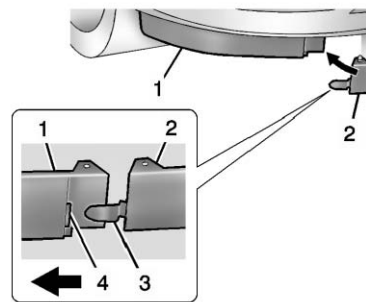

1. Outer Air Deflector

2. Inner Air Deflector
3. Tab
4. Slot

The front air deflector directs the air flow under the vehicle.

If it becomes detached, insert the Tab into the Slot. Repeat for the other side.

### **Cleaning Exterior Lamps/Lenses and Emblems**

Use only lukewarm or cold water, a soft cloth, and a car washing soap to clean exterior lamps and lenses. Follow instructions under "Washing the Vehicle" earlier in this section.

### **Windshield and Wiper Blades**

Clean the outside of the windshield with glass cleaner.

Clean rubber blades using lint-free cloth or paper towel soaked with windshield washer fluid or a mild detergent. Wash the windshield thoroughly when cleaning the blades. Bugs, road grime, sap, and

a buildup of vehicle wash/wax treatments may cause wiper streaking.

Replace the wiper blades if they are worn or damaged. Damage can be caused by extreme dusty conditions, sand, salt, heat, sun, snow and ice.

### **Weatherstrips**

Apply silicone grease on weatherstrips to make them last longer, seal better, and not stick or squeak. Lubricate weatherstrips once a year. Black marks from rubber material on painted surfaces can be removed by rubbing with a clean cloth. See *Recommended Fluids and Lubricants* on page 11-12.

### **Tires**

Use a stiff brush with tire cleaner to clean the tires.

**Notice:** Using petroleum-based tire dressing products on the vehicle may damage the paint finish and/or tires. When applying

a tire dressing, always wipe off any overspray from all painted surfaces on the vehicle.

### **Wheels and Trim — Aluminum or Chrome**

Use a soft, clean cloth with mild soap and water to clean the wheels. After rinsing thoroughly with clean water, dry with a soft, clean towel. A wax may then be applied.

**Notice:** Chrome wheels and other chrome trim may be damaged if the vehicle is not washed after driving on roads that have been sprayed with magnesium, calcium, or sodium chloride. These chlorides are used on roads for conditions such as ice and dust. Always wash the chrome with soap and water after exposure.

**Notice:** To avoid surface damage, do not use strong soaps, chemicals, abrasive polishes, cleaners, brushes, or cleaners that contain acid on aluminum or chrome-plated wheels. Use only

approved cleaners. Also, never drive a vehicle with aluminum or chrome-plated wheels through an automatic car wash that uses silicone carbide tire cleaning brushes. Damage could occur and the repairs would not be covered by the vehicle warranty.

### **Steering, Suspension, and Chassis Components**

Visually inspect front and rear suspension and steering system for damaged, loose, or missing parts or signs of wear. Inspect the power steering for proper hook-up, binding, leaks, cracks, chafing, etc. Visually check constant velocity joints, rubber boots, and axle seals for leaks.

### **Body Component Lubrication**

Lubricate all key lock cylinders, hood hinges, liftgate hinges, and the steel fuel door hinge unless the components are plastic. Applying silicone grease on weatherstrips

with a clean cloth will make them last longer, seal better, and not stick or squeak.

### **Underbody Maintenance**

Use plain water to flush dirt and debris from the vehicle's underbody. Your dealer or an underbody car washing system can do this. If not removed, rust and corrosion can develop.

### **Sheet Metal Damage**

If the vehicle is damaged and requires sheet metal repair or replacement, make sure the body repair shop applies anti-corrosion material to parts repaired or replaced to restore corrosion protection.

Original manufacturer replacement parts will provide the corrosion protection while maintaining the vehicle warranty.

### **Finish Damage**

Quickly repair minor chips and scratches with touch-up materials available from your dealer to avoid corrosion. Larger areas of finish damage can be corrected in your dealer's body and paint shop.

### **Chemical Paint Spotting**

Airborne pollutants can fall upon and attack painted vehicle surfaces causing blotchy, ring-shaped discolorations, and small, irregular dark spots etched into the paint surface.

### **Interior Care**

To prevent dirt particle abrasions, regularly clean the vehicle's interior. Immediately remove any soils. Note that newspapers or dark garments that can transfer color to home furnishings can also permanently transfer color to the vehicle's interior.

Use a soft bristle brush to remove dust from knobs and crevices on the instrument cluster. Using a mild soap solution, immediately remove hand lotions, sunscreen, and insect repellent from all interior surfaces or permanent damage may result.

Your dealer may have products for cleaning the interior. Use cleaners specifically designed for the surfaces being cleaned to prevent permanent damage. Apply all cleaners directly to the cleaning cloth. Do not spray cleaners directly on any switches or controls. Cleaners should be removed quickly. Never allow cleaners to remain on the surface being cleaned for extended periods of time.

Cleaners may contain solvents that can become concentrated in the interior. Before using cleaners, read and adhere to all safety instructions on the label. While cleaning the interior, maintain adequate ventilation by opening the doors and windows.

To prevent damage, do not clean the interior using the following cleaners or techniques:

- Never use a razor or any other sharp object to remove a soil from any interior surface.
- Never use a brush with stiff bristles.
- Never rub any surface aggressively or with excessive pressure.
- Do not use laundry detergents or dishwashing soaps with degreasers. For liquid cleaners, use approximately 20 drops per 3.78 L (1 gal) of water. A concentrated soap solution will leave a residue that creates streaks and attracts dirt. Do not use solutions that contain strong or caustic soap.
- Do not heavily saturate the upholstery when cleaning.
- Do not use solvents or cleaners containing solvents.

## Interior Glass

To clean, use a terry cloth fabric dampened with water. Wipe droplets left behind with a clean dry cloth. Commercial glass cleaners may be used, if necessary, after cleaning the interior glass with plain water.

**Notice:** To prevent scratching, never use abrasive cleaners on automotive glass. Abrasive cleaners or aggressive cleaning may damage the rear window defogger.

**Notice:** Cleaning the windshield with water during the first three to six months of ownership will reduce tendency to fog.

## Speaker Covers

Vacuum around a speaker cover gently, so that the speaker will not be damaged. Clean spots with just water and mild soap.

### Coated Moldings

Coated moldings should be cleaned.

- When lightly soiled, wipe with a sponge or soft lint-free cloth dampened with water.
- When heavily soiled, use warm soapy water.

### Fabric/Carpet/Suede

Start by vacuuming the surface using a soft brush attachment. If a rotating brush attachment is being used during vacuuming, only use it on the floor carpet. Before cleaning, gently remove as much of the soil as possible using one of the following techniques:

- Gently blot liquids with a paper towel. Continue blotting until no more soil can be removed.
- For solid soils, remove as much as possible prior to vacuuming.

To clean:

1. Saturate a clean lint-free colorfast cloth with water or club soda. Microfiber cloth is recommended to prevent lint transfer to the fabric or carpet.
2. Remove excess moisture by gently wringing until water does not drip from the cleaning cloth.
3. Start on the outside edge of the soil and gently rub toward the center. Fold the cleaning cloth to a clean area frequently to prevent forcing the soil in to the fabric.
4. Continue gently rubbing the soiled area until there is no longer any color transfer from the soil to the cleaning cloth.
5. If the soil is not completely removed, use a mild soap solution followed only by club soda or plain water.

If the soil is not completely removed, it may be necessary to use a commercial upholstery

cleaner or spot lifter. Test a small hidden area for colorfastness before using a commercial upholstery cleaner or spot lifter. If ring formation occurs, clean the entire fabric or carpet.

Following the cleaning process, a paper towel can be used to blot excess moisture.

### Cleaning High Gloss Surfaces and Vehicle Information and Radio Displays

For vehicles with high gloss surfaces or vehicle displays, use a microfiber cloth to wipe surfaces. Before wiping the surface with the microfiber cloth, use a soft bristle brush to remove dirt that could scratch the surface. Then use the microfiber cloth by gently rubbing to clean. Never use window cleaners or solvents. Periodically hand wash the microfiber cloth separately, using mild soap. Do not use bleach or fabric softener. Rinse thoroughly and air dry before next use.



**Notice:** Do not attach a device with a suction cup to the display. This may cause damage and would not be covered by the warranty.

### Instrument Panel, Leather, Vinyl, and Other Plastic Surfaces

Use a soft microfiber cloth dampened with water to remove dust and loose dirt. For a more thorough cleaning, use a soft microfiber cloth dampened with a mild soap solution.

**Notice:** Soaking or saturating leather, especially perforated leather, as well as other interior surfaces, may cause permanent damage. Wipe excess moisture from these surfaces after cleaning and allow them to dry naturally. Never use heat, steam, spot lifters, or spot removers. Do not use cleaners that contain silicone or wax-based products. Cleaners containing these solvents can permanently change

the appearance and feel of leather or soft trim and are not recommended.

Do not use cleaners that increase gloss, especially on the instrument panel. Reflected glare can decrease visibility through the windshield under certain conditions.

**Notice:** Use of air fresheners may cause permanent damage to plastics and painted surfaces. If an air freshener comes in contact with any plastic or painted surface in the vehicle, blot immediately and clean with a soft cloth dampened with a mild soap solution. Damage caused by air fresheners would not be covered by the vehicle warranty.

### Cargo Cover and Convenience Net

Wash with warm water and mild detergent. Do not use chlorine bleach. Rinse with cold water, and then dry completely.

### Care of Safety Belts

Keep belts clean and dry.

#### WARNING

Do not bleach or dye safety belts. It may severely weaken them. In a crash, they might not be able to provide adequate protection. Clean safety belts only with mild soap and lukewarm water.

### Floor Mats

#### WARNING

If a floor mat is the wrong size or is not properly installed, it can interfere with the pedals. Interference with the pedals can cause unintended acceleration and/or increased stopping distance which can cause a crash and injury. Make sure the floor mat does not interfere with the pedals.

## 10-84 Vehicle Care

---

Use the following guidelines for proper floor mat usage:

- The original equipment floor mats were designed for your vehicle. If the floor mats need replacing, it is recommended that GM certified floor mats be purchased. Non-GM floor mats may not fit properly and may interfere with the pedals. Always check that the floor mats do not interfere with the pedals.
- Use the floor mat with the correct side up. Do not turn it over.
- Do not place anything on top of the driver side floor mat.
- Use only a single floor mat on the driver side.
- Do not place one floor mat on top of another.

### Removing and Replacing the Floor Mats

Pull up on the rear of the floor mat to unlock each retainer and remove.

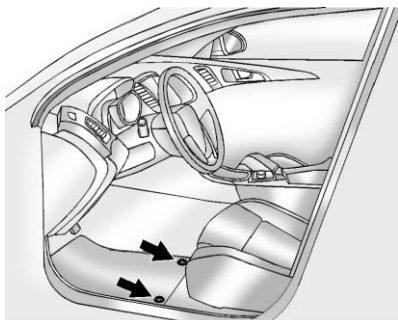

Reinstall by lining up the floor mat retainer openings over the carpet retainers and snap into position.

Make sure the floor mat is properly secured in place.

Verify the floor mat does not interfere with the pedals.

## Service and Maintenance

### General Information

General Information ..... 11-1

### Maintenance Schedule

Maintenance Schedule ..... 11-2

### Special Application Services

Special Application  
Services ..... 11-8

### Additional Maintenance and Care

Additional Maintenance  
and Care ..... 11-8

### Recommended Fluids, Lubricants, and Parts

Recommended Fluids and  
Lubricants ..... 11-12  
Maintenance Replacement  
Parts ..... 11-13

### Maintenance Records

Maintenance Records ..... 11-14

## General Information

Your vehicle is an important investment. This section describes the required maintenance for the vehicle. Follow this schedule to help protect against major repair expenses resulting from neglect or inadequate maintenance. It may also help to maintain the value of the vehicle if it is sold. It is the responsibility of the owner to have all required maintenance performed.

Your dealer has trained technicians who can perform required maintenance using genuine replacement parts. They have up-to-date tools and equipment for fast and accurate diagnostics. Many dealers have extended evening and Saturday hours, courtesy transportation, and online scheduling to assist with service needs.

Your dealer recognizes the importance of providing competitively priced maintenance and repair services. With trained

technicians, the dealer is the place for routine maintenance such as oil changes and tire rotations and additional maintenance items like tires, brakes, batteries, and wiper blades.

**Notice: Damage caused by improper maintenance can lead to costly repairs and may not be covered by the vehicle warranty. Maintenance intervals, checks, inspections, recommended fluids, and lubricants are important to keep the vehicle in good working condition.**

The Tire Rotation and Required Services are the responsibility of the vehicle owner. It is recommended to have your dealer perform these services every 12 000 km/7,500 mi. Proper vehicle maintenance helps to keep the vehicle in good working condition, improves fuel economy, and reduces vehicle emissions.

Because of the way people use vehicles, maintenance needs vary. There may need to be more

## 11-2 Service and Maintenance

frequent checks and services. The Additional Required Services - Normal are for vehicles that:

- Carry passengers and cargo within recommended limits on the Tire and Loading Information label. See *Vehicle Load Limits on page 9-11*.
- Are driven on reasonable road surfaces within legal driving limits.
- Use the recommended fuel. See *Fuel on page 9-55*.

Refer to the information in the Maintenance Schedule Additional Required Services - Normal chart.

The Additional Required Services - Severe are for vehicles that are:

- Mainly driven in heavy city traffic in hot weather.
- Mainly driven in hilly or mountainous terrain.
- Frequently towing a trailer.

- Used for high speed or competitive driving.
- Used for taxi, police, or delivery service.

Refer to the information in the Maintenance Schedule Additional Required Services - Severe chart.

### WARNING

Performing maintenance work can be dangerous and can cause serious injury. Perform maintenance work only if the required information, proper tools, and equipment are available. If they are not, see your dealer to have a trained technician do the work. See *Doing Your Own Service Work on page 10-5*.

## Maintenance Schedule

### Owner Checks and Services

#### At Each Fuel Stop

- Check the engine oil level. See *Engine Oil on page 10-9*.

#### Once a Month

- Check the tire inflation pressures. See *Tire Pressure on page 10-46*.
- Inspect the tires for wear. See *Tire Inspection on page 10-51*.
- Check the windshield washer fluid level. See *Washer Fluid on page 10-19*.
- Engine, power electronics, and high voltage battery pack coolant level checks. See *Cooling System (Engine) on page 10-14* or *Cooling System (High Voltage Battery) on page 10-15* or *Cooling System*

(*Power Electronics and Charger Modules*) on page 10-16 for more information.

## Engine Oil Change

Every 24 months or when the CHANGE ENGINE OIL SOON message displays, change the engine oil and filter as soon as possible, within the next 1 000 km/ 600 mi. The engine oil and filter must be changed at least once every 24 months. After each oil and filter change, the oil life system must be reset. See *Engine Oil Life System* on page 10-12. More frequent changes may be required when the vehicle is exposed to a corrosive environment, such as areas of high humidity, along an ocean coast, and/or areas that apply road salt during winter.

Your trained dealer technician can perform this work. If the engine oil life system is reset accidentally, service the vehicle within 5 000 km/

3,000 mi since the last service. Reset the oil life system when the oil is changed.

## Tire Rotation and Required Services Every 12 000 km/ 7,500 mi

Rotate the tires, if recommended for the vehicle, and perform the following services. See *Tire Rotation* on page 10-52.

- Check engine oil level and oil life percentage. If needed, change engine oil and filter, and reset oil life system. See *Engine Oil* on page 10-9 and *Engine Oil Life System* on page 10-12.
- Check engine coolant level. See *Engine Coolant* on page 10-16.
- Check windshield washer fluid level. See *Washer Fluid* on page 10-19.
- Visually inspect windshield wiper blades for wear, cracking, or contamination. See *Exterior Care* on page 10-77. Replace

worn or damaged wiper blades. See *Wiper Blade Replacement* on page 10-25.

- Check tire inflation pressures. See *Tire Pressure* on page 10-46.
- Inspect tire wear. See *Tire Inspection* on page 10-51.
- Visually check for fluid leaks.
- Inspect engine air cleaner filter. See *Engine Air Cleaner/Filter* on page 10-12.
- Inspect brake system.
- Visually inspect steering, suspension, and chassis components for damaged, loose, or missing parts or signs of wear. See *Exterior Care* on page 10-77.
- Check restraint system components. See *Safety System Check* on page 3-15.
- Visually inspect fuel system for damage or leaks.

## 11-4 Service and Maintenance

---

- Visually inspect exhaust system and nearby heat shields for loose or damaged parts.
- Lubricate body components. See *Exterior Care on page 10-77*.
- Check electrical drive unit shift lock control function. See *Electric Drive Unit Shift Lock Control Function Check on page 10-24*.
- Check parking brake and automatic transmission park mechanism. See *Park Brake and P (Park) Mechanism Check on page 10-25*.
- Check accelerator pedal for damage, high effort, or binding. Replace if needed.
- Visually inspect gas strut for signs of wear, cracks, or other damage. Check the hold open ability of the strut. See your dealer if service is required.
- Check tire sealant expiration date, if equipped. See *Tire Sealant and Compressor Kit on page 10-60*.



## 11-6 Service and Maintenance

---

### Footnotes — Maintenance Schedule Additional Required Services — Normal

(1) Or every four years, whichever comes first.

(2) Or every five years, whichever comes first. See *Cooling System (Engine)* on page 10-14 or *Cooling System (High Voltage Battery)* on page 10-15 or *Cooling System (Power Electronics and Charger Modules)* on page 10-16.

(3) Or every 10 years, whichever comes first.

(4) Inspect for fraying, excessive cracking, or damage; replace, if needed.





### Footnotes — Maintenance Schedule Additional Required Services — Severe

(1) Or every four years, whichever comes first.

(2) Or every five years, whichever comes first. See *Cooling System (Engine)* on page 10-14 or *Cooling System (High Voltage Battery)* on page 10-15 or *Cooling System (Power Electronics and Charger Modules)* on page 10-16.

(3) Or every 10 years, whichever comes first.

(4) Inspect for fraying, excessive cracking, or damage; replace, if needed.

### Special Application Services

- Severe Commercial Use Vehicles Only: Lubricate chassis components every 5 000 km/ 3,000 mi.
- Have underbody flushing service performed once a year.
- Have air conditioning system flushed and refilled and desiccant replaced every ten years.

### Additional Maintenance and Care

Your vehicle is an important investment and caring for it properly may help to avoid future costly repairs. To maintain vehicle performance, additional maintenance services may be required. It is recommended that your dealer perform these services — their trained dealer technicians know your vehicle best. Your dealer can also perform a thorough assessment with a multi-point inspection to recommend when your vehicle may need attention. The following list is intended to explain the services and conditions to look for that may indicate services are required.

### Battery

The battery supplies power to start the engine and operate any additional electrical accessories.

- To avoid break-down or failure to start the vehicle, maintain a battery with full cranking power.
- Trained dealer technicians have the diagnostic equipment to test the battery and ensure that the connections and cables are corrosion-free.

### Belts

- Belts may need replacing if they squeak or show signs of cracking or splitting.
- Trained dealer technicians have access to tools and equipment to inspect the belts and recommend adjustment or replacement when necessary.

### Brakes

Brakes stop the vehicle and are crucial to safe driving.

- Signs of brake wear may include chirping, grinding, or squealing noises, or difficulty stopping.
- Trained dealer technicians have access to tools and equipment to inspect the brakes and recommend quality parts engineered for the vehicle.

### Fluids

Proper fluid levels and approved fluids protect the vehicle's systems and components. See *Recommended Fluids and Lubricants on page 11-12* for GM approved fluids.

- Engine oil and windshield washer fluid levels should be checked at every fuel fill.
- Instrument cluster lights may come on to indicate that fluids may be low and need to be filled.

### Hoses

Hoses transport fluids and should be regularly inspected to ensure that there are no cracks or leaks. With a multi-point inspection, your dealer can inspect the hoses and advise if replacement is needed.

### Lamps

Properly working headlamps, taillamps, and brake lamps are important to see and be seen on the road.

- Signs that the headlamps need attention include dimming, failure to light, cracking, or damage. The brake lamps need to be checked periodically to ensure that they light when braking.
- With a multi-point inspection, your dealer can check the lamps and note any concerns.

## 11-10 Service and Maintenance

---

### Shocks and Struts

Shocks and struts help aid in control for a smoother ride.

- Signs of wear may include steering wheel vibration, bounce/sway while braking, longer stopping distance, or uneven tire wear.
- As part of the multi-point inspection, trained dealer technicians can visually inspect the shocks and struts for signs of leaking, blown seals, or damage, and can advise when service is needed.

### Tires

Tires need to be properly inflated, rotated, and balanced. Maintaining the tires can save money, fuel, and can reduce the risk of tire failure.

- Signs that the tires need to be replaced include three or more visible treadwear indicators; cord or fabric showing through the

rubber; cracks or cuts in the tread or sidewall; or a bulge or split in the tire.

- Trained dealer technicians can inspect and recommend the right tires. Your dealer can also provide tire/wheel balancing services to ensure smooth vehicle operation at all speeds. Your dealer sells and services name brand tires.

### Vehicle Care

To help keep the vehicle looking like new, vehicle care products are available from your dealer. For information on how to clean and protect the vehicle's interior and exterior, see *Interior Care on page 10-80* and *Exterior Care on page 10-77*.

### Wheel Alignment

Wheel alignment is critical for ensuring that the tires deliver optimal wear and performance.

- Signs that the alignment may need to be adjusted include pulling, improper vehicle handling, or unusual tire wear.
- Your dealer has the required equipment to ensure proper wheel alignment.

### Windshield

For safety, appearance, and the best viewing, keep the windshield clean and clear.

- Signs of damage include scratches, cracks, and chips.
- Trained dealer technicians can inspect the windshield and recommend proper replacement if needed.

### **Wiper Blades**

Wiper blades need to be cleaned and kept in good condition to provide a clear view.

- Signs of wear include streaking, skipping across the windshield, and worn or split rubber.
- Trained dealer technicians can check the wiper blades and replace them when needed.

## Recommended Fluids, Lubricants, and Parts

### Recommended Fluids and Lubricants

Usage	Fluid/Lubricant
Engine Oil	Use only engine oil licensed to the dexos1 specification, or equivalent, of the proper SAE viscosity grade. ACDelco dexos1 Synthetic Blend is recommended. See <i>Engine Oil on page 10-9</i> .
Engine Cooling System	Premix DEX-COOL (GM Part No. 12378390, in Canada 10953456). See <i>Engine Coolant on page 10-16</i> .
High Voltage Battery Cooling System	Premix DEX-COOL (GM Part No. 12378390, in Canada 10953456).
Power Electronics Cooling System	Premix DEX-COOL (GM Part No. 12378390, in Canada 10953456).
Hydraulic Brake System	DOT 3 Hydraulic Brake Fluid (GM Part No. 88863461, in Canada 88863462).
Windshield Washer	Automotive windshield washer fluid that meets regional freeze protection requirements.
Parking Brake Cable Guides	Chassis Lubricant (GM Part No. 12377985, in Canada 88901242) or lubricant meeting requirements of NLGI #2, Category LB or GC-LB.
Electric Drive Unit	DEXRON <sup>®</sup> -VI Automatic Transmission Fluid
Key Lock Cylinders	Multi-Purpose Lubricant, Superlube (GM Part No. 12346241, in Canada 10953474).

Usage	Fluid/Lubricant
Hood and Hatch Hinges	Multi-Purpose Lubricant, Superlube (GM Part No. 12346241, in Canada 10953474).
Weatherstrip Conditioning	Weatherstrip Lubricant (GM Part No. 3634770, in Canada 10953518) or Dielectric Silicone Grease (GM Part No. 12345579, in Canada 10953481).

## Maintenance Replacement Parts

Replacement parts identified below by name, part number, or specification can be obtained from your dealer.

Part	GM Part Number	ACDelco Part Number
Engine Air Cleaner/Filter	20871244	A3148C
Engine Oil Filter	55352643	PF65
Spark Plugs	55564962	41-119
Wiper Blades		
Driver – 65 cm (25.6 in)	22742323	—
Passenger – 65 cm (25.6 in)	22742324	—













## Technical Data

### Vehicle Identification

Vehicle Identification	
Number (VIN) .....	12-1
Service Parts Identification	
Label .....	12-1

### Vehicle Data

Capacities and	
Specifications .....	12-2
Engine Drive Belt Routing ...	12-3

## Vehicle Identification

### Vehicle Identification Number (VIN)



This legal identifier is in the front corner of the instrument panel, on the left side of the vehicle. It can be seen through the windshield from outside. The VIN also appears on the Vehicle Certification and Service Parts labels and certificates of title and registration.

## Engine Identification

The eighth character in the VIN is the engine code. This code identifies the vehicle's engine, specifications, and replacement parts. See "Engine Specifications" under *Capacities and Specifications* on page 12-2 for the vehicle's engine code.

### Service Parts Identification Label

The label is inside the right rear cargo storage door and has the following information:

- Vehicle Identification Number (VIN).
- Model designation.
- Paint information.
- Production options and special equipment.

Do not remove this label from the vehicle.

### Vehicle Data

#### Capacities and Specifications

The following approximate capacities are given in metric and English conversions. Refer to *Recommended Fluids and Lubricants on page 11-12* for more information.

Application	Capacities	
	Metric	English
Air Conditioning Refrigerant R134a	For the air conditioning system refrigerant charge amount, see the refrigerant label under the hood. See your dealer for more information.	
Cooling Systems		
Engine	7.3 L	7.7 qt
High Voltage Battery	5.8 L	6.2 qt
Power Electronics	2.8 L	3.0 qt
Engine Oil with Filter	3.5 L	3.7 qt
Fuel Tank	35.2 L	9.3 gal
Electric Drive Unit	8.45 L	8.93 qt
Wheel Nut Torque	140N•m	100 lb ft
All capacities are approximate. When adding, be sure to fill to the approximate level, as recommended in this manual.		

**Engine Specifications**

Engine	VIN Code	Electric Drive Unit	Spark Plug Gap
1.4L L4	4	Automatic	0.7 mm (0.027 in)

**Engine Drive Belt Routing**

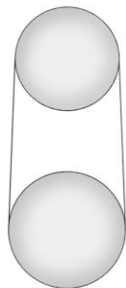





## Customer Information

### Customer Information

Customer Satisfaction Procedure .....	13-1
Customer Assistance Offices .....	13-3
Customer Assistance for Text Telephone (TTY) Users .....	13-4
Online Owner Center .....	13-4
GM Mobility Reimbursement Program .....	13-5
Roadside Assistance Program .....	13-5
Scheduling Service Appointments .....	13-7
Courtesy Transportation Program .....	13-7
Collision Damage Repair .....	13-9
Service Publications Ordering Information .....	13-11

### Reporting Safety Defects

Reporting Safety Defects to the United States Government .....	13-12
Reporting Safety Defects to the Canadian Government .....	13-13
Reporting Safety Defects to General Motors .....	13-13

### Vehicle Data Recording and Privacy

Vehicle Data Recording and Privacy .....	13-13
Event Data Recorders .....	13-14
OnStar® .....	13-14
Infotainment System .....	13-15
Radio Frequency Identification (RFID) .....	13-15
Radio Frequency Statement .....	13-15

## Customer Information

### Customer Satisfaction Procedure

Your satisfaction and goodwill are important to your dealer and to Chevrolet. Normally, any concerns with the sales transaction or the operation of the vehicle will be resolved by your dealer's sales or service departments. Sometimes, however, despite the best intentions of all concerned, misunderstandings can occur. If your concern has not been resolved to your satisfaction, the following steps should be taken:

**STEP ONE:** Discuss your concern with a member of dealership management. Normally, concerns can be quickly resolved at that level. If the matter has already been reviewed with the sales, service, or parts manager, contact the owner of your dealership or the general manager.

## 13-2 Customer Information

---

**STEP TWO:** If after contacting a member of dealership management, it appears your concern cannot be resolved by your dealership without further help, in the U.S., call the Chevrolet Customer Assistance Center at 1-877-486-5846 (1-877-4-Volt Info). In Canada, call General Motors of Canada Customer Care Centre at 1-800-263-3777 (English), or 1-800-263-7854 (French).

We encourage you to call the toll-free number in order to give the inquiry prompt attention. Have the following information available to give the Customer Assistance representative:

- Vehicle Identification Number (VIN). This is available from the vehicle registration or title, or the plate at the top left of the instrument panel and visible through the windshield.
- Dealership name and location.
- Vehicle delivery date and present mileage.

When contacting Chevrolet, remember that your concern will likely be resolved at a dealer's facility. That is why we suggest following Step One first.

### **STEP THREE — U.S. Owners:**

Both General Motors and your dealer are committed to making sure you are completely satisfied with the new vehicle. However, if you continue to remain unsatisfied after following the procedure outlined in Steps One and Two, you can file with the Better Business Bureau (BBB) Auto Line<sup>®</sup> Program to enforce your rights.

The BBB Auto Line Program is an out-of-court program administered by the Council of Better Business Bureaus to settle automotive disputes regarding vehicle repairs or the interpretation of the New Vehicle Limited Warranty. Although you may be required to resort to this informal dispute resolution program prior to filing a court action, use of the program is free of charge and your case will generally be heard within

40 days. If you do not agree with the decision given in your case, you may reject it and proceed with any other venue for relief available to you.

You may contact the BBB Auto Line Program using the toll-free telephone number or write them at the following address:

BBB Auto Line Program  
Council of Better Business  
Bureaus, Inc.  
4200 Wilson Boulevard  
Suite 800  
Arlington, VA 22203-1838

Telephone: 1-800-955-5100  
[www.dr.bbb.org/goauto](http://www.dr.bbb.org/goauto)

This program is available in all 50 states and the District of Columbia. Eligibility is limited by vehicle age, mileage, and other factors. General Motors reserves the right to change eligibility limitations and/or discontinue its participation in this program.

**STEP THREE — Canadian**

**Owners:** In the event that you do not feel your concerns have been addressed after following the procedure outlined in Steps One and Two, General Motors of Canada Limited wants you to be aware of its participation in a no-charge Mediation/Arbitration Program. General Motors of Canada Limited has committed to binding arbitration of owner disputes involving factory-related vehicle service claims. The program provides for the review of the facts involved by an impartial third party arbiter, and may include an informal hearing before the arbiter. The program is designed so that the entire dispute settlement process, from the time you file your complaint to the final decision, should be completed in about 70 days. We believe our impartial program offers advantages over courts in most jurisdictions because it is informal, quick, and free of charge.

For further information concerning eligibility in the Canadian Motor Vehicle Arbitration Plan (CAMVAP), call toll-free 1-800-207-0685, or call the General Motors Customer Care Centre, 1-800-263-3777 (English), 1-800-263-7854 (French), or write to:

The Mediation/Arbitration Program  
c/o Customer Care Centre  
General Motors of Canada Limited  
Mail Code: CA1-163-005  
1908 Colonel Sam Drive  
Oshawa, Ontario L1H 8P7

The inquiry should be accompanied by the Vehicle Identification Number (VIN).

**Customer Assistance Offices**

Chevrolet encourages customers to call the toll-free number for assistance. However, if a customer wishes to write or e-mail Chevrolet, the letter should be addressed to:

**United States and Puerto Rico**

Chevrolet Motor Division  
Chevrolet Customer Assistance  
Center  
P.O. Box 33170  
Detroit, MI 48232-5170  
www.Chevrolet.com

1-877-486-5846 (1-877-4-Volt Info)  
1-800-833-2438 (For Text  
Telephone Devices (TTYs))  
Roadside Assistance:  
1-888-811-1926

From U.S. Virgin Islands:  
1-800-496-9994

## 13-4 Customer Information

---

### Canada

General Motors of Canada Limited  
Customer Care Centre, Mail  
Code: CA1-163-005  
1908 Colonel Sam Drive  
Oshawa, Ontario L1H 8P7  
[www.gm.ca](http://www.gm.ca)

1-800-263-3777 (English)  
1-800-263-7854 (French)  
1-800-263-3830 (For Text  
Telephone devices (TTYs))  
Roadside Assistance:  
1-800-268-6800

### Overseas

Please contact the local General  
Motors Business Unit.

### Customer Assistance for Text Telephone (TTY) Users

To assist customers who are deaf,  
hard of hearing, or speech-impaired  
and who use Text Telephones  
(TTYs), Chevrolet has TTY  
equipment available at its Customer

Assistance Center. Any TTY user in  
the U.S. can communicate with  
Chevrolet by dialing:  
1-800-833-2438. TTY users in  
Canada can dial 1-800-263-3830.

### Online Owner Center

#### Online Owner Experience (U.S.) [my.chevrolet.com](http://my.chevrolet.com)

The Chevrolet online owner  
experience is a one-stop resource  
that allows interaction with  
Chevrolet and keeps important  
vehicle-specific information in one  
place.

#### Membership Benefits

 **(Vehicle Information):**  
Download owner manuals and view  
vehicle-specific how-to videos.

 **(Maintenance Information):**  
View maintenance schedules,  
required alerts, OnStar onboard  
vehicle diagnostic information, and  
schedule service appointments.

 **(Service History):** View  
printable dealer-recorded service  
records and self-recorded service  
records.

 **(Preferred Dealer  
Information):** Select a preferred  
dealer and view dealer location,  
maps, phone numbers, and hours.

 **(Warranty Tracking  
Information):** Track the vehicle's  
warranty information.

 **(Recall Information):** View  
active recalls or search by Vehicle  
Identification Number (VIN). See  
*Vehicle Identification Number (VIN)*  
on page 12-1.

 **(Other Account Information):**  
View GM Card, SiriusXM Satellite  
radio, and OnStar account  
information.

 **(Live Chat Support):** Chat live  
with online help representatives.

Visit [my.chevrolet.com](http://my.chevrolet.com) to register  
your vehicle.

## Chevrolet Owner Centre (Canada) [chevroletowner.ca](http://chevroletowner.ca)

Take a trip to the Chevrolet Owner Centre:

- Chat live with online help representatives.
- Use the Vehicle Tools section.
- Access third party enthusiast sites and social media networks.
- Locate owner resources such as lease-end, financing, and warranty information.
- Retrieve your favorite articles, quizzes, tips, and multimedia galleries organized into the Features and Auto Care Sections.
- Download the owner manual for your vehicle, quickly and easily.
- Find the Chevrolet-recommended maintenance services for your vehicle.

## GM Mobility Reimbursement Program



This program is available to qualified applicants for cost reimbursement of eligible aftermarket adaptive equipment required for the vehicle, such as hand controls or a wheelchair/scooter lift for the vehicle.

For more information on the limited offer, visit [www.gmmobility.com](http://www.gmmobility.com) or call the GM Mobility Assistance Center at 1-800-323-9935. Text Telephone (TTY) users, call 1-800-833-9935.

General Motors of Canada also has a Mobility Program. Call 1-800-GM-DRIVE (463-7483) for details. TTY users call 1-800-263-3830.

## Roadside Assistance Program

From the U.S., call 1-888-811-1926; (Text Telephone (TTY): 1-888-889-2438).

From Canada, call 1-800-268-6800.

Service is available 24 hours a day, 365 days a year.

### Calling for Assistance

When calling Roadside Assistance, have the following information ready:

- Your name, home address, and home telephone number.
- Telephone number of your location.
- Location of the vehicle.

## 13-6 Customer Information

---

- Model, year, color, and license plate number of the vehicle.
- Odometer reading, Vehicle Identification Number (VIN), and delivery date of the vehicle.
- Description of the problem.

### Coverage

Services are provided up to 5 years/160 000 km (100,000 mi), whichever comes first.

In the U.S., anyone driving the vehicle is covered. In Canada, a person driving the vehicle without permission from the owner is not covered.

Roadside Assistance is not a part of the New Vehicle Limited Warranty. Chevrolet and General Motors of Canada Limited reserve the right to make any changes or discontinue the Roadside Assistance program at any time without notification.

Chevrolet and General Motors of Canada Limited reserve the right to limit services or payment to an owner or driver if they decide the

claims are made too often, or the same type of claim is made many times.

### Services Provided

- **Emergency Fuel Delivery:** Delivery of enough fuel for the vehicle to get to the nearest service station.
- **Lock-Out Service:** Service to unlock the vehicle if you are locked out. A remote unlock may be available if you have OnStar. For security reasons, the driver must present identification before this service is given.
- **Emergency Tow from a Public Road or Highway:** Tow to the nearest Chevrolet dealer for warranty service, or if the vehicle was in a crash and cannot be driven. Assistance is also given when the vehicle is stuck in the sand, mud, or snow.
- **Flat Tire Change:** Service to change a flat tire with the tire sealant and compressor kit.

If the tire has been separated from the wheel, has damaged sidewalls, or has a large puncture, the tire is too severely damaged for the tire sealant and compressor kit to be effective. It is the owner's responsibility for the repair or replacement of the tire if it is not covered by the warranty.

- **Battery Jump Start:** Service to jump start a dead battery.

### Services Not Included in Roadside Assistance

- Impound towing caused by violation of any laws.
- Legal fines.
- Mounting, dismounting, or changing of snow tires, chains, or other traction devices.
- Towing or services for vehicles driven on a non-public road or highway.

## Services Specific to Canadian Vehicles

- **Fuel Delivery:** Reimbursement is approximately \$5 Canadian. Diesel fuel delivery may be restricted. Propane and other fuels are not provided through this service.
- **Lock-Out Service:** Vehicle registration is required.
- **Trip Interruption Benefits and Assistance:** Must be over 250 km (150 mi) from where the trip was started to qualify. General Motors of Canada Limited requires pre-authorization, original detailed receipts, and a copy of the repair orders. Once authorization has been received, the Roadside Assistance advisor will help to make arrangements and explain how to receive payment.
- **Alternative Service:** If assistance cannot be provided right away, the Roadside

Assistance advisor may give permission to get local emergency road service. You will receive payment, up to \$100, after sending the original receipt to Roadside Assistance. Mechanical failures may be covered, however any cost for parts and labor for repairs not covered by the warranty are the owner's responsibility.

## Scheduling Service Appointments

When the vehicle requires warranty service, contact your dealer and request an appointment. By scheduling a service appointment and advising the service consultant of your transportation needs, your dealer can help minimize your inconvenience.

If the vehicle cannot be scheduled into the service department immediately, keep driving it until it can be scheduled for service, unless, of course, the problem is

safety related. If it is, please call your dealership, let them know this, and ask for instructions.

If your dealer requests you to bring the vehicle for service, you are urged to do so as early in the work day as possible to allow for same-day repair.

## Courtesy Transportation Program

To enhance your ownership experience, we and our participating dealers are proud to offer Courtesy Transportation, a customer support program for vehicles with the Bumper-to-Bumper (Base Warranty Coverage period in Canada) and extended powertrain warranties in both the U.S. and Canada.

Several Courtesy Transportation options are available to assist in reducing inconvenience when warranty repairs are required.

## 13-8 Customer Information

---

Courtesy Transportation is not a part of the New Vehicle Limited Warranty. A separate booklet entitled "Limited Warranty and Owner Assistance Information" furnished with each new vehicle provides detailed warranty coverage information.

### Transportation Options

Warranty service can generally be completed while you wait. However, if you are unable to wait, GM helps to minimize inconvenience by providing several transportation options. Depending on the circumstances, your dealer can offer one of the following:

#### Shuttle Service

Shuttle service is the preferred means of offering Courtesy Transportation. Dealers may provide shuttle service to get you to your destination with minimal interruption of your daily schedule. This includes

one-way or round-trip shuttle service within reasonable time and distance parameters of your dealer's area.

#### Public Transportation or Fuel Reimbursement

If the vehicle requires overnight warranty repairs, and public transportation is used instead of your dealer's shuttle service, the expense must be supported by original receipts and can only be up to the maximum amount allowed by GM for shuttle service. In addition, for U.S. customers, should you arrange transportation through a friend or relative, limited reimbursement for reasonable fuel expenses may be available. Claim amounts should reflect actual costs and be supported by original receipts. See your dealer for information regarding the allowance amounts for reimbursement of fuel or other transportation costs.

#### Courtesy Rental Vehicle

Your dealer may arrange to provide you with a courtesy rental vehicle or reimburse you for a rental vehicle that you obtain if the vehicle is kept for an overnight warranty repair. Rental reimbursement will be limited and must be supported by original receipts. This requires that you sign and complete a rental agreement and meet state/provincial, local, and rental vehicle provider requirements. Requirements vary and may include minimum age requirements, insurance coverage, credit card, etc. You are responsible for fuel usage charges and may also be responsible for taxes, levies, usage fees, excessive mileage, or rental usage beyond the completion of the repair.

It may not be possible to provide a like vehicle as a courtesy rental.



## Additional Program Information

All program options, such as shuttle service, may not be available at every dealer. Please contact your dealer for specific information about availability. All Courtesy Transportation arrangements will be administered by appropriate dealer personnel.

*General Motors reserves the right to unilaterally modify, change, or discontinue Courtesy Transportation at any time and to resolve all questions of claim eligibility pursuant to the terms and conditions described herein at its sole discretion.*

## Collision Damage Repair

If the vehicle is involved in a collision and it is damaged, have the damage repaired by a qualified technician using the proper equipment and quality replacement parts. Poorly performed collision repairs diminish the vehicle resale

value, and safety performance can be compromised in subsequent collisions.

## Collision Parts

Genuine GM Collision parts are new parts made with the same materials and construction methods as the parts with which the vehicle was originally built. Genuine GM Collision parts are the best choice to ensure that the vehicle's designed appearance, durability, and safety are preserved. The use of Genuine GM parts can help maintain the GM New Vehicle Limited Warranty.

Recycled original equipment parts may also be used for repair. These parts are typically removed from vehicles that were total losses in prior crashes. In most cases, the parts being recycled are from undamaged sections of the vehicle. A recycled original equipment GM part may be an acceptable choice to maintain the vehicle's originally designed appearance and safety performance; however, the history of

these parts is not known. Such parts are not covered by the GM New Vehicle Limited Warranty, and any related failures are not covered by that warranty.

Aftermarket collision parts are also available. These are made by companies other than GM and may not have been tested for the vehicle. As a result, these parts may fit poorly, exhibit premature durability/corrosion problems, and may not perform properly in subsequent collisions. Aftermarket parts are not covered by the GM New Vehicle Limited Warranty, and any vehicle failure related to such parts is not covered by that warranty.

## Repair Facility

GM also recommends that you choose a collision repair facility that meets your needs before you ever need collision repairs. Your dealer may have a collision repair center with GM-trained technicians and state-of-the-art equipment, or be able to recommend a collision repair

## 13-10 Customer Information

---

center that has GM-trained technicians and comparable equipment.

### Insuring the Vehicle

Protect your investment in the GM vehicle with comprehensive and collision insurance coverage. There are significant differences in the quality of coverage afforded by various insurance policy terms. Many insurance policies provide reduced protection to the GM vehicle by limiting compensation for damage repairs by using aftermarket collision parts. Some insurance companies will not specify aftermarket collision parts. When purchasing insurance, we recommend that you ensure that the vehicle will be repaired with GM original equipment collision parts. If such insurance coverage is not available from your current insurance carrier, consider switching to another insurance carrier.

If the vehicle is leased, the leasing company may require you to have insurance that ensures repairs with Genuine GM Original Equipment Manufacturer (OEM) parts or Genuine Manufacturer replacement parts. Read the lease carefully, as you may be charged at the end of the lease for poor quality repairs.

### If a Crash Occurs

If there has been an injury, call emergency services for help. Do not leave the scene of a crash until all matters have been taken care of. Move the vehicle only if its position puts you in danger, or you are instructed to move it by a police officer.

Give only the necessary information to police and other parties involved in the crash.

For emergency towing see *Roadside Assistance Program on page 13-5*.

Gather the following information:

- Driver name, address, and telephone number.
- Driver license number.
- Owner name, address, and telephone number.
- Vehicle license plate number.
- Vehicle make, model, and model year.
- Vehicle Identification Number (VIN).
- Insurance company and policy number.
- General description of the damage to the other vehicle.

Choose a reputable repair facility that uses quality replacement parts. See "Collision Parts" earlier in this section.

In a crash, the sensing system may shut down the high voltage system. See *Battery on page 10-22* for important safety information. If an

airbag has inflated, see *What Will You See after an Airbag Inflates?* on page 3-21.

### **Managing the Vehicle Damage Repair Process**

In the event that the vehicle requires damage repairs, GM recommends that you take an active role in its repair. If you have a pre-determined repair facility of choice, take the vehicle there, or have it towed there. Specify to the facility that any required replacement collision parts be original equipment parts, either new Genuine GM parts or recycled original GM parts. Remember, recycled parts will not be covered by the GM vehicle warranty.

Insurance pays the bill for the repair, but you must live with the repair. Depending on your policy limits, your insurance company may initially value the repair using aftermarket parts. Discuss this with the repair professional, and insist on Genuine GM parts. Remember, if the vehicle is leased, you may be

obligated to have the vehicle repaired with Genuine GM parts, even if your insurance coverage does not pay the full cost.

If another party's insurance company is paying for the repairs, you are not obligated to accept a repair valuation based on that insurance company's collision policy repair limits, as you have no contractual limits with that company. In such cases, you can have control of the repair and parts choices as long as the cost stays within reasonable limits.

### **Service Publications Ordering Information**

#### **Service Manuals**

Service Manuals have the diagnosis and repair information on the engines, electric drive unit, axle, suspension, brakes, electrical, steering, body, etc.

#### **Service Bulletins**

Service Bulletins give additional technical service information needed to knowledgeably service General Motors cars and trucks. Each bulletin contains instructions to assist in the diagnosis and service of the vehicle.

#### **Owner Information**

Owner publications are written specifically for owners and intended to provide basic operational information about the vehicle. The Owner Manual includes the Maintenance Schedule for all models.

In-Portfolio: Includes a Portfolio, Owner Manual, and Warranty Booklet.

RETAIL SELL PRICE:  
\$35.00 (U.S.) plus handling and shipping fees.

Without Portfolio: Owner Manual only.

## 13-12 Customer Information

---

RETAIL SELL PRICE:  
\$25.00 (U.S.) plus handling and shipping fees.

### Current and Past Models

Technical Service Bulletins and Manuals are available for current and past model GM vehicles.

### ORDER TOLL FREE:

**1-800-551-4123 Monday - Friday  
8:00 AM - 6:00 PM Eastern Time**

For Credit Card Orders Only  
(VISA-MasterCard-Discover), visit  
Helm, Inc. at: [www.helminc.com](http://www.helminc.com)

Or write to:

Helm, Incorporated  
Attention: Customer Service  
47911 Halyard Drive  
Plymouth, MI 48170

Prices are subject to change without notice and without incurring obligation. Allow ample time for delivery.

All listed prices are quoted in U.S. funds. Make checks payable in U.S. funds.

## Reporting Safety Defects

### Reporting Safety Defects to the United States Government

If you believe that your vehicle has a defect which could cause a crash or could cause injury or death, you should immediately inform the National Highway Traffic Safety Administration (NHTSA) in addition to notifying General Motors.

If NHTSA receives similar complaints, it may open an investigation, and if it finds that a safety defect exists in a group of vehicles, it may order a recall and remedy campaign. However, NHTSA cannot become involved in individual problems between you, your dealer, or General Motors.

To contact NHTSA, you may call the Vehicle Safety Hotline toll-free at 1-888-327-4236 (TTY: 1-800-424-9153); go to <http://www.safercar.gov>; or write to:

Administrator, NHTSA  
1200 New Jersey Avenue, S.E.  
Washington, D.C. 20590

You can also obtain other information about motor vehicle safety from <http://www.safercar.gov>.

## Reporting Safety Defects to the Canadian Government

If you live in Canada, and you believe that the vehicle has a safety defect, notify Transport Canada immediately, and notify General Motors of Canada Limited. Call Transport Canada at 1-800-333-0510 or write to:

Transport Canada  
Road Safety Branch  
80 rue Noel  
Gatineau, QC J8Z 0A1

## Reporting Safety Defects to General Motors

In addition to notifying NHTSA (or Transport Canada) in a situation like this, notify General Motors.

Call 1-800-222-1020, or write:

Chevrolet Motor Division  
Chevrolet Customer Assistance  
Center  
P.O. Box 33170  
Detroit, MI 48232-5170

In Canada, call 1-800-263-3777  
(English) or 1-800-263-7854  
(French), or write:

General Motors of Canada Limited  
Customer Care Centre, Mail  
Code: CA1-163-005  
1908 Colonel Sam Drive  
Oshawa, Ontario L1H 8P7

## Vehicle Data Recording and Privacy

The vehicle has a number of computers that record information about the vehicle's performance and how it is driven. For example, the vehicle uses computer modules to monitor and control engine and electric drive unit performance, to monitor the conditions for airbag deployment and to deploy them in a crash, and, if equipped, to provide antilock braking to help the driver control the vehicle. These modules may store data to help the dealer technician service the vehicle. Some modules may also store data about how the vehicle is operated, such as rate of fuel consumption or average speed. These modules may retain personal preferences, such as radio presets, seat positions, and temperature settings.

### Event Data Recorders

This vehicle is equipped with an event data recorder (EDR). The main purpose of an EDR is to record, in certain crash or near crash-like situations, such as an air bag deployment or hitting a road obstacle, data that will assist in understanding how a vehicle's systems performed. The EDR is designed to record data related to vehicle dynamics and safety systems for a short period of time, typically 30 seconds or less. The EDR in this vehicle is designed to record such data as:

- How various systems in your vehicle were operating;
- Whether or not the driver and passenger safety belts were buckled/fastened;
- How far (if at all) the driver was depressing the accelerator and/or brake pedal; and,
- How fast the vehicle was traveling.

These data can help provide a better understanding of the circumstances in which crashes and injuries occur. NOTE: EDR data are recorded by your vehicle only if a non-trivial crash situation occurs; no data are recorded by the EDR under normal driving conditions and no personal data (e.g., name, gender, age, and crash location) are recorded. However, other parties, such as law enforcement, could combine the EDR data with the type of personally identifying data routinely acquired during a crash investigation.

To read data recorded by an EDR, special equipment is required, and access to the vehicle or the EDR is needed. In addition to the vehicle manufacturer, other parties, such as law enforcement, that have the special equipment, can read the information if they have access to the vehicle or the EDR.

GM will not access this data or share it with others except: with the consent of the vehicle owner or,

if the vehicle is leased, with the consent of the lessee; in response to an official request by police or similar government office; as part of GM's defense of litigation through the discovery process; or, as required by law. Data that GM collects or receives may also be used for GM research needs or may be made available to others for research purposes, where a need is shown and the data is not tied to a specific vehicle or vehicle owner.

### OnStar®

If the vehicle is equipped with OnStar® and has an active subscription, additional data may be collected through the OnStar system. This includes information about the vehicle's operation; about collisions involving the vehicle; the use of the vehicle and its features; and, in certain situations, the location and approximate GPS speed of the vehicle. Refer to the

OnStar Terms and Conditions and Privacy Statement on the OnStar website.

## Infotainment System

If the vehicle is equipped with a navigation system as part of the infotainment system, use of the system may result in the storage of destinations, addresses, telephone numbers, and other trip information. See the infotainment manual for information on stored data and for deletion instructions.

## Radio Frequency Identification (RFID)

RFID technology is used in some vehicles for functions such as tire pressure monitoring and ignition system security, as well as in connection with conveniences such as Remote Keyless Entry (RKE) transmitters for remote door locking/unlocking and starting, and in-vehicle transmitters for garage door openers. RFID technology in

GM vehicles does not use or record personal information or link with any other GM system containing personal information.

## Radio Frequency Statement

This vehicle has systems that operate on a radio frequency that comply with Part 15 of the Federal Communications Commission (FCC) rules and with Industry Canada Standards RSS-GEN/210/220/310.

Operation is subject to the following two conditions:

1. The device may not cause harmful interference.
2. The device must accept any interference received, including interference that may cause undesired operation of the device.

Changes or modifications to any of these systems by other than an authorized service facility could void authorization to use this equipment.





# OnStar

## OnStar Overview

OnStar Overview ..... 14-1

## OnStar Services

Emergency ..... 14-2

Security ..... 14-2

Navigation ..... 14-2

Connections ..... 14-3

Diagnostics ..... 14-4

## OnStar Additional Information

OnStar Additional  
Information ..... 14-5

## OnStar Overview



If equipped, this vehicle has a comprehensive, in-vehicle system that can connect to a live Advisor for Emergency, Security, Navigation, Connection, and Diagnostic Services.

The OnStar system status light is next to the OnStar buttons. If the status light is:

- Solid Green: System is ready.
- Flashing Green: On a call.
- Red: Indicates a problem.

Press  or call 1-888-4ONSTAR (1-888-466-7827) to speak to an Advisor.

Press  to:

- Make a call, end a call, or answer an incoming call.
- Give OnStar Hands-Free Calling voice commands.
- Give OnStar Turn-by-Turn Navigation voice commands. Requires the available Directions and Connections service plan.

Press  to connect to a live Advisor to:

- Verify account information or update contact information.
- Get driving directions. Requires the available Directions and Connections service plan.
- Receive On-Demand Diagnostics for a check of the vehicle's key operating systems.
- Receive Roadside Assistance.

Press the OnStar Emergency button  to get a priority connection to an Emergency Advisor available 24/7 to:

- Get help for an emergency.
- Be a Good Samaritan or respond to an AMBER Alert.
- Get crisis assistance and evacuation routes.

## OnStar Services

### Emergency

With Automatic Crash Response, the built-in system can automatically connect to help in most crashes, even if help cannot be requested.

Press  to connect to an Emergency Advisor. GPS technology is used to identify the vehicle location and can provide critical information to emergency personnel. The Advisor is also trained to offer critical assistance in emergency situations before first responders arrive.

### Security

OnStar provides services like Stolen Vehicle Assistance, Remote Ignition Block, and Roadside Assistance, if the vehicle is equipped. OnStar can unlock the vehicle doors remotely, if it is equipped with

automatic door locks, and can help police locate the vehicle if it is stolen.

### Navigation

OnStar navigation requires the Directions and Connections service plan.

Press  to receive directions or have them sent to the vehicle navigation screen, if equipped. Destinations can also be forwarded to the vehicle from MapQuest.com. The OnStar mapping database is continuously updated. For coverage maps, see [www.onstar.com](http://www.onstar.com) (U.S.) [www.onstar.ca](http://www.onstar.ca) (Canada).

### Turn-by-Turn Navigation

1. Press  to connect to a live Advisor.
2. Request directions.
3. Directions are downloaded to the vehicle.
4. Follow the voice-guided commands.

## Using Voice Commands During a Planned Route

### Cancel Route

1. Press . System responds: "OnStar ready," then a tone. Say "Cancel route." System responds: "Do you want to cancel directions?"
2. Say "Yes." System responds: "OK, request completed, thank you, goodbye."

### Route Preview

1. Press . System responds: "OnStar ready," then a tone.
2. Say "Route preview." System responds with the next three maneuvers.
3. Say "Goodbye." Exits voice commands.

### Repeat

1. Press . System responds: "OnStar ready," then a tone.

2. Say "Repeat." System responds with the last direction given, then responds with "OnStar ready," then a tone.
3. Say "Goodbye." Exits voice commands.

### Get My Destination

1. Press . System responds: "OnStar ready," then a tone.
2. Say "Get my destination." System responds with address and the distance to the destination, then responds with "OnStar ready," then a tone.
3. Say "Goodbye." Exits voice commands.

### Other Navigation Services Available from OnStar

**OnStar eNav:** Allows subscribers to send destinations from MapQuest.com to their Turn-by-Turn Navigation or screen-based navigation system. When ready, the directions will be downloaded to the vehicle.

**Destination Download:** Press , then request the Advisor to download directions to the navigation system in the vehicle. After the call ends, press the "Go" button on the navigation screen to begin driving directions.

Destinations can also be downloaded on the go. For information about eNav, Destination Download, and coverage maps see [www.onstar.com](http://www.onstar.com) (U.S.), [www.onstar.ca](http://www.onstar.ca) (Canada).

### Connections

OnStar Hands-Free Calling allows calls to be made and received from the vehicle. The vehicle can also be controlled from a cell phone through the OnStar RemoteLink mobile app. For coverage maps, see [www.onstar.com](http://www.onstar.com) (U.S.), [www.onstar.ca](http://www.onstar.ca) (Canada).

### Hands-Free Calling

1. Press . System responds: "OnStar ready."

## 14-4 OnStar

---

2. Say "Call." System responds: "Please say the name or number to call."
3. Say the entire number without pausing, including a "1" and the area code. System responds: "OK calling."

### Calling 911 Emergency

1. Press . The system responds "OnStar Ready," followed by a tone.
2. Say "Call." The system responds "Please say the name or number to call."
3. Say "911" without pausing. The system responds "911."
4. Say "Call." The system responds "OK, dialing 911."

### Retrieve My Number

1. Press . System responds: "OnStar ready."
2. Say "My number." System responds: "Your OnStar Hands-Free Calling number is."

### End a Call

Press . System responds: "Call ended."

### Store a Name Tag for Speed Dialing

1. Press . System responds: "OnStar ready."
2. Say "Store." System responds: "Please say the number you would like to store."
3. Say the entire number without pausing. System responds: "Please say the name tag."
4. Pick a name tag. System responds: "About to store <name tag>. Does that sound OK?"
5. Say "Yes" or say "No" to try again. System responds: "OK, storing <name tag>."

### Place a Call Using a Stored Number

1. Press . System responds: "OnStar ready."

2. Say "Call <name tag>." System responds: "OK, calling <name tag>."

### Verify Minutes and Expiration

Press  and say "Minutes" then "Verify" to check how many minutes remain and their expiration date.

### OnStar Mobile App

Download the OnStar RemoteLink mobile app to select Apple, Android and BlackBerry devices to check vehicle fuel level, oil life, or tire pressure; to start the vehicle (if equipped) or unlock it; or to connect to an OnStar Advisor. For OnStar RemoteLink information and compatibility, see [www.onstar.com](http://www.onstar.com) (U.S.), [www.onstar.ca](http://www.onstar.ca) (Canada).

### Diagnostics

OnStar Vehicle Diagnostics will perform a vehicle check every month. It will check the engine, transmission, antilock brakes, and major vehicle systems. It also

checks the tire pressures, if the vehicle is equipped with the Tire Pressure Monitoring System. If a diagnostics check is needed between e-mails, press , and an Advisor can run a check.

## OnStar Additional Information

### Transferring Service

Press  to request account transfer eligibility information. The Advisor can assist in canceling or removing account information. If OnStar receives information that vehicle ownership has changed, OnStar may send a voice message to the vehicle, requesting updated account information.

### Reactivation for Subsequent Owners

Press  and follow the prompts to speak to an Advisor as soon as possible after acquiring the vehicle. The Advisor will update vehicle records and will explain the OnStar service offers and options available.

### How OnStar Service Works

Automatic Crash Response, Emergency Services, Crisis Assist, Stolen Vehicle Assistance, Vehicle Diagnostics, Remote Door Unlock, Roadside Assistance, Turn-by-Turn Navigation, and Hands-Free Calling are available on most vehicles. Not all OnStar services are available everywhere or on all vehicles. For more information, a full description of OnStar services, system limitations, and OnStar terms and conditions:

- In the U.S. see [www.onstar.com](http://www.onstar.com) (U.S.) or call 1.888.4.ONSTAR. (1.888.466.7827).
- In Canada see [www.onstar.ca](http://www.onstar.ca) (Canada) or call 1.888.4.ONSTAR. (1.888.466.7827).
- TTY 1-877-248-2080
- Press  to speak with an Advisor.

OnStar services require a vehicle electrical system, wireless service, and GPS satellite technologies to be available and operating for features to function properly. These systems may not operate if the battery is discharged or disconnected.

OnStar service cannot work unless your vehicle is in a place where OnStar has an agreement with a wireless service provider for service in that area, and the wireless service provider has coverage, network capacity, reception, and technology compatible with OnStar service. Service involving location information about the vehicle cannot work unless GPS signals are available, unobstructed, and compatible with the OnStar hardware. OnStar service may not work if the OnStar equipment is not properly installed or it has not been properly maintained. If equipment or software is added, connected, or modified, OnStar service may not work. Other problems beyond the control of OnStar may prevent

service such as hills, tall buildings, tunnels, weather, electrical system design and architecture of the vehicle, damage to the vehicle in a crash, or wireless phone network congestion or jamming.

See *Radio Frequency Statement on page 13-15* for information regarding Part 15 of the Federal Communications Commission (FCC) rules and Industry Canada Standards RSS-GEN/210/220/310.

### Services for People with Disabilities

Advisors provide services to help subscribers with physical disabilities and medical conditions.

Press  for help with:

- Locating a gas station with an attendant to pump gas.
- Finding a hotel, restaurant, etc., that meets accessibility needs.
- Providing directions to the closest hospital or pharmacy in urgent situations.

### TTY Users

OnStar has the ability to communicate to the deaf, hard-of-hearing, or speech-impaired customers while in the vehicle. The available dealer-installed TTY system can provide in-vehicle access to all of the OnStar services, except Virtual Advisor and OnStar Turn-by-Turn Navigation.

### OnStar.com (U.S.) or OnStar.ca (Canada)

The website provides access to account information, allows management of the OnStar subscription, and viewing of videos of each service. Get subscription plan pricing and sign up for OnStar Vehicle Diagnostics. Click on the “My Account” tab on the home page. The website navigation and services provided may vary by country.

## OnStar Personal Identification Number (PIN)

A PIN is needed to access some of the OnStar services, like Remote Door Unlock and Stolen Vehicle Assistance. You will be prompted to change the PIN the first time when speaking with an Advisor. To change the OnStar PIN, call OnStar and provide the Advisor with the current number.

## Warranty

OnStar equipment may be warranted as part of the New Vehicle Limited Warranty. The manufacturer of the vehicle furnishes detailed warranty information.

## Languages

The vehicle can be programmed to respond in English, French or Spanish. Press  and ask an Advisor. Advisors can speak English, French or Spanish.

## Potential Issues

OnStar cannot perform Remote Door Unlock or Stolen Vehicle Assistance after the vehicle has been off continuously for five days. After five days, OnStar can contact Roadside Assistance and a locksmith to help gain access to the vehicle.

## Global Positioning System (GPS)

- Obstruction of the GPS can occur in a large city with tall buildings; in parking garages; around airports; in tunnels, underpasses, or parking garages; or in an area with very dense trees. If GPS signals are not available, the OnStar system should still operate to call OnStar. However, OnStar could have difficulty identifying the exact location.

- In emergency situations, OnStar can use the last stored GPS location to send to emergency responders.
- A temporary loss of GPS can cause loss of the ability to send a Turn-by-Turn Navigation route. The Advisor may give a verbal route or may ask for a call back after the vehicle is driven into an open area.

## Cellular and GPS Antennas

Avoid placing items over or near the antenna to prevent blocking cellular and GPS signal reception. Cellular reception is required for OnStar to send remote signals to the vehicle.

## Unable to Connect to OnStar Message

If there is limited cellular coverage or the cellular network has reached maximum capacity, this message may come on. Press  to try the call again or try again after driving a few miles into another cellular area.

### Vehicle and Power Issues

OnStar services require a vehicle electrical system, wireless service, and GPS satellite technologies to be available and operating for features to function properly. These systems may not operate if the battery is discharged or disconnected.

### Add-on Electrical Equipment

The OnStar system is integrated into the electrical architecture of the vehicle. Do not add any electrical equipment. See *Add-On Electrical Equipment on page 9-60*. Added electrical equipment may interfere with the operation of the OnStar system and cause it to not operate.

### Privacy

The complete OnStar Privacy Statement may be found at [www.onstar.com](http://www.onstar.com) (U.S.), or [www.onstar.ca](http://www.onstar.ca) (Canada). Privacy-sensitive users of wireless communications are cautioned that the privacy of any information sent via wireless cellular communications

cannot be assured. Third parties may unlawfully intercept or access transmissions and private communications without consent.

### OnStar - libcurl and unzip acknowledgments

Certain OnStar components include libcurl and unzip software. Below are the notices and licenses associated with this software:

#### libcurl:

#### COPYRIGHT AND PERMISSION NOTICE

Copyright (c) 1996 - 2010, Daniel Stenberg, <daniel@haxx.se>.

All rights reserved.

Permission to use, copy, modify, and distribute this software for any purpose with or without fee is hereby granted, provided that the above copyright notice and this permission notice appear in all copies.

THE SOFTWARE IS PROVIDED "AS IS," WITHOUT WARRANTY OF ANY KIND, EXPRESS OR IMPLIED, INCLUDING BUT NOT LIMITED TO THE WARRANTIES OF MERCHANTABILITY, FITNESS FOR A PARTICULAR PURPOSE AND NONINFRINGEMENT OF THIRD PARTY RIGHTS. IN NO EVENT SHALL THE AUTHORS OR COPYRIGHT HOLDERS BE LIABLE FOR ANY CLAIM, DAMAGES OR OTHER LIABILITY, WHETHER IN AN ACTION OF CONTRACT, TORT OR OTHERWISE, ARISING FROM, OUT OF OR IN CONNECTION WITH THE SOFTWARE OR THE USE OR OTHER DEALINGS IN THE SOFTWARE.

Except as contained in this notice, the name of a copyright holder shall not be used in advertising or otherwise to promote the sale, use or other dealings in this Software without prior written authorization of the copyright holder.



**unzip:**

This is version 2005-Feb-10 of the Info-ZIP copyright and license. The definitive version of this document should be available at <ftp://ftp.info-zip.org/pub/infozip/license.html> indefinitely.

Copyright (c) 1990-2005 Info-ZIP. All rights reserved.

For the purposes of this copyright and license, "Info-ZIP" is defined as the following set of individuals:

Mark Adler, John Bush, Karl Davis, Harald Denker, Jean-Michel Dubois, Jean-loup Gailly, Hunter Goatley, Ed Gordon, Ian Gorman, Chris Herborth, Dirk Haase, Greg Hartwig, Robert Heath, Jonathan Hudson, Paul Kienitz, David Kirschbaum, Johnny Lee, Onno van der Linden, Igor Mandrichenko, Steve P. Miller, Sergio Monesi, Keith Owens, George Petrov, Greg Roelofs, Kai Uwe Rommel, Steve Salisbury, Dave Smith, Steven M. Schweda,

Christian Spieler, Cosmin Truta, Antoine Verheijen, Paul von Behren, Rich Wales, Mike White

This software is provided "as is," without warranty of any kind, express or implied. In no event shall Info-ZIP or its contributors be held liable for any direct, indirect, incidental, special or consequential damages arising out of the use of or inability to use this software.

Permission is granted to anyone to use this software for any purpose, including commercial applications, and to alter it and redistribute it freely, subject to the following restrictions:

1. Redistributions of source code must retain the above copyright notice, definition, disclaimer, and this list of conditions.
2. Redistributions in binary form (compiled executables) must reproduce the above copyright notice, definition, disclaimer, and this list of conditions in documentation and/or other

materials provided with the distribution. The sole exception to this condition is redistribution of a standard UnZipSFX binary (including SFXWiz) as part of a self-extracting archive; that is permitted without inclusion of this license, as long as the normal SFX banner has not been removed from the binary or disabled.

3. Altered versions—including, but not limited to, ports to new operating systems, existing ports with new graphical interfaces, and dynamic, shared, or static library versions—must be plainly marked as such and must not be misrepresented as being the original source. Such altered versions also must not be misrepresented as being Info-ZIP releases—including, but not limited to, labeling of the altered versions with the names "Info-ZIP" (or any variation thereof, including, but not limited to, different capitalizations),

“Pocket UnZip,” “WiZ” or “MacZip” without the explicit permission of Info-ZIP. Such altered versions are further prohibited from misrepresentative use of the Zip-Bugs or Info-ZIP e-mail addresses or of the Info-ZIP URL(s).

4. Info-ZIP retains the right to use the names “Info-ZIP,” “Zip,” “UnZip,” “UnZipSFX,” “WiZ,” “Pocket UnZip,” “Pocket Zip,” and “MacZip” for its own source and binary releases.

**A**

Accessories and Modifications .....	10-2
Accessory Power .....	9-19
Add-On Electrical Equipment .....	9-60
Additional Information OnStar® .....	14-5
Air Cleaner/Filter, Engine .....	10-12
Air Conditioning .....	8-1
Air Vents .....	8-8
Airbag System Check .....	3-28
How Does an Airbag Restrain? .....	3-21
Passenger Sensing System .....	3-23
What Makes an Airbag Inflate? .....	3-21
What Will You See after an Airbag Inflates? .....	3-21
When Should an Airbag Inflate? .....	3-20
Where Are the Airbags? .....	3-18

Airbags Adding Equipment to the Vehicle .....	3-27
Passenger Status Indicator .....	5-16
Readiness Light .....	5-15
Serviceing Airbag-Equipped Vehicles .....	3-27
System Check .....	3-16
Alarm Vehicle Security .....	2-14
Antilock Brake System (ABS) .....	9-29
Warning Light .....	5-21
Appearance Care Exterior .....	10-77
Interior .....	10-80
Assistance Program, Roadside .....	13-5
Automatic Climate Control System .....	8-1
Door Locks .....	2-12
Headlamp System .....	6-2

**B**

Battery .....	10-22
Gauge .....	5-13
High Voltage .....	5-13
Jump Starting .....	10-68
Power Protection .....	6-5
Battery and Charging Messages. ....	5-43
Blade Replacement, Wiper ..	10-25
Brake Parking, Electric .....	9-30
System Warning Light .....	5-20
Brakes .....	10-20
Antilock .....	9-29
Fluid .....	10-21
Regenerative Braking .....	9-32
System Messages .....	5-44
Braking .....	9-5
Break-In, New Vehicle .....	9-16
Bulb Replacement .....	10-29
Back-up Lamps .....	10-28
Halogen Bulbs .....	10-27
Headlamp Aiming .....	10-26
Headlamps .....	10-27
License Plate Lamps .....	10-29
Buying New Tires .....	10-53

**C**

- Calibration ..... 5-13
- California
  - Fuel Requirements ..... 9-56
  - Perchlorate Materials
    - Requirements ..... 10-2
    - Warning ..... 10-2
- Camera, Rear Vision ..... 9-42
- Canadian Vehicle Owners ..... iii
- Capacities and
  - Specifications ..... 12-2
- Carbon Monoxide
  - Engine Exhaust ..... 9-26
  - Hatch ..... 2-13
  - Winter Driving ..... 9-9
- Cargo
  - Cover ..... 4-4
- Cautions, Danger, and
  - Warnings ..... iii
- Chains, Tire ..... 10-59
- Charge Cord ..... 9-53
- Charging
  - Delay Override ..... 9-49
  - Electrical Requirements ..... 9-54
  - Plug-In ..... 9-47
  - Programmable ..... 5-29
  - Utility Interruption ..... 9-54
- Charging Status Screens ..... 9-49
- Charging System Light ..... 5-17
- Check
  - Engine Light ..... 5-17
- Child Restraints
  - Infants and Young
    - Children ..... 3-31
    - Lower Anchors and
      - Tethers for Children ..... 3-37
    - Older Children ..... 3-29
  - Securing ..... 3-43, 3-46
  - Systems ..... 3-34
- Cleaning
  - Exterior Care ..... 10-77
  - Interior Care ..... 10-80
- Climate Control Systems
  - Automatic ..... 8-1
- Clock ..... 5-40
- Cluster, Instrument ..... 5-8
- Collision Damage Repair ..... 13-9
- Compass ..... 5-13
- Compressor Kit, Tire
  - Sealant ..... 10-60
- Connections
  - OnStar® ..... 14-3
- Control of a Vehicle ..... 9-5
- Convex Mirrors ..... 2-16
- Coolant
  - Engine ..... 10-16
  - Engine Temperature
    - Warning Light ..... 5-23
- Cooling System ..... 10-14–10-16
  - Engine Messages ..... 5-45
- Courtesy Transportation
  - Program ..... 13-7
- Cover
  - Cargo ..... 4-4
- Cruise Control ..... 9-35
  - Light ..... 5-26
  - Messages ..... 5-44
- Customer Assistance ..... 13-4
  - Offices ..... 13-3
  - Text Telephone (TTY)
    - Users ..... 13-4

Customer Information  
 Service Publications  
     Ordering Information .....13-11  
 Customer Satisfaction  
     Procedure ..... 13-1

**D**

Damage Repair, Collision ..... 13-9  
 Danger, Warnings, and  
     Cautions ..... iii  
 Data Recorders, Event ..... 13-14  
 Daytime Running  
     Lamps (DRL) ..... 6-2  
 Defensive Driving ..... 9-4  
 Delayed Charging Override .... 9-49  
 Delayed Locking ..... 2-11  
 Diagnostics  
     OnStar® ..... 14-4  
 Distracted Driving ..... 9-4  
 Dome Lamps ..... 6-4  
 Door  
     Ajar Messages ..... 5-44  
     Delayed Locking ..... 2-11  
     Locks ..... 2-10  
     Power Locks ..... 2-11

Drive Belt Routing, Engine ..... 12-3  
 Drive Mode Messages ..... 5-45  
 Drive Unit  
     Electric ..... 9-27  
 Driver Efficiency Gauge ..... 5-14  
 Driver Information  
     Center (DIC) ..... 5-41  
 Driver Selected Operating  
     Modes ..... 9-22  
 Driving  
     Defensive ..... 9-4  
     Drunk ..... 9-5  
     Highway Hypnosis ..... 9-8  
     Hill and Mountain Roads ..... 9-8  
     If the Vehicle is Stuck ..... 9-11  
     Loss of Control ..... 9-7  
     Off-Road Recovery ..... 9-6  
     Vehicle Load Limits ..... 9-11  
     Wet Roads ..... 9-7  
     Winter ..... 9-9  
 Driving for Better  
     Energy Efficiency ..... 1-25, 9-2

**E**

Electric Drive Unit ..... 9-27  
 Electric Drive Unit  
     Messages ..... 5-45  
 Electric Drive Unit Shift  
     Lock Control Function  
         Check ..... 10-24  
 Electric Mode ..... 9-21  
 Electric Parking Brake ..... 9-30  
 Electric Parking Brake Light ... 5-20  
 Electrical Equipment,  
     Add-On ..... 9-60  
 Electrical Requirements for  
     Battery Charging ..... 9-54  
 Electrical System  
     Engine Compartment  
         Fuse Block ..... 10-31  
     Instrument Panel  
         Fuse Block ..... 10-34, 10-35  
     Overload ..... 10-30  
     Rear Compartment Fuse  
         Block ..... 10-38  
 Electronic Stability Control .... 9-34  
 Emergency  
     OnStar® ..... 14-2

Energy Efficiency  
  Driving ..... 1-25, 9-2  
Energy Information ..... 5-39  
Engine  
  Air Cleaner/Filter ..... 10-12  
  Check and Service Engine  
    Soon Light ..... 5-17  
  Compartment Overview ..... 10-8  
  Coolant ..... 10-16  
  Coolant Temperature  
    Warning Light ..... 5-23  
  Cooling System ..... 10-14–10-16  
  Cooling System Messages ... 5-45  
  Drive Belt Routing ..... 12-3  
  Exhaust ..... 9-26  
  Oil Life System ..... 10-12  
  Oil Messages ..... 5-45  
  Overheating ..... 10-19  
  Pressure Light ..... 5-24  
  Running While Parked ..... 9-27  
Engine Unavailable  
  Out of Fuel ..... 9-24  
Entry Lighting ..... 6-5  
Event Data Recorders ..... 13-14

Exit Lighting ..... 6-5  
Extended Range Mode ..... 9-21  
Extender, Safety Belt ..... 3-14  
Exterior Lamp Controls ..... 6-1

## F

Filter,  
  Engine Air Cleaner ..... 10-12  
Flash-to-Pass ..... 6-2  
Flashers, Hazard Warning ..... 6-3  
Flat Tire ..... 10-59  
Floor Console Storage ..... 4-1  
Floor Mats ..... 10-83  
Fluid  
  Brakes ..... 10-21  
  Washer ..... 10-19  
Folding Mirrors ..... 2-16  
Forward Collision Alert  
  (FCA) System ..... 9-38  
Forward Collision Alert  
  (FCA) Warning Light ..... 5-22  
Front Seats  
  Adjustment ..... 3-3  
  Heated ..... 3-5

Fuel ..... 9-55  
  Additives ..... 9-56  
  Filling a Portable Fuel  
    Container ..... 9-59  
  Filling the Tank ..... 9-57  
  Foreign Countries ..... 9-56  
  Gasoline Specifications ..... 9-56  
  Gauge ..... 5-13  
  Low Fuel Warning Light ..... 5-25  
  Requirements, California ... 9-56  
  System Messages ..... 5-46  
Function Check  
  Electric Drive Unit Shift  
    Lock Control ..... 10-24  
Fuses  
  Engine Compartment  
    Fuse Block ..... 10-31  
  Instrument Panel  
    Fuse Block ..... 10-34, 10-35  
  Rear Compartment Fuse  
    Block ..... 10-38

**G**

Garage Door Opener ..... 5-59  
 Programming ..... 5-59  
 Gasoline  
 Specifications ..... 9-56  
 Gauges  
 Battery ..... 5-13  
 Driver Efficiency ..... 5-14  
 Fuel ..... 5-13  
 Odometer ..... 5-12  
 Speedometer ..... 5-12  
 Trip Odometer ..... 5-13  
 Warning Lights and  
 Indicators ..... 5-8  
 General Information  
 Service and Maintenance .... 11-1  
 Towing ..... 9-60  
 Vehicle Care ..... 10-2  
 Glove Box ..... 4-1  
 GM Mobility Reimbursement  
 Program ..... 13-5

**H**

Halogen Bulbs ..... 10-27  
 Hatch ..... 2-13  
 Hazard Warning Flashers ..... 6-3  
 Head Restraints ..... 3-2  
 Headlamps ..... 10-27  
 Aiming ..... 10-26  
 Automatic ..... 6-2  
 Bulb Replacement ..... 10-27  
 Daytime Running  
 Lamps (DRL) ..... 6-2  
 Flash-to-Pass ..... 6-2  
 High-Beam On Light ..... 5-25  
 High/Low Beam Changer ..... 6-1  
 Lamps On Reminder ..... 5-25  
 Heated Front Seats ..... 3-5  
 Heated Mirrors ..... 2-17  
 Heating and Air Conditioning ... 8-1  
 High Voltage Battery Gauge ... 5-13  
 High Voltage Devices and  
 Wiring ..... 10-30  
 High-Beam On Light ..... 5-25  
 Highway Hypnosis ..... 9-8  
 Hill and Mountain Roads ..... 9-8  
 Hold Mode Light ..... 5-22  
 Hood ..... 10-6

Hood, Door, Hatch Open  
 Light ..... 5-26  
 Horn ..... 5-6  
 How to Wear Safety Belts  
 Properly ..... 3-10

**I**

Immobilizer ..... 2-15  
 Infants and Young Children,  
 Restraints ..... 3-31  
 Information  
 Energy ..... 5-39  
 Infotainment ..... 7-1  
 Infotainment System ..... 13-15  
 Instrument Cluster ..... 5-8  
 Instrument Panel  
 Storage Area ..... 4-1  
 Introduction ..... iii

**J**

Jump Starting ..... 10-68

**K**

- Key and Lock Messages ..... 5-46
- Keyless Entry
  - Remote (RKE) System ..... 2-2
- Keys ..... 2-1

**L**

- Labeling, Tire Sidewall ..... 10-41
- Lamps
  - Daytime Running (DRL) ..... 6-2
  - Dome ..... 6-4
  - Exterior Controls ..... 6-1
  - License Plate ..... 10-29
  - Malfunction Indicator ..... 5-17
  - Messages ..... 5-47
  - On Reminder ..... 5-25
  - Reading ..... 6-4
- Lane Departure Warning ..... 9-44
- Lane Departure Warning Light ..... 5-22
- Lap-Shoulder Belt ..... 3-11
- LATCH System
  - Replacing Parts after a Crash ..... 3-43
- LATCH, Lower Anchors and Tethers for Children ..... 3-37

- LED Lighting ..... 10-27
- Lifting the Vehicle, Tires ..... 10-3
- Light
  - Hold Mode ..... 5-22
  - Ready Indicator ..... 5-25
  - Vehicle Ready ..... 5-25
- Lighting
  - Entry ..... 6-5
  - Exit ..... 6-5
  - Illumination Control ..... 6-4
  - LED ..... 10-27
- Lights
  - Airbag Readiness ..... 5-15
  - Antilock Brake System (ABS) Warning ..... 5-21
  - Brake System Warning ..... 5-20
  - Charging System ..... 5-17
  - Cruise Control ..... 5-26
  - Electric Parking Brake ..... 5-20
  - Engine Coolant Temperature Warning ..... 5-23
  - Engine Oil Pressure ..... 5-24
  - Flash-to-Pass ..... 6-2
  - High-Beam On ..... 5-25
  - High/Low Beam Changer ..... 6-1
  - Hood, Door, Hatch Open ..... 5-26

**Lights (cont'd)**

- Lane Departure Warning ..... 5-22
  - Low Fuel Warning ..... 5-25
  - Mountain Mode ..... 5-21
  - Safety Belt Reminders ..... 5-14
  - Security ..... 5-25
  - Service Electric Parking Brake ..... 5-20
  - Sport Mode ..... 5-21
  - StabiliTrak<sup>®</sup> OFF ..... 5-23
  - Tire Pressure ..... 5-24
  - Traction Control System (TCS)/StabiliTrak<sup>®</sup> ..... 5-23
  - Traction Off ..... 5-22
- Locks**
- Automatic Door ..... 2-12
  - Delayed Locking ..... 2-11
  - Door ..... 2-10
  - Lockout Protection ..... 2-12
  - Power Door ..... 2-11
  - Safety ..... 2-12
- Loss of Control ..... 9-7**
- Low Fuel Warning Light ..... 5-25
- Lower Anchors and Tethers for Children (LATCH System) ..... 3-37**



**M**

Maintenance	
Records .....	11-14
Maintenance Modes .....	9-25
Maintenance Schedule	
Recommended Fluids	
and Lubricants .....	11-12
Malfunction Indicator Lamp ....	5-17
Messages	
Airbag System .....	5-49
Brake System .....	5-44
Door Ajar .....	5-44
Drive Mode .....	5-45
Electric Drive Unit .....	5-45
Engine Cooling System .....	5-45
Engine Oil .....	5-45
Fuel System .....	5-46
Key and Lock .....	5-46
Lamp .....	5-47
Object Detection System .....	5-47
Propulsion Power .....	5-48
Ride Control System .....	5-48
Security .....	5-49
Service Vehicle .....	5-49
Starting the Vehicle .....	5-50
Tire .....	5-50

Messages (cont'd)	
Vehicle .....	5-43
Vehicle Reminder .....	5-51
Vehicle Speed .....	5-51
Mirrors	
Automatic Dimming	
Rearview .....	2-17
Convex .....	2-16
Folding .....	2-16
Heated .....	2-17
Manual Rearview .....	2-17
Power .....	2-16
Mode	
Electric .....	9-21
Extended Range .....	9-21
Hold Light .....	5-22
Modes	
Driver Selected .....	9-22
Maintenance .....	9-25
Monitor System, Tire	
Pressure .....	10-47
Mountain Mode Light .....	5-21

**N**

Navigation	
OnStar® .....	14-2
New Vehicle Break-In .....	9-16

**O**

Object Detection System	
Messages .....	5-47
Odometer .....	5-12
Trip .....	5-13
Off-Road	
Recovery .....	9-6
Oil	
Engine .....	10-9
Engine Oil Life System .....	10-12
Messages .....	5-45
Pressure Light .....	5-24
Older Children, Restraints .....	3-29
Online Owner Center .....	13-4
OnStar®	
System, In Brief .....	1-27
OnStar® Additional	
Information .....	14-5
OnStar® Connections .....	14-3
OnStar® Diagnostics .....	14-4
OnStar® Emergency .....	14-2

OnStar® Navigation .....	14-2
OnStar® Overview .....	14-1
OnStar® Security .....	14-2
Ordering	
Service Publications .....	13-11
Out of Fuel/Engine	
Unavailable .....	9-24
Outlets	
Power .....	5-7
Overheating, Engine .....	10-19

## **P**

Park	
Shifting Into .....	9-19
Shifting Out of .....	9-20
Parking	
Assist, Ultrasonic .....	9-40
Brake and P (Park)	
Mechanism Check .....	10-25
Over Things That Burn .....	9-20
Passenger Airbag Status	
Indicator .....	5-16
Passenger Sensing System ...	3-23
Perchlorate Materials	
Requirements, California .....	10-2

Personalization	
Vehicle .....	5-51
Plug-In Charging .....	9-47
Power	
Button .....	9-16
Door Locks .....	2-11
Flows .....	5-27
Mirrors .....	2-16
Outlets .....	5-7
Protection, Battery .....	6-5
Retained Accessory (RAP) ...	9-19
Windows .....	2-18
Pregnancy, Using Safety	
Belts .....	3-14
Privacy	
Radio Frequency	
Identification (RFID) .....	13-15
Program	
Courtesy Transportation .....	13-7
Programmable Charging .....	5-29
Proposition 65 Warning,	
California .....	10-2
Propulsion Power	
Messages .....	5-48

## **R**

Radio Frequency	
Identification (RFID) .....	13-15
Statement .....	13-15
Reading Lamps .....	6-4
Ready Indicator .....	5-25
Rear Seats .....	3-7
Rear Vision Camera (RVC) ...	9-42
Rearview Mirrors .....	2-17
Automatic Dimming .....	2-17
Reclining Seatbacks .....	3-4
Recommended Fluids and	
Lubricants .....	11-12
Records	
Maintenance .....	11-14
Recreational Vehicle	
Towing .....	10-76
Regenerative Braking .....	9-32
Reimbursement Program,	
GM Mobility .....	13-5
Remote Keyless Entry (RKE)	
System .....	2-2
Remote Start .....	2-8
Replacement Bulbs .....	10-29

Replacement Parts  
 Airbags ..... 3-29  
 Maintenance ..... 11-13  
 Replacing Airbag System ..... 3-29  
 Replacing LATCH System  
 Parts after a Crash ..... 3-43  
 Replacing Safety Belt  
 System Parts after a Crash ... 3-15  
 Reporting Safety Defects  
 Canadian Government ..... 13-13  
 General Motors ..... 13-13  
 U.S. Government ..... 13-12  
 Requirements  
 Electrical Battery Charging ... 9-54  
 Restraints  
 Where to Put ..... 3-35  
 Retained Accessory  
 Power (RAP) ..... 9-19  
 Ride Control Systems ..... 9-34  
 Electronic Stability (ESC) ..... 9-34  
 Messages ..... 5-48  
 Roads  
 Driving, Wet ..... 9-7  
 Roadside Assistance  
 Program ..... 13-5

Rotation, Tires ..... 10-52  
 Routing, Engine Drive Belt ..... 12-3  
 Running the Vehicle While  
 Parked ..... 9-27

**S**

Safety Belts ..... 3-9  
 Care ..... 3-15  
 Extender ..... 3-14  
 How to Wear Safety Belts  
 Properly ..... 3-10  
 Lap-Shoulder Belt ..... 3-11  
 Reminders ..... 5-14  
 Replacing after a Crash ..... 3-15  
 Use During Pregnancy ..... 3-14  
 Safety Defects Reporting  
 Canadian Government ..... 13-13  
 General Motors ..... 13-13  
 U.S. Government ..... 13-12  
 Safety Locks ..... 2-12  
 Safety System Check ..... 3-15  
 Scheduling Appointments ..... 13-7  
 Sealant Kit, Tire ..... 10-60

Seats  
 Adjustment, Front ..... 3-3  
 Head Restraints ..... 3-2  
 Heated Front ..... 3-5  
 Rear ..... 3-7  
 Reclining Seatbacks ..... 3-4  
 Securing Child  
 Restraints ..... 3-43, 3-46  
 Security  
 Light ..... 5-25  
 Messages ..... 5-49  
 OnStar® ..... 14-2  
 Vehicle ..... 2-14  
 Vehicle Alarm ..... 2-14  
 Service  
 Accessories and  
 Modifications ..... 10-2  
 Doing Your Own Work ..... 10-5  
 Engine Soon Light ..... 5-17  
 Maintenance Records ..... 11-14  
 Maintenance, General  
 Information ..... 11-1  
 Parts Identification Label ..... 12-1

Service (cont'd)	
Publications Ordering	
Information .....	13-11
Scheduling Appointments .....	13-7
Vehicle Messages .....	5-49
Service Electric Parking	
Brake Light .....	5-20
Servicing the Airbag .....	3-27
Shifting	
Into Park .....	9-19
Out of Park .....	9-20
Signals, Turn and	
Lane-Change .....	6-3
Specifications and	
Capacities .....	12-2
Speedometer .....	5-12
Sport Mode Light .....	5-21
StabiliTrak	
OFF Light .....	5-23
Start	
Remote .....	2-8
Starting and Stopping the	
Vehicle .....	9-17

Starting the Vehicle	
Messages .....	5-50
Status Screens	
Charging .....	9-49
Steering .....	9-5
Wheel Adjustment .....	5-5
Wheel Controls .....	5-5
Storage Areas	
Cargo Cover .....	4-4
Floor Console .....	4-1
Glove Box .....	4-1
Instrument Panel .....	4-1
Umbrella .....	4-4
Storing the Tire Sealant	
and Compressor Kit .....	10-67
Stuck Vehicle .....	9-11
Sun Visors .....	2-20
Symbols .....	iv
System	
Forward Collision	
Alert (FCA) .....	9-38
Infotainment .....	13-15, 7-1
System Operation .....	9-21

**T**

Text Telephone (TTY) Users ...	13-4
Theft-Deterrent Systems .....	2-15
Immobilizer .....	2-15
Tires	
Buying New Tires .....	10-53
Chains .....	10-59
Designations .....	10-42
Different Size .....	10-55
If a Tire Goes Flat .....	10-59
Inflation Monitor System ....	10-48
Inspection .....	10-51
Lifting the Vehicle .....	10-3
Messages .....	5-50
Pressure Light .....	5-24
Pressure Monitor System ...	10-47
Rotation .....	10-52
Sealant and	
Compressor Kit .....	10-60
Sealant and Compressor	
Kit, Storing .....	10-67
Sidewall Labeling .....	10-41
Terminology and	
Definitions .....	10-43
Uniform Tire Quality	
Grading .....	10-56

Tires (cont'd)

- Wheel Alignment and Tire Balance ..... 10-57
- Wheel Replacement ..... 10-57
- When It Is Time for New Tires ..... 10-53
- Winter ..... 10-41
- Total Vehicle Range ..... 5-14
- Towing
  - General Information ..... 9-60
  - Recreational Vehicle ..... 10-76
  - Vehicle ..... 10-73
- Traction
  - Control System (TCS) ..... 9-32
  - Control System (TCS)/StabiliTrak® Light ..... 5-23
  - Off Light ..... 5-22
- Transportation Program, Courtesy ..... 13-7
- Trip Odometer ..... 5-13
- Turn and Lane-Change Signals ..... 6-3

**U**

- Ultrasonic Parking Assist ..... 9-40
- Umbrella Storage ..... 4-4
- Uniform Tire Quality Grading ..... 10-56
- Universal Remote System ..... 5-59
  - Operation ..... 5-62
  - Programming ..... 5-59
- Using This Manual ..... iii
- Utility Interruption of Charging ..... 9-54

**V**

Vehicle

- Alarm System ..... 2-14
- Canadian Owners ..... iii
- Control ..... 9-5
- Identification
  - Number (VIN) ..... 12-1
- Load Limits ..... 9-11
- Messages ..... 5-43
- Personalization ..... 5-51
- Reminder Messages ..... 5-51
- Security ..... 2-14
- Speed Messages ..... 5-51

Vehicle (cont'd)

- Starting and Stopping ..... 9-17
- Total Range ..... 5-14
- Towing ..... 10-73
- Vehicle Care
  - Storing the Tire Sealant and Compressor Kit ..... 10-67
  - Tire Pressure ..... 10-46
- Vehicle Ready Light ..... 5-25
- Ventilation, Air ..... 8-8
- Visors ..... 2-20
- Voltage Devices and Wiring ..... 10-30

**W**

Warning

- Brake System Light ..... 5-20
- Warning Light
  - Forward Collision Alert (FCA) ..... 5-22
- Warning Lights, Gauges, and Indicators ..... 5-8
- Warnings ..... iii
  - Cautions and Danger ..... iii
  - Hazard Flashers ..... 6-3
- Washer Fluid ..... 10-19

Wheels	
Alignment and Tire	
Balance .....	10-57
Different Size .....	10-55
Replacement .....	10-57
When It Is Time for New	
Tires .....	10-53
Where to Put the Restraint ....	3-35
Windows .....	2-18
Power .....	2-18
Windshield	
Wiper/Washer .....	5-6
Winter	
Driving .....	9-9
Winter Tires .....	10-41
Wiper Blade Replacement ....	10-25
Wiring, High Voltage	
Devices .....	10-30