



owner.ford.com



ford.ca

April 2021  
First Printing  
Litho in U.S.A.



NC3J19A321 AA



The information contained in this publication was correct at the time of going to print. In the interest of continuous development, we reserve the right to change specifications, design or equipment at any time without notice or obligation. No part of this publication may be reproduced, transmitted, stored in a retrieval system or translated into any language in any form by any means without our written permission. Errors and omissions excepted.

© Ford Motor Company 2021

All rights reserved.

Part Number: 202103 20210330115440

## California Proposition 65



**WARNING:** Operating, servicing and maintaining a passenger vehicle or off-highway motor vehicle can expose you to chemicals including engine exhaust, carbon monoxide, phthalates, and lead, which are known to the State of California to cause cancer and birth defects or other reproductive harm. To minimize exposure, avoid breathing exhaust, do not idle the engine except as necessary, service your vehicle in a well-ventilated area and wear gloves or wash your hands frequently when servicing your vehicle. For more information go to [www.P65Warnings.ca.gov/passenger-vehicle](http://www.P65Warnings.ca.gov/passenger-vehicle).



**WARNING:** Battery posts, terminals and related accessories contain lead and lead compounds, chemicals known to the State of California to cause cancer and reproductive harm.  
**Wash your hands after handling.**



# Table of Contents

---

## Contacting Us

Contacting Us .....	17
---------------------	----

## Introduction

About This Publication .....	19
Using This Publication .....	20

## Symbols Glossary

Symbols Used on Your Vehicle .....	21
------------------------------------	----

## Data Privacy

Data Privacy .....	24
Service Data .....	25
Event Data .....	25
Settings Data .....	26
Connected Vehicle Data .....	26
Mobile Device Data - Vehicles With: SYNC 3 .....	27
Mobile Device Data - Vehicles With: SYNC 4 .....	27
Emergency Call System Data .....	28

## Visual Search

Steering Wheel - Vehicles With: SYNC 4 .....	29
Steering Wheel - Vehicles With: SYNC 3 .....	30
Instrument Panel .....	31
Vehicle Interior .....	32
Front Exterior .....	33
Rear Exterior .....	34

## Child Safety

Child Safety Precautions .....	35
Child Restraint Anchor Points .....	36
Child Restraints .....	38
Installing Child Restraints .....	39
Booster Seats .....	46
Child Safety Locks .....	48

## Seatbelts

Seatbelt Precautions .....	49
Fastening and Unfastening the Seatbelts .....	50
Sensitive Locking Mode .....	51
Automatic Locking Mode .....	51
Adjusting the Seatbelts During Pregnancy .....	52
Adjusting the Seatbelt Height .....	52
Adjusting the Seatbelt Length .....	53
Seatbelt Reminder .....	53
Checking the Seatbelts .....	55
Seatbelt Extensions .....	56

## Airbags

How Do the Front Airbags Work .....	57
How Do the Side Airbags Work .....	57
How Does the Safety Canopy™ Work .....	58
Airbag Precautions .....	59
Switching the Passenger Airbag On and Off .....	60
Properly Adjusting the Driver and Front Passenger Seats .....	64
Children and Airbags .....	64
Crash Sensors and Airbag Indicator .....	65
Disposing of Airbags .....	66

## 911 Assist

What Is 911 Assist .....	67
How Does 911 Assist Work .....	67
Emergency Call Requirements .....	67
Emergency Call Limitations .....	68

## Keys and Remote Controls

Remote Control Limitations .....	69
Using the Remote Control .....	69
Opening and Closing the Flip Key .....	69
Removing the Key Blade .....	70
Sounding the Panic Alarm .....	70

# Table of Contents

Locating Your Vehicle .....	70	Keyless Entry – Troubleshooting .....	88
Changing the Remote Control Battery .....	71	<b>Keyless Entry Keypad</b>	
Changing the Remote Control Battery - Vehicles With: Flip Key .....	72	What Is the Keyless Entry Keypad .....	89
Replacing a Lost Key or Remote Control .....	73	Keyless Entry Keypad Limitations .....	89
Programming the Remote Control .....	74	Locating the Keyless Entry Keypad .....	89
Programming the Remote Control - Vehicles With: Flip Key .....	75	Keyless Entry Keypad Master Access Code .....	89
Keys and Remote Controls – Troubleshooting .....	76	Keyless Entry Keypad Personal Access Codes .....	90
<b>MyKey™</b>		Using the Keyless Entry Keypad .....	91
What Is MyKey .....	77	Keyless Entry Keypad – Troubleshooting .....	91
MyKey Settings .....	77	<b>Easy Entry and Exit</b>	
Creating a MyKey .....	78	How Does Easy Entry and Exit Work .....	93
Creating a MyKey - Vehicles With: Flip Key .....	79	Switching Easy Entry and Exit On and Off .....	93
Programming a MyKey .....	79	<b>Tailgate - Vehicles With: Manual Tailgate</b>	
Clearing All MyKeys .....	79	Tailgate Precautions .....	94
Checking MyKey System Status .....	80	Opening the Tailgate .....	94
Using MyKey With Remote Start Systems .....	80	Locking and Unlocking the Tailgate .....	94
MyKey – Troubleshooting .....	80	Removing and Installing the Tailgate .....	94
<b>Doors and Locks</b>		Tailgate Step .....	95
Operating the Doors From Outside Your Vehicle .....	83	Bed Extender .....	96
Operating the Doors From Inside Your Vehicle .....	83	<b>Tailgate - Vehicles With: Remote Release Tailgate</b>	
Autounlock .....	84	Tailgate Precautions .....	99
Autolock .....	84	Opening the Tailgate .....	99
Mislock .....	84	Removing and Installing the Tailgate .....	99
Doors and Locks Audible Warnings .....	84	Tailgate Step .....	100
Doors and Locks – Troubleshooting .....	85	Bed Extender .....	101
<b>Keyless Entry</b>		Tailgate – Troubleshooting .....	104
Keyless Entry Limitations .....	87		
Keyless Entry Settings .....	87		
Using Keyless Entry .....	87		

# Table of Contents

## Security

Passive Anti-Theft System .....	106
Anti-Theft Alarm System .....	106
Anti-Theft Alarm System Settings .....	107
Security – Troubleshooting .....	108

## Power Running Boards

Power Running Board Precautions .....	110
Power Running Board Settings .....	110
Deploying and Stowing the Power Running Boards .....	110
Power Running Boards – Troubleshooting .....	110

## Steering Wheel

Adjusting the Steering Wheel - Vehicles With: Power Adjustable Steering Column .....	111
Adjusting the Steering Wheel - Vehicles With: Manual Adjustable Steering Column .....	112
Resetting the Stopping Position - Vehicles With: Power Adjustable Steering Column .....	112
Horn .....	112
Switching the Heated Steering Wheel On and Off .....	112

## Adjustable Pedals

Adjusting the Pedals .....	114
----------------------------	-----

## Wipers and Washers

Wipers .....	115
Autowipers .....	115
Checking the Wiper Blades .....	116
Replacing the Front Wiper Blades .....	116
Washers .....	116
Wipers and Washers – Troubleshooting .....	117

## Exterior Lighting

Exterior Lighting Control .....	118
---------------------------------	-----

Headlamps .....	118
Headlamps – Troubleshooting .....	118
Autolamps .....	119
Exterior Lamps .....	119
Automatic High Beam Control .....	121
Automatic High Beam Control – Troubleshooting .....	123

## Interior Lighting

Switching All of the Interior Lamps On and Off .....	124
Switching the Front Interior Lamps On and Off .....	124
Switching the Rear Interior Lamps On and Off .....	124
Interior Lamp Function .....	124
Adjusting the Instrument Panel Lighting Brightness .....	125
Ambient Lighting .....	125
Interior Lighting – Troubleshooting .....	125

## Windows

Opening and Closing the Windows .....	126
Window Bounce-Back .....	126
Locking the Rear Window Controls .....	127
Opening and Closing the Sliding Windows .....	127

## Interior Mirror

Interior Mirror Precautions .....	128
Manually Dimming the Interior Mirror .....	128
Auto-Dimming Interior Mirror .....	128

## Exterior Mirrors

Adjusting the Exterior Mirrors .....	129
Folding the Exterior Mirrors - Vehicles With: Manual Folding Mirrors .....	129
Folding the Exterior Mirrors - Vehicles With: Power Folding Mirrors .....	129
Extending the Exterior Mirrors .....	130
Auto-Dimming Exterior Mirror .....	130

# Table of Contents

## **Moonroof**

Opening and Closing the Sun Shade .....	131
Opening and Closing the Moonroof .....	131
Venting the Moonroof .....	131
Moonroof Bounce-Back .....	132

## **Instrument Cluster**

Instrument Cluster Overview - Vehicles With: 2.3 Inch Screen .....	133
Instrument Cluster Overview - Vehicles With: 4.2 Inch Screen .....	134
Instrument Cluster Overview - Vehicles With: 8 Inch Screen .....	135
What Is the Tachometer .....	135
What Is the Speedometer .....	135
Fuel Gauge .....	136
What Is the Engine Coolant Temperature Gauge .....	136
What Is the Engine Oil Pressure Gauge .....	136
What Is the Transmission Fluid Temperature Gauge .....	136
What Is the Turbo Boost Gauge .....	136
What Is the Diesel Exhaust Fluid Gauge .....	136
What Are the Instrument Cluster Warning Lamps .....	137
Instrument Cluster Warning Lamps .....	137
What Are the Instrument Cluster Indicators .....	138
Instrument Cluster Indicators .....	138

## **Instrument Cluster Display**

Using the Instrument Cluster Display Controls .....	141
Instrument Cluster Display Main Menu - Vehicles With: 2.3 Inch Screen .....	141
Instrument Cluster Display Main Menu - Vehicles With: 4.2 Inch Screen .....	141
Instrument Cluster Display Main Menu - Vehicles With: 8 Inch Screen .....	142

Customizing the Instrument Cluster Display - Vehicles With: 8 Inch Screen .....	142
Personalized Settings .....	142

## **Trip Computer**

Accessing the Trip Computer - Vehicles With: 2.3 Inch Screen .....	145
Accessing the Trip Computer - Vehicles With: 4.2 Inch Screen .....	145
Accessing the Trip Computer - Vehicles With: 8 Inch Screen .....	145
Resetting the Trip Computer .....	145
Resetting the Individual Trip Values .....	145
Configuring the Trip Computer .....	145
Trip Data .....	145

## **Remote Start**

What Is Remote Start .....	146
Remote Start Precautions .....	146
Remote Start Limitations .....	146
Enabling Remote Start .....	146
Remotely Starting and Stopping the Vehicle .....	146
Extending the Remote Start Duration .....	147
Remote Start Remote Control Indicators .....	147
Remote Start Settings .....	147

## **Climate Control - Vehicles With: Automatic Temperature Control**

Identifying the Climate Control Unit .....	149
Switching Climate Control On and Off .....	149
Switching Recirculated Air On and Off .....	149
Switching Air Conditioning On and Off .....	149
Switching Defrost On and Off .....	149

# Table of Contents

---

Switching Maximum Defrost On and Off .....	149
Switching Maximum Cooling On and Off .....	150
Switching the Heated Rear Window On and Off .....	150
Setting the Blower Motor Speed .....	150
Setting the Temperature .....	150
Directing the Flow of Air .....	150
Auto Mode .....	151
Climate Control Hints .....	152
Sitting in the Correct Position .....	158
Manual Seats .....	159
Power Seats .....	161
Massage Seats .....	164
Heated Seats .....	165
Ventilated Seats .....	165

## Rear Seats

Manual Seats .....	167
Heated Seats .....	169

## Climate Control - Vehicles With: Manual Temperature Control

Identifying the Climate Control Unit .....	154
Switching Climate Control On and Off .....	154
Switching Recirculated Air On and Off .....	154
Switching Air Conditioning On and Off .....	154
Switching Defrost On and Off .....	154
Switching Maximum Defrost On and Off .....	154
Switching Maximum Cooling On and Off .....	154
Switching the Heated Rear Window On and Off .....	155
Switching the Heated Mirrors On and Off .....	155
Setting the Blower Motor Speed .....	155
Setting the Temperature .....	155
Directing the Flow of Air .....	155
Climate Control Hints .....	156

## Interior Air Quality

What Is the Cabin Air Filter .....	157
Replacing the Cabin Air Filter .....	157

## Front Seats

Front Seat Precautions .....	158
------------------------------	-----

## Rear Occupant Alert System

What is the Rear Occupant Alert System .....	171
How Does the Rear Occupant Alert System Work .....	171
Rear Occupant Alert System Precautions .....	171
Rear Occupant Alert System Limitations .....	171
Switching Rear Occupant Alert System On and Off - Vehicles With: SYNC .....	171
Switching Rear Occupant Alert System On and Off - Vehicles With: SYNC 3 .....	172
Switching Rear Occupant Alert System On and Off - Vehicles With: SYNC 4 .....	172
Rear Occupant Alert System Indicators - Vehicles With: SYNC .....	172
Rear Occupant Alert System Indicators - Vehicles With: SYNC 3/SYNC 4 .....	172
Rear Occupant Alert System Audible Warnings .....	173

## Memory Function

What Is the Memory Function .....	174
Memory Function Precautions .....	174
Locating the Memory Function Buttons .....	174
Saving a Preset Position .....	174



# Table of Contents

---

Recalling a Preset Position .....174

## **Garage Door Opener**

What Is the Garage Door Opener .....176

How Does the Garage Door Opener Work  
.....176

Garage Door Opener Precautions .....176

Garage Door Opener Limitations .....176

Programming the Garage Door Opener  
to Your Hand-Held Transmitter .....177

Programming the Garage Door Opener  
to Your Garage Door Opener Motor  
.....177

Programming the Garage Door Opener  
to Your Gate Opener Motor .....178

Clearing the Garage Door Opener .....178

Reprogramming the Garage Door Opener  
.....179

Garage Door Opener Radio Frequencies  
.....179

## **USB Ports**

Locating the USB Ports .....180

Playing Media Using the USB Port .....180

Charging a Device .....181

## **Power Outlet - Vehicles With: 120V Power Outlet**

What Is the Power Outlet .....182

Power Outlet Precautions .....182

Power Outlet Limitations .....182

Locating the Power Outlet .....182

Power Outlet Indicators .....182

## **Power Outlet - Vehicles With: 12V Power Outlet**

What Is the Power Outlet .....184

Power Outlet Precautions .....184

Locating the Power Outlet .....184

## **Wireless Accessory Charger**

What Is the Wireless Accessory Charger  
.....185

Wireless Accessory Charger Precautions  
.....185

Locating the Wireless Accessory Charger  
.....185

Charging a Wireless Device .....185

## **Storage**

Cup Holders .....187

Glove Compartment .....187

Center Console .....188

Under Seat Storage .....188

Glasses Holder .....190

## **Starting and Stopping the Engine**

Starting and Stopping the Engine –  
Precautions .....191

Ignition Switch .....191

Push Button Ignition Switch .....192

Starting the Engine .....192

Engine Block Heater .....194

Stopping the Engine .....195

Automatic Engine Stop .....196

Accessing the Passive Key Backup  
Position .....197

Starting and Stopping the Engine –  
Troubleshooting .....198

## **Fuel and Refueling**

Fuel and Refueling Precautions .....203

Fuel Quality .....204

Running Out of Fuel .....208

Refueling .....209

Fuel Tank Capacity .....211

Fuel and Refueling – Troubleshooting  
.....211

# Table of Contents

---

## **Diesel Particulate Filter**

What Is the Diesel Particulate Filter .....	212
How Does the Diesel Particulate Filter Work .....	212
Diesel Particulate Filter Precautions .....	212
Diesel Particulate Filter Requirements .....	213
Diesel Particulate Filter Manual Regeneration .....	213
Diesel Particulate Filter – Troubleshooting .....	215

## **Selective Catalytic Reduction System**

What Is the Selective Catalytic Reduction System .....	217
How Does the Selective Catalytic Reduction System Work .....	217
Selective Catalytic Reduction System Precautions .....	217
Selective Catalytic Reduction System Requirements .....	218
Selective Catalytic Reduction System Guidelines .....	218
Filling the Selective Catalytic Reduction System Tank .....	219
Checking the Selective Catalytic Reduction System Status .....	221
Diesel Exhaust Fluid Capacity and Specification .....	221
Selective Catalytic Reduction System – Troubleshooting .....	221

## **Catalytic Converter**

What Is the Catalytic Converter .....	223
Catalytic Converter Precautions .....	223
Catalytic Converter – Troubleshooting .....	223

## **Automatic Transmission**

Automatic Transmission Precautions .....	224
--	-----

Automatic Transmission Positions .....	224
Shifting Your Vehicle Into Gear .....	224
Manually Shifting Gears .....	225
Brake Shift Interlock .....	225
Power Take-Off .....	227

## **Four-Wheel Drive**

How Does Four-Wheel Drive Work .....	228
Four-Wheel Drive Precautions .....	228
Four-Wheel Drive Limitations .....	230
Selecting a Four-Wheel Drive Mode .....	230
Four-Wheel Drive Modes .....	231
Four-Wheel Drive Indicators .....	232
Four-Wheel Drive Driving Hints .....	232
Four-Wheel Drive – Troubleshooting .....	234

## **Electronic Locking Differential**

What Is the Electronic Locking Differential .....	237
How Does the Electronic Locking Differential Work .....	237
Electronic Locking Differential Precautions .....	237
Switching the Electronic Locking Differential On and Off - 4x4 .....	237
Switching the Electronic Locking Differential On and Off - 4x2 .....	238
Electronic Locking Differential Indicators .....	239
Electronic Locking Differential – Troubleshooting .....	239

## **Brakes**

Brake Precautions .....	240
Anti-Lock Braking System .....	240
Brake Over Accelerator .....	240
Locating the Brake Fluid Reservoir .....	240
Checking the Brake Fluid .....	240
Brake Fluid Specification .....	241

# Table of Contents

---

Brakes – Troubleshooting .....241

## **Parking Brake**

Applying the Parking Brake .....243

Releasing the Parking Brake .....243

Parking Brake – Troubleshooting .....243

## **Diesel Engine Exhaust Brake**

Diesel Engine Exhaust Brake –  
Precautions .....244

Using the Diesel Engine Exhaust Brake  
.....244

Diesel Engine Exhaust Brake Indicators  
.....245

Diesel Engine Exhaust Brake –  
Troubleshooting .....245

## **Hill Start Assist**

What Is Hill Start Assist .....246

How Does Hill Start Assist Work .....246

Hill Start Assist Precautions .....246

Hill Start Assist – Troubleshooting .....246

## **Traction Control**

What Is Traction Control .....247

How Does Traction Control Work .....247

Switching Traction Control On and Off  
.....247

Traction Control Indicator .....247

Traction Control – Troubleshooting .....248

## **Stability Control**

How Does Stability Control Work .....249

Switching Stability Control On and Off  
.....250

Stability Control Indicator .....251

## **Trail Control**

What Is Trail Control .....252

Switching Trail Control On and Off .....252

Setting the Trail Control Speed .....252

Canceling the Set Speed .....252

Trail Control Indicators .....252

Trail Control – Troubleshooting .....253

## **Hill Descent Control**

What Is Hill Descent Control .....254

How Does Hill Descent Control Work  
.....254

Hill Descent Control Precautions .....254

Switching Hill Descent Control On and  
Off .....254

Setting the Hill Descent Speed .....254

Hill Descent Control Indicator .....254

Hill Descent Control – Troubleshooting  
.....255

## **Steering**

Hydraulic Power Steering .....256

Steering – Troubleshooting .....258

## **Parking Aids**

Parking Aid Precautions .....260

Rear Parking Aid .....260

Parking Aids – Troubleshooting .....261

## **Rear View Camera**

What Is the Rear View Camera .....263

Rear View Camera Precautions .....263

Locating the Rear View Camera .....263

Rear View Camera Guide Lines .....264

Rear View Camera Settings .....264

## **360 Degree Camera**

What Is the 360 Degree Camera .....266

How Does the 360 Degree Camera Work  
.....266

360 Degree Camera Precautions .....266

360 Degree Camera Limitations .....266

Locating the 360 Degree Cameras .....266

# Table of Contents

---

360 Degree Camera Guide Lines .....	267
360 Degree Camera Settings .....	268

## **Cruise Control**

What Is Cruise Control .....	270
Switching Cruise Control On and Off .....	270
Setting the Cruise Control Speed .....	270
Canceling the Set Speed .....	271
Resuming the Set Speed .....	271
Cruise Control Indicators .....	271

## **Adaptive Cruise Control**

How Does Adaptive Cruise Control Work .....	272
Adaptive Cruise Control Precautions .....	272
Adaptive Cruise Control Limitations .....	273
Switching Adaptive Cruise Control On and Off .....	275
Adaptive Cruise Control Automatic Cancellation .....	275
Setting the Adaptive Cruise Control Speed .....	275
Setting the Adaptive Cruise Control Gap .....	276
Canceling the Set Speed .....	277
Resuming the Set Speed .....	277
Overriding the Set Speed .....	277
Adaptive Cruise Control Indicators .....	277
Switching From Adaptive Cruise Control to Cruise Control - Vehicles With: 2.3 Inch Screen .....	278
Switching From Adaptive Cruise Control to Cruise Control - Vehicles With: 4.2 Inch Screen .....	278
Switching From Adaptive Cruise Control to Cruise Control - Vehicles With: 8 Inch Screen .....	278
Adaptive Cruise Control – Troubleshooting .....	279

## **Drive Mode Control**

What Is Drive Mode Control .....	281
How Does Drive Mode Control Work .....	281
Selecting a Drive Mode .....	281
Drive Modes .....	282
Drive Mode Control – Troubleshooting .....	283

## **Lane Keeping System**

What Is the Lane Keeping System .....	286
How Does the Lane Keeping System Work .....	286
Lane Keeping System Precautions .....	286
Lane Keeping System Limitations .....	286
Switching the Lane Keeping System On and Off - Vehicles With: 4.2 Inch Screen .....	287
Switching the Lane Keeping System On and Off - Vehicles With: 8 Inch Screen .....	288
Alert Mode .....	288
Lane Keeping System Indicators .....	289
Lane Keeping System – Troubleshooting .....	290

## **Blind Spot Information System**

What Is Blind Spot Information System .....	293
How Does Blind Spot Information System Work .....	293
Blind Spot Information System Precautions .....	293
Blind Spot Information System Limitations .....	293
Blind Spot Information System Requirements .....	293
Switching Blind Spot Information System On and Off - Vehicles With: 4.2 Inch Screen .....	293

# Table of Contents

---

Switching Blind Spot Information System On and Off - Vehicles With: 8 Inch Screen .....	294
Locating the Blind Spot Information System Sensors .....	294
Blind Spot Information System With Trailer Coverage .....	295
Blind Spot Information System Indicators .....	296
Blind Spot Information System – Troubleshooting .....	297

## Cross Traffic Alert

What Is Cross Traffic Alert .....	298
How Does Cross Traffic Alert Work .....	298
Cross Traffic Alert Precautions .....	298
Cross Traffic Alert Limitations .....	298
Switching Cross Traffic Alert On and Off - Vehicles With: 4.2 Inch Screen .....	299
Switching Cross Traffic Alert On and Off - Vehicles With: 8 Inch Screen .....	299
Locating the Cross Traffic Alert Sensors .....	299
Cross Traffic Alert Indicators .....	300
Cross Traffic Alert – Troubleshooting .....	300

## Pre-Collision Assist

What Is Pre-Collision Assist .....	301
How Does Pre-Collision Assist Work .....	301
Pre-Collision Assist Precautions .....	301
Pre-Collision Assist Limitations .....	302
Switching Pre-Collision Assist On and Off - Vehicles With: 2.3 Inch Screen .....	302
Switching Pre-Collision Assist On and Off - Vehicles With: 4.2 Inch Screen .....	303
Switching Pre-Collision Assist On and Off - Vehicles With: 8 Inch Screen .....	303
Locating the Pre-Collision Assist Sensors .....	303

Distance Indication .....	304
Distance Alert .....	305
Automatic Emergency Braking .....	306
Pre-Collision Assist – Troubleshooting .....	307

## Driver Alert

What Is Driver Alert .....	309
How Does Driver Alert Work .....	309
Driver Alert Precautions .....	309
Driver Alert Limitations .....	309
Switching Driver Alert On and Off - Vehicles With: 4.2 Inch Screen .....	310
Switching Driver Alert On and Off - Vehicles With: 8 Inch Screen .....	310
Driver Alert – Troubleshooting .....	310

## Load Carrying

Load Carrying Precautions .....	311
Using a Slide-In Camper .....	312
Locating the Safety Compliance Certification Labels .....	312
What Is the Gross Axle Weight Rating .....	312
What Is the Gross Vehicle Weight Rating .....	312
What Is the Gross Combined Weight Rating .....	313
Calculating Payload .....	314
Calculating the Load Limit .....	314

## Pickup Bed

Pickup Bed Precautions .....	317
Pickup Bed Anchor Points .....	317
Tailgate Anchor Points .....	319
Pickup Bed Ramps .....	319

## Connecting a Trailer

Connecting a Trailer Precautions .....	323
Hitches .....	323
Connecting a Trailer .....	325

# Table of Contents

Connecting a Trailer – Troubleshooting .....	327	Setting Up the Trailer Backup Assistance for a Fifth-Wheel or Gooseneck Trailer .....	343
<b>Towing a Trailer</b>		Switching Trailer Backup Assistance On and Off .....	346
Towing a Trailer Precautions .....	328	Using the Trailer Backup Assistance Controller .....	346
Trailer Brake Precautions .....	328	Using the Trailer Backup Assistance Views .....	347
Towing a Trailer Limitations .....	329	Trailer Backup Assistance – Troubleshooting .....	349
Loading Your Trailer .....	329	<b>Trailer Reverse Guidance</b>	
Trailer Towing Hints .....	329	What Is Trailer Reverse Guidance .....	357
Launching or Retrieving a Boat or Personal Watercraft .....	330	How Does Trailer Reverse Guidance Work .....	357
Towing Weights and Dimensions .....	331	Trailer Reverse Guidance Precautions .....	357
Towing a Trailer – Troubleshooting .....	333	Setting Up Trailer Reverse Guidance for a Conventional Trailer .....	357
<b>Integrated Trailer Brake Controller</b>		Setting Up Trailer Reverse Guidance for a Fifth-Wheel or Gooseneck Trailer .....	360
What Is the Integrated Trailer Brake Controller .....	334	Switching Trailer Reverse Guidance On and Off .....	362
Integrated Trailer Brake Controller Precautions .....	334	Using Trailer Reverse Guidance Views .....	363
Using the Integrated Trailer Brake Controller .....	334	Trailer Reverse Guidance – Troubleshooting .....	364
Adjusting the Integrated Trailer Brake Controller Mode .....	335	<b>Driving Hints</b>	
Integrated Trailer Brake Controller – Troubleshooting .....	336	Off-Road Driving .....	371
<b>Trailer Sway Control</b>		Cold Weather Precautions .....	373
How Does Trailer Sway Control Work .....	338	Breaking-In .....	373
Trailer Sway Control Precautions .....	338	Driving Economically .....	373
Switching Trailer Sway Control On and Off .....	338	Driving Through Shallow Water .....	373
<b>Trailer Backup Assistance</b>		Floor Mats .....	374
What is Trailer Backup Assistance .....	339	<b>Snow Plowing</b>	
How Does Trailer Backup Assistance Work .....	339	Snow Plowing Precautions .....	376
Trailer Backup Assistance Precautions .....	339	Operating Your Vehicle With a Snowplow .....	376
Setting Up the Trailer Backup Assistance for a Conventional Trailer .....	339		

# Table of Contents

## Crash and Breakdown Information

Roadside Assistance .....	378
Switching the Hazard Flashers On and Off .....	379
Jump Starting the Vehicle .....	379
Post-Crash Alert System .....	381
Automatic Crash Shutoff .....	381
Recovery Towing .....	382
Transporting the Vehicle .....	383

## Towing Your Vehicle

Towing Your Vehicle Precautions .....	384
Recreationally Towing Your Vehicle - 4x4 .....	384
Recreationally Towing Your Vehicle - 4x2 .....	386
Emergency Towing .....	386
Towing Your Vehicle – Troubleshooting .....	386

## Fuses

Fuse Precautions .....	387
Under Hood Fuse Box .....	387
Body Control Module Fuse Box .....	392
Identifying Fuse Types .....	395
Fuses – Troubleshooting .....	395

## Maintenance

Maintenance Precautions .....	396
Opening and Closing the Hood .....	396
Under Hood Overview - 6.2L .....	397
Under Hood Overview - 6.7L Diesel .....	398
Under Hood Overview - 7.3L .....	399
Engine Oil .....	400
Checking the Coolant .....	402
Engine Air Filter .....	405
Draining the Fuel Filter Water Trap - Diesel .....	407
Changing the Fuel Filter - Diesel .....	408

Changing the Fuel Filter - Gasoline .....	409
Changing the 12V Battery .....	409
Adjusting the Headlamps .....	411
Exterior Bulbs .....	412
Interior Bulbs .....	419
Drive Belt Routing - 6.2L .....	419
Drive Belt Routing - 6.7L Diesel, Vehicles With: Dual Generators .....	419
Drive Belt Routing - 6.7L Diesel, Vehicles With: Single Generator .....	419
Drive Belt Routing - 7.3L, Vehicles With: Dual Generators .....	420
Drive Belt Routing - 7.3L, Vehicles With: Single Generator .....	420

## Vehicle Care

Cleaning Products .....	421
Cleaning the Exterior .....	421
Cleaning the Interior .....	424
Repairing Minor Paint Damage .....	426
Waxing Your Vehicle .....	426

## Storing Your Vehicle

Preparing Your Vehicle for Storage .....	427
Removing Your Vehicle From Storage .....	428

## Wheel and Tire Information

Locating the Tire label .....	429
Department of Transportation Uniform Tire Quality Grades .....	429
Information on the Tire Sidewall .....	430
Glossary of Tire Terminology .....	435
Tire Replacement Requirements .....	436
Using Snow Chains .....	438

## Tire Care

Checking the Tire Pressures .....	441
Inflating the Tires .....	441
Inspecting the Tire for Wear .....	444
Inspecting the Tire for Damage .....	445

# Table of Contents

Inspecting the Wheel Valve Stems .....	446	Cooling System Capacity and Specification - 7.3L .....	480
Tire Rotation .....	446	Fuel Tank Capacity - Diesel .....	481
<b>Tire Pressure Monitoring System</b>		Fuel Tank Capacity - Gasoline .....	482
What Is the Tire Pressure Monitoring System .....	448	Air Conditioning System Capacity and Specification - 6.2L .....	483
Tire Pressure Monitoring System Overview .....	448	Air Conditioning System Capacity and Specification - 6.7L Diesel .....	484
Tire Pressure Monitoring System Precautions .....	449	Air Conditioning System Capacity and Specification - 7.3L .....	485
Tire Pressure Monitoring System Limitations .....	449	Washer Fluid Specification .....	485
Viewing the Tire Pressures .....	450	Diesel Exhaust Fluid Capacity and Specification .....	486
Resetting Tire Pressure Monitoring System .....	450	Automatic Transmission Fluid Capacity and Specification - Diesel .....	487
Tire Pressure Monitoring System – Troubleshooting .....	453	Automatic Transmission Fluid Capacity and Specification - Gasoline .....	487
<b>Changing a Road Wheel</b>		Brake Fluid Specification .....	489
Changing a Flat Tire .....	455	Transfer Case Fluid Capacity and Specification .....	490
Wheel Nuts .....	465	Front Axle Fluid Capacity and Specification .....	490
<b>Capacities and Specifications</b>		Rear Axle Fluid Capacity and Specification - Diesel .....	491
Engine Specifications - 6.2L .....	467	Rear Axle Fluid Capacity and Specification - Gasoline .....	493
Engine Specifications - 6.7L Diesel .....	467	Hydraulic Power Steering Fluid Capacity and Specification .....	496
Engine Specifications - 7.3L .....	468	<b>Vehicle Identification</b>	
Motorcraft Parts - 6.2L .....	469	Vehicle Identification Number .....	497
Motorcraft Parts - 6.7L Diesel .....	471	<b>Connected Vehicle - Vehicles With: SYNC 3</b>	
Motorcraft Parts - 7.3L .....	472	What Is a Connected Vehicle .....	498
Engine Oil Capacity and Specification - 6.2L .....	473	Connected Vehicle Requirements .....	498
Engine Oil Capacity and Specification - 6.7L Diesel .....	474	Connected Vehicle Limitations .....	498
Engine Oil Capacity and Specification - 7.3L .....	477	Connecting the Vehicle to a Mobile Network .....	498
Cooling System Capacity and Specification - 6.2L .....	479	Connecting the Vehicle to a Wi-Fi Network .....	498
Cooling System Capacity and Specification - 6.7L Diesel .....	480	Connected Vehicle – Troubleshooting - Vehicles With: Modern .....	499



# Table of Contents

Connected Vehicle – Troubleshooting - Vehicles With: SYNC 3 .....	500
---	-----

## **Connected Vehicle - Vehicles With: SYNC 4**

What Is a Connected Vehicle .....	502
Connected Vehicle Requirements .....	502
Connected Vehicle Limitations .....	502
Connecting the Vehicle to a Mobile Network .....	502
Connecting the Vehicle to a Wi-Fi Network .....	502
Connected Vehicle – Troubleshooting .....	503

## **Vehicle Wi-Fi Hotspot**

Creating a Vehicle Wi-Fi Hotspot .....	506
Changing the Vehicle Wi-Fi Hotspot Name or Password .....	506

## **Audio System - Vehicles With: SYNC**

General Information .....	508
Audio Unit .....	508
Digital Radio .....	510
Satellite Radio .....	513
USB Port .....	516

## **Audio System - Vehicles With: SYNC 3**

General Information .....	517
Audio Unit .....	517
Digital Radio .....	518
Satellite Radio .....	521
USB Port .....	524

## **Audio System - Vehicles With: SYNC 4**

Audio System Precautions .....	525
Switching the Audio Unit On and Off .....	525

Selecting the Audio Source .....	525
Playing or Pausing the Audio Source .....	525
Adjusting the Volume .....	525
Switching Shuffle Mode On and Off .....	526
Switching Repeat Mode On and Off .....	526
Setting a Memory Preset .....	526
Muting the Audio .....	526
Adjusting the Sound Settings .....	526
Setting the Clock and Date .....	526
AM/FM Radio .....	527
Switching the Display On and Off .....	528
Digital Radio .....	528
Satellite Radio .....	529
Audio System – Troubleshooting .....	532
Identifying the Audio Unit .....	535

## **SYNC™**

General Information .....	536
Using Voice Recognition .....	537
Using SYNC™ With Your Phone .....	539
SYNC™ Applications and Services .....	540
Using SYNC™ With Your Media Player .....	542
SYNC™ Troubleshooting .....	542

## **SYNC™ 3**

General Information .....	552
Using Voice Recognition .....	554
Entertainment .....	560
Climate .....	570
Phone .....	572
Navigation .....	574
Apps .....	580
Settings .....	582
SYNC™ 3 Troubleshooting .....	584

# Table of Contents

---

## **Center Display Overview - Vehicles With: SYNC 4**

Center Display Precautions .....	597
Center Display Limitations .....	597
Status Bar .....	597
Feature Bar .....	598
Information On Demand Screen .....	599

## **Voice Interaction - Vehicles With: SYNC 4**

What is Voice Interaction .....	600
Setting the Wake Word .....	600
Beginning a Voice Interaction .....	600
Voice Interaction Examples .....	600

## **Phone - Vehicles With: SYNC 4**

Phone Precautions .....	602
Connecting Your Phone .....	602
Phone Menu .....	602
Making and Receiving a Phone Call ....	604
Sending and Receiving a Text Message .....	605
Switching Text Message Notification On and Off .....	606

## **Bluetooth® - Vehicles With: SYNC 4**

Connecting a Bluetooth® Device .....	607
Playing Media Using Bluetooth® .....	607

## **Apps - Vehicles With: SYNC 4**

App Precautions .....	608
App Requirements .....	608
Accessing Apps .....	608
Enabling Apps on an iOS Device .....	608
Enabling Apps on an Android Device .....	608
Switching Apple CarPlay On and Off .....	609

Switching Android Auto On and Off ....	609
--	-----

## **Navigation - Vehicles With: SYNC 4**

Accessing Navigation .....	610
Navigation Map Updates .....	610
Adjusting the Map .....	610
Live Traffic .....	610
Setting a Destination .....	610
Waypoints .....	611
Route Guidance .....	611
Trailer Towing Navigation .....	612

## **Vehicle System Updates - Vehicles With: SYNC 4**

Updating the Vehicle Systems Wirelessly .....	613
Performing a Master Reset .....	614

## **Accessories**

Accessories .....	615
Auxiliary Switches .....	616

## **Auxiliary Switches**

What Are the Auxiliary Switches .....	618
Locating the Auxiliary Switches .....	618
Locating the Auxiliary Switch Wiring .....	618
Identifying the Auxiliary Switch Wiring .....	619

## **Ford Protect**

What Is Ford Protect .....	620
----------------------------	-----

## **Scheduled Maintenance**

General Maintenance Information .....	622
Normal Scheduled Maintenance - Diesel .....	625
Normal Scheduled Maintenance - Gasoline .....	628

# Table of Contents

---

Special Operating Conditions Scheduled Maintenance - Diesel .....	631
Special Operating Conditions Scheduled Maintenance - Gasoline .....	636

## Customer Information

Rollover Warning .....	640
Our Sustainability Report .....	640
The Better Business Bureau Auto Line Program - United States of America .....	640
The Mediation and Arbitration Program - Canada .....	641
Ordering a Canadian French Owner's Manual .....	641
Reporting Safety Defects in the United States .....	642
Reporting Safety Defects in Canada .....	642
Radio Frequency Certification Labels .....	643
Perchlorate .....	684
Replacement Parts Recommendation .....	684
Mobile Communications Equipment .....	685
End User License Agreement .....	685
Emission Law .....	710
Export Unique Options .....	711

## Appendices

Electromagnetic Compatibility .....	713
-------------------------------------	-----

# Contacting Us

---

If you require assistance or clarification on policies or procedures, please contact the customer relationship center.

## United States

Ford Motor Company  
Customer Relationship Center  
PO Box 6248  
Dearborn, MI 48126  
1-800-392-3673 (FORD)  
(TDD for the hearing impaired:  
1-888-658-6805  
[www.ford.com/help/contact/](http://www.ford.com/help/contact/)

## Canada

Customer Relationship Center  
Ford Motor Company of Canada Limited  
P.O. Box 2000  
Oakville, Ontario L6J 5E4  
1-800-565-3673 (FORD)  
[www.ford.ca](http://www.ford.ca)  
Facebook: FordServiceCA (English),  
FordServiceQC (Français)

## Europe

Telephone: 02035644444  
E-mail: [UKCRC1@ford.com](mailto:UKCRC1@ford.com)  
Twitter: @forduk

## Australia

Ford Motor Company  
Attention: Customer Relationship Centre  
Private Mail Bag 5  
Fairlane Business Park #3  
Campbellfield, Victoria, 3061  
Telephone: 13 3673 (FORD)  
E-mail: [foacust1@ford.com](mailto:foacust1@ford.com)

## New Zealand

Ford Motor Company  
Attention: Customer Relationship Centre  
Private Bag 76912  
Manukau City 2241  
Telephone: 0800 367 369 (FORDNZ)  
E-mail: [fnzcust@ford.com](mailto:fnzcust@ford.com)

## China - Imported Vehicle

Customer Relationship Center  
Telephone: 400-690-1886  
Website: <https://www.ford.com.cn/>

## China - Chang'An Ford

Customer Relationship Center  
Telephone: 800-810-8168  
Mobile: 400-887-7766  
Website: <https://www.ford.com.cn/>

## Asia Pacific

E-mail: [expcac@ford.com](mailto:expcac@ford.com)

## Caribbean, Central America and Israel

Ford Motor Company  
Ford Export Operations  
Attention: Owner Relations  
1555 Fairlane Drive  
Fairlane Business Park #3  
Allen Park, MI 48101  
Fax: (313) 390-0804  
Telephone: (313) 594-4857  
E-mail: [expcac@ford.com](mailto:expcac@ford.com)

## U.S. Virgin Islands and Puerto Rico

Ford Motor Company  
Ford Export Operations  
Attention: Owner Relations  
1555 Fairlane Drive  
Fairlane Business Park #3  
Allen Park, MI 48101  
Telephone: (800) 841-3673  
E-mail: [prcac@ford.com](mailto:prcac@ford.com)

## Argentina

Telephone: 0800-888-3673

## Brazil

[www.ford.com.br](http://www.ford.com.br)

# Contacting Us

---

## North Africa

E-mail: [nafcrc@ford.com](mailto:nafcrc@ford.com)

## Sub-Saharan Africa

E-mail: [ssacrc@ford.com](mailto:ssacrc@ford.com)

## Puerto Rico

Ford International Business Development,  
Inc.  
P.O. Box 11957  
Caparra Heights Station  
San Juan, PR 00922-1957  
1-800-392-3673 (FORD)  
Fax: (313) 390-0804  
E-mail: [prcac@ford.com](mailto:prcac@ford.com)  
[www.ford.com.pr](http://www.ford.com.pr)

## Middle East

Ford Middle East Customer Relationship  
Center  
P.O. Box 21740  
Dubai, United Arab Emirates  
Telephone: 80004441066  
Toll-free number for the Kingdom of Saudi  
Arabia: 8008443673  
Mobily and Zain cell phone users in Saudi  
Arabia: 800850078  
Kuwait: 22280384  
Local telephone number for Kuwait: +965  
1 898900  
Fax: +971 4 3327266  
E-mail: [menacac@ford.com](mailto:menacac@ford.com)  
[www.me.ford.com](http://www.me.ford.com)

## South Korea

Telephone: +82-02-1600-6003  
E-mail: [infokr1@ford.com](mailto:infokr1@ford.com)

## Ford Credit - US Only

Ford Credit offers a full range of financing and lease plans to help you acquire your vehicle. If you have financed or leased your vehicle through Ford Credit, thank you for your business.

For assistance call 1-800-727-7000, or for more information about Ford Credit and access to an account manager, visit [www.ford.com/finance](http://www.ford.com/finance).

# Introduction

## ABOUT THIS PUBLICATION



**WARNING:** Driving while distracted can result in loss of vehicle control, crash and injury. We strongly recommend that you use extreme caution when using any device that may take your focus off the road. Your primary responsibility is the safe operation of your vehicle. We recommend against the use of any hand-held device while driving and encourage the use of voice-operated systems when possible. Make sure you are aware of all applicable local laws that may affect the use of electronic devices while driving.



**WARNING:** You risk death, fire, or serious injury to yourself and others if you do not follow the instruction highlighted by the warning symbol.

Thank you for choosing Ford. We recommend that you take some time to get to know your vehicle in order to benefit from greater safety and pleasure from driving it. Use this publication to familiarize yourself with the basics and then read the digital version, that is available in your vehicle. You can also view the comprehensive manual through the FordPass app and through the local Ford website.

**Note:** To download the FordPass app, visit your device's app store.

**Note:** To find the local Ford website, visit <https://corporate.ford.com/operations/locations/global-links.html>.

**Note:** Use and operate your vehicle in line with all applicable laws and regulations.

**Note:** Pass on all printed owner's information when selling this vehicle.

Our digital resources include a comprehensive digital Owner's Manual dynamically created according to the features on your vehicle by using the vehicle identification number. See **Locating the Vehicle Identification Number** (page 497). The digital Owner's Manual includes visual and full text search functions so that you can quickly locate the information you are looking for. It also includes links to a number of how-to videos created to help you understand some of the advanced technologies on your vehicle.

## Features and Options

This publication describes product features and options available throughout the range of available models, sometimes even before they are generally available. It could describe options that are not available on the vehicle you have purchased.

## Illustrations

Some of the illustrations in this publication could show features as used in different models, so they could appear different to you on your vehicle.

## Location of Components

This manual may qualify the location of a component as left-hand side or right-hand side. The side is determined when facing forward in the seat.

# Introduction

---



- A Right-hand side.
- B Left-hand side.













## USING THIS PUBLICATION















To quickly locate information about your vehicle, use the word search within the Owner's Manual application.

# Symbols Glossary

## SYMBOLS USED ON YOUR VEHICLE

These are some of the symbols you may see on your vehicle.

	Air conditioning system
	Air conditioning system lubricant type
	Anti-lock braking system
	Avoid smoking, flames or sparks
	Battery
	Battery acid
	Brake fluid - non petroleum based
	Brake system
	Brake system
	Cabin air filter
	Check fuel cap
	Child safety door lock or unlock
	Child seat lower anchor

	Child seat tether anchor
	Cruise control
	Do not open when hot
	Electric Parking brake
	Engine air filter
	Engine coolant
	Engine coolant temperature
	Engine oil
	Explosive gas
	Fan warning
	Fasten seatbelt
	Flammable
	Airbag
	Front fog lamps
	Fuel pump reset



# Symbols Glossary



Fuse compartment



Hazard flashers



Heated rear window



Windshield defrosting system



Interior luggage compartment release



Jack



Keep out of reach of children



Lighting control



Low tire pressure warning



Maintain correct fluid level



Note operating instructions



Horn control



Panic alarm



Parking aid



Passenger airbag activated



Passenger airbag deactivated



Power steering fluid



Power windows front/rear



Power window lockout



Requires registered technician



Safety alert



See Owner's Manual



See Service Manual



Malfunction Indicator Lamp (MIL)



Side airbag



Shield the eyes



Stability control



Hill descent control



Trail control



Windshield wiping system

# Symbols Glossary

---



Windshield wash and wipe

# Data Privacy



**WARNING:** Do not connect wireless plug-in devices to the data link connector. Unauthorized third parties could gain access to vehicle data and impair the performance of safety related systems. Only allow repair facilities that follow our service and repair instructions to connect their equipment to the data link connector.

We respect your privacy and are committed to protecting it. The information contained in this manual was correct at the time of publication but as technology rapidly changes, we recommend that you visit the local Ford website for the latest information.

Your vehicle has electronic control units that have data recording functionality and the ability to permanently or temporarily store data. This data could include information on the condition and status of your vehicle, vehicle maintenance requirements, events and malfunctions. The types of data that can be recorded are described in this section. Some of the data recorded is stored in event logs or error logs.

**Note:** *Error logs are reset following a service or repair.*

**Note:** *We may provide information in response to requests from law enforcement, other government authorities and third parties acting with lawful authority or through a legal process. Such information could be used by them in legal proceedings.*

Data recorded includes, for example:

- Operating states of system components, for example fuel level, tire pressure and battery charge level.
- Vehicle and component status, for example wheel speed, deceleration, lateral acceleration and seatbelt status.

- Events or errors in essential systems, for example headlamps and brakes.
- System responses to driving situations, for example airbag deployment and stability control.
- Environmental conditions, for example temperature.

Some of this data, when used in combination with other information, for example an accident report, damage to a vehicle or eyewitness statements, could be associated with a specific person.

## Services That We Provide

If you use our services, we collect and use data, for example account information, vehicle location and driving characteristics, that could identify you. We transmit this data through a dedicated, protected connection. We only collect and use data to enable your use of our services to which you have subscribed, with your consent or where permitted by law. For additional information, see the terms and conditions of the services to which you have subscribed.

For additional information about our privacy policy, refer to the local Ford website.

## Services That Third Parties Provide

We recommend that you review the terms and conditions and data privacy information for any services equipped with your vehicle or to which you subscribe. We take no responsibility for services that third parties provide.

Where equipped, SiriusXM with 360L may use the modem. To disable, turn off the SiriusXM 360L or Vehicle Connectivity setting. See **Enabling and Disabling the Modem** (page 498).

# Data Privacy

---

## SERVICE DATA

Service data recorders in your vehicle are capable of collecting and storing diagnostic information about your vehicle. This potentially includes information about the performance or status of various systems and modules in the vehicle, such as engine, throttle, steering or brake systems. In order to properly diagnose and service your vehicle, Ford Motor Company (Ford of Canada in Canada), and service and repair facilities may access or share among them vehicle diagnostic information received through a direct connection to your vehicle when diagnosing or servicing your vehicle. Additionally, Ford Motor Company (Ford of Canada, in Canada) may, where permitted by law, use vehicle diagnostic information for vehicle improvement or with other information we may have about you, for example, your contact information, to offer you products or services that may interest you. Data may be provided to our service providers such as part suppliers that may help diagnose malfunctions, and who are similarly obligated to protect data. We retain this data only as long as necessary to perform these functions or to comply with law. We may provide information where required in response to official requests to law enforcement or other government authorities or third parties acting with lawful authority or court order, and such information may be used in legal proceedings. For U.S. only (if equipped), if you choose to use connected apps and services, you consent that certain diagnostic information may also be accessed electronically by Ford Motor Company and Ford authorized service facilities, and that the diagnostic information may be used to provide services to you, personalizing your experience, troubleshoot, and to improve products and services and offer you products and services that may interest

you, where permitted by law. For Canada only, for more information, please review the Ford of Canada privacy policy at [www.ford.ca](http://www.ford.ca), including our U.S. data storage and use of service providers in other jurisdictions who may be subject to legal requirements in Canada, the United States and other countries applicable to them, for example, lawful requirements to disclose personal information to governmental authorities in those countries.

## EVENT DATA

This vehicle is equipped with an event data recorder. The main purpose of an event data recorder is to record, in certain crash or near crash-like situations, such as an airbag deployment or hitting a road obstacle; this data will assist in understanding how a vehicle's systems performed. The event data recorder is designed to record data related to vehicle dynamics and safety systems for a short period of time, typically 30 seconds or less.

The event data recorder in this vehicle is designed to record such data as:

- How various systems in your vehicle were operating.
- Whether or not the driver and passenger seatbelts were buckled/fastened.
- How far (if at all) the driver was depressing the accelerator and/or the brake pedal.
- How fast the vehicle was traveling.
- Where the driver was positioning the steering wheel.

This data can help provide a better understanding of the circumstances in which crashes and injuries occur.

# Data Privacy

---

**Note:** *Event data recorder data is recorded by your vehicle only if a non-trivial crash situation occurs; no data is recorded by the event data recorder under normal driving conditions and no personal data or information (for example name, gender, age, and crash location) is recorded. However, parties, such as law enforcement, could combine the event data recorder data with the type of personally identifying data routinely acquired during a crash investigation.*

To read data recorded by an event data recorder, special equipment is required, and access to the vehicle or the event data recorder is needed. In addition to the vehicle manufacturer, other parties, such as law enforcement, that have such special equipment, can read the information if they have access to the vehicle or the event data recorder.

## SETTINGS DATA

Your vehicle has electronic control units that have the ability to store data based on your personalized settings. The data is stored locally in the vehicle or on devices that you connect to it, for example, a USB drive or digital music player. You can delete some of this data and also choose whether to share it through the services to which you subscribe. See **Settings** (page 582).

## Comfort and Convenience Data

Data recorded includes, for example:

- Seat and steering wheel position.
- Climate control settings.
- Radio presets.

## Entertainment Data

Data recorded includes, for example:

- Music, videos or album art.
- Contacts and corresponding address book entries.
- Navigation destinations.

## CONNECTED VEHICLE DATA



The modem has a SIM. The modem was enabled when your vehicle was built and periodically sends messages to stay connected to the cell phone network, receive automatic software updates and send vehicle-related information to us, for example diagnostic information. These messages could include information that identifies your vehicle, the SIM and the electronic serial number of the modem. Cell phone network service providers could have access to additional information, for example cell phone network tower identification. For additional information about our privacy policy, visit [www.FordConnected.com](http://www.FordConnected.com) or refer to your local Ford website.

**Note:** *The modem continues to send this information unless you disable the modem or stop the modem from sharing vehicle data by changing the modem settings. See **Connected Vehicle** (page 502).*

**Note:** *The service can be unavailable or interrupted for a number of reasons, for example environmental or topographical conditions and data plan coverage.*

**Note:** *To find out if your vehicle has a modem, visit [www.FordConnected.com](http://www.FordConnected.com).*

# Data Privacy

---

## MOBILE DEVICE DATA - VEHICLES WITH: SYNC 3

If you connect a mobile device to your vehicle, you can display data from your device on the touchscreen for example, music and album art. You can share your vehicle data with mobile apps on your device through the system. See **App Precautions** (page 608).

The mobile apps function operates by your connected device sending data to us in the United States. The data is encrypted and includes, for example, the vehicle identification number of your vehicle, the SYNC module serial number, odometer, enabled apps, usage statistics and debugging information. We retain it only as long as necessary to provide the service, to troubleshoot, for continuous improvement and to offer you products and services that may be of interest to you according to your preferences and where allowed by law.

If you connect a cell phone to the system, the system creates a profile that links to that cell phone. The cell phone profile enables more mobile features and efficient operation. The profile contains, for example data from your phonebook, read and unread text messages and call history, including history of calls when your cell phone was not connected to the system.

If you connect a media device, the system creates and retains a media device index of supported media content. The system also records a short diagnostic log of approximately 10 minutes of all recent system activity.

The cell phone profile, media device index and diagnostic log remain in your vehicle unless you delete them and are generally accessible only in your vehicle when you connect your cell phone or media device. If you no longer plan to use the system or your vehicle, we recommend you use the master reset function to erase the stored information. See **Settings** (page 582).

System data cannot be accessed without special equipment and access to your vehicle's module.

For additional information about our privacy policy, refer to the local Ford website.

**Note:** *To find out if your vehicle has connectivity technology, visit [www.FordConnected.com](http://www.FordConnected.com).*

## MOBILE DEVICE DATA - VEHICLES WITH: SYNC 4

If you connect a mobile device to your vehicle, you can display data from your device on the touchscreen for example, music and album art. You can share your vehicle data with mobile apps on your device through the system. See **App Requirements** (page 608).

The mobile apps function operates by your connected device sending data to us in the United States. The data is encrypted and includes, for example, the vehicle identification number of your vehicle, the SYNC module serial number, odometer, enabled apps, usage statistics and debugging information. We retain it only as long as necessary to provide the service, to troubleshoot, for continuous improvement and to offer you products and services that may be of interest to you according to your preferences and where allowed by law.

# Data Privacy

---

If you connect a cell phone to the system, the system creates a profile that links to that cell phone. The cell phone profile enables more mobile features and efficient operation. The profile contains, for example data from your phonebook, read and unread text messages and call history, including history of calls when your cell phone was not connected to the system.

If you connect a media device, the system creates and retains a media device index of supported media content. The system also records a short diagnostic log of approximately 10 minutes of all recent system activity.

The cell phone profile, media device index and diagnostic log remain in your vehicle unless you delete them and are generally accessible only in your vehicle when you connect your cell phone or media device. If you no longer plan to use the system or your vehicle, we recommend you use the master reset function to erase the stored information. See **Performing a Master Reset** (page 614).

System data cannot be accessed without special equipment and access to your vehicle's module.

For additional information about our privacy policy, refer to the local Ford website.

**Note:** *To find out if your vehicle has connectivity technology, visit [www.FordConnected.com](http://www.FordConnected.com).*

## EMERGENCY CALL SYSTEM DATA

When the emergency call system is active, it may disclose to emergency services that your vehicle has been in a crash involving the deployment of an airbag or activation of the fuel pump shut-off. Certain versions or updates to the emergency call system may also be capable of electronically or

verbally disclosing to emergency services operators your vehicle location or other details about your vehicle or crash to assist emergency services operators to provide the most appropriate emergency services. If you do not want to disclose this information, do not activate the emergency call system.

**Note:** *You cannot deactivate emergency call systems that are required by law.*

# Visual Search

## STEERING WHEEL - VEHICLES WITH: SYNC 4



- A See **Using the Instrument Cluster Display Controls** (page 141).
- B See **Adjusting the Volume** (page 525).
- C See **Making and Receiving a Phone Call** (page 604).
- D See **Setting the Cruise Control Speed** (page 270). See **Setting the Adaptive Cruise Control Speed** (page 275).



# Visual Search

---

## STEERING WHEEL - VEHICLES WITH: SYNC 3



- A See **Using the Instrument Cluster Display Controls** (page 141).
- B See **Audio Unit** (page 517).
- C See **Phone** (page 572).
- D See **Setting the Cruise Control Speed** (page 270). See **Setting the Adaptive Cruise Control Speed** (page 275).

# Visual Search

## INSTRUMENT PANEL

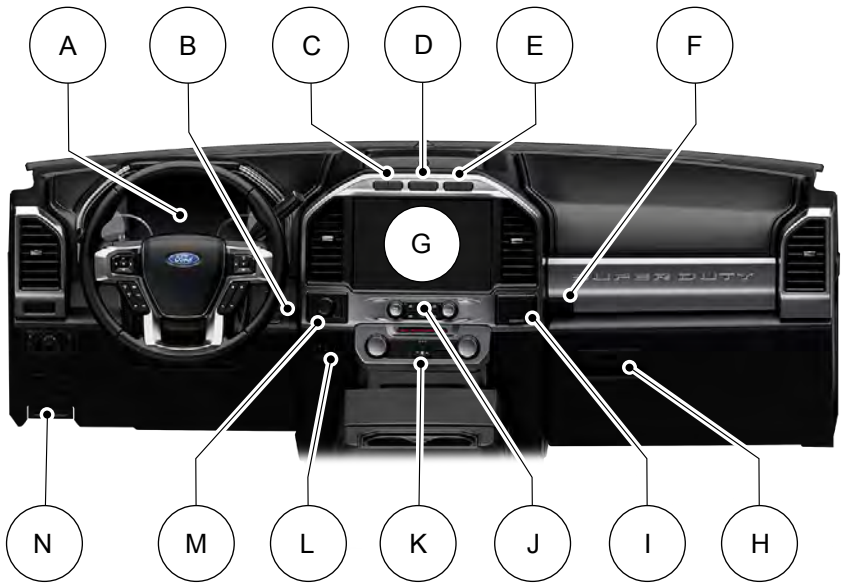

- A See **Instrument Cluster Overview** (page 133). See **Instrument Cluster Overview** (page 134). See **Instrument Cluster Overview** (page 135).
- B See **Push Button Ignition Switch** (page 192).
- C See **Switching Stability Control On and Off** (page 250).
- D See **Switching the Hazard Flashers On and Off** (page 379).
- E See **Switching the 360 Degree Camera On and Off** (page 268).
- F See **Opening the Glove Compartment** (page 187).
- G See **Status Bar** (page 597).
- H See **Opening the Glove Compartment** (page 187).
- I See **Locating the Power Outlet** (page 182).
- J See **Switching the Audio Unit On and Off** (page 525).
- K See **Identifying the Climate Control Unit** (page 149).
- L See **Using the Integrated Trailer Brake Controller** (page 334).

# Visual Search

---

- M See **Selecting a Four-Wheel Drive Mode** (page 230).
- N See **Releasing the Parking Brake** (page 243).

## VEHICLE INTERIOR

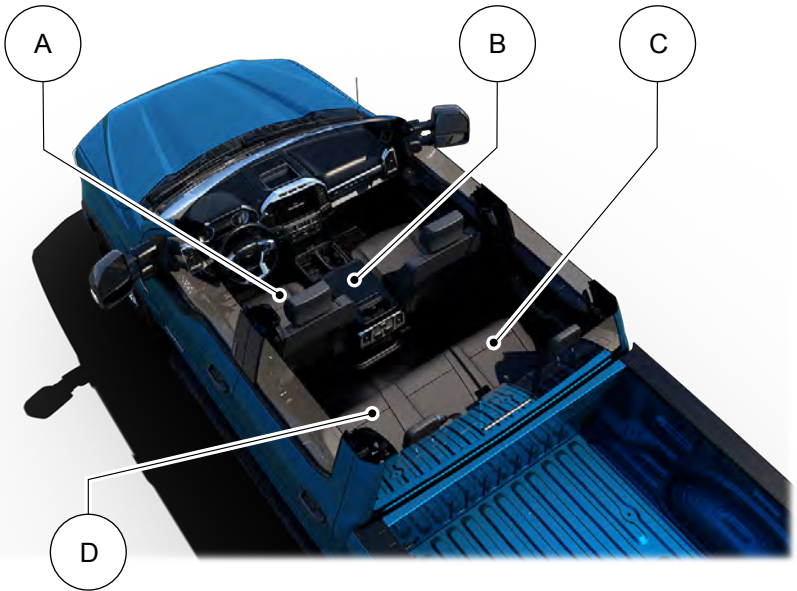

- A See **Sitting in the Correct Position** (page 158).
- B See **Opening the Center Console** (page 188).
- C See **Unfolding the Seats** (page 168).
- D See **Folding the Seats** (page 168).

# Visual Search

## FRONT EXTERIOR

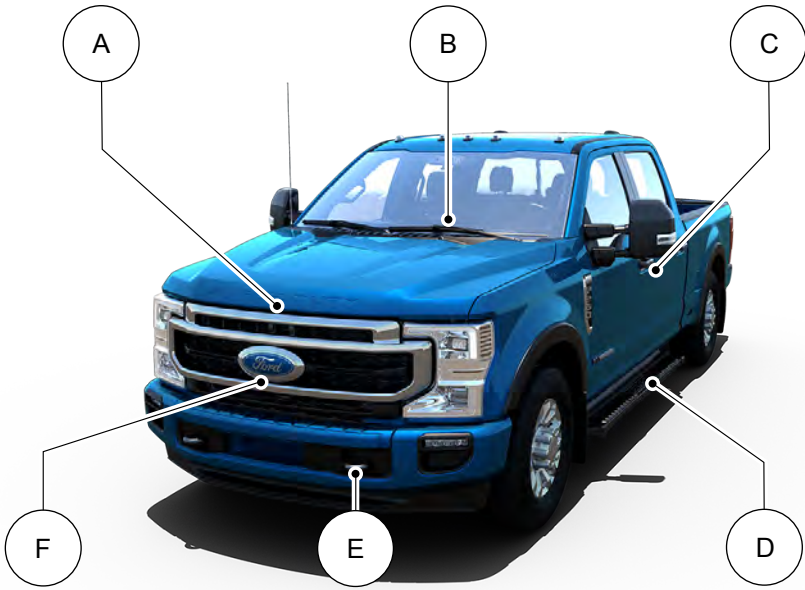

- A See **Opening and Closing the Hood** (page 396).
- B See **Replacing the Front Wiper Blades** (page 116).
- C See **Unlocking and Locking the Doors Using the Key Blade** (page 83).
- D See **Deploying and Stowing the Power Running Boards** (page 110).
- E See **Accessing the Front Towing Point** (page 382).
- F See **Locating the 360 Degree Cameras** (page 266).

# Visual Search

## REAR EXTERIOR

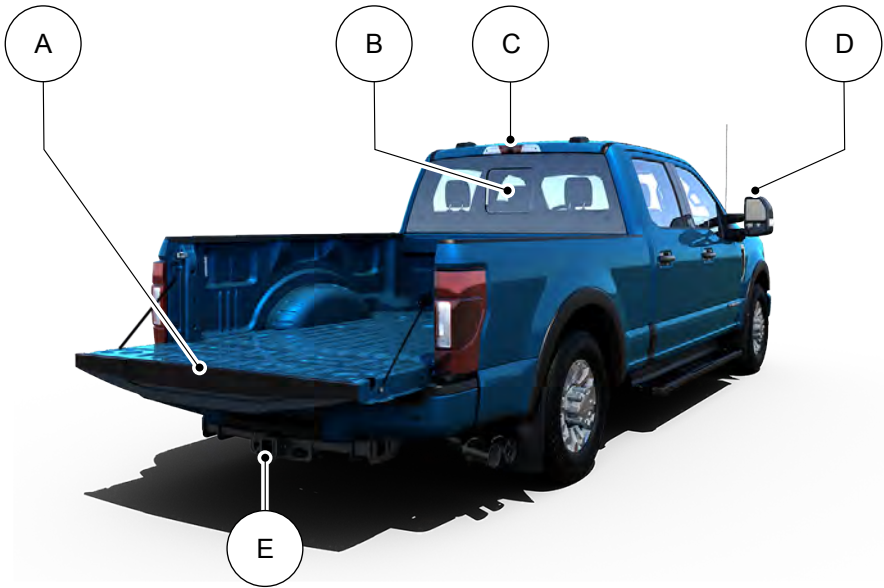

- A See **Opening the Tailgate From Outside Your Vehicle** (page 99).
- B See **Opening and Closing the Sliding Windows** (page 127).
- C See **Locating the 360 Degree Cameras** (page 266).
- D See **Folding the Exterior Mirrors** (page 129). See **Folding the Exterior Mirrors** (page 129).
- E See **Connecting a Trailer** (page 325).

# Child Safety

## CHILD SAFETY PRECAUTIONS



**WARNING:** Always make sure your child is secured properly in a device that is appropriate for their height, age and weight. Child safety restraints must be bought separately from your vehicle. Failure to follow these instructions and guidelines may result in an increased risk of serious injury or death to your child.



**WARNING:** All children are shaped differently. The National Highway Traffic Safety Administration and other safety organizations, base their recommendations for child restraints on probable child height, age and weight thresholds, or on the minimum requirements of the law. We recommend that you check with a NHTSA Certified Child Passenger Safety Technician (CPST) to make sure that you properly install the child restraint in your vehicle and that you consult your pediatrician to make sure you have a child restraint appropriate for your child. To locate a child restraint fitting station and CPST, contact NHTSA toll free at 1-888-327-4236 or go to [www.nhtsa.dot.gov](http://www.nhtsa.dot.gov). In Canada, contact Transport Canada toll free at 1-800-333-0371 or go to [www.tc.gc.ca](http://www.tc.gc.ca) to find a Child Car Seat Clinic in your area. Failure to properly restrain children in child restraints made especially for their height, age and weight, may result in an increased risk of serious injury or death to your child.



**WARNING:** On hot days, the temperature inside the vehicle can rise very quickly. Exposure of people or animals to these high temperatures for even a short time can cause death or serious heat related injuries, including brain damage. Small children are particularly at risk.



**WARNING:** Do not place a rearward facing child restraint in front of an active airbag. Failure to follow this instruction could result in personal injury or death.



**WARNING:** Properly secure children 12 years old and under in a rear seating position whenever possible. If you are unable to properly secure all children in a rear seating position, properly secure the largest child on the front seat. If you must use a forward facing child restraint on the front seat, move the seat as far back as possible. Failure to follow these instructions could result in personal injury or death.



**WARNING:** Always carefully follow the instructions and warnings provided by the manufacturer of any child restraint to determine if the restraint device is appropriate for your child's size, height, weight, or age. Follow the child restraint manufacturer's instructions and warnings provided for installation and use in conjunction with the instructions and warnings provided by your vehicle manufacturer. A safety seat that is improperly installed or utilized, is inappropriate for your child's height, age, or weight or does not properly fit the child may increase the risk of serious injury or death.

# Child Safety

**WARNING:** Do not allow a passenger to hold a child on their lap when your vehicle is moving. Failure to follow this instruction could result in personal injury or death in the event of a sudden stop or crash.

**WARNING:** Do not use pillows, books or towels to boost your child's height. Failure to follow this instruction could result in personal injury or death.

**WARNING:** Properly secure child restraints or booster seats when they are not in use. They could become projectiles in a sudden stop or crash. Failure to follow this instruction could result in personal injury or death.

**WARNING:** Do not put the shoulder section of the seatbelt or allow the child to put the shoulder section of the seatbelt under their arm or behind their back. Failure to follow this instruction could reduce the effectiveness of the seatbelt and increase the risk of injury or death in a crash.

**WARNING:** Do not leave children or pets unattended in your vehicle. Failure to follow this instruction could result in personal injury or death.

When installing a child restraint with seatbelts:

- Place the vehicle seat in the upright position before you install the child restraint.
- Use the correct seatbelt buckle for that seating position.
- Insert the belt tongue into the buckle. Make sure the tongue is securely fastened in the buckle.

- Keep the buckle release button pointing up and away from the child restraint, with the tongue between the child restraint and the release button, to prevent accidental unbuckling.
- Put the seatbelt in the automatic locking mode.

## CHILD RESTRAINT ANCHOR POINTS

### WHAT ARE THE CHILD RESTRAINT ANCHOR POINTS

Anchor points allow you to quickly and safely install a child restraint.

### LOCATING THE CHILD RESTRAINT LOWER ANCHOR POINTS

Crew Cab

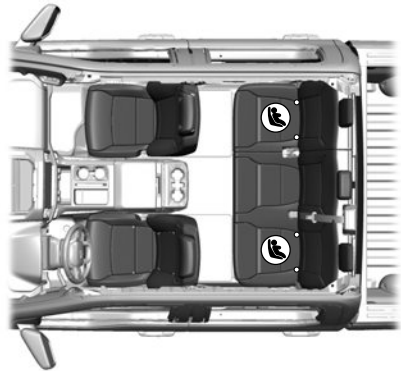

Super Cab

# Child Safety

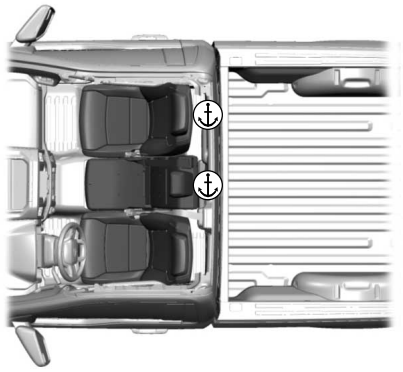
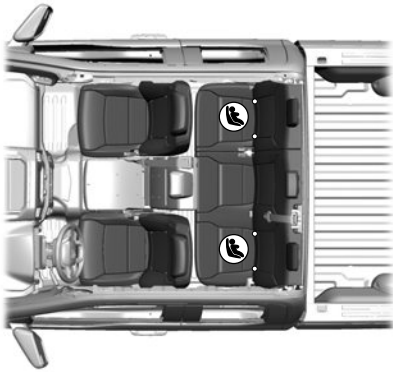

Crew Cab

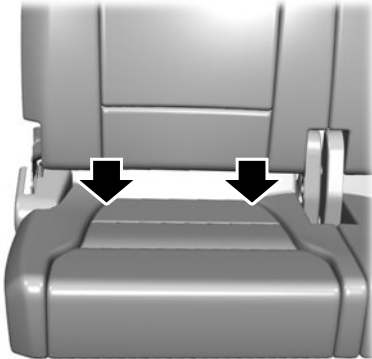

The lower child restraint anchors are at the rear section of the rear seat between the cushion and seat backrest.

**Note:** *Regular Cab vehicles do not have lower anchors.*

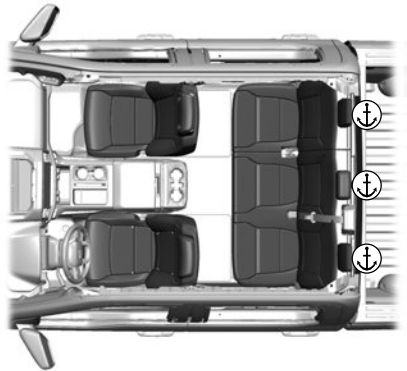

Super Cab

## LOCATING THE CHILD RESTRAINT TOP TETHER ANCHOR POINTS

Regular Cab



# Child Safety

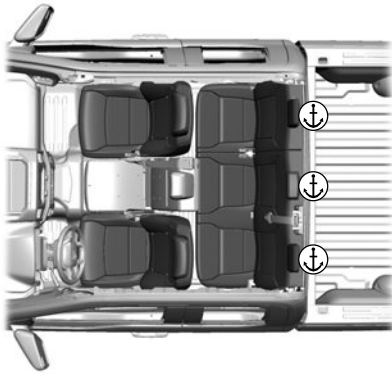

## CHILD RESTRAINTS

### CHILD RESTRAINT POSITION INFORMATION

Install the child restraint tightly against the vehicle seat. It may be necessary to lift or remove the head restraint.

### Rear Facing Child Restraints

Combined Weight of Child and Child Restraint	LATCH (Lower Anchors Only)	Seatbelt Only
Up to 65 lb (29 kg)	X	X
Over 65 lb (29 kg)		X

### Forward Facing Child Restraints

Combined Weight of Child and Child Restraint	LATCH (Lower Anchors and Top Tether Anchor)	Seatbelt and Top Tether Anchor	Seatbelt and LATCH (Lower Anchors and Top Tether Anchor)
Up to 65 lb (29 kg)	X	X	X
Over 65 lb (29 kg)		X	X

# Child Safety

## CHILD RESTRAINTS RECOMMENDATION

Child Size, Height, Weight, or Age	Recommended Restraint Type
Children weighing 40 lb (18 kg) or less (generally age four or younger).	Use a child restraint (sometimes called an infant carrier, convertible seat, or toddler seat).
Children who have outgrown or no longer properly fit in a child restraint (generally children who are less than 57 in (1.45 m) tall, are greater than age four and less than age 12, and between 40 lb (18 kg) and 80 lb (36 kg) and upward to 100 lb (45 kg) if recommended by your child restraint manufacturer).	Use a belt-positioning booster seat.
Children who have outgrown or no longer properly fit in a belt-positioning booster seat (generally children who are at least 57 in (1.45 m) tall or greater than 80 lb (36 kg) or 100 lb (45 kg) if recommended by child restraint manufacturer).	Use a vehicle seatbelt having the lap belt snug and low across the hips, shoulder belt centered across the shoulder and chest, and seat backrest upright.

You are required by law to properly use child restraints for infants and toddlers in the United States, Canada and Mexico.

Many states and provinces require that small children use approved booster seats until they reach age eight, a height of 57 in (1.45 m) tall, or 80 lb (36 kg). Check your local and state or provincial laws for specific requirements about the safety of children in your vehicle.

When possible, properly restrain children 12 years of age and under in a rear seating position of your vehicle. Accident statistics suggest that children are safer when properly restrained in the rear seating positions than in a front seating position.

When installing a rear facing child restraint, adjust the vehicle seats to avoid interference between the child restraint and the vehicle seat in front of the child restraint.

## INSTALLING CHILD RESTRAINTS

### USING SEATBELTS



**WARNING:** Depending on where you secure a child restraint, and depending on the child restraint design, you may block access to certain seatbelt buckle assemblies and LATCH lower anchors, rendering those features potentially unusable. To avoid risk of injury, make sure occupants only use seating positions where they are able to be properly restrained.

**Note:** *The following does not apply to the front center position of Super Cab and Crew Cab vehicles.*

**Note:** *Although the child restraint illustrated is a forward facing child restraint, the steps are the same for installing a rear facing child restraint.*

# Child Safety

Perform the following steps when installing a child restraint with seatbelts.

1. Position the child restraint in a seat with a seatbelt.



2. Pull down on the shoulder belt and then grasp the shoulder belt and lap belt together.



3. While holding the shoulder and lap belt portions together, route the tongue through the child restraint according to the child restraint manufacturer's instructions. Make sure you did not twist the belt webbing.

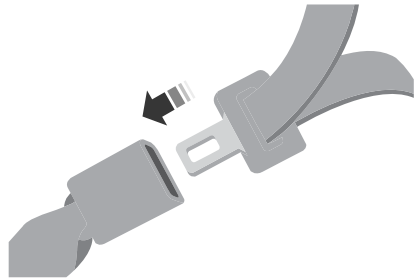

4. Insert the belt tongue into the proper buckle for that seating position until the latch engages. Make sure the tongue is latched securely by pulling on it.



5. To put the retractor in the automatic locking mode, grasp the shoulder portion of the belt and pull downward until you pull all of the seatbelt out.

**Note:** *The automatic locking mode is available on the front passenger and rear seats. This mode is also available on the center seat of a Regular Cab. This vehicle does not require the use of a locking clip.*

6. Allow the belt to retract to remove slack. The seatbelt clicks as it retracts to indicate it is in the automatic locking mode.

# Child Safety

7. Pull the seatbelt out of the retractor to make sure the retractor is in the automatic locking mode. You should not be able to pull more belt out. If the retractor is not locked, unbuckle the belt and repeat Steps 5 and 6.



8. Remove remaining slack from the belt. Force the seat down with extra weight, for example, by pressing down or kneeling on the child restraint while pulling up on the shoulder belt in order to force slack from the belt. This is necessary to remove the remaining slack that exists once you add the extra weight of the child to the child restraint. It also helps to achieve the proper snugness of the child restraint to your vehicle. Sometimes, a slight lean toward the buckle helps to remove remaining slack from the belt.
9. If the child restraint has a tether strap, attach it.



10. Before placing the child in the seat, forcibly move the seat forward and back to make sure the seat is securely held in place.

To check this, grab the seat at the belt path and attempt to move it side to side and forward and back. There should be no more than 1 in (2.5 cm) of movement.

We recommend checking with a NHTSA Certified Child Passenger Safety Technician to make certain the child restraint is properly installed. In Canada, check with Transport Canada for referral to a Child Car Seat Clinic.

## Using Seatbelts

 **WARNING:** Always use both the lap and shoulder portion of the seatbelt in the center seating position.

**Note:** *The following applies to the front center position of Super Cab and Crew Cab vehicles.*

The seatbelt webbing below the tongue is the lap portion of the seatbelt. The webbing above the tongue is the shoulder belt portion of the seatbelt.

1. Position the child restraint in the front center seat.

# Child Safety



2. Slide the tongue up the webbing.



3. While holding both shoulder and lap portions next to the tongue, route the tongue and webbing through the child restraint according to the child restraint manufacturer's instructions. Make sure you did not twist the belt webbing.

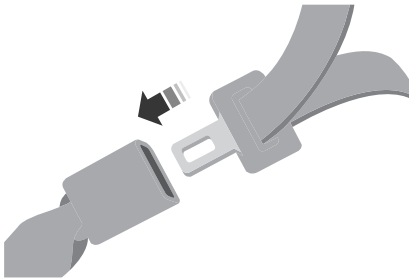

4. Insert the belt tongue into the proper buckle for that seating position until the latch engages. Make sure the tongue is latched securely by pulling on it.



5. When pushing down with your knee on the child restraint, pull up on the shoulder belt portion to tighten the lap belt portion of the seatbelt.
6. Allow the seatbelt to retract and remove any slack in the belt to securely tighten the child restraint in the vehicle.
7. If the child restraint has a tether strap, attach it.



# Child Safety

8. Before placing the child in the seat, forcibly move the seat forward and back to make sure the seat is securely held in place. To check this, grab the seat at the belt path and attempt to move it side to side and forward and back. There should be no more than 1 in (2.5 cm) of movement.
  9. Check from time to time to be sure that there is no slack in the lap and shoulder belt. The shoulder belt must be snug to keep the lap belt tight during a crash.
- Two lower anchors where the vehicle seat backrest and seat cushion meet, called the seat bight.
  - One top tether anchor behind that seating position.

LATCH compatible child restraints have two rigid or webbing mounted attachments. These attachments connect to the two lower anchors at the LATCH equipped seating positions in your vehicle. This type of attachment method eliminates the need to use seatbelts to attach the child restraint.

We recommend checking with a NHTSA Certified Child Passenger Safety Technician to make certain the child restraint is properly installed. In Canada, check with Transport Canada for referral to a Child Car Seat Clinic.

However, you can still use the seatbelt to attach the child restraint if the lower anchors are not used. For forward-facing child restraints, you must also attach the top tether strap to the proper top tether anchor if a top tether strap has been provided with your child restraint.

## USING LOWER ANCHORS AND TETHERS FOR CHILDREN

Follow the instructions later in this chapter on attaching child restraints with tether straps.



**WARNING:** Do not attach two child safety restraints to the same anchor. In a crash, one anchor may not be strong enough to hold two child safety restraint attachments and may break, causing serious injury or death.



**WARNING:** Depending on where you secure a child restraint, and depending on the child restraint design, you may block access to certain seatbelt buckle assemblies and LATCH lower anchors, rendering those features potentially unusable. To avoid risk of injury, make sure occupants only use seating positions where they are able to be properly restrained.

The Lower Anchors and Tethers for Children (LATCH) system has three vehicle anchor points:

## INSTALLING A CHILD RESTRAINT IN A CENTER SEAT



**WARNING:** The standardized spacing for LATCH lower anchors is 11 in (280 mm) center to center. Do not use LATCH lower anchors for the center seating position unless the child restraint manufacturer's instructions permit and specify using anchors spaced at least as far apart as those in this vehicle.

The lower anchors at the center of the second row rear seat are spaced 25.7 in (652 mm) apart. The standardized spacing for LATCH lower anchors is 11 in (280 mm) center to center.

# Child Safety

You cannot install a child restraint with rigid LATCH attachments at the center seating position. You can only use LATCH compatible child restraints with attachments on belt webbing at this seating position provided that the child restraint manufacturer's instructions permit use with the anchor spacing stated. Do not attach a child restraint to any lower anchor if another child restraint is attached to that anchor.

Each time you use the child restraint, check that the seat is properly attached to the lower anchors and tether anchor, if applicable. Tug the child restraint from side to side and forward and back where it is secured to the vehicle. The seat should move less than 1 in (2.5 cm).

If you did not properly anchor the child restraint, the risk of a child being injured in a crash greatly increases.

## COMBINING THE SEATBELT AND LOWER ANCHORS FOR ATTACHING CHILD RESTRAINTS

When used in combination, you may attach either the seatbelt or the LATCH lower anchors first, provided a proper installation is achieved. Attach the tether strap afterward, if it is included with the child restraint.

## USING TETHER STRAPS

Many forward-facing child restraints include a tether strap which extends from the back of the child restraint and hooks to an anchoring point called the top tether anchor. Tether straps are available as an accessory for many older child restraints.

Contact the manufacturer of your child restraint for information about ordering a tether strap, or to obtain a longer tether strap if the tether strap on your child restraint does not reach the appropriate top tether anchor in the vehicle.

Attach the tether strap only to the appropriate tether anchor. The tether strap may not work properly if attached somewhere other than the correct tether anchor.

If you install a child restraint with rigid LATCH attachments, do not tighten the tether strap enough to lift the child restraint off the vehicle seat cushion when the child is seated in it. Keep the tether strap just snug without lifting the front of the child restraint. Keeping the child restraint just touching the vehicle seat gives the best protection in a severe crash.

Once you have installed the child restraint using either the seatbelt, the lower anchors of the LATCH system, or both, you can attach the top tether strap.

## ATTACHING THE FRONT SEAT TETHER STRAP

Regular Cab



1. Route the child restraint tether strap over the back of the seat and under the head restraint.

# Child Safety

**Note:** For vehicles with adjustable head restraints, route the tether strap under the head restraint and between the head restraint posts. Otherwise, route the tether strap over the top of the seat backrest.

2. Locate the correct anchor for the selected seating position. You may need to pull the seat backrest forward to access the tether anchors. Make sure the seat is locked in the upright position before installing the child restraint.
3. Clip the tether strap to the anchor.
4. Tighten the child restraint tether strap according to the manufacturer's instructions.

If you incorrectly clip the tether strap, the child restraint may not be retained properly in the event of a crash.

If you did not properly anchor the child restraint, the risk of a child being injured in a crash greatly increases.

If your child restraint system has a tether strap, and the child restraint manufacturer recommends its use, we also recommend its use.

## ATTACHING THE REAR SEAT TETHER STRAP

Crew Cab and Super Cab

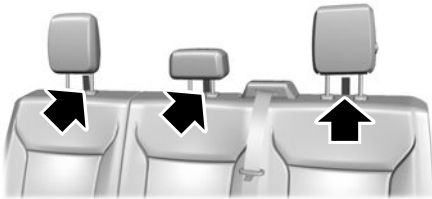

There are three loops of webbing above the back of the rear seat. Use these loops as routing loops and anchor loops for up to three child restraint tether straps.

For example, you can use the center loop as a routing loop for a child restraint in the center rear seat and as an anchoring loop for child restraints installed in the outermost rear seats.

Many tether straps cannot be tightened if the tether strap is hooked to the loop directly behind the child restraint.

To provide a tight tether strap:

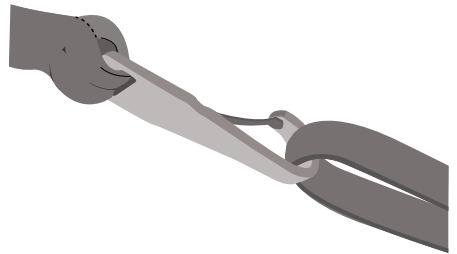

1. Route the vehicle tether loop between the head restraint posts, then route the child restraint tether strap through the loop, forward of the head restraint.
2. Hook the strap to the vehicle tether anchor loop in the adjacent seating position. If using the driver side, pass the strap behind the shoulder belt for the center seat. Put the tether strap through the routing loop. The head restraint support post holds the child restraint tightly, but the head restraint post is not strong enough to hold the child restraint during a crash.
3. Tighten the tether strap according to the child restraint manufacturer's instructions.



# Child Safety

If you did not properly anchor the child restraint, the risk of a child being injured in a crash greatly increases.

If your child restraint system has a tether strap, and the child restraint manufacturer recommends its use, we also recommend its use.

## BOOSTER SEATS

Use a belt-positioning booster seat for children who have outgrown or no longer properly fit in a child restraint and meet the following criteria.

- Generally children who are less than 57 in (1.45 m) tall.
- Are greater than age four (4) and less than age twelve (12).
- Are between 40 lb (18 kg) and 80 lb (36 kg) and upward to 100 lb (45 kg).

Many state and provincial laws require that children use approved booster seats until they reach age eight, a height of 57 in (1.45 m) tall, or 80 lb (36 kg).

Booster seats should be used until you can answer yes to all of these questions when seated without a booster seat:

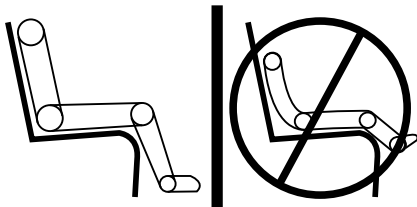

- Can the child sit all the way back against their vehicle seat backrest with knees bent comfortably at the edge of the seat cushion?
- Can the child sit without slouching?
- Does the lap belt rest low across the hips?
- Is the shoulder belt centered on the shoulder and chest?
- Can the child stay seated like this for the whole trip?

Always use booster seats in conjunction with your vehicle lap and shoulder belt.

## Types of Booster Seats



- Backless booster seats

If your backless booster seat has a removable shield, remove the shield.

If a vehicle seating position has a low seat backrest or no head restraint, a backless booster seat may place your child's head, as measured at the tops of the ears, above the top of the seat. In this case, move the backless booster to another seating position with a higher seat backrest or head restraint and lap and shoulder belts, or consider using a high-back booster seat.

# Child Safety



- High-back booster seats

If, with a backless booster seat, you cannot find a seating position that adequately supports your child's head, a high-back booster seat would be a better choice.

Children and booster seats vary in size and shape. Choose a booster that keeps the lap belt low and snug across the hips, never up across the stomach, and lets you adjust the shoulder belt to cross the chest and rest snugly near the center of the shoulder.

The following drawings compare the ideal fit to a shoulder belt uncomfortably close to the neck and a shoulder belt that could slip off the shoulder. The drawings also show how the lap belt should be low and snug across the child's hips.



# Child Safety

If the booster seat slides on the vehicle seat upon which it is being used, placing a rubberized mesh sold as shelf or carpet liner under the booster seat may improve this condition. Do not use any item thicker than this under the booster seat. Check with the booster seat manufacturer's instructions.

## Right-Hand Side

Turn the key clockwise to switch the child lock on and counterclockwise to switch it off.

## CHILD SAFETY LOCKS



**WARNING:** You cannot open the rear doors from inside if you have put the child safety locks on.



A child safety lock is on the rear edge of each rear door. You must switch the child safety lock separately on each door.

## Left-Hand Side

Turn the key counterclockwise to switch the child lock on and clockwise to switch it off.

# Seatbelts

## SEATBELT PRECAUTIONS



**WARNING:** Always drive and ride with your seatback upright and the lap belt snug and low across the hips.



**WARNING:** Children must always be properly restrained.



**WARNING:** Do not allow a passenger to hold a child on their lap when your vehicle is moving. Failure to follow this instruction could result in personal injury or death in the event of a sudden stop or crash.



**WARNING:** All occupants of your vehicle, including the driver, should always properly wear their seatbelts, even when an airbag supplemental restraint system is provided. Failure to properly wear your seatbelt could seriously increase the risk of injury or death.



**WARNING:** It is extremely dangerous to ride in a cargo area, inside or outside of a vehicle. In a crash, people riding in these areas are more likely to be seriously injured or killed. Do not allow people to ride in any area of your vehicle that is not equipped with seats and seatbelts. Make sure everyone in your vehicle is in a seat and properly using a seatbelt. Failure to follow this warning could result in serious personal injury or death.



**WARNING:** In a rollover crash, an unbelted person is significantly more likely to die than a person wearing a seatbelt.



**WARNING:** Each seating position in your vehicle has a specific seatbelt assembly made up of one buckle and one tongue designed to be used as a pair. Use the shoulder belt on the outside shoulder only. Never wear the shoulder belt under the arm. Never use a single seatbelt for more than one person.



**WARNING:** Even with advanced restraints systems, properly restrain children 12 and under in a rear seating position. Failure to follow this could seriously increase the risk of injury or death.



**WARNING:** Seatbelts and seats may be hot in a vehicle that is in the sunshine. The hot seatbelts or seats may burn a small child. Check seat covers and buckles before you place a child anywhere near them.



**WARNING:** If your vehicle is involved in a crash, have the seatbelts and associated components inspected as soon as possible. Failure to follow this instruction could result in personal injury or death.

All seating positions in this vehicle have seatbelts. All occupants of the vehicle should properly wear their seatbelts, even when an airbag supplemental restraint system is provided.

The seatbelt system consists of:

- Lap and shoulder seatbelts.
- A shoulder seatbelt with automatic locking mode, except driver seatbelt.
- Height adjusters at the front outermost seating positions.
- Seatbelt pretensioners at the front outermost and rear outermost seating positions.

# Seatbelts



A seatbelt warning light and chime.



Crash sensors and monitoring system with readiness indicator.

The seatbelt pretensioners are designed to tighten the seatbelts when activated. In frontal and near-frontal crashes, the seatbelt pretensioners may be activated alone or, if the crash is of sufficient severity, together with the front airbags. In side crashes and rollovers, the pretensioners will be activated when the Safety Canopy is activated.

## FASTENING AND UNFASTENING THE SEATBELTS

This applies to all seating positions, except for the front center position of Super Cab and Crew Cab.



1. Insert the seatbelt tongue into the buckle until you hear a snap and feel it latch.

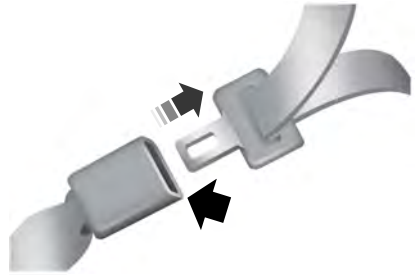

2. Press the button to release the seatbelt.

## Using the Seatbelt With Cinch Tongue

This applies to the front center seating position of Super Cab and Crew Cab.

The cinch tongue slides up and down the seatbelt webbing when you stow the seatbelt or when you put the seatbelts on. When you buckle the seatbelt, the cinch tongue allows you to shorten the lap portion, but pinches the webbing to keep the lap portion from getting longer. The cinch tongue is designed to slip during a crash, so wear the shoulder belt properly and do not allow any slack in either the lap or shoulder portions.

## Fastening the Cinch Tongue



**WARNING:** Always drive and ride with your seatback upright and the lap belt snug and low across the hips.

1. Pull the seatbelt from the retractor so that the shoulder belt portion of the seatbelt crosses your shoulder and chest.
2. Make sure the belt is not twisted. If the belt is twisted, remove the twist.

# Seatbelts

---

3. Insert the belt tongue into the proper buckle for your seating position until you hear a snap and feel it latch.
4. Make sure you securely fasten the tongue to the buckle by pulling on the tongue.

While you are fastened in the seatbelt, the seatbelt with a cinch tongue adjusts to your movement. However, if you brake hard, turn hard, or if your vehicle receives an impact of 5 mph (8 km/h) or more, the seatbelt locks and helps reduce your forward movement.

## **SENSITIVE LOCKING MODE**

### **WHAT IS SENSITIVE LOCKING MODE**

Sensitive locking mode is a seatbelt retractor feature that allows shoulder belt length adjustment according to your movements and locking in response to vehicle movement.

### **HOW DOES SENSITIVE LOCKING MODE WORK**

If the driver suddenly brakes, turns a corner sharply, or the vehicle receives an impact of about 5 mph (8 km/h) or more, the seatbelts lock to help reduce forward movement of the driver and passengers.

In addition, the seatbelt retractor locks if you pull the seatbelt webbing out too quickly. If the retractor locks, slowly lower the height adjuster to allow the seatbelt to retract.

If the retractor does not unlock, pull the seatbelt out slowly then feed a small length of webbing back toward the stowed position.

For rear seatbelts, recline the rear seat backrest or push the seat backrest cushion away from the seatbelt. Feed a small length of webbing back toward the stowed position.

## **AUTOMATIC LOCKING MODE**

### **WHAT IS AUTOMATIC LOCKING MODE**

This feature keeps the seatbelts pre-locked. The belt still retracts to remove any slack in the shoulder belt.

### **WHEN TO USE AUTOMATIC LOCKING MODE**

Use this mode any time you install a child restraint in a front seating position in a Regular Cab, Super Cab, Crew Cab or any rear seating position of a Super Cab or Crew Cab. The optional front seat center seatbelt in the Super Cab and Crew Cab has a cinch mechanism. Properly restrain children 12 years old and under in a rear seat whenever possible. See **Child Safety** (page 35).

**Note:** *Automatic locking mode is not available on the driver seatbelt.*

# Seatbelts

## ENGAGING AUTOMATIC LOCKING MODE



1. Fasten the combination lap and shoulder belt.
2. Grasp the shoulder portion and pull downward until you pull the entire belt out.
3. Allow the belt to retract. As the belt retracts, you will hear a clicking sound. This indicates the seatbelt is now in the automatic locking mode.

## DISENGAGING AUTOMATIC LOCKING MODE

Unbuckle the combination lap and shoulder belt and allow it to retract completely to disengage the automatic locking mode and activate the vehicle sensitive locking mode.

## ADJUSTING THE SEATBELTS DURING PREGNANCY



**WARNING:** Always ride and drive with your seatback upright and properly fasten your seatbelt. Fit the lap portion of the seatbelt snugly and low across the hips. Position the shoulder portion of the seatbelt across your chest. Pregnant women must follow this practice. See the following figure.

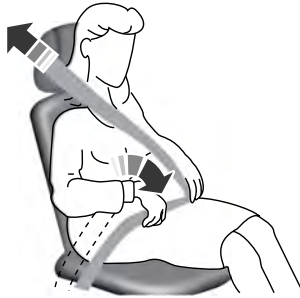

Pregnant women should always wear their seatbelt. Position the lap belt portion of a combination lap and shoulder belt low across the hips below the belly and worn as tight as comfort allows. Position the shoulder belt to cross the middle of the shoulder and the center of the chest.

## ADJUSTING THE SEATBELT HEIGHT



**WARNING:** Position the seatbelt height adjuster so that the seatbelt rests across the middle of your shoulder. Failure to adjust the seatbelt correctly could reduce its effectiveness and increase the risk of injury in a crash.

# Seatbelts

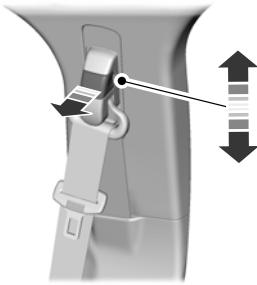

1. Pull the button and slide the height adjuster up or down.
2. Release the button and pull down on the height adjuster to make sure it is locked in place.

## ADJUSTING THE SEATBELT LENGTH



1. Pull some seatbelt webbing out of the shoulder belt retractor.
2. While holding the webbing below the tongue, grasp the metal tip of the tongue so that it is parallel to the webbing and slide the tongue up.
3. Provide enough lap belt length so that the tongue can reach the buckle.

## SEATBELT REMINDER

### HOW DOES THE SEATBELT REMINDER WORK

This feature supplements the seatbelt warning function. It provides additional reminders by intermittently sounding a tone and illuminating the seatbelt warning light when you are in the driver seat and a seatbelt is unbuckled.



# Seatbelts

---

<b>If</b>	<b>Then</b>
You buckle your seatbelt before you switch the ignition on or less than 1-2 minutes elapse after you switch the ignition on...	The Belt-Minder feature will not activate.
You do not buckle your seatbelt before your vehicle reaches at least 6 mph (9.7 km/h) and 1-2 minutes elapse after you switch the ignition on...	The Belt-Minder feature activates - the seatbelt warning light illuminates and a warning tone sounds for six seconds every 25 seconds, repeating for about five minutes or until you buckle your seatbelt.
The driver seatbelt is unbuckled for about one minute while the vehicle is traveling at least 6 mph (9.7 km/h) and more than 1-2 minutes elapse after you switch the ignition on...	The Belt-Minder feature activates - the seatbelt warning light illuminates and the warning tone sounds for six seconds every 25 seconds, repeating for about five minutes or until you buckle your seatbelt.

# Seatbelts

## SEATBELT REMINDER INDICATORS

A warning lamp illuminates if the ignition is on, a front seat is occupied and the seatbelt has not been fastened.



The warning lamp illuminates until you fasten your seatbelt.

## SEATBELT REMINDER AUDIBLE WARNINGS

A warning tone sounds if the warning lamp illuminates and your vehicle exceeds a relatively low speed.

The warning tone sounds for up to five minutes or until you fasten your seatbelt.

## SWITCHING THE SEATBELT REMINDER ON AND OFF



**WARNING:** While the system allows you to deactivate it, this system is designed to improve your chances of being safely belted and surviving an accident. We recommend you leave the system activated for yourself and others who may use the vehicle.

**Note:** *The driver and front passenger warnings switch off independently. When you perform this procedure for one seating position, do not buckle the other position as this cancels the process.*

**Note:** *If you are using MyKey, you cannot disable the seatbelt reminder. Also, if the seatbelt reminder has been previously disabled, it will be re-enabled during the use of MyKey. See **MyKey™** (page 77).*

Read Steps 1 - 4 before proceeding with the programming procedure.

Make sure that:

- The parking brake is set.
  - The transmission is in park (P).
  - The ignition is off.
  - The driver and front passenger seatbelts are unfastened.
1. Switch the ignition on. Do not start the engine.
  2. Wait about one minute until the seatbelt warning light switches off. After Step 2, wait an additional five seconds before proceeding with Step 3. Once you start Step 3, you must complete the procedure within 30 seconds.
  3. For the seating position you are switching off, buckle then unbuckle the seatbelt three times at a moderate speed, ending in the unbuckled state. After Step 3, the seatbelt warning light switches on.
  4. When the seatbelt warning light is on, buckle then unbuckle the seatbelt. After Step 4, the seatbelt warning light flashes for confirmation.

This switches the feature off for that seating position if it is currently on.

This switches the feature on for that seating position if it is currently off.

## CHECKING THE SEATBELTS

Check the seatbelts and child restraints periodically to make sure they work properly and are not damaged. Make sure there are no nicks, tears or cuts. Replace if necessary.

Check the following seatbelt assemblies after a crash.

- Retractors.
- Buckles.
- Front seatbelt buckle assemblies.

# Seatbelts

- Shoulder belt height adjusters.
- Shoulder belt guide on seat backrest.
- Child restraint LATCH and tether anchors.
- Attaching hardware.

Read the child restraint manufacturer's instructions for additional inspection and maintenance information specific to the child restraint.

We recommend that all seatbelt assemblies in use in vehicles involved in a crash be replaced. However, if the crash was minor and an authorized dealer finds that the belts do not show damage and continue to operate properly, they do not need to be replaced. Seatbelt assemblies not in use during a crash should also be checked and replaced if either damage or improper operation is noted.

Properly care for seatbelts. See **Cleaning Seatbelts** (page 426).

## SEATBELT EXTENSIONS



**WARNING:** Persons who fit into the vehicle's seatbelt should not use an extension. Unnecessary use could result in serious personal injury in the event of a crash.



**WARNING:** Only use extensions provided free of charge by our dealers. The dealer will provide an extension designed specifically for this vehicle, model year and seating position. The use of an extension intended for another vehicle, model year or seating position may not offer you the full protection of your vehicle's seatbelt restraint system.



**WARNING:** Never use seatbelt extensions to install child restraints.



**WARNING:** Do not use extensions to change the way the seatbelt fits across the torso, over the lap or to make the seatbelt buckle easier to reach.

If, because of body size or driving position, it is not possible to properly fasten the seatbelt over your lap and shoulder, an extension that is compatible with the seatbelts is available free of charge from our dealers. Only use our seatbelt extensions made by the original equipment seatbelt manufacturer with our seatbelts. Ask your authorized dealer if your extension is compatible with your vehicle restraint system.

# Airbags

## HOW DO THE FRONT AIRBAGS WORK

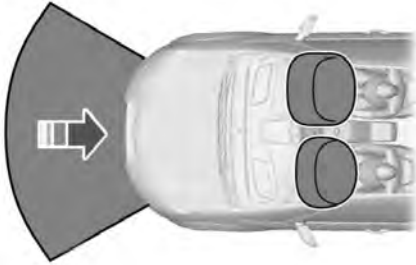

The driver and front passenger airbags deploy during significant frontal and near frontal crashes.

The driver and passenger front airbag system consists of:

- Driver and passenger airbag modules.
- Crash sensors and monitoring system with readiness indicator. See **Crash Sensors and Airbag Indicator** (page 65).

The airbags are a supplemental restraint system and are designed to work with the seatbelts to help protect the driver and right front passenger from certain upper body injuries. Airbags do not inflate slowly. There is a risk of injury from a deploying airbag.

**Note:** *You will hear a loud bang and see a cloud of harmless powdery residue if an airbag deploys. This is normal.*

The airbags inflate and deflate rapidly upon activation. After airbag deployment, it is normal to notice a smoke-like, powdery residue or smell the burnt propellant. This may consist of cornstarch, talcum powder, to lubricate the bag, or sodium compounds

(for example, baking soda) that result from the combustion process that inflates the airbag. Small amounts of sodium hydroxide may be present which may irritate the skin and eyes, but none of the residue is toxic.

Contact with a deploying airbag may cause abrasions or swelling. Temporary hearing loss is also a possibility as a result of the noise associated with a deploying airbag.

Because airbags must inflate rapidly and with considerable force, there is the risk of death or serious injuries such as fractures, facial and eye injuries or internal injuries, particularly to occupants who are not properly restrained or are otherwise out of position at the time of airbag deployment. Thus, it is extremely important that occupants be properly restrained as far away from the airbag module as possible while maintaining vehicle control.

Routine maintenance of the airbags is not required.

## HOW DO THE SIDE AIRBAGS WORK



**WARNING:** Do not place objects or mount equipment on or near the airbag cover, on the side of the front or rear seatbacks, or in areas that may come into contact with a deploying airbag. Failure to follow these instructions may increase the risk of personal injury in the event of a crash.



**WARNING:** Accessory seat covers not released by Ford Motor Company could prevent the deployment of the airbags and increase the risk of injuries in a crash.

# Airbags



**WARNING:** Do not lean your head on the door. The side airbag could injure you as it deploys from the side of the seatback.

The side airbags are on the outermost side of the seat backrests of the front seats. In certain sideways crashes or rollovers, the airbags will be inflated. The airbag was designed to inflate between the door panel and occupant to further enhance the protection provided to occupants in side impact crashes.



The system consists of the following:

- A label or embossed side panel indicating that side airbags are fitted to your vehicle.
- Side airbags inside the driver and front passenger seat backrests.
- Crash sensors and monitoring system with readiness indicator. See **Crash Sensors and Airbag Indicator** (page 65).

## HOW DOES THE SAFETY CANOPY™ WORK



**WARNING:** Do not place objects or mount equipment on or near the headliner at the siderail that may come into contact with a deploying curtain airbag. Failure to follow these instructions may increase the risk of personal injury in the event of a crash.



**WARNING:** Do not lean your head on the door. The curtain airbag could injure you as it deploys from the headliner.



**WARNING:** To reduce risk of injury, do not obstruct or place objects in the deployment path of the airbag.

The Safety Canopy deploys during significant side crashes or when a certain likelihood of a rollover event is detected by the rollover sensor. The Safety Canopy is mounted to the roof side-rail sheet metal, behind the headliner, above each row of seats. In certain sideways crashes or rollover events, the Safety Canopy will be activated, regardless of which seats are occupied. The Safety Canopy inflates between the side window area and occupants to further enhance protection provided in side impact crashes and rollover events.

# Airbags

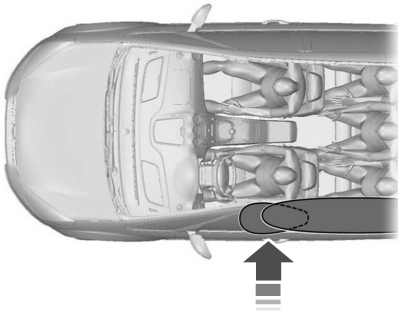

The system consists of the following:

- Safety Canopy curtain airbags above the trim panels over the front and rear side windows identified by a label or wording on the headliner or roof-pillar trim.
- A flexible headliner which opens above the side doors to allow air curtain deployment



• Crash sensors and monitoring system with a readiness indicator. See **Crash Sensors and Airbag Indicator** (page 65).

Properly restrain children 12 years old and under in the rear seats. The Safety Canopy will not interfere with children restrained using a properly installed child or booster seat because it is designed to inflate downward from the headliner above the doors along the side window opening.

## AIRBAG PRECAUTIONS



**WARNING:** Airbags do not inflate slowly or gently, and the risk of injury from a deploying airbag is the greatest close to the trim covering the airbag module.



**WARNING:** All occupants of your vehicle, including the driver, should always properly wear their seatbelts, even when an airbag supplemental restraint system is provided. Failure to properly wear your seatbelt could seriously increase the risk of injury or death.



**WARNING:** Properly secure children 12 years old and under in a rear seating position whenever possible. If you are unable to properly secure all children in a rear seating position, properly secure the largest child on the front seat. If you must use a forward facing child restraint on the front seat, move the seat as far back as possible. Failure to follow these instructions could result in personal injury or death.



**WARNING:** Do not place your arms on the airbag cover or through the steering wheel. Failure to follow this instruction could result in personal injury.



**WARNING:** Keep the areas in front of the airbags free from obstruction. Do not affix anything to or over the airbag covers. Objects could become projectiles during airbag deployment. Failure to follow this instruction could result in personal injury or death.



**WARNING:** To reduce risk of injury, do not obstruct or place objects in the deployment path of the airbag.



**WARNING:** Do not place a rearward facing child restraint in front of an active airbag. Failure to follow this instruction could result in personal injury or death.

# Airbags

**WARNING:** Do not attempt to service, repair, or modify the supplementary restraint system or associated components. Failure to follow this instruction could result in personal injury or death.

**WARNING:** Several airbag system components get hot after inflation. To reduce the risk of injury, do not touch them after inflation.

**WARNING:** If a supplementary restraint system component has deployed, it will not function again. Have the system and associated components inspected as soon as possible. Failure to follow this instruction could result in personal injury or death.

**WARNING:** The front passenger airbag is not designed to offer protection to an occupant in the center seating position.

**WARNING:** Your vehicle may have an airbag deactivation switch. Before driving, always look at the switch to make sure it is in the appropriate position. Failure to put the switch in the proper position can increase the risk of serious injury or death in a crash.



## SWITCHING THE PASSENGER AIRBAG ON AND OFF (IF EQUIPPED)

**WARNING:** Even with advanced restraints systems, properly restrain children 12 and under in a rear seating position. Failure to follow this could seriously increase the risk of injury or death.

The front passenger airbag on and off switch has indicators that illuminate, indicating that the front passenger frontal airbag is either on or off. The indicators are near the center of the instrument panel.

**Note:** *The indicators illuminate for a short period of time when you switch the ignition on to confirm it is functional.*

Switch Position	Passenger Airbag Status Indicator	Passenger Airbag
Off	OFF: Illuminated	Disabled
	ON: Not Illuminated	
On	OFF: Not Illuminated	Enabled
	ON: Illuminated	

# Airbags

## Switching the Passenger Airbag Off

**WARNING:** If the light does not illuminate when the passenger airbag switch is off and you switch the ignition on, have the passenger airbag switch serviced immediately by a qualified technician.

**WARNING:** To avoid switching on the airbag, always remove the ignition key with the switch in the off position.

**WARNING:** If your vehicle has rear seats, always transport children who are 12 and younger in the rear seat. Always use seatbelts and child restraints properly. Do not place a child in a rear facing infant seat in the front seat unless your vehicle is equipped with an airbag on and off switch and the passenger airbag is turned off. This is because the back of the infant seat is too close to the inflating airbag and the risk of a fatal injury to the infant when the airbag inflates is substantial.

The passenger airbag on and off switch is in the glovebox.



1. Insert the ignition key, turn the switch to OFF and hold in OFF while removing the key.
2. When you switch the ignition on, the passenger airbag off light illuminates briefly, momentarily shuts off and then switches back on. This indicates that the passenger airbag is deactivated.

## Switching the Passenger Airbag On

**WARNING:** The seatbelts for the driver and right front passenger seating positions are specifically designed to operate together with the airbags in certain types of crashes. When you switch off your airbag, you not only lose the protection of the airbag, you also may reduce the effectiveness of your seatbelt system. If the passenger does not meet the requirements stated in the National Highway Traffic Safety Administration or Transport Canada deactivation criteria, switching off the airbag can increase the risk of serious injury or death in a crash.

**WARNING:** If your vehicle has rear seats, always transport children who are 12 and younger in the rear seat. Always use seatbelts and child restraints properly. Do not place a child in a rear facing infant seat in the front seat unless your vehicle is equipped with an airbag on and off switch and the passenger airbag is turned off. This is because the back of the infant seat is too close to the inflating airbag and the risk of a fatal injury to the infant when the airbag inflates is substantial.



# Airbags



**WARNING:** If the passenger airbag off light is illuminated when the passenger airbag switch is on and the ignition is on, have the passenger airbag switch serviced immediately by a qualified technician.

The passenger airbag remains off until you switch it back on.



1. Insert the ignition key and turn the switch to ON.
2. The passenger airbag off light briefly illuminates when you switch the ignition on. This indicates that the passenger airbag is operational.

The passenger side airbag should always be on, and the passenger airbag off light should not be illuminated, unless the passenger is a person who meets the requirements stated either in Category 1, 2 or 3 of the National Highway Traffic Safety Administration or Transport Canada deactivation criteria which follows.

The vast majority of drivers and passengers are much safer with an airbag than without. To do their job and reduce the risk of life threatening injuries, airbags must open with great force, and this force can pose a potentially deadly risk in some situations, particularly when a front seat occupant is not properly buckled up. The most effective way to reduce the risk of unnecessary airbag injuries without reducing the overall safety of the vehicle is to make sure all occupants are properly restrained in the vehicle, especially in the front seat. This provides the protection of seatbelts and permits the airbags to provide the additional protection they were designed to provide. If you choose to deactivate your airbag, you are losing the very significant risk reducing benefits of the airbag and you are also reducing the effectiveness of the seatbelts. Seatbelts in modern vehicles are designed to work as a safety system with the airbags.

## National Highway Traffic Safety Administration Deactivation Criteria-Excluding Canada



**WARNING:** This vehicle has special energy management seatbelts for the driver and right front passenger. These particular seatbelts are specifically designed to work with airbags to help reduce the risk of injury in a crash. The energy management seatbelt gives or releases additional seatbelt webbing in some accidents to reduce the concentration of force on an occupant's chest and to reduce the risk of certain bone fractures and injuries to underlying organs. In a crash, if the airbag is off, this energy management seatbelt might permit the passenger wearing the seatbelt to move forward enough to have a serious or fatal injury. The more

# Airbags

severe the crash, and the heavier the occupant, the greater the risk. Make sure the airbag is on for any passenger who does not qualify under the National Highway Traffic Safety Administration deactivation criteria.

1. **Infant.** An infant, less than 1 year old, must ride in the front seat because:

- The vehicle has no rear seat.
- The vehicle has a rear seat too small to accommodate a rear-facing infant seat.
- The infant has a medical condition which, according to the infant's physician, makes it necessary for the infant to ride in the front so that the driver can constantly monitor the child's condition.

2. **Children age 1 to 12.** Children age 1 to 12 must ride in the front seat because:

- The vehicle has no rear seat.
- Although children ages 1 to 12 ride in the rear seat(s) whenever possible, children ages 1 to 12 sometimes must ride in the front because no space is available in the rear seat(s) of your vehicle.
- The child has a medical condition which, according to the child's physician, makes it necessary for the child to ride in the front seat so that the driver can constantly monitor the child's condition.

3. **Medical condition.** A passenger has a medical condition which, according to his or her physician:

- Causes the passenger airbag to pose a special risk for the passenger.
- Makes the potential harm from the passenger airbag in a crash greater than the potential harm from turning off the airbag and allowing the passenger, even if belted, to hit the dashboard or windshield in a crash.

## Transport Canada Deactivation Criteria-Canada Only



**WARNING:** This vehicle has special energy management seatbelts for the driver and right front passenger. These particular seatbelts are specifically designed to work with airbags to help reduce the risk of injury in a crash. The energy management seatbelt gives or releases additional seatbelt webbing in some accidents to reduce the concentration of force on an occupant's chest and to reduce the risk of certain bone fractures and injuries to underlying organs. In a crash, if the airbag is off, this energy management seatbelt might permit the passenger wearing the seatbelt to move forward enough to have a serious or fatal injury. The more severe the crash, and the heavier the occupant, the greater the risk. Make sure the airbag is on for any passenger who does not qualify under the Transport Canada deactivation criteria.

1. **Infant:** An infant, less than 1 year old, must ride in the front seat because:

# Airbags

- The vehicle has no rear seat.
- The rear seat in my vehicle cannot accommodate a rear-facing infant seat.
- The infant has a medical condition which, according to the infant's physician, makes it necessary for the infant to ride in the front seat so that the driver can monitor the infant's condition.

2. **Children age 12 or under:** Children age 12 or under must ride in the front seat because:

- The vehicle has no rear seat.
- Although children age 12 and under ride in the rear seat whenever possible, children age 12 and under have no option but to sometimes ride in the front seat because rear seat space is insufficient.
- The child has a medical condition that, according to the child's physician, makes it necessary for the child to ride in the front seat so that the driver can monitor the child's condition.

3. **Medical condition:** A passenger has a medical condition that, according to his or her physician:

- Poses a special risk for the passenger if the airbag deploys.
- Makes the potential harm from the passenger airbag deployment greater than the potential harm from turning off the airbag and experiencing a crash without the protection offered by the airbag.

## PROPERLY ADJUSTING THE DRIVER AND FRONT PASSENGER SEATS



**WARNING:** National Highway Traffic Safety Administration (NHTSA) recommends a minimum distance of at least 10 in (25 cm) between an occupant's chest and the driver airbag module.

To properly position yourself away from the airbag:

- Move your seat to the rear as far as you can while still reaching the pedals comfortably.
- Recline the seat slightly one or two degrees from the upright position.

After all occupants have adjusted their seats and put on seatbelts, it is very important that they continue to sit properly. Properly seated occupants sit upright, lean against the seat backrest, and center themselves on the seat cushion, with their feet comfortably extended on the floor. Sitting improperly can increase the chance of injury in a crash event. For example, if an occupant slouches, lies down, turns sideways, sits forward, leans forward or sideways, or puts one or both feet up, the chance of injury during a crash greatly increases.

## CHILDREN AND AIRBAGS



**WARNING:** Do not place a rearward facing child restraint in front of an active airbag. Failure to follow this instruction could result in personal injury or death.

# Airbags



Children must always be properly restrained. Accident statistics suggest that children are safer when properly restrained in the rear seating positions than in the front seating position. Failure to follow these instructions may increase the risk of injury in a crash.

If two adults and a child occupy a vehicle without rear seats, properly restrain the child in the center front seat unless doing so would interfere with driving your vehicle. This provides lap and shoulder belt protection for all occupants, and airbag protection for the adults. A child or infant properly restrained in the center front seat should not incur risk of serious injury from the airbags.

## CRASH SENSORS AND AIRBAG INDICATOR



**WARNING:** Modifying or adding equipment to the front of your vehicle could affect the performance of the airbag system, increasing the risk of injury. This includes the hood, bumper system, frame, front body structure, tow hooks, hood pins, push bar and snowplows.

Your vehicle has a collection of crash and occupant sensors. These sensors provide information to the restraints control module which activates the following:

- Seatbelt pretensioners.
- Adaptive steering column.
- Driver airbag.
- Passenger airbag.
- Seat mounted side airbags.
- Safety Canopy.

Based on the type of crash, the restraints control module deploys the appropriate safety devices.

The restraints control module also monitors the readiness of the above safety devices plus the crash and occupant sensors. The readiness of the safety system is indicated by a warning indicator light in the instrument cluster or by a backup tone if the warning light is not working. Routine maintenance of the airbag is not required.

A difficulty with the system is indicated by one or more of the following:



The readiness light will not illuminate immediately after you switch the ignition on.

- The readiness light either flashes or stays on.
- You hear a series of five tones. The tone pattern repeats periodically until the problem, the light or both are repaired.

If any of these things happen, even intermittently, have the supplemental restraint system serviced immediately. Unless serviced, the system may not function properly in the event of a crash.

# Airbags

---

The fact that the seatbelt pretensioners or front airbags did not activate for both front seat occupants in a crash does not mean that something is wrong with the system. Rather, it means the restraints control module determined the accident conditions (crash severity, seatbelt usage) were not appropriate to activate these safety devices.

- The front airbags activate only in frontal and near-frontal crashes. Front airbags may activate in rollovers, side impacts or rear impacts if the crash causes sufficient frontal deceleration.
- The adaptive steering column activates only in frontal and near-frontal crashes. It may activate in rollovers, side impacts or rear impacts if the crash causes sufficient frontal deceleration.
- The seatbelt pretensioners activate in frontal, near-frontal and side crashes, and in rollovers.
- The side airbags inflate in certain side impact crashes or rollover events. Side airbags may activate in other types of crashes if the vehicle experiences sufficient sideways motion or deformation.
- The Safety Canopy inflates in certain side impact crashes or rollover events. The Safety Canopy may activate in other types of crashes if the vehicle experiences sufficient sideways motion or deformation, or a certain likelihood of rollover.

## **DISPOSING OF AIRBAGS**

Contact your authorized dealer as soon as possible. Airbags must be disposed of by qualified personnel.

# 911 Assist

## WHAT IS 911 ASSIST

911 Assist is a SYNC system feature that can call for help.

For more information, visit [www.owner.ford.com](http://www.owner.ford.com).

## HOW DOES 911 ASSIST WORK

If a crash deploys an airbag, excluding knee airbags and rear inflatable seatbelts, or activates the fuel pump shut-off, your vehicle may be able to contact emergency services by dialing 911 through a paired and connected **Bluetooth**®-enabled phone.

Not all crashes will deploy an airbag or activate the fuel pump shut-off. If a connected cell phone sustains damage or loses its connection to SYNC during a crash, SYNC will search for and try to connect to a previously paired cell phone. SYNC will then attempt to call the emergency services.

Before making the call:

- SYNC provides about 10 seconds to cancel the call. If you fail to cancel the call, SYNC attempts to dial 911.
- SYNC says the following, or a similar message: "SYNC will attempt to call 911, to cancel the call, press Cancel on your screen or press and hold the phone button on your steering wheel."

If you do not cancel the call and SYNC makes a successful call a pre-recorded message plays for the 911 operator. The occupants in your vehicle are able to talk with the operator. Be prepared to provide your name, phone number and location immediately because not all 911 systems are capable of receiving this information electronically.

During an emergency call the system transmits vehicle data to the emergency service.

## EMERGENCY CALL REQUIREMENTS



**WARNING:** Do not wait for 911 Assist to make an emergency call if you can do it yourself. Dial emergency services immediately to avoid delayed response time which could increase the risk of serious injury or death after a crash. If you do not hear 911 Assist within five seconds of the crash, the system or phone may be damaged or non-functional.



**WARNING:** Always place your phone in a secure location in your vehicle so it does not become a projectile or get damaged in a crash. Failure to do so may cause serious injury to someone or damage the phone which could prevent 911 Assist from working properly.



**WARNING:** Unless the 911 Assist setting is set on before a crash, the system will not dial for help which could delay response time, potentially increasing the risk of serious injury or death after a crash.

- SYNC is powered and working properly at the time of the incident and throughout feature activation and use.
- The 911 Assist feature must be set on before the incident.
- You must pair and connect a **Bluetooth**® enabled and compatible cell phone to SYNC.
- A connected **Bluetooth**® enabled phone must have the ability to make and maintain an outgoing call at the time of the incident.

# 911 Assist

---

- A connected **Bluetooth®** enabled phone must have adequate network coverage, battery power and signal strength.
- The vehicle must have battery power and be located in the U.S., Canada or in a territory in which 911 is the emergency number.
- Your cellular phone or 911 Assist hardware sustains damage in a crash.
- The vehicle's battery or the SYNC system has no power.
- The phone(s) thrown from your vehicle are the ones paired and connected to the system.

**Note:** *If any user sets 911 Assist to on or off, that setting applies for all paired phones. If 911 Assist is off and the phone connected to SYNC, an icon displays on the status bar.*

**Note:** *Every phone operates differently. While SYNC 911 Assist works with most cellular phones, some may have trouble using this feature.*

## Privacy Notice

When you switch on 911 Assist, it may disclose to emergency services that your vehicle has been in a crash involving the deployment of an airbag or activation of the fuel pump shut-off. Certain versions or updates to 911 Assist may also be capable of electronically or verbally disclosing to 911 operators your vehicle location or other details about your vehicle or crash to assist 911 operators to provide the most appropriate emergency services. If you do not want to disclose this information, do not switch the feature on.

## EMERGENCY CALL LIMITATIONS

The SYNC 911 Assist feature only operates in the U.S., Canada or in a territory in which 911 is the emergency number. The following are limitations of this feature:

# Keys and Remote Controls

## REMOTE CONTROL LIMITATIONS



**WARNING:** Changes or modifications not expressly approved by the party responsible for compliance could void the user's authority to operate the equipment. The term "IC:" before the radio certification number only signifies that Industry Canada technical specifications were met.

This device complies with Part 15 of the FCC Rules and with Industry Canada license-exempt RSS standard(s). Operation is subject to the following two conditions: (1) This device may not cause harmful interference, and (2) This device must accept any interference received, including interference that may cause undesired operation.

Make sure a valid remote control is within 5 ft (1.5 m) from the front door handles and rear of vehicle.

The system may not function if:

- The remote control remains stationary for about a minute.
- The vehicle battery has no charge.
- The remote control battery has no charge.
- There is interference causing issues with the remote control frequencies.
- The remote control is too close to metal objects or electronic devices, for example keys or a cell phone.

## USING THE REMOTE CONTROL

Use your remote control to access various vehicle systems.

**Note:** *The buttons on your remote may vary depending on the vehicle region or options.*

## Unlock



Press the button to unlock all doors. See **Unlocking and Locking the Doors Using the Remote Control** (page 83).

## Lock



Press the button to lock all doors. See **Unlocking and Locking the Doors Using the Remote Control** (page 83).

## Remote Start (If Equipped)



Press the button to remote start. See **Remotely Starting and Stopping the Vehicle** (page 146).

## Tailgate (If Equipped)



Press the button to open the tailgate. See **Opening the Tailgate Using the Remote Control** (page 99).

## Panic Alarm (If Equipped)



Press the button to sound the panic alarm. See **Sounding the Panic Alarm** (page 70).

## OPENING AND CLOSING THE FLIP KEY

### Opening Your Flip Key

Press the round button on the remote control to extend the flip key.



# Keys and Remote Controls

## REMOVING THE KEY BLADE



**Note:** *Inspect the key blade for debris. Periodically clean with a brush.*

### Closing Your Flip Key

Press and hold the round button on the remote control to fold the key blade when not in use.

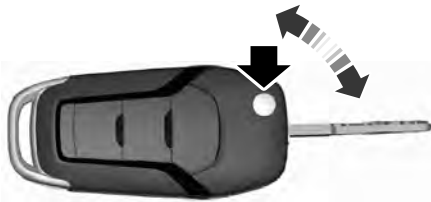

Push the release button on your passive key and pull the key blade out.

## SOUNDING THE PANIC ALARM



Press the button to sound the panic alarm. Press the button again, or switch the ignition on to turn it off.

**Note:** *The panic alarm only operates when the ignition is off.*

## LOCATING YOUR VEHICLE



Press the lock button twice within three seconds. The turn signal lamps flash.

**Note:** *We recommend you use this method to locate your vehicle.*

# Keys and Remote Controls

## CHANGING THE REMOTE CONTROL BATTERY

**⚠ WARNING:** Keep batteries away from children to prevent ingestion. Failure to follow this instruction could result in personal injury or death. If ingested, immediately seek medical attention.

**⚠ WARNING:** If the battery compartment does not securely close, stop using the remote control and replace it as soon as possible. In the meantime, keep the remote control away from children. Failure to follow this instruction could result in personal injury or death.

The remote control uses one coin-type 3-volt lithium battery CR2450 or equivalent.

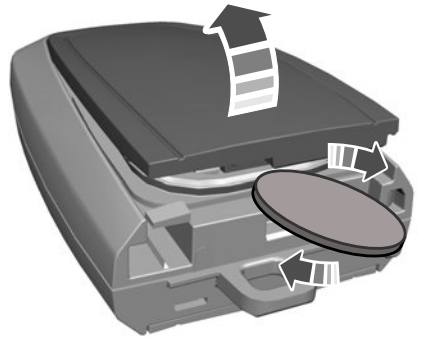
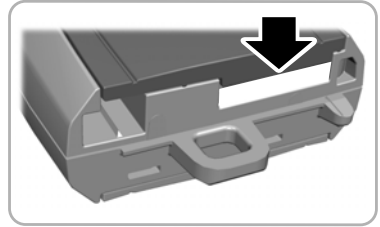

2. Twist a thin coin under the tab hidden behind the key blade head to remove the battery cover.



1. Push the release button and pull the key blade out.

# Keys and Remote Controls

## CHANGING THE REMOTE CONTROL BATTERY - VEHICLES WITH: FLIP KEY

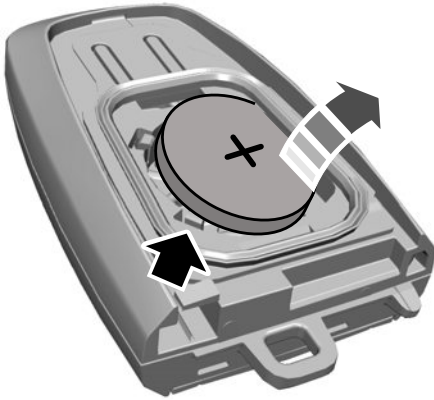

3. Insert a screwdriver, and carefully remove the battery.
4. Install a new battery with the + facing upward.
5. Reinstall the battery housing cover onto the transmitter and install the key blade.



Dispose of old batteries in an environmentally friendly way. Seek advice from your local authority about recycling old batteries.

**Note:** Do not wipe off any grease on the battery terminals or on the back surface of the circuit board.

**Note:** Replacing the battery does not erase the programmed key from your vehicle. The remote control should operate normally.



**WARNING:** Keep batteries away from children to prevent ingestion. Failure to follow this instruction could result in personal injury or death. If ingested, immediately seek medical attention.



**WARNING:** If the battery compartment does not securely close, stop using the remote control and replace it as soon as possible. In the meantime, keep the remote control away from children. Failure to follow this instruction could result in personal injury or death.

### Battery Replacement Procedure

The remote control uses one coin-type 3-volt lithium battery CR2032 or equivalent.

Press the button to release the key blade before beginning the procedure.



1. Insert a screwdriver, in the position shown and gently push the clip.
2. Press the clip down to release the battery cover.

# Keys and Remote Controls

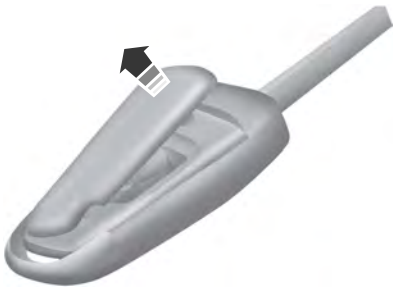

3. Carefully remove the cover.



4. Insert a screwdriver as shown to release the battery.



**Note:** Do not touch the battery contacts or the printed circuit board with the screwdriver.

5. Remove the battery.

6. Install a new battery with the + facing up.

7. Replace the battery cover.



Dispose of old batteries in an environmentally friendly way. Seek advice from your local authority about recycling old batteries.

**Note:** Do not wipe off any grease on the battery terminals or on the back surface of the circuit board.

**Note:** Replacing the battery does not erase the programmed key from your vehicle. The remote control should operate normally.

## REPLACING A LOST KEY OR REMOTE CONTROL

You can purchase replacement keys or remote controls from an authorized dealer. Authorized dealers can program remote controls for your vehicle.



**Note:** Your vehicle keys came with a security label that provides important key cut information. Keep the label in a safe place for future reference.

# Keys and Remote Controls

## PROGRAMMING THE REMOTE CONTROL

### General Information

You must have two previously programmed remote controls inside your vehicle and the new unprogrammed remote controls readily accessible. Contact an authorized dealer to have the spare remote control programmed if two previously programmed remotes are not available. Make sure that your vehicle is off before beginning this procedure. Make sure that you close all the doors before beginning and that they remain closed throughout the procedure. Perform all steps within 30 seconds of starting the sequence. Stop and wait for at least one minute before starting again if you perform any steps out of sequence.

Read and understand the entire procedure before you begin.

**Note:** You can program a maximum of four remote controls to your vehicle.

**Note:** If your programmed remote controls are lost or stolen and you do not have an extra coded remote, you need to have your vehicle towed to an authorized dealer. Store an extra programmed remote away from your vehicle in a safe place to help prevent any inconvenience. Contact an authorized dealer to purchase additional spare or replacement remotes.

### Steps for Programming Your Spare Remote Control

**Note:** Your vehicle is equipped with one of the following center consoles.

### Programming Backup Location

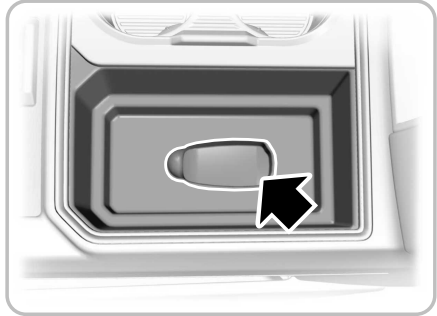
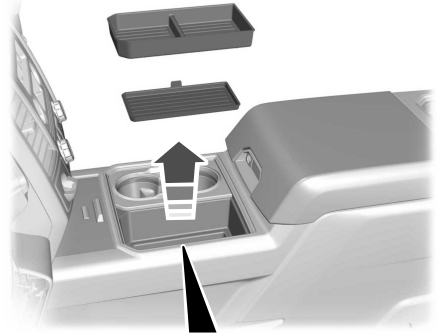

# Keys and Remote Controls

---

1. Place the first programmed remote in the backup slot inside the center console with your foot off the brake pedal, press and release the push button ignition switch.
2. Wait five seconds and then press and release the push button ignition switch again.
3. Remove the remote control.
4. Within 10 seconds, place a second programmed remote control in the backup slot. Press and release the push button ignition switch.
5. Wait five seconds and then press and release the push button ignition switch again. Keep the ignition on for at least three seconds, but no more than 10 seconds.
6. Remove the remote control.
7. Place the unprogrammed remote control in the backup slot and press and release the push button ignition switch.

Programming is now complete. With your foot on the brake pedal, press the push button ignition switch to verify the remote control functions operate and your vehicle starts with the new remote control.

If programming was not successful, wait 10 seconds and repeat Steps 1 through 7. If you are still unsuccessful, take your vehicle to an authorized dealer.

## **PROGRAMMING THE REMOTE CONTROL - VEHICLES WITH: FLIP KEY**

### **General Information**

You can program your own remote control to your vehicle. This procedure programs both the engine immobilizer keycode and the remote entry portion of the remote control to your vehicle.

Only use remote controls with an integrated mechanical key.

You must have two previously programmed coded remote controls and the new un-programmed remote readily accessible. Contact an authorized dealer to have the spare remote control programmed if the two previously programmed coded remote controls are not available.

Read and understand the entire procedure before you begin.

### **Steps for Programming Your Spare Remote Control**

1. Insert the first previously programmed coded key into the ignition.
2. Switch the ignition from off to on. Keep the ignition on for at least three seconds, but no more than 10 seconds.
3. Switch the ignition off and remove the first coded key from the ignition.
4. After three seconds but within 10 seconds of switching the ignition off, insert the second previously coded key into the ignition.
5. Switch the ignition from off to on. Keep the ignition on for at least three seconds, but no more than 10 seconds.
6. Switch the ignition off and remove the second previously programmed coded key from the ignition.
7. After three seconds but within 10 seconds of switching the ignition off and removing the previously programmed coded key, insert the new un-programmed key into the ignition.
8. Switch the ignition from off to on. Keep the ignition on for at least six seconds until you hear the door locks cycle.
9. Remove the newly programmed coded key from the ignition.

# Keys and Remote Controls

---

The key starts the engine if programming is successful. You can operate the keyless remote entry system with the new remote control with integrated key.

If programming was not successful, wait 20 seconds and repeat Steps 1 through 8. If you are still unsuccessful, take your vehicle to an authorized dealer.

**Note:** *You can program a maximum of six coded remote controls to your vehicle.*

## KEYS AND REMOTE CONTROLS – TROUBLESHOOTING

### KEYS AND REMOTE CONTROLS – INFORMATION MESSAGES

Message	Action
Key Battery Low Replace Soon	Replace remote control battery.

## WHAT IS MYKEY

MyKey allows you to program keys with restricted driving modes to promote good driving habits.

## MYKEY SETTINGS

### NON-CONFIGURABLE MYKEY SETTINGS

#### Seatbelt Reminder or Belt-Minder™

MyKey mutes the audio system until the front seat passengers buckle the front seat belts.

**Note:** *If your vehicle includes an AM/FM radio or a very basic audio system, then the radio may not mute.*

#### Satellite Radio (If Equipped)

Some Satellite radio channels have restricted access to adult radio content.

#### Early Low Fuel

The low fuel level warning lamp turns on earlier.

#### Driving and Parking Aids

You cannot configure settings for parking aids, blind spot information system, and cross traffic alert. These systems turn on when the vehicle turns on, and you cannot switch them off with a MyKey.

You cannot configure settings for pre-collision assist and lane keeping. These systems turn on when the vehicle turns on, but you can switch them off with a MyKey.

A new destination in the navigation system can only be set using voice commands when using a MyKey, and with your vehicle moving.

**Note:** *MyKey drivers may be able to switch the lane departure warning feature off, but this feature turns back on automatically with every new key cycle.*

## CONFIGURABLE MYKEY SETTINGS

You can configure the following settings after creating a MyKey. See **Creating a MyKey** (page 78).

### Speed Limit

 **WARNING:** Do not set MyKey maximum speed limit to a limit that will prevent the driver from maintaining a safe speed considering posted speed limits and prevailing road conditions. The driver is always responsible to drive in accordance with local laws and prevailing conditions. Failure to do so could result in accident or injury.

You can set a speed limit for your vehicle. Warning messages appear in the information display and a tone sounds if your vehicle reaches the set speed. You cannot override the set speed when using a MyKey.

### Speed Minder

You can set a speed reminder for your vehicle. Warning messages appear in the information display and a tone sounds if your vehicle exceeds the set speed.

### Audio System Volume Limit

The audio system maximum volume reduces. A message appears in the information display if you attempt to exceed the volume limit. Automatic volume control turns off.



## Emergency Assistance

If you set emergency assistance to always on, you cannot switch it off with a MyKey.

## Do Not Disturb

If you set do not disturb to always on, you cannot switch it off with a MyKey.

**Note:** *If a phone is connected using Apple CarPlay or Android Auto while driving with a MyKey, the driver can receive phone calls and text messages even if the do not disturb restriction is on, and if the vehicle comes with satellite radio, there is no restriction on the adult content.*

## Traction and Stability Control

If you set traction control or stability control to always on, you cannot switch it off with a MyKey.

## CREATING A MYKEY

Vehicles with a center console shifter:

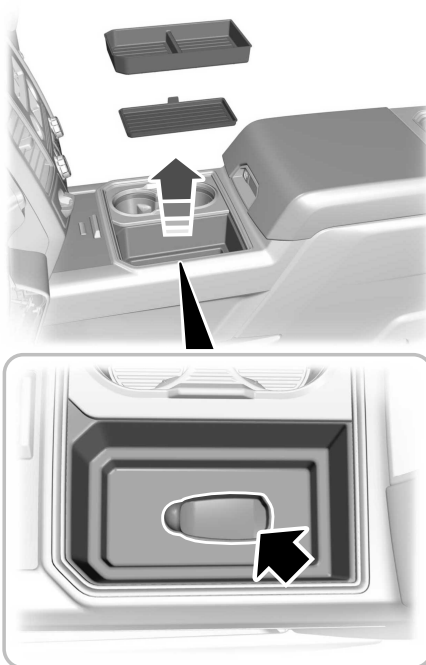

1. Remove the mat from the center console cup holder.
2. Remove the key blade from the transmitter.
3. Place the remote control in the backup slot with the buttons facing toward the front of the vehicle.
4. Switch the ignition on using an admin key.
5. Using the instrument cluster display controls on the steering wheel, select **Settings**.
6. Select **Vehicle Settings**.
7. Select **MyKey**.
8. Select **Create MyKey**.

# MyKey™

9. Select **Create MyKey** and press the **OK** button.

**Note:** After you confirm the creation of a MyKey, we recommend that you label this key.

Vehicles with a column shifter.



1. Raise the front center seat storage lid.
2. Place the remote control in the backup slot with the buttons facing toward the front of the vehicle.
3. Switch the ignition on using an admin key.
4. Using the instrument cluster display controls on the steering wheel, select **Settings**.
5. Select **Vehicle Settings**.
6. Select **MyKey**.
7. Select **Create MyKey**.
8. Select **Create MyKey** and press the **OK** button.

**Note:** After you confirm the creation of a MyKey, we recommend that you label this key.

## CREATING A MYKEY - VEHICLES WITH: FLIP KEY

1. Switch the ignition on using an admin key.

2. Using the instrument cluster display controls on the steering wheel, select **Settings**.
3. Select **Vehicle Settings**.
4. Select **MyKey**.
5. Select **Create MyKey**.
6. Select **Create MyKey** and press the **OK** button.

**Note:** After you confirm the creation of a MyKey, we recommend that you label this key.

## PROGRAMMING A MYKEY

You can only program MyKeys to the same settings.

1. Switch the ignition on using an admin key.
2. Press the menu button on the steering wheel to enter the information display main menu.
3. Select **Settings**.
4. Select **MyKey**.
5. Select a setting and press the **OK** button.
6. Configure the setting.
7. Switch the ignition off.

## CLEARING ALL MYKEYS

When you clear all MyKeys, you remove all restrictions and return all MyKeys to their original admin key status.

1. Switch the ignition on using an admin key.
2. Press the menu button on the steering wheel to enter the information display main menu.
3. Select **Settings**.
4. Select **MyKey**.

5. Select **Clear MyKeys**.
6. Press and hold the **OK** button until a confirmation message appears in the information display.

## CHECKING MYKEY SYSTEM STATUS

You can find information about the distance traveled using a MyKey and also the number of admin keys and MyKeys created for your vehicle.

1. Switch the ignition on.

2. Press the menu button on the steering wheel to enter the information display main menu.
3. Select **Settings**.
4. Select **MyKey**.
5. Select **MyKey Info**.

## USING MYKEY WITH REMOTE START SYSTEMS

MyKey is not compatible with unapproved, aftermarket remote start systems. If you choose to install a remote start system, see an authorized dealer for an approved remote start system.

## MYKEY – TROUBLESHOOTING

### MYKEY – INFORMATION MESSAGES

Message	Description
Place Key in Backup Location	Displays when trying to create a MyKey and the admin key is not placed in the backup position. See <b>Creating a MyKey</b> (page 78).
Key is Already a MyKey	Displays when trying to create a MyKey with a key already designated as a MyKey.
This Key restricted at Next Key Cycle. Label Key as MyKey	Displays to confirm that the key is restricted after you switch the ignition off.

# MyKey™

---

## MYKEY – INFORMATION MESSAGES - VEHICLES WITH: FLIP KEY

<b>Message</b>	<b>Description</b>
Key is Already a MyKey	Displays when trying to create a MyKey with a key already designated as a MyKey.
This Key restricted at Next Key Cycle. Label Key as MyKey	Displays to confirm that the key is restricted after you switch the ignition off.

## MYKEY – FREQUENTLY ASKED QUESTIONS

### What is an admin key?

An admin key is a key that you have not created as a MyKey. See **Creating a MyKey** (page 78).

### Why am I not able to create a MyKey?

You have not placed the admin key in the backup position. See **Creating a MyKey** (page 78). The key used to switch the ignition on is not an admin key. The key used to switch the ignition on is the only admin key. There has to be at least one admin key. You did not switch the ignition off after creating the last MyKey.

### Why am I not able to program a MyKey?

The admin key is not inside your vehicle. The key used to switch the ignition on is not an admin key. You have not created any MyKeys. See **Creating a MyKey** (page 78).

### Why am I not able to clear the MyKeys?

The admin key is not inside your vehicle. The key used to switch the ignition on is not an admin key. You have not created any MyKeys. See **Creating a MyKey** (page 78).

### Why is the MyKey distance not accumulating?

The key used to start the engine is an admin key. An admin key and a MyKey are inside your vehicle. You have not created any MyKeys. See **Creating a MyKey** (page 78). You have cleared the MyKeys. See **Clearing All MyKeys** (page 79).

### Why am I not able to start the engine with a MyKey?

An admin key and a MyKey are inside your vehicle. The system recognizes only the admin key when both are present.

## MYKEY – FREQUENTLY ASKED QUESTIONS - VEHICLES WITH: FLIP KEY

### What is an admin key?

An admin key is a key that you have not created as a MyKey. See **Creating a MyKey** (page 79).

### Why am I not able to create a MyKey?

The key used to switch the ignition on is not an admin key. The key used to switch the ignition on is the only admin key. There has to be at least one admin key.

### Why am I not able to program a MyKey?

The key used to switch the ignition on is not an admin key. You have not created any MyKeys. See **Creating a MyKey** (page 79).

### Why am I not able to clear the MyKeys?

The key used to switch the ignition on is not an admin key. You have not created any MyKeys. See **Creating a MyKey** (page 79).

### Why is the MyKey distance not accumulating?

The key used to start the engine is an admin key. You have not created any MyKeys. See **Creating a MyKey** (page 79). You have cleared the MyKeys. See **Clearing All MyKeys** (page 79).

# Doors and Locks

## OPERATING THE DOORS FROM OUTSIDE YOUR VEHICLE

### UNLOCKING AND LOCKING THE DOORS USING THE REMOTE CONTROL

You can only use the remote control when your vehicle is stationary.

#### Unlocking the Doors



Press the button to unlock all doors.

#### Locking the Doors



Press the button to lock all doors. One short flash of the turn signal lamps confirms that your vehicle has locked.

**Note:** For more information on operating the doors from outside your vehicle See **Keyless Entry Keypad** (page 89).

### UNLOCKING AND LOCKING THE DOORS USING THE KEY BLADE

If there is a power door lock fault you can use the key blade to lock and unlock the doors.

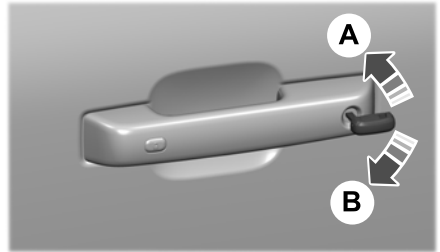

A Lock.

B Unlock.

## OPERATING THE DOORS FROM INSIDE YOUR VEHICLE

### INDIVIDUALLY UNLOCKING AND LOCKING THE DOORS USING THE LOCKING BUTTON

The power door lock control is on the driver and front passenger door panels.

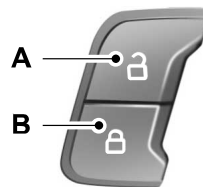

A Unlock.

B Lock.

# Doors and Locks

---

## OPENING THE DOORS FROM INSIDE YOUR VEHICLE - CREW CAB

Pull the interior door handle twice to unlock and open a rear door. The first pull unlocks the door and the second pull opens the door.

## AUTOUNLOCK

### WHAT IS AUTOUNLOCK

Autounlock is an unlocking feature that unlocks the vehicle doors when your vehicle comes to a stop.

### AUTOUNLOCK REQUIREMENTS

Autounlock unlocks all the doors when all of the following occur:

- The ignition is on, all the doors are closed and your vehicle is moving at a speed greater than 12 mph (20 km/h).
- Your vehicle comes to a stop.
- You open the driver door within 10 minutes of switching the ignition off or to the accessory position.

### SWITCHING AUTOUNLOCK ON AND OFF

1. Using the instrument cluster display controls on the steering wheel, select **Settings**.
2. Select **Vehicle Settings**.
3. Switch **Autounlock** on or off.

## AUTOLOCK

### WHAT IS AUTOLOCK

Autolock is a locking feature that locks your vehicle doors when you start driving.

## AUTOLOCK REQUIREMENTS

Autolock locks all the doors when all of the following occur:

- All doors are closed.
- The ignition is on.
- Your vehicle reaches a speed greater than 12 mph (20 km/h).

## MISLOCK

### WHAT IS MISLOCK

Mislock is a locking feature that warns you if your vehicle has not locked.

### MISLOCK LIMITATIONS

When you press the lock button once, the direction indicators do not flash if:

- Any door or the tailgate is open.
- The hood is open.

If you switch mislock off, the horn does not sound if you press the lock button on the remote control when a door is open.

### SWITCHING MISLOCK ON AND OFF

1. Using the instrument cluster display controls on the steering wheel, select **Settings**.
2. Select **Vehicle Settings**.
3. Switch **Mislock Chirp** on or off.

## DOORS AND LOCKS AUDIBLE WARNINGS

### Door Ajar Audible Warning

Sounds when a door is not fully closed and your vehicle is moving.

# Doors and Locks

---

## DOORS AND LOCKS – TROUBLESHOOTING

## DOORS AND LOCKS – WARNING LAMPS

### Door Ajar Warning Lamp



It illuminates when you switch the ignition on and remains on if any door or the hood is open.

## DOORS AND LOCKS – INFORMATION MESSAGES

Message	Action
Driver Door Ajar	Displays if a door is open. Fully close the door.
Passenger Door Ajar	
Rear Left Door Ajar	
Rear Right Door Ajar	



# Doors and Locks

---

## **DOORS AND LOCKS – FREQUENTLY ASKED QUESTIONS**

### **Can accessories such as steps or handles be used with the latch assembly?**

Do not use the door latch assembly to attach any accessory, such as handles or steps, as this can cause damage to your vehicle.

# Keyless Entry

## KEYLESS ENTRY LIMITATIONS

Make sure your remote control is within 3 ft (1 m) from the front door handles and the tailgate.

The system could not function if:

- The remote control remains stationary for about a minute.
- The vehicle battery has no charge.
- The remote control battery has no charge.
- There is interference causing issues with the remote control frequencies.
- The remote control is too close to metal objects or electronic devices, for example keys or a cell phone.

## KEYLESS ENTRY SETTINGS

### Switching Keyless Entry On and Off

1. Switch the ignition on using an original key that has not been created as a MyKey.
2. Press **Settings** on the touchscreen.
3. Press **Vehicle Settings**.
4. Press **Locks**.

### Reprogramming the Unlocking Function

You can enable two-stage unlocking function allowing you to unlock only the driver door when you touch the unlock sensor.

Press and hold both the lock and unlock buttons on the remote control for four seconds to disable or enable two-stage unlocking.

If you program the unlocking function so that only the driver door unlocks, you can unlock all of the other doors from inside your vehicle using the power door lock control. You can unlock individual doors by pulling the interior door handles on those doors.

## USING KEYLESS ENTRY

### Unlocking the Doors



With your passive key within 3 ft (1 m) of your vehicle, touch the unlock sensor on the back of the door handle for a brief period and then pull on the door handle to unlock, being careful not to touch the lock sensor at the same time or pull on the door handle too quickly. The intelligent access system requires a brief delay to authenticate your passive key.

### Locking the Doors



With your passive key within 3 ft (1 m) of your vehicle, touch the outer door handle lock sensor for approximately one second to lock, being careful not to touch the unlock sensor on the back of the door handle at the same time. After locking, you can immediately pull on the door handle to confirm locking occurred without inadvertently unlocking.

# Keyless Entry

---

## **KEYLESS ENTRY – TROUBLESHOOTING**

### **KEYLESS ENTRY – FREQUENTLY ASKED QUESTIONS**

#### **Why does the passive key not work?**

The system deactivates passive keys left inside your vehicle when you lock it. You cannot switch the ignition on using a deactivated passive key. Press the unlock button on the remote control to reactivate a passive key.

# Keyless Entry Keypad (If Equipped)

## WHAT IS THE KEYLESS ENTRY KEYPAD

The keyless entry keypad allows you to lock and unlock your vehicle using the keypad on the window trim.

## KEYLESS ENTRY KEYPAD LIMITATIONS

The system may not function if:

- The vehicle battery has no charge.

## LOCATING THE KEYLESS ENTRY KEYPAD

The keypad is near the driver window and illuminates when you touch it.



## KEYLESS ENTRY KEYPAD MASTER ACCESS CODE

### Unlocking the Doors

1-2
3-4
5-6
7-8
9-0

Enter the factory-set five-digit code or your personal code. You must press each number within five seconds of each other.

- Press 3-4 within five seconds to unlock all doors.

# Keyless Entry Keypad (If Equipped)

## Locking the Doors

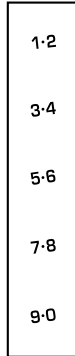

Press and hold **7-8** and **9-0** at the same time with the driver door closed.

**Note:** You do not need to enter the code first.

## KEYLESS ENTRY KEYPAD PERSONAL ACCESS CODES

### Programming a Personal Entry Code

1. Enter the five-digit master code.
2. Press **1-2** on the keypad within five seconds.
3. Enter your personal five-digit code. You must do this within five seconds of completing Step 2.
4. Press **1-2** on the keypad to save personal code 1.

The doors lock then unlock to confirm that programming was successful.

To program additional personal entry codes, repeat Steps 1 through 3, then for Step 4:

- Press **3-4** to save personal code 2.
- Press **5-6** to save personal code 3.
- Press **7-8** to save personal code 4.
- Press **9-0** to save personal code 5.

If your vehicle comes with SYNC, you can also program the system with a personal entry code.

Hints:

- Do not set a code that uses five of the same number.
- Do not use five numbers in sequential order.
- The five-digit master code works even if you have set your own personal code.

### Erasing a Personal Code

1. Enter the five-digit master code.
2. Press and release **1-2** on the keypad within five seconds.
3. Press and hold **1-2** for two seconds. You must do this within five seconds of completing Step 2.

All personal codes erase and only the five-digit master code works.

### Anti-Scan Feature

The keypad goes into an anti-scan mode if you enter the wrong code seven times. This mode turns off the keypad for one minute and the keypad lamp flashes.

The anti-scan feature turns off after:

- One minute of keypad inactivity.
- You press the unlock button on the remote control.
- You switch the ignition on.
- You unlock your vehicle using intelligent access.

# Keyless Entry Keypad (If Equipped)

## USING THE KEYLESS ENTRY KEYPAD

### Unlocking the Doors

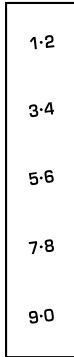

Enter the factory-set five-digit code or your personal code. You must press each number within five seconds of each other.

- Press **3-4** within five seconds to unlock all doors.

### Locking the Doors

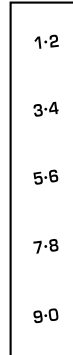

Press and hold **7-8** and **9-0** at the same time with the driver door closed.

**Note:** You do not need to enter the code first.

### To Release the Tailgate

Enter the factory-set code or your personal code, then press **5-6** control within 5 seconds.

## KEYLESS ENTRY KEYPAD – TROUBLESHOOTING

### KEYLESS ENTRY KEYPAD – FREQUENTLY ASKED QUESTIONS

#### Why does the keypad not accept the access code?

If you enter the access code too fast on the keypad, the unlock function may not work. Slowly re-enter the access code.

## Keyless Entry Keypad (If Equipped)

---

### **Why does the keypad not function?**

The keypad goes into an anti-scan mode if you enter a wrong code seven times. The anti-scan mode disables the keypad for one minute and the red light flashes.

# Easy Entry and Exit

---

## HOW DOES EASY ENTRY AND EXIT WORK

Easy entry and exit moves the driver seat rearward up to 2 in (5 cm) and the steering column up when you switch the ignition off. The driver seat and steering column return to their previous positions when you switch the ignition on.

**Note:** *Depending on your vehicle, the column may move up and in.*

## SWITCHING EASY ENTRY AND EXIT ON AND OFF

1. Press **Settings** on the touchscreen.
2. Press **Vehicle**.
3. Select **Easy Entry/Exit**.

If you press any adjustment or memory button when in easy exit mode, the system cancels the operation.



# Tailgate - Vehicles With: Manual Tailgate

## TAILGATE PRECAUTIONS



**WARNING:** It is extremely dangerous to ride in a cargo area, inside or outside of a vehicle. In a crash, people riding in these areas are more likely to be seriously injured or killed. Do not allow people to ride in any area of your vehicle that is not equipped with seats and seatbelts. Make sure everyone in your vehicle is in a seat and properly using a seatbelt. Failure to follow this warning could result in serious personal injury or death.

## OPENING THE TAILGATE

### OPENING THE TAILGATE FROM OUTSIDE YOUR VEHICLE

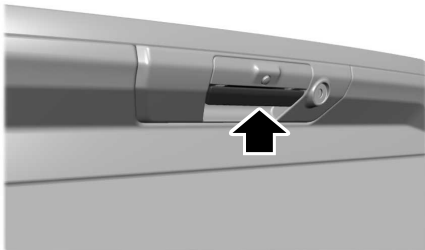

Pull up on the handle to release the tailgate.

**Note:** You may need to unlock the tailgate first.

## LOCKING AND UNLOCKING THE TAILGATE

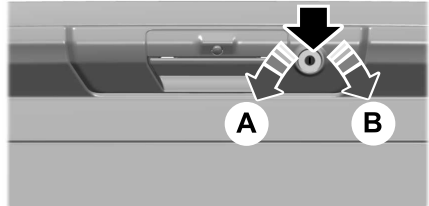

- A Lock.
- B Unlock.

1. Insert the ignition key into the tailgate lock.
2. Turn it to the left to lock the tailgate.
3. Turn it to the right to unlock the tailgate.

## REMOVING AND INSTALLING THE TAILGATE



**WARNING:** Always properly secure cargo to prevent shifting cargo or cargo falling from the vehicle. Failure to do so could result in compromised vehicle stability and serious personal injury to vehicle occupants or others.

## Tailgate - Vehicles With: Manual Tailgate

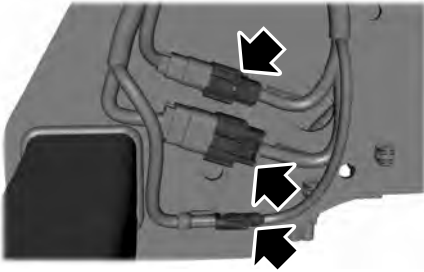

1. Obtain the tailgate removal kit from the glove box.
2. Locate and disconnect the frame connections. They are on the left-hand side of the vehicle.

**Note:** Your vehicle may have up to three frame connections.

3. Install the protective caps on the in-line connector portion that remains under the pickup box.

**Note:** If you do not install the caps on the connectors, some features may not operate as intended.

4. Partially lower the tailgate. Carefully feed the tailgate harness up through the gap between the pickup box and the bumper and place it out of the way under the pickup box.
5. Lower the tailgate.

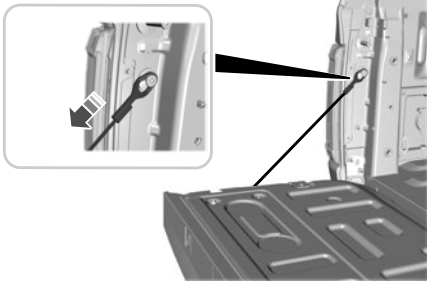

6. Use a screwdriver to gently pry the spring clip on each connector past the head of the support screw. Disconnect the cable.

7. Disconnect the other cable.

**Note:** To avoid damaging the tailgate, you may need assistance when removing. The tailgate weighs approximately 97 lb (44 kg).

8. Lift the tailgate to 45 degrees from the horizontal position.
9. Lift the right-hand side off its hinge.
10. Lift the tailgate to 80 degrees from the horizontal position.
11. Remove the tailgate from the left-hand side hinge by sliding it to the right.
12. Install the tailgate in reverse order.

### TAILGATE STEP

#### ACCESSING THE TAILGATE STEP

1. Lower the tailgate.
2. Push the button in the center of the step molding. The step pops out slightly.

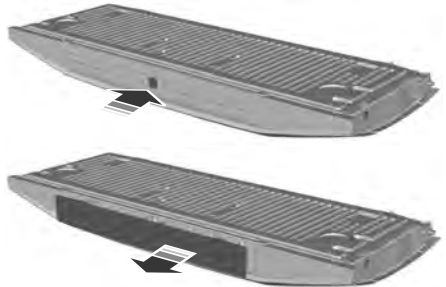

3. Pull the step out fully. Lower the step to its lowest position.

## Tailgate - Vehicles With: Manual Tailgate



4. Pull the yellow handle stop backward out of the tailgate until it fully extends.
5. To lock the handle in place, rotate the handle up from the horizontal to the vertical position until you hear a click.

**Note:** Do not tow with the step or grab handle.

Replace the slip resistance tape or grab handle molding if it appears as worn or damaged.

To reduce the risk of falling:

- Only operate the step when your vehicle is on a level surface.
- Only operate the step in areas with sufficient lighting.
- Make sure you use the grab handle when climbing on the step.
- Do not use the step with bare feet.
- Make sure the step is clean before use.
- Keep the step load below the total maximum load of 350 lb (159 kg).

### STOWING THE TAILGATE STEP

1. Press the yellow button on the handle to lower and then press the yellow lever at the bottom of the handle to unlock. Rotate the handle down from the vertical to the horizontal position and push it into the tailgate.

2. Rotate the step up until it is horizontal, then push it back into the tailgate until the step is secure.

**Note:** Make sure to close and fully latch the step before moving your vehicle. Do not drive with the step or grab handle open.

**Note:** The power tailgate cannot close if the step is opened. A warning message appears and a chime sounds. After stowing step the power close function is restored.

### BED EXTENDER

#### BED EXTENDER PRECAUTIONS

**Note:** Do not use the bed extender when driving off road.

**Note:** Make sure to engage the locking pins and knobs fully before driving your vehicle.

**Note:** Make sure to secure all cargo.

**Note:** Do not exceed 150 lb (68 kg) on the tailgate when your vehicle is moving.

**Note:** Do not keep the bed extender in the tailgate mode when you are not using it for restraining cargo. Always keep the bed extender in the grocery mode or the stowed position with the tailgate closed.

## Tailgate - Vehicles With: Manual Tailgate

### USING THE BED EXTENDER

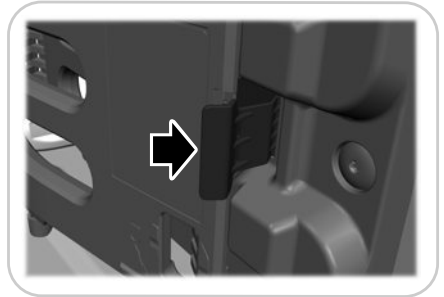
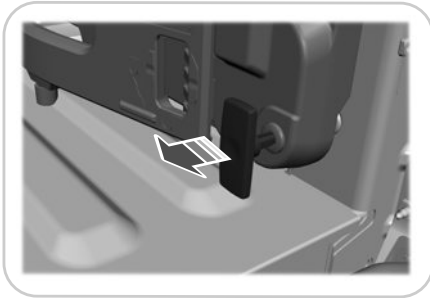
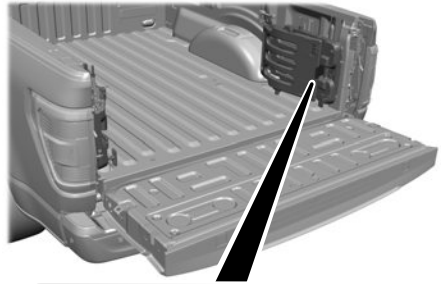
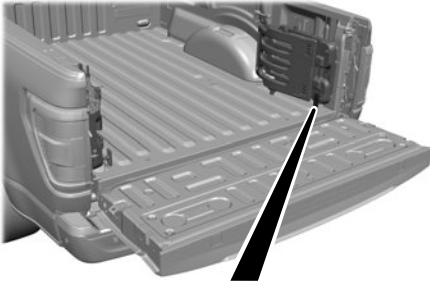

1. Pull the locking pin toward the center of your vehicle.

2. Open the latches to release the panels.

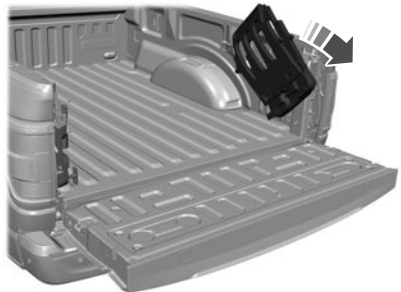

3. Rotate the panels toward the tailgate. Repeat steps 1-3 on the other side of your vehicle.

## Tailgate - Vehicles With: Manual Tailgate

### Grocery Mode

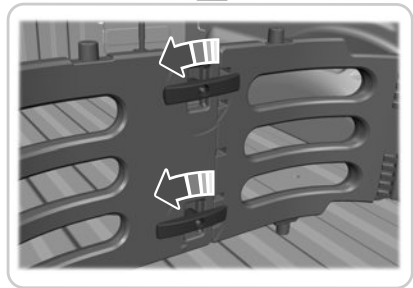
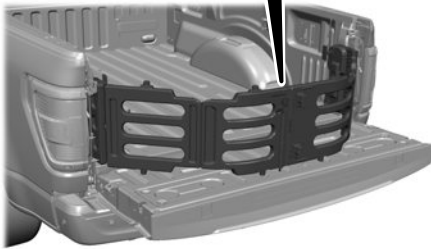
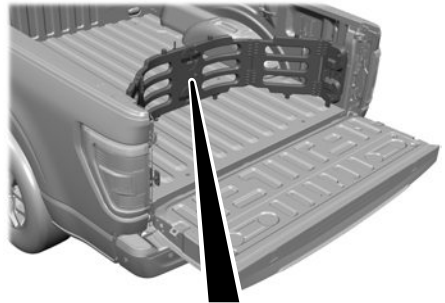
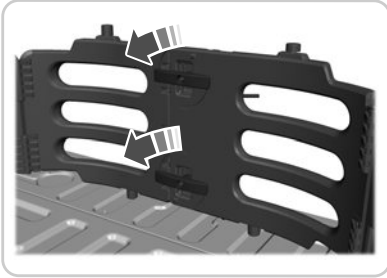

4. Connect the two panels. Rotate both knobs one-quarter turn clockwise to secure the panels.

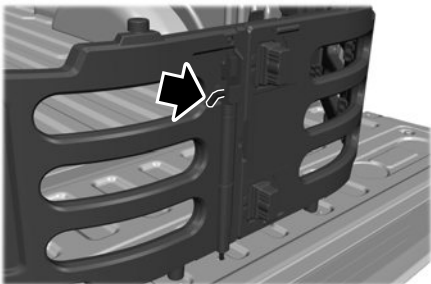

5. Insert the latch rod into the tailgate hole.
6. Engage both sides of the locking pins into their holes in the pick-up box.

1. Follow steps 1-4.
2. Before engaging the locking pins, rotate the panels away from the tailgate.
3. Engage both sides of the locking pins into their holes in the pick-up box.
4. Close the tailgate.

# Tailgate - Vehicles With: Remote Release Tailgate

## TAILGATE PRECAUTIONS



**WARNING:** It is extremely dangerous to ride in a cargo area, inside or outside of a vehicle. In a crash, people riding in these areas are more likely to be seriously injured or killed. Do not allow people to ride in any area of your vehicle that is not equipped with seats and seatbelts. Make sure everyone in your vehicle is in a seat and properly using a seatbelt. Failure to follow this warning could result in serious personal injury or death.



2. Press the button in the top of the tailgate handle.

## OPENING THE TAILGATE

### OPENING THE TAILGATE FROM INSIDE YOUR VEHICLE

The vehicle must be in park (P) to operate the power tailgate.



Press the button on the instrument panel.

**Note:** A tone sounds while the tailgate opens.

### OPENING THE TAILGATE FROM OUTSIDE YOUR VEHICLE

1. Unlock the vehicle with the remote control or power door unlock control.

**Note:** If an intelligent access transmitter is within 3 ft (1 m) of the tailgate, the tailgate unlocks when you press the tailgate release button.

### OPENING THE TAILGATE USING THE REMOTE CONTROL



Press the remote control button twice within three seconds.

### REMOVING AND INSTALLING THE TAILGATE



**WARNING:** Always properly secure cargo to prevent shifting cargo or cargo falling from the vehicle. Failure to do so could result in compromised vehicle stability and serious personal injury to vehicle occupants or others.

## Tailgate - Vehicles With: Remote Release Tailgate

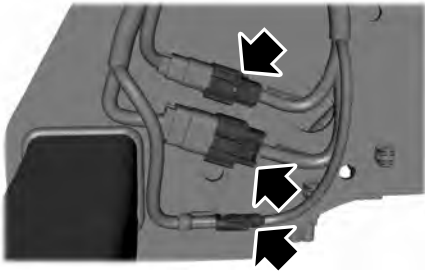

1. Obtain the tailgate removal kit from the glove box.
2. Locate and disconnect the frame connections. They are on the left-hand side of the vehicle.

**Note:** Your vehicle may have up to three frame connections.

3. Install the protective caps on the in-line connector portion that remains under the pickup box.

**Note:** If you do not install the caps on the connectors, some features may not operate as intended.

4. Partially lower the tailgate. Carefully feed the tailgate harness up through the gap between the pickup box and the bumper and place it out of the way under the pickup box.
5. Lower the tailgate.

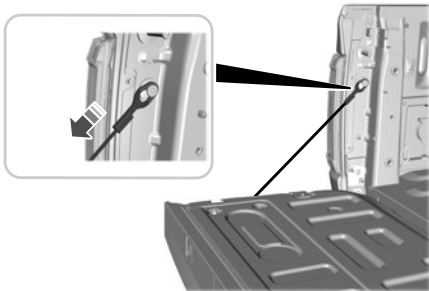

6. Use a screwdriver to gently pry the spring clip on each connector past the head of the support screw. Disconnect the cable.

7. Disconnect the other cable.

**Note:** To avoid damaging the tailgate, you may need assistance when removing. The tailgate weighs approximately 97 lb (44 kg).

8. Lift the tailgate to 45 degrees from the horizontal position.
9. Lift the right-hand side off its hinge.
10. Lift the tailgate to 80 degrees from the horizontal position.
11. Remove the tailgate from the left-hand side hinge by sliding it to the right.
12. Install the tailgate in reverse order.

### TAILGATE STEP

#### ACCESSING THE TAILGATE STEP

1. Lower the tailgate.
2. Push the button in the center of the step molding. The step pops out slightly.

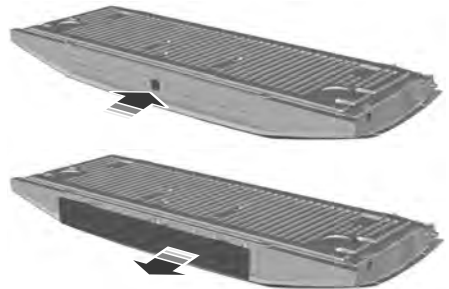

3. Pull the step out fully. Lower the step to its lowest position.

## Tailgate - Vehicles With: Remote Release Tailgate



4. Pull the yellow handle stop backward out of the tailgate until it fully extends.
5. To lock the handle in place, rotate the handle up from the horizontal to the vertical position until you hear a click.

**Note:** Do not tow with the step or grab handle.

Replace the slip resistance tape or grab handle molding if it appears as worn or damaged.

To reduce the risk of falling:

- Only operate the step when your vehicle is on a level surface.
- Only operate the step in areas with sufficient lighting.
- Make sure you use the grab handle when climbing on the step.
- Do not use the step with bare feet.
- Make sure the step is clean before use.
- Keep the step load below the total maximum load of 350 lb (159 kg).

### STOWING THE TAILGATE STEP

1. Press the yellow button on the handle to lower and then press the yellow lever at the bottom of the handle to unlock. Rotate the handle down from the vertical to the horizontal position and push it into the tailgate.

2. Rotate the step up until it is horizontal, then push it back into the tailgate until the step is secure.

**Note:** Make sure to close and fully latch the step before moving your vehicle. Do not drive with the step or grab handle open.

**Note:** The power tailgate cannot close if the step is opened. A warning message appears and a chime sounds. After stowing step the power close function is restored.

### BED EXTENDER

#### BED EXTENDER PRECAUTIONS

**Note:** Do not use the bed extender when driving off road.

**Note:** Make sure to engage the locking pins and knobs fully before driving your vehicle.

**Note:** Make sure to secure all cargo.

**Note:** Do not exceed 150 lb (68 kg) on the tailgate when your vehicle is moving.

**Note:** Do not keep the bed extender in the tailgate mode when you are not using it for restraining cargo. Always keep the bed extender in the grocery mode or the stowed position with the tailgate closed.



## Tailgate - Vehicles With: Remote Release Tailgate

### USING THE BED EXTENDER

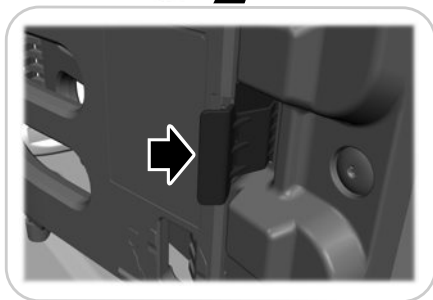
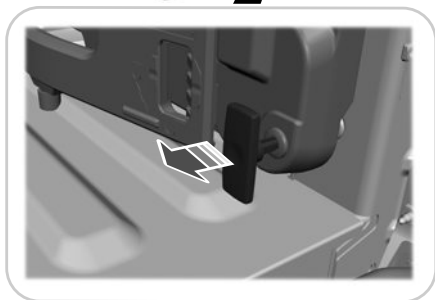
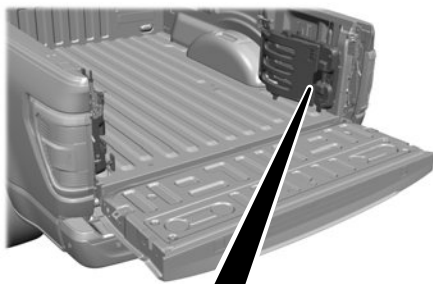
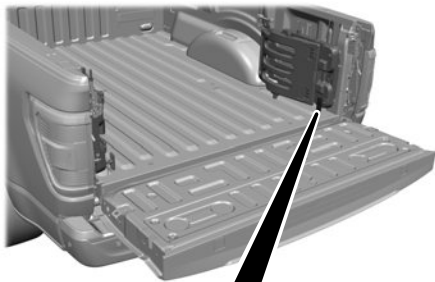

1. Pull the locking pin toward the center of your vehicle.

2. Open the latches to release the panels.



3. Rotate the panels toward the tailgate. Repeat steps 1-3 on the other side of your vehicle.

## Tailgate - Vehicles With: Remote Release Tailgate

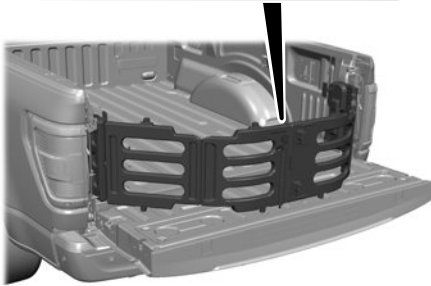
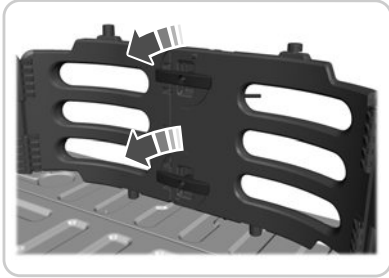

4. Connect the two panels. Rotate both knobs one-quarter turn clockwise to secure the panels.

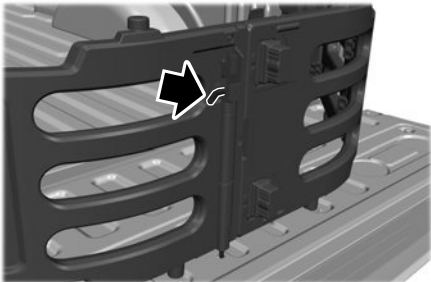

5. Insert the latch rod into the tailgate hole.
6. Engage both sides of the locking pins into their holes in the pick-up box.

### Grocery Mode

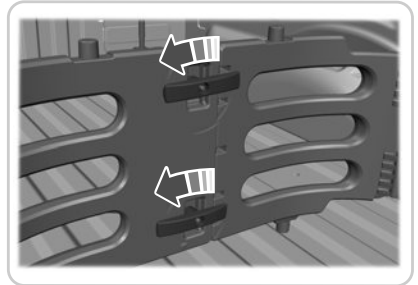
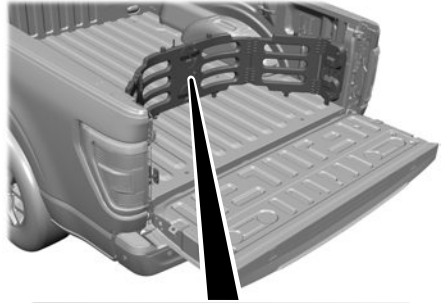

1. Follow steps 1-4.
2. Before engaging the locking pins, rotate the panels away from the tailgate.
3. Engage both sides of the locking pins into their holes in the pick-up box.
4. Close the tailgate.

# Tailgate - Vehicles With: Remote Release Tailgate

---

## TAILGATE – TROUBLESHOOTING

### TAILGATE – INFORMATION MESSAGES

Message	Action
Check Tailgate Ajar	Reminder to check the tailgate due to it recently being opened from the remote control or the button on the instrument panel while the vehicle is on and the transmission is not in Park (P).  You must clear the message using the steering wheel controls. Repeatedly closing the tailgate will not clear the message.
Power Tailgate System Fault Service Now	Reminder to check if tailgate is closed securely. If message persists contact an authorized dealer.

# Tailgate - Vehicles With: Remote Release Tailgate

---

## **TAILGATE – FREQUENTLY ASKED QUESTIONS**

### **Why won't my tailgate open?**

Make sure the transmission is in park (P), ensure nothing is obstructing the tailgate path and or causing resistance (tonneau cover or other aftermarket accessories, freezing conditions or being parked downhill). If you have continued issues, the battery voltage may be low or other system issues. See an authorized dealer.

# Security (If Equipped)

---

## PASSIVE ANTI-THEFT SYSTEM

### WHAT IS THE PASSIVE ANTI-THEFT SYSTEM

The passive anti-theft system prevents someone from starting the vehicle with an incorrectly coded key.

### HOW DOES THE PASSIVE ANTI-THEFT SYSTEM WORK

The passive anti-theft system arms when you switch the ignition off.

It disarms when the ignition is switched on with a correctly coded key.

**Note:** *The system is not compatible with non-Ford aftermarket remote start systems.*

**Note:** *Do not leave a duplicate coded key in your vehicle. Always take the keys and lock all doors when leaving your vehicle.*

## ANTI-THEFT ALARM SYSTEM

### WHAT IS THE ANTI-THEFT ALARM SYSTEM

The Anti-Theft Alarm System warns you of an unauthorized entry to your vehicle.

### HOW DOES THE ANTI-THEFT ALARM SYSTEM WORK

When armed, the anti-theft alarm is triggered in any of the following ways:

- If someone opens a door, the tailgate or the hood without a correctly coded key or remote control.
- If you turn the power on without a correctly coded key.
- If the interior sensors detect movement inside your vehicle.

- If the inclination sensors detect an attempt to raise your vehicle.
- If someone disconnects the vehicle battery or the battery backup alarm.
- If someone disconnects the trailer. See **Connecting a Trailer** (page 323).

Any further attempts to carry out one of the above sounds the alarm again.

If the anti-theft alarm is triggered, the alarm horn sounds for 30 seconds and the direction indicators flash for five minutes.

## WHAT IS THE PERIMETER ALARM

The perimeter alarm is designed to detect unauthorized access to your vehicle.

## WHAT ARE THE INTERIOR SENSORS

The interior sensors are designed to detect any movement inside your vehicle.

The interior sensors are in the overhead console.

**Note:** *Do not cover the interior sensors.*

## WHAT ARE THE INCLINATION SENSORS

The inclination sensor is designed to detect an attempt to raise your vehicle, for example to remove a wheel or to tow it away.

## WHAT IS THE BATTERY BACKUP ALARM

The battery backup alarm is an additional alarm system that has its own battery and horn. It is designed to detect if the vehicle battery or the battery backup alarm is disconnected.

# Security (If Equipped)

---

## ARMING THE ANTI-THEFT ALARM SYSTEM

The alarm is ready to arm when there is not a key in your vehicle.

Lock your vehicle with your remote control to arm the alarm.

## DISARMING THE ANTI-THEFT ALARM SYSTEM

Disarm the alarm by performing any of the following actions:

- Unlock the doors or luggage compartment with the remote control.
- Switch your vehicle on or start your vehicle.

## ANTI-THEFT ALARM SYSTEM SETTINGS

### WHAT ARE THE ALARM SECURITY LEVELS

You can select two levels of alarm security, all sensors and perimeter sensing.

#### All Sensors

All sensors is the standard setting.

In all sensors, all equipped sensors are on when you arm the alarm.

**Note:** Do not arm the alarm with all sensors if passengers, animals or other moving objects are inside your vehicle.

#### Perimeter Sensing

In perimeter sensing, the interior sensors are off when you arm the alarm.

All the other equipped sensors activate when you arm the alarm in this mode.

## SETTING THE ALARM SECURITY LEVEL

1. Press **Settings** on the touchscreen.
2. Press **Vehicle Settings**.
3. Press **Alarm System**.
4. Press **Motion Sensors**.
5. Press a setting.

## WHAT IS ASK ON EXIT

You can choose which level of security you require after you switch the ignition off.

**Note:** If you do not choose a setting, the system defaults to all sensors.

## SWITCHING ASK ON EXIT ON AND OFF

1. Press **Settings** on the touchscreen.
2. Press **Vehicle Settings**.
3. Press **Alarm System**.
4. Switch **Ask on Exit** on or off.

## Security (If Equipped)

---

### SECURITY – TROUBLESHOOTING

#### SECURITY – INFORMATION MESSAGES

<b>Message</b>	<b>Action</b>
No Key Detected	The system has not detected a correctly coded key.
Starting System Fault	The system has malfunctioned. Have your vehicle checked as soon as possible.
Vehicle Alarm To Stop Alarm, Start Vehicle.	Displays when the alarm has been triggered due to unauthorized entry.
Alarm Announcement	

## **Security (If Equipped)**

---

### **SECURITY – FREQUENTLY ASKED QUESTIONS**

#### **What should I do if there is any potential alarm problem with my vehicle?**

Take all remote controls to an authorized dealer if there is any potential alarm problem with your vehicle.

#### **What should I do if the vehicle is unable to start with a correctly coded key?**

Have your vehicle checked as soon as possible.



# Power Running Boards (If Equipped)

## POWER RUNNING BOARD PRECAUTIONS



**WARNING:** In extreme climates, excessive ice buildup may occur, causing the running boards not to deploy. Make sure that the running boards have deployed, and have finished moving before attempting to step on them. The running boards will resume normal function once the blockage is cleared.



**WARNING:** Switch off the running boards before jacking or placing any object under your vehicle. Never place your hand between the extended running board and your vehicle. A moving running board may cause injury.

Do not use the running boards, front and rear hinge assemblies, running board motors, or the running board underbody mounts to lift your vehicle when jacking. Use proper jacking points.

The running boards could move slower in cold temperatures.

## POWER RUNNING BOARD SETTINGS

1. Using the instrument cluster display controls on the steering wheel, select **Settings**.
2. Select **Advanced Settings**.
3. Select **Vehicle**.
4. Select **Power Running Boards**.
5. Select a setting.

### Power Running Board Settings

#### Off

The power running boards remain stowed, regardless of door position.

#### Auto

The power running boards deploy when you open the door and stow when you close the door.

#### Out

The power running boards remain deployed, regardless of door position.

## DEPLOYING AND STOWING THE POWER RUNNING BOARDS

The power running boards deploy when you open the door and stow when you close the door.

**Note:** *The power running boards reverse direction and move to the end of travel if they encounter an object when moving.*

## POWER RUNNING BOARDS – TROUBLESHOOTING

### POWER RUNNING BOARDS – FREQUENTLY ASKED QUESTIONS

#### Why is there unwanted noise coming from my power running boards?

The power running board mechanism could trap debris such as mud, dirt, snow, ice and salt. If this happens, set the running boards to the deployed position. Then, wash the system, in particular the front and rear hinge arms, with a high-pressure car wash wand.

# Steering Wheel

## ADJUSTING THE STEERING WHEEL - VEHICLES WITH: POWER ADJUSTABLE STEERING COLUMN



**WARNING:** Do not adjust the steering wheel when your vehicle is moving.

**Note:** Make sure that you are sitting in the correct position. See **Sitting in the Correct Position** (page 158).

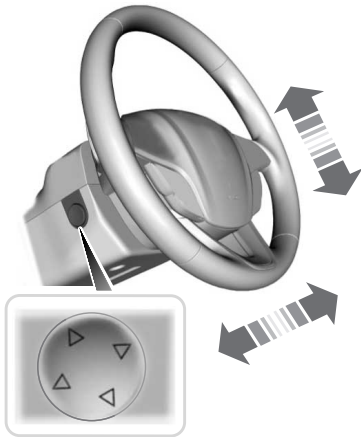

Use the control on the side of the steering column to adjust the position.

To adjust:

- Tilt: Press the top or bottom of the control.
- Telescope: Press the front or rear of the control.

## End of Travel Position

The steering column sets a stopping position just short of the end of the column position to prevent damage to the steering column. A new stopping position sets if the steering column encounters an object when tilting or telescoping.

To reset the steering column to its normal stopping position:

1. Confirm there is nothing obstructing the motion of the steering column.
2. Press and hold the steering column control until the steering column stops moving.
3. Press the steering column control again.

**Note:** The steering column may begin to move again.

4. When the steering column stops, continue holding the control for a few seconds.
5. Repeat for each direction as necessary.

A new stopping position sets. The next time you tilt or telescope the steering column, it stops just short of the end of the column position.

## Memory Feature (If Equipped)

You can save and recall the steering column position with the memory function. See **What Is the Memory Function** (page 174).

Pressing the adjustment control during a memory recall cancels the operation.

## Easy Entry and Exit Feature

The column moves up when you switch the ignition off. Switch the ignition on to return the system to its previous settings. You can switch this feature on or off in the information display. See **Instrument Cluster Display** (page 141).

# Steering Wheel

**Note:** If you press any adjustment or memory button when in easy exit mode, the system cancels the operation.

**Note:** Depending on your vehicle, the column may move up and in.

## ADJUSTING THE STEERING WHEEL - VEHICLES WITH: MANUAL ADJUSTABLE STEERING COLUMN



**WARNING:** Do not adjust the steering wheel when your vehicle is moving.

**Note:** Make sure that you are sitting in the correct position. See **Sitting in the Correct Position** (page 158).

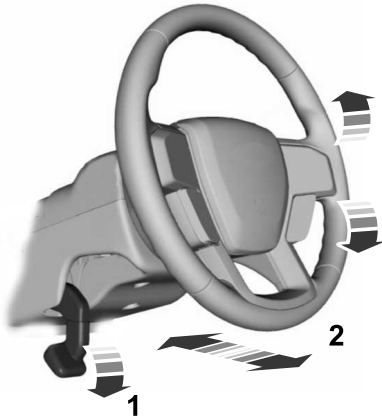

1. Unlock the steering column by pulling down on the lever.
2. Adjust the steering wheel to the preferred position. The wheel can move up or down, in or out.

3. Lock the steering column into position by pulling the lever up into the locked position.

## RESETTING THE STOPPING POSITION - VEHICLES WITH: POWER ADJUSTABLE STEERING COLUMN

**Note:** The steering wheel stops when it detects an obstruction. This sets a new stopping position.

To reset the steering column to its normal stopping position:

1. Confirm there is nothing obstructing the motion of the steering column.
2. Press and hold the steering column control until the steering column stops moving.
3. Press the steering column control again.

**Note:** The steering column may start to move again.

4. When the steering column stops, continue holding the control for a few seconds.
5. Repeat for each direction, as necessary.

## HORN



Press on the center of the steering wheel near the horn icon to activate the horn.

## SWITCHING THE HEATED STEERING WHEEL ON AND OFF

(IF EQUIPPED)



To activate the heated steering wheel, press the button on the climate control unit.

# Steering Wheel

---

On some vehicles, an indicator on the button illuminates when the heated steering wheel is on.

**Note:** *A sensor regulates the temperature of the steering wheel.*

## Adjustable Pedals (If Equipped)

### ADJUSTING THE PEDALS



**WARNING:** Do not use the pedal adjustment controls when the vehicle is moving. Failure to follow this instruction could result in personal injury or death.

Your control is on the left-hand side of the steering column or on the instrument panel.

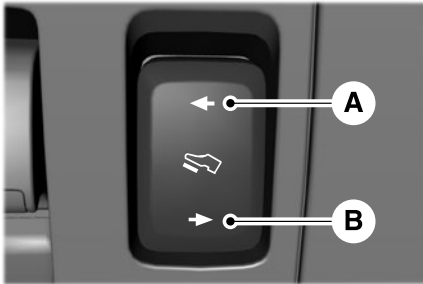

- A. Farther away from you.
- B. Closer to you.

You can save and recall the pedal positions with the memory feature. See **Memory Function** (page 174).

# Wipers and Washers

## WIPERS

### WIPER PRECAUTIONS

Do not operate the wipers on a dry windshield. This could scratch the glass or damage the wiper blades. Use the windshield washers before wiping a dry windshield.

Fully defrost the windshield before you switch the windshield wipers on.

Switch the windshield wipers off before entering a car wash.

### SWITCHING WINDSHIELD WIPERS ON AND OFF

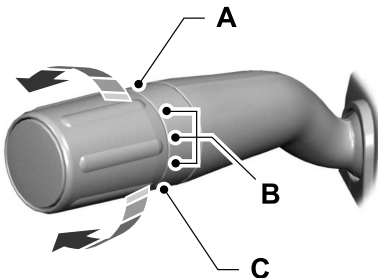

- A High-speed wipe.
- B Intermittent wipe.
- C Off.



Use the rotary control.

## AUTOWIPERS (IF EQUIPPED)

### WHAT ARE AUTOWIPERS

Autowipers turns on and controls the speed and frequency of the windshield wipers.

### AUTOWIPERS SETTINGS

1. Using the instrument cluster controls on the steering wheel, select **Settings**.
2. Select **Vehicle**.
3. Select **Wipers**.
4. Switch **Rain Sensing** on or off.

**Note:** When you switch the feature off, the wipers do not operate based on the rain sensor. When you switch on the windshield wipers to the intermittent wipe position with the feature off, the wipers use the wipe speed set by the rotary control.

### ADJUSTING THE SENSITIVITY OF THE RAIN SENSOR

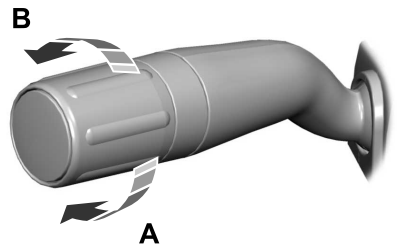

- A Low sensitivity.
- B High sensitivity.

Use the rotary control to set the sensitivity of the rain sensor.

# Wipers and Washers

When you select low sensitivity, the wipers operate when the sensor detects a large amount of water on the windshield.

When you select high sensitivity, the wipers operate when the sensor detects a small amount of water on the windshield.

## CHECKING THE WIPER BLADES



Run the tip of your fingers over the edge of the blade to check for roughness.

## REPLACING THE FRONT WIPER BLADES

Make sure your vehicle is off before beginning this procedure.



1. Pull the wiper blade and arm away from the glass.

**Note:** Do not hold the wiper blade to lift the wiper arm.

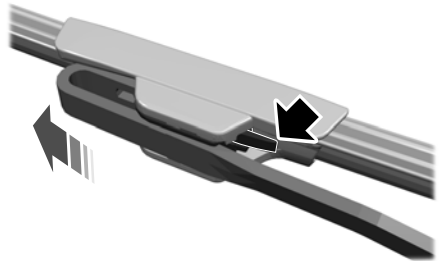

2. Press the wiper blade locking clip.
3. Remove the wiper blade.

**Note:** Make sure that the wiper arm does not spring back against the glass when the wiper blade is not attached.

4. To install, reverse the removal procedure.

**Note:** Make sure that the wiper blade locks into place.

## WASHERS

### WASHER PRECAUTIONS



**WARNING:** If you operate your vehicle in temperatures below 41°F (5°C), use washer fluid with antifreeze protection. Failure to use washer fluid with antifreeze protection in cold weather could result in impaired windshield vision and increase the risk of injury or accident.

Do not operate the washers when the washer reservoir is empty. This could cause the washer pump to overheat.

# Wipers and Washers

Keep the outside of the windshield clean. The rain sensor is very sensitive and the wipers may operate if dirt, mist or insects hit the windshield.

## USING THE WINDSHIELD WASHER

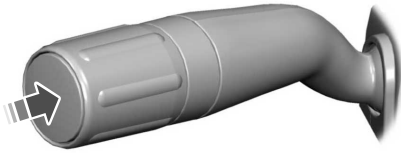

Press and hold the button at the end of the lever to operate the windshield washer.

**Note:** A *courtesy wipe* occurs a short time after the wipers stop to clear any remaining washer fluid when switched on. See **Switching the Courtesy Wipe On and Off** (page 117).

## SWITCHING THE COURTESY WIPE ON AND OFF

1. Using the instrument cluster controls on the steering wheel, select **Settings**.
2. Select **Vehicle**.
3. Select **Wipers**.
4. Switch **Courtesy Wipe** on or off.

## ADDING WASHER FLUID

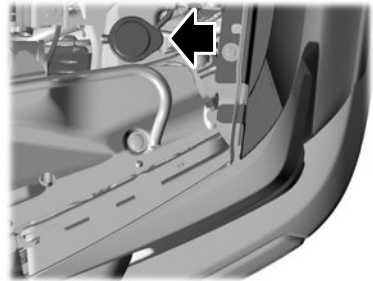

## WASHER FLUID SPECIFICATION

See **Washer Fluid Specification** (page 117).

## WIPERS AND WASHERS – TROUBLESHOOTING

### WIPERS AND WASHERS – WARNING LAMPS



Illuminates when the windshield washer fluid is low.

### WIPERS AND WASHERS – FREQUENTLY ASKED QUESTIONS

#### Why are there streaks and smears on the windshield?

The wiper blades could be dirty, worn or damaged. Check the wiper blades. See **Checking the Wiper Blades** (page 116). If the wiper blades are dirty, clean them with washer fluid or water applied with a soft sponge or cloth. If the wiper blades are worn or damaged, install new ones. See **Replacing the Front Wiper Blades** (page 116).



# Exterior Lighting

## EXTERIOR LIGHTING CONTROL

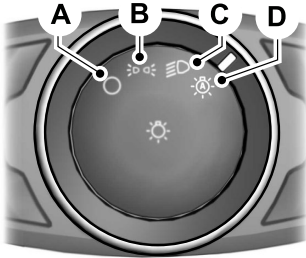



- A Lamps off.
- B Parking lamps on.
- C Headlamps on.
- D Autolamps on.

Rotate the control to make a selection.

## HEADLAMPS

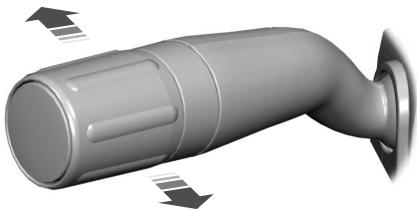
### USING THE HIGH BEAM HEADLAMPS



 Push the lever away from you to switch the high beam on.

Push the lever forward again or pull the lever toward you to switch the high beams off.

Slightly pull the lever toward you and release it to flash the headlamps.

## HEADLAMP INDICATORS

### Lamps On



Illuminates when you switch the low beam headlamps or the parking lamps on.

### Headlamp High Beam



Illuminates when you switch the high beam headlamps on.

## HEADLAMPS – TROUBLESHOOTING

### HEADLAMPS – FREQUENTLY ASKED QUESTIONS

#### Why is there condensation in the headlamps?

Headlamps have vents to accommodate normal changes in air pressure. Condensation can be a natural by-product of this design. When moist air enters the lamp assembly through the vents, there is a possibility that condensation can occur when the temperature is cold. When normal condensation occurs, a fine mist can form on the interior of the lens. The fine mist eventually clears and exits through the vents during normal operation.

#### How much condensation is acceptable?

The presence of a fine mist, for example no streaks, drip marks or large droplets. A fine mist covers less than 50% of the lens.

# Exterior Lighting

## How long may it take for the acceptable condensation to be cleared?

Clearing time may take as long as 48 hours under dry weather conditions.

## How much condensation is unacceptable?

A water puddle inside the lamp. Streaks, drip marks or large droplets present on the interior of the lens.

## What should I do if unacceptable condensation is present?

Have your vehicle checked as soon as possible.

## Why do my headlamps turn off when I have them switched on when I switch my vehicle off?

The battery saver turns the headlamps off after a short period of time after you switch your vehicle off.

## AUTOLAMPS

### WHAT ARE AUTOLAMPS



**WARNING:** The system does not relieve you of your responsibility to drive with due care and attention. You may need to override the system if it does not turn the headlamps on in low visibility conditions, for example daytime fog.

Autolamps turn the headlamps on in low light situations or when the windshield wipers operate.

### AUTOLAMP SETTINGS

1. Using the instrument cluster controls on the steering wheel, select **Settings**.
2. Select **Vehicle**.

3. Select **Lighting**.
4. Select **Autolamp Delay**.
5. Select a setting and press the **OK** button.

## EXTERIOR LAMPS

### SWITCHING THE TURN SIGNAL LAMPS ON AND OFF

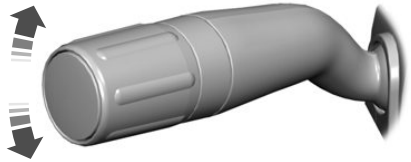

Push the lever up or down to switch the turn signal lamps on.

Set the lever to the middle position to switch the turn signal lamps off.

**Note:** Tap the lever up or down to make the turn signal lamps flash three times.

# Exterior Lighting

## SWITCHING THE DAYTIME RUNNING LAMPS ON AND OFF - VEHICLES WITH: CONFIGURABLE DAYTIME RUNNING LAMPS



**WARNING:** The daytime running lamps system does not activate the rear lamps and may not provide adequate lighting during low visibility driving conditions. Make sure you switch the headlamps on, as appropriate, during all low visibility conditions. Failure to do so may result in a crash.

1. Using the instrument cluster controls on the steering wheel, select **Settings**.
2. Select **Vehicle**.
3. Select **Lighting**.
4. Switch **Daytime Running Lights** on or off.

The daytime running lamps turn on when all of the following occur:

- You switch the system on.
- You switch your vehicle on.
- The transmission is not in park (P) for vehicles with automatic transmissions or you release the parking brake for vehicles with manual transmissions.
- The lighting control is in the autolamps position.
- The headlamps are off.

**Note:** Other lighting control positions do not turn on the daytime running lamps.

## SWITCHING THE DAYTIME RUNNING LAMPS ON AND OFF - VEHICLES WITH: DAYTIME RUNNING LAMPS (DRL)



**WARNING:** The daytime running lamps system does not activate the rear lamps and may not provide adequate lighting during low visibility driving conditions. Make sure you switch the headlamps on, as appropriate, during all low visibility conditions. Failure to do so may result in a crash.

Daytime running lamps are always on unless you switch on the headlamps or your vehicle is in park (P).

## SWITCHING THE FRONT FOG LAMPS ON AND OFF (If Equipped)

The front fog lamp button is on the lighting control.



Press the button to switch the front fog lamps on or off.

**Note:** Only switch the front fog lamps on during reduced visibility.

**Note:** The brightness of the daytime running lamps may decrease when the front fog lamps are switched on.

**Note:** When the lighting control is in the autolamps position, you cannot switch the fog lamps on unless the headlamps are on.

## SWITCHING THE CARGO LAMPS ON (If Equipped)



Press the button in the lighting control or in the rear cargo box.

# Exterior Lighting

## SWITCHING THE SPOT LAMPSON AND OFF (If Equipped)

The spot lamp buttons are near the lighting control.



Press the button to switch on the left-hand spot lamp.



Press the button to switch on the right-hand spot lamp.

Move the position of the exterior mirrors to adjust the aim.

**Note:** *The lighting control must be set to the parking lamp position.*

**Note:** *The spot lamps illuminate the area in front of and to the side of your vehicle.*

## EXTERIOR LAMP INDICATORS

### Front Fog Lamp



It illuminates when you switch the front fog lamps on.

### Turn Signal Lamp



It flashes when you switch the turn signal lamps on.

**Note:** *An increase in the rate of flashing warns of a failed turn signal lamp.*

## EXTERIOR LAMP AUDIBLE WARNING

### Exterior Lamps On

Sounds when you open the driver door and the exterior lamps are on.

## AUTOMATIC HIGH BEAM CONTROL (IF EQUIPPED)

### HOW DOES AUTOMATIC HIGH BEAM CONTROL WORK

Automatic high beam control turns the high beams on if it is dark enough and no other traffic is present. If it detects an approaching vehicle's headlamps or tail lamps, or street lighting ahead, the system turns the high beams off.

A camera sensor, centrally mounted behind the windshield of your vehicle, continuously monitors conditions to turn the high beams on and off.

# Exterior Lighting

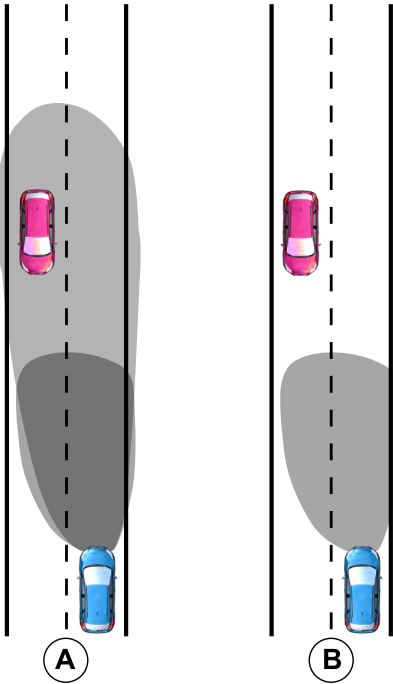

- A Without automatic high beam control.
- B With automatic high beam control.

## AUTOMATIC HIGH BEAM CONTROL PRECAUTIONS

**WARNING:** The system does not relieve you of your responsibility to drive with due care and attention. You may need to override the system if it does not turn the high beams on or off.

**WARNING:** Do not use the system in poor visibility, for example fog, heavy rain, spray or snow.

**WARNING:** You may need to override the system when approaching other road users.

**WARNING:** You may need to override the system during inclement weather.

## AUTOMATIC HIGH BEAM CONTROL REQUIREMENTS

The system turns the high beams on if all of the following occur:

- You switch the system on.
- You set the lighting control to the autolamps position.
- The ambient light level is low enough that you require high beams.
- There is no traffic in front of your vehicle.
- The vehicle speed is greater than approximately 32 mph (52 km/h).

## AUTOMATIC HIGH BEAM CONTROL LIMITATIONS

The system turns the high beams off if any of the following occur:

- You switch the system off.
- You set the lighting control to any position except autolamps.
- The ambient light level is high enough that you do not require high beams.
- The system detects an approaching vehicle's headlamps or rear lamps.
- The system detects severe rain, snow or fog.
- The system detects street lighting.

# Exterior Lighting

- The camera has reduced visibility.
- The vehicle speed falls below approximately 27 mph (44 km/h).

## SWITCHING AUTOMATIC HIGH BEAM CONTROL ON AND OFF

1. Using the instrument cluster controls on the steering wheel, select **Settings**.
2. Select **Vehicle**.
3. Select **Lighting**.
4. Switch **Auto High Beam** on or off.

## AUTOMATIC HIGH BEAM CONTROL INDICATORS



Illuminates to confirm when the system is ready to assist.

## OVERRIDING AUTOMATIC HIGH BEAM CONTROL

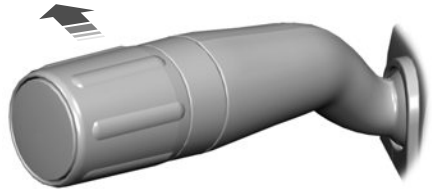

Push the lever away from you to switch the high beams on.

Push the lever away from you again to switch the high beams off.

Push the lever away from you for a third time to switch automatic high beam control back on.

## AUTOMATIC HIGH BEAM CONTROL – TROUBLESHOOTING

### AUTOMATIC HIGH BEAM CONTROL – INFORMATION MESSAGES

Message	Description
Front Camera Low Visibility Clean Screen	The camera has reduced visibility. Clean the windshield. If the message continues to appear, have your vehicle checked as soon as possible.
Front Camera Temporarily Not Available	The camera has malfunctioned. Wait a short period of time for the camera to cool down. If the message continues to appear, have your vehicle checked as soon as possible.
Front Camera Malfunction Service Required	The camera has malfunctioned. Have your vehicle checked as soon as possible.

# Interior Lighting

## SWITCHING ALL OF THE INTERIOR LAMPS ON AND OFF

The lamps turn on under the following conditions:

- You open any door.
- You press a button on the remote control.
- You press the all lamps on button on the overhead console.



Press to switch all interior lamps on or off.

## SWITCHING THE FRONT INTERIOR LAMPS ON AND OFF



The front interior lamp switches are on the overhead console.

**Note:** The position of each button on the overhead console depends on your vehicle.

### Individual Map Lamps



Press to switch the left-hand individual dome lamp on and off.



Press to switch the right-hand individual dome lamp on and off.

## SWITCHING THE REAR INTERIOR LAMPS ON AND OFF



The rear interior lamps may be above the rear seat or above the rear windows.



Press to switch the lamps on or off.

**Note:** If you switch the rear lamps on through the overhead console, you cannot switch them off with the rear lamp switch.

## INTERIOR LAMP FUNCTION

### WHAT IS THE INTERIOR LAMP FUNCTION

The interior lamp function switches the courtesy and door lamps on or off.

### SWITCHING THE INTERIOR LAMP FUNCTION ON AND OFF



Press to switch the interior lamp function on and off.

**Note:** The indicator lamp illuminates amber when the door function is off.

# Interior Lighting

---

## ADJUSTING THE INSTRUMENT PANEL LIGHTING BRIGHTNESS

The instrument lighting dimmer buttons are on the lighting control.



Repeatedly press one of the buttons to adjust the brightness.



## AMBIENT LIGHTING (IF EQUIPPED)

### SWITCHING AMBIENT LIGHTING ON AND OFF

1. Press **Settings** on the touchscreen.
2. Press **Vehicle Settings**.
3. Press **Ambient Light**.
4. Switch **Ambient Light** on or off.

### ADJUSTING AMBIENT LIGHTING

Drag the slider left or right.

## INTERIOR LIGHTING – TROUBLESHOOTING

### INTERIOR LIGHTING – FREQUENTLY ASKED QUESTIONS

#### Why do my courtesy lamps or interior lamps turn off when I have them switched on when I switch my vehicle off?

The battery saver turns the courtesy lamps and interior lamps off after a short period of time after you switch your vehicle off.



# Windows

## OPENING AND CLOSING THE WINDOWS



**WARNING:** Do not leave children unattended in your vehicle and do not let them play with the power windows. Failure to follow this instruction could result in personal injury.



**WARNING:** When closing the power windows, verify they are free of obstruction and make sure that children and pets are not in the proximity of the window openings.



Press the window control switch to open the window. Lift the window control switch to close the window.

**Note:** The power windows operate with the ignition on, and for several minutes after you switch the ignition off or until you open a front door.

To reduce wind noise or pulsing noise when one window is open, slightly open the opposite window.

### One-Touch Open

Fully press the window control switch and release it. Press again or lift it to stop the window.

### One-Touch Close

Fully lift the window control switch and release it. Press again or lift it to stop the window.

### Resetting One-Touch Close

Carry out all steps within 30 seconds of starting the sequence.

1. Close the window.

2. Press and hold the window control switch until the window is fully open. Keep the window control switch pressed for a few seconds.
3. Lift and hold the window control switch until the window is fully closed. Keep the window control switch held for a few seconds.
4. Press and hold the window control switch until the window is fully open. Keep the window control switch pressed for a few seconds.
5. Lift and hold the window control switch until the window is fully closed. Keep the window control switch held for a few seconds.

**Note:** Repeat the procedure if the window does not close when you use one-touch.

## WINDOW BOUNCE-BACK

### WHAT IS WINDOW BOUNCE-BACK

The window stops and reverses if it detects an obstruction when closing.

### OVERRIDING WINDOW BOUNCE-BACK



**WARNING:** If you override bounce-back, the window does not reverse if it detects an obstacle. Take care when closing the windows to avoid personal injury or damage to your vehicle.

1. Close the window until it reaches the point of resistance and let it reverse.
2. Lift and hold the window control switch within two seconds to override bounce-back and close the window. Bounce-back is now disabled and you can close the window manually.

# Windows

**Note:** The window goes past the point of resistance and you can fully close it.

**Note:** If the window does not close, have your vehicle checked as soon as possible.

Press and hold the window control switch to open the window. Pull and hold the window control switch to close the window.

## LOCKING THE REAR WINDOW CONTROLS



Press the window control switch to lock or unlock the rear window controls. It illuminates when you lock the rear window controls.

## OPENING AND CLOSING THE SLIDING WINDOWS (IF EQUIPPED)



**WARNING:** When closing the power windows, verify they are free of obstruction and make sure that children and pets are not in the proximity of the window openings.



**WARNING:** Do not leave children unattended in your vehicle and do not let them play with the power windows. Failure to follow this instruction could result in personal injury.

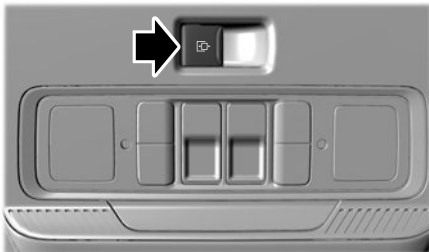

The window control switch is on the overhead console.

# Interior Mirror

---

## INTERIOR MIRROR PRECAUTIONS



**WARNING:** Do not adjust the mirrors when your vehicle is moving. This could result in the loss of control of your vehicle, serious personal injury or death.

**Note:** Do not clean the mirror housing or glass with harsh abrasives, fuel or other petroleum-based cleaning products.

## MANUALLY DIMMING THE INTERIOR MIRROR

Pull the tab below the mirror toward you to reduce glare at night.

## AUTO-DIMMING INTERIOR MIRROR (IF EQUIPPED)

### WHAT IS THE AUTO-DIMMING INTERIOR MIRROR

The mirror dims to reduce the effect of bright light from behind. It returns to normal when the bright light from behind is no longer present or if you shift into reverse (R).

### AUTO-DIMMING INTERIOR MIRROR LIMITATIONS

Do not block the sensors on the front and back of the mirror.

**Note:** A rear center passenger or raised rear center head restraint could prevent light from reaching the sensor.

# Exterior Mirrors

## ADJUSTING THE EXTERIOR MIRRORS



**WARNING:** Do not adjust the mirrors when your vehicle is moving. This could result in the loss of control of your vehicle, serious personal injury or death.

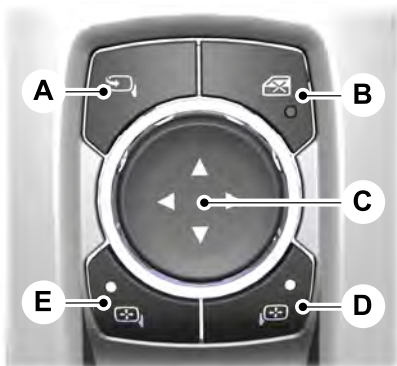

- A Power fold.
- B Window lock.
- C Adjustment control.
- D Right-hand mirror.
- E Left-hand mirror.

To adjust the mirrors, switch your vehicle on, with the ignition in accessory mode or the engine running:

1. Select the mirror you want to adjust. The control light turns on.
2. Use the adjustment control to adjust the position of the mirror.
3. Press the mirror control again. The control light turns off.

## FOLDING THE EXTERIOR MIRRORS - VEHICLES WITH: MANUAL FOLDING MIRRORS

Push the mirror toward the door window glass.

Make sure that you fully engage the mirror in its support when returning it to its original position.

## FOLDING THE EXTERIOR MIRRORS - VEHICLES WITH: POWER FOLDING MIRRORS

The exterior mirrors fold when you lock your vehicle and unfold when you unlock your vehicle.



For tight parking conditions, press the control to fold the mirrors.

Press the control switch again to unfold the mirrors.

**Note:** Do not stop the mirrors midway through their movement. Wait until the mirrors stop moving and press the control again.

The left-hand and right-hand mirrors move at different rates. For example, one mirror may stop while the other one continues to move. This is normal.

If you press the control switch to fold in the mirrors with auto-fold on, the mirrors do not unfold when you unlock your vehicle.

**Note:** The power folding mirrors operate with the ignition on, and for several minutes after you switch the ignition off.

**Note:** If you fold and unfold the mirrors several times within one minute, the power fold function may turn off to protect the motors from overheating.

# Exterior Mirrors

## Switching Auto-fold On and Off

1. Press **Settings** on the touchscreen.
2. Press **Vehicle Settings**.
3. Press **Mirrors**.
4. Switch **Autofold** on or off.

## Loose Mirror

If you manually fold your power-folding mirrors, they may not work properly even after you re-position them. You need to reset them if:

- The mirrors vibrate when you drive.
- The mirrors feel loose.
- The mirrors do not stay in the folded or unfolded position.
- One of the mirrors is not in its normal driving position.

To reset the mirrors, perform the following steps:

1. By hand, fold or retract both mirrors.
2. Using the power folding/power telescoping mirror control switch, operate the mirrors until you hear an audible click.
3. Operate the power folding or power telescoping mirrors an additional 3 to 4 times to synchronize the mirrors.

## EXTENDING THE EXTERIOR MIRRORS

This optional feature lets you extend the mirror about 3 in (75 mm). It is useful when towing a trailer. You can manually pull out or push in the mirrors to various positions.

### Power Telescoping Mirrors (if Equipped)

This feature lets you position both mirrors at the same time.

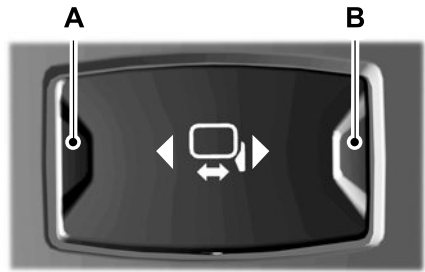

- A. Extend.
- B. Retract.

To adjust your mirrors, make sure you switch your vehicle on, with the ignition in accessory mode or the engine running.

1. Press and release the control switch.
2. Press the adjustment control to position the mirrors.
3. Press the left arrow to extend the mirrors out. Press the right arrow to retract the mirrors in.

**Note:** Moving the mirrors 10 or more times within one minute, or repeated folding and unfolding of the mirrors when holding the control down during full travel, could disable the system to protect the motors from overheating. Wait approximately three minutes with the vehicle running, and up to 10 minutes with the vehicle off, for the system to reset and for function to return to normal.

## AUTO-DIMMING EXTERIOR MIRROR

### WHAT IS THE AUTO-DIMMING EXTERIOR MIRROR

The driver exterior mirror dims when the interior auto-dimming mirror turns on.

# Moonroof (If Equipped)

## OPENING AND CLOSING THE SUN SHADE



**WARNING:** Do not leave children unattended in your vehicle and do not let them play with the sun shades. Failure to follow this instruction could result in personal injury.

The controls are on the overhead console.

### Opening the Sun Shade



Press and release the switch to activate the one-touch open feature. To stop movement, press the switch a second time. The sun shade also opens when you open the moonroof.

**Note:** *The sun shade stops short of its fully opened position for the comfort of rear passengers. To fully open the sun shade, press the switch again.*

### Closing the Sun Shade



Press and release the switch to activate the one-touch close feature. To stop movement, press the switch a second time.

## OPENING AND CLOSING THE MOONROOF



**WARNING:** Do not leave children unattended in your vehicle and do not let them play with the moonroof. Failure to follow this instruction could result in personal injury.



**WARNING:** When closing the moonroof, verify that it is free of obstruction and make sure that children and pets are not in the proximity of the roof opening.

The controls are on the overhead console.

### Opening the Moonroof



Press and release the switch to activate the one-touch open feature. To stop movement, press the switch a second time.

**Note:** *The moonroof stops short of the fully opened position to reduce wind noise or rumbling that may happen with the moonroof fully open.*

*Press and release the switch again to fully open the moonroof.*

### Closing the Moonroof



Press and release the switch to activate the one-touch close feature, from either the open or vent positions. To stop movement, press the switch a second time.

## VENTING THE MOONROOF



**WARNING:** Do not leave children unattended in your vehicle and do not let them play with the moonroof. Failure to follow this instruction could result in personal injury.

The moonroof controls are on the overhead console.

## **Moonroof (If Equipped)**

---



With the moonroof in the closed position, press and release the switch to vent the moonroof. To close the moonroof from the vent position, press and release the switch again.

### **MOONROOF BOUNCE-BACK**

#### **WHAT IS MOONROOF BOUNCE-BACK**

The moonroof stops and reverses some distance if it detects an obstacle when closing.

#### **OVERRIDING MOONROOF BOUNCE-BACK**

Press and hold the close button within two seconds after the moonroof comes to a stop.

## Instrument Cluster

### INSTRUMENT CLUSTER OVERVIEW - VEHICLES WITH: 2.3 INCH SCREEN

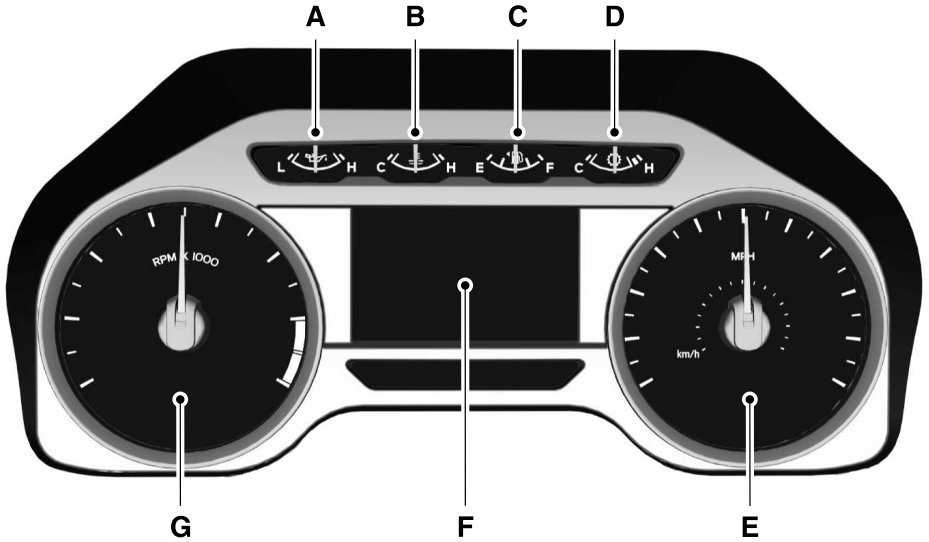

- A Engine oil pressure gauge.
- B Engine coolant temperature gauge.
- C Fuel gauge.
- D Transmission fluid temperature gauge.
- E Speedometer.
- F Instrument cluster display.
- G Tachometer.



# Instrument Cluster

## INSTRUMENT CLUSTER OVERVIEW - VEHICLES WITH: 4.2 INCH SCREEN

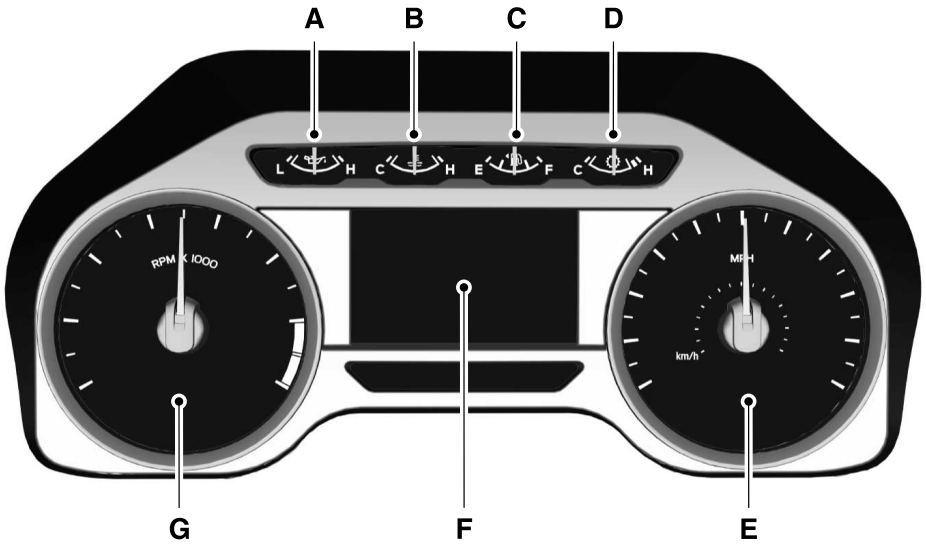

- A Engine oil pressure gauge.
- B Engine coolant temperature gauge.
- C Fuel gauge.
- D Transmission fluid temperature gauge.
- E Speedometer.
- F Instrument cluster display.
- G Tachometer.

# Instrument Cluster

## INSTRUMENT CLUSTER OVERVIEW - VEHICLES WITH: 8 INCH SCREEN

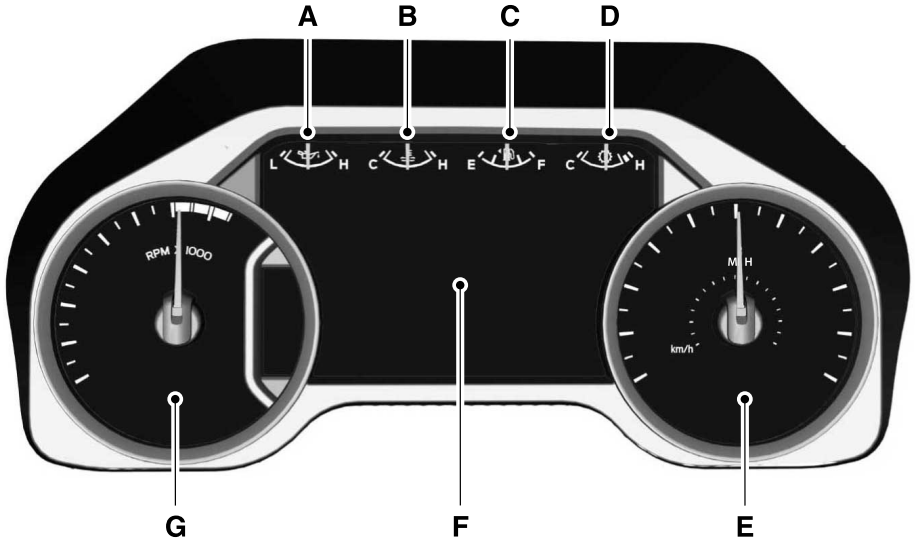

- A Engine oil pressure gauge.
- B Engine coolant temperature gauge.
- C Fuel gauge.
- D Configurable. Transmission fluid temperature gauge, turbo boost or DEF gauge.
- E Speedometer.
- F Instrument cluster display.
- G Tachometer.

### WHAT IS THE TACHOMETER

Indicates the engine speed.

### WHAT IS THE SPEEDOMETER

Indicates the vehicle speed.

# Instrument Cluster

---

## FUEL GAUGE

### WHAT IS THE FUEL GAUGE

Indicates approximately how much fuel is in the fuel tank.

### FUEL GAUGE LIMITATIONS

The fuel gauge may not provide an accurate reading when your vehicle is on an incline.

### LOCATING THE FUEL FILLER DOOR

The arrow adjacent to the fuel pump symbol indicates on which side of your vehicle the fuel filler door is located.

### WHAT IS THE LOW FUEL REMINDER

A low fuel level reminder displays and sounds when the distance to empty reaches 75 mi (120 km) to empty for MyKey, and at 50 mi (80 km), 25 mi (40 km), 12 mi (20 km) and 0 mi (0 km) for all vehicle keys.

**Note:** *The low fuel reminder can appear at different fuel gauge positions depending on fuel economy conditions. This variation is normal.*

### WHAT IS DISTANCE TO EMPTY

Indicates the approximate distance your vehicle can travel on the fuel remaining in the tank. Changes in driving pattern can cause the value to not only decrease but also increase or stay constant for periods of time.

## WHAT IS THE ENGINE COOLANT TEMPERATURE GAUGE

Indicates the engine coolant temperature.

### WHAT IS THE ENGINE OIL PRESSURE GAUGE

Indicates the engine oil pressure.

**Note:** *This is a configurable gauge.*

### WHAT IS THE TRANSMISSION FLUID TEMPERATURE GAUGE

Indicates the transmission fluid temperature.

Special operating conditions can cause higher than normal operating temperatures. See **Special Operating Conditions Scheduled Maintenance** (page 636).

**Note:** *This is a configurable gauge.*

### WHAT IS THE TURBO BOOST GAUGE

Indicates the amount of manifold air pressure in the engine.

**Note:** *This is a configurable gauge.*

### WHAT IS THE DIESEL EXHAUST FLUID GAUGE

Indicates the current diesel exhaust fluid level.

# Instrument Cluster

## WHAT ARE THE INSTRUMENT CLUSTER WARNING LAMPS

Warning lamps alert you to a vehicle condition that could become serious. Some lamps illuminate when you start your vehicle to make sure they work. If any lamps remain on after starting your vehicle, refer to the respective system warning lamp for further information.

## INSTRUMENT CLUSTER WARNING LAMPS

Depending on your vehicle options, some warning lamps can appear different or not at all.

### Adaptive Steering



It illuminates when the adaptive steering system detects a concern. Have the system checked as soon as possible.

### Anti-Lock Brake System



If it illuminates when you are driving, this indicates a malfunction. Your vehicle continues to have normal braking without the anti-lock brake system function. Have your vehicle checked as soon as possible.

### Battery



It illuminates when you switch the ignition on.

If it illuminates when the engine is running, this indicates your vehicle requires service. Have your vehicle checked as soon as possible.

### Brake System



It illuminates when you apply the parking brake and the ignition is on. If it illuminates when your vehicle is moving, make sure the parking brake is released. If the parking brake is released, this indicates low brake fluid level or the brake system requires service. Have your vehicle checked as soon as possible.

**Note:** Indicators may vary depending on region.

### Check Fuel Cap



It illuminates when the fuel cap is not properly installed. Continued driving with this light on may cause the malfunction indicator lamp to illuminate.

### Diesel Exhaust Fluid



It illuminates when the diesel exhaust fluid is low, contaminated or the system requires service. See **Selective Catalytic Reduction System** (page 217).

### Door Ajar



It illuminates when you switch the ignition on and remains on if any door is open.

### Electric Parking Brake



It illuminates or flashes when the electric parking brake requires service.

# Instrument Cluster

## Engine Coolant Temperature



If it illuminates, safely stop your vehicle and switch the vehicle off.

## Fasten Seatbelt



It illuminates and a tone sounds until you fasten the seatbelts.

## Hood Ajar



It illuminates when the ignition is on and the hood is not completely closed.

## Low Fuel Level



It illuminates when the fuel level is low.

## Low Tire Pressure



It illuminates when your tire pressure is low. If illuminated, check your tire pressure as soon as possible. If it begins to flash at anytime, have the system checked as soon as possible.

## Low Washer Fluid Level



It illuminates when the washer fluid is low.

## Malfunction Indicator Lamp



It illuminates when the ignition is on and the engine is off, this is normal. If it illuminates when the engine is on this indicates the emission control system requires service. If it flashes, have your vehicle checked immediately. See **Customer Information** (page 640). See **Starting and Stopping the Engine – Warning Lamps** (page 198).

## Oil Pressure



It illuminates when the engine oil pressure is low.

## Powertrain Malfunction, Reduced Power, Electronic Throttle Control, Check 4X4



It illuminates when the powertrain or four-wheel drive require service. Have the system checked as soon as possible.

## Tailgate Ajar



It illuminates when the ignition is on and the tailgate is not completely closed.

## Water in Fuel



It illuminates when the fuel and water separator has a significant quantity of water in it and requires immediate draining.

## WHAT ARE THE INSTRUMENT CLUSTER INDICATORS

Indicators notify you of various features that are active on your vehicle.

## INSTRUMENT CLUSTER INDICATORS

Depending on your vehicle options, some warning lamps can appear different or not at all.

## Adaptive Cruise Control



See **Adaptive Cruise Control** (page 272).

# Instrument Cluster

## Automatic High Beam



See **Automatic High Beam Control Indicators** (page 123).

## Automatic Regen Control Off



See **Diesel Particulate Filter** (page 212).

## Blind Spot Monitor



See **Blind Spot Information System** (page 293).

## Cruise Control



See **Adaptive Cruise Control** (page 272).

## Diesel Engine Brake



See **Brakes** (page 240).



## Electronic Locking Differential



See **Electronic Locking Differential** (page 237).

## Four-Wheel Drive



See **Four-Wheel Drive** (page 228).



**Note:** Some indicators appear different depending on vehicle options.

## Front Airbag



See **Airbags** (page 57).

## Front Fog Lamp



See **Switching the Front Fog Lamps On and Off** (page 120).

## High Beam



See **Using the High Beam Headlamps** (page 118).

## Hill Descent



See **Hill Descent Control** (page 254).

## Parking Lamps



See **Exterior Lighting Control** (page 118).

## Stability Control and Traction Control



See **Traction Control** (page 247). See **Stability Control** (page 249).



## Turn Signal Lamps



See **Switching the Turn Signal Lamps On and Off** (page 119).

# Instrument Cluster

---

## Tow Haul



See **Towing a Trailer** (page 328).

## Wait to Start



See **Starting a Diesel Engine** (page 193).

# Instrument Cluster Display

## USING THE INSTRUMENT CLUSTER DISPLAY CONTROLS



**WARNING:** Driving while distracted can result in loss of vehicle control, crash and injury. We strongly recommend that you use extreme caution when using any device that may take your focus off the road. Your primary responsibility is the safe operation of your vehicle. We recommend against the use of any hand-held device while driving and encourage the use of voice-operated systems when possible. Make sure you are aware of all applicable local laws that may affect the use of electronic devices while driving.

The controls are on the steering wheel.



- Press the up and down arrow buttons to scroll through and highlight the options within a menu.
- Press the right arrow button to enter a sub-menu.
- Press the left arrow to exit a menu.
- Press the **OK** button to choose and confirm settings or messages.



This icon shows the features on or off status. A check in the box indicates the feature is on, and unchecked indicates the feature is off.

## INSTRUMENT CLUSTER DISPLAY MAIN MENU - VEHICLES WITH: 2.3 INCH SCREEN

Depending on your vehicle options, some menu items can appear different or not at all.

**Note:** For your safety, some features are speed-dependent and could be unavailable when your vehicle is above a certain speed.

Main Menu
Trip 1
Trip 2
Fuel Economy
Seatbelts
Driver Assist
Settings

## INSTRUMENT CLUSTER DISPLAY MAIN MENU - VEHICLES WITH: 4.2 INCH SCREEN

Depending on your vehicle options, some menu items can appear different or not at all.

**Note:** For your safety, some features are speed-dependent and could be unavailable when your vehicle is above a certain speed.



# Instrument Cluster Display

Main Menu
Display Mode
Trip/Fuel
Towing
Off-Road
Settings

## INSTRUMENT CLUSTER DISPLAY MAIN MENU - VEHICLES WITH: 8 INCH SCREEN

Depending on your vehicle options, some menu items can appear different or not at all.

**Note:** For your safety, some features are speed-dependent and could be unavailable when your vehicle is above a certain speed.

Main Menu
MyView
Trip/Fuel
Truck Info
Towing
Off-Road
Settings

## CUSTOMIZING THE INSTRUMENT CLUSTER DISPLAY - VEHICLES WITH: 8 INCH SCREEN

1. Select **Settings** using the instrument cluster display controls.

2. Select **Gauge Selection**.
3. Select to swap or change left-hand side and right-hand side gauges.

## PERSONALIZED SETTINGS

### CHANGING THE INSTRUMENT CLUSTER DISPLAY LANGUAGE - VEHICLES WITH: 2.3 INCH SCREEN

1. Select **Settings** using the instrument cluster display controls.
2. Select **Display Setup**.
3. Select **Language**.
4. Select a language.

### CHANGING THE INSTRUMENT CLUSTER DISPLAY LANGUAGE - VEHICLES WITH: 4.2 INCH SCREEN

1. Select **Settings** using the instrument cluster display controls.
2. Select **Advanced Settings**.
3. Select **Display Setup**.
4. Select **Language**.
5. Select a language.

### CHANGING THE INSTRUMENT CLUSTER DISPLAY LANGUAGE - VEHICLES WITH: 8 INCH SCREEN

1. Select **Settings** using the instrument cluster display controls.
2. Select **Display Setup**.
3. Select **Language**.
4. Select a language.

# Instrument Cluster Display

---

## CHANGING THE MEASURE UNIT - VEHICLES WITH: 2.3 INCH SCREEN

1. Select **Settings** using the instrument cluster display controls.
2. Select **Display Setup**.
3. Select **Displ. Settings**.
4. Select **Units**.
5. Select a measurement unit.

## CHANGING THE MEASURE UNIT - VEHICLES WITH: 4.2 INCH SCREEN

1. Select **Settings** using the instrument cluster display controls.
2. Select **Advanced Settings**.
3. Select **Display Setup**.
4. Select **Measurement Units**.
5. Select a measurement unit.

## CHANGING THE MEASURE UNIT - VEHICLES WITH: 8 INCH SCREEN

1. Select **Settings** using the instrument cluster display controls.
2. Select **Display Setup**.
3. Select **Measurement Units**.
4. Select a measurement unit.

## CHANGING THE TEMPERATURE UNIT - VEHICLES WITH: 2.3 INCH SCREEN

1. Select **Settings** using the instrument cluster display controls.
2. Select **Display Setup**.
3. Select **Temperature**.
4. Select a temperature unit.

## CHANGING THE TEMPERATURE UNIT - VEHICLES WITH: 4.2 INCH SCREEN

1. Select **Settings** using the instrument cluster display controls.
2. Select **Advanced Settings**.
3. Select **Display Setup**.
4. Select **Temperature Units**.
5. Select a temperature unit.

## CHANGING THE TEMPERATURE UNIT - VEHICLES WITH: 8 INCH SCREEN

1. Select **Settings** using the instrument cluster display controls.
2. Select **Display Setup**.
3. Select **Temperature Units**.
4. Select a temperature unit.

## CHANGING THE TIRE PRESSURE UNIT - VEHICLES WITH: 2.3 INCH SCREEN

1. Select **Settings** using the instrument cluster display controls.
2. Select **Display Setup**.
3. Select **Tire Pressure**.
4. Select a tire pressure unit.

## CHANGING THE TIRE PRESSURE UNIT - VEHICLES WITH: 4.2 INCH SCREEN

1. Select **Settings** using the instrument cluster display controls.
2. Select **Advanced Settings**.
3. Select **Display Setup**.
4. Select **Tire Pressure**.
5. Select a pressure unit.

# Instrument Cluster Display

---

## **CHANGING THE TIRE PRESSURE UNIT - VEHICLES WITH: 8 INCH SCREEN**

1. Select **Settings** using the instrument cluster display controls.
2. Select **Display Setup**.
3. Select **Tire Pressure**.
4. Select a tire pressure unit.

# Trip Computer

---

## ACCESSING THE TRIP COMPUTER - VEHICLES WITH: 2.3 INCH SCREEN

1. Use the instrument cluster display controls to navigate the home screen.
2. Select **Trip 1** or **Trip 2**.
3. Select a setting and press the **OK** button.

## ACCESSING THE TRIP COMPUTER - VEHICLES WITH: 4.2 INCH SCREEN

1. Use the instrument cluster display controls to navigate the home screen.
2. Select **Trip/Fuel**.
3. Press the **OK** button.
4. Select **Trip 1** or **Trip 2**.

## ACCESSING THE TRIP COMPUTER - VEHICLES WITH: 8 INCH SCREEN

1. Use the instrument cluster display controls to navigate the home screen.
2. Select **Trip/Fuel**.
3. Press the **OK** button.
4. Select **Trip 1** or **Trip 2**.

## RESETTING THE TRIP COMPUTER

1. Use the instrument cluster display controls to navigate the home screen.
2. Select the trip screen you want to reset.
3. Press and hold the **OK** button until the system reset confirmation appears.

## RESETTING THE INDIVIDUAL TRIP VALUES

1. Use the instrument cluster display controls to navigate the home screen.
2. Select **Trip 1** or **Trip 2**.
3. Press and hold the **OK** button until the system reset confirmation appears.

## CONFIGURING THE TRIP COMPUTER

1. Use the instrument cluster display controls to navigate the home screen.
2. Select **Trip 1** or **Trip 2**.
3. Select a setting and press the **OK** button.
4. Select values to display.

## TRIP DATA

### Trip 1 and 2

Provides trip timer, trip average fuel economy and total trip distance traveled. For hybrid vehicles, the trip also shows the distance traveled on electric power only.

**Note:** *Trip 1 and 2 are selectable screens. See [Accessing the Trip Computer](#) (page 145).*

### This Trip

Provides trip timer, trip average fuel economy, total trip distance traveled, and distance traveled on electric power only with the engine off. If the gasoline engine has not turned on during the trip then trip average fuel economy is not shown. This Trip resets each time you start your vehicle.

**Note:** *This trip is a selectable screen. See [Accessing the Trip Computer](#) (page 145).*

# Remote Start (If Equipped)

## WHAT IS REMOTE START

The system allows you to remotely start your vehicle and to adjust the interior temperature according to the settings that you chose.

## REMOTE START PRECAUTIONS



**WARNING:** Do not start the engine in a closed garage or in other enclosed areas. Exhaust fumes are toxic. Always open the garage door before you start the engine. Failure to follow this instruction could result in personal injury or death.

## REMOTE START LIMITATIONS

Remote start does not work under the following conditions:

- The alarm horn is sounding.
- The hood is open.
- The transmission is not in park (P).
- The ignition is on.
- The battery voltage is below the minimum operating voltage.

**Note:** Do not use remote start if your fuel level is low.

**Note:** You can use remote start with FordPass. See **Connecting the Vehicle to a Wi-Fi Network** (page 498).

## ENABLING REMOTE START

1. Press **Settings** on the touchscreen.
2. Press **Vehicle Settings**.
3. Press **Remote Start Setup**.
4. Switch **Remote Start** on or off.

**Note:** To remote start with FordPass, make sure that the modem is enabled. See **Connecting FordPass to the Modem** (page 502).

## REMOTELY STARTING AND STOPPING THE VEHICLE

### Remotely Starting the Vehicle



Press the button on the remote control.



Within three seconds, press the button on the remote control.

Within three seconds, press the button again.

**Note:** You can also use FordPass to start the vehicle.

**Note:** The turn signal lamps flash twice.

**Note:** The parking lamps turn on when the vehicle is running.

**Note:** The horn sounds if the system fails to start.

**Note:** All other vehicle systems remain off when you have remotely started the vehicle.

**Note:** The vehicle remains secured when you have remotely started the vehicle. A valid key must be inside your vehicle to switch the ignition on and drive your vehicle.

### Remotely Stopping the Vehicle



Within three seconds, press the button on the remote control.

Within three seconds, press the button again.

# Remote Start (If Equipped)

## EXTENDING THE REMOTE START DURATION

To extend the remote start duration during remote start, do the following:



Press the button on the remote control.



Within three seconds, press the button on the remote control.

Within three seconds, press the button again.

If the duration is set to 15 minutes, the duration extends by another 15 minutes. This provides a total of 30 minutes.

**Note:** Remote start can only be extended once.

**Note:** A maximum of two remote starts, or one remote start with an extension, are allowed. To reset the restart procedure switch the vehicle to on, then to off.

## REMOTE START REMOTE CONTROL INDICATORS

### Remote Control Feedback

An LED on the remote control provides status feedback of remote start or stop commands.

LED	Status
Solid green.	Remote start successful.
Solid red.	Remote stop successful.
Blinking red.	Request failed or status not received.
Blinking green.	Status incomplete.

## REMOTE START SETTINGS

### SWITCHING CLIMATE CONTROL AUTO MODE ON AND OFF

1. Press **Settings** on the touchscreen.
2. Press **Remote Start Setup**.
3. Press **Climate Control**.
4. Select **Vehicle**.
5. Switch **Auto** on or off.

**Note:** If you switch the auto mode on, the system attempts to heat or cool the interior to 72°F (22°C).

**Note:** When you switch the ignition on, the climate control system returns to the last used settings.

### SWITCHING CLIMATE CONTROL LAST SETTINGS ON AND OFF

1. Press **Settings** on the touchscreen.
2. Press **Vehicle Settings**.
3. Press **Remote Start Setup**.
4. Switch **Last settings** on or off.

**Note:** If you switch the last settings on, the system remembers the last used settings.

### SWITCHING THE HEATED SEAT SETTINGS ON AND OFF (If Equipped)

1. Press **Settings** on the touchscreen.
2. Press **Vehicle Settings**.
3. Press **Remote Start Setup**.
4. Press **Seats**.
5. Switch **Auto** on or off.

**Note:** If you switch the heated seat settings on, the heated seats turn on during cold weather.

## Remote Start (If Equipped)

---

### SWITCHING THE HEATED STEERING WHEEL SETTINGS ON AND OFF (If Equipped)

1. Press **Settings** on the touchscreen.
2. Press **Vehicle Settings**.
3. Press **Remote Start Setup**.
4. Press **Seats and Steering Wheel**.
5. Switch **Auto** on or off.

**Note:** *If you switch the heated steering wheel settings on, the heated steering wheel turns on during cold weather.*

### SETTING THE REMOTE START DURATION

1. Press **Settings** on the touchscreen.
2. Press **Vehicle Settings**.
3. Press **Remote Start Setup**.
4. Press **Duration**.

**Note:** *Wait a few seconds before remotely starting the vehicle after the vehicle stops running.*

# Climate Control - Vehicles With: Automatic Temperature Control

## IDENTIFYING THE CLIMATE CONTROL UNIT



Depending on your vehicle options, the controls could look different than what you see here.

## SWITCHING CLIMATE CONTROL ON AND OFF



Press the button.

## SWITCHING RECIRCULATED AIR ON AND OFF



Press the button to recirculate air currently in the passenger compartment.

**Note:** *Recirculated air may turn off automatically, or prevent you from switching on in all air flow modes except MAX A/C to reduce the risk of fogging. Recirculation may also turn on and off automatically in various air distribution control combinations to improve heating or cooling efficiency.*

## SWITCHING AIR CONDITIONING ON AND OFF



Press the button.

**Note:** *Under certain conditions, the air conditioning compressor could continue to operate after you switch air conditioning off.*

## SWITCHING DEFROST ON AND OFF



Press the button to activate the selection screen.



Press the button on the touchscreen to switch the windshield air vents on.



Make sure that the instrument panel air vents are switched off.



Make sure that the footwell air vents are switched off.

## SWITCHING MAXIMUM DEFROST ON AND OFF



Press the button.

Air flows through the windshield air vents, and the blower motor adjusts to the highest speed.

You can also use this setting to defog and clear the windshield of a thin covering of ice.

**Note:** *To prevent window fogging, you cannot select recirculated air when maximum defrost is on.*

**Note:** *The heated rear window also turns on when you select maximum defrost.*



# Climate Control - Vehicles With: Automatic Temperature Control

## SWITCHING MAXIMUM COOLING ON AND OFF

 Press the button.

**Note:** When you switch maximum cooling off, air conditioning remains on.

## SWITCHING THE HEATED REAR WINDOW ON AND OFF (IF EQUIPPED)

 Press the button to clear the rear window of thin ice and fog. The heated rear window turns off after a short period of time.

**Note:** This button also activates the heated mirrors.

**Note:** Do not use harsh chemicals, razor blades or other sharp objects to clean or remove decals from the inside of the heated rear window as this could cause damage to the heated rear window grid lines not covered by the vehicle Warranty.

## SETTING THE BLOWER MOTOR SPEED



Press up or down on the control to select the blower motor speed.

## SETTING THE TEMPERATURE

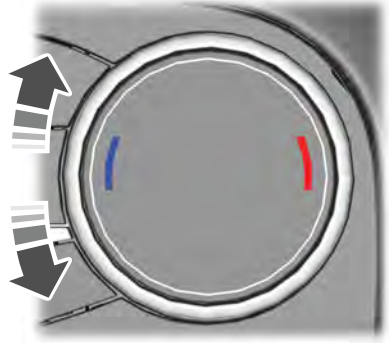

Turn the control on the left-hand side of the climate control to set the left-hand temperature.

**Note:** This control also sets the right-hand side temperature when you switch off dual zone mode.

Turn the control on the right-hand side of the climate control to set the right-hand temperature.

## DIRECTING THE FLOW OF AIR

### Directing Air to the Windshield Air Vents



Press the button to activate the selection screen.



Press the button on the touchscreen.

### Directing Air to the Instrument Panel Air Vents



Press the button to activate the selection screen.

# Climate Control - Vehicles With: Automatic Temperature Control



Press the button on the touchscreen.

## Directing Air to the Footwell Air Vents



Press the button to activate the selection screen.



Press the button on the touchscreen.

## AUTO MODE

### SWITCHING AUTO MODE ON AND OFF



Press the button to switch auto mode on. Repeatedly press the button to adjust auto mode.

**Note:** When you switch auto mode on, lights on the blower motor control do not illuminate to indicate the blower motor speed.

Adjust the blower motor control or air distribution control to switch auto mode off.

### AUTO MODE INDICATORS

The indicators are on the Auto Mode button.

Auto Mode Indicator Status	Description
One indicator illuminated.	The blower motor speed is reduced. Use this setting to minimize the amount of noise from the blower motor. This setting increases the time taken to cool the interior.
Two indicators illuminated.	The blower motor speed is moderate.
Three indicators illuminated.	The blower motor speed is increased. Use this setting to reduce the time taken to cool the interior. This setting increases the amount of noise from the blower motor.

# Climate Control - Vehicles With: Automatic Temperature Control

## SWITCHING DUAL MODE ON AND OFF



Press the button.

## CLIMATE CONTROL HINTS

### General Hints

- Prolonged use of recirculated air may cause the windows to fog up.
- You may feel a small amount of air from the footwell air vents regardless of the air distribution setting.
- To reduce humidity build-up inside your vehicle, do not drive with the system switched off or with recirculated air always switched on.
- Do not place objects under the front seats as this may interfere with the airflow to the rear seats.
- Remove any snow, ice or leaves from the air intake area at the base of the windshield.
- To improve the time to reach a comfortable temperature in hot weather, drive with the windows open until you feel cold air through the air vents.

### Automatic Climate Control

- Adjusting the settings when your vehicle interior is extremely hot or cold is not necessary. Automatic mode is best recommended to maintain set temperature.
- The system adjusts to heat or cool the interior to the temperature you select as quickly as possible.
- For the system to function efficiently, the instrument panel and side air vents should be fully open.

- If you press **AUTO** during cold outside temperatures, the system directs air flow to the windshield and side window air vents. In addition, the blower motor may run at a slower speed until the engine warms up.
- If you press **AUTO** during hot temperatures and the inside of the vehicle is hot, the system uses recirculated air to maximize interior cooling. Blower motor speed may also reduce until the air cools.

### Quickly Heating the Interior

1. Press **AUTO**.
2. Adjust the temperature function to the setting you prefer.

### Recommended Settings for Heating

1. Press **AUTO**.
2. Adjust the temperature function to the setting you prefer. Use 72°F (22°C) as a starting point, then adjust the setting as necessary.

### Quickly Cooling the Interior

Press **MAX A/C**.

### Recommended Settings for Cooling

1. Press **AUTO**.
2. Adjust the temperature function to the setting you prefer. Use 72°F (22°C) as a starting point, then adjust the setting as necessary.

### Defogging the Side Windows in Cold Weather

1. Press and release defrost or maximum defrost.

## Climate Control - Vehicles With: Automatic Temperature Control

---

2. Adjust the temperature control to the setting you prefer. Use 72°F (22°C) as a starting point, then adjust the setting as necessary.

# Climate Control - Vehicles With: Manual Temperature Control

## IDENTIFYING THE CLIMATE CONTROL UNIT



Depending on your vehicle options, the controls could look different than what you see here.

## SWITCHING CLIMATE CONTROL ON AND OFF



Press the button.

## SWITCHING RECIRCULATED AIR ON AND OFF



Press the button to recirculate air currently in the passenger compartment.

**Note:** Recirculated air may turn off automatically, or prevent you from switching on in all air flow modes except MAX A/C to reduce the risk of fogging. Recirculation may also turn on and off automatically in various air distribution control combinations to improve heating or cooling efficiency.

## SWITCHING AIR CONDITIONING ON AND OFF



Press the button.

**Note:** Under certain conditions, the air conditioning compressor could continue to operate after you switch air conditioning off.

## SWITCHING DEFROST ON AND OFF



Press the button to switch the windshield air vents on.



Make sure that the instrument panel air vents are switched off.



Make sure that the footwell air vents are switched off.

## SWITCHING MAXIMUM DEFROST ON AND OFF



Turn the temperature control clockwise past the highest setting to maximize defrosting.

**Note:** The temperature control springs back to the highest setting.

Air flows through the windshield air vents, and the blower motor adjusts to the highest speed.

**Note:** To prevent window fogging, you cannot select recirculated air when maximum defrost is on.

**Note:** The heated rear window also turns on when you select maximum defrost.

## SWITCHING MAXIMUM COOLING ON AND OFF



Turn the temperature control counterclockwise past the lowest setting to maximize cooling.

**Note:** The temperature control springs back to the lowest setting.

# Climate Control - Vehicles With: Manual Temperature Control

**Note:** When you switch maximum cooling off, air conditioning remains on.

## SWITCHING THE HEATED REAR WINDOW ON AND OFF (IF EQUIPPED)

 Press the button to clear the rear window of thin ice and fog. The heated rear window turns off after a short period of time.

**Note:** Do not use harsh chemicals, razor blades or other sharp objects to clean or remove decals from the inside of the heated rear window as this could cause damage to the heated rear window grid lines not covered by the vehicle Warranty.

## SWITCHING THE HEATED MIRRORS ON AND OFF

 Press the button.

## SETTING THE BLOWER MOTOR SPEED

 **Note:** Lights on the control illuminate to indicate the blower motor speed.

**Note:** When you switch the blower motor off, air conditioning turns off and the windows could fog up.

## SETTING THE TEMPERATURE

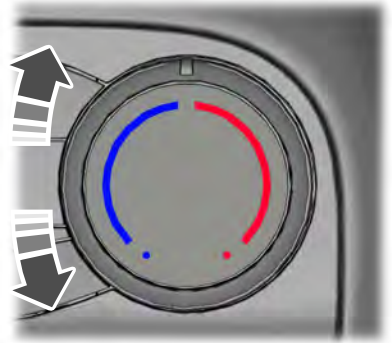

Turn the temperature control counterclockwise for cooler temperature settings.

Turn the temperature control clockwise for warmer temperature settings.

## DIRECTING THE FLOW OF AIR

### Directing Air to the Windshield Air Vents

 Press the button.

### Directing Air to the Instrument Panel Air Vents

 Press the button.

### Directing Air to the Footwell Air Vents

 Press the button.

# Climate Control - Vehicles With: Manual Temperature Control

---

## CLIMATE CONTROL HINTS

### General Hints

- Prolonged use of recirculated air may cause the windows to fog up.
- You may feel a small amount of air from the footwell air vents regardless of the air distribution setting.
- To reduce humidity build-up inside your vehicle, do not drive with the system switched off or with recirculated air always switched on.
- Do not place objects under the front seats as this may interfere with the airflow to the rear seats.
- Remove any snow, ice or leaves from the air intake area at the base of the windshield.
- To improve the time to reach a comfortable temperature in hot weather, drive with the windows open until you feel cold air through the air vents.

### Quickly Heating the Interior

1. Adjust the blower motor speed to the highest speed setting.
2. Adjust the temperature control to the highest setting.
3. Direct air to the footwell air vents.

### Recommended Settings for Heating

1. Adjust the blower motor speed to the center setting.
2. Adjust the temperature control to the midway point of the hot settings.
3. Direct air to the footwell air vents.

### Quickly Cooling the Interior

1. Turn the temperature control counterclockwise past the lowest setting.
2. Drive with the windows open for a short period of time.

### Recommended Settings for Cooling

1. Adjust the blower motor speed to the center setting.
2. Adjust the temperature control to the midway point of the cold settings.
3. Direct air to the instrument panel air vents.

### Defogging the Side Windows in Cold Weather

1. Direct air to the instrument panel and windshield air vents.
2. Press and release **A/C**.
3. Adjust the temperature control to the setting you prefer.
4. Adjust the blower motor speed to the highest setting.
5. Direct air toward the side windows.
6. Close the instrument panel air vents.

# Interior Air Quality

---

## WHAT IS THE CABIN AIR FILTER

The cabin air filter improves the quality of air in your vehicle by trapping dust, pollen and other particles.

## REPLACING THE CABIN AIR FILTER

Replace the filter at regular intervals. See **Scheduled Maintenance** (page 622).

**Note:** *Make sure you have a cabin air filter installed at all times. This prevents foreign objects from entering the system. Running the system without a filter in place could result in degradation or damage to the system.*

**Note:** *Using an aftermarket cabin air filter could reduce cabin air filtration and climate control performance.*



# Front Seats

## FRONT SEAT PRECAUTIONS



**WARNING:** Sitting improperly, out of position or with the seatback reclined too far can take weight off the seat cushion and affect the decision of the passenger sensing system, resulting in serious injury or death in the event of a crash. Always sit upright against your seat back, with your feet on the floor.



**WARNING:** Do not recline the seat backrest too far as this can cause the occupant to slide under the seatbelt, resulting in personal injury in the event of a crash.



**WARNING:** Do not place objects higher than the top of the seat backrest. Failure to follow this instruction could result in personal injury or death in the event of a sudden stop or crash.



**WARNING:** Do not adjust the driver seat or seat backrest when your vehicle is moving. This may result in sudden seat movement, causing the loss of control of your vehicle.

## SITTING IN THE CORRECT POSITION

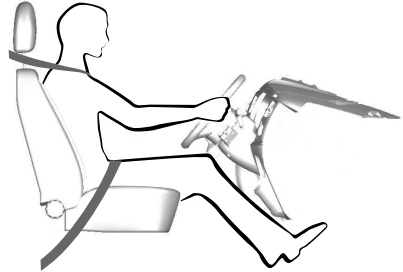

When you use them properly, the seat, head restraint, seatbelt and airbags will provide optimum protection in the event of a crash.

We recommend that you follow these guidelines:

- Sit in an upright position with the base of your spine as far back as possible.
- Do not recline the seat backrest so that your torso is more than 30 degrees from the upright position.
- Adjust the head restraint so that the top of it is level with the top of your head and as far forward as possible. Make sure that you remain comfortable.
- Keep sufficient distance between yourself and the steering wheel. We recommend a minimum of 10 in (25 cm) between your breastbone and the airbag cover.
- Hold the steering wheel with your arms slightly bent.

## Front Seats

- Bend your legs slightly so that you can press the pedals fully.
- Position the shoulder strap of the seatbelt over the center of your shoulder and position the lap strap tightly across your hips.

Make sure that your driving position is comfortable and that you can maintain full control of your vehicle.

### MANUAL SEATS

#### HEADRESTRAINT COMPONENTS

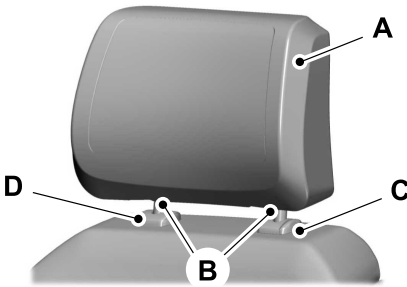



The head restraints consist of:

- A An energy absorbing head restraint.
- B Two steel stems.
- C Guide sleeve adjust and release button.
- D Guide sleeve unlock and remove button (If equipped).

#### ADJUSTING THE HEAD RESTRAINT

 **WARNING:** Fully adjust the head restraint before you sit in or operate your vehicle. This will help minimize the risk of neck injury in the event of a crash. Do not adjust the head restraint when your vehicle is moving.

 **WARNING:** The head restraint is a safety device. Whenever possible it should be installed and properly adjusted when the seat is occupied. Failure to adjust the head restraint properly could reduce its effectiveness during certain impacts.

 **WARNING:** Adjust the head restraints for all passengers before you drive your vehicle. This will help minimize the risk of neck injury in the event of a crash. Do not adjust the head restraints when your vehicle is moving.

**Note:** *Adjust the seat backrest to an upright driving position before adjusting the head restraint. Adjust the head restraint so that the top of it is level with the top of your head and as far forward as possible. Make sure that you remain comfortable. If you are extremely tall, adjust the head restraint to its highest position.*

Pull the head restraint up to raise it.

To lower the head restraint:

1. Press and hold the adjust and release button.
2. Push the head restraint down.

# Front Seats



For vehicles with tilting head restraints:

1. Adjust the seat backrest to an upright driving or riding position.
2. Pivot the head restraint forward toward your head to the preferred position.

After the head restraint reaches the forward-most tilt position, pivot it forward again to release it to the rearward, untilted position.

**Note:** Do not attempt to force the head restraint backward after it is tilted. Instead, continue tilting it forward until the head restraint releases to the upright position.

## REMOVING THE HEAD RESTRAINT

1. Pull up the head restraint until it reaches the highest adjustment position.
2. Press and hold the adjust and release button and the unlock and remove button.
3. Pull up the head restraint.

**Note:** Your vehicle may have a front row center head restraint that you cannot adjust or remove.

## INSTALLING THE HEAD RESTRAINT

Align the steel stems into the guide sleeves and push the head restraint down until it locks.

## MOVING THE SEAT BACKWARD AND FORWARD



**WARNING:** Do not adjust the driver seat or seat backrest when your vehicle is moving. This may result in sudden seat movement, causing the loss of control of your vehicle.



**WARNING:** Make sure the seat fully locks into place by rocking it backward and forward. Not securing the seat into the locked position can be dangerous in a crash and could cause serious personal injury or death.



# Front Seats

## ADJUSTING THE SEAT BACKREST



**WARNING:** Always drive and ride with your seatback upright and the lap belt snug and low across the hips.



**WARNING:** Do not place cargo or any objects behind the seat backrest before returning it to the original position. Pull on the seat backrest to make sure that it has fully latched after returning the seat backrest to its original position. An unlatched seat may become dangerous if you stop suddenly or have a crash.



## ADJUSTING THE LUMBAR SUPPORT

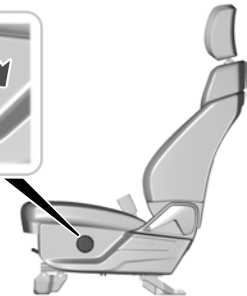
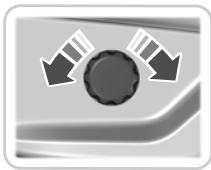

## POWER SEATS (IF EQUIPPED)

### HEADRESTRAINT COMPONENTS

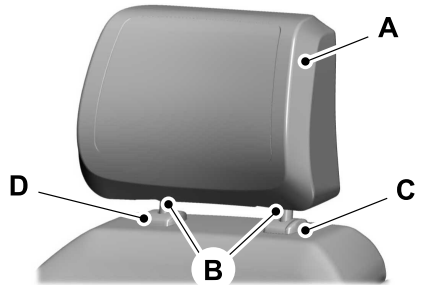

The head restraints consist of:

- A An energy absorbing head restraint.
- B Two steel stems.
- C Guide sleeve adjust and release button.
- D Guide sleeve unlock and remove button.

# Front Seats

## Center Head Restraint - Crew Cab

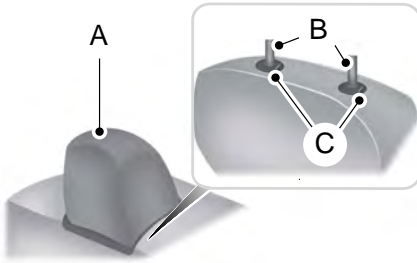

- A An energy absorbing head restraint.
- B Two steel stems.
- C Guide sleeve unlock and remove button.

## ADJUSTING THE HEAD RESTRAINT



**WARNING:** Fully adjust the head restraint before you sit in or operate your vehicle. This will help minimize the risk of neck injury in the event of a crash. Do not adjust the head restraint when your vehicle is moving.



**WARNING:** The head restraint is a safety device. Whenever possible it should be installed and properly adjusted when the seat is occupied. Failure to adjust the head restraint properly could reduce its effectiveness during certain impacts.



**WARNING:** Adjust the head restraints for all passengers before you drive your vehicle. This will help minimize the risk of neck injury in the event of a crash. Do not adjust the head restraints when your vehicle is moving.

To raise the head restraint, pull the head restraint up.

To lower the head restraint:

1. Press and hold the adjust and release button.
2. Push the head restraint down.

To tilt the head restraint - if equipped:



1. Adjust the seat backrest to an upright driving or riding position.
2. Pivot the head restraint forward toward your head to the preferred position.

After the head restraint reaches the forward-most tilt position, pivot it forward again to release it to the rearward, untilted position.

**Note:** Do not attempt to force the head restraint backward after you tilt it. Instead, continue tilting it forward until the head restraint releases to the upright position.

## REMOVING THE HEADRESTRAINT

1. Pull up the head restraint until it reaches its highest position.
2. Press and hold the adjust and release button and the unlock and remove button.
3. Pull up the head restraint.

**Note:** You cannot remove head restraints that have audio system speakers.

# Front Seats

## INSTALLING THE HEAD RESTRAINT

Align the steel stems into the guide sleeves and push the head restraint down until it locks.

**⚠ WARNING:** Do not place cargo or any objects behind the seatback before returning it to the original position.

## MOVING THE SEAT BACKWARD AND FORWARD

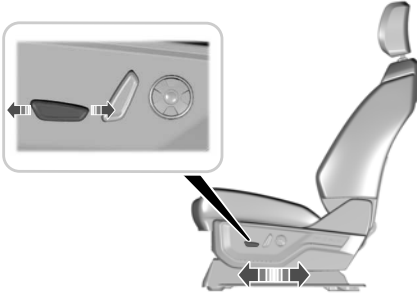

## ADJUSTING THE SEAT CUSHION

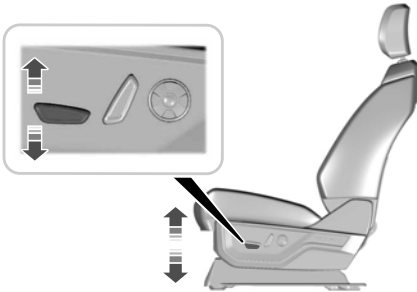

## ADJUSTING THE SEAT HEIGHT

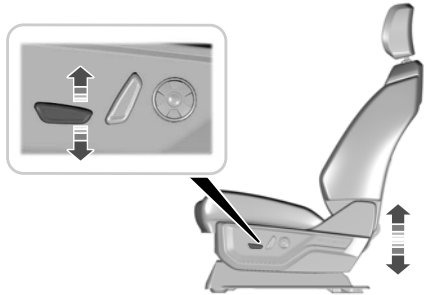

## ADJUSTING THE SEAT BACKREST

**⚠ WARNING:** Always drive and ride with your seatback upright and the lap belt snug and low across the hips.

# Front Seats

## ADJUSTING THE LUMBAR SUPPORT (If Equipped)

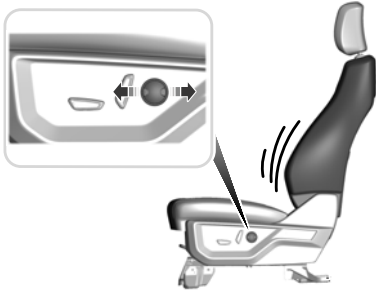

## MESSAGE SEATS (IF EQUIPPED)

### MESSAGE SEAT LIMITATIONS

The engine must be running or the vehicle must be in accessory mode to activate the seats.

The passenger side massage is available if the occupant meets the seat sensor weight requirements.

Allow a few seconds for any selection to activate. Selecting a different adjustment cancels the current one in progress. When the seat backrest and cushion are both active, the massage alternates between zones.

## ADJUSTING THE MESSAGE SEAT SETTINGS

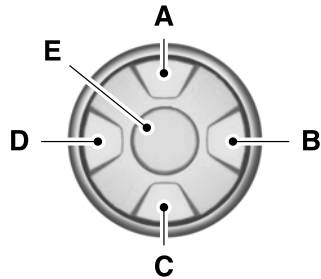

- A Select the previous massage pattern or lumbar area.
- B Decrease the massage or lumbar Intensity.
- C Select the next massage pattern or lumbar area.
- D Increase the massage or lumbar Intensity.
- E Select the massage or lumbar mode.

You can also adjust this feature through the touchscreen.

# Front Seats

## HEATED SEATS (IF EQUIPPED)

### HEATED SEAT PRECAUTIONS



**WARNING:** Use caution when using the heated seat if you are unable to feel pain to your skin because of advanced age, chronic illness, diabetes, spinal cord injury, medication, alcohol use, exhaustion or other physical conditions. The heated seat could cause burns even at low temperatures, especially if used for long periods of time. Failure to follow this instruction could result in personal injury.



**WARNING:** Do not poke sharp objects into the seat cushion or seat backrest. This could damage the heated seat element and cause it to overheat. Failure to follow this instruction could result in personal injury.



**WARNING:** Do not place anything on the seat that blocks the heat, for example a seat cover or a cushion. This could cause the seat to overheat. Failure to follow this instruction could result in personal injury.

Do not:

- Place heavy objects on the seat.
- Operate the heated seat if water or any other liquid spills on the seat. Allow the seat to dry.

### SWITCHING THE HEATED SEATS ON AND OFF

The vehicle must be running to use this feature.



Press the heated seat symbol on the climate controls or touchscreen to cycle through the various heat settings and off. The more indicators that display, the warmer the temperature of the seat.

**Note:** *The heated seats may remain on after you remote start your vehicle, based on your remote start settings. The heated seats may also turn on when you start your vehicle if they were on when you switched your vehicle off.*

## VENTILATED SEATS (IF EQUIPPED)

### VENTILATED SEAT PRECAUTIONS

Do not:

- Spill liquid on the front seats. This may cause the air vent holes to become blocked and not work properly.
- Place cargo or objects under the seats. They may block the air intake causing the air vents to not work properly.

### SWITCHING THE VENTILATED SEATS ON AND OFF

The vehicle must be running to use this feature.





## Front Seats

---

Press this symbol on the climate controls or the touchscreen to cycle through the various ventilation settings and off. More indicator lights indicate higher fan speeds.

**Note:** *When you switch the climate control fan speed and the ventilated seats to their maximum settings, the ventilated seats provide increased cooling.*

If the engine falls below 350 RPM while the ventilated seats are on, the feature turns itself off unless the vehicle is in Auto-Start-Stop mode. You may need to reactivate the ventilated seats.

**Note:** *The ventilated seats may remain on after you remote start your vehicle, based on your remote start settings. The ventilated seats may also turn on when you start your vehicle if they were on when you switched your vehicle off.*

# Rear Seats

## MANUAL SEATS

### HEADRESTRAINT COMPONENTS

#### Outermost Head Restraints

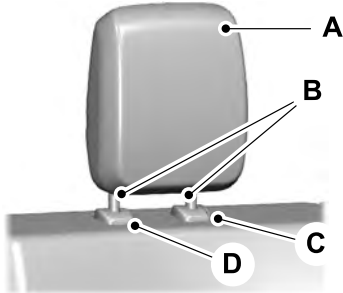

The head restraints consist of:

- A An energy absorbing head restraint.
- B Two steel stems.
- C Guide sleeve adjust and release button.
- D Guide sleeve unlock and remove button.

#### Center Head Restraint - Crew Cab

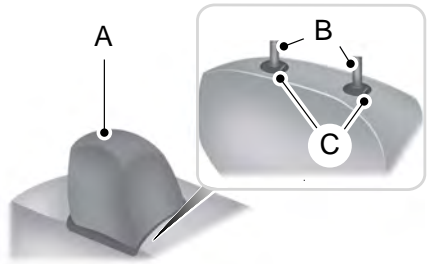

- A An energy absorbing head restraint.
- B Two steel stems.
- C Guide sleeve unlock and remove button.

### ADJUSTING THE HEAD RESTRAINT

Pull the head restraint up to raise it.

To lower the head restraint:

1. Press and hold the adjust and release button.
2. Push the head restraint down.

Your vehicle may have a rear seat center head restraint that you cannot adjust or remove.

### REMOVING THE HEADRESTRAINT

1. Pull up the head restraint until it reaches its highest position.
2. Press and hold the adjust and release button and the unlock and remove button.
3. Pull up the head restraint.

# Rear Seats

## INSTALLING THE HEAD RESTRAINT

Align the steel stems into the guide sleeves and push the head restraint down until it locks.

## FOLDING THE SEATS

If your vehicle has a split folding rear seat, you can flip each seat cushion up into a vertical storage position.



Rotate the seat cushion up until it locks in place.

### Locking the Cushion (If Equipped)

The locking key is in the remote control. See **Using the Remote Control** (page 69).

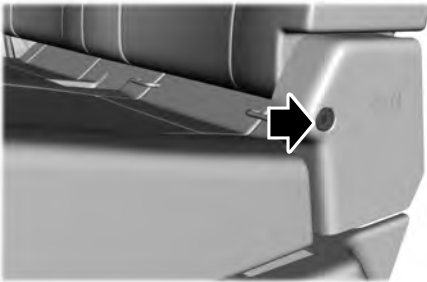

Turn the key to lock or unlock.

## UNFOLDING THE SEATS



**WARNING:** Make sure that cargo and other objects are not trapped under the seat cushion and that you return the seat cushion to the full-down position. Failure to do so may prevent the seat from operating properly, which could increase the risk of serious injury in a crash.

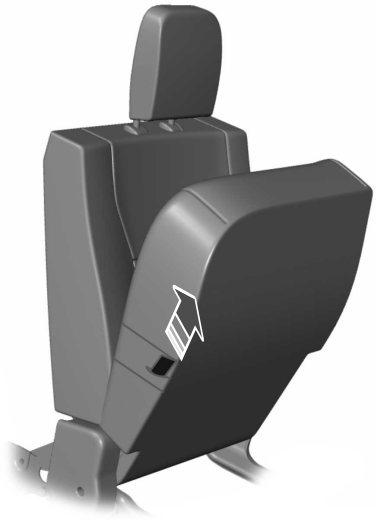

Pull the strap to lower the seat cushion.

### Rear Under Seat Storage (If Equipped)

The rear seat has storage space under the seat cushion.

## Rear Seats

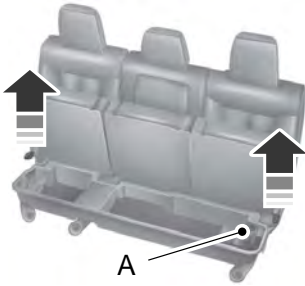

Lift the lever and flip up the seat cushion to access the storage space and the power point (A).

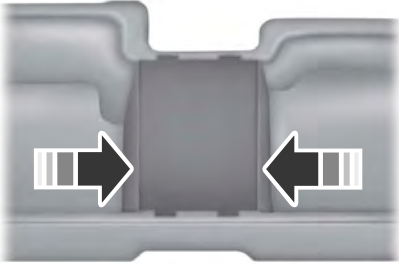

To remove the storage space divider, squeeze the sides and lift it from the storage tub.



Use your vehicle key to lock the storage space.

### HEATED SEATS (IF EQUIPPED)

#### HEATED SEAT PRECAUTIONS

**⚠ WARNING:** Use caution when using the heated seat if you are unable to feel pain to your skin because of advanced age, chronic illness, diabetes, spinal cord injury, medication, alcohol use, exhaustion or other physical conditions. The heated seat could cause burns even at low temperatures, especially if used for long periods of time. Failure to follow this instruction could result in personal injury.

**⚠ WARNING:** Do not poke sharp objects into the seat cushion or seat backrest. This could damage the heated seat element and cause it to overheat. Failure to follow this instruction could result in personal injury.

**⚠ WARNING:** Do not place anything on the seat that blocks the heat, for example a seat cover or a cushion. This could cause the seat to overheat. Failure to follow this instruction could result in personal injury.

Do not:

- Place heavy objects on the seat.
- Operate the heated seat if water or any other liquid spills on the seat. Allow the seat to dry.

#### SWITCHING THE HEATED SEATS ON AND OFF

The vehicle must be running to use this feature.

## Rear Seats

---

The rear seat heat controls are on the rear of the center console.



Press the heated seat symbol to cycle through the various heat settings and off. More indicator lights indicate warmer settings.

The heated seats turn off when you switch off the vehicle.

# Rear Occupant Alert System (If Equipped)

## WHAT IS THE REAR OCCUPANT ALERT SYSTEM

The rear occupant alert system monitors vehicle conditions and notifies you to check for rear seat occupants when you switch the ignition off.

## HOW DOES THE REAR OCCUPANT ALERT SYSTEM WORK

The system monitors when rear doors have been opened and closed to indicate the potential presence of an occupant in the rear seat.

A message displays in the information and entertainment display screen and an audible warning sounds when you switch the ignition off after any of the following conditions have been met:

- A rear door is opened or closed while the ignition is on.
- You switch the ignition on within 15 minutes of a rear door opening and closing.
- You switch the ignition on within 15 minutes of the alert having displayed or sounded.

## REAR OCCUPANT ALERT SYSTEM PRECAUTIONS



**WARNING:** On hot days, the temperature inside the vehicle can rise very quickly. Exposure of people or animals to these high temperatures for even a short time can cause death or serious heat related injuries, including brain damage. Small children are particularly at risk.



**WARNING:** Do not leave children or pets unattended in your vehicle. Failure to follow this instruction could result in personal injury or death.

## REAR OCCUPANT ALERT SYSTEM LIMITATIONS

The system does not detect the presence of objects or passengers in the rear seat. It monitors when rear doors are opened and closed.

**Note:** *It is possible to receive an alert when there is no rear seat occupant, but alert conditions are met.*

**Note:** *It is possible to receive no alert when there is an occupant in the rear seat, if alert conditions are not met. For example, if a rear seat occupant does not enter the vehicle through a rear door.*

**Note:** *The audible warning does not sound when the front door is opened before you switch the ignition off.*

## SWITCHING REAR OCCUPANT ALERT SYSTEM ON AND OFF - VEHICLES WITH: SYNC



Press the button on the audio unit.

1. Using the controls on the audio unit, select **Settings**.
2. Switch **Rear Occupant Alert** on or off.

### **Semiannual Reminder (If Equipped)**

When you switch the system off, a message appears every six months as a reminder that the system is off. You can switch the system back on or leave it off.

## Rear Occupant Alert System (If Equipped)

### SWITCHING REAR OCCUPANT ALERT SYSTEM ON AND OFF - VEHICLES WITH: SYNC 3

1. Press **Settings** on the touchscreen.
2. Press **Vehicle**.
3. Switch **Rear Occupant Alert** on or off.

**Note:** *The default setting is on.*

**Note:** *Performing a master reset causes the system to switch on again.*

#### **Semiannual Reminder (If Equipped)**

When you switch the system off, a message appears every six months as a reminder that the system is off. You can switch the system back on or leave it off.

### SWITCHING REAR OCCUPANT ALERT SYSTEM ON AND OFF - VEHICLES WITH: SYNC 4

1. Press **Settings** on the touchscreen.
2. Press **Vehicle**.
3. Switch **Rear Occupant Alert** on or off.

**Note:** *The default setting is on.*

**Note:** *Performing a master reset causes the system to switch on again.*

#### **Semiannual Reminder (If Equipped)**

When you switch the system off, a message appears every six months as a reminder that the system is off. You can switch the system back on or leave it off.

### REAR OCCUPANT ALERT SYSTEM INDICATORS - VEHICLES WITH: SYNC

Message
Check rear seats for occupants.

Displays when you switch the vehicle off after the alert conditions are met.



The message displays for a short period of time. Press the **OK** button to acknowledge and remove some messages from the information display.

### REAR OCCUPANT ALERT SYSTEM INDICATORS - VEHICLES WITH: SYNC 3/ SYNC 4



Message
Check rear seats for occupants.

Displays when you switch your vehicle off after the alert conditions are met.

## Rear Occupant Alert System (If Equipped)

---

The message displays for a short period of time. Press **Close** to acknowledge and remove the message.

**Note:** *Depending on your SYNC version, the graphic may look different from what you see here.*

### **REAR OCCUPANT ALERT SYSTEM AUDIBLE WARNINGS**

Sounds when you switch your vehicle off after the alert conditions are met.

The warning sounds for a short period of time.



# Memory Function

## WHAT IS THE MEMORY FUNCTION

The memory function recalls the position of these features:

- Driver seat.
- Power mirrors.
- Optional power steering column.
- Optional power adjustable pedals.

## MEMORY FUNCTION PRECAUTIONS

**WARNING:** Before activating the memory seat, make sure that the area immediately surrounding the seat is clear of obstructions and that all occupants are clear of moving parts.

**WARNING:** Do not use the memory function when your vehicle is moving.

## LOCATING THE MEMORY FUNCTION BUTTONS



The memory function buttons are on the driver door.

## SAVING A PRESET POSITION

1. Adjust the memory features to your preferred position.
2. Press and hold the preferred preset button until you hear a single tone.

A confirmation message appears in the information display.

You can save up to three preset memory positions at any time.

## RECALLING A PRESET POSITION

Press and release a preset button.

**Note:** You can recall a preset memory position when the ignition is off, or when you place the transmission in park (P) or neutral (N) if the ignition is on and the vehicle is not moving.

**Note:** Pressing any of the preset buttons or any memory feature control during a memory recall cancels the operation.

You can also recall a preset memory position by:

- Pressing the unlock button on your remote control if you linked it to a preset position.
- Unlocking the intelligent driver door handle if a linked remote control is present.

Using a linked remote control to recall your memory position when the ignition is off moves the seat and steering column to the easy entry position.

## Linking a Preset Position to Your Remote Control or Passive Key

Your vehicle can save the preset memory positions for up to two remote controls.

1. With the ignition on, move the memory positions to the positions you prefer.

# Memory Function

---

2. Press and hold the preferred preset button for about five seconds. A tone sounds, and the instrument panel prompts you to press the lock button on your remote control.
3. Within ten seconds, press the lock button on the remote control you are linking. The instrument panel indicates a successful link.

To unlink a remote control, follow the same procedure – except in step 3, press the unlock button on the remote control.

**Note:** *If more than one linked remote control is in range, the memory function moves to the settings of the first key to initiate a memory recall.*

## Garage Door Opener (If Equipped)

### WHAT IS THE GARAGE DOOR OPENER

#### HomeLink Wireless Control System



The universal garage door opener replaces the common hand-held garage door opener with a three-button transmitter integrated into the driver's sun visor.

### HOW DOES THE GARAGE DOOR OPENER WORK

The system includes two primary features, a garage door opener and a platform for remote activation of devices within the home. You can program garage doors as well as entry gate operators, security systems, entry door locks and home or office lighting.

Additional system information can be found online at [www.homelink.com](http://www.homelink.com) or by calling the toll-free help line at 1-800-355-3515.

**Note:** You can program a maximum of three devices. To change or replace any of the three devices after it has been initially programmed, you must first erase the current settings. See **Clearing the Garage Door Opener** (page 178).

### GARAGE DOOR OPENER PRECAUTIONS



**WARNING:** Do not use the system with any garage door opener that does not have the safety stop and reverse feature as required by U.S. Federal Safety Standards (this includes any garage door opener manufactured before April 1, 1982). A garage door opener which cannot detect an object, signaling the door to stop and reverse, does not meet current federal safety standards. Using a garage door opener without these features increases the risk of serious injury or death.

**Note:** Make sure that the garage door and security device are free from obstruction when you are programming. Do not program the system with your vehicle in the garage.

**Note:** Make sure you keep the original remote control transmitter for use in other vehicles as well as for future system programming.

**Note:** We recommend that upon the sale or lease termination of your vehicle, you erase the programmed function buttons for security reasons. See **Clearing the Garage Door Opener** (page 178).

### GARAGE DOOR OPENER LIMITATIONS

Canadian radio-frequency laws require transmitter signals to time-out (or quit) after several seconds – which may not be long enough for HomeLink to pick up the signal.

U.S. gate operators time-out in the same manner.

## Garage Door Opener (If Equipped)

**Note:** If programming a garage door opener or gate operator, it is advised to unplug the device during the “cycling” process to prevent possible overheating.

### PROGRAMMING THE GARAGE DOOR OPENER TO YOUR HAND-HELD TRANSMITTER

This process is to program your in-vehicle HomeLink function button with your hand-held transmitter.

**Note:** The programming steps below assume you will be programming HomeLink that was not previously programmed. If your HomeLink was previously programmed, you may need to erase your HomeLink buttons. See **Clearing the Garage Door Opener** (page 178).



1. With your vehicle parked outside of the garage, switch your ignition to the on position, but do not start your vehicle.
2. Press and release one of the three HomeLink function buttons that you would like to program.
3. Hold your hand-held garage door transmitter 1–3 in (2–8 cm) away from the HomeLink button you want to program.

4. Press and hold the hand-held transmitter button you want to program while watching the indicator light on HomeLink. Continue to hold the hand-held button until the HomeLink indicator light flashes rapidly or is continuously on.

**Note:** You may need to use a different method if you live in Canada or have difficulties programming your gate operator or garage door opener. See **Programming the Garage Door Opener to Your Gate Opener Motor** (page 178).

5. Press and hold the HomeLink button you programmed for two seconds, then release. You may need to do this twice to activate the door.

**Note:** If the indicator light stays on, the programming is complete.

**Note:** If the HomeLink indicator flashes rapidly, repeat step 5.

**Note:** If your device still does not operate, you must program your garage door. See **Programming the Garage Door Opener to Your Garage Door Opener Motor** (page 177).

6. To program additional buttons, repeat Steps 1 – 4.

### PROGRAMMING THE GARAGE DOOR OPENER TO YOUR GARAGE DOOR OPENER MOTOR



## Garage Door Opener (If Equipped)

1. Press the learn button on the garage door opener motor, you have 30 seconds to complete the next two steps.
2. Return to your vehicle.

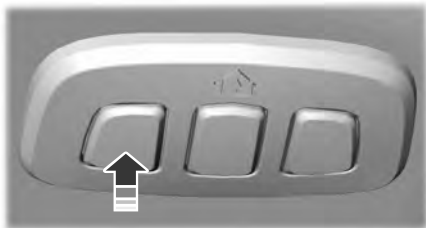

3. Press and hold one of the three HomeLink function buttons you want to program for two seconds, then release. Repeat this step. Depending on your brand of garage door opener, you may need to repeat this sequence a third time.

### PROGRAMMING THE GARAGE DOOR OPENER TO YOUR GATE OPENER MOTOR

#### Gate Operator / Canadian Programming

Canadian radio-frequency laws require transmitter signals to “time-out” (or quit) after several seconds of transmission – which may not be long enough for HomeLink to pick up the signal during programming. Similar to this Canadian law, some U.S. gate operators “time-out” in the same manner.

**Note:** *If programming a garage door opener or gate operator, it is advised to unplug the device during the “cycling” process to prevent possible overheating.*

1. Press and release, every two seconds, your hand-held transmitter until the HomeLink indicator light changes to a rapidly blinking or continuously on light.
2. Release the hand-held transmitter button.
3. Press and hold the HomeLink function button you want to program for two seconds, then release. You may need to do this twice to activate the door.

**Note:** *If the indicator light stays on, the programming is complete.*

**Note:** *If the HomeLink indicator flashes rapidly, repeat Step 3.*

**Note:** *If your device still does not operate, you must program your garage door. See **Programming the Garage Door Opener to Your Garage Door Opener Motor** (page 177).*

4. To program additional buttons, repeat Steps 1 – 4.

### CLEARING THE GARAGE DOOR OPENER

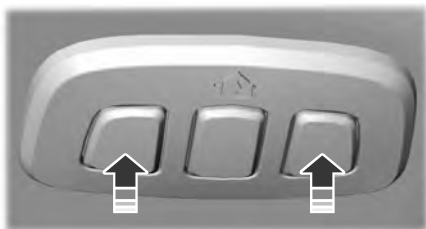

1. Press and hold the outer two function buttons simultaneously for approximately 10 seconds until the indicator light above the buttons flashes rapidly.

## Garage Door Opener (If Equipped)

---

2. When the indicator light flashes, release the buttons.

**Note:** *You cannot erase individual buttons.*

### REPROGRAMMING THE GARAGE DOOR OPENER

To program a device to a previously trained button, follow these steps:

1. Press and hold the desired button. Do NOT release the button.
2. The indicator light begins to flash after 20 seconds. Without releasing the button, follow programming steps.

### GARAGE DOOR OPENER RADIO FREQUENCIES

#### FCC and RSS-210 Industry Canada Compliance



**WARNING:** Changes or modifications not expressly approved by the party responsible for compliance could void the user's authority to operate the equipment. The term "IC:" before the radio certification number only signifies that Industry Canada technical specifications were met.

This device complies with Part 15 of the FCC Rules and with RSS-210 of Industry Canada. Operation is subject to the following two conditions: (1) this device may not cause harmful interference, and (2) this device must accept any interference received, including interference that could cause undesired operation.

This equipment complies with FCC radiation exposure limits set forth for an uncontrolled environment. End Users must follow the specific operating instructions for satisfying RF exposure compliance. This transmitter must be at least 8 in (20 cm) from the user and must not be co-located or operating in conjunction with any other antenna or transmitter.

# USB Ports

## LOCATING THE USB PORTS

### Data Transfer USB Ports



The USB Ports could be in the following locations:

- On the lower instrument panel.
- Inside the media bin.
- Inside the center console.

**Note:** *These USB ports can also charge devices.*

**Note:** *Not all USB ports in your vehicle have data transfer capabilities.*

**Note:** *We recommend using only USB-IF certified cables and adapters. Non-certified cables and adapters may not work.*

### Charge Only USB Ports



The USB ports could be in the following locations:

- On the lower instrument panel.
- On the upper instrument panel.
- Inside the media bin.
- Inside the center console.
- On the rear of the center console.
- In the cargo area.

## PLAYING MEDIA USING THE USB PORT



**WARNING:** Driving while distracted can result in loss of vehicle control, crash and injury. We strongly recommend that you use extreme caution when using any device that may take your focus off the road. Your primary responsibility is the safe operation of your vehicle. We recommend against the use of any hand-held device while driving and encourage the use of voice-operated systems when possible. Make sure you are aware of all applicable local laws that may affect the use of electronic devices while driving.

Connect your device to the USB port.



Press the audio button on the feature bar.

Select **Sources**.



Select the USB option.



Press the button to play a track. Press the button again to pause the track.



Press the button to skip to the next track.

Press and hold the button to fast forward through the track.



Press the button once to return to the beginning of a track. Repeatedly press the button to return to previous tracks.

Press and hold the button to fast rewind.

# USB Ports

---

## **CHARGING A DEVICE**

Connect your device to the USB port.

You can use the charger when the vehicle is in accessory mode, when the vehicle is running, or when SYNC is on.



# Power Outlet - Vehicles With: 120V Power Outlet

## WHAT IS THE POWER OUTLET

The power outlet can power devices that require up to the rating on the outlet cover.

**Note:** *The total power delivered is divided if more than one outlet is used.*

## POWER OUTLET PRECAUTIONS



**WARNING:** Do not keep electrical devices plugged in the power point whenever the device is not in use. Do not use any extension cord with the 120 volt AC power point, since it will defeat the safety protection design. Doing so may cause the power point to overload due to powering multiple devices that can reach beyond the 400 watt load limit and could result in fire or serious injury.

## POWER OUTLET LIMITATIONS

Devices may exceed the power rating shown the device label when plugged in. Unplug the device and switch the ignition on and off to reset the system.

You should not use the power outlet for these types of electric devices:

- Cathode ray tube type televisions.
- Motor loads, for example vacuum cleaners, electric saws and other electric power tools, or compressor-driven refrigerators.
- Measuring devices which process precise data, for example medical equipment or measuring equipment.
- Other appliances requiring an extremely stable power supply, for example microcomputer-controlled electric blankets or touch sensor lamps.

## LOCATING THE POWER OUTLET

The power outlet is on the instrument panel or the rear of the center console.



## POWER OUTLET INDICATORS

The power outlet indicator illuminates to let you know the status of the system.

Indicator Status	Description
On	The power point is working, the ignition is on, or the vehicle is in accessory mode.
Off	The power point is off, the ignition is off, or the vehicle is not in accessory mode.
Flashing	The power point is in fault mode.

**Note:** *Due to different technologies used on its construction, some devices may exceed the capacity shown on its label when they are initially plugged in.*

## Power Outlet - Vehicles With: 120V Power Outlet

---

**Note:** *The power outlet temporarily turns off power when in fault mode if the device exceeds the Watt limit. Unplug your device and switch the ignition off. Switch the ignition back on, but do not plug your device back in. Let the system cool off and switch the ignition off to reset the fault mode. Switch the ignition back on and make sure the indicator light remains on.*

# Power Outlet - Vehicles With: 12V Power Outlet

---

## WHAT IS THE POWER OUTLET

The power outlet can power devices using a 12 V outlet adapter.

## POWER OUTLET PRECAUTIONS

When you switch the vehicle on, you can use the socket to power 12 V appliances with a maximum current rating of 20 A. Do not use the power point over the vehicle capacity of 12 V DC 240 W or a fuse could blow. Do not plug in any device that supplies power to the vehicle through the power points. This could result in damage to vehicle systems. Do not hang any accessory from the accessory plug. Always keep the power point caps closed when not in use. Do not insert objects other than an accessory plug into the power point.

To prevent the battery from running out of charge:

- Do not use the power point longer than necessary when the vehicle is off.
- Do not leave devices plugged in overnight or when you park your vehicle for extended periods.

## LOCATING THE POWER OUTLET

Power outlets are in the following locations:

- On the instrument panel.
- Inside the center console.
- On the rear of the center console.

# Wireless Accessory Charger (If Equipped)

## WHAT IS THE WIRELESS ACCESSORY CHARGER

The wireless accessory charger allows you to charge one compatible Qi wireless charging device on the charging area.

## WIRELESS ACCESSORY CHARGER PRECAUTIONS



**WARNING:** Wireless charging devices can affect the operation of implanted medical devices, including cardiac pacemakers. If you have any implanted medical devices, we recommend that you consult with your physician.

Tests on this equipment show that it complies with part 18 of the FCC Rules.

- This equipment generates, uses and can radiate radio frequency energy and may cause harmful interference to radio communications. There is no guarantee that the interference will not occur in a particular installation. If this equipment does cause harmful interference to radio or television reception, please consult the dealer.
- This product is not end-user serviceable.



**WARNING:** Changes or modifications not expressly approved by the party responsible for compliance could void the user's authority to operate the equipment. The term "IC:" before the radio certification number only signifies that Industry Canada technical specifications were met.

This device complies with Industry Canada licence-exempt RSS standard(s).

Operation is subject to:

- This device may not cause interference.
- This device must accept any interference, including interference that may cause undesired operation of the device.

Keep the charging area clean and remove foreign objects prior to charging a device.

Do not place items with a magnetic strip or radio-frequency identification chip, for example passports, parking tickets, transportation passes or credit cards, near the charging area when charging a device. Damage may occur to the magnetic strip or radio-frequency identification chip.

Do not place metal objects, for example remote controls, coins and candy wrappers, on or near the charging area when charging a device. Metal objects may heat up and degrade the charging performance, in addition to causing error messages and interruptions in charging.

**Note:** *During charging, the device and the charger could heat up, this is normal. If the battery gets hotter than usual, the device may stop charging.*

## LOCATING THE WIRELESS ACCESSORY CHARGER



The charging area is in the center console media bin below the instrument panel.

## CHARGING A WIRELESS DEVICE

Place the device on the center of the charging surface with the charging side down. The charging stops after your device reaches a full charge.

## Wireless Accessory Charger (If Equipped)

---

You can use the charger when the vehicle is in accessory mode, when the vehicle is running, or when SYNC is on.



Displays on the status bar when wireless charging is in progress.

**Note:** *The charging performance may be affected if your device is in a case. It may be necessary to remove the case to wirelessly charge your device.*

**Note:** *Software and firmware updates may affect device compatibility, including the use of unofficial software or firmware. You should verify charging functionality with your specific devices in-vehicle.*

# Storage

## CUP HOLDERS

### CUP HOLDER PRECAUTIONS



**WARNING:** Use caution when stowing items or hot drinks in the cup holders. Items could become loose or spill during hard braking, acceleration or crashes. Failure to follow this instruction could result in personal injury.

## GLOVE COMPARTMENT

### OPENING THE GLOVE COMPARTMENT

#### Upper Glove Compartment (if Equipped)

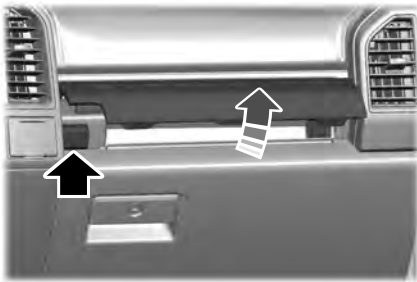

Push the button on the instrument panel to open.

#### Lower Glove Compartment



Pull the latch to open.

### LOCKING THE GLOVE COMPARTMENT

To lock the lower glove compartment, use the key.

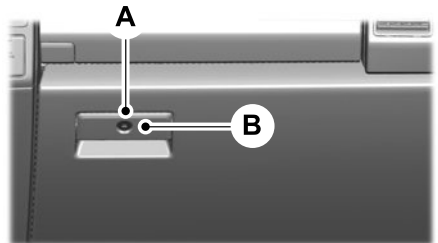

- A Unlock.
- B Lock.

# Storage

## CENTER CONSOLE

### OPENING THE CENTER CONSOLE

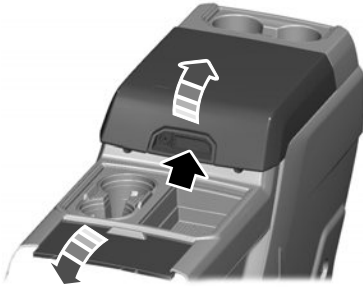

To open the center console push the button and lift up.

## UNDER SEAT STORAGE

### LOCATING THE UNDER SEAT STORAGE COMPARTMENT

#### Front Under Seat Storage



Lift the latch to access the storage compartment under the center seat cushion.

### Locking the Front Under Seat Storage

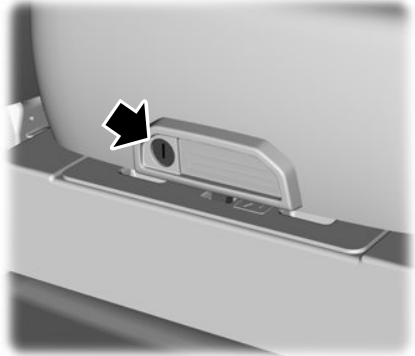

1. Use the key in the remote control to unlock.

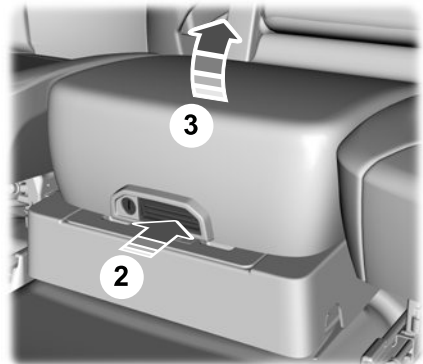

2. Press the latch to release the cushion.
3. Lift the cushion to access the storage compartment.

# Storage

## Rear Under Seat Storage



Lift the rear seat to access the under seat storage bin.

## Locking the Rear Under Seat Storage



1. Lift the rear seat to access under seat storage bin.

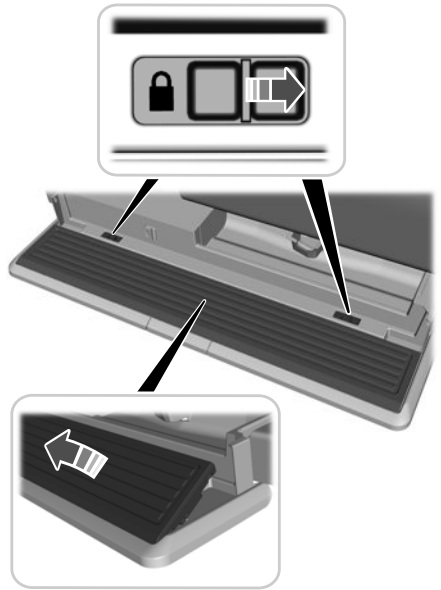

2. Lift the front and side panels to expand and lock them in place.



# Storage

4. To collapse, release the lever, push down to the stowed position and fold in the side and front panels.

**Note:** Make sure the storage divider is not locked into place when collapsing. Push the button to release the divider door and swing to stowed position on front wall.

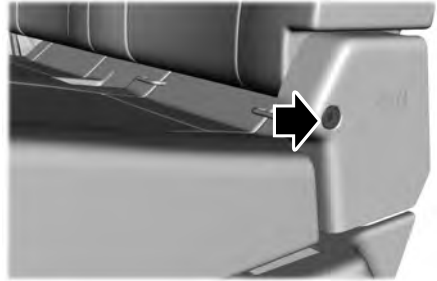
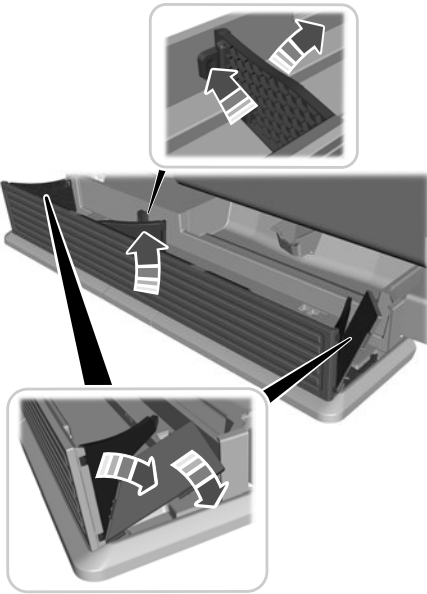

The locking key is in the key fob. Turn the key to lock or unlock the cushion.

## GLASSES HOLDER

### LOCATING THE GLASSES HOLDER

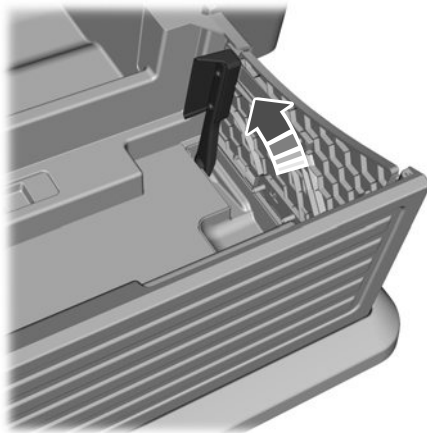

The glasses holder is in the overhead console.

Press near the rear edge of the door to open it.

# Starting and Stopping the Engine

## STARTING AND STOPPING THE ENGINE – PRECAUTIONS

**WARNING:** Extended idling at high engine speeds can produce very high temperatures in the engine and exhaust system, creating the risk of fire or other damage.

**WARNING:** Do not park, idle or drive your vehicle on dry grass or other dry ground cover. The emission system heats up the engine compartment and exhaust system, creating the risk of fire.

**WARNING:** Do not start the engine in a closed garage or in other enclosed areas. Exhaust fumes are toxic. Always open the garage door before you start the engine. Failure to follow this instruction could result in personal injury or death.

**WARNING:** Do not use starting fluid, for example ether, in the air intake system. Such fluid could cause immediate explosive damage to the engine and possible personal injury.

**WARNING:** Exhaust leaks may result in entry of harmful and potentially lethal fumes into the passenger compartment. If you smell exhaust fumes inside your vehicle, have your vehicle inspected immediately. Do not drive if you smell exhaust fumes.

The powertrain control system meets all Canadian interference-causing equipment standard requirements regulating the impulse electrical field or radio noise.

If you stop your vehicle and leave the engine idling for long periods, we recommend that you do one of the following:

- Open the windows at least 1 in (2.5 cm).
- Set your climate control to outside air.

## IGNITION SWITCH (IF EQUIPPED)

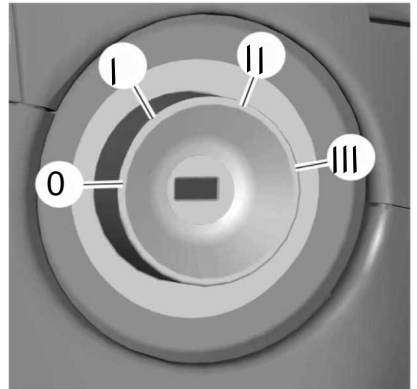

### Switching the Ignition Off

Turn the key to position **0**.

### Switching the Ignition to Accessory Mode

Turn the key to position **I**. Electrical accessories, for example the radio, operate without the engine running.

### Switching the Ignition On

Turn the key to position **II**. All electrical circuits and accessories are operational and the warning lamps and indicators illuminate.

# Starting and Stopping the Engine

## Starting the Engine

Turn the key to position **III**. Release the key when the engine starts.

## PUSH BUTTON IGNITION SWITCH (IF EQUIPPED)



## Switching the Ignition Off

When the ignition is on or in accessory mode, press the push button ignition switch once without your foot on the brake pedal.

## Switching the Ignition to Accessory Mode

When the ignition is off, press the push button ignition switch once without your foot on the brake pedal.

All electrical circuits and accessories are operational and the warning lamps and indicators illuminate.

**Note:** *Your vehicle has a battery saver feature that shuts your vehicle off when it detects a certain amount of battery drain, or after approximately 30 minutes of inactivity in accessory mode.*

## Starting the Engine

With the transmission in park (P), press the brake pedal and press the push button ignition switch. An indicator light on the button illuminates when the ignition is on and when the engine starts.

**Note:** *The system may not function if the passive key is close to metal objects or electronic devices, for example keys or a cell phone.*

**Note:** *A valid key must be inside your vehicle to switch the ignition on and start the engine.*

## STARTING THE ENGINE

### STARTING A GASOLINE ENGINE - VEHICLES WITHOUT: PUSH BUTTON START

Before starting your vehicle, check the following:

- Make sure that the headlamps and electrical accessories are off.
  - Make sure that the parking brake is on.
  - Make sure that the transmission is in park (P).
1. Fully press the brake pedal.

**Note:** *Do not touch the accelerator pedal.*



2. Turn the key to position **III**.

**Note:** *The engine may continue cranking for up to 15 seconds or until it starts.*

**Note:** *The engine takes longer to start at lower temperatures. It may crank for several seconds when very cold.*

# Starting and Stopping the Engine

## STARTING A GASOLINE ENGINE - VEHICLES WITH: PUSH BUTTON START

Before starting your vehicle, check the following:

- Make sure that the headlamps and electrical accessories are off.
- Make sure that the parking brake is on.
- Make sure that the transmission is in park (P).

1. Fully press the brake pedal.

**Note:** Do not touch the accelerator pedal.



2. Press the push button ignition switch.

**Note:** The engine may continue cranking for up to 15 seconds or until it starts.

**Note:** The engine takes longer to start at lower temperatures. It may crank for several seconds when very cold.

## STARTING A DIESEL ENGINE - VEHICLES WITHOUT: PUSH BUTTON START

Before starting your vehicle, check the following:

- Make sure that the headlamps and electrical accessories are off.
- Make sure that the parking brake is on.
- Make sure that the transmission is in park (P).



1. Turn the key to position II.

**Note:** Wait until the glow plug indicator turns off.

2. Fully press the brake pedal.

**Note:** Do not touch the accelerator pedal.



3. Turn the key to position III.

**Note:** The engine may continue cranking for up to 15 seconds or until it starts.

**Note:** The engine takes longer to start at lower temperatures. It may crank for several seconds when very cold.

## Glow Plug Indicator



If it illuminates, wait until the glow plug indicator turns off before starting the engine.

## STARTING A DIESEL ENGINE - VEHICLES WITH: PUSH BUTTON START

Before starting your vehicle, check the following:

- Make sure that the headlamps and electrical accessories are off.
- Make sure that the parking brake is on.
- Make sure that the transmission is in park (P).

1. Fully press the brake pedal.

**Note:** Do not touch the accelerator pedal.

# Starting and Stopping the Engine



2. Press the push button ignition switch.

**Note:** The engine may continue cranking for up to 15 seconds or until it starts.

**Note:** The engine takes longer to start at lower temperatures. It may crank for several seconds when very cold.

## Glow Plug Indicator



The engine does not start until the glow plug indicator turns off. This may take several seconds in extremely cold conditions.

## RESTARTING THE ENGINE AFTER STOPPING IT - VEHICLES WITH: PUSH BUTTON START

The system allows you to start the engine within 10 seconds of switching it off, even if it does not detect a valid passive key.

Within 10 seconds of switching the engine off, fully press the brake pedal and press the push button ignition switch. After 10 seconds, you can no longer start the engine if the system does not detect a valid passive key.

When you start the engine, it remains running until you press the push button ignition switch, even if your vehicle does not detect a valid passive key. If you open and close a door when the engine is running, the system searches for a valid passive key.

## ENGINE BLOCK HEATER (IF EQUIPPED)

### ENGINE BLOCK HEATER PRECAUTIONS



**WARNING:** Failure to follow engine block heater instructions could result in property damage or serious personal injury.



**WARNING:** Do not use your heater with ungrounded electrical systems or two-pronged adapters. There is a risk of electrical shock.



**WARNING:** Do not fully close the hood, or allow it to drop under its own weight when using the engine block heater. This could damage the power cable and may cause an electrical short resulting in fire, injury and property damage.

We recommend that you do the following for a safe and correct operation:

- Use a 16-gauge outdoor extension cord that is product certified by Underwriter's Laboratory (UL) or Canadian Standards Association (CSA). This extension cord must be suitable for use outdoors, in cold temperatures, and be clearly marked Suitable for Use with Outdoor Appliances. Do not use an indoor extension cord outdoors. This could result in an electric shock or become a fire hazard.
- Use as short an extension cord as possible.
- Do not use multiple extension cords.

# Starting and Stopping the Engine

- Make sure that when in operation, the extension cord plug and engine block heater cord plug connections are free and clear of water. This could cause an electric shock or fire.
- If the engine block heater cord is under the hood, do not remove the wiring from its original location. Do not close the hood on the extension wiring.
- Park your vehicle in a clean area, clear of combustible materials.
- Firmly connect the engine block heater cord and the extension cord.
- Check the extension cord for heat anywhere when the system has been operating for approximately 30 minutes.
- Unplug and properly stow the system before starting and driving your vehicle. The protective cover seals the terminals of the engine block heater cord plug when not in use.
- Check the engine block heater system for proper operation before winter.

## HOW DOES THE ENGINE BLOCK HEATER WORK

The engine block heater warms the engine coolant. This allows the climate control system to quickly respond. The equipment includes a heater element installed in the engine block and a wire harness. You can connect the system to a grounded 220-240 volt AC electrical source.

**Note:** *The engine block heater is most effective when outdoor temperatures are below 0°F (-18°C).*

## USING THE ENGINE BLOCK HEATER

Make sure the receptacle terminals are clean and dry prior to use. Clean them with a dry cloth if necessary.

The heater uses 0.4 to 1.0 kilowatt-hours of energy per hour of use. The system does not have a thermostat. It achieves maximum temperature after approximately three hours of operation. Using the engine block heater longer than three hours does not improve system performance and unnecessarily uses electricity.

## STOPPING THE ENGINE

### STOPPING THE ENGINE WHEN YOUR VEHICLE IS STATIONARY - VEHICLES WITHOUT: PUSH BUTTON START

1. Shift into park (P).
2. Apply the parking brake.
3. Wait until the engine reaches idle speed.

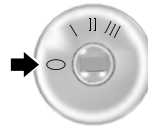

4. Turn the key to position **0**.

### STOPPING THE ENGINE WHEN YOUR VEHICLE IS STATIONARY - VEHICLES WITH: PUSH BUTTON START

1. Shift into park (P).
2. Apply the parking brake.
3. Wait until the engine reaches idle speed.



# Starting and Stopping the Engine

4. Press the push button ignition switch.

## STOPPING THE ENGINE WHEN YOUR VEHICLE IS MOVING - VEHICLES WITHOUT: PUSH BUTTON START



**WARNING:** Switching off the engine when your vehicle is still moving results in a significant decrease in braking assistance. Higher effort is required to apply the brakes and to stop your vehicle. A significant decrease in steering assistance could also occur. The steering does not lock, but higher effort could be required to steer your vehicle. When you switch the ignition off, some electrical circuits, for example airbags, also turn off. If you unintentionally switch the ignition off, shift into neutral (N) and restart the engine.

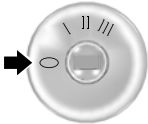

1. Turn the key to position **0**.
2. Shift into neutral and use the brakes to bring your vehicle to a safe stop.
3. Shift into park (P).
4. Apply the parking brake.

## STOPPING THE ENGINE WHEN YOUR VEHICLE IS MOVING - VEHICLES WITH: PUSH BUTTON START



**WARNING:** Switching off the engine when your vehicle is still moving results in a significant decrease in braking assistance. Higher effort is required to apply the brakes and to stop your vehicle. A significant decrease in steering assistance could also occur. The steering does not lock, but higher effort could be required to steer your vehicle. When you switch the ignition off, some electrical circuits, for example airbags, also turn off. If you unintentionally switch the ignition off, shift into neutral (N) and restart the engine.



1. Press and hold the push button ignition switch until the engine stops, or press it three times within two seconds.
2. Shift into neutral and use the brakes to bring your vehicle to a safe stop.
3. Shift into park (P).
4. Apply the parking brake.

## AUTOMATIC ENGINE STOP

### WHAT IS AUTOMATIC ENGINE STOP

Automatic engine stop is a feature that switches the engine off if it has been idling for an extended period to help you save fuel.

# Starting and Stopping the Engine

## HOW DOES AUTOMATIC ENGINE STOP WORK

Automatic engine stop turns the engine off. The ignition also turns off in order to save battery power. Before the engine shuts down, a message appears in the information display showing a timer counting down. If you do not intervene within 30 seconds, the engine shuts down. Another message appears in the information display to inform you that the engine has shut down in order to save fuel. Start your vehicle as you normally do.

## SWITCHING AUTOMATIC ENGINE STOP ON AND OFF - VEHICLES WITH: 2.3 INCH SCREEN/4.2 INCH SCREEN

1. Using the information display controls on the steering wheel, select **Settings**.
2. Select **Vehicle Settings**.
3. Switch **30min Max Idle** on or off.

**Note:** You cannot permanently switch off the automatic shutdown. If you switch it off, it turns on each time you switch the ignition on.

## SWITCHING AUTOMATIC ENGINE STOP ON AND OFF - VEHICLES WITH: 8 INCH SCREEN

1. Press the menu button on the steering wheel to enter the information display main menu.
2. Select **Settings**.
3. Switch **Auto Engine Off** on or off.

**Note:** You cannot permanently switch off the automatic shutdown. If you switch it off, it turns on each time you switch the ignition on.

## OVERRIDING AUTOMATIC ENGINE STOP

You can stop the engine shutdown, or reset the timer, at any point before the 30-second countdown has expired by doing any of the following:

- Pressing the brake pedal or accelerator pedal.
- Pressing the **OK** or **RESET** button during the countdown.

**Note:** You cannot permanently switch off the automatic engine shutdown feature. When you switch it off temporarily, it turns on at the next ignition cycle.

## ACCESSING THE PASSIVE KEY BACKUP POSITION

If you are unable to start your vehicle, locate the backup slot in one of two positions:

### Type One

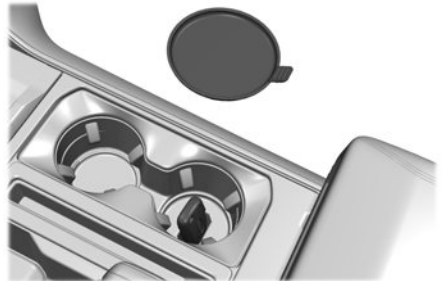



# Starting and Stopping the Engine

## Type Two



**Note:** If your vehicle is equipped with Type One, make sure to place the key properly into the backup slot.

**Note:** If your vehicle is equipped with Type Two, make sure the buttons are facing the rear of the vehicle and the key ring up. Place the key into the backup slot.

With the key in the backup slot, press the brake pedal, then press the push button ignition switch to start your vehicle.

## STARTING AND STOPPING THE ENGINE – TROUBLESHOOTING

### STARTING AND STOPPING THE ENGINE – WARNING LAMPS

#### Malfunction Indicator Lamp



If it illuminates when the engine is running, the on-board diagnostics system is detecting a malfunction of the vehicle emission control system.

If it flashes, engine misfire could be occurring. Increased exhaust gas temperatures could damage the catalytic converter or other vehicle components. Avoid heavy acceleration and deceleration, and have your vehicle checked as soon as possible.

#### Powertrain Warning Lamp



If it illuminates when the engine is running, this indicates a powertrain or four-wheel drive fault. If it flashes when you are driving, immediately reduce the vehicle speed. Avoid heavy acceleration and deceleration, and have your vehicle checked as soon as possible.

If both lamps illuminate when the engine is running, stop your vehicle as soon as it is safe to do so. Continuing to drive your vehicle could cause reduced power or the engine to stop. Switch the ignition off and attempt to restart the engine. Have your vehicle checked as soon as possible.

# Starting and Stopping the Engine

---

## STARTING AND STOPPING THE ENGINE – INFORMATION MESSAGES

<b>Message</b>	<b>Action</b>
Cranking Time Exceeded	Displays if you exceed the starting time limit. You cannot attempt to start the engine for 15 minutes. If you cannot start the engine after 15 minutes passes, have your vehicle immediately checked.
Starting System Fault	Displays if you are unable to start your vehicle with a correctly coded key. The system has detected a fault that requires service. Have your vehicle checked as soon as possible.
No Key Detected	Displays if the system does not detect a valid passive key.

# Starting and Stopping the Engine

## STARTING AND STOPPING THE ENGINE – FREQUENTLY ASKED QUESTIONS - GASOLINE, VEHICLES WITHOUT: PUSH BUTTON START

### Why is the engine idle speed high when I am starting the engine?

The speed at which the engine idles immediately after starting is optimized to minimize vehicle emissions and maximize cabin comfort and fuel economy.

### Why does the engine not crank?

You can only attempt to start the engine for a limited amount of time before the starting system temporarily disables. If you exceed the starting time limit, a message may appear and you cannot attempt to start the engine for at least 15 minutes.

### Why do I experience different driving characteristics?

If you disconnect the battery, your vehicle may exhibit some unusual driving characteristics for approximately 5 mi (8 km) after you reconnect it. This is because the engine management system must realign itself with the engine. You can disregard any unusual driving characteristics during this period.

### Why can I not start the engine?

If you cannot start the engine after 3 attempts, wait 10 seconds and do the following:

1. Fully press the brake pedal or the clutch pedal.

**Note:** Make sure that the parking brake is applied.

**Note:** Make sure that the transmission is in park (P) or neutral (N).

2. Fully press the accelerator pedal and hold it there.



3. Turn the key to position **III** and wait until the engine stops cranking.
4. Release the accelerator pedal.
5. Turn the key to position **III**.

## STARTING AND STOPPING THE ENGINE – FREQUENTLY ASKED QUESTIONS - GASOLINE, VEHICLES WITH: PUSH BUTTON START

### Why is the engine idle speed high when I am starting the engine?

The speed at which the engine idles immediately after starting is optimized to minimize vehicle emissions and maximize cabin comfort and fuel economy.

### Why does the engine not crank?

You can only attempt to start the engine for a limited amount of time before the starting system temporarily disables. If you exceed the starting time limit, a message may appear and you cannot attempt to start the engine for at least 15 minutes.

# Starting and Stopping the Engine

## Why do I experience different driving characteristics?

If you disconnect the battery, your vehicle may exhibit some unusual driving characteristics for approximately 5 mi (8 km) after you reconnect it. This is because the engine management system must realign itself with the engine. You can disregard any unusual driving characteristics during this period.

## Why can I not start the engine?

If you cannot start the engine after 3 attempts, wait 10 seconds and do the following:

1. Fully press the brake pedal or the clutch pedal.

**Note:** Make sure that the parking brake is applied.

**Note:** Make sure that the transmission is in park (P) or neutral (N).

2. Fully press the accelerator pedal and hold it there.
3. Press the push button ignition switch.

**Note:** The engine cranks for a short period of time and then it stops.

4. Release the accelerator pedal.



5. Press the push button ignition switch.

## Why does the system not detect a passive key?

If the system does not detect a passive key and you are unable to start the engine, insert the passive key into the backup position and press the push button ignition switch to start the engine. See **Accessing the Passive Key Backup Position** (page 197).

## STARTING AND STOPPING THE ENGINE – FREQUENTLY ASKED QUESTIONS - DIESEL, VEHICLES WITHOUT: PUSH BUTTON START

### Why is the engine idle speed high when I am starting the engine?

The speed at which the engine idles immediately after starting is optimized to minimize vehicle emissions and maximize cabin comfort and fuel economy.

### Why does the engine not crank?

You can only attempt to start the engine for a limited amount of time before the starting system temporarily disables. If you exceed the starting time limit, a message may appear and you cannot attempt to start the engine for at least 15 minutes.

## Why do I experience different driving characteristics?

If you disconnect the battery, your vehicle may exhibit some unusual driving characteristics for approximately 5 mi (8 km) after you reconnect it. This is because the engine management system must realign itself with the engine. You can disregard any unusual driving characteristics during this period.

## Why can I not start the engine?

If you cannot start the engine, do the following:

# Starting and Stopping the Engine

1. Fully press the brake pedal or the clutch pedal.

**Note:** Make sure that the parking brake is applied.

**Note:** Make sure that the transmission is in park (P) or neutral (N).



2. Turn the key to position III until the engine starts.

## STARTING AND STOPPING THE ENGINE – FREQUENTLY ASKED QUESTIONS - DIESEL, VEHICLES WITH: PUSH BUTTON START

### Why is the engine idle speed high when I am starting the engine?

The speed at which the engine idles immediately after starting is optimized to minimize vehicle emissions and maximize cabin comfort and fuel economy.

### Why does the engine not crank?

You can only attempt to start the engine for a limited amount of time before the starting system temporarily disables. If you exceed the starting time limit, a message may appear and you cannot attempt to start the engine for at least 15 minutes.

### Why do I experience different driving characteristics?

If you disconnect the battery, your vehicle may exhibit some unusual driving characteristics for approximately 5 mi (8 km) after you reconnect it. This is because the engine management system must realign itself with the engine. You can disregard any unusual driving characteristics during this period.

### Why can I not start the engine?

If you cannot start the engine, do the following:

1. Fully press the brake pedal or the clutch pedal.

**Note:** Make sure that the parking brake is applied.

**Note:** Make sure that the transmission is in park (P) or neutral (N).



2. Press the push button ignition switch until the engine starts.

### Why does the system not detect a passive key?

If the system does not detect a passive key and you are unable to start the engine, insert the passive key into the backup position and press the push button ignition switch to start the engine. See **Accessing the Passive Key Backup Position** (page 197).

# Fuel and Refueling

## FUEL AND REFUELING PRECAUTIONS



**WARNING:** Do not overfill the fuel tank. The pressure in an overfilled tank may cause leakage and lead to fuel spray and fire.



**WARNING:** The fuel system may be under pressure. If you hear a hissing sound near the fuel filler inlet, do not refuel until the sound stops. Otherwise, fuel may spray out, which could cause serious personal injury.



**WARNING:** Fuels can cause serious injury or death if misused or mishandled.



**WARNING:** Fuel may contain benzene, which is a cancer-causing agent.



**WARNING:** When refueling always shut the engine off and never allow sparks or open flames near the fuel tank filler valve. Never smoke or use a cell phone while refueling. Fuel vapor is extremely hazardous under certain conditions. Avoid inhaling excess fumes.



**WARNING:** Read and follow all the instructions on the pump island.

Follow these guidelines when refueling:

- Extinguish all smoking materials and any open flames before refueling your vehicle.
- Switch the engine off before refueling.
- Automotive fuels can be harmful or fatal if swallowed. Fuel is highly toxic and if swallowed can cause death or permanent injury. If fuel is swallowed immediately call a physician, even if no symptoms are immediately apparent. The toxic effects of fuel may not be apparent for hours.
- Avoid inhaling fuel vapors. Inhaling fuel vapor can lead to eye and respiratory tract irritation. In severe cases, excessive or prolonged breathing of fuel vapor can cause serious illness and permanent injury.
- Avoid getting fuel in your eyes. If you splash fuel in your eyes, immediately remove contact lenses, if worn, flush with water for 15 minutes and seek medical attention. Failure to seek proper medical attention could lead to permanent injury.
- Fuels can be harmful if absorbed through the skin. If you splash fuel on your skin, clothing or both, promptly remove contaminated clothing and thoroughly wash your skin with soap and water. Repeated or prolonged skin contact causes skin irritation.
- Be particularly careful if you are taking Antabuse or other forms of Disulfiram for the treatment of alcoholism. Breathing fuel vapors could cause an adverse reaction, serious personal injury or sickness. Immediately call a physician if you experience any adverse reactions.

# Fuel and Refueling

## FUEL QUALITY

### SELECTING THE CORRECT FUEL - FLEX FUEL – ETHANOL

Flex fuel vehicles have one of the following identifiers:

- Yellow fuel filler cap.
- Yellow bezel around the fuel filler inlet.
- Yellow fuel filler housing.
- Yellow E85 label on the fuel tank filler door.

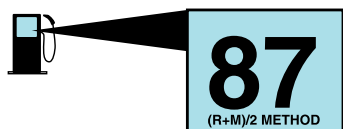

Your vehicle operates on regular unleaded gasoline with a minimum pump (R+M)/2 octane rating of 87 or regular unleaded gasoline blended with a maximum of 85% ethanol (E85).

Some fuel stations, particularly those in high altitude areas, offer fuels posted as regular unleaded gasoline with an octane rating below 87. The use of these fuels could result in engine damage that will not be covered by the vehicle Warranty.

For best overall vehicle and engine performance, premium fuel with an octane rating of 91 or higher is recommended. The performance gained by using premium fuel is most noticeable in hot weather as well as other conditions, for example when towing a trailer. See **Towing a Trailer** (page 328).

Do not be concerned if the engine sometimes knocks lightly. However, if the engine knocks heavily while using fuel with the recommended octane rating, contact an authorized dealer to prevent any engine damage.

We recommend Top Tier detergent gasolines, where available to help minimize engine deposits and maintain optimal vehicle and engine performance.

For additional information, visit [www.toptiergas.com](http://www.toptiergas.com).

**Note:** *Use of any fuel for which the vehicle was not designed can impair the emission control system, cause loss of vehicle performance, and cause damage to the engine which may not be covered by the vehicle Warranty.*

Do not use:

- Diesel fuel.
- Fuels containing kerosene or paraffin.
- Fuels containing more than 85% ethanol or E100 fuel.
- Fuels containing methanol.
- Fuels containing metallic-based additives, including manganese-based compounds.
- Fuels containing the octane booster additive, methylcyclopentadienyl manganese tricarbonyl (MMT).
- Leaded fuel, using leaded fuel is prohibited by law.

The use of fuels with metallic compounds such as methylcyclopentadienyl manganese tricarbonyl, which is a manganese-based fuel additive, will impair engine performance and affect the emission control system.

# Fuel and Refueling

## SELECTING THE CORRECT FUEL - GASOLINE



Your vehicle operates on regular unleaded gasoline with a minimum pump (R+M)/2 octane rating of 87.

Some fuel stations, particularly those in high altitude areas, offer fuels posted as regular unleaded gasoline with an octane rating below 87. The use of these fuels could result in engine damage that will not be covered by the vehicle Warranty.

For best overall vehicle and engine performance, premium fuel with an octane rating of 91 or higher is recommended. The performance gained by using premium fuel is most noticeable in hot weather as well as other conditions, for example when towing a trailer. See **Towing a Trailer** (page 328).

Do not be concerned if the engine sometimes knocks lightly. However, if the engine knocks heavily while using fuel with the recommended octane rating, contact an authorized dealer to prevent any engine damage.

We recommend Top Tier detergent gasolines, where available to help minimize engine deposits and maintain optimal vehicle and engine performance.

For additional information, visit [www.toptiergas.com](http://www.toptiergas.com).

**Note:** Use of any fuel for which the vehicle was not designed can impair the emission control system, cause loss of vehicle performance, and cause damage to the engine which may not be covered by the vehicle Warranty.

Do not use:

- Diesel fuel.
- Fuels containing kerosene or paraffin.
- Fuel containing more than 15% ethanol or E85 fuel.
- Fuels containing methanol.
- Fuels containing metallic-based additives, including manganese-based compounds.
- Fuels containing the octane booster additive, methylcyclopentadienyl manganese tricarbonyl (MMT).
- Leaded fuel, using leaded fuel is prohibited by law.

The use of fuels with metallic compounds such as methylcyclopentadienyl manganese tricarbonyl, which is a manganese-based fuel additive, will impair engine performance and affect the emission control system.

## SELECTING THE CORRECT FUEL FOR COLD WEATHER - DIESEL

**Choosing the Right Fuel: Vehicles Operated Where Ultra Low Sulfur Diesel Fuel Is Required (United States/Canada/Puerto Rico/U.S. Virgin Islands And Other Locales)**

**Note:** Your Warranty will not cover damage caused by using an improper type of fuel or fuel additive.



# Fuel and Refueling

**Note:** Do not blend used engine oil with diesel fuel under any circumstances. Blending used oil with the fuel significantly increases your vehicle's exhaust emissions and reduce engine life due to increased internal wear.

We recommend Top Tier diesel fuel where available to help minimize engine deposits and maintain optimal vehicle and engine performance.

For additional information, visit [www.toptiergas.com](http://www.toptiergas.com).

You should use ultra-low sulfur diesel fuel designated as number 1-D or 2-D with a maximum of 15-ppm sulfur in your diesel vehicle. You can operate your vehicle on diesel fuels containing up to 20% biodiesel, also known as B20. These fuels should meet the ASTM D975 diesel or the ASTM D7467 B6-B20 biodiesel industry specifications. Outside of North America, use fuels meeting EN590 or equivalent local market standard.



Using low-sulfur diesel fuel (16-500 ppm) or high-sulfur diesel fuel (greater than 500 ppm) in your diesel engine will cause certain emission components to malfunction which could also cause the service engine soon light to illuminate indicating an emissions-related concern.

Diesel fuel is adjusted seasonally for cold temperature. For best results at temperatures below 19°F (-7°C), we recommend using a diesel fuel which has been seasonally adjusted for the ambient conditions.

## Choosing the Right Fuel: Vehicles Operated Where Ultra Low Sulfur Diesel Fuel Is Not Required

For the engine to operate reliably on low-sulfur or high-sulfur diesel fuel, the engine must be a factory-built high-sulfur engine (available as a dealer order option for select markets) or an ultra-low sulfur diesel fuel configured engine that has been retrofitted for high-sulfur diesel fuel using authorized dealer service parts. Failure to use retrofit components other than those available through your authorized dealer results in coolant system damage, engine overheating, selective catalyst reduction system or diesel particulate filter damage and possible base engine damage.

Use only a diesel engine configured for use with high-sulfur diesel fuel in markets with diesel fuel that has sulfur content greater than 15 ppm. Using low-sulfur diesel fuel (16–500 ppm) or high-sulfur diesel fuel (greater than 500 ppm) in a diesel engine designed to use only ultra-low sulfur diesel fuel could result in damage to engine emission control devices and the after treatment system, potentially rendering the vehicle inoperable.

Vehicles with engines configured for use with high-sulfur diesel fuel are only available for sale in countries where ultra-low sulfur diesel fuel is generally not available or mandated by the government. Vehicles originally sold in an ultra-low sulfur diesel fuel market that are subsequently exported to non-ultra low sulfur diesel fuel markets will need to be retrofitted at the customer's expense using Ford authorized dealer service parts in order to be reliably operated on non-ultra low sulfur diesel fuel.

# Fuel and Refueling

## Biodiesel



**WARNING:** Do not mix diesel with gasoline, gasohol or alcohol. This could cause an explosion.

**Note:** Do not use home heating oil, agricultural fuel, raw fats and oils, waste cooking greases, biodiesel greater than 20% or any diesel not intended for highway use. Damage to the fuel injection system, engine and exhaust catalyst, and diesel particulate filter can occur if you use an improper fuel. Red dye is used to identify fuels intended for agricultural and non-highway use.

You can operate your vehicle on diesel fuels containing up to 20% biodiesel, also known as B20.

Biodiesel fuel is a chemically converted product from renewable fuel sources, such as vegetable oils, animal fats and waste cooking greases.

To help achieve acceptable engine performance and durability when using biodiesel in your vehicle:

- Confirm the biodiesel content of the fuel to be B20 (20% biodiesel) or less.
- Only use biodiesel fuel of good quality that complies with industry standards.
- Follow the recommended service maintenance intervals. See **General Maintenance Information** (page 622).
- Do not store biodiesel fuel in the fuel tank for more than 1 month.
- Consider changing brands or reducing biodiesel content if you have cold temperature fuel gelling issues or a frequently appearing LOW FUEL PRESSURE message.

Use of biodiesel in concentrations greater than 20% can cause damage to your vehicle, including engine and/or exhaust after-treatment hardware (exhaust catalyst and particulate filter) failures. Concentrations greater than 20% can also cause fuel filter restrictions that could result in a lack of power or damage to fuel system components, including fuel pump and fuel injector failures.

We recommend SAE 5W-40 oil for fuels with greater than 5% biodiesel (B5). For more information about oil change intervals and other maintenance when operating on biodiesel. See **Special Operating Conditions Scheduled Maintenance** (page 636).

Look for a label on the fuel pump to confirm the amount of biodiesel contained in diesel fuel. Ask the service station attendant to confirm the biodiesel content of diesel fuel, if you do not see a label on the fuel pump.

If you plan to park or store your vehicle for more than 1 month, then you should empty your vehicle fuel tank of biodiesel fuel. You should fill the tank with a pure petroleum-based diesel fuel and run your vehicle for a minimum of 30 minutes.

**Note:** Degraded or oxidized biodiesel can damage fuel system seals and plastics and corrode steel parts.

During cold weather, if you have problems operating on biodiesel, you may need to use diesel fuel with lower biodiesel content, try another brand or discontinue the use of biodiesel.

## Diesel Fuel Additives

It should not be necessary to add any aftermarket additives to your fuel if you use a high-quality diesel fuel that conforms to ASTM industry specifications. Aftermarket additives can damage the fuel injector system or engine.

# Fuel and Refueling

Use Motorcraft® cetane booster or an equivalent cetane booster additive if you suspect fuel has low cetane. Use Motorcraft® anti-gel and performance improver or an equivalent additive if there is fuel gelling.

Do not use alcohol-based additives to improve cetane quality, to prevent fuel gelling or any other use. The use of alcohol additives could result in damage to the fuel injectors and system.

Your Warranty may not cover repairs needed to correct the effects of using an aftermarket product that does not meet our specifications in your fuel.

## SWITCHING BETWEEN E85 AND GASOLINE

We do not recommend repeatedly alternating between E85 and gasoline. If you switch from using E85 to gasoline, or from gasoline to E85, add as much fuel as possible, at least half a tank. Drive your vehicle immediately for a minimum of 5 mi (8 km) to allow it to adapt to the change in ethanol concentration. If you use E85 exclusively, we recommend that you fill the fuel tank with regular unleaded gasoline at each scheduled oil change.

## RUNNING OUT OF FUEL

### FILLING A PORTABLE FUEL CONTAINER



**WARNING:** Flow of fuel through a fuel pump nozzle can produce static electricity. This can cause a fire if you are filling an ungrounded fuel container.

Use the following guidelines to avoid electrostatic charge build-up, which can produce a spark, when filling an ungrounded fuel container:

- Only use an approved fuel container to transfer fuel to your vehicle. Place the container on the ground when filling it.
- Do not fill a fuel container when it is inside your vehicle (including the cargo area).
- Keep the fuel pump nozzle in contact with the fuel container when filling it.
- Do not use a device that holds the fuel pump nozzle lever in the fill position.

## ADDING FUEL FROM A PORTABLE FUEL CONTAINER



**WARNING:** Do not insert the nozzle of a fuel container or an aftermarket fuel funnel into the fuel filler neck. This may damage the fuel system filler neck or its seal and cause fuel to run onto the ground.



**WARNING:** Do not pry open the fuel tank filler valve. This could damage the fuel system. Failure to follow this instruction could result in fire, personal injury or death.



**WARNING:** Do not dispose of fuel in the household refuse or the public sewage system. Use an authorized waste disposal facility.

When refueling the vehicle fuel tank from a fuel container, do the following:

1. Fully open the fuel filler door.
2. Turn the fuel filler cap counterclockwise and remove it.
3. Add fuel to your vehicle from the fuel container.

# Fuel and Refueling

- To replace the fuel filler cap, turn it clockwise until you feel a strong resistance and it clicks.
- Fully close the fuel filler door.

**Note:** If your vehicle runs out of fuel add a minimum of 1.3 gal (5 L) of fuel to restart the engine.

**Note:** You may need to switch the ignition from off to on several times after refueling to allow the fuel system to pump the fuel from the tank to the engine. When restarting, cranking time takes a few seconds longer than normal.

## REFUELING

### REFUELING SYSTEM OVERVIEW

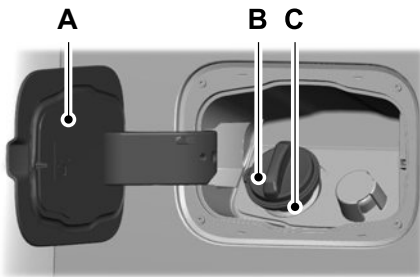

- A Fuel filler door.
- B Fuel tank filler valve.
- C Fuel tank filler pipe.

## REFUELING YOUR VEHICLE

**WARNING:** When refueling always shut the engine off and never allow sparks or open flames near the fuel tank filler valve. Never smoke or use a cell phone while refueling. Fuel vapor is extremely hazardous under certain conditions. Avoid inhaling excess fumes.

**WARNING:** Fuel vapor burns violently and a fuel fire can cause severe injuries.

**WARNING:** The fuel system may be under pressure. If you hear a hissing sound near the fuel filler inlet, do not refuel until the sound stops. Otherwise, fuel may spray out, which could cause serious personal injury.

**WARNING:** Keep children away from the fuel pump. Never let children pump fuel.

**WARNING:** Do not pry open the fuel tank filler valve. This could damage the fuel system. Failure to follow this instruction could result in fire, personal injury or death.

**WARNING:** Stay outside your vehicle and do not leave the fuel pump unattended when refueling your vehicle.

**WARNING:** Do not remove the fuel pump nozzle from its fully inserted position when refueling.

**WARNING:** Stop refueling when the fuel pump nozzle automatically shuts off for the first time. Failure to follow this will fill the expansion space in the fuel tank and could lead to fuel overflowing.

# Fuel and Refueling

**WARNING:** Do not overfill the fuel tank. The pressure in an overfilled tank may cause leakage and lead to fuel spray and fire.

**WARNING:** Wait at least five seconds before removing the fuel pump nozzle to allow any residual fuel to drain into the fuel tank.

1. Fully open the fuel filler door.
2. Select the correct fuel pump nozzle for your vehicle.

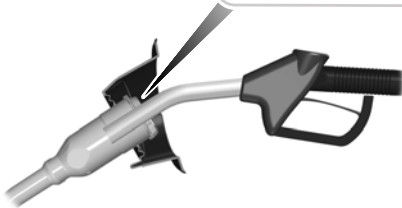
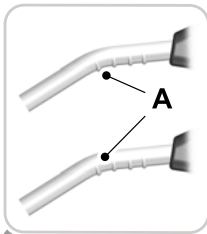

3. Insert the fuel pump nozzle up to the first notch. Keep the fuel pump nozzle resting on the fuel tank filler pipe.

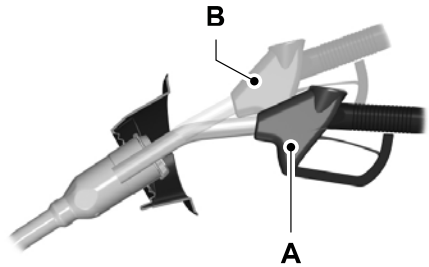

4. Hold the fuel pump nozzle in position A when refueling. Holding the fuel pump nozzle in position B can affect the flow of fuel and shut off the fuel pump nozzle before the fuel tank is full.

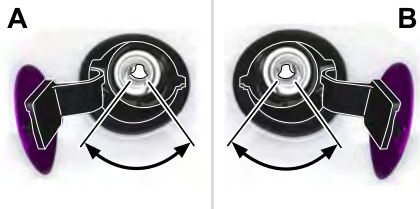

5. Operate the fuel pump nozzle within the area shown. Refer to A for left hand drive or B for right hand drive.

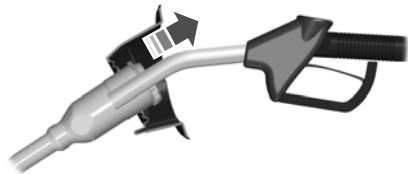

6. When the pump shuts off, wait five seconds, then raise the fuel pump nozzle and slowly remove it.
7. Fully close the fuel filler door.

# Fuel and Refueling

**Note:** Do not attempt to start the engine if you have filled the fuel tank with incorrect fuel. Incorrect fuel use could cause damage not covered by the vehicle Warranty. Have your vehicle immediately checked.

## FUEL TANK CAPACITY

### Advertised Capacity

The advertised capacity is the maximum amount of fuel that you can add to the fuel tank after running out of fuel. Included in the advertised capacity is an empty reserve. The empty reserve is an unspecified amount of fuel that remains in the fuel tank when the fuel gauge indicates empty.

**Note:** The amount of fuel in the empty reserve varies and should not be relied upon to increase driving range.

## FUEL AND REFUELING – TROUBLESHOOTING

### FUEL AND REFUELING – WARNING LAMPS



If it illuminates when you are driving, refuel as soon as possible.

## FUEL AND REFUELING – INFORMATION MESSAGES

Message	Action
Check Fuel Cap	You may not have installed the fuel filler cap properly. At the next opportunity, safely pull off of the road, remove the fuel filler cap, align the cap properly and reinstall it.

# Diesel Particulate Filter

## WHAT IS THE DIESEL PARTICULATE FILTER

The diesel particulate filter is part of your vehicle's emissions system and filters harmful diesel particulates from the exhaust gas.

## HOW DOES THE DIESEL PARTICULATE FILTER WORK

The diesel particulate filter reduces carbon emissions by trapping exhaust particles before they reach the tailpipe. The system must periodically clean the exhaust particles that gather inside the filter. This is carried out in three ways, passive regeneration, active regeneration and manual regeneration.

### Passive Regeneration

In passive regeneration, the normal exhaust system temperature cleans the filter by oxidizing the soot. Cleaning occurs during normal vehicle operating conditions due to driving patterns.

### Active Regeneration

Once the diesel particulate filter is full, active regeneration raises the exhaust temperature to eliminate the particles. During cleaning, the particles convert to harmless gasses.

When the engine control module detects that the diesel particulate filter is nearly full of particulates, and you are not operating your vehicle in a manner to allow effective regeneration, messages appear in the information display as a reminder for you to drive your vehicle in order to clean the diesel particulate filter. If you drive your vehicle in a manner to allow effective regeneration, the information display shows a cleaning exhaust filter message.

## DIESEL PARTICULATE FILTER PRECAUTIONS



**WARNING:** Do not park or idle your vehicle over dry leaves, dry grass or other combustible materials. The regeneration process creates very high exhaust gas temperatures and the exhaust will radiate a considerable amount of heat during and after regeneration and after you have switched the engine off. This is a potential fire hazard.



**WARNING:** When the **Exhaust Filter Cleaning** message appears in the information display, do not park near flammable materials, vapors or structures until filter cleaning is complete.



**WARNING:** The normal operating temperature of the exhaust system is very high. Never work around or attempt to repair any part of the exhaust system until it has cooled. Use special care when working around the diesel oxidation catalytic converter or the diesel particulate filter. The diesel oxidation catalytic converter and the diesel particulate filter heat up to very high temperatures after only a short period of engine operation and remain hot after you switch the engine off.

**Note:** *Avoid running out of fuel.*

**Note:** *During regeneration at low speed or engine idle, you may smell a hot metallic odor and could notice a clicking metallic sound. This is due to high temperatures reached during regeneration and is normal.*

**Note:** *Changes in the engine or exhaust sound may be heard during the regeneration process.*

# Diesel Particulate Filter

Failure to perform active or manual regeneration when instructed could result in a clogged diesel particulate filter. If the diesel particulate filter fills beyond the regeneration threshold, your vehicle disables the ability for active and manual regeneration. This could result in irreversible damage your vehicle Warranty may not cover.

## DIESEL PARTICULATE FILTER REQUIREMENTS

The diesel particulate filter on your vehicle requires periodic regeneration to maintain its correct function.

If your journeys meet one of the following conditions:

- You drive only short distances.
- You frequently switch the ignition on and off.
- Your journeys contain a high level of acceleration and deceleration.

You must carry out occasional trips with the following conditions to assist the regeneration process:

- Drive your vehicle in more favorable conditions, which you will find at higher vehicle speeds in normal driving, on a main road or freeway for a minimum of 20 minutes. This drive may include short stops that will not affect the regeneration process.
- Avoid prolonged idling and observe speed limits and road conditions.
- Do not switch the ignition off.
- Select a suitable gear to ideally maintain engine speed between 1500 and 3000 RPM.

## DIESEL PARTICULATE FILTER MANUAL REGENERATION

### WHAT IS DIESEL PARTICULATE FILTER MANUAL REGENERATION

Diesel particulate filter manual regeneration allows you to manually start regeneration of the diesel particulate filter at idle to clean the filter.

**Note:** *If you are not sure whether your vehicle has this feature, contact your authorized dealer.*

### DIESEL PARTICULATE FILTER MANUAL REGENERATION PRECAUTIONS

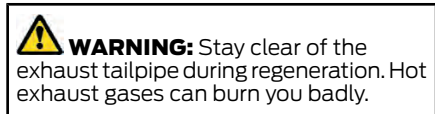

You may not be able to use manual regeneration if the service engine soon warning lamp appears in the information display.

**Note:** *During the use of manual regeneration, you may observe a light amount of white smoke. This is normal.*

### DIESEL PARTICULATE FILTER MANUAL REGENERATION REQUIREMENTS

You can use the manual regeneration feature when a message appears in the information display and you are not able to drive in a manner that allows effective automatic active regeneration or if you choose to manually start the regeneration of the diesel particulate filter while the vehicle is idle.



# Diesel Particulate Filter

Before you start manual regeneration, do the following:

- Shift into park (P) and apply the parking brake, on stable, level ground.
- Park your vehicle outside of any structure.
- Park your vehicle 10–15 ft (3–5 m) away from any obstructions and away from materials that can easily combust or melt, for example paper, leaves, petroleum products, fuels, plastics and other dry organic material.
- Make sure there is a minimum of 1/8 tank of fuel.
- Make sure all fluids are at proper levels.

## DIESEL PARTICULATE FILTER MANUAL REGENERATION LIMITATIONS

You cannot use manual regeneration until the diesel particulate filter load percentage has reached 100%. The diesel particulate filter load percentage fluctuates up and down when driving your vehicle due to active and passive regenerations.

If your vehicle is operated with significant stationary operation, low speed drive cycles less than 25 mph (40 km/h), short drive cycles, drive time less than 15 minutes or the vehicle does not fully warm up, passive and active regeneration may not sufficiently clean the diesel particulate filter system.

Aftermarket devices or modifications to the exhaust system may reduce the effectiveness of the exhaust system as well as cause damage to the exhaust system or engine. This may also degrade vehicle performance and could lead to engine damage that may not be covered by the vehicle Warranty.

## STARTING DIESEL PARTICULATE FILTER MANUAL REGENERATION

Start with your vehicle engine and when it has reached the normal operating temperature, press the information display control button on the steering wheel. See **Instrument Cluster Display** (page 141).

If the diesel particulate filter is near or at saturation, a message requesting permission to initiate filter cleaning appears in the information display. See **Diesel Particulate Filter – Information Messages** (page 215). Answer yes to this prompt and then follow the next prompts regarding exhaust position required to initiate manual regeneration. Be sure to understand each prompt. If you are not sure what is being asked by each prompt, contact an authorized dealer. The display confirms the operation has started and when it has finished. You can also drive to clean the filter.



When the system is at the point of oversaturation, the service engine warning lamp illuminates and a message appears in the information display. You cannot initiate filter cleaning. You must have your vehicle checked as soon as possible.

Once manual regeneration starts, engine speed increases to approximately 1600 rpm and the cooling fan speed increases. You will hear a change in audible sound due to engine speed and cooling fan speed increases.

It is not necessary to open the hood on the engine compartment. Once manual regeneration completes, the engine speed returns to normal idling. The exhaust system remains very hot for several minutes even after regeneration is complete. Do not reposition the vehicle over materials that could burn until the

# Diesel Particulate Filter

exhaust system has had sufficient time to cool. Depending on the amount of soot collected by the diesel particulate filter, ambient temperature and altitude, manual regeneration lasts approximately 30 minutes.



If there are any issues with the diesel particulate filter system, the engine control system warning lamp and a service engine soon warning lamp illuminate to inform you that your vehicle requires service. Have your vehicle checked as soon as possible.



## DIESEL PARTICULATE FILTER – TROUBLESHOOTING

### DIESEL PARTICULATE FILTER – WARNING LAMPS



If filter service is required, the engine control system warning lamp illuminates in the information display.

### DIESEL PARTICULATE FILTER – INFORMATION MESSAGES

Message	Action
Exhaust Filter Cleaning	Your vehicle has entered the cleaning mode. Various engine actions will raise the exhaust temperature in the Diesel Particulate Filter system to burn off the particles (exhaust soot). After the vehicle burns the particles off, the exhaust temperature will return to normal levels. This message is NORMAL.
Exhaust Filter Overloaded Drive to Clean	The diesel particulate filter is full of particles (exhaust soot) and you are not operating the vehicle in a manner that allows normal cleaning. Drive the vehicle above 30 mph (48 km/h) until the message turns off.
Exhaust Filter Overloaded Clean Now	
Exhaust Filter at Limit Clean Now	The diesel particulate filter is full of particles (exhaust soot) and you are not operating the vehicle in a manner that allows normal cleaning. Drive the vehicle above 30 mph (48 km/h) until the message turns off.
Exhaust Filter at Limit Drive to Clean Now	
Exhaust Filter Drive Complete	Your diesel particulate filter is clean.

# Diesel Particulate Filter

---

<b>Message</b>	<b>Action</b>
Exhaust Filter Cleaned	Your diesel particulate filter is clean (OCR Only).
Exhaust Filter Cleaning Stopped	The manual regeneration process has stopped (OCR Only).
Exhaust Filter Over Limit Service Now	You must have your vehicle serviced by an authorized dealer. Ignoring this warning message could lead to reduced drivability and customer expense, including damage to the diesel particulate filter. Your new vehicle warranty may not cover this damage.

# Selective Catalytic Reduction System

## WHAT IS THE SELECTIVE CATALYTIC REDUCTION SYSTEM

The selective catalytic reduction system helps reduce emission levels of oxides of nitrogen from the exhaust system.

## HOW DOES THE SELECTIVE CATALYTIC REDUCTION SYSTEM WORK

The selective catalytic reduction system injects diesel exhaust fluid into the exhaust system to enable correct selective catalytic reduction system function.

## SELECTIVE CATALYTIC REDUCTION SYSTEM PRECAUTIONS



**WARNING:** Keep diesel exhaust fluid out of reach of children. Avoid contact with skin, eyes or clothing. In case of contact with your eyes, flush immediately with water and get prompt medical attention. In case of contact with your skin, clean immediately with soap and water. If you swallow any diesel exhaust fluid, drink plenty of water, call a physician immediately.



**WARNING:** Only refill the diesel exhaust fluid tank in a well ventilated area. When you remove the diesel exhaust fluid tank filler cap or a diesel exhaust fluid container cap, ammonia vapors may escape. Ammonia vapors can be irritating to skin, eyes and mucous membranes. Inhaling ammonia vapors can cause burning to the eyes, throat and nose and cause coughing and watery eyes.



**WARNING:** Diesel exhaust fluid must be refilled when low or replaced when contaminated or your vehicle speed becomes limited to 50 mph (80 km/h). In these conditions, drive with caution and refill diesel exhaust fluid immediately. If the diesel exhaust fluid becomes empty or contaminated and fluid is not replaced, your vehicle becomes limited to engine idle only once stopped. In these conditions, be cautious where you stop your vehicle because you may not be able to drive long distances or maintain highway speeds until you refill or replace the diesel exhaust fluid.



**WARNING:** Tampering with or disabling the selective catalytic reduction system results in severe vehicle performance limitation including eventual speed limiting to 5 mph (8 km/h).

**Note:** Do not put diesel exhaust fluid in the fuel tank. This can cause damage that your vehicle Warranty may not cover.

Selective catalytic reduction systems are sensitive to contamination of the diesel exhaust fluid. Maintaining the purity of the fluid is important to avoid system malfunctions. If you remove or drain the diesel exhaust fluid tank, do not use the same fluid to refill the tank. The system has a sensor to monitor fluid quality.

# Selective Catalytic Reduction System

Driving without refilling, replacing contaminated diesel exhaust fluid, or having the selective catalytic reduction system repaired results in the following actions as required by the California Air Resources Board (CARB) and the U.S. Environmental Protection Agency (EPA):

- Within a preset distance to empty, speed is limited upon vehicle restart. Prior to this occurring a message appears in the information display.
- Further vehicle operation without refilling or replacing contaminated diesel exhaust fluid causes the engine to enter an idle-only condition. This only occurs upon vehicle refueling, vehicle idling in park for 1 hour, or engine shutdown for 10 minutes or more and is indicated by a message in the information display indicating required actions to resume normal operation. It is required to add a minimum of 1.0 gal (3.8 L) of diesel exhaust fluid to the tank to exit the idle-only condition, but your vehicle is still in the speed-limiting mode until you refill the tank completely.

**Note:** For vehicle speed limiting or idle-only condition, normal vehicle operation resumes when you refill the diesel exhaust fluid tank or repair the contaminated system. If the system is contaminated or inoperative, have your vehicle checked as soon as possible.

## SELECTIVE CATALYTIC REDUCTION SYSTEM REQUIREMENTS



Only use diesel exhaust fluid that is certified by the American Petroleum Institute (API).

You can purchase diesel exhaust fluid at an authorized dealer, or contact roadside assistance for help in finding a retailer that sells diesel exhaust fluid.

**Note:** *Non-certified diesel exhaust fluid use can cause damage that your Warranty may not cover*

## SELECTIVE CATALYTIC REDUCTION SYSTEM GUIDELINES

- Diesel exhaust fluid is non-flammable, non-toxic, colorless and water-soluble liquid.
- In order for the system to operate correctly you must maintain the diesel exhaust fluid level.
- Do not overfill the diesel exhaust fluid tank.
- Diesel exhaust fluid is corrosive.

# Selective Catalytic Reduction System

- Avoid spilling diesel exhaust fluid on painted surfaces, carpeting or plastic components. Immediately wipe away any diesel exhaust fluid that has spilled with a damp cloth and water. If it has already crystallized, use warm water and a sponge.
- Do not store the diesel exhaust fluid bottle in your vehicle. If it leaks it could cause damage to interior components or release an ammonia odor inside your vehicle.
- Do not re-use the diesel exhaust fluid container once it is emptied.
- Store diesel exhaust fluid out of direct sunlight and in temperatures between 23–68°F (-5–20°C).
- The system has a diesel exhaust fluid quality sensor. Dilution of diesel exhaust fluid or use of any other liquid in the selective catalytic reduction system leads to a diesel exhaust fluid system fault, eventually leading to the vehicle only operating in idle-only mode.
- Do not dilute diesel exhaust fluid with water or any other liquid.

## FILLING THE SELECTIVE CATALYTIC REDUCTION SYSTEM TANK

### FILLING THE SELECTIVE CATALYTIC REDUCTION SYSTEM TANK IN COLD WEATHER

Diesel exhaust fluid may freeze if the ambient temperature is below 12°F (-11°C). Your vehicle has a preheating system which allows diesel exhaust fluid to operate below 12°F (-11°C). If you do not use your vehicle for an extended period when the ambient temperature is below 12°F (-11°C), the fluid in the tank may freeze. If the tank is overfilled and the fluid freezes it may cause damage that your Warranty will not cover.

### FILLING THE SELECTIVE CATALYTIC REDUCTION SYSTEM TANK USING A FUEL STATION PUMP

Filling the diesel exhaust fluid tank using a fuel station pump is similar to refueling your vehicle.

1. Fully open the fuel filler door.

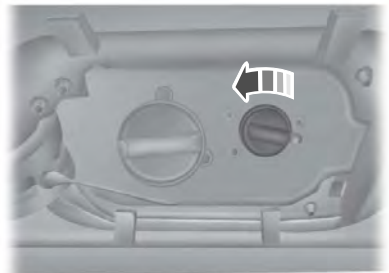

2. Remove the diesel exhaust fluid tank filler cap.

# Selective Catalytic Reduction System

**Note:** The diesel exhaust fluid tank has a blue filler cap.

3. Fully insert the diesel exhaust fluid pump nozzle.

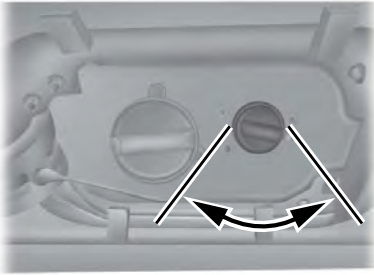

4. Operate the diesel exhaust fluid pump nozzle within the area shown.

**Note:** The pump nozzle shuts off when the tank is full.

5. Slightly raise the diesel exhaust fluid pump nozzle and then slowly remove it.
6. Replace the diesel exhaust fluid tank filler cap. Turn it clockwise until you feel a strong resistance and it clicks.

## FILLING THE SELECTIVE CATALYTIC REDUCTION SYSTEM TANK USING A PORTABLE CONTAINER

The following procedure applies to Motorcraft diesel exhaust fluid or similar fluid containers. Follow the manufacturer's instructions.

1. Fully open the fuel filler door.
2. Remove the diesel exhaust fluid container cap.
3. Place the spout on to the container and tighten it until you feel a strong resistance.

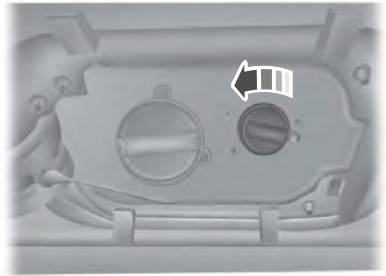

4. Remove the diesel exhaust fluid tank filler cap.

**Note:** The diesel exhaust fluid tank has a blue filler cap.

5. Insert the spout into the filler neck until the seal on the spout fully seats.
6. Pour the fluid into the tank.

**Note:** The fluid stops flowing when the tank is full.

7. Return the container to the vertical position slightly below the diesel exhaust fluid filler neck.
8. Allow any fluid remaining in the spout to drain back into the container.
9. Remove the spout from the diesel exhaust fluid filler neck.
10. Replace the diesel exhaust fluid tank cap. Turn it clockwise until you feel a strong resistance and it clicks.
11. Remove the spout from the diesel exhaust fluid container and replace the cap.

**Note:** If there is diesel exhaust fluid left in the container retain it for later use. The spout is reusable. Wash the spout with clean water prior to storage. Do not use the diesel exhaust fluid spout with any other fluid.

# Selective Catalytic Reduction System

## CHECKING THE SELECTIVE CATALYTIC REDUCTION SYSTEM STATUS

The information display shows a series of messages about the amount of diesel exhaust fluid available. A systems check displays messages indicating the amount of diesel exhaust fluid available or displays a warning message indicating the approximate distance remaining as the fluid in the diesel exhaust fluid tank nears empty. See **Selective Catalytic Reduction System – Information Messages** (page 221).

## DIESEL EXHAUST FLUID CAPACITY AND SPECIFICATION

For filling information please refer to the Capacities and Specifications section of the owner's manual. See **Diesel Exhaust Fluid Capacity and Specification** (page 221).

## SELECTIVE CATALYTIC REDUCTION SYSTEM – INFORMATION MESSAGES

Message	Action
DEF Level Range: XX mi/ km Refill Now	The distance you can travel before depleting the remaining diesel exhaust fluid. Refill as soon as possible.
DEF Level Empty Speed Limited to XX MPH / km/h in XX mi/km	Your diesel exhaust fluid is nearing empty. Your vehicle's top speed will become limited in the displayed distance. You must replenish the diesel exhaust fluid to resume normal operation of your vehicle. See <b>Diesel Exhaust Fluid Capacity and Specification</b> (page 221).
DEF Level Empty Speed Limited to XX MPH/km/h Upon Restart	Your remaining diesel exhaust fluid has depleted. Your speed will be limited upon restart. You must replenish the diesel exhaust fluid to resume normal operation of your vehicle. See <b>Diesel Exhaust Fluid Capacity and Specification</b> (page 221).

## SELECTIVE CATALYTIC REDUCTION SYSTEM – TROUBLESHOOTING

### SELECTIVE CATALYTIC REDUCTION SYSTEM – WARNING LAMPS



As the diesel exhaust fluid level nears empty, the warning symbol displays and a series of tones and messages starting at 500 mi (800 km) remaining before diesel exhaust fluid is depleted. The warning symbol and messages continue until you refill the diesel exhaust fluid tank.

The warning lamp illuminates and a message appears in the information display if the system becomes contaminated or inoperative.



## Selective Catalytic Reduction System

Message	Action
DEF Level Low Speed Limited to XX MPH/km/h	The diesel exhaust fluid is empty. You must replenish the diesel exhaust fluid to resume normal operation of your vehicle. See <b>Diesel Exhaust Fluid Capacity and Specification</b> (page 221).
DEF Level Empty Engine Idled Soon	The selective catalytic reduction system detects low exhaust fluid. The engine will eventually enter into an idle only mode. You must replenish the diesel exhaust fluid to resume normal operation of your vehicle. See <b>Diesel Exhaust Fluid Capacity and Specification</b> (page 221).
DEF Level Empty Engine Idled See Manual	The vehicle will enter into an idle only mode. You must replenish the diesel exhaust fluid to resume normal operation of your vehicle. See <b>Diesel Exhaust Fluid Capacity and Specification</b> (page 221).
DEF Fault Speed Limited to XX MPH/km/h in XX mi/km	The selective catalytic reduction system detects a fault. The vehicle's top speed will become limited in the displayed distance and count down from this point. Have your vehicle checked as soon as possible.
DEF Fault Speed Limited to XX MPH/km/h Upon Restart	The selective catalytic reduction system detects a fault. The vehicle's top speed will become limited upon restarting. Have your vehicle checked as soon as possible.
DEF Fault Speed Limited to XX MPH/km/h	The selective catalytic reduction system detects a fault. The vehicle's top speed is limited. Have your vehicle checked as soon as possible.
DEF Fault Engine Idled Soon	The selective catalytic reduction system detects a fault. The engine will eventually enter into an idle only mode. Have your vehicle checked as soon as possible.

# Catalytic Converter

## WHAT IS THE CATALYTIC CONVERTER

The catalytic converter is part of your vehicle's emissions system and filters harmful pollutants from the exhaust gas.

## CATALYTIC CONVERTER PRECAUTIONS



**WARNING:** Do not park, idle or drive your vehicle on dry grass or other dry ground cover. The emission system heats up the engine compartment and exhaust system, creating the risk of fire.



**WARNING:** The normal operating temperature of the exhaust system is very high. Never work around or attempt to repair any part of the exhaust system until it has cooled. Use special care when working around the catalytic converter. The catalytic converter heats up to a very high temperature after only a short period of engine operation and stays hot after the engine is switched off.

To avoid damaging the catalytic converter:

- Do not crank the engine for more than 10 seconds at a time.
- Do not run the engine with a spark plug lead disconnected.
- Do not push-start or tow-start your vehicle. Use booster cables. See **Jump Starting the Vehicle** (page 380).
- Use the correct fuel. See **Fuel and Refueling** (page 203).
- Do not switch the ignition off when your vehicle is moving.
- Avoid running out of fuel.
- Have the items listed in scheduled maintenance information performed according to the specified schedule.

**Note:** Do not make any unauthorized changes to your vehicle or engine. By law, vehicle owners and anyone who manufactures, repairs, or services a fleet of vehicles are not permitted to intentionally remove an emission control device or prevent it from working.

## CATALYTIC CONVERTER – TROUBLESHOOTING

### CATALYTIC CONVERTER – WARNING LAMPS

Your vehicle has an on-board diagnostics system that monitors the emission control system. If any of the following warning lamps illuminate, this may indicate that the on-board diagnostics system has detected an emission control system malfunction.



Continuing to drive your vehicle may cause reduced power or the engine to stop. Failure to respond to a warning lamp may cause damage that your vehicle Warranty may not cover. Have your vehicle checked as soon as possible.

# Automatic Transmission

## AUTOMATIC TRANSMISSION PRECAUTIONS



**WARNING:** Apply the parking brake, shift into park (P), switch the ignition off and remove the key before you leave your vehicle. Failure to follow this instruction could result in personal injury or death.



**WARNING:** Do not use tow/haul when the road surface is slippery. Failure to follow this instruction could result in the loss of control of your vehicle.



**WARNING:** When your vehicle is stationary, keep the brake pedal fully pressed when shifting gears. Failure to follow this instruction could result in personal injury, death or property damage.



**WARNING:** Do not apply the brake pedal and accelerator pedal simultaneously. Applying both pedals simultaneously for more than a few seconds will limit engine performance, which may result in difficulty maintaining speed in traffic and could lead to serious injury.

## AUTOMATIC TRANSMISSION POSITIONS

### PARK (P)

This position locks the driveline and prevents the wheels from turning. Come to a complete stop before putting your vehicle into and out of park (P).

### REVERSE (R)



**WARNING:** Move the transmission selector lever to reverse (R) only when your vehicle is stationary and the engine is at idle speed.

This position allows your vehicle to move backward. Come to a complete stop before shifting into and out of reverse (R).

### NEUTRAL (N)



**WARNING:** In neutral (N) your vehicle is free to roll.

This position allows your vehicle to roll free. Hold the brake pedal down when in this position.

**Note:** *You can start your vehicle in this position.*

### DRIVE (D)

Drive (D) is the normal driving position, and allows automatic upshifts and downshifts through all available gears.

### MANUAL (M)

To select manual (M) mode, place the gearshift in the manual (M) position.

This position allows you to change gears up or down as preferred using the + or - buttons on the shifter lever.

To return to the normal drive (D) position, move the shifter into the drive (D) position.

## SHIFTING YOUR VEHICLE INTO GEAR

1. Fully press down on the brake pedal.

# Automatic Transmission

2. Move the gearshift lever into the desired gear.
3. When you finish driving, come to a complete stop.
4. Pull lever toward the driver and move the gearshift lever and securely latch it in park (P).

## MANUALLY SHIFTING GEARS

### SHIFTING USING THE BUTTONS ON THE SELECTOR LEVER

Pressing the manual (M) button on the shifter allows you to select the gear you prefer. Only the current gear displays. Press the **+** button to upshift or the **-** button to downshift. Return the transmission to a different gearshift position to deactivate manual control or press manual (M).

Your vehicle has a SelectShift Automatic transmission gearshift lever. This gives you the ability to change gears up or down, without a clutch, as preferred.

**Note:** *To prevent the engine from running at too low an RPM, which could cause it to stall, SelectShift still makes some downshifts if it determines that you have not downshifted in time. Although SelectShift makes some downshifts for you, it still allows you to downshift at any time if it determines that damage to the engine from over-revving does not occur.*

**Note:** *SelectShift does not automatically upshift, even if the engine is approaching the RPM limit. Shift manually by pressing the **+** button.*

**Note:** *Engine damage could occur if you maintain excessive engine revving without shifting.*

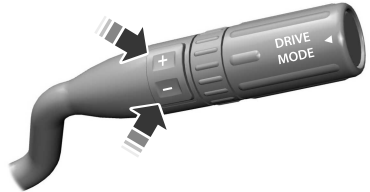

## BRAKE SHIFT INTERLOCK

### WHAT IS BRAKE SHIFT INTERLOCK

Brake shift interlock prevents you from shifting out of park (P) when you have switched the ignition on and not pressed the brake pedal.

### BRAKE SHIFT INTERLOCK PRECAUTIONS



**WARNING:** Do not drive your vehicle until you verify that the stoplamps are working.



**WARNING:** When doing this procedure, you need to take the transmission out of park (P) which means your vehicle can roll freely. To avoid unwanted vehicle movement, always fully apply the parking brake prior to doing this procedure. Use wheels chocks if appropriate.

# Automatic Transmission



**WARNING:** If the parking brake is fully released, but the brake warning lamp remains illuminated, the brakes may not be working properly. Have your vehicle checked as soon as possible.

In the event of an electrical malfunction, it is possible that a fuse has blown or the stoplamps are not working. See **Fuse Precautions** (page 387).

If the vehicle battery has no charge, jump start your vehicle.

## USING BRAKE SHIFT INTERLOCK

### Brake-Shift Interlock

The following procedure allows you to move the gearshift lever from park (P):

1. Apply the parking brake. Switch the ignition key to 1 - 0, then remove the key.
2. Move the steering column to the full down and full rearward position, toward the driver seat.
3. Remove the gearshift lever boot.
4. Place your fingers into the hole where you removed the gearshift lever boot and pull the top half of the shroud up and forward to separate it from the lower half of the shroud. There is a hinge at the forward edge of the top shroud. Roll the top half of the shroud upward on the hinge point, then pull straight rearward toward the driver seat to remove.
5. Remove the top half of the shroud.
6. Remove the three fasteners under the column that secure the lower shroud half to the column.



7. Pull the lock lever into the fully unlocked position and remove the lower shroud cover by pulling the lever handle through the slot in the cover.
8. Apply the brake. Gently lift the override disk and move the gearshift lever into neutral (N).



9. Start your vehicle.

Perform steps 4 through 8 in reverse order to get the shroud back together, making sure to engage the hinge pivots between the upper and lower halves of the shroud. Keep slight pressure in the forward direction as you rotate the halves together.

# Automatic Transmission

---

## **POWER TAKE-OFF (IF EQUIPPED)**

### **HOW DOES THE POWER TAKE-OFF WORK**

Auxiliary equipment called power take-off, or PTO, is often added to the engine or transmission to operate utility equipment. Examples include a wheel-lift for tow trucks, cranes, tools for construction or tire service, and pumping fluids. PTO applications draw auxiliary horsepower from the powertrain, often while the vehicle is stationary. In this condition, there is limited cooling air flow through the radiator and around the vehicle that normally occurs when a vehicle is moving. The aftermarket PTO system installer, having the most knowledge of the final application, is responsible for determining whether additional chassis heat protection or powertrain cooling is required, and alerting the user to the safe and proper operation.

**Note:** *Use of auxiliary equipment that exceeds the maximum Power Take-Off (PTO) load specified in our Truck Body Builders Layout Book can adversely affect the performance of the powertrain system. Refer to the Body Builders Layout Book for instructions about the appropriate installation of additional equipment.*

For additional information, visit [www.fordbbas.com/home](http://www.fordbbas.com/home).

This feature is approved as a stationary mobile power source, within the limits and operating guidelines detailed in our Truck Body Builders Layout Book. For additional information, visit

[www.fordbbas.com/home](http://www.fordbbas.com/home).

### **WHAT IS THE SPLIT SHAFT CAPABILITY**

Split shaft capability is when the output gear connects directly with the engine to power your power takeoff (PTO), anytime the engine is running.

# Four-Wheel Drive (If Equipped)

## HOW DOES FOUR-WHEEL DRIVE WORK

### Using the Electronic Shift On the Fly System (If Equipped)

This four-wheel drive system utilizes a 2-speed Electronic Shift On the Fly (ESOF) transfer case which is also known as a part-time system. This system offers the driver two-wheel drive high, four-wheel drive high, and four-wheel drive low as available modes of operation. When you select either four-wheel drive high or four-wheel drive low, the system provides mechanically locked four-wheel drive power to both the front and rear wheels for use in off-road or slippery conditions such as deep snow, sand or mud. When you select four-wheel drive low, the system provides additional gearing for increased torque multiplication for conditions like deep sand, steep slopes, or pulling heavy objects. Additionally, the system is capable of recreational flat towing by putting the transfer case into a neutral position. See **Recreationally Towing Your Vehicle** (page 384).



For proper operation, make sure that each hub is fully engaged and that both hub locks are set to the same position (both set to lock or both set to auto). To engage lock, turn the hub locks completely clockwise. To engage auto, turn the hub locks completely counterclockwise.

The ESOF four-wheel drive system:

- Provides 4x4 High engagement and disengagement while the vehicle is moving.
- Operates by a rotary control located on the instrument panel that allows you select 4x2, 4x4 High or 4x4 Low operation.
- Uses auto-manual hub locks that can be engaged and disengaged automatically based on the 4x4 mode you select.
- Increases fuel economy when used in the hub lock's recommended auto mode.

**Note:** *Auto-manual hub locks manually lock by rotating the hub lock control from auto to lock.*

## FOUR-WHEEL DRIVE PRECAUTIONS



**WARNING:** Vehicles with a higher center of gravity (utility and four-wheel drive vehicles) handle differently than vehicles with a lower center of gravity (passenger cars). Avoid sharp turns, excessive speed and abrupt steering in these vehicles. Failure to drive cautiously increases the risk of losing control of your vehicle, vehicle rollover, personal injury and death.

## Four-Wheel Drive (If Equipped)



**WARNING:** If the parking brake is fully released, but the brake warning lamp remains illuminated, the brakes may not be working properly. Have your vehicle checked as soon as possible.



**WARNING:** Do not become overconfident in the ability of four-wheel drive vehicles. Although a four-wheel drive vehicle may accelerate better than a two-wheel drive vehicle in low traction situations, it won't stop any faster than two-wheel drive vehicles. Always drive at a safe speed.

Truck and utility vehicles can differ from some other vehicles. Your vehicle could be higher to allow it to travel over rough terrain without getting stuck or damaging underbody components. The differences that make your vehicle so versatile also make it handle differently than an ordinary passenger car. Always maintain steering wheel control, especially in rough terrain. Since sudden changes in terrain can result in abrupt steering wheel motion, make sure you grip the steering wheel from the outside. Do not grip the spokes. Drive cautiously to avoid vehicle damage from concealed objects such as rocks and stumps. Drive slower in strong crosswinds which can affect the normal steering characteristics of your vehicle. Be extremely careful when driving on pavement made slippery by loose sand, water, gravel, snow or ice.

**Note:** Do not use four-wheel drive high or four-wheel drive low mode on dry, hard surfaced roads. Doing so can produce excessive noise, increase tire wear and can damage drive components. Four-wheel drive high or four-wheel drive low modes are for consistently slippery or loose surfaces. Use of four-wheel drive low mode on these surfaces could produce some noise, such as occasional clunks, but should not damage drive components. When transitioning from consistently loose or slippery surfaces, be sure the four-wheel drive systems not mechanically blocked once on dry, hard surfaced roads in two-wheel drive high.

### Parking



**WARNING:** If the parking brake is fully released, but the brake warning lamp remains illuminated, the brakes may not be working properly. Have your vehicle checked as soon as possible.



**WARNING:** Apply the parking brake, shift into park (P), switch the ignition off and remove the key before you leave your vehicle. Failure to follow this instruction could result in personal injury or death.

On some four-wheel drive vehicles, when the transfer case is in the neutral (N) position, the engine and transmission disconnects from the rest of the driveline. Therefore, the vehicle is free to roll even if the automatic transmission is in park (P) or the manual transmission is in gear. Do not leave the vehicle unattended with the transfer case in the neutral (N) position. Always set the parking brake fully and turn off the ignition when leaving the vehicle.



## Four-Wheel Drive (If Equipped)

### FOUR-WHEEL DRIVE LIMITATIONS

Do not use four-wheel drive high or four-wheel drive low mode on dry, hard surfaced roads. Doing so can produce excessive noise, increase tire wear and can damage drive components. four-wheel drive high or four-wheel drive low modes intended for consistently slippery or loose surfaces. Use of four low mode on these surfaces could produce some noise, such as occasional clunks, but should not damage drive components. When transitioning from consistently loose or slippery surfaces, be sure the four-wheel drive systems not mechanically blocked once on dry, hard surfaced roads in two-wheel drive high.

### Operating Four-Wheel Drive with a Spare or Mismatched tires

On four-wheel drive vehicles, the size of the spare tire can affect the four-wheel drive system. If there is a significant difference between the size of the spare tire and the remaining tires, you could have limited four-wheel drive functionality. When driving with the full-size dissimilar spare wheel and tire assembly, do not:

- Exceed 50 mph (80 km/h) with a four-wheel drive mode turned on.
- Turn on a four-wheel drive mode unless the vehicle is stationary.
- Use a four-wheel drive mode on dry pavement.

When driving with the full-size dissimilar spare wheel and tire assembly, four-wheel drive functionality is limited, especially when driving in a mechanically locked four-wheel drive mode. You can experience the following:

- Additional noise from the transfer case or other drive components.
- Difficulty shifting out of a mechanically locked four-wheel drive mode.

Use of a dissimilar spare wheel and tire assembly can lead to impairment of the following:

- Comfort and noise.
- Winter weather driving capability.
- Wet driving capability.
- Four-wheel drive capability.

### SELECTING A FOUR-WHEEL DRIVE MODE

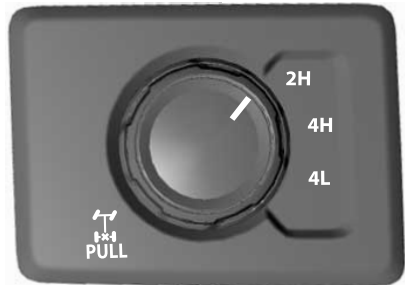

The four-wheel drive mode control is on the instrument panel.

To select a four-wheel drive mode, rotate the four-wheel drive mode control to switch to the desired mode. You can select two-wheel drive high (2H), or four-wheel drive high (4H), at a stop or while driving. Once the shift is complete, the information display then displays the selected four-wheel drive mode. While shifts are in progress, you could see messages in the information display indicating that a shift is in progress or to release the accelerator pedal to improve shift performance.

## Four-Wheel Drive (If Equipped)

**Note:** Do not perform this operation if the rear wheels are slipping or while applying the accelerator pedal.

**Note:** You could hear some noise as the system shifts or engages which is normal.

If the system detects a fault, a warning message appears in the information display. See **Four-Wheel Drive – Information Messages** (page 235).

### Shifting to or from Four-Wheel Drive Low (4L)

To select or exit four-wheel drive low (4L):

1. Bring your vehicle to a speed of 3 mph (5 km/h) or less.
2. Place the transmission in neutral (N).
3. Move the four-wheel drive control to the preferred position.

The information display then displays a message indicating a four-wheel drive shift is in progress. If any of the above shift conditions are not present, the shift won't occur and the information display shows information guiding the driver through the proper shifting procedures. If there is a transfer case tooth blockage Shift Delayed Pull Forward displays in the information display. To alleviate this condition, place the transmission in a forward gear, move your vehicle forward approximately 5 ft (1.5 m), and shift the transmission back to neutral (N) to allow the transfer case to complete the range shift.

**Note:** You could hear some noise as the system shifts or engages which is normal.

If the system detects a fault, a warning message appears in the information display. See **Four-Wheel Drive – Information Messages** (page 235).

### Entering and Exiting Rock Crawl Mode with Tremor Package (If

Equipped)

- To enter rock crawl, your vehicle must be in 4x4 low (4L).
- Press the drive mode button on the shifter column to bring up the information display and select rock crawl mode.
- With the switch in 4x4 low (4L) position, press rock crawl mode again to deactivate it.
- You must first deactivate rock crawl mode to exit four-wheel drive low (4L).

## FOUR-WHEEL DRIVE MODES

### TWO-WHEEL DRIVE HIGH

Two-wheel drive high is for general on-road driving. Power's sent to the rear wheels only.

### FOUR-WHEEL DRIVE HIGH

Four-wheel drive high provides electronically or mechanically locked four-wheel drive power to both the front and rear wheels for use in off-road or winter conditions such as deep snow, sand or mud. This mode is not for use on dry pavement.

### FOUR-WHEEL DRIVE LOW

Four-wheel drive low provides electronically or mechanically locked four-wheel drive power to both the front and rear wheels for use on low traction surfaces, but does so with additional gearing for increased torque multiplication. This mode is only for off-road conditions such as deep sand, steep slopes, or pulling heavy objects.

# Four-Wheel Drive (If Equipped)

## FOUR-WHEEL DRIVE INDICATORS

### Two-wheel Drive High

**2H** Momentarily illuminates when you select two-wheel drive high.

### Four-wheel Drive High

**4H** Continuously illuminates when you select four-wheel drive high.

### Four-wheel Drive Low

**4L** Continuously illuminates when you select four-wheel drive low.

## FOUR-WHEEL DRIVE DRIVING HINTS

### EMERGENCY MANEUVERS

In an unavoidable emergency situation where a sudden sharp turn must be made, remember to avoid over-driving your vehicle (i.e. turn the steering wheel only as rapidly and as far as required to avoid the emergency). Excessive steering can result in loss of vehicle control. Apply smooth pressure to the accelerator pedal or brake pedal when changes in vehicle speed are required. Avoid abrupt steering, acceleration and braking. This could result in an increased risk of vehicle roll over, loss of vehicle control and personal injury. Use all available road surface to bring your vehicle to a safe direction of travel.

In the event of an emergency stop, avoid skidding the tires and do not attempt any sharp steering wheel movements.

If your vehicle goes from one type of surface to another (i.e. from concrete to gravel) there can be a change in the way your vehicle responds to a maneuver, i.e. steering, acceleration or braking.

### DRIVING IN SAND

When driving over sand, try to keep all four wheels on the most solid area of the trail. Avoid reducing the tire pressures but shift to a lower gear and drive steadily through the terrain. Apply the accelerator slowly and avoid excessive wheel slip.

When driving at slow speeds in deep sand under high outside temperatures, use a low gear when possible. Low gear operation can maximize the engine and transmission cooling capability.

Avoid driving at excessive speed. This causes vehicle momentum to work against you and your vehicle could become stuck to the point that assistance may be required from another vehicle. Remember, you may be able to back out the way you came if you proceed with caution.

### DRIVING THROUGH MUD AND WATER



**WARNING:** Do not spin the wheels at over 34 mph (55 km/h). The tires may fail and injure a passenger or bystander.

# Four-Wheel Drive (If Equipped)

## Mud

Be cautious of sudden changes in vehicle speed or direction when you are driving in mud. Even four-wheel drive vehicles can lose traction in slick mud. If your vehicle does slide, steer in the direction of the slide until you regain control of your vehicle. After driving through mud, clean off residue stuck to rotating driveshafts and tires. Excess mud stuck on tires and rotating driveshafts can cause an imbalance that could damage drive components.

## Water

If you must drive through high water, drive slowly. Traction or brake capability may be limited. When driving through water, determine the depth and avoid water higher than the bottom of the hubs. If the ignition system gets wet, your vehicle may stall. Once through water, test the brakes. Wet brakes do not stop your vehicle as effectively as dry brakes. Drying improves by applying light pressure to the brake pedal while moving slowly.

**Note:** *Driving through deep water may damage the transmission. If the front or rear axle is submerged in water, the axle lubricant and power transfer unit lubricant should be checked and changed if necessary.*

## DRIVING ON HILLY OR SLOPING TERRAIN

Although natural obstacles may make it necessary to travel diagonally up or down a hill or steep incline, you should try to drive straight up or straight down.

**Note:** *Avoid turning on steep slopes or hills. A danger lies in losing traction, slipping sideways and possible vehicle roll over. Whenever driving on a hill, determine beforehand the route you can use. Do not drive over the crest of a hill without seeing what conditions are on the other side. Do not drive in reverse over a hill without the aid of an observer.*

When climbing a steep slope or hill, start in a lower gear rather than downshifting to a lower gear from a higher gear once the ascent has started. This reduces strain on the engine and the possibility of stalling.

If your vehicle stalls, do not try to turnaround because this could cause vehicle roll over. It is better to reverse back to a safe location.

Apply just enough power to the wheels to climb the hill. Too much power can cause the tires to slip, spin or lose traction, resulting in loss of vehicle control.

Descend a hill in the same gear you would use to climb up the hill to avoid excessive brake application and brake overheating. Do not descend in neutral. Disengage overdrive or move the transmission selector lever to a lower gear. When descending a steep hill, avoid sudden hard braking as you could lose control. The front wheels have to be turning in order to steer your vehicle.

**Note:** *If your vehicle has anti-lock brakes, apply the brakes steadily. Do not pump the brakes.*

## DRIVING ON SNOW AND ICE



**WARNING:** If you are driving in slippery conditions that require tire chains or cables, then it is critical that you drive cautiously. Keep speeds down, allow for longer stopping distances and avoid aggressive steering to reduce the

# Four-Wheel Drive (If Equipped)

chances of a loss of vehicle control which can lead to serious injury or death. If the rear end of your vehicle slides while cornering, steer in the direction of the slide until you regain control of your vehicle.

Four-wheel drive vehicles have advantages over two-wheel drive vehicles in snow and ice but can skid like any other vehicle. Should you start to slide while driving on snowy or icy roads, turn the steering wheel in the direction of the slide until you regain control.

Avoid sudden applications of power and quick changes of direction on snow and ice. Apply the accelerator slowly and steadily when starting from a full stop. Avoid sudden braking. Although a four-wheel drive vehicle may accelerate better than a two-wheel drive vehicle in snow and ice, it cannot stop any faster as braking occurs at all four wheels. Do not become overconfident as to road conditions.

Make sure you allow sufficient distance between you and other vehicles for stopping. Drive slower than usual and consider using one of the lower gears. In emergency stopping situations, apply the brake steadily. Do not pump the brake pedal. See **Anti-Lock Braking System Limitations** (page 240).

**Note:** *Excessive tire slippage can cause transmission damage.*

## FOUR-WHEEL DRIVE – TROUBLESHOOTING

### FOUR-WHEEL DRIVE – WARNING LAMPS

#### CHECK 4X4



Displays when a four-wheel drive fault is present.

**Note:** *When a system fault is present, the system can typically remain in whichever modes selected prior to the fault condition occurring. It does not default to two-wheel drive in all circumstances. When this warning displays, have your vehicle serviced by an authorized dealer.*

**Note:** *When a four-wheel drive system fault is present, the system will typically remain in whichever four-wheel drive mode was selected prior to the fault condition occurring. It will not default to two-wheel drive in all circumstances. When this warning displays, have your vehicle serviced by an authorized dealer.*

## Four-Wheel Drive (If Equipped)

### FOUR-WHEEL DRIVE – INFORMATION MESSAGES

Message	Action
Check 4x4	A four-wheel drive system fault is present. Contact your authorized dealer as soon as possible.
4x4 Shift in Progress	The four-wheel drive system is making a shift.
For 4x4 LOW Shift to N	Displays when you attempt to switch to four-wheel drive low mode and you do not shift the transmission to neutral (N).
For 4x4 LOW Slow to 3 MPH	Displays when you attempt to switch to four-wheel drive low mode and your vehicle's speed is greater than 3 mph (5 km/h).
For 4x4 LOW Slow to 5 km/h	
To Exit 4x4 LOW Shift to N	Displays when you attempt to switch from four-wheel drive low mode and you do not shift the transmission to neutral (N).
To Exit 4x4 LOW Slow to 3 MPH	Displays when you attempt to switch from four-wheel drive low mode and your vehicle's speed is greater than 3 mph (5 km/h).
To Exit 4x4 LOW Slow to 5 km/h	
Shift Delayed Pull Forward	Displays when there is a transfer case gear tooth blockage while shifting to or from four-wheel drive low mode or to the neutral state. Place the transmission in a forward gear, move your vehicle forward approximately 5 ft (1.5 m), and shift the transmission back to neutral (N) to allow the transfer case to complete the range shift.
Shift to Neutral	Displays when the system requires an additional transmission shift to neutral (N) to complete a transfer case shift.

## Four-Wheel Drive (If Equipped)

---

Message	Action
To Engage 4x4 Slow to 3 MPH	Displays when you command a four-wheel drive shift during conditions which are potentially harmful to the driveline components.
To Engage 4x4 Slow to 5 km/h	
To Engage 4x4 Release Accelerator Pedal	Displays when the four-wheel drive system requests that you release the accelerator pedal to complete a four-wheel drive shift. See <b>Selecting a Four-Wheel Drive Mode</b> (page 230).

# Electronic Locking Differential (If Equipped)

## WHAT IS THE ELECTRONIC LOCKING DIFFERENTIAL

The electronic locking differential is a device housed in the axles, and can provide additional traction when needed.

## HOW DOES THE ELECTRONIC LOCKING DIFFERENTIAL WORK

You can activate the differential electronically and shift it on the fly within the operating speed range. The electronic differential will disengage when the vehicle speed exceeds a set value and it will reengage when the vehicle speed goes below a set value. See **Switching the Electronic Locking Differential On and Off** (page 237). The electronic locking differential is for use in mud, rocks, sand, or any off-road condition where you need maximum traction.

**Note:** *The electronic locking differential is for off-road use only and is not for use on dry pavement. Using the electronic locking differential on dry pavement will result in increased tire wear, noise and vibration.*

## ELECTRONIC LOCKING DIFFERENTIAL PRECAUTIONS

### Operating the Electronic Locking Differential with a Spare or Mismatched Tires

On vehicles with an electronic locking differential, the size of the spare tire can affect performance of the system. If there is a significant difference between the two rear tires, you may have limited electronic locking differential functionality. If the system has difficulty disengaging, release the accelerator pedal and turn the steering wheel in the opposite direction when rolling. We recommend engaging and disengaging the electronic locking differential at a stop when you mount a spare on the rear axle.

## SWITCHING THE ELECTRONIC LOCKING DIFFERENTIAL ON AND OFF - 4X4

Pull the electronic locking differential switch towards you to turn on, to turn off the electronic locking differential push the knob back into the off position.

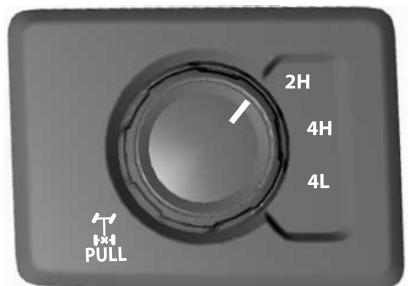



# Electronic Locking Differential (If Equipped)

## 4X4 Rear Electronic Locking Differential Engagement Speed

4WD Mode	Maximum Engagement Speed	Automatic Disengagement Speed	Automatic Re-Engagement Speed
Two-Wheel Drive High (2H)	20 mph (32 km/h)	25 mph (41 km/h)	20 mph (32 km/h)
Four-Wheel Drive High (4H)	20 mph (32 km/h)	25 mph (41 km/h)	20 mph (32 km/h)
Four-Wheel Drive Low (4L)	55 mph (90 km/h)	62 mph (100 km/h)	55 mph (90 km/h)

**Note:** The electronic locking differential may not engage if you press your accelerator pedal during an engagement attempt. A message could display in the instrument display guiding you to release the accelerator pedal.

**Note:** If the electronic locking differential has difficulty disengaging, release the accelerator pedal and turn the steering wheel in the opposite direction while rolling.

**Note:** The electronic locking differential is for off-road use only and is not for use on dry pavement. Using the electronic locking differential on dry pavement results in increased tire wear, noise and vibration.

## SWITCHING THE ELECTRONIC LOCKING DIFFERENTIAL ON AND OFF - 4X2

Rotate the electronic locking differential switch to the on position, to turn off the electronic locking differential turn to the off position.

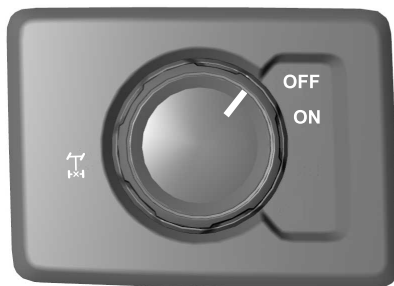

## 4X2 Rear Electronic Locking Differential Engagement Speed and Availability

Maximum Engagement Speed	Automatic Disengagement Speed	Automatic Re-Engagement Speed
20 mph (30 km/h)	25 mph (41 km/h)	20 mph (32 km/h)

# Electronic Locking Differential (If Equipped)

**Note:** The electronic locking differential may not engage if you press your accelerator pedal during an engagement attempt. A message could display in the instrument display guiding you to release the accelerator pedal.

**Note:** If the electronic locking differential has difficulty disengaging, release the accelerator pedal and turn the steering wheel in the opposite direction while rolling.

**Note:** The electronic locking differential is for off-road use only and is not for use on dry pavement. Using the electronic locking differential on dry pavement results in increased tire wear, noise and vibration.

## ELECTRONIC LOCKING DIFFERENTIAL INDICATORS



Once the indicator light illuminates in the information display, both rear wheel axle shafts lock together providing added traction.

If the indicator does not come on, or the indicator turns off while driving, one of the following has occurred:

- The vehicle speed is too high.
- The left and right rear wheel speed difference is too high during an engagement attempt.
- The system has malfunctioned and a message in the information display appears. See your authorized dealer for assistance.
- The vehicle is experiencing an anti-lock brake activation.

If you select the electronic locking differential, but it malfunctions a message appears in the information display. See your authorized dealer for assistance.

**Note:** If the vehicle is experiencing an anti-lock braking event, the electronic locking differential may momentarily disengage.

## ELECTRONIC LOCKING DIFFERENTIAL – TROUBLESHOOTING

### ELECTRONIC LOCKING DIFFERENTIAL – INFORMATION MESSAGES

Message	Description and Action
Check Locking Differential	An electronic locking differential system fault is present. Contact an authorized dealer as soon as possible.
To Engage Locking Differential Slow to XX mph/km/h	You select the electronic locking differential and need to slow to a required speed.
To Engage Locking Differential Release Accelerator Pedal	Release the accelerator pedal in order to engage.

# Brakes

## BRAKE PRECAUTIONS



**WARNING:** Driving your vehicle with the warning lamp on is dangerous. A significant decrease in braking performance may occur. It may take you longer to stop your vehicle. Have your vehicle checked as soon as possible. Driving extended distances with the parking brake engaged can cause brake failure and the risk of personal injury.

Wet brakes result in reduced braking efficiency. Gently press the brake pedal a few times when driving from a car wash or standing water to dry the brakes.

## ANTI-LOCK BRAKING SYSTEM

### ANTI-LOCK BRAKING SYSTEM LIMITATIONS

The anti-lock braking system does not eliminate the risk of crash when:

- You drive too closely to the vehicle in front of you.
- Your vehicle is hydroplaning.
- You take corners too fast.
- The road surface is poor.

**Note:** *If the system activates, the brake pedal could pulse and could travel further. Maintain pressure on the brake pedal.*

## BRAKE OVER ACCELERATOR

In the event the accelerator pedal becomes stuck or entrapped, apply steady and firm pressure to the brake pedal to slow the vehicle and reduce engine power. If you experience this condition, apply the brakes and bring your vehicle to a safe

stop. Move the transmission to park (P), switch the engine off and apply the parking brake. Inspect the accelerator pedal for any interference. If none are found and the condition persists, have your vehicle towed to the nearest authorized dealer.

## LOCATING THE BRAKE FLUID RESERVOIR

See **Under Hood Overview** (page 397).

## CHECKING THE BRAKE FLUID



**WARNING:** Do not use any fluid other than the recommended brake fluid as this will reduce brake efficiency. Use of incorrect fluid could result in the loss of vehicle control, serious personal injury or death.



**WARNING:** Only use brake fluid from a sealed container. Contamination with dirt, water, petroleum products or other materials may result in brake system damage or failure. Failure to adhere to this warning could result in the loss of vehicle control, serious personal injury or death.



**WARNING:** Do not allow the fluid to touch your skin or eyes. If this happens, rinse the affected areas immediately with plenty of water and contact your physician.



**WARNING:** The brake system could be affected if the brake fluid level is below the **MIN** mark or above the **MAX** mark on the brake fluid reservoir.

# Brakes



1. Park your vehicle on a level surface.
2. Look at the brake fluid reservoir to see where the brake fluid level is relative to the **MIN** and the **MAX** marks on the reservoir.

**Note:** To avoid fluid contamination, the reservoir cap must remain in place and fully tight, unless you are adding fluid.

Only use fluid that meets our specifications. See **Brakes** (page 240).

## BRAKE FLUID SPECIFICATION

See **Brake Fluid Specification** (page 241).

## BRAKES – TROUBLESHOOTING

### BRAKES – WARNING LAMPS



If the ABS indicator illuminates when you are driving, this indicates a malfunction. Your vehicle continues to have normal braking without the anti-lock braking system function. See an authorized dealer.

It also momentarily illuminates when you switch the ignition on to confirm the lamp is functional. If it does not illuminate when you switch the ignition on, or begins to flash at any time, have the system checked by an authorized dealer.

### BRAKE



The brake indicator momentarily illuminates when you switch the ignition on to confirm the lamp is functional. It may also illuminate when you apply the parking brake and the ignition is on. If it illuminates when your vehicle is moving, make sure the parking brake is disengaged. If the parking brake is disengaged, this indicates low brake fluid level or a brake system fault. See an authorized dealer.

## BRAKES – FREQUENTLY ASKED QUESTIONS

### Is it normal for my brakes to make noise?

Occasional brake noise is normal. If a metal-to-metal, continuous grinding, or continuous squeal sound is present, the brake lining could be worn-out. Have the system checked by an authorized dealer.

# Brakes

---

**There is an electrical motor sound when I press on the brake pedal or activate the park brake switch. Is this normal?**

Yes, those sounds are the electronic brake booster or the electronic park brake operating.

**Note:** *Brake dust could accumulate on the wheels, even under normal driving conditions. Some dust is inevitable as the brakes wear and does not contribute to brake noise. See **Cleaning Wheels** (page 422).*

# Parking Brake

## APPLYING THE PARKING BRAKE



**WARNING:** Apply the parking brake, shift into park (P), switch the ignition off and remove the key before you leave your vehicle. Failure to follow this instruction could result in personal injury or death.

Apply the parking brake whenever you park your vehicle. Press the pedal downward to set the parking brake. The brake warning lamp in the instrument cluster will illuminate and remains illuminated until you release the parking brake.

If you are parking your vehicle on a grade or with a trailer, press and hold the brake pedal down, then set the parking brake. There may be a little vehicle movement as the parking brake sets to hold the vehicle's weight. This is normal and should be no reason for concern. If needed, press and hold the service brake pedal down, then try reapplying the parking brake. Chock the wheels if required. If the parking brake cannot hold the weight of the vehicle, the parking brake may need service or the vehicle may be overloaded.

## RELEASING THE PARKING BRAKE

To release, pull the brake release lever located at the lower left side of the instrument panel.

## PARKING BRAKE – TROUBLESHOOTING

## PARKING BRAKE – INFORMATION MESSAGES

Message	Action
Check Brake System	The system has detected a fault, contact an authorized dealer as soon as possible.
Brake Fluid Level Low	The brake fluid level is low, inspect the brake system immediately.
Park Brake Engaged	You have set the parking brake and you have driven the vehicle more than 3.1 mph (5 km/h). If the warning stays on after you have released the parking brake, contact an authorized dealer.

# Diesel Engine Exhaust Brake (If Equipped)

## DIESEL ENGINE EXHAUST BRAKE – PRECAUTIONS



**WARNING:** Do not use tow/haul when the road surface is slippery. Failure to follow this instruction could result in the loss of control of your vehicle.



**WARNING:** Do not use diesel engine exhaust braking when the road surface is slippery. Failure to follow this instruction could result in the loss of control of your vehicle.

## USING THE DIESEL ENGINE EXHAUST BRAKE

This feature increases engine braking at higher engine speeds to provide better grade descent control with less brake and transmission wear and tear.

**Note:** Use this when driving downhill and carrying heavy loads or trailering.

Benefits of engine braking are:

- Lower brake temperature.
- Reduced brake fade.
- Longer brake life.
- Improved driving and trailering control.



Press the button on the switch bank next to the audio unit to switch the system on or off.

There are two engine brake modes, manual and automatic.

Braking conditions must be met to use exhaust brake:

- Your vehicle is in a forward gear.
- The engine speed is above 1500 RPM.
- Your foot is off the accelerator.

You can use this feature with tow/haul, or progressive range selection to provide further increased engine braking. The transmission upshifts to prevent the engine from entering the red zone on the tachometer.

## Manual Engine Braking

1. Press the button to switch on manual engine braking.
2. Release the accelerator pedal to maximize engine braking.
3. Apply the brakes. The transmission downshifts to lower gears.

**Note:** The engine braking feature only functions when you release the accelerator.

**Note:** You can shift the transmission to lower gears with progressive range selection (PRS) or manual shifting independent of pressing the brakes.

**Note:** You can also use manual engine braking with cruise control to improve grade descent control.

**Note:** If your vehicle has Adaptive Cruise Control, the speed control system uses the selected engine brake mode, transmission gears, and brakes to maintain the set speed and distance to the vehicle being followed.

## Automatic Engine Braking

1. Press the button twice to switch on automatic engine braking.
2. Release the accelerator or brake pedal. The system remembers your vehicle speed.

# Diesel Engine Exhaust Brake (If Equipped)

---

**Note:** *This feature offers smoother, less aggressive engine braking during downhill descents. It may not apply braking if the vehicle speed is not increasing, although it will apply full engine braking force when needed to prevent acceleration. The system automatically activates the engine brake and, if necessary, downshifts the transmission to lower gears to not exceed your vehicle's set speed when the brake or accelerator were last released.*

## DIESEL ENGINE EXHAUST BRAKE INDICATORS



## DIESEL ENGINE EXHAUST BRAKE – TROUBLESHOOTING

### DIESEL ENGINE EXHAUST BRAKE – WARNING LAMPS

- Illuminates when this feature is switched on and the system is operating properly.
- Flashes when the engine brake is disabled due to a fault or the engine does not meet the required braking conditions.
- Does not illuminate when the switch or indicator is faulty.

You can switch the system on at any time. The braking system becomes active once the braking conditions are met.



# Hill Start Assist

## WHAT IS HILL START ASSIST

Hill Start Assist makes it easier for you to pull away when your vehicle is on a slope without using the parking brake.

## HOW DOES HILL START ASSIST WORK

When the system activates, your vehicle remains stationary for a few seconds after you release the brake pedal. This gives you time to move your foot from the brake pedal to the accelerator pedal. The brakes release when the engine has developed sufficient torque to prevent your vehicle from rolling down the slope.

## HILL START ASSIST PRECAUTIONS



**WARNING:** The system does not replace the parking brake. When you leave your vehicle, always apply the parking brake.



**WARNING:** You must remain in your vehicle when the system turns on. At all times, you are responsible for controlling your vehicle, supervising the system and intervening, if required. Failure to take care may result in the loss of control of your vehicle, serious personal injury or death.



**WARNING:** The system turns off if there is a malfunction or if you excessively rev the engine.

## HILL START ASSIST – TROUBLESHOOTING

## HILL START ASSIST – INFORMATION MESSAGES

Message	Action
Hill Start Assist Not Available	Displays when system is not available. Have your vehicle checked as soon as possible.

# Traction Control

## WHAT IS TRACTION CONTROL

The traction control system helps to avoid drive wheel spin and loss of traction.

## HOW DOES TRACTION CONTROL WORK

If your vehicle begins to slide, the system applies the brakes to individual wheels and, when needed, reduces engine power at the same time. If the wheels spin when accelerating on slippery or loose surfaces, the system reduces engine power in order to increase traction.

## SWITCHING TRACTION CONTROL ON AND OFF



**WARNING:** Operating your vehicle with the traction control disabled could lead to an increased risk of loss of vehicle control, vehicle rollover, personal injury and death.



The traction control system turns on each time you switch the ignition on.

The button for the stability and traction control system is on the instrument panel.

Press and release the button to switch traction control off. The stability control system remains fully active, to switch it off, press and hold the button for a few seconds, then release.

When you switch traction control off, a message and an illuminated icon appear on the instrument cluster.

Press the switch again to turn the traction control system back on to normal operation.

If your vehicle is stuck in mud or snow, switching traction control off may be beneficial as this allows the wheels to spin.

Your vehicle may have MyKey restrictions regarding this feature. See **What Is MyKey** (page 77).

## TRACTION CONTROL INDICATOR

### Stability and Traction Control Indicator



If the indicator does not illuminate when you switch the ignition on, or remains on when the engine is running, this indicates a malfunction. Have your vehicle checked by an authorized dealer as soon as possible.



The traction control off indicator illuminates when you switch the traction control system off, or when an alternative stability control mode is selected that requires the traction control off depending on the drive mode selected.

# Traction Control

---

## TRACTION CONTROL – TROUBLESHOOTING

### TRACTION CONTROL – INFORMATION MESSAGES

<b>Message</b>	<b>Action</b>
Service AdvanceTrac	The system detects a condition that requires service. Contact an authorized dealer as soon as possible.
AdvanceTrac Off	The status of the AdvanceTrac system after you switched it off.
AdvanceTrac On	The status of the AdvanceTrac system after you switched it on.
Traction Control Off	The status of the traction control system after you switched it off.
Traction Control On	The status of the traction control system after you switched it on.

# Stability Control

## HOW DOES STABILITY CONTROL WORK



**WARNING:** Vehicle modifications involving braking system, aftermarket roof racks, suspension, steering system, tire construction and wheel and tire size may change the handling characteristics of your vehicle and may adversely affect the performance of the electronic stability control system. In addition, installing any stereo speakers may interfere with and adversely affect the electronic stability control system. Reducing the effectiveness of the electronic stability control system could lead to an increased risk of loss of vehicle control, vehicle rollover, personal injury and death.



**WARNING:** Remember that even advanced technology cannot defy the laws of physics. It's always possible to lose control of a vehicle due to inappropriate driver input for the conditions. Aggressive driving on any road condition can cause you to lose control of your vehicle increasing the risk of personal injury or property damage. Activation of the electronic stability control system is an indication that at least some of the tires have exceeded their ability to grip the road; this could reduce the operator's ability to control the vehicle potentially resulting in a loss of vehicle control, vehicle rollover, personal injury and death.



**WARNING:** You are responsible for controlling your vehicle at all times. The system is designed to be an aid and does not relieve you of your responsibility to drive with due care and attention. Failure to follow this instruction could result in the loss of control of your vehicle, personal injury or death.

If a driving condition activates either the stability control or traction control you may experience the following conditions:

- The stability and traction control light flashes.
- Your vehicle slows down.
- Reduced engine power.

The stability control system has several features built into it to help you maintain control of your vehicle:

### Electronic Stability Control

Electronic stability control enhances your vehicle's ability to prevent skids or lateral slides by applying brakes to one or more of the wheels individually and, if necessary, reducing engine power.

### Roll Stability Control

Roll stability control enhances your vehicle's ability to prevent rollovers by detecting your vehicle's roll motion and the rate at which it changes by applying the brakes to one or more wheels individually.

### Curve Control

Curve control enhances your vehicle's ability to follow the road when cornering severely or avoiding objects in the roadway. Curve control operates by reducing engine power and, if necessary, applying brakes to one or more of the wheels individually.

# Stability Control

## Side Wind Stabilization

Side wind stabilization is an advanced feature that works by carefully applying the brakes on one side of the vehicle to reduce the effect of a side wind gust on the vehicle's path.

## Torque Vectoring by Brakes

Torque vectoring control applies brake torque on the inner driven wheel in a curve for better traction to avoid an understeer, or oversteer situation. Unlike electronic stability control, enhanced torque vectoring control does not slow the vehicle. It helps control excessive wheel slip and gives the vehicle improved cornering agility.

## Traction Control

Traction control enhances your vehicle's ability to maintain traction of the wheels by detecting and controlling wheel spin. See **What Is Traction Control** (page 247).

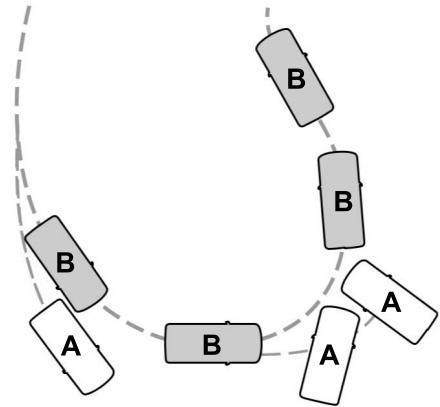

- A Vehicle without stability control skidding off its intended route.
- B Vehicle with stability control maintaining control on a slippery surface.

## SWITCHING STABILITY CONTROL ON AND OFF

The system turns on each time you switch the ignition on.

You can switch the electronic stability control system off by pressing and holding the ESC off button for over 5 seconds, or you can press the button again to switch the system on.

Shifting the transmission into reverse (R) will disable the system.

You can switch the traction control system off or on independently. See **Switching Traction Control On and Off** (page 247).

# Stability Control

## Stability Control and Traction Control with Roll Stability Control

	<b>Stability Control OFF Light</b>	<b>Roll Stability Control<sup>3</sup></b>	<b>Electronic Stability Control<sup>3</sup></b>	<b>Traction Control System<sup>3</sup></b>
Default at start-up	Illuminated during bulb check	Enabled	Enabled <sup>3</sup>	Enabled
Button pressed momentarily	illuminated	Enabled	Enabled <sup>3</sup>	Disabled <sup>1</sup>
Button Pressed and held for 5 - 15 seconds	illuminated	Enabled	Disabled <sup>2</sup>	Disabled <sup>1</sup>
Button not pressed and transfer case is switched to 4x4 Low or put into Rock Crawl Mode	illuminated	Enabled	Disabled	Disabled <sup>1</sup>

<sup>1</sup> The Traction Control system can still be enabled but with tighter or looser thresholds.

<sup>2</sup> When you press and hold the button, a progress bar will display to show the button hold time progress.

<sup>3</sup> Functions can vary depending on what selectable drive mode the vehicle is currently in.

## STABILITY CONTROL INDICATOR



If it does not illuminate when you switch the power on, or remains on, this indicates a malfunction.

Have your vehicle checked by an authorized dealer as soon as possible.

# Trail Control (If Equipped)

## WHAT IS TRAIL CONTROL



**WARNING:** The system does not control speed in low traction conditions or extremely steep slopes. The system is designed to be an aid and does not relieve you of your responsibility to drive with due care and attention. Failure to follow this instruction could result in personal injury.

Trail control lets you focus on steering during low-speed and off-road use by controlling your vehicle's acceleration and braking to maintain the speed that you set.

You may hear a noise from the anti-lock brake system pump motor when you use the system. This is normal.

## SWITCHING TRAIL CONTROL ON AND OFF



Press the button.

The system switches off if you press the button again or exceed 40 mph (64 km/h).

## SETTING THE TRAIL CONTROL SPEED

**Note:** The buttons are located on the steering wheel.

Drive to your preferred speed.

**SET+**

Press button to increase the set current speed.

**SET-**

Press button to decrease the set current speed.

**Note:** The indicator changes color.

You can adjust the set speed in small or large increments. Press the toggle button upward or downward once to adjust the set speed in small increments. Press and hold the toggle button upward or downward to adjust the set speed in large increments.

You can also adjust the set speed by braking.

**Note:** Pressing the brake pedal does not switch off the system.

## CANCELING THE SET SPEED

**CNCL**

Press the button.

## TRAIL CONTROL INDICATORS



# Trail Control (If Equipped)

## TRAIL CONTROL – TROUBLESHOOTING

### TRAIL CONTROL – INFORMATION MESSAGES

Message	Details
Reduce Speed To Enter Trail Control	Displays when you must reduce your vehicle speed to use trail control.
Trail Control Not Available with Park Brake Applied	Displays when you must release the park brake to use trail control.
Trail Control Not Available While Pro Trailer Backup Assist™ Active	Displays when you must switch off the trailer backup assist to use trail control.
Trail Control Enabled Use SET Button to Set Speed	Displays when you successfully enabled trail control and can set a speed with the Set+ or Set- control.
Trail Control Off Driver Resume Control	Displays when a system fault has occurred when trail control was active and the driver must resume control.
Trail Control Off	Displays when the system has turned off.
Trail Control Fault See Manual	Displays when a system fault is present. See the trail control section in your Owner's Manual. See your authorized dealer for diagnosis.
Trail Control To Activate Select Gear	Displays when you must be in drive (D), neutral (N) or reverse (R) to use trail control.
Trail Control Not Available with Cruise Control Active	Displays when you must switch the cruise control off to use trail control.
Trail Control Not Available with Driver Door Open	Displays when you must close the driver door to use trail control.
Set Trail Control to 1 MPH to Aid in Getting Unstuck in Sand	Displays when the system detects you may be stuck in sand and recommends using trail control on to the lowest set speed. Doing this could slowly pull sand under the tires to free the vehicle.
Set Trail Control to 2 km/h to Aid in Getting Unstuck in Sand	
Descent Control Now Active Press Trail Control Switch To Exit	Due to some driver action, Trail Control propulsion was turned off but the vehicle will still brake if descending a hill. The driver must press the Trail Control switch to turn the feature OFF, they can then turn it back on.
Trail Control Not Available with Seatbelt Off	Displays when you must have the seatbelt on to use trail control.



# Hill Descent Control (If Equipped)

## WHAT IS HILL DESCENT CONTROL

Hill descent control allows the driver to set and maintain vehicle speed while descending steep slopes in various surface conditions.

## HOW DOES HILL DESCENT CONTROL WORK

Hill descent control can maintain vehicle speeds on downhill slopes between 2–20 mph (3–32 km/h). Above 20 mph (32 km/h), the system remains on but the descent speed cannot be set or maintained.

**Note:** *The system does not function below 2 mph (3 km/h).*

The system requires a cool down interval after a period of sustained use. Hill descent control provides a warning in the message center and a tone sounds when the system is about to disengage for cooling. At this time, manually apply the brakes as needed to maintain descent speed.

**Note:** *The amount of time that the system can remain active before cooling varies with conditions.*

## HILL DESCENT CONTROL PRECAUTIONS



**WARNING:** The system does not control speed in low traction conditions or extremely steep slopes. The system is designed to be an aid and does not relieve you of your responsibility to drive with due care and attention. Failure to follow this instruction could result in personal injury.



**WARNING:** Hill descent control cannot control descent in all surface conditions and circumstances, such as ice or extremely steep grades. Hill descent control is a driver assist system and cannot substitute for good judgment by the driver. Failure to do so may result in loss of vehicle control, crash or serious injury.



**WARNING:** The system does not replace the parking brake. When you leave your vehicle, always apply the parking brake and shift the transmission into park (P) for automatic transmission or first gear for manual transmission.

## SWITCHING HILL DESCENT CONTROL ON AND OFF



Press the button on the instrument panel. A light illuminates and a tone sounds when the system is active.

## SETTING THE HILL DESCENT SPEED

To increase or decrease the descent speed, press the accelerator or brake pedal, or use the SET + and SET - buttons on the steering wheel. Once you reach the preferred speed remove your feet from the pedals.

## HILL DESCENT CONTROL INDICATOR



Illuminates when you switch hill descent control on.

## Hill Descent Control (If Equipped)

---

### HILL DESCENT CONTROL – TROUBLESHOOTING

#### HILL DESCENT CONTROL – INFORMATION MESSAGES

<b>Message</b>	<b>Action</b>
For Hill Descent Reduce Speed XX MPH/km/h or Less	Your vehicle speed requirement for off-road mode entry has not been met.
For Hill Descent Select Gear	You need to select a transmission gear for hill descent mode.
Hill Descent Driver Resume Control	Hill descent control mode is deactivated and you must resume control.
Hill Descent Control Fault	A hill descent system fault is present.
Hill Descent Control Off System Cooling	The hill descent system is cooling due to overuse.
Hill Descent Control not available with Cruise Control Active	The hill descent system cannot activate while Cruise Control is actively controlling speed.

# Steering

## HYDRAULIC POWER STEERING

### HYDRAULIC POWER STEERING GUIDELINES

To help prevent damage to the power steering system:

- Do not hold the steering wheel at its furthest turning points for more than three to five seconds when the engine is running.
- Avoid continuously steering back and forth with elevated engine RPM as this may overheat the system. If trying to free a stuck vehicle, pause between attempts to allow the power steering system to cool or seek assistance. Typical steering and driving maneuvers allow the system to cool.
- Do not operate the vehicle if the power steering pump fluid level is below the MIN mark on the reservoir.
- Some noise is normal during operation. If excessive, check for low power steering pump fluid level before seeking service by your dealer.
- Heavy or uneven efforts may be caused by low power steering fluid. Check for low power steering pump fluid level before seeking service by your dealer.
- Do not fill the power steering pump reservoir above the MAX mark on the reservoir, as this may result in leaks from the reservoir.

If the power steering system breaks down or if you switch the engine off, you can steer the vehicle manually, but it takes more effort.

If you have any steering components serviced or replaced, install new fasteners. Many fasteners have coatings with thread adhesive, or have prevailing torque features you cannot reuse. Do not reuse a bolt or nut. Torque fasteners to specifications.

### Steering Tips

If the steering wanders or pulls, check for:

- An improperly inflated tire.
- Uneven tire wear.
- Loose or worn suspension components.
- Loose or worn steering components.
- Improper vehicle alignment.

**Note:** *A high crown in the road or high crosswinds may also make the steering seem to wander or pull.*

### Electronic Torque Overlay Steering

(If Equipped)



**WARNING:** The electric power steering system has diagnostic checks that continuously monitor the system. If a fault is detected, a message displays in the information display. Stop your vehicle as soon as it is safe to do so. Switch the ignition off. After at least 10 seconds, switch the ignition on and watch the information display for a steering system warning message. If a steering system warning message returns, have the system checked as soon as possible.



**WARNING:** If the system detects an error, you may not feel a difference in the steering, however a serious condition may exist. Have your vehicle checked as soon as possible. Failure to do so may result in loss of steering control.

# Steering

The electronic torque overlay steering system adds supplemental steering assist to the hydraulic gear when needed, dependent on vehicle conditions such as vehicle speed, steering wheel angle, and steering wheel torque. The hydraulic steering system provides the majority of steering assistance. The electronic torque overlay enables features such as pro trailer backup assistance and lane departure warning.

If your vehicle loses electrical power while you are driving, your vehicle loses electric power steering assistance. The steering system still operates, and you can steer your vehicle with hydraulic assist. Steering your vehicle with only hydraulic assist requires more effort.

Extreme continuous steering may increase the effort required for you to steer your vehicle. This increased effort prevents overheating and permanent damage to the steering system. You do not lose the ability to steer your vehicle manually. Typical steering and driving maneuvers allow the system to cool and return to normal operation.

## **Adaptive Learning (If Equipped)**

The electronic power steering system adaptive learning helps correct road irregularities and improves overall handling and steering feel. It communicates with the brake system to help operate advanced stability control and accident avoidance systems. Whenever the battery is disconnected or a new battery installed, you must drive your vehicle a short distance before the system relearns the strategy and reactivates all systems.

## **LOCATING THE HYDRAULIC POWER STEERING FLUID RESERVOIR**

The hydraulic power steering fluid reservoir is found in the engine compartment. See **Under Hood Overview** (page 397).

## **CHECKING THE HYDRAULIC POWER STEERING FLUID**

Check the power steering fluid. See **Scheduled Maintenance** (page 622). If adding fluid is necessary, use only MERCON LV ATF.

Check the fluid level when it is at ambient temperature.

1. Check the fluid level in the reservoir. It should be between the MIN and MAX range. Do not add fluid if the level is within this range.
2. If the fluid level is low, add fluid to bring the fluid level up to between the MIN and MAX range.
3. Switch the engine on.
4. While the engine idles, turn the steering wheel left and right several times.
5. Switch the engine off.
6. Recheck the fluid level in the reservoir. Do not add fluid if the level is between the MIN and MAX range.
7. If the fluid is low, add fluid in small amounts, continuously checking the level until it is between the MIN and MAX range. For proper fluid type, See **Capacities and Specifications** (page 467). Be sure to put the cap back on the reservoir.

# Steering

## HYDRAULIC POWER STEERING ADAPTIVE STEERING

**Note:** The adaptive steering system has diagnostic checks that continuously monitor the system. If the system detects a fault, a message displays in the information display. If a red warning message displays, stop your vehicle as soon as it is safe to do so. The message may clear if the fault is no longer present. If an adaptive steering system warning message appears each time you start your vehicle, have the system checked as soon as possible.

The adaptive steering system continually changes the steering ratio with changes to vehicle speed, optimizing the steering response in all conditions. The system also changes when you switch on the transmission tow/haul feature. When you select the tow/haul button, the adaptive steering system reduces vehicle sensitivity to steering inputs at higher vehicle speeds, while maintaining the ease of parking and maneuverability at low speeds.

**Note:** The adaptive steering system is designed with a locking device. With the lock engaged, the adaptive steering system remains mechanically locked at a fixed steering ratio. You may also notice a click when you switch the vehicle on or after you switch it off, as the lock disengages or engages.

**Note:** If your vehicle loses electrical power or detects a fault when you are driving, the system automatically shuts down and you retain normal steering function with a fixed steering ratio. During this time, it is possible that the steering wheel may not be straight when the vehicle is driving straight ahead. In addition, the driver may notice that the steering wheel angle required to steer the vehicle may be different.

**Note:** During parking maneuvers, the adaptive steering system balances the driver workload for various steering wheel inputs and vehicle loading conditions. Under extreme operating conditions the system locking device may engage. This strategy prevents overheating and permanent damage to the adaptive steering system. Typical steering and driving maneuvers allow the system to cool and return to normal operation.

## STEERING – TROUBLESHOOTING

### STEERING – WARNING INDICATORS



The adaptive steering system indicator illuminates if the system detects a fault during the continuous diagnostic checks.

**Note:** If a red warning message displays, stop your vehicle as soon as it is safe to do so.

# Steering

---

## STEERING – INFORMATION MESSAGES

<b>Message</b>	<b>Action</b>
Steering Fault Service Now	The power steering system has detected a condition that requires service. Have your vehicle checked as soon as possible.
Steering Loss Stop Safely	The power steering system is not working. Stop your vehicle in a safe place. Have your vehicle checked as soon as possible.
Steering Assist Fault Service Required	The power steering system has detected a condition that requires service. Have your vehicle checked as soon as possible.
Steering Lock Malfunction Service Now	The steering system has detected a condition that requires service. Have your vehicle checked as soon as possible.

# Parking Aids (If Equipped)

## PARKING AID PRECAUTIONS



**WARNING:** To help avoid personal injury, always use caution when in reverse (R) and when using the sensing system.



**WARNING:** The system may not detect objects with surfaces that absorb reflection. Always drive with due care and attention. Failure to take care may result in a crash.



**WARNING:** Traffic control systems, fluorescent lamps, inclement weather, air brakes, external motors and fans may affect the correct operation of the sensing system. This may cause reduced performance or false alerts.



**WARNING:** The system may not detect small or moving objects, particularly those close to the ground.



**WARNING:** The parking aid system can only assist you to detect objects when your vehicle is moving at parking speeds. To help avoid personal injury you must take care when using the parking aid system.



**WARNING:** The system may not function if the sensor is blocked.



**WARNING:** In cold and severe weather conditions the system may not function. Rain, snow and spray can all limit sensor performance.



**WARNING:** If damage occurs in the immediate area surrounding the sensor, have your vehicle checked as soon as possible.

**Note:** *If your vehicle sustains damage leaving the sensors misaligned, this will cause inaccurate measurements or false alerts.*

When you connect a trailer to your vehicle, the rear parking aid detects the trailer and provides an alert. Disable the parking aid when you connect a trailer to prevent the alert.

**Note:** *Certain add-on devices installed around the bumper or fascia may create false alerts, for example, large trailer hitches, bike or surfboard racks, license plate brackets, bumper covers or any other device that could block the normal detection zone of the parking aid system. Aftermarket spare tires or spare tire covers mounted to the rear tailgate could cause false alerts from the park aid system. Remove the add-on device to prevent false alerts.*

**Note:** *Keep the sensors free from snow, ice and large accumulations of dirt. If the sensors are covered, the system's accuracy can be affected.*

Do not clean the sensors with sharp objects.

**Note:** *When using a programmed MyKey you cannot switch this off. See **MyKey™** (page 77).*

## REAR PARKING AID

### WHAT IS THE REAR PARKING AID

Rear parking sensors detect objects behind your vehicle when in reverse (R).

### REAR PARKING AID LIMITATIONS

There is a decreased coverage area at the outer corners.

When using a programmed MyKey, you cannot switch the rear parking aid off.

## Parking Aids (If Equipped)

The rear parking aid sensors are active when your vehicle is in reverse (R) and the vehicle speed is less than 5 mph (8 km/h).

The sensor coverage area is up to 71 in (180 cm) from the rear bumper.

The rear parking aid detects large objects when you shift into reverse (R) and any of the following occur:

- Your vehicle is moving backward at a low speed.
- Your vehicle is stationary but an object is approaching the rear of your vehicle at a low speed.
- Your vehicle is moving backward at a low speed and an object is moving towards your vehicle, for example another vehicle at a low speed.

### LOCATING THE REAR PARKING AID SENSORS



The rear parking aid sensors are in the rear bumper.

### REAR PARKING AID AUDIBLE WARNINGS

A warning tone sounds when your vehicle approaches an object. As your vehicle moves closer to an object, the rate of the tone increases. The warning tone continuously sounds when an object is 12 in (30 cm) or less from the rear bumper.

If your vehicle remains stationary for a few seconds, the audible warning turns off. If your vehicle moves backward the tone sounds again.

**Note:** When the parking aid system sounds a tone, the audio system could reduce the set volume.

### PARKING AIDS – TROUBLESHOOTING

#### PARKING AIDS – INFORMATION MESSAGES

If a fault is present in the parking aids, a warning message appears in the instrument cluster or the information and entertainment display.



## Parking Aids (If Equipped)

---

<b>Message</b>	<b>Action</b>
Check Front Park Aid	The system detects a condition that requires service. Have your vehicle checked as soon as possible.
Check Rear Park Aid	The system detects a condition that requires service. Have your vehicle checked as soon as possible.
Front Park Aid On Off	Displays the park aid status.
Rear Park Aid On Off	Displays the park aid status.

# Rear View Camera

## WHAT IS THE REAR VIEW CAMERA

The rear view camera provides a video image of the area behind your vehicle when the transmission is in reverse (R).



The rear view camera button is on the instrument panel.

## REAR VIEW CAMERA PRECAUTIONS



**WARNING:** The rear view camera system is a reverse aid supplement device that still requires the driver to use it in conjunction with the interior and exterior mirrors for maximum coverage.



**WARNING:** Objects that are close to either corner of the bumper or under the bumper, might not be seen on the screen due to the limited coverage of the camera system.



**WARNING:** Reverse your vehicle slowly. Failure to follow this instruction could result in the loss of control of your vehicle, personal injury or death.



**WARNING:** Use caution when the tailgate is ajar. If the tailgate is ajar, the camera is out of position and the video image could be incorrect. All guide lines disappear when the tailgate is ajar. Failure to follow this instruction could result in personal injury.



**WARNING:** Use caution when turning camera features on or off when the transmission is not in park (P). Make sure your vehicle is not moving.

**Note:** When towing, the camera only sees what you are towing. This might not provide adequate coverage and you might not see some objects. In some vehicles, the guide lines may disappear when you connect the trailer tow connector.

## LOCATING THE REAR VIEW CAMERA

The rear view camera is on the tailgate. It provides a video image of the area behind your vehicle.

# Rear View Camera

## REAR VIEW CAMERA GUIDE LINES

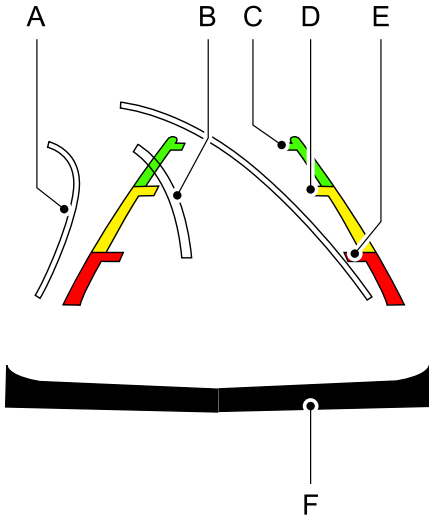

- A Active guide lines.
- B Centerline.
- C Fixed guide line: Green zone.
- D Fixed guide line: Yellow zone.
- E Fixed guide line: Red zone.
- F Rear bumper.

Active guide lines only show with fixed guide lines. To use active guide lines, turn the steering wheel to point the guide lines toward an intended path. If the steering wheel position changes while reversing, your vehicle might deviate from the intended path.

The fixed and active guide lines fade in and out depending on the steering wheel position. The active guide lines do not display when the steering wheel position is straight.

Use caution while reversing. Objects in the red zone are closest to your vehicle and objects in the green zone are farther away. Objects get closer to your vehicle as they move from the green zone to the yellow or red zones. Use the side view mirrors and rear view mirror to get better coverage on both sides and rear of your vehicle.

**Note:** Active guide lines and fixed guide lines are only available when the transmission is in reverse (R).

**Note:** The centerline is only available if the active or fixed guide lines are on.

**Note:** Not all camera modes work properly without an auxiliary camera.

## REAR VIEW CAMERA SETTINGS

### ZOOMING THE REAR VIEW CAMERA IN AND OUT



**WARNING:** When manual zoom is on, the full area behind your vehicle may not show. Be aware of your surroundings when using the manual zoom feature.

Selectable settings for this feature are zoom in (+) and zoom out (-). Press the symbol on the camera screen to change the view. The default setting is zoom off.

This allows you to get a closer view of an object behind your vehicle. The zoomed image keeps the bumper in the image to provide a reference. The zoom is only active while the transmission is in reverse (R).

# Rear View Camera

---

**Note:** *Zooming in also engages park hold which applies the electric park brake when you shift to park (P). When you press the zoom button, the electronic park hold button illuminates on the touchscreen. See **Connecting a Trailer** (page 323).*

**Note:** *Manual zoom is only available when the transmission is in reverse (R).*

**Note:** *Only the centerline shows when you enable manual zoom.*

## **SWITCHING REAR VIEW CAMERA DELAY ON AND OFF**

1. Press **Features** on the touchscreen.
2. Press **Driver Assistance**.
3. Press **Rear View Camera**.
4. Switch **Rear View Camera Delay** on or off.

When shifting the transmission out of reverse (R) and into any gear other than park (P), the camera image remains in the display until:

- Your vehicle speed reaches approximately 5 mph (8 km/h).
- You shift your vehicle into park (P).

# 360 Degree Camera (If Equipped)

## WHAT IS THE 360 DEGREE CAMERA

The 360 degree camera system consists of front, side and rear cameras which provide visibility around your vehicle.

## HOW DOES THE 360 DEGREE CAMERA WORK

The 360 Degree Camera system:

- Allows you to see what is directly in front of or behind your vehicle.
- Helps you when parallel parking and centering in a parking space.
- Provides a cross traffic view in front of and behind your vehicle.
- Allows you to see a top-down view of the area outside your vehicle, including the blind spots and obstacles near your vehicle.

## 360 DEGREE CAMERA PRECAUTIONS



**WARNING:** The 360 degree camera system still requires the driver to use it in conjunction with looking out of the windows, and checking the interior and exterior mirrors for maximum coverage.



**WARNING:** Objects that are close to either corner of the bumper or under the bumper, might not be seen on the screen due to the limited coverage of the camera system.



**WARNING:** Use caution when turning camera features on or off when the transmission is not in park (P). Make sure your vehicle is not moving.



**WARNING:** You are responsible for controlling your vehicle at all times. The system is designed to be an aid and does not relieve you of your responsibility to drive with due care and attention. Failure to follow this instruction could result in the loss of control of your vehicle, personal injury or death.

## 360 DEGREE CAMERA LIMITATIONS

**Note:** Use caution if a door is ajar. The 360 degree camera could be out of position and the image could be incorrect.

## LOCATING THE 360 DEGREE CAMERAS

### Rear View Camera

The rear view camera is on the tailgate. It provides a video image of the area behind your vehicle.

### Front View Camera

The front view camera is in the grille. It provides a video image of the area in front of your vehicle.

### Side View Camera

The side view camera is on the outside mirror. It provides a video image of the area on the sides of your vehicle to aid you when parking or when backing up a trailer.

# 360 Degree Camera (If Equipped)

## Bed Camera

The bed camera is mounted within the high-mount stop lamp. It displays the contents of your truck bed. The camera contains a dynamic guideline to help locate the center of your vehicle. This view can be accessed while in drive (D) or reverse (R).

## Auxiliary Camera

The auxiliary camera is a variant of the rear view camera and is accessed by pressing the AUX button on the display screen when moving in reverse (R) or in drive (D). It displays a rear view image from the back of a trailer while in reverse.

## 360 DEGREE CAMERA GUIDE LINES

**Note:** Active guide lines are only available when the transmission is in reverse (R).

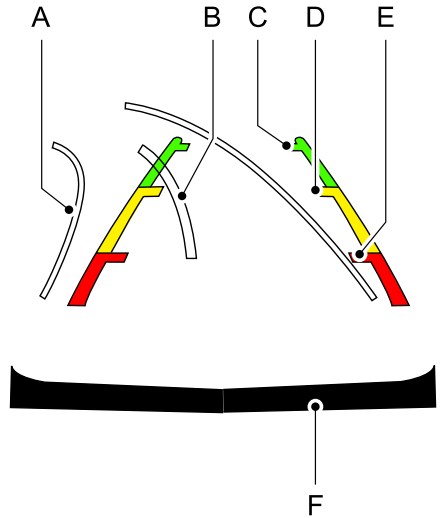

A	Active guide lines.
B	Centerline.
C	Fixed guide line: Green zone.
D	Fixed guide line: Yellow zone.
E	Fixed guide line: Red zone.
F	Rear bumper.

Active guide lines only show with fixed guide lines. Turn the steering wheel to point the guide lines toward an intended path. If the steering wheel position changes when reversing, your vehicle could deviate from the intended path.

## 360 Degree Camera (If Equipped)

The fixed and active guide lines fade in and out depending on the steering wheel position. The active guide lines do not display when the steering wheel position is straight.

Objects in the red zone are closest to your vehicle and objects in the green zone are farther away. Objects get closer to your vehicle as they move from the green zone to the yellow or red zones. Use the side view mirrors and rear view mirror to get better coverage on both sides and rear of your vehicle.

### Keep Out Zone

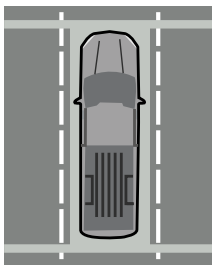

The Keep Out Zone is represented by the yellow dotted lines running parallel to your vehicle.

### 360 DEGREE CAMERA SETTINGS

#### SWITCHING THE 360 DEGREE CAMERA ON AND OFF

The 360 degree camera system button is on the instrument panel. The front and rear cameras have multiple screens which consist of:

- Normal view.
- Normal view with 360.
- Split view.
- Bed camera.
- Auxiliary camera.
- Hitch view.

**Note:** The rear view camera activates when you switch into reverse (R). Additional views are then accessible on the touchscreen.

When in park (P), neutral (N) or drive (D), the front images display when the button is pressed. When in reverse (R), only the rear images display when the button is pressed.

**Note:** Not all cameras are available.

**Note:** The 360 degree camera system turns off when your vehicle is in motion at low speed, except when in reverse (R).

#### SWITCHING THE 360 DEGREE CAMERA VIEW



Press to access the different camera views.



Front normal view provides an image of what is directly in front of your vehicle.



Front split view provides an extended view of what is in front of your vehicle.



Normal + 360 degree view contains the normal camera view next to a 360 degree camera view.



Rear normal view provides an image of what is directly behind your vehicle.



Rear split view provides an extended view of what is behind your vehicle.

## 360 Degree Camera (If Equipped)

---



Bed camera shows the truck bed.



Trailer AUX camera shows a rear view camera image of what is behind your trailer. This camera needs to be purchased and installed separately.



The hitch view provides an image of the area around the tow hitch.



Trailer reverse guidance shows the sides of your truck and trailer. See **Trailer Reverse Guidance** (page 357).



Zooms in on the image and park hold is activated. See **Connecting a Trailer** (page 323).



Zooms in on the 360 degree image.

**Note:** *The rear normal view, bed camera view, hitch view and trailer auxiliary view are available when your vehicle speed is greater than 6 mph (10 km/h).*



# Cruise Control (If Equipped)

## WHAT IS CRUISE CONTROL

Cruise control lets you maintain a set speed without keeping your foot on the accelerator pedal.

### Requirements

Use cruise control when the vehicle speed is greater than 20 mph (30 km/h).

## SWITCHING CRUISE CONTROL ON AND OFF



**WARNING:** Do not use cruise control on winding roads, in heavy traffic or when the road surface is slippery. This could result in loss of vehicle control, serious injury or death.

The cruise controls are on the steering wheel. See **What Is Cruise Control** (page 270).

### Switching Cruise Control On

**ON**

Press the button.

### Switching Cruise Control Off

**OFF**

Press the button when the system is in standby mode.

The system also turns off when you switch the ignition off.

**Note:** *The set speed erases when you switch the system off.*

## SETTING THE CRUISE CONTROL SPEED



**WARNING:** When you are going downhill, your vehicle speed could increase above the set speed. The system does not apply the brakes.

Drive to the speed you prefer.

**SET+**

Press either the Set+ or Set- buttons to set the current speed.

**SET-**

Take your foot off the accelerator pedal.

**Note:** *The indicator changes color in the information display.*

### Changing the Set Speed

**SET+**

Press the Set+ button to increase the set speed in small increments. Press and hold the Set+ button to accelerate. Release the button when you have reached your preferred speed.

**SET-**

Press the Set- button to decrease the set speed in small increments. Press and hold the Set- button to decelerate. Release the button when you have reached your preferred speed.

**Note:** *If you accelerate by pressing the accelerator pedal, the set speed does not change. When you release the accelerator pedal, your vehicle returns to the speed that you previously set.*

## Cruise Control (If Equipped)

---

### CANCELING THE SET SPEED



Press the button, or tap the brake pedal to cancel the set speed.

**Note:** *The system remembers the set speed.*

**Note:** *The system cancels if the vehicle speed drops below 10 mph (16 km/h) under the set speed when driving uphill.*

### RESUMING THE SET SPEED



Press the button.

### CRUISE CONTROL INDICATORS



Illuminates when you switch the system on.

# Adaptive Cruise Control (If Equipped)

## HOW DOES ADAPTIVE CRUISE CONTROL WORK

Adaptive Cruise Control adjusts your vehicle speed to maintain a selected gap between you and the vehicle in front of you in the same lane. The system uses sensors to maintain the speed and gap. You can select four different gap settings.

## ADAPTIVE CRUISE CONTROL PRECAUTIONS

 **WARNING:** You are responsible for controlling your vehicle at all times. The system is designed to be an aid and does not relieve you of your responsibility to drive with due care and attention. Failure to follow this instruction could result in the loss of control of your vehicle, personal injury or death.

 **WARNING:** Do not use adaptive cruise control on winding roads, in heavy traffic or when the road surface is slippery. This could result in loss of vehicle control, serious injury or death.

 **WARNING:** Pay close attention to changing road conditions such as entering or leaving a highway, on roads with intersections or roundabouts, roads without visible lanes of travel, roads that are winding, slippery, unpaved, or steep slopes.

 **WARNING:** The system is not a crash warning or avoidance system.

 **WARNING:** Do not use the system when towing a trailer that has aftermarket electronic trailer brake controls. Failure to follow this instruction could result in the loss of control of your vehicle, personal injury or death.

 **WARNING:** Do not use tire sizes other than those recommended because this can affect the normal operation of the system. Failure to do so may result in a loss of vehicle control, which could result in serious injury.

 **WARNING:** Do not use the system with a snow plow blade installed.

 **WARNING:** Do not use the system in poor visibility, for example fog, heavy rain, spray or snow.

## When Following a Vehicle

 **WARNING:** When following a vehicle that is braking, your vehicle does not always decelerate quickly enough to avoid a crash without driver intervention. Apply the brakes when necessary. Failure to follow this instruction could result in personal injury or death.

## Hilly Condition and Trailer Tow Usage

You should select a lower gear when the system is active in situations such as prolonged downhill driving on steep slopes, for example in mountainous areas. The system needs additional engine braking in these situations to reduce the load on the vehicle's regular brake system to prevent it from overheating.

# Adaptive Cruise Control (If Equipped)

**Note:** An audible alarm sounds and the system shuts down if it applies brakes for an extended period of time. This allows the brakes to cool. The system functions normally again after the brakes cool.

**Note:** When towing with adaptive cruise control, switch on Tow/Haul Mode and Diesel Engine Brake.

**Note:** Tow/Haul mode increases the time gaps and allows more distance for braking.

## ADAPTIVE CRUISE CONTROL LIMITATIONS

### Sensor Limitations

**WARNING:** On rare occasions, detection issues can occur due to the road infrastructures, for example bridges, tunnels and safety barriers. In these cases, the system may brake late or unexpectedly. At all times, you are responsible for controlling your vehicle, supervising the system and intervening, if required.

**WARNING:** If the system malfunctions, have your vehicle checked as soon as possible.

**WARNING:** Large contrasts in outside lighting can limit sensor performance.

**WARNING:** The system only warns of vehicles detected by the radar sensor. In some cases there may be no warning or a delayed warning. Apply the brakes when necessary. Failure to follow this instruction could result in personal injury or death.

**WARNING:** The system may not detect stationary or slow moving vehicles below 6 mph (10 km/h).

**WARNING:** The system does not detect pedestrians or objects in the road.

**WARNING:** The system does not detect oncoming vehicles in the same lane.

**WARNING:** The system may not operate properly if the sensor is blocked. Keep the windshield free from obstruction.

**WARNING:** The sensor may incorrectly track lane markings as other structures or objects. This can result in a false or missed warning.

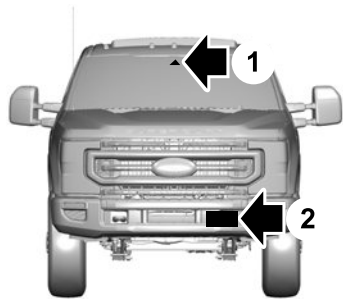

1. Camera.
2. Radar sensor.

The camera is on the windshield behind the interior mirror.

The radar sensor is in the lower grille.

**Note:** You cannot see the sensor. It is behind a fascia panel.

# Adaptive Cruise Control (If Equipped)

**Note:** Keep the front of your vehicle free of dirt, metal badges or objects. Vehicle front protectors, aftermarket lights, additional paint or plastic coatings could also degrade sensor performance.

A message displays if something obstructs the camera or the sensor. When something blocks the sensor, the system cannot detect a vehicle ahead and does not function. See **How Does Adaptive Cruise Control Work** (page 272).

The radar sensor has a limited field of view. It may not detect vehicles at all or detect a vehicle later than expected in some situations. The lead vehicle image does not illuminate if the system does not detect a vehicle in front of you.

## Detection Issues Can Occur:

A

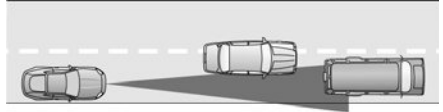

B

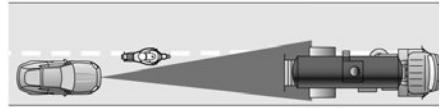

C

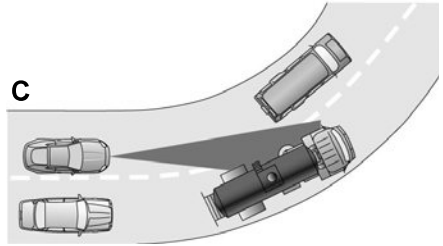

- A When driving on a different line than the vehicle in front.
- B With vehicles that edge into your lane. The system can only detect these vehicles once they move fully into your lane.
- C There may be issues with the detection of vehicles in front when driving into and coming out of a bend or curve in the road.

In these cases, the system may brake late or unexpectedly.

If something hits the front end of your vehicle or damage occurs, the radar-sensing zone may change. This could cause missed or false vehicle detection.

# Adaptive Cruise Control (If Equipped)

Optimal system performance requires a clear view of the road by the windshield camera.

Optimal performance may not occur if:

- The camera is blocked.
- There is poor visibility or lighting conditions.
- There are bad weather conditions.

## SWITCHING ADAPTIVE CRUISE CONTROL ON AND OFF

The cruise controls are on the steering wheel.

### Switching Adaptive Cruise Control On

**ON** Press and release the button.

 The indicator, current gap setting and set speed appear in the instrument cluster display.

### Switching Adaptive Cruise Control Off

**OFF** Press and release the button when the system is in standby mode or switch the ignition off.

**Note:** When you switch the system off, the set speed and gap setting clears.

## ADAPTIVE CRUISE CONTROL AUTOMATIC CANCELLATION

The system is not functional at vehicle speeds below 12 mph (20 km/h). The information display indicates low engine speed, an audible alarm sounds and the automatic braking releases if the vehicle drops below this speed.

The system may cancel if:

- The tires lose traction.
- You apply the parking brake.

The system may deactivate or prevent activating when requested if:

- The vehicle has a blocked sensor.
- The brake temperature is too high.
- There is a failure in the system or a related system.

**Note:** If the engine speed drops too low, an audible warning sounds and a message appears in the information display. Automatic braking releases.

## SETTING THE ADAPTIVE CRUISE CONTROL SPEED

Drive to the speed you prefer.

**SET+** Press the Set+ or Set- buttons to set the current speed.

**SET-**

Take your foot off the accelerator pedal.

The indicator, current gap setting and set speed appear in the information display.



A vehicle image illuminates if there is a vehicle detected in front of you.

# Adaptive Cruise Control (If Equipped)

**Note:** When adaptive cruise control is active, the speedometer may vary slightly from the set speed displayed in the information display.

## Manually Changing the Set Speed

**SET+** Press the Set+ button to increase the set speed in small increments. Press and hold the Set+ button to accelerate. Release the button when you have reached your preferred speed.

**SET-** Press the Set- button to decrease the set speed in small increments. Press and hold the Set- button to decelerate. Release the button when you have reached your preferred speed.

You can also press the accelerator or brake pedal until you reach the speed you prefer. Press the Set+ or Set- button to select the current speed as the set speed.

The system may apply the brakes to slow the vehicle to the new set speed. The set speed continuously displays in the information display when the system is active.

## SETTING THE ADAPTIVE CRUISE CONTROL GAP

You can decrease or increase the distance between your vehicle and the vehicle in front by pressing the gap control.



Press and release to increase the gap distance.



Press and release to decrease the gap distance.



The selected gap appears in the information display as shown by the bars in the image.

**Note:** The gap setting is time dependent and therefore, the distance adjusts with your vehicle speed.

**Note:** It is your responsibility to select a gap appropriate to the driving conditions.

## Adaptive Cruise Control Gap Settings

Graphic Display, Bars Indicated Between Vehicles	Gap Distance	Dynamic Behavior
1	Closest.	Sport.
2	Close.	Normal.
3	Medium.	Normal.
4	Far.	Comfort.

Each time you switch the system on, it selects the last chosen gap setting.

## Following a Vehicle

When a vehicle ahead of you enters the same lane or a slower vehicle is ahead in the same lane, the vehicle speed adjusts to maintain the gap setting.

# Adaptive Cruise Control (if Equipped)

**Note:** When you are following a vehicle and you switch on a turn signal lamp, adaptive cruise control may provide a small, temporary acceleration to help you pass.

Your vehicle maintains a consistent gap from the vehicle ahead until:

- The vehicle in front of you accelerates to a speed above the set speed.
- The vehicle in front of you moves out of the lane you are in.
- You set a new gap distance.

The system applies the brakes to slow down your vehicle to maintain a safe gap distance from the vehicle in front of you. The system only applies limited braking. You can override the system by applying the brakes.

**Note:** The brakes may emit noise when applied by the system.

If the system determines that its maximum braking level is not sufficient, an audible warning sounds, a message appears in the information display and an indicator flashes when the system continues to brake. Take immediate action.

## CANCELING THE SET SPEED

**CNCL** Press the button or tap the brake pedal.

The set speed does not erase.

## RESUMING THE SET SPEED

**RES** Press the button.

Your vehicle speed returns to the previously set speed and gap setting. The set speed displays continuously in the information display when the system is active.

**Note:** Only use resume if you are aware of the set speed and intend to return to it.

## OVERRIDING THE SET SPEED

 **WARNING:** If you override the system by pressing the accelerator pedal, it does not automatically apply the brakes to maintain a gap from any vehicle ahead.

When you press the accelerator pedal, you override the set speed and gap distance.

Use the accelerator pedal to intentionally exceed the set speed limit.

When you override the system, the green indicator illuminates and the vehicle icon does not appear in the instrument cluster display.

The system resumes operation when you release the accelerator pedal. The vehicle speed decreases to the set speed, or a lower speed if following a slower vehicle.

## ADAPTIVE CRUISE CONTROL INDICATORS

 Illuminates when you switch adaptive cruise control on. The color of the indicator changes to indicate the system status.

White indicates the system is on but inactive.

Green indicates that you set the speed and the system is active.



# Adaptive Cruise Control (If Equipped)

## SWITCHING FROM ADAPTIVE CRUISE CONTROL TO CRUISE CONTROL - VEHICLES WITH: 2.3 INCH SCREEN



**WARNING:** Normal cruise control will not brake when your vehicle is approaching slower vehicles. Always be aware of which mode you have selected and apply the brakes when necessary.

To switch from adaptive cruise control to cruise control, use the instrument cluster display:

1. Select **Driver Assist**.
2. Select **Cruise Control**.
3. Select a cruise control option.



The cruise control indicator replaces the adaptive cruise control indicator if you select normal cruise control. The gap setting does not display, and the system does not respond to lead vehicles. Automatic braking remains active to maintain set speed. The system remembers the last setting when you start your vehicle.

## SWITCHING FROM ADAPTIVE CRUISE CONTROL TO CRUISE CONTROL - VEHICLES WITH: 4.2 INCH SCREEN



**WARNING:** Normal cruise control will not brake when your vehicle is approaching slower vehicles. Always be aware of which mode you have selected and apply the brakes when necessary.

To switch from adaptive cruise control to cruise control, use the instrument cluster display:

1. Select **Driver Assist**.
2. Select **Cruise Control**.
3. Select a cruise control option.



The cruise control indicator replaces the adaptive cruise control indicator if you select normal cruise control. The gap setting does not display, and the system does not respond to lead vehicles. Automatic braking remains active to maintain set speed. The system remembers the last setting when you start your vehicle.

## SWITCHING FROM ADAPTIVE CRUISE CONTROL TO CRUISE CONTROL - VEHICLES WITH: 8 INCH SCREEN



**WARNING:** Normal cruise control will not brake when your vehicle is approaching slower vehicles. Always be aware of which mode you have selected and apply the brakes when necessary.

To switch from adaptive cruise control to cruise control, use the instrument cluster display:

1. Select **Driver Assist**.
2. Select **Cruise Control**.
3. Select a cruise control option.

# Adaptive Cruise Control (If Equipped)



The cruise control indicator replaces the adaptive cruise control indicator if you select normal cruise control. The gap setting does not display, and the system does not respond to lead vehicles. Automatic braking remains active to maintain set speed. The system remembers the last setting when you start your vehicle.

## ADAPTIVE CRUISE CONTROL – TROUBLESHOOTING

### ADAPTIVE CRUISE CONTROL – INFORMATION MESSAGES

#### Blocked Sensor



The camera is mounted on the windshield behind the interior mirror.

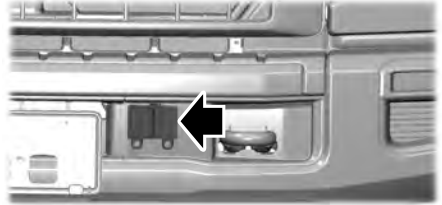

A message displays if something obstructs the radar signals from the sensor. The sensor is in the lower grille. The system cannot detect a vehicle ahead and does not function when something blocks the sensor.

**Note:** *You cannot see the sensor. It is behind a fascia panel.*

Keep the front of your vehicle free of dirt, metal badges or objects. Vehicle front protectors and aftermarket lights may also block the sensor.

#### Possible Causes and Actions for This Message Displaying:

Cause	Action
The surface of the radar is dirty or obstructed.	Clean the grille surface in front of the radar or remove the object causing the obstruction.
The surface of the radar is clean but the message remains in the display.	Wait a short time. It may take several minutes for the radar to detect that it is free from obstruction.
Heavy rain or snow is interfering with the radar signals.	Do not use the system in these conditions because it may not detect any vehicles ahead.

## Adaptive Cruise Control (If Equipped)

---

Cause	Action
Water, snow or ice on the surface of the road may interfere with the radar signals.	Do not use the system in these conditions because it may not detect any vehicles ahead.
You are in a desert or remote area with no other vehicles and no roadside objects.	Wait a short time or switch to normal cruise control.

Due to the nature of radar technology, it is possible to get a blockage warning with no actual block. A false blocked condition either self clears, or clears after you restart your vehicle.

# Drive Mode Control

## WHAT IS DRIVE MODE CONTROL

Your vehicle has various drive modes that you can select for different driving conditions. Depending on the drive mode that you select, the system adjusts various vehicle settings.

## HOW DOES DRIVE MODE CONTROL WORK

Drive mode control adjusts your vehicle configuration for each mode you select.

Changing the drive mode adjusts the steering effort and feel of the steering system.

The stability and traction control assist your vehicle control in adverse conditions or high-performance driving.

Throttle control enhances the powertrain response, transmission controls become optimized with shift schedules, and four-wheel drive settings are optimized and tuned to each mode.

Changing the drive mode can engage or disengage the electronic locking differentials.

Changing the drive mode changes the four-wheel drive mode to the default setting for the selected drive mode.

**Note:** *The system has diagnostic checks that continuously monitor the system for proper operation. If a mode is unavailable due to a system fault, the drive mode system defaults to normal. When the system defaults to normal, the driveline settings remain the same as prior to the system fault.*

**Note:** *The system reverts to the normal mode each time you start your vehicle. At startup the system also displays a prompt on the instrument cluster display that gives you the option to return to the previously selected drive mode during the last ignition cycle. If you select yes, the system returns to the last selected drive mode and the default driveline settings associated with that mode. If you select no, the system remains in normal mode and the driveline settings remain the same as selected in the prior ignition cycle. If you do not select yes or no, the system stays in normal mode and the driveline settings remain the same as selected in the prior ignition cycle.*

## SELECTING A DRIVE MODE



To change the drive mode setting, press the drive mode button. The drive mode selection menu appears in the instrument cluster and allows you to select through the available drive modes.

# Drive Mode Control

## DRIVE MODES

### DEEP SNOW/SAND - 4X4



For off-road driving on soft, dry sand or deep snow. This mode optimizes accelerator pedal response, traction and stability controls to help maintain forward momentum. If your vehicle becomes stuck in deep conditions, use this mode to help get unstuck.

Four-wheel drive high is the default four-wheel drive mode. Four-wheel drive low is selectable in deep snow/sand mode.

The electronic locking differential engages when you select this mode at any speed, and you can disengage it at any time using the button. See **Switching the Electronic Locking Differential On and Off** (page 238).

**Note:** *Do not use this mode when driving on pavement or packed snow. This could cause driveline bind up and damage the system depending on the four-wheel drive mode selection. See **Four-Wheel Drive** (page 228).*

### ECO - 4X4



For efficient driving. This mode helps deliver maximum fuel efficiency and helps to increase driving range.

Two-wheel drive high is the default four-wheel drive mode. Four-wheel drive low is not available in eco mode.

The electronic locking differential is available below 25 mph (40 km/h). See **Switching the Electronic Locking Differential On and Off** (page 238).

### ECO - 4X2



For efficient driving. This mode helps deliver maximum fuel efficiency and helps to increase driving range.

The electronic locking differential is available below 25 mph (40 km/h). See **Switching the Electronic Locking Differential On and Off** (page 238).

### NORMAL - 4X4



For everyday driving. This mode is the perfect balance of excitement, comfort and convenience. This is the default mode after each ignition cycle.

Two-wheel drive high is the default four-wheel drive mode. All four-wheel drive modes are selectable when in normal mode.

The electronic locking differential is available below 25 mph (40 km/h). See **Switching the Electronic Locking Differential On and Off** (page 238).

### NORMAL - 4X2



For everyday driving. This mode is the perfect balance of excitement, comfort and convenience. This is the default mode after each ignition cycle.

The electronic locking differential is available below 25 mph (40 km/h). See **Switching the Electronic Locking Differential On and Off** (page 238).

# Drive Mode Control

## ROCK CRAWL - TREMOR, 4X4



For off-road driving and optimum rock-climbing. Rock crawl mode engages the electronic locking differential, optimizes throttle response and adjusts transmission shift points to provide additional control of your vehicle.

Four-wheel drive low is the only four-wheel drive mode available in rock crawl mode.

The electronic locking differential engages when you select this mode at any speed, and you can disengage it at any time using the button. See **Switching the Electronic Locking Differential On and Off** (page 238).

## TOW/HAUL - 4X4



For improved transmission operation when towing a trailer or a heavy load. This mode moves upshifts to higher engine speeds to reduce the frequency of transmission shifting. This mode also provides engine braking in all forward gears, which slows your vehicle and assists you in controlling your vehicle when descending a slope. The amount of downshift braking provided varies based on the amount you press the brake pedal.

All four-wheel drive modes are selectable in tow/haul mode. This mode does not default to a certain four-wheel drive mode.

The system tunes the steering and suspension to enhance driving comfort when towing or carrying heavy loads.

The electronic locking differential is available below 25 mph (40 km/h). See **Switching the Electronic Locking Differential On and Off** (page 238).

## TOW/HAUL - 4X2



For improved transmission operation when towing a trailer or a heavy load. This mode moves upshifts to higher engine speeds to reduce the frequency of transmission shifting. This mode also provides engine braking in all forward gears, which slows your vehicle and assists you in controlling your vehicle when descending a slope. The amount of downshift braking provided varies based on the amount you press the brake pedal.

The system tunes the steering and suspension to enhance driving comfort when towing or carrying heavy loads.

The electronic locking differential is available below 25 mph (40 km/h). See **Switching the Electronic Locking Differential On and Off** (page 238).

## DRIVE MODE CONTROL – TROUBLESHOOTING

### DRIVE MODE CONTROL – WARNING LAMPS



Some drive modes reduce traction and stability control performance and the indicator illuminates in the instrument cluster.

# Drive Mode Control

---

## DRIVE MODE CONTROL – INFORMATION MESSAGES

<b>Message</b>	<b>Action</b>
Selected 4x4 Mode Not Available in Current Drive Mode	You have selected a four-wheel drive mode that is not available in the current drive mode. Select an available four-wheel drive mode.

# Drive Mode Control

---

## **DRIVE MODE CONTROL – FREQUENTLY ASKED QUESTIONS**

### **Why did the system default to normal mode?**

If a mode is unavailable due to a system fault, it defaults to normal mode and the driveline settings remain the same as prior to the system fault.



# Lane Keeping System (If Equipped)

## WHAT IS THE LANE KEEPING SYSTEM

The lane keeping system alerts you by providing temporary steering wheel vibration when it detects an unintended lane departure.

## HOW DOES THE LANE KEEPING SYSTEM WORK

The lane keeping system uses a forward looking camera mounted on the windshield to monitor vehicle movement within the travel lane.

When the camera detects a drift out of the travel lane, the lane keeping system alerts the driver by vibrating the steering wheel.

The driver can select the steering wheel vibration intensity.

## LANE KEEPING SYSTEM PRECAUTIONS



**WARNING:** You are responsible for controlling your vehicle at all times. The system is designed to be an aid and does not relieve you of your responsibility to drive with due care and attention. Failure to follow this instruction could result in the loss of control of your vehicle, personal injury or death.



**WARNING:** The system will not operate if the sensor cannot track the road lane markings.



**WARNING:** The sensor may incorrectly track lane markings as other structures or objects. This can result in a false or missed warning.



**WARNING:** In cold and severe weather conditions the system may not function. Rain, snow and spray can all limit sensor performance.



**WARNING:** The system may not operate properly if the sensor is blocked. Keep the windshield free from obstruction.



**WARNING:** If damage occurs in the immediate area surrounding the sensor, have your vehicle checked as soon as possible.



**WARNING:** The system may not correctly operate if your vehicle is fitted with a suspension kit not approved by us.



**WARNING:** Large contrasts in outside lighting can limit sensor performance.

## LANE KEEPING SYSTEM LIMITATIONS

The lane keeping system only operates when the vehicle speed is greater than 40 mph (64 km/h).

The system works when the camera can detect at least one lane marking.

The lane keeping system may not correctly operate in any of the following conditions:

- The lane keeping system does not detect at least one lane marking.
- You switch the turn signal on.
- You apply direct steering, accelerate fast or brake hard.
- The vehicle speed is less than 40 mph (64 km/h).
- The anti-lock brake, stability control or traction control system activates.

# Lane Keeping System (If Equipped)

- The lane is too narrow.
- Something is obscuring the camera or it is unable to detect the lane markings due to environment, traffic or vehicle conditions.
- Entering or exiting a tight curve when driving at high speeds.

The lane keeping system may not correct lane positioning in any of the following conditions:

- High winds.
- Uneven road surfaces.
- Heavy or uneven loads.
- Incorrect tire pressure.

## SWITCHING THE LANE KEEPING SYSTEM ON AND OFF - VEHICLES WITH: 4.2 INCH SCREEN



To activate the lane keeping system, press the button on the steering wheel.

To deactivate the lane keeping system, press the button again.

**Note:** When switching the system on or off a message appears in the information and entertainment display to show the status.

**Note:** The system stores the on or off setting until manually changed, unless it detects a MyKey™. If the system detects a MyKey™, it defaults to the last setting for that MyKey™.

**Note:** If the system detects a MyKey™, pressing the button does not affect the on or off status of the system. You can only change the mode and intensity settings.

## System Settings

To switch the system on or off, use the instrument cluster display:

1. Select **Driver Assist**.
2. Select **Lane-Keeping System**.
3. Switch the feature on or off.

The system remembers the last selection. You do not need to readjust the setting each time you turn on your vehicle.

**Sensitivity:** This setting allows you to select where in the lane the system provides a warning. Increasing the sensitivity setting moves the warning zones in closer to your vehicle.

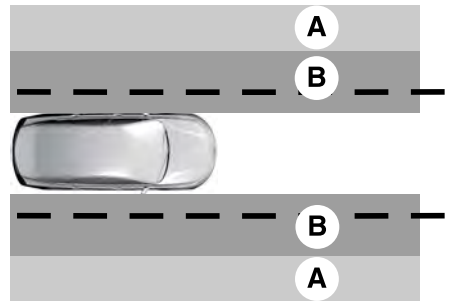

A Normal.

B Increased.

**Note:** The alert diagram illustrates general zone coverage. It does not provide exact zone parameters.

**Intensity:** This setting affects the intensity of the steering wheel vibration. Increasing the intensity causes a higher rate of feedback.

- High.
- Normal.
- Low.

## Lane Keeping System (If Equipped)

### SWITCHING THE LANE KEEPING SYSTEM ON AND OFF - VEHICLES WITH: 8 INCH SCREEN



To activate the lane keeping system, press the button on the steering wheel.

To deactivate the lane keeping system, press the button again.

**Note:** When switching the system on or off a message appears in the information and entertainment display to show the status.

**Note:** The system stores the on or off setting until manually changed, unless it detects a MyKey™. If the system detects a MyKey™, it defaults to the last setting for that MyKey™.

**Note:** If the system detects a MyKey™, pressing the button does not affect the on or off status of the system. You can only change the mode and intensity settings.

### System Settings

To switch the system on or off, use the instrument cluster display:

1. Select **Driver Assist**.
2. Select **Lane-Keeping System**.
3. Switch the feature on or off.

The system remembers the last selection. You do not need to readjust the setting each time you turn on your vehicle.

**Sensitivity:** This setting allows you to select where in the lane the system provides a warning. Increasing the sensitivity setting moves the warning zones in closer to your vehicle.

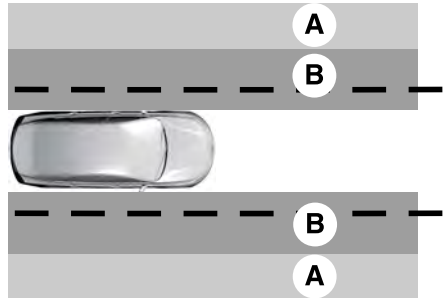

- A Normal.
- B Increased.

**Note:** The alert diagram illustrates general zone coverage. It does not provide exact zone parameters.

**Intensity:** This setting affects the intensity of the steering wheel vibration. Increasing the intensity causes a higher rate of feedback.

- High.
- Normal.
- Low.

### ALERT MODE

#### WHAT IS ALERT MODE

Alert mode vibrates the steering wheel when it detects an unintended lane departure.

# Lane Keeping System (If Equipped)

## HOW DOES ALERT MODE WORK

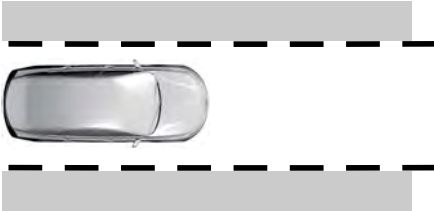

When in alert mode, the lane keeping system alerts you by vibrating the steering wheel. The intensity of the vibration is set through the lane keeping system menu.

## ADJUSTING THE STEERING WHEEL VIBRATION INTENSITY - VEHICLES WITH: 4.2 INCH SCREEN

To change the steering wheel vibration intensity, use the instrument cluster display:

1. Select **Driver Assist**.
2. Select **Lane-Keeping System**.
3. Select **Alert Intensity**.
4. Select an intensity setting.

## ADJUSTING THE STEERING WHEEL VIBRATION INTENSITY - VEHICLES WITH: 8 INCH SCREEN

To change the steering wheel vibration intensity, use the instrument cluster display:

1. Select **Driver Assist**.
2. Select **Lane-Keeping System**.
3. Select **Alert Intensity**.
4. Select an intensity setting.

## LANE KEEPING SYSTEM INDICATORS



If you switch the lane keeping system on, a graphic with lane markings appears in the information display.

When you switch the system off, the lane marking graphics do not display.

**Note:** *The overhead vehicle graphic may still display if adaptive cruise control is enabled.*

While the lane keeping system is on, the color of the lane markings change to indicate the system status.

## Lane Keeping System (If Equipped)

---

<b>Gray</b>	<b>Green</b>	<b>Yellow</b>	<b>Red</b>
Indicates that the system is temporarily unavailable to provide a warning or intervention on the indicated side.	Indicates that the system is available or ready to provide a warning or intervention on the indicated side.	Indicates that the system is providing or has just provided a lane keeping aid intervention.	Indicates that the system is providing or has just provided a lane keeping alert warning.

### LANE KEEPING SYSTEM – TROUBLESHOOTING

#### LANE KEEPING SYSTEM – INFORMATION MESSAGES

<b>Message</b>	<b>Action</b>
Lane Keeping Sys. Malfunction Service Required	The system has malfunctioned. Have your vehicle checked as soon as possible.
Front Camera Temporarily Not Available	The system has detected a condition that has caused the system to be temporarily unavailable.
Front Camera Low Visibility Clean Screen	The system has detected a condition that requires you to clean the windshield in order for it to operate properly.
Front Camera Malfunction Service Required	The system has malfunctioned. Have your vehicle checked as soon as possible.
Keep Hands on Steering Wheel	The system requests that you keep your hands on the steering wheel.

## Lane Keeping System (If Equipped)

### LANE KEEPING SYSTEM – FREQUENTLY ASKED QUESTIONS

<b>Why is the feature not available (lane markings are gray) when I can see the lane markings on the road?</b>
Your vehicle speed is less than 40 mph (65 km/h).
The sun is shining directly into the camera lens.
A quick intentional lane change has occurred.
Your vehicle stays too close to the lane markings for an extended interval of time.
Driving at high speeds in curves.
The last alert warning or aid intervention occurred a short time ago.
Ambiguous lane markings, for example, in construction zones.
Rapid transition from light to dark, or from dark to light.
Sudden offset in lane markings.
ABS or AdvanceTrac™ is active.
There is a camera blockage due to dirt, grime, fog, frost or water on the windshield.
You are driving too close to the vehicle in front of you.
Transitioning between no lane markings to lane markings, or vice versa.
There is standing water on the road.
Faint lane markings, for example, partial yellow lane markings on concrete roads.
Lane width is too narrow or too wide.
You have not calibrated the camera after a windshield replacement.
Driving on tight or on uneven roads.

## Lane Keeping System (If Equipped)

---

<b>Why does the vehicle not come back toward the middle of the lane, as expected, in the Aid, or Aid + Alert mode?</b>
High cross winds are present.
There is a large road crown.
Rough roads, grooves or shoulder drop-offs.
Heavy, uneven loading of the vehicle or improper tire inflation pressure.
You changed the tires or modified the suspension.

# Blind Spot Information System (If Equipped)

## WHAT IS BLIND SPOT INFORMATION SYSTEM

Blind spot information system detects vehicles that may have entered the blind spot zone.

## HOW DOES BLIND SPOT INFORMATION SYSTEM WORK

Blind spot information system uses sensors on both sides of your vehicle, detecting rearward from the exterior mirrors to approximately 13 ft (4 m) beyond the rear bumper. The detection area extends to approximately 59 ft (18 m) beyond the rear bumper when the vehicle speed is greater than 30 mph (48 km/h) to alert you of faster approaching vehicles.



## BLIND SPOT INFORMATION SYSTEM PRECAUTIONS



**WARNING:** Do not use the blind spot information system as a replacement for using the interior and exterior mirrors or looking over your shoulder before changing lanes. The blind spot information system is not a replacement for careful driving.



**WARNING:** The system may not operate properly during severe weather conditions, for example snow, ice, heavy rain and spray. Always drive with due care and attention. Failure to take care may result in a crash.

**Note:** *Blind spot information system does not prevent contact with other vehicles. It does not detect parked vehicles, pedestrians, animals or other infrastructure.*

## BLIND SPOT INFORMATION SYSTEM LIMITATIONS

Blind spot information system does not operate in park (P) or reverse (R).

The system may not alert you if a vehicle quickly passes through the detection zone.

## BLIND SPOT INFORMATION SYSTEM REQUIREMENTS

Blind spot information system turns on when all the following occur:

- You start your vehicle.
- You shift into drive (D).
- The vehicle speed is greater than 6 mph (10 km/h).

## SWITCHING BLIND SPOT INFORMATION SYSTEM ON AND OFF - VEHICLES WITH: 4.2 INCH SCREEN

To switch the system on or off, use the instrument cluster display:

1. Select **Driver Assist**.
2. Select **Blind Spot**.
3. Switch the feature on or off.



## Blind Spot Information System (If Equipped)

When you switch blind spot information system off, a warning lamp illuminates and a message displays. When you switch the system on or off, the alert indicators flash twice.

**Note:** *The system remembers the last setting when you start your vehicle.*

To permanently switch the system off, contact an authorized dealer.

### SWITCHING BLIND SPOT INFORMATION SYSTEM ON AND OFF - VEHICLES WITH: 8 INCH SCREEN

To switch the system on or off, use the instrument cluster display:

1. Select **Driver Assist**.
2. Select **Blind Spot**.
3. Switch the feature on or off.

When you switch blind spot information system off, a warning lamp illuminates and a message displays. When you switch the system on or off, the alert indicators flash twice.

**Note:** *The system remembers the last setting when you start your vehicle.*

To permanently switch the system off, contact an authorized dealer.

### LOCATING THE BLIND SPOT INFORMATION SYSTEM SENSORS

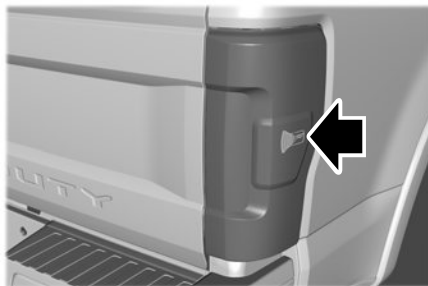

The sensors are inside the brake lamp on both sides of your vehicle.

**Note:** *Keep the sensors free from snow, ice and large accumulations of dirt.*

**Note:** *Do not cover the sensors with bumper stickers, repair compound or other objects.*

**Note:** *Bike and cargo racks could cause false alerts due to obstruction of the sensor. We recommend switching the feature off when using a bike or cargo rack.*

**Note:** *Blocked sensors may affect system accuracy.*

If the sensors become blocked, a message appears in the instrument cluster display. See **Blind Spot Information System – Information Messages** (page 297). The alert indicators illuminate but the system does not alert you.

# Blind Spot Information System (If Equipped)

## BLIND SPOT INFORMATION SYSTEM WITH TRAILER COVERAGE

### WHAT IS BLIND SPOT INFORMATION SYSTEM WITH TRAILER COVERAGE

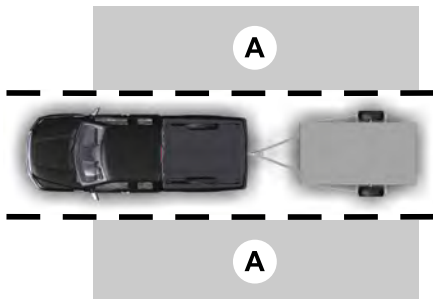

Blind spot information system detects vehicles that may have entered the blind spot zone. The detection area is on both sides your vehicle and trailer, extending rearward from the exterior mirrors to the end of your trailer.

### BLIND SPOT INFORMATION SYSTEM WITH TRAILER COVERAGE LIMITATIONS

Trailer coverage only supports conventional trailers. The system turns off if you select a fifth wheel trailer type.

Make sure the trailer width is less than or equal to 8.5 ft (2.6 m) and the length is less than 33 ft (10.1 m). If you input values higher, the system turns off.

Some trailers could cause a slight change in system performance:

- Large box trailers could cause false alerts to occur when driving next to infrastructures or near parked cars. A false alert could also occur while making a 90-degree turn.
- Trailers that have a width greater than 8.5 ft (2.6 m) at the front and have a total length greater than 20 ft (6 m) could cause delayed alerts when a vehicle is passing at high speeds.
- Box trailers that have a width greater than 8.5 ft (2.6 m) at the front could cause early alerts when you pass a vehicle.
- Clam shell or v-nose box trailers with a width greater than 8.5 ft (2.6 m) at the front could cause delayed alerts when a vehicle traveling the same speed as your vehicle merges lanes.

## SETTING A TRAILER LENGTH

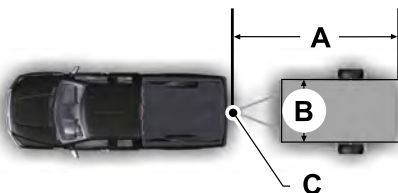

- A Trailer length.
- B Trailer width.
- C Trailer hitch ball.

You can set-up a trailer to work with the blind spot information system through the touchscreen. When setting up a trailer, a sequence of screens appear asking for trailer information.

1. Select type of trailer screen - conventional, fifth wheel or gooseneck.

## Blind Spot Information System (If Equipped)

**Note:** The system only supports conventional trailers.

2. Do you want to set up blind spot with trailer screen? If no, the system turns off. If yes, the menu goes to the next screen.
3. Is the width less than 9 ft (2.7 m) and length less than 33 ft (10.1 m)? If no, the system turns off. If yes, the menu goes to the next screen.
4. Trailer width measurement. Measure the width at the front of the trailer. It is not measured at the widest point of the trailer. The maximum width at the front of the trailer the system can support is 8.5 ft (2.6 m).

**Note:** You do not need to enter an exact trailer width measurement. You only need to confirm that the width of the trailer is less than 9 ft (2.7 m).

5. Trailer length measurement. The trailer length is the distance between the trailer hitch ball and the rear of the trailer. The maximum length that the system can support is 33 ft (10.1 m).
6. Enter the length of trailer. The default setting is 18 ft (5.5 m). Toggling up or down using the menu buttons increases or decreases the measurement by 3 ft (1 m). Select a length that is equal to or within 3 ft (1 m) of the actual measured length. For example, if the actual measure length is 25 ft (7.5 m), toggle the length in the menu to 27 ft (8.2 m). The system setup saves when you enter the length of the trailer.

**Note:** If the trailer is a bike rack or cargo rack with electrical lighting, enter a length of 3 ft (1 m). Cross traffic alert remains on for trailers with a length of 3 ft (1 m) or less.

**Note:** The system requires proper measurement and measure entry to function properly.

### SELECTING A TRAILER

When you connect a trailer to your vehicle, the trailer set up menu appears in the touchscreen. This menu allows you to set up a new trailer or choose from a previously set up trailer. A warning message appears and the system turns off if you do not choose or add a new trailer.

**Note:** The warning message may not appear until your vehicle reaches 22 mph (35 km/h).

### BLIND SPOT INFORMATION SYSTEM INDICATORS



When blind spot information system detects a vehicle, an alert indicator illuminates in the exterior mirror on the side the approaching vehicle is coming from. If you turn the turn signal on for that side of your vehicle, the alert indicator flashes.

# Blind Spot Information System (If Equipped)

## BLIND SPOT INFORMATION SYSTEM – TROUBLESHOOTING

### BLIND SPOT INFORMATION SYSTEM – INFORMATION MESSAGES

<b>Message</b>	<b>Action</b>
Blind Spot System Fault	A fault with the system has occurred. Have your vehicle checked as soon as possible.
Blind Spot Not Available Sensor Blocked See Manual	Something is blocking the sensors. Clean the sensors.
Blind Spot Alert Deactivated Trailer Attached	The system automatically turns off and displays this message when you connect a trailer to the vehicle that does not have a trailer blind spot system or when you switch the trailer blind spot system off through the touchscreen.

# Cross Traffic Alert (If Equipped)

## WHAT IS CROSS TRAFFIC ALERT

The system alerts you of vehicles approaching from the sides behind your vehicle when you shift into reverse (R).

## HOW DOES CROSS TRAFFIC ALERT WORK

Cross Traffic Alert detects vehicles that approach at a speed between 4–37 mph (6–60 km/h). Coverage decreases when the sensors are partially, mostly or fully obstructed.

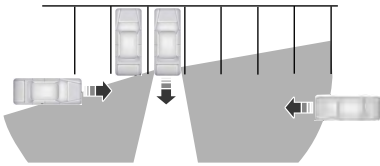

The sensor on the left-hand side is only partially obstructed and zone coverage on the right-hand side is maximized.

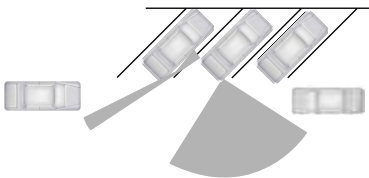

Zone coverage also decreases when parking at narrow angles. The sensor on the left-hand side is mostly obstructed and zone coverage on that side is severely reduced.

**Note:** *Slowly reversing helps increase the coverage area and effectiveness.*

## CROSS TRAFFIC ALERT PRECAUTIONS

**WARNING:** Do not use the cross traffic alert system as a replacement for using the interior and exterior mirrors or looking over your shoulder before reversing out of a parking space. The cross traffic alert system is not a replacement for careful driving.

**WARNING:** The system may not operate properly during severe weather conditions, for example snow, ice, heavy rain and spray. Always drive with due care and attention. Failure to take care may result in a crash.

## CROSS TRAFFIC ALERT LIMITATIONS

Cross Traffic Alert may not correctly operate when any of the following occur:

- Something is blocking the sensors.
- Adjacently parked vehicles or objects are obstructing the sensors.
- Vehicles approach at speeds less than 4 mph (6 km/h) or greater than 37 mph (60 km/h).
- Your vehicle speed is greater than 7 mph (12 km/h).
- You reverse out of an angled parking space.

## Cross Traffic Alert (If Equipped)

### Cross Traffic Alert Limitations with a Trailer Attached

The system remains on when you attach a trailer in vehicles with blind spot information system with trailer tow under the following conditions:

- You connect a trailer.
- The trailer is a bike rack or cargo rack with a maximum length of 3 ft (1 m).
- You set the trailer length to 3 ft (1 m) in the instrument cluster display.

**Note:** *The system may not correctly operate when towing a trailer. For vehicles with an approved trailer tow module and tow bar, the system turns off when you attach a trailer. For vehicles with an aftermarket trailer tow module or tow bar, we recommend that you switch the system off when you attach a trailer.*

### SWITCHING CROSS TRAFFIC ALERT ON AND OFF - VEHICLES WITH: 4.2 INCH SCREEN

To switch the system on or off, use the instrument cluster display:

1. Select **Driver Assist**.
2. Select **Cross Traffic Alert**.
3. Switch the feature on or off.

**Note:** *The system switches on every time you switch the ignition on. To permanently switch the system off, contact an authorized dealer.*

### SWITCHING CROSS TRAFFIC ALERT ON AND OFF - VEHICLES WITH: 8 INCH SCREEN

To switch the system on or off, use the instrument cluster display:

1. Select **Driver Assist**.
2. Select **Cross Traffic Alert**.
3. Switch the feature on or off.

**Note:** *The system switches on every time you switch the ignition on. To permanently switch the system off, contact an authorized dealer.*

### LOCATING THE CROSS TRAFFIC ALERT SENSORS



The sensors are inside the brake lamp on both sides of your vehicle.

**Note:** *Keep the sensors free from snow, ice and large accumulations of dirt.*

**Note:** *Do not cover the sensors with bumper stickers, repair compound or other objects.*

**Note:** *Blocked sensors may affect system accuracy.*

If something is blocking the sensors, a message may appear in the information display when you shift into reverse (R).

## Cross Traffic Alert (If Equipped)

**Note:** *Bike and cargo racks could cause false alerts due to obstruction of the sensor. We recommend switching the feature off when using a bike or cargo rack.*

### CROSS TRAFFIC ALERT INDICATORS



When the cross traffic alert detects an approaching vehicle, a tone sounds, a warning lamp illuminates in the relevant exterior mirror and arrows appear in the information display to show which side the vehicle is approaching from.

If the system malfunctions, a warning lamp illuminates in the instrument cluster and a message appears in the information display. Have your vehicle checked as soon as possible.

**Note:** *If arrows do not display, a message appears in the information display.*

**Note:** *In some conditions, the system could alert you, even when there is nothing in the detection zone, for example a vehicle passing further away from your vehicle.*

### CROSS TRAFFIC ALERT – TROUBLESHOOTING

#### CROSS TRAFFIC ALERT – INFORMATION MESSAGES

Message	Action
Cross Traffic Alert	Displays instead of indication arrows when the system detects a vehicle. Check for approaching traffic.
Cross Traffic Not Available Sensor Blocked See Manual	Indicates blocked cross traffic alert system sensors. Clean the sensors. If the message continues to appear, have your vehicle checked as soon as possible.
Cross Traffic System Fault	The system has malfunctioned. Have your vehicle checked as soon as possible.
Cross Traffic Alert Deactivated Trailer Attached	Displays if you attach a trailer to your vehicle.

# Pre-Collision Assist (If Equipped)

## WHAT IS PRE-COLLISION ASSIST

Pre-collision assist detects and warns of approaching hazards in the roadway. If your vehicle is rapidly approaching another stationary vehicle, a vehicle traveling in the same direction as yours, or a pedestrian within your driving path, the system provides multiple levels of assistance to help avoid a collision.

## HOW DOES PRE-COLLISION ASSIST WORK

The system warns the driver of potential hazards by providing three levels of assistance.



If your vehicle is rapidly approaching potential hazards, the system provides the following levels of functionality:

1. Alert.
2. Brake Support.
3. Automatic Emergency Braking.



**Alert:** When active, a flashing visual warning appears and an audible warning tone sounds.

**Brake Support:** The system is designed to help reduce the impact speed by preparing the brakes for rapid braking. The system does not automatically apply the brakes. If you press the brake pedal, the system could apply additional braking up to maximum braking force, even if you lightly press the brake pedal.

**Automatic Emergency Braking:** This may activate if the system determines that a collision is imminent.

**Note:** If you perceive pre-collision assist alerts as being too frequent or disturbing, you can reduce the alert sensitivity, although we recommend using the highest sensitivity setting where possible. Setting a lower sensitivity leads to fewer and later system warnings.

Each system has various levels of detection capabilities. See **Pre-Collision Assist Limitations** (page 302).

## PRE-COLLISION ASSIST PRECAUTIONS



**WARNING:** You are responsible for controlling your vehicle at all times. The system is designed to be an aid and does not relieve you of your responsibility to drive with due care and attention. Failure to follow this instruction could result in the loss of control of your vehicle, personal injury or death.



**WARNING:** The system does not detect vehicles that are driving in a different direction, cyclists or animals. Apply the brakes when necessary. Failure to follow this instruction could result in the loss of control of your vehicle, personal injury or death.



**WARNING:** The system does not operate during hard acceleration or steering. Failure to take care may lead to a crash or personal injury.



**WARNING:** The system may fail or operate with reduced function during cold and severe weather conditions. Snow, ice, rain, spray and fog can adversely affect the system. Keep the front camera and radar free of snow and ice. Failure to take care may result in the loss of control of your vehicle, serious personal injury or death.



## Pre-Collision Assist (If Equipped)



**WARNING:** Take additional care if your vehicle is heavily loaded or you are towing a trailer. These conditions could result in reduced performance of this system. Failure to follow this instruction could result in the loss of control of your vehicle, personal injury or death.



**WARNING:** The system cannot help prevent all crashes. Do not rely on this system to replace driver judgment and the need to maintain a safe distance and speed.



**WARNING:** In situations where the vehicle camera has limited detection capability, this may reduce system performance. These situations include but are not limited to direct or low sunlight, vehicles at night without tail lights, unconventional vehicle types, pedestrians with complex backgrounds, running pedestrians, partly obscured pedestrians, or pedestrians that the system cannot distinguish from a group. Failure to take care may result in the loss of control of your vehicle, serious personal injury or death.

### PRE-COLLISION ASSIST LIMITATIONS

Pre-collision assist depends on the detection ability of its camera and sensors. Any obstructions or damage to these areas can limit detection or prevent the system from functioning. See **Locating the Pre-Collision Assist Sensors** (page 303).

The system is active at speeds above 3 mph (5 km/h).

**Note:** The Pre-Collision Assist system disables when you select **4X4 LOW**, **Deep Snow/Sand** mode, **Rock Crawl** mode, or when you manually disable AdvanceTrac™.

**Note:** Brake support and automatic emergency braking are active at speeds up to 80 mph (130 km/h). If your vehicle has a radar sensor included with adaptive cruise control, then brake support and automatic emergency braking are active up to the maximum speed of the vehicle.

### Pedestrian Detection Limitations

Pedestrian detection is active at speeds up to 50 mph (80 km/h).

Pedestrian detection operates optimally when detected hazards are clearly identifiable. System performance may reduce in situations where pedestrians are running, partly obscured, have a complex background, or cannot be distinguished from a group.

### SWITCHING PRE-COLLISION ASSIST ON AND OFF - VEHICLES WITH: 2.3 INCH SCREEN

To switch the system on or off, use the instrument cluster display:

1. Select **Driver Assist**.
2. Select **Pre-Collision**.
3. Switch the feature on or off.

**Note:** If your vehicle has a radar sensor, we recommend that you switch the system off if you install a snow plow or similar object in such a way that it may block the radar sensor. Your vehicle remembers the selected setting across key cycles.

## Pre-Collision Assist (If Equipped)

### SWITCHING PRE-COLLISION ASSIST ON AND OFF - VEHICLES WITH: 4.2 INCH SCREEN

To switch the system on or off, use the instrument cluster display:

1. Select **Driver Assist**.
2. Select **Pre-Collision**.
3. Switch the feature on or off.

**Note:** If your vehicle has a radar sensor, we recommend that you switch the system off if you install a snow plow or similar object in such a way that it may block the radar sensor. Your vehicle remembers the selected setting across key cycles.

### SWITCHING PRE-COLLISION ASSIST ON AND OFF - VEHICLES WITH: 8 INCH SCREEN

To switch the system on or off, use the instrument cluster display:

1. Select **Driver Assist**.
2. Select **Pre-Collision**.
3. Switch the feature on or off.

**Note:** If your vehicle has a radar sensor, we recommend that you switch the system off if you install a snow plow or similar object in such a way that it may block the radar sensor. Your vehicle remembers the selected setting across key cycles.

### LOCATING THE PRE-COLLISION ASSIST SENSORS

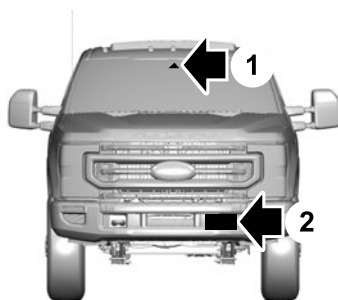

1. Camera.
2. Radar sensor (if equipped).

If a message regarding a blocked sensor or camera appears in the information display, something is obstructing the radar signals or camera images. The radar sensor is behind the fascia cover in the center of the lower grille. With a blocked sensor or camera, the system may not function, or performance may reduce. See **Pre-Collision Assist – Information Messages** (page 307).

**Note:** Proper system operation requires a clear view of the road by the camera. Have any windshield damage in the area of the camera's field of view repaired.

**Note:** If something hits the front end of your vehicle or damage occurs and your vehicle has a radar sensor, the radar sensing zone could change. This could cause missed or false vehicle detections. Have your vehicle serviced to have the radar checked for proper coverage and operation.

## Pre-Collision Assist (If Equipped)

**Note:** If your vehicle detects excessive heat at the camera or a potential misalignment condition, a message could display in the information display indicating temporary sensor unavailability. When operational conditions are correct, the message deactivates. For example, when the ambient temperature around the sensor decreases or the sensor recalibrates successfully.

### DISTANCE INDICATION (IF EQUIPPED)

#### WHAT IS DISTANCE INDICATION

Distance indication displays the gap between your vehicle and the vehicle ahead of you.

**Note:** The graphic does not display if you switch on cruise control or adaptive cruise control.

Vehicle Speed	System Sensitivity	Distance Indicator Color	Distance Gap	Time Gap
62 mph (100 km/h).	Normal.	Gray.	Greater than 82 ft (25 m).	Greater than 0.9 seconds.
		Yellow.	56–82 ft (17–25 m).	0.6–0.9 seconds.
		Red.	Less than 56 ft (17 m).	Less than 0.6 seconds.

## Pre-Collision Assist (If Equipped)

### SWITCHING DISTANCE INDICATION ON AND OFF - VEHICLES WITH: 2.3 INCH SCREEN

To switch the system on or off, use the instrument cluster display:

1. Select **Driver Assist**.
2. Select **Pre-Collision**.
3. Select **Distance Indication**.
4. Switch the feature on or off.

### SWITCHING DISTANCE INDICATION ON AND OFF - VEHICLES WITH: 4.2 INCH SCREEN

To switch the system on or off, use the instrument cluster display:

1. Select **Driver Assist**.
2. Select **Pre-Collision**.
3. Select **Distance Indication**.
4. Switch the feature on or off.

### SWITCHING DISTANCE INDICATION ON AND OFF - VEHICLES WITH: 8 INCH SCREEN

To switch the system on or off, use the instrument cluster display:

1. Select **Driver Assist**.
2. Select **Pre-Collision**.
3. Select **Distance Indication**.
4. Switch the feature on or off.

### DISTANCE INDICATION INDICATOR

The indicator displays the time gap between your vehicle and vehicles traveling in the same direction ahead of you.



### DISTANCE ALERT (IF EQUIPPED)

#### WHAT IS DISTANCE ALERT

The system alerts you with a warning lamp if the distance to the vehicle ahead is small.

**Note:** *The warning lamp does not illuminate if cruise control or adaptive cruise control is active.*

#### ADJUSTING THE SENSITIVITY OF DISTANCE ALERT - VEHICLES WITH: 2.3 INCH SCREEN

To switch the system on or off, use the instrument cluster display:

1. Select **Driver Assist**.
2. Select **Pre-Collision**.
3. Select **Alert Sens.**

## Pre-Collision Assist (If Equipped)

4. Select a setting.

### ADJUSTING THE SENSITIVITY OF DISTANCE ALERT - VEHICLES WITH: 4.2 INCH SCREEN

To switch the system on or off, use the instrument cluster display:

1. Select **Driver Assist**.
2. Select **Pre-Collision**.
3. Select **Alert Sensitivity**.
4. Select a setting.

### ADJUSTING THE SENSITIVITY OF DISTANCE ALERT - VEHICLES WITH: 8 INCH SCREEN

To switch the system on or off, use the instrument cluster display:

1. Select **Driver Assist**.
2. Select **Pre-Collision**.
3. Select **Alert Sensitivity**.
4. Select a setting.

## AUTOMATIC EMERGENCY BRAKING

### WHAT IS AUTOMATIC EMERGENCY BRAKING

Automatic emergency braking may activate if the system determines that a collision is imminent. The system may help reduce impact damage to avoid the crash completely.

Automatic emergency braking is only available up to certain speeds. See **Pre-Collision Assist Limitations** (page 302).

### SWITCHING AUTOMATIC EMERGENCY BRAKING ON AND OFF - VEHICLES WITH: 2.3 INCH SCREEN

To switch the system on or off, use the instrument cluster display:

1. Select **Driver Assist**.
2. Select **Pre-Collision**.
3. Select **Active Brak.**
4. Switch the feature on or off.

**Note:** *Automatic emergency braking turns on every time you switch the ignition on.*

### SWITCHING AUTOMATIC EMERGENCY BRAKING ON AND OFF - VEHICLES WITH: 4.2 INCH SCREEN

To switch the system on or off, use the instrument cluster display:

1. Select **Driver Assist**.
2. Select **Pre-Collision**.
3. Select **Active Braking**.
4. Switch the feature on or off.

**Note:** *Automatic emergency braking turns on every time you switch the ignition on.*

### SWITCHING AUTOMATIC EMERGENCY BRAKING ON AND OFF - VEHICLES WITH: 8 INCH SCREEN

To switch the system on or off, use the instrument cluster display:

1. Select **Driver Assist**.
2. Select **Pre-Collision**.
3. Select **Active Braking**.
4. Switch the feature on or off.

**Note:** *Automatic emergency braking turns on every time you switch the ignition on.*

## Pre-Collision Assist (If Equipped)

---

### PRE-COLLISION ASSIST – TROUBLESHOOTING

#### PRE-COLLISION ASSIST – INFORMATION MESSAGES

<b>Message</b>	<b>Action</b>
Pre-Collision Assist Not Available Sensor Blocked	You have a blocked sensor due to bad weather, ice, mud or water in front of the radar sensor. You can typically clean the sensor to resolve.
Pre-Collision Assist Not Available	A fault with the system has occurred. Have your vehicle checked as soon as possible.

# Pre-Collision Assist (If Equipped)

---

## **PRE-COLLISION ASSIST – FREQUENTLY ASKED QUESTIONS**

### **Camera Troubleshooting**

#### **The windshield in front of the camera is dirty or obstructed.**

Clean the outside of the windshield in front of the camera.

#### **The windshield in front of the camera is clean, but the message remains in the instrument cluster display.**

Wait a short time. It could take several minutes for the camera to detect that there is no obstruction.

### **Radar Troubleshooting (If Equipped)**

#### **The surface of the radar in the grille is dirty or obstructed.**

Clean the grille surface in front of the radar or remove the object causing the obstruction.

#### **The surface of the radar in the grille is clean, but the message remains in the instrument cluster display.**

Wait a short time. It could take several minutes for the radar to detect that there is no obstruction.

#### **Heavy rain, spray or fog is interfering with the radar signals.**

The pre-collision assist system is temporarily disabled. Pre-collision assist reactivates a short time after the weather conditions improve.

#### **Swirling water or snow or ice on the surface of the road is interfering with the radar signals.**

The pre-collision assist system is temporarily disabled. Pre-collision assist reactivates a short time after the weather conditions improve.

#### **Radar is out of alignment due to a front-end impact.**

Have your vehicle serviced to have the radar checked for proper coverage and operation.

# Driver Alert

## WHAT IS DRIVER ALERT

Driver alert alerts you if it determines that you are becoming drowsy or if your driving deteriorates.

## HOW DOES DRIVER ALERT WORK

Driver Alert calculates your alertness level based on your driving behavior in relation to the lane markings and other factors through use of the front camera sensor behind the interior mirror.

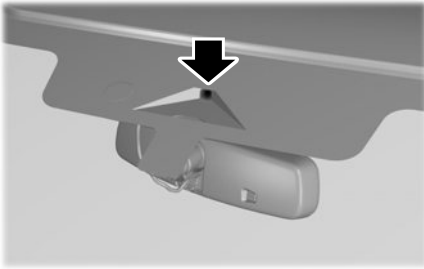

## DRIVER ALERT PRECAUTIONS

**WARNING:** You are responsible for controlling your vehicle at all times. The system is designed to be an aid and does not relieve you of your responsibility to drive with due care and attention. Failure to follow this instruction could result in the loss of control of your vehicle, personal injury or death.

**WARNING:** Take regular rest breaks if you feel tired. Do not wait for the system to warn you.

**WARNING:** Certain driving styles may result in the system warning you even if you are not feeling tired.

**WARNING:** In cold and severe weather conditions the system may not function. Rain, snow and spray can all limit sensor performance.

**WARNING:** The system will not operate if the sensor cannot track the road lane markings.

**WARNING:** If damage occurs in the immediate area surrounding the sensor, have your vehicle checked as soon as possible.

**WARNING:** The system may not correctly operate if your vehicle is fitted with a suspension kit not approved by us.

**WARNING:** The system may not operate properly if the sensor is blocked. Keep the windshield free from obstruction.

**Note:** If something is blocking the camera or damaged the windshield, Driver Alert may not function.

## DRIVER ALERT LIMITATIONS

Driver alert may not function correctly if:

- The sensor cannot track the road lane markings.
- Your vehicle's speed is less than approximately 40 mph (65 km/h).



# Driver Alert

## SWITCHING DRIVER ALERT ON AND OFF - VEHICLES WITH: 4.2 INCH SCREEN

To switch the system on or off, use the instrument cluster display:

1. Select **Driver Assist**.
2. Select **Driver Alert**.
3. Switch the feature on or off.

**Note:** *The system remains on or off depending on how it was last set.*

### Resetting Driver Alert

You can reset the system by either:

- Switching the ignition off and on.
- Stopping the vehicle and then opening and closing the driver door.

## SWITCHING DRIVER ALERT ON AND OFF - VEHICLES WITH: 8 INCH SCREEN

To switch the system on or off, use the instrument cluster display:

1. Select **Driver Assist**.
2. Select **Driver Alert**.
3. Switch the feature on or off.

**Note:** *The system remains on or off depending on how it was last set.*

### Resetting Driver Alert

You can reset the system by either:

- Switching the ignition off and on.
- Stopping the vehicle and then opening and closing the driver door.

## DRIVER ALERT – TROUBLESHOOTING

### DRIVER ALERT – INFORMATION MESSAGES

Message	Action
Driver Alert Warning Rest Now	Stop and rest as soon as it is safe to do so.
Driver Alert Warning Rest Suggested	Take a rest soon.

# Load Carrying

## LOAD CARRYING PRECAUTIONS

Keep your loaded vehicle weight within its design rating capability, with or without a trailer. Properly loading your vehicle provides maximum return of vehicle design performance. Before you load your vehicle, become familiar with the following terms for determining your vehicle's weight rating, with or without a trailer, from the vehicle's Tire and Loading Information label or Safety Compliance Certification label.



**WARNING:** Vehicles with a higher center of gravity (utility and four-wheel drive vehicles) handle differently than vehicles with a lower center of gravity (passenger cars). Avoid sharp turns, excessive speed and abrupt steering in these vehicles. Failure to drive cautiously increases the risk of losing control of your vehicle, vehicle rollover, personal injury and death.



**WARNING:** The appropriate loading capacity of your vehicle can be limited either by volume capacity (how much space is available) or by payload capacity (how much weight the vehicle should carry). Once you have reached the maximum

payload of your vehicle, do not add more cargo, even if there is space available. Overloading or improperly loading your vehicle can contribute to loss of vehicle control and vehicle rollover.



**WARNING:** Exceeding the Safety Compliance Certification label vehicle weight limits can adversely affect the performance and handling of your vehicle, cause vehicle damage and can result in the loss of control of your vehicle, serious personal injury or death.



**WARNING:** Do not use replacement tires with lower load carrying capacities than the original tires because they may lower your vehicle's GVWR and GAWR limitations. Replacement tires with a higher limit than the original tires do not increase the GVWR and GAWR limitations.



**WARNING:** Do not exceed the GVWR or the GAWR specified on the certification label.



**WARNING:** Exceeding any vehicle weight rating can adversely affect the performance and handling of your vehicle, cause vehicle damage and can result in the loss of control of your vehicle, serious personal injury or death.

# Load Carrying



**WARNING:** When loading the roof racks, we recommend you evenly distribute the load, as well as maintain a low center of gravity. Loaded vehicles, with higher centers of gravity, may handle differently than unloaded vehicles. Take extra precautions, such as slower speeds and increased stopping distance, when driving a heavily loaded vehicle.

## LOCATING THE SAFETY COMPLIANCE CERTIFICATION LABELS

### Safety Compliance Certification Label Example:

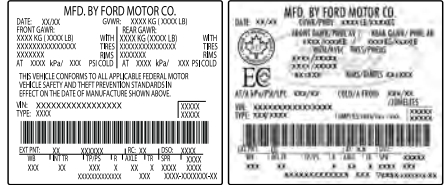

The gross combined weight must never exceed the Gross Combined Weight Rating.

## USING A SLIDE-IN CAMPER

For information regarding the use of slide-in campers, consult the Truck Camper Loading document supplied with your vehicle.

**Note:** We do not recommend using a slide-in camper on an F-150 SuperCrew cab.

**Note:** We do not recommend using a slide-in camper on a Raptor.

The Safety Compliance Certification label is located on the door hinge pillar, door-latch post, or the door edge that meets the door-latch post, next to the driver seating position.

## WHAT IS THE GROSS AXLE WEIGHT RATING

### GAWR (Gross Axle Weight Rating)

GAWR is the maximum allowable weight that a single axle (front or rear) can carry. These numbers are on the Safety Compliance Certification label.

## WHAT IS THE GROSS VEHICLE WEIGHT RATING

GVWR is the maximum allowable weight of the fully loaded vehicle. This includes all options, equipment, passengers and cargo. It appears on the Safety Compliance Certification label.

# Load Carrying

---

## WHAT IS THE GROSS COMBINED WEIGHT RATING

Gross Combined Weight Rating (GCWR) is the maximum allowable weight of the vehicle and the loaded trailer, including all cargo and passengers, that the vehicle can handle without risking damage. (Important: The towing vehicle's braking system is rated for operation at Gross Vehicle Weight Rating, not at Gross

Combined Weight Rating.) Separate functional brakes should be used for safe control of towed vehicles and for trailers where the Gross Combined Weight of the towing vehicle plus the trailer exceed the Gross Vehicle Weight Rating of the towing vehicle.

**Note:** For trailer towing information refer to the *RV and Trailer Towing Guide* available at an authorized dealer, or online at the website that follows.

RV & Trailer Towing Guide Online	
Website	<a href="http://www.fleet.ford.com/towing-guides">www.fleet.ford.com/towing-guides</a>

# Load Carrying

## CALCULATING PAYLOAD

### Tire and Loading Label Information

#### Example:



#### TIRE AND LOADING INFORMATION

SEATING CAPACITY TOTAL : 5 FRONT: 2 REAR: 3

The combined weight of occupants, and cargo should never exceed 385 kg or 850 lbs.

TIRE	SIZE	COLD TIRE PRESSURE	SEE OWNERS MANUAL FOR ADDITIONAL INFORMATION
FRONT	235/45R18 94V	235 KPA, 34 PSI	
REAR	235/45R18 94V	235 KPA, 34 PSI	
SPARE	NONE	NONE	



#### TIRE AND LOADING INFORMATION RENSEIGNEMENTS SUR LES PNEUS ET LE CHARGEMENT

SEATING CAPACITY TOTAL 5 FRONT 2 REAR 3  
NOMBRE DE PLACES

The combined weight of occupants and cargo should never exceed 396 kg or 875 lbs.  
Le poids total des occupants et du chargement ne doit jamais dépasser

TIRE PNEU	SIZE DIMENSIONS	COLD TIRE PRESSURE PRESSION DES PNEUS A FROID	SEE OWNER'S MANUAL FOR ADDITIONAL INFORMATION  VOIR LE MANUEL DE L'USAGER POUR PLUS DE RENSEIGNEMENTS
FRONT AVANT	235/40R19 96V	255 KPA, 37 PSI	
REAR ARRIERE	235/40R19 96V	255 KPA, 37 PSI	
SPARE DE SECOURS	T125/80R16 97M	415 KPA, 60 PSI	

Payload is the combined weight of cargo and passengers that your vehicle is carrying. The maximum payload for your vehicle appears on the Tire and Loading label. The label is either on the B-pillar or the edge of the driver door. Vehicles exported outside the US and Canada may not have a tire and loading label. Look for "The combined weight of occupants and cargo should never exceed XXX kg or XXX lb" for maximum payload. The payload listed on the Tire and Loading Information label

is the maximum payload for your vehicle as built by the assembly plant. If you install any additional equipment on your vehicle, you must determine the new payload. Subtract the weight of the equipment from the payload listed on the Tire and Loading label. When towing, trailer tongue weight or king pin weight is also part of payload.

## CALCULATING THE LOAD LIMIT

Steps for determining the correct load limit:

1. Locate the statement "The combined weight of occupants and cargo should never exceed XXX kg or XXX lb." on your vehicle's placard.
2. Determine the combined weight of the driver and passengers that will be riding in your vehicle.
3. Subtract the combined weight of the driver and passengers from XXX kg or XXX lb.
4. The resulting figure equals the available amount of cargo and luggage load capacity. For example, if the "XXX" amount equals 1,400 lb. and there will be five 150 lb. passengers in your vehicle, the amount of available cargo and luggage load capacity is 650 lb. (1400-750 (5 x 150) = 650 lb.)

## Load Carrying

- Determine the combined weight of luggage and cargo being loaded on the vehicle. That weight may not safely exceed the available cargo and luggage load capacity calculated in Step 4.
- If your vehicle will be towing a trailer, load from your trailer will be transferred to your vehicle. Consult this manual to determine how this reduces the available cargo and luggage load capacity of your vehicle.

### Helpful examples for calculating the available amount of cargo and luggage load capacity

Suppose your vehicle has a 1400-pound (635-kilogram) cargo and luggage capacity. You decide to go golfing. Is there enough load capacity to carry you, four of your friends and all the golf bags? You and four friends average 220 pounds (99 kilograms) each and the golf bags weigh approximately 30 pounds (13.5 kilograms) each. The calculation would be:  $1400 - (5 \times 220) - (5 \times 30) = 1400 - 1100 - 150 = 150$  pounds. Yes, you have enough load capacity in your vehicle to transport four friends and your golf bags. In metric units, the calculation would be:  $635 \text{ kilograms} - (5 \times 99 \text{ kilograms}) - (5 \times 13.5 \text{ kilograms}) = 635 - 495 - 67.5 = 72.5$  kilograms.

Suppose your vehicle has a 1400-pound (635-kilogram) cargo and luggage capacity. You and one of your friends decide to pick up cement from the local home improvement store to finish that patio you have been planning for the past two years. Measuring the inside of the vehicle with the rear seat folded down, you have room for twelve 100-pound (45-kilogram) bags of cement. Do you have enough load capacity to transport the cement to your home? If you and your friend each weigh 220 pounds (99 kilograms), the calculation would be:  $1400 - (2 \times 220) - (12 \times 100) = 1400 - 440 - 1200 = -240$  pounds. No, you do not have enough cargo capacity to carry that much weight. In metric units, the calculation would be:  $635 \text{ kilograms} - (2 \times 99 \text{ kilograms}) - (12 \times 45 \text{ kilograms}) = 635 - 198 - 540 = -103$  kilograms. You will need to reduce the load weight by at least 240 pounds (104 kilograms). If you remove three 100-pound (45-kilogram) cement bags, then the load calculation would be:  $1400 - (2 \times 220) - (9 \times 100) = 1400 - 440 - 900 = 60$  pounds. Now you have the load capacity to transport the cement and your friend home. In metric units, the calculation would be:  $635 \text{ kilograms} - (2 \times 99 \text{ kilograms}) - (9 \times 45 \text{ kilograms}) = 635 - 198 - 405 = 32$  kilograms.

## Load Carrying

---

The above calculations also assume that the loads are positioned in your vehicle in a manner that does not overload the front or the rear gross axle weight rating specified for your vehicle on the Safety Compliance Certification label.

# Pickup Bed

## PICKUP BED PRECAUTIONS

**⚠️ WARNING:** Do not allow people or animals in truck beds that have modifications, such as bed covers or slide-in campers, when the engine is running. Exhaust fumes are toxic. Failure to follow this instruction could result in personal injury or death.

**⚠️ WARNING:** It is extremely dangerous to ride in a cargo area, inside or outside of a vehicle. In a crash, people riding in these areas are more likely to be seriously injured or killed. Do not allow people to ride in any area of your vehicle that is not equipped with seats and seatbelts. Make sure everyone in your vehicle is in a seat and properly using a seatbelt. Failure to follow this warning could result in serious personal injury or death.

the maximum payload of your vehicle, do not add more cargo, even if there is space available. Overloading or improperly loading your vehicle can contribute to loss of vehicle control and vehicle rollover.

**⚠️ WARNING:** It is extremely dangerous to ride in a cargo area, inside or outside of a vehicle. In a crash, people riding in these areas are more likely to be seriously injured or killed. Do not allow people to ride in any area of your vehicle that is not equipped with seats and seatbelts. Make sure everyone in your vehicle is in a seat and properly using a seatbelt. Failure to follow this warning could result in serious personal injury or death.

## PICKUP BED ANCHOR POINTS

(IF EQUIPPED)

### PICKUP BED ANCHOR POINT PRECAUTIONS

**⚠️ WARNING:** Always properly secure cargo to prevent shifting cargo or cargo falling from the vehicle. Failure to do so could result in compromised vehicle stability and serious personal injury to vehicle occupants or others.

**⚠️ WARNING:** The appropriate loading capacity of your vehicle can be limited either by volume capacity (how much space is available) or by payload capacity (how much weight the vehicle should carry). Once you have reached

## LOCATING THE PICKUP BED ANCHOR POINTS

The pickup bed anchor points are located at each corner of the pickup bed.





# Pickup Bed

## INSTALLING AND REMOVING THE PICKUP BED TIE-DOWN CLEATS

### Installing the Cleats

1. Insert the key into the lock and turn clockwise to unlock.
2. Insert the cleat into the pickup bed anchor point and slide upward.
3. Turn the key counterclockwise to lock.

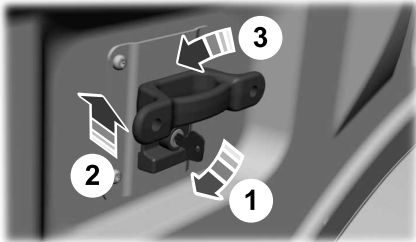

**Note:** Leave the key in the lock when removing or installing the cleats. The key cannot be removed unless it is in the locked position.

### Removing the Cleats

To remove, reverse the installation procedure.

## PICKUP BED ANCHOR POINT LOAD CAPACITIES

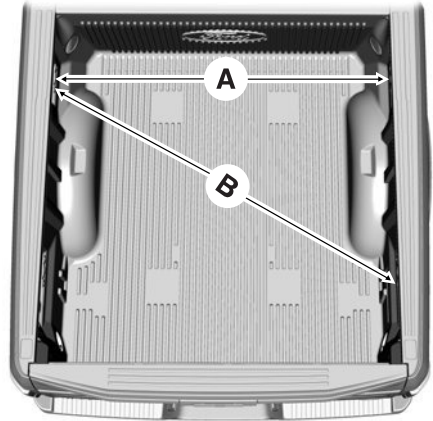

A	B
Maximum force between directly opposed cleats 276 lb (125 kg).	Maximum force between diagonally opposed cleats 600 lb (272 kg).

**Note:** You could damage the pickup bed walls if you overload the tie downs.

**Note:** Make sure that you properly balance and secure the cargo load. Failure to do this can cause cargo instability and damage to the box.

**Note:** Do not secure cargo with tie downs connected from the tie down brackets to the cargo box tie downs. This could cause the tailgate to detach.

# Pickup Bed

## TAILGATE ANCHOR POINTS (IF EQUIPPED)

### LOCATING THE TAILGATE ANCHOR POINTS

The tailgate anchor points are located at each side of the tailgate.

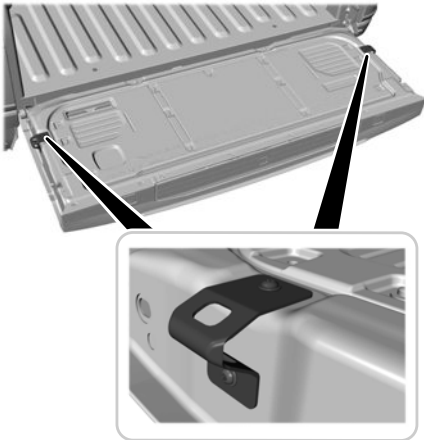

**Note:** You could damage the tailgate if you overload the tie downs.

## TAILGATE ANCHOR POINT LOAD CAPACITIES

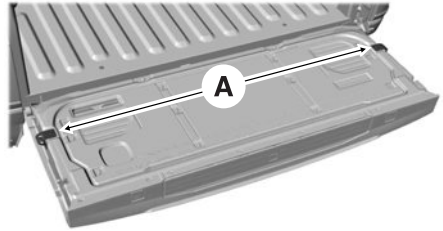

**A**

The maximum force between the tailgate anchor points 400 lb (181 kg).

**Note:** Do not secure cargo from a pickup bed anchor point to a tailgate anchor point. This could cause the tailgate to detach.

## PICKUP BED RAMPS (IF EQUIPPED)

### PICKUP BED RAMP PRECAUTIONS

**WARNING:** When sliding the ramp up or down, take care not to get your fingers or hands caught in the mechanism. Failure to follow this instruction could result in personal injury.

**WARNING:** Make sure that you correctly install the ramp to the tailgate plate. Failure to follow this instruction could result in personal injury.

# Pickup Bed



**WARNING:** Do not step or sit on the ramp when it is in the stowed position. Failure to follow this instruction could result in personal injury.



**WARNING:** Only install the ramp within the prescribed ramp angles. Failure to follow this instruction could result in personal injury.

**Note:** Each pickup bed ramp has a maximum capacity of 400 lb (181.4 kg).

**Note:** Verify the ramp is on stable ground before usage.

**Note:** For loading and unloading equipment, your ramp should be set between 10 degrees upward and 26 degrees downward to avoid damage to the ramp claw and tailgate plate.

**Note:** When using your vehicle for off-road operation, remove the bed ramps from the vehicle and store them in a safe location away from your vehicle.

## INSTALLING AND REMOVING THE PICKUP BED RAMP HOLDER

### Installing the Ramp Holder

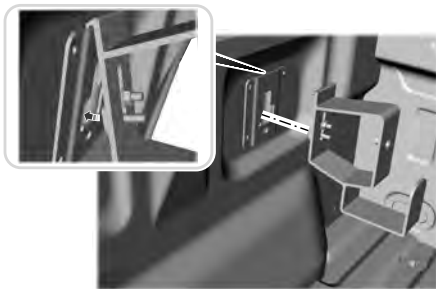

1. Hook the top of the ramp holder over the mounting plate and rotate the ramp holder into position.

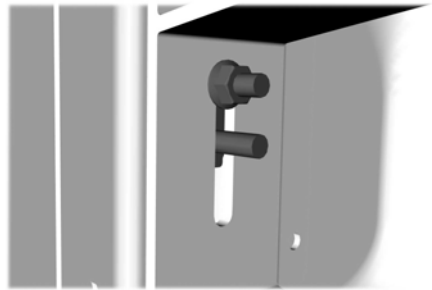

2. Slide the ramp holder studs upwards into the installed position.
3. Tighten the ramp holder nut.

**Note:** The nut should be on the upper stud.

### Removing the Ramp Holder

Remove in the reverse order.

## INSTALLING AND REMOVING THE PICKUP BED RAMPS

**Note:** You cannot use the pickup bed ramps with the tailgate work surface or tailgate step.

### Installing the Bed Ramp

1. Remove the front and rear cables.

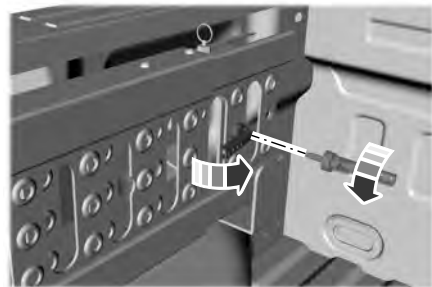

2. Open the cam lever arms and unscrew the cam bolts.

# Pickup Bed

3. Remove the ramp from the ramp holder.



4. Rotate the stops at the underside of the ramp to the open position.

**Note:** You can use a smooth surface tool to rotate the stops.

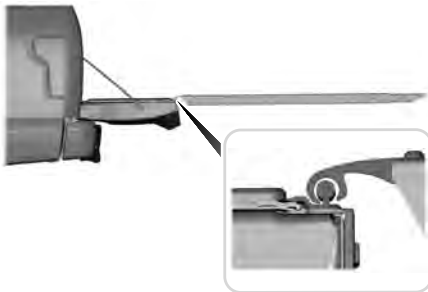

5. Slide the ramp claw onto the tailgate plate.

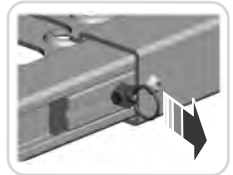

6. Pull the location pin outward and extend the ramp until the pin is seated in the usage position, then set the ramp on even ground.

## Removing the Ramp

Remove in the reverse order.

## STORING THE PICKUP BED RAMPS

### Storing the Bed Ramp

1. Pick up the ramp. Pull the location pin outward.
2. Slide the ramp into the storage position until the location pin locks.

**Note:** Make sure the proper pin location has been applied for your bed size.

## Pickup Bed

---

3. Slide the ramp claw off of the tailgate plate.
4. Rotate the stops at the underside of the ramp to the closed position.

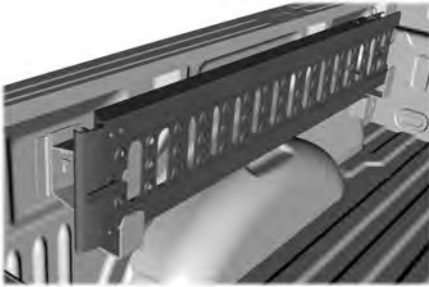

5. Place the ramp into the ramp holder.
6. Install the cam bolts and close the cam lever arms.
7. Attach the front and rear cables.

**Note:** Make sure you properly secure the locking cable. If the locking cable is unsecured, you may hear a rattling noise.

# Connecting a Trailer

## CONNECTING A TRAILER PRECAUTIONS



**WARNING:** Do not adjust the spring bars so that your vehicle's rear bumper is higher than before attaching the trailer. Doing so will defeat the function of the weight-distributing hitch, which may cause unpredictable handling, and could result in serious personal injury.

Do not tow a trailer until you drive your vehicle at least 1,000 mi (1,600 km).

Consult your local motor vehicle laws for towing a trailer.

See the instructions included with towing accessories for the proper installation and adjustment specifications.

Service your vehicle more frequently if you tow a trailer. See **Normal Scheduled Maintenance** (page 625).

If you use a rental trailer, follow the instructions the rental agency gives you.

When attaching the trailer wiring connector to your vehicle, only use a proper fitting connector that works with the vehicle and trailer functions.

Account for the trailer coupler weight as part of your vehicle load when calculating the total vehicle weight.

Do not exceed the load limits. See **Calculating the Load Limit** (page 314).

## HITCHES

### INSTALLING A HITCH



**WARNING:** You must use the heavy-duty drawbar pin supplied with your vehicle when using the heavy-duty hitch. Failure to follow this instruction could result in the loss of control of your vehicle, personal injury or death.

Do not use a hitch that either clamps onto the bumper or attaches to the axle. You must distribute the load in your trailer so that 10–15% for conventional towing or 15–25% for fifth wheel towing of the total weight of the trailer is on the tongue. Do not exceed the tongue load rating indicated on the conventional hitch receiver.

**Note:** *On pick-up trucks, the trailer hitch provided on this vehicle enhances crash protection for the fuel system. Do not remove!*

### Hitch Components

The following components are required. Some are provided in certain vehicles.

- A trailer hitch with a 3 inch receiver and a 5/8 inch hitch pin. Check the stamped rating number on the pin to determine the 21,200 lb (9,616 kg) or 24,200 lb (10,976 kg) hitch pin capacity.
- A hitch pin sleeve stored in the glove box to use when mounting the 3 inch drawbar with the 3/4 inch pin hole.
- A cotter pin to help keep the hitch pin in place.

## Connecting a Trailer

### Installing a 3 Inch Drawbar with 3/4 Inch Pin Hole

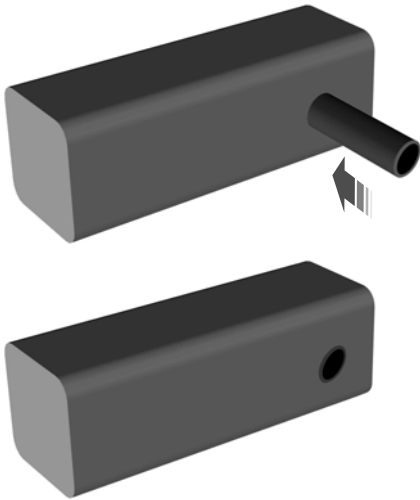

The pin sleeve should be inserted in the 3/4 inch pin hole of the 3 inch drawbar.

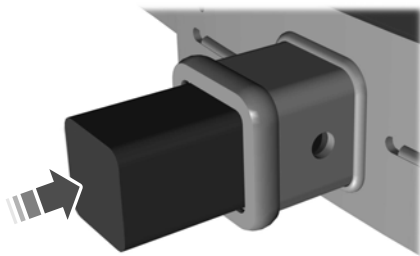

Remove reducers before inserting the 3 inch drawbar. Insert the drawbar into hitch receiver.

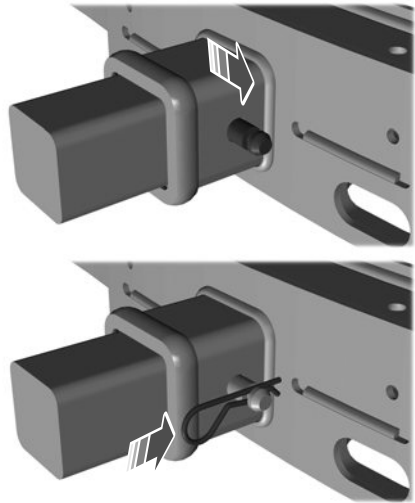

Put the 5/8 inch hitch pin through pin hole. Place the cotter pin around the neck of hitch pin.

### HOOKING UP A TRAILER USING A WEIGHT-DISTRIBUTING HITCH



**WARNING:** Do not adjust the spring bars so that your vehicle's rear bumper is higher than before attaching the trailer. Doing so will defeat the function of the weight-distributing hitch, which may cause unpredictable handling, and could result in serious personal injury.

A weight-distributing hitch helps distribute tongue load to all towing vehicle and trailer wheels. For more information, visit the links in the following table.

# Connecting a Trailer

Market	Website
United States of America	<a href="https://www.fleet.ford.com/towing-guides/">https://www.fleet.ford.com/towing-guides/</a>
Canada	<a href="https://www.fleet.ford.ca/towing-guides/">https://www.fleet.ford.ca/towing-guides/</a>

## FIFTH-WHEEL TRAILER HITCH

Your vehicle has a fifth-wheel prep package. This package enables your vehicle to accept certain fifth-wheel trailer hitches and gooseneck ball hitches. The fifth-wheel trailer hitch attaches to the four mounting pads in the pick-up bed. A 7-pin trailer wiring connector could be in the bed as well. The gooseneck ball hitch is a separate mounting pad from the fifth-wheel hitch in the center of the bed.

Shorter pick-up boxes provide less clearance between the cab and the fifth-wheel and gooseneck trailer compared to longer box pick-ups. When selecting a trailer and tow vehicle, it is critical to check that this combination provides clearance between the front of the trailer and tow vehicle for turns up to 90°. Failure to follow this recommendation could result in the trailer contacting the cab of the tow vehicle during tight turns that are typical during low-speed parking and turning maneuvers. This contact could result in damage to the trailer and tow vehicle.

**Note:** Contact an authorized dealer to purchase gooseneck and fifth-wheel hitches that are compatible with your vehicle.

**Note:** The mounting pads in the bed are specifically designed for certain fifth-wheel trailer hitches and gooseneck ball hitches. Do not use these mounting pads for other purposes.

## CONNECTING A TRAILER

### Recognizing a Trailer

1. Attach the trailer and wiring connector to your vehicle.
2. Switch on your vehicle.
3. Set up a profile for the trailer using the instrument cluster display.

**Note:** If your vehicle does not recognize the trailer, press and hold the brake pedal for a few seconds.

**Note:** Trailer profiles store trailer types, dimensions, preferences, trailer specific mileage and fuel economy.

**Note:** Disabling the trailer detection notification makes the default trailer profile active when a connection is detected.



When attaching the trailer wiring connector to your vehicle, only use a proper fitting connector that works with the vehicle and trailer functions.



# Connecting a Trailer

## Trailer Light Check



**WARNING:** Never connect any trailer lamp wiring to the vehicle's tail lamp wiring; this may damage the electrical system resulting in fire. Contact your authorized dealer as soon as possible for assistance in proper trailer tow wiring installation. Additional electrical equipment may be required.

Most towed vehicles require trailer lamps. Make sure all running lights, brake lights, turn signals and hazard lights are working.

## Safety Chains

Install trailer safety chains to the trailer hitch as recommended by the manufacturer. Cross the chains under the trailer coupler and allow enough slack for turning tight corners. Do not allow the chains to drag on the ground.

**Note:** Do not attach safety chains to the bumper. Always connect the safety chains to the frame or hook retainers of your trailer hitch.

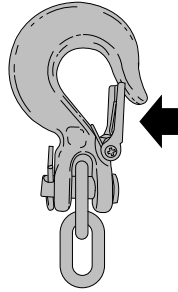

If the trailer safety chain hook has a latch, make sure to fully close the latch.

# Connecting a Trailer

## CONNECTING A TRAILER – TROUBLESHOOTING

### CONNECTING A TRAILER – INFORMATION MESSAGES

<b>Message</b>	<b>Description</b>
Trailer Disconnected	The system senses a trailer connection becomes disconnected, either intentionally or unintentionally, during a given ignition cycle.
Trailer Wiring Fault	There are certain faults in your vehicle wiring and trailer wiring or brake system.
Trailer Battery Not Charging See Manual	There is a fault with your trailer battery, or your trailer battery voltage is very low.
Trailer Tire Low Specified:	One or more tires on your trailer is below the specified tire pressure.
Trailer Tire Over Temperature	Displays when one or more tires on the trailer is above the recommended temperature.
Trailer Tire Pressure Sensor Fault	A trailer tire pressure sensor is malfunctioning. If the warning stays on or continues to come on, have the system checked as soon as possible.
Trailer Tire Pressure Monitor Fault	The trailer tire pressure monitoring system is malfunctioning. If the warning stays on or continues to come on, have the system checked.
Trailer Tire Pressure Monitor Capability Not Detected	The system cannot detect the trailer tire pressure monitoring system.
Trailer Tire Pressure Indication Not Setup See Manual	The trailer tire pressure monitoring system is not setup.

# Towing a Trailer

## TOWING A TRAILER PRECAUTIONS

 **WARNING:** Do not exceed the GVWR or the GAWR specified on the certification label.

 **WARNING:** Towing trailers beyond the maximum recommended gross trailer weight exceeds the limit of your vehicle and could result in engine damage, transmission damage, structural damage, loss of vehicle control, vehicle rollover and personal injury.

 **WARNING:** Do not exceed the lowest rating capacity for your vehicle or trailer hitch. Overloading your vehicle or trailer hitch can impair your vehicle stability and handling. Failure to follow this instruction could result in the loss of control of your vehicle, personal injury or death.

 **WARNING:** Make sure that the vertical load on the tow ball is between the minimum and maximum recommended weight at all times. Failure to follow this instruction could result in the loss of control of your vehicle, personal injury or death.

 **WARNING:** Do not cut, drill, weld or modify the trailer hitch. Modifying the trailer hitch could reduce the hitch rating.

 **WARNING:** The anti-lock brake system does not control the trailer brakes.

## TRAILER BRAKE PRECAUTIONS

 **WARNING:** Do not connect a trailer's hydraulic brake system directly to your vehicle's brake system. Your vehicle may not have enough braking power and your chances of having a collision greatly increase.

 **WARNING:** Do not tow a trailer fitted with electric trailer brakes unless your vehicle is fitted with a compatible aftermarket electronic trailer brake controller. Failure to follow this instruction could result in the loss of control of your vehicle, personal injury or death. For additional information and assistance, we recommend that you contact an authorized dealer.

Electric brakes and manual, automatic or surge-type trailer brakes are safe if you install them properly and adjust them to the manufacturer's specifications. The trailer brakes must meet local and federal regulations.

The rating for the tow vehicle's braking system operation is at the gross vehicle weight rating, not the gross combined weight rating.

# Towing a Trailer

---

Certain states require functioning trailer brakes for trailers over a specified weight. Be sure to check state regulations for this specified weight.

Ford Motor Company recommends separate functioning brake systems for trailers weighing more than 1,500 lb (680 kg) when loaded.

## TOWING A TRAILER LIMITATIONS

The vehicle's load capacity designation is by weight, not by volume, so you cannot necessarily use all available space when loading a vehicle or trailer.

**Note:** *Your vehicle could have reduced performance when operating at high altitudes and when heavily loaded or towing a trailer. When driving at elevation, to match driving performance as perceived at sea level, reduce gross vehicle weight and gross combination weight by 2% per 1,000 ft (300 m) elevation.*

## LOADING YOUR TRAILER

To help minimize how trailer movement affects your vehicle when driving:

- Load the heaviest items closest to the trailer floor.
- Load the heaviest items centered between the left-hand and right-hand side trailer tires.
- Load the heaviest items above the trailer axles or just slightly forward toward the trailer tongue. Do not allow the final trailer tongue weight to go above or below 10-15% of the loaded trailer weight. The trailer tongue weight should never exceed 10% of the maximum towing capacity when towing a conventional trailer, and should never exceed 15% of the maximum towing capacity when towing a fifth-wheel or gooseneck trailer.
- Select a ball mount with the correct rise or drop. When you connect both the loaded vehicle and trailer, the trailer frame should be level, or slightly angled down toward your vehicle, when viewed from the side.

## TRAILER TOWING HINTS

Towing a trailer places an extra load on your vehicle's engine, transmission, axle, brakes, tires and suspension. Periodically inspect these components during and after any towing operation.

When driving with a trailer or payload, a slight takeoff vibration or shudder may be present due to the increased payload weight.

# Towing a Trailer

---

Your vehicle may have a temporary or conventional spare tire. A temporary spare tire is different in diameter or width, tread-type, or is from a different manufacturer than the road tires on your vehicle. Consult information on the tire label or Safety Compliance label for limitations when using.

When towing a trailer:

- Obey country specific regulations for towing a trailer.
- Do not drive faster than 70 mph (113 km/h) during the first 500 mi (800 km).
- Do not make full-throttle starts.
- Check your hitch, electrical connections and trailer wheel lug nuts thoroughly after you have traveled 50 mi (80 km).
- When stopped in congested or heavy traffic during hot weather, place the transmission in park (P) to aid engine and transmission cooling and to help A/C performance.
- Turn off the speed control with heavy loads or in hilly terrain. The speed control may turn off when you are towing on long, steep slopes.
- Shift to a lower gear when driving down a long or steep hill. Do not continuously apply the brakes, as they may overheat and become less effective.
- If your transmission has Grade Assist or Tow/Haul, use this feature when towing. This provides engine braking and helps eliminate excessive transmission shifting for optimum fuel economy and transmission cooling.
- If your vehicle has AdvanceTrac with roll stability control, this system may turn on during typical cornering maneuvers with a heavily loaded trailer. This is normal. Turning the corner at a slower speed when towing may reduce this tendency.

- Allow more distance for stopping with a trailer attached. Anticipate stops and gradually brake.
- Avoid parking on a slope. However, if you must park on a slope, turn the steering wheel to point your vehicle tires away from traffic flow, set the parking brake, place the transmission in park (P) and place wheel chocks in front and back of the trailer wheels.

**Note:** Chocks are not included with your vehicle.

## LAUNCHING OR RETRIEVING A BOAT OR PERSONAL WATERCRAFT

When backing down a ramp during boat launching or retrieval:

- Do not allow the static water level to rise above the bottom edge of the rear bumper.
- Do not allow waves to break higher than 6 in (15 cm) above the bottom edge of the rear bumper.

Exceeding 6 in (15 cm) could allow water to enter vehicle components, causing internal damage to the components and affecting driveability, emissions and reliability.

**Note:** Replace the rear axle lubricant anytime the rear axle has been submerged in water.

**Note:** Disconnect the trailer wiring connector before backing the trailer into the water.

**Note:** Reconnect the trailer wiring connector after removing the trailer from the water.

# Towing a Trailer

---

## TOWING WEIGHTS AND DIMENSIONS

### RECOMMENDED TOWING WEIGHTS

<b>Market</b>	<b>Website</b>
United States of America	<a href="https://www.fleet.ford.com/towing-guides/">https://www.fleet.ford.com/towing-guides/</a>
Canada	<a href="https://www.fleet.ford.ca/towing-guides/">https://www.fleet.ford.ca/towing-guides/</a>

# Towing a Trailer

---

## WHAT IS THE MAXIMUM LOADED TRAILER WEIGHT

The maximum loaded trailer weight is the highest possible weight of a fully loaded trailer the vehicle can tow.

## CALCULATING THE MAXIMUM LOADED TRAILER WEIGHT FOR YOUR VEHICLE

1. Start with the gross combined weight rating for your vehicle model and axle ratio.
2. Subtract all of the following that apply to your vehicle:
  - Vehicle curb weight.
  - Hitch hardware weight, for example a draw bar, ball, locks or weight distributing hardware.

- Driver weight.
- Passenger weight.
- Payload, cargo and luggage weight.
- Aftermarket equipment weight.

This equals the maximum loaded trailer weight for this combination.

**Note:** *The trailer tongue load is considered part of the payload for your vehicle. Reduce the total payload by the final trailer tongue weight.*

**Note:** *Consult an authorized dealer to determine the maximum trailer weight allowed for your vehicle if you are not sure.*

# Towing a Trailer

## TOWING A TRAILER – TROUBLESHOOTING

### TOWING A TRAILER – INFORMATION MESSAGES

<b>Message</b>	<b>Details</b>
Trailer Left Turn Lamps Fault Check Lamps	The left-hand trailer turn lamp requires service.
Trailer Right Turn Lamps Fault Check Lamps	The right-hand trailer turn lamp requires service.
Trailer Battery Not Charging See Manual	The trailer battery voltage is too low to charge. If there is no trailer attached, the vehicle battery voltage is low.
Trailer Lighting Module Fault See Manual	The system detects a short created by the trailer lamps. Inspect and repair the trailer wiring, or have the system checked as soon as possible.
Trailer Stop Lamps Fault Check Lamps	The trailer stoplamps require service.
Trailer Sway Reduce Speed	The trailer sway control detects trailer sway. Reduce the vehicle's speed.
Trailer Tire Over Temperature	Displays when one or more tires on the trailer is above the recommended temperature.
Trailer Tire Low Specified:	One or more tires on your trailer is below the specified tire pressure.
Trailer Tire Pressure Sensor Fault	A trailer tire pressure sensor requires service. If the warning stays on or continues to come on, have the system checked as soon as possible.
Trailer Tire Pressure Monitor Fault	The trailer tire pressure monitoring system requires service. If the warning stays on or continues to come on, have the system checked as soon as possible.
Trailer Tire Pressure Monitor Capability Not Detected	The system cannot detect the trailer tire pressure monitoring system.
Trailer Tire Pressure Indication Not Setup See Manual	The trailer tire pressure monitoring system is not setup.



# Integrated Trailer Brake Controller (If Equipped)

## WHAT IS THE INTEGRATED TRAILER BRAKE CONTROLLER

The trailer brake controller assists in smooth and effective trailer braking based on the towing vehicle's brake pressure.

## INTEGRATED TRAILER BRAKE CONTROLLER PRECAUTIONS



**WARNING:** Use the integrated trailer brake controller to properly adjust the trailer brakes and check all connections before towing a trailer. Failure to follow this instruction could result in the loss of control of your vehicle, personal injury or death.

- Only use the manual control lever for proper adjustment of the gain during trailer setup. Misuse, such as application during trailer sway, could cause instability of trailer or tow vehicle.
- Avoid towing in adverse weather conditions. The trailer brake controller does not provide anti-lock control of the trailer wheels. Trailer wheels can lock up on slippery surfaces, resulting in reduced stability of trailer and tow vehicle.
- The trailer brake controller is only a factory-installed or dealer-installed item. Ford is not responsible for warranty or performance of the controller due to misuse or customer installation.

**Note:** Do not attempt removal of the trailer brake controller without consulting the Workshop Manual. Damage to the unit may result.

## USING THE INTEGRATED TRAILER BRAKE CONTROLLER

1. Make sure the trailer brakes are in good working condition, functioning normally and properly adjusted. See your trailer dealer if necessary.

**Note:** An authorized dealer can diagnose the trailer brake controller to determine exactly which trailer fault has occurred. Your vehicle warranty does not cover issues with your trailer.

2. Hook up the trailer and make the electrical connections according to the trailer manufacturer's instructions.

**Note:** Select default mode if the trailer has surge brakes, or no brakes at all. The system has no effect on the braking performance of the trailer in either of these cases.

**Note:** If a trailer is connected by a four-pin connector, the trailer braking function will not be supported.

3. When you plug in a trailer with electric or electric-over-hydraulic brakes, a message confirming connection appears in the information display.
4. Use the gain adjustment to find the desired starting point. A gain setting of 6.0 is a good starting point for heavier loads.

**Note:** Use the following steps to adjust the gain setting whenever road, weather and trailer, or vehicle loading conditions, change from when you initially set the gain.

5. In a traffic-free environment, tow the trailer on a dry, level surface and squeeze the manual control lever completely.

## Integrated Trailer Brake Controller (If Equipped)

- If the trailer wheels lock up, indicated by squealing tires, reduce the gain setting. If the trailer wheels turn freely, increase the gain setting. Repeat Steps 5 and 6 until the gain setting is at a point just below trailer wheel lock-up. If towing a heavier trailer, trailer wheel lock-up may not be attainable even with the maximum gain setting of 10.

**Note:** Only perform this procedure at speeds of approximately 20–25 mph (30–40 km/h).

**Note:** The trailer brake controller reduces output at vehicle speeds below 11 mph (18 km/h) so that trailer and vehicle braking is not jerky or harsh. This feature is only available when applying the brakes using your vehicle's brake pedal, not the controller.

**Note:** Your vehicle's brake system and the trailer brake system work independently of each other. Changing the gain setting on the controller does not affect the operation of your vehicle's brakes whether you attach a trailer or not.

**Note:** With the proper electrical connection, pressing your vehicle brake pedal or using the manual control lever illuminates both trailer and vehicle brake lamps.

**Note:** When you switch the engine off, the controller output is disabled and the display and module shut down. The controller module and display turn on when you switch the ignition on.

### Adjusting the Trailer Brake Gain

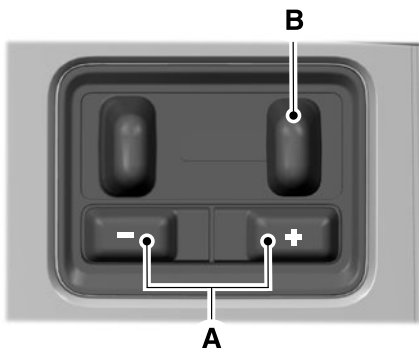

- A Increase or decrease the amount of gain in set increments.
- B Slide the control to engage the trailer brakes.

**Note:** Adjust gain setting before using the trailer brake controller for the first time.

**Note:** The gain should be set to provide the maximum trailer braking assistance while making sure the trailer wheels do not lock when using the brakes. Locked trailer wheels may lead to trailer instability.

**Note:** Setting adjustments are saved when a trailer profile is selected.

### ADJUSTING THE INTEGRATED TRAILER BRAKE CONTROLLER MODE

Select the correct integrated trailer brake controller mode option using the instrument cluster display.

**Note:** Trailer brake gain settings are saved to the active trailer profile.

# Integrated Trailer Brake Controller (If Equipped)

## Selecting the Trailer Brake Type

Use the instrument cluster display controls on the steering wheel to select the correct setting for your trailer.

**Note:** Select **Default Electric/Surge/None** if the trailer has electric, surge or no brakes.

## Selecting the Trailer Brake Effort

Select the correct setting for your trailer.

**Note:** Select a different setting if your trailer's brakes require more initial voltage, or you prefer more aggressive trailer braking.

## INTEGRATED TRAILER BRAKE CONTROLLER – TROUBLESHOOTING

### INTEGRATED TRAILER BRAKE CONTROLLER – INFORMATION MESSAGES

Message	Action
Trailer Connected	The system detects a correct trailer connection during a given ignition cycle.
Trailer Disconnected	The system detects the trailer wiring connection is disconnected, during a given ignition cycle.
Trailer Wiring Fault	The system detects an electrical fault in the trailer brake circuit. If this message appears without a trailer attached, see your authorized dealer. If a trailer is attached, inspect and repair the trailer wiring.
Trailer Brake Gain: {trailer gain value:#0.0}	Displays the current gain setting for the trailer brake.
Trailer Brake Gain: {trailer gain value:#0.0} No Trailer	Displays the current gain setting for the trailer brake when you do not have a trailer connected.

# Integrated Trailer Brake Controller (If Equipped)

---

## **INTEGRATED TRAILER BRAKE CONTROLLER – FREQUENTLY ASKED QUESTIONS**

### **How do I determine if there is an issue with the wiring on my vehicle?**

A message displays accompanied by a single tone, when no trailer is connected. This indicates that the issue is between the trailer brake controller and the 7-pin connector at the bumper.

### **How do I determine if there is an issue with the wiring on my trailer?**

A message only displays with a trailer connected. Consult your trailer dealer for assistance.

# Trailer Sway Control

---

## HOW DOES TRAILER SWAY CONTROL WORK

The system applies the brakes to the individual wheels and reduces engine torque to aid vehicle stability.

If the trailer begins to sway, the stability control lamp flashes and the message **Trailer Sway Reduce Speed** appears in the information display.

Stop your vehicle as soon as it is safe to do so. Check the vertical weight on the tow ball and trailer load distribution.

2. Press **Towing**.
3. Switch **Trailer Sway Control** on or off.

The system turns on each time you start your vehicle.

## TRAILER SWAY CONTROL PRECAUTIONS



**WARNING:** Turning off trailer sway control increases the risk of loss of vehicle control, serious injury or death. Ford does not recommend disabling this feature except in situations where speed reduction may be detrimental (such as hill climbing), the driver has significant trailer towing experience, and can control trailer sway and maintain safe operation.

**Note:** *This feature only activates when significant trailer sway occurs.*

**Note:** *This feature does not prevent trailer sway, but reduces it once it begins.*

**Note:** *This feature cannot stop all trailers from swaying.*

**Note:** *In some cases, if vehicle speed is too high, the system may activate multiple times, gradually reducing vehicle speed.*

## SWITCHING TRAILER SWAY CONTROL ON AND OFF

1. Press **Features** on the touchscreen.

# Trailer Backup Assistance (If Equipped)

## WHAT IS TRAILER BACKUP ASSISTANCE

Trailer backup assistance utilizes the control knob on the instrument panel to help you steer a trailer. Turn the control knob in the direction you want the trailer to go and the system steers the vehicle.

## HOW DOES TRAILER BACKUP ASSISTANCE WORK

Trailer backup assistance uses a sticker or sensor attached to the trailer to detect the trailer angle relative to the towing vehicle and provides instructions, graphics and camera views on the touchscreen.

## TRAILER BACKUP ASSISTANCE PRECAUTIONS



**WARNING:** Driving while distracted can result in loss of vehicle control, crash and injury. We strongly recommend that you use extreme caution when using any device that may take your focus off the road. Your primary responsibility is the safe operation of your vehicle. We recommend against the use of any hand-held device while driving and encourage the use of voice-operated systems when possible. Make sure you are aware of all applicable local laws that may affect the use of electronic devices while driving.



**WARNING:** This system is an extra driving aid. It does not replace your attention and judgment, or the need to apply the brakes. This system does NOT automatically brake your vehicle. If you fail to press the brake pedal when necessary, you may collide with another vehicle.

**Note:** *The system is not a substitute for safe driving practices. Always be aware of your vehicle and trailer combination, and the surrounding environment.*

**Note:** *The system does not detect or prevent your vehicle or trailer from making contact with obstacles in the surrounding environment.*

**Note:** *The front end of your vehicle swings out when changing the direction of the trailer.*

**Note:** *In certain conditions, the trailer could turn faster or the trailer angle could increase more than anticipated. Always monitor the clearance between the trailer and vehicle and the surroundings.*

## SETTING UP THE TRAILER BACKUP ASSISTANCE FOR A CONVENTIONAL TRAILER

### CONFIGURING THE TRAILER

You must configure a trailer in the system to use trailer backup assistance. This is a one-time setup process and the trailer information is saved in the system for the next time you use that trailer.

The following illustration shows examples of conventional trailers on the left-hand side.

## Trailer Backup Assistance (If Equipped)

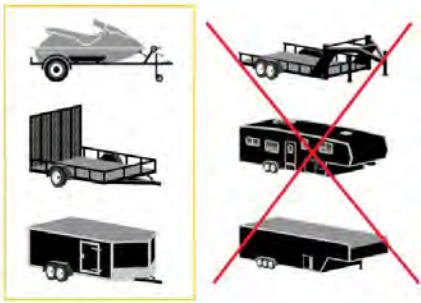

Make sure that the trailer and your vehicle are in line with each other. You can do this by putting the transmission in drive (D) and pulling straight forward.

### Configuring the Trailer in the Instrument Cluster Display



### Positioning the Trailer

Hitch the trailer to your vehicle and connect the electrical wiring harness. Check to make sure that the wiring is working. See **Connecting a Trailer** (page 323).



Park your vehicle and hitched trailer on a level surface.

For best results, make sure that your trailer rides level with the ground when you hitch your vehicle. See **Connecting a Trailer** (page 323).



1. Press the button to switch the system on.
2. Using the instrument cluster controls on the steering wheel, select **Add Trailer**.
3. Add a personalized name for the trailer using the instrument cluster display prompts. Use the down arrow to scroll to the preferred letter and then press the right arrow to advance to the next letter. Press the **OK** button.
4. Select the trailer brake type.

# Trailer Backup Assistance (If Equipped)

**Note:** Select **Default Electric/Surge/None** if the trailer has electric, surge or no brakes.

5. Select the trailer brake effort.

**Note:** The default value is **Low** and is the recommended setting for most trailers. Select a different setting if your trailer's brakes require more initial voltage, or you prefer more aggressive trailer braking.

6. Select the trailer type.

**Note:** The system could prompt you to setup **Trailer Blind Spot** before continuing the setup process.

7. Select whether you want to add the feature.

## APPLYING THE TRAILER REVERSING AID STICKER

### Placing the Sticker

Place the sticker in an area visible by the rear view camera. The entire sticker must be within 7–20 in (17–51 cm) from the center of the hitch ball, as shown in the following illustration.

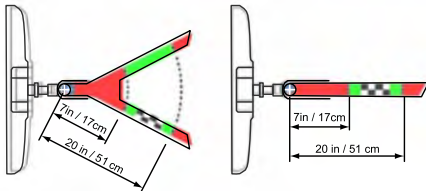

Use the supplied sticker placement card, a tape measure and pen to carefully mark the area to attach the sticker. The sticker is in the back cover pocket of your quick start guide. Make sure the entire sticker is within the green zone between the two arcs or distance markers on the diagram, and is also visible in the rear view camera display.

Once you have found the correct location, place the sticker.

**Note:** Make sure nothing can obstruct the rear view camera's view of the sticker such as a jack handle or wiring.

**Note:** Position the sticker on a flat, dry and clean horizontal surface. For best results, apply the sticker when temperatures are above 32°F (0°C).

**Note:** Do not move stickers after placing them. Do not re-use any stickers if removed.

**Note:** See your authorized dealer to purchase additional stickers.

### Taking the Measurements

After you place the sticker on your trailer, you must take some measurements.

The measurement card requires recording four distances: A, B, C and D. Record the trailer name for these measurements.

**Note:** Use consistent metric or imperial units as required by your country or vehicle.

**Note:** The system requires accurate measurements to properly operate.



# Trailer Backup Assistance (If Equipped)

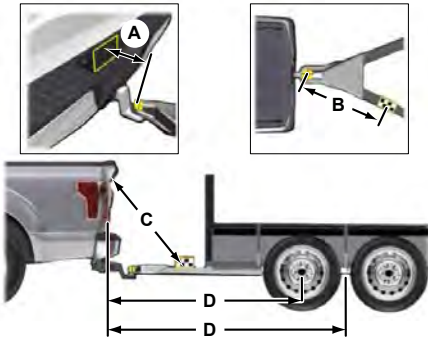

- A The horizontal distance from the license plate to the center of the ball hitch on the trailer.
- B The horizontal distance from the center of the ball hitch to the center of the sticker.
- C The point to point distance from the rear view camera to the center of the sticker.
- D The horizontal distance from the tailgate to the center of the trailer axle or axles.

**Note:** Distance D is the center of the axles for trailers with more than one axle.

**Note:** Round distance D to the nearest inch or centimeter.

**Note:** When rounding in inches, round upward if the measured length is a quarter inch or greater. Round downward if the measured length is less than a quarter inch. For example, 12.25 in (31.11 cm) would be rounded up to 12.50 in (31.75 cm). 12.13 in (30.8 cm) would be rounded down to 12.00 in (30.48 cm).

**Note:** When rounding in centimeters, round to the nearest whole centimeter. If the measurement is less than 0.2 in (0.5 cm) round downward. If the measurement is more than or equal to 0.2 in (0.5 cm) round upward. For example, 11.9 in (30.3 cm) would be rounded down to 11.8 in (30 cm). 12.0 in (30.5 cm) would be rounded up to 12.2 in (31 cm).

## Entering the Measurements

Follow the prompts in the instrument cluster display to enter each of the measurements. Use the up and down arrows to increase or decrease the numbers, as necessary. Press OK to confirm each measurement. When you add the last measurement, the instrument cluster display shows all the measurements entered. You can choose to confirm or change the measurements.

## Confirming the Sticker Placement

Check the rear view camera display to see if the system identifies the sticker. The system marks the sticker with a red circle. Confirm that the red circle shows over the sticker image in the rear view camera display.

**Note:** If the system cannot locate the sticker, try cleaning the camera lens. Make sure the sticker is within the green zone.

## CALIBRATING THE SYSTEM

Calibrating the system requires driving straight forward. Follow the instructions in the instrument cluster display to complete the calibration process.

**Note:** Calibrating the system requires an area where you can safely drive forward. An open parking lot is an ideal place to perform the calibration.

## Trailer Backup Assistance (If Equipped)

---

**Note:** Keep the steering wheel straight when instructed to by the instrument cluster display. If the steering wheel is in a turned position during this instruction, the calibration pauses.

**Note:** The system is designed to work with drawbars that have a license plate to hitch ball center measurement of 9–20 in (23–52 cm) when installed. Do not attempt to use drawbars that have a length outside of this range as the system performance degrades and could cause improper system function.

**Note:** The instrument cluster display shows if you are going too slow or fast. Calibration pauses if the speed is outside the required range of 4–24 mph (6–39 km/h).

**Note:** For best results, do not calibrate the system at night when calibrating the system with the sticker.



## SETTING UP THE TRAILER BACKUP ASSISTANCE FOR A FIFTH-WHEEL OR GOOSENECK TRAILER

### CONFIGURING THE TRAILER

You must configure a trailer in the system to use trailer backup assistance. This is a one-time setup process and the trailer information is saved in the system for the next time you use that trailer.

The following illustration shows examples of fifth-wheel and gooseneck trailers.

**Note:** Trailer reverse guidance camera views are available with no trailer setup. However, complete functionality including graphics and automatic view switching is enabled by setup. Setup is required to enable trailer backup assistance.

## Trailer Backup Assistance (If Equipped)

### Configuring the Trailer in the Instrument Cluster Display



1. Press the button to switch the system on.
2. Using the instrument cluster controls on the steering wheel, select **Add Trailer**.
3. Add a personalized name for the trailer using the instrument cluster display prompts. Use the down arrow to scroll to the preferred letter and then press the right arrow to advance to the next letter. Press the **OK** button.
4. Select the trailer brake type.

**Note:** Select **Default Electric/Surge/None** if the trailer has electric, surge or no brakes.

5. Select the trailer brake effort.

**Note:** The default value is **Low** and is the recommended setting for most trailers. Select a different setting if your trailer's brakes require more initial voltage, or you prefer more aggressive trailer braking.

6. Select the trailer type.

**Note:** The system could prompt you to setup **Trailer Blind Spot** before continuing the setup process.

7. Select whether you want to add the feature.

### TRAILER SENSOR INSTALLATION

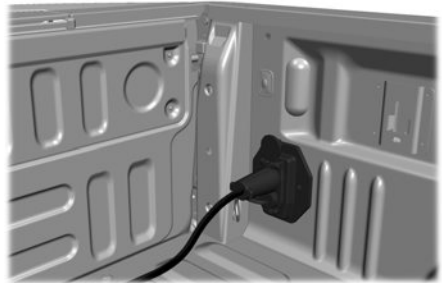

To use the system with a fifth-wheel or gooseneck trailer, you must install a sensor. Refer to the instructions in the sensor kit for proper installation.

## Trailer Backup Assistance (If Equipped)

**Note:** Make sure the arrows on the sensor housing are facing up. Mount the sensor to a vertical part of the trailer that pivots and moves when you turn your vehicle. Do not mount to a stationary surface or to the truck side of the fifth wheel-trailer hitch.

**Note:** You need to replace the 7/4 way connector in the bumper with the recommended 7/12 pin connector if your vehicle did not come with the fifth-wheel prep package. See your authorized dealer.

**Note:** If your vehicle has the fifth-wheel prep package, you have everything you need. If your vehicle does not have the fifth-wheel prep package, see your authorized dealer to purchase the sensor kit and the 7/12 pin connector.

**Note:** Keep the steering wheel straight when instructed to by the instrument cluster display and touchscreen. If the steering wheel is in a turned position during this instruction, the calibration pauses.

**Note:** During calibration, the system determines the trailer length. The system supports trailer lengths of 10–39 ft (3–11.94 m) distance from the hitch point to the center of the axle or axles.

**Note:** The instrument cluster displays and touchscreen shows if you are going too slow or fast. Calibration pauses if the speed is outside the required range of 2–16 mph (4–25 km/h).

**Note:** You need to complete at least a 90° turn, and longer trailers could require a 180° turn.

### CALIBRATING THE SYSTEM

Calibrating the system requires driving forward and turning left or right. Follow the instructions on the instrument cluster display and touchscreen to complete the calibration process.



**Note:** Calibrating the system requires an area where you can safely drive forward and turn left or right. An open parking lot is an ideal place to perform the calibration.

# Trailer Backup Assistance (If Equipped)

## SWITCHING TRAILER BACKUP ASSISTANCE ON AND OFF



Press the button and use the instrument cluster display controls to select the connected trailer.

**Note:** You must configure a trailer to use trailer backup assistance. See **Configuring the Trailer** (page 339). See **Configuring the Trailer** (page 343).

**Note:** If you use the steering wheel when using trailer backup assistance, the system turns off and a message displays in the instrument cluster display.

**Note:** If you connected a trailer just prior to turning the system on, you may need to drive forward to initialize the system. Follow the instructions in the instrument cluster display to activate the system.

## USING THE TRAILER BACKUP ASSISTANCE CONTROLLER

Use the control knob to steer the trailer. Take your hands off the steering wheel and turn the control knob instead. The control knob acts as the steering control for the trailer.



Turn and hold counterclockwise to make the trailer go left.



Turn and hold clockwise to make the trailer go right.

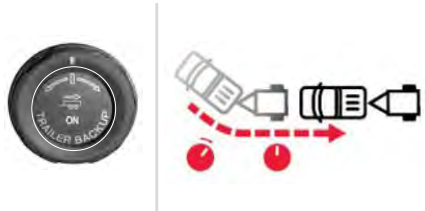

Release the knob when the trailer is moving in the direction you want.

## Trailer Backup Assistance (If Equipped)

**Note:** The more you turn the knob, the sharper the trailer turns.

**Note:** Quickly turning and releasing the knob results in a jerky movement of the vehicle.

**Note:** You may have to use the knob to correct the trailer direction when attempting to move the trailer straight back under some conditions.

**Note:** For fifth-wheel and gooseneck trailers, the weight and hitch position of these trailers could make the trailer respond differently to the knob input than conventional trailers. You may need to release the knob early or stop and pull forward to align your truck and trailer when returning to straight backing after making a turn.

**Note:** Trailer maneuvering performance could be compromised when using a fifth-wheel sliding hitch or pivoting pin box since the system does not know the pivot point.

### USING THE TRAILER BACKUP ASSISTANCE VIEWS

Up to seven camera views could be available when using trailer backup assistance. Use the view that helps you the most when reversing your vehicle and trailer.

 360° camera view. Shows a 360° view on the right-hand side of the touchscreen with a rear camera view on the left-hand side of the touchscreen.

 Rear view camera view. Shows your trailer hitch or what is directly behind your vehicle.

 Rear split view camera view. Shows a 180° degree view of what is behind your vehicle.



Bed camera view. Shows the truck bed.



Trailer AUX camera view. Shows a rear view camera image of what is behind your trailer. You need to separately purchase this camera and have it installed.



Trailer reverse guidance view. Shows you a view of the sides of your truck and the trailer. In auto mode, this view moves as the trailer moves so that you do not have to adjust the camera as you turn. Left and right arrows let you see other camera views.



Auto. Press to return to auto view.

**Note:** Auto mode is the default setting.

### Hitch Angle Graphic

The hitch angle graphic shows a small representation of your truck and trailer with visual feedback to help you monitor the trailer. The graphic shows two different colored lines for the trailer hitch angle. A black line shows you where your trailer is in relation to your vehicle. The white line represents the amount the trailer can turn based on knob input.

The graphic shows a yellow and red zone for the hitch angle to warn you of a high angle condition that could require you to pull forward to reduce the hitch angle. The angle limits for each zone vary based on the trailer length.

The yellow zone indicates you are approaching the maximum controllable trailer angle for the system. When the trailer enters this zone, it is more difficult to reduce the trailer turn when backing up. It may be necessary to put your vehicle back into drive (D) and pull forward to get the truck and trailer back to an in-line position.

## **Trailer Backup Assistance (If Equipped)**

---

The red zone indicates you have exceeded the maximum controllable trailer angle for the system. Immediately stop reversing.

Put your vehicle into drive (D) and pull forward until the trailer is no longer in the red zone.

## Trailer Backup Assistance (If Equipped)

### TRAILER BACKUP ASSISTANCE – TROUBLESHOOTING

#### TRAILER BACKUP ASSISTANCE – INFORMATION MESSAGES

Message	Description
Detecting Trailer Please Wait...	Displays when the system turns on and is initializing.
Pro Trailer Backup Assist™ Locating Sticker Please wait... Press Knob to Exit	
Pro Trailer Backup Assist™ Sticker Not Found Refer to Owner's Manual. Press Knob to Exit	These messages display when the system cannot locate the sticker.
Pro Trailer Backup Assist™ Sticker Not Found Shift to Park Press Knob to Exit	
Pro Trailer Backup Assist™ System is Not Available	A condition exists that prevents the system from turning on. If the message continues to display, visit your authorized dealer to have your vehicle checked.
Pro Trailer Backup Assist™ Driving Required to Initialize Steering Press Knob to Exit	The steering system needs to learn internal parameters to fully enable the feature. Drive your vehicle straight forward above 25 mph (40 km/h) for approximately 5 minutes.
Pro Trailer Backup Assist™ Stop now Maximum trailer angle Press Knob to Exit	Displays when you reach the maximum controllable trailer angle for the system. Place your vehicle in drive (D) and pull forward to get the truck and trailer back to an in-line position. If this message consistently displays, you may need to repeat the trailer calibration. Delete the trailer from the system and repeat the setup and calibration process.



## Trailer Backup Assistance (If Equipped)

Message	Description
Stop now. Deactivated by trailer angle.	Displays when you exceed the maximum controllable trailer angle for the system. Place your vehicle in drive (D) and pull forward to get your vehicle and trailer back to an in-line position, then activate the system by selecting the connected trailer and following the instructions in the instrument cluster display. If this message consistently displays, you may need to repeat the trailer setup and calibration. Delete the trailer from the system and repeat the setup and calibration process.
Pro Trailer Backup Assist™ Stop Now Take Control of Steering Wheel	Displays when the system can no longer steer the vehicle and you must take over steering.
Pro Trailer Backup Assist™ Sensor Not Detected Refer to Owner's Manual Press Knob to Exit	Displays when the system does not detect the sensor. Check the sensor connection, that there is no damaged wiring between the connector and sensor and that there is only one sensor connected.
Pro Trailer Backup Assist™ Trailer Not Detected. Shift to Park Press Knob to Exit	These messages display when the system does not detect the trailer. Check that the sensor is correctly installed and the trailer length is within the allowed range.
Pro Trailer Backup Assist™ Trailer Not Detected. Refer to Owner's Manual. Press Knob to Exit	

## Trailer Backup Assistance (If Equipped)

---

<b>Message</b>	<b>Description</b>
Pro Trailer Backup Assist™ Trailer Not Detected Pull Forward to Initialize Press Knob to Exit	Displays when your vehicle has not moved after the trailer sensor is connected or extended operation below 1 mph (1 km/h). Drive forward above 2 mph (3 km/h) to initialize the system.
Pro Trailer Backup Assist™ Stop Now System Not Active Press Knob to Exit	Displays when your vehicle is backing up but the system is not activated. Select the connected trailer in the instrument cluster display and follow the instructions to activate the system. This message also displays when you back up during the calibration process.
Pro Trailer Backup Assist™ Backup Slowly Turn Knob to Steer Press Knob to Exit	Displays when the system turns on and is available to use.

# Trailer Backup Assistance (If Equipped)

---

## TRAILER BACKUP ASSISTANCE – FREQUENTLY ASKED QUESTIONS

### What does it mean if Measurement A has reached its maximum or minimum value?

The system is designed to work with drawbars that have a license plate to hitch ball center measurement of 9–20 in (23–52 cm) when installed. Do not attempt to use drawbars that have a length outside this range as the system performance degrades and could cause improper system function. Make sure that the measurement being made is the horizontal distance only from the license plate to the hitch ball center. A straight line distance that includes any vertical rise or drop increases the measurement and makes it inaccurate. Inaccurate measurements degrade system performance and could cause improper system function. See **Applying the Trailer Reversing Aid Sticker** (page 341).

### What does it mean if Measurement B has reached its maximum or minimum value?

Make sure that the sticker is properly placed. Stickers placed outside the allowed zone adversely affects the system performance and could cause improper feature function. Make sure that the measurement being made is the horizontal distance only from center of the sticker to the hitch ball center. A straight line distance that includes any vertical rise or drop increases the measurement and causes an inaccurate value to be entered into the system. See **Applying the Trailer Reversing Aid Sticker** (page 341).

### What does it mean if Measurement C has reached its maximum or minimum value?

Make sure you follow the sticker placement instructions. Stickers placed outside the allowed zone adversely affect the system performance and could cause improper feature function. If you have met all the criteria for sticker placement and you see this message, the sticker is either too far below or too close to the camera to properly recognize the sticker. For the system to correctly operate, lower the sticker height if you receive the minimum warning or raise the sticker height if you receive the maximum warning. Only one sticker can be placed on the trailer for correct system function. The previous sticker must be removed or covered so only one sticker is visible to the camera. Measurement B and C must be measured again if a new sticker is placed on the trailer. See **Applying the Trailer Reversing Aid Sticker** (page 341).

### What does it mean if Measurement D has reached its maximum or minimum value?

Make sure that the measurement being made is the horizontal distance only from tailgate to the center of the single axle or the center of all the axles on the trailer. The system does not support trailer lengths outside the range allowed by the information display. See **Applying the Trailer Reversing Aid Sticker** (page 341).

# Trailer Backup Assistance (If Equipped)

---

## **Why does the trailer not reverse straight when using a conventional trailer?**

Factors such as the drawbar connection to the hitch receiver, road camber, road grade and compliance in the trailer suspension can influence how straight the system is able to reverse your trailer when the knob is not turned. You can compensate for the trailer drifting to the right or left by slowly turning the knob until the trailer is following your preferred path and then holding the knob in that position. If you would like to recalibrate the system for straight backing, change the sticker option in the instrument cluster display. Confirm the measurements, and the system prompts you to perform the calibration procedure.

## **Why does the trailer not reverse straight when using a fifth-wheel or gooseneck trailer?**

Verify the sensor is correctly installed. Other factors such as the hitch connection, road camber, road slope and trailer suspension could influence how straight the system can reverse the trailer when the control knob is not turned. You can compensate for the trailer drifting to the right or left by slowly turning the knob until the trailer is following your desired path and then holding the knob in that position.

## **Why does the system not detect a sensor?**

There could be an issue with the connection, the wiring harness could be damaged, you could have multiple sensors connected or the sensor could be incorrectly installed. Check that the 12-way connector is fully inserted into the 12-way socket. The red rubber seal is not visible when the connector is fully inserted. Also check that the wiring harness sensor connection is fully inserted at the trailer sensor, and check for damaged wiring between the 12-way connector and the trailer sensor. Also, check that the sensor is installed on a vertical surface with the arrows pointing straight up.

## **What does it mean if the system remains on one message for an extended time during calibration when setting up the system with a conventional trailer?**

The camera could need to be cleaned, the sticker could be blocked, the drawbar could be outside the allowed range of 4–19 in (10–48 cm) or you could need to move to a different area to change the lighting and background. Verify the sticker is in the proper location. See **Applying the Trailer Reversing Aid Sticker** (page 341). You can move to a different area or change the direction you are driving or setup the system at a different time of day. Some trailers are not compatible with the sticker and camera system.

## **What does it mean if the system pauses during calibration?**

There could be steering input or trailer movement during the straight drive portion of the calibration process.

## Trailer Backup Assistance (If Equipped)

---

### **What does it mean if the system remains on one message for an extended time during calibration when setting up the system with a fifth-wheel or gooseneck trailer?**

The sensor could be incorrectly installed, the trailer length could be outside the allowed range or the road surface could be too rough or bumpy.

### **What does it mean if the system displays hold steering steady during turn?**

Part of the calibration process for the sticker setup requires a steady turn. If you are continually moving the steering wheel during the turn, this delays the calibration process. To enable the calibration process, hold the steering wheel at the same position when turning.

### **What does it mean if the system displays that it is not available?**

There could be a sub-system that the system uses that is not correctly operating or there could be a battery voltage issue. If the system continues to display it is not available, visit your authorized dealer to have your vehicle checked.

### **What does it mean if the system displays that driving is required to initialize steering?**

The steering system needs to learn internal parameters to fully turn on the feature. Drive your vehicle straight forward above 25 mph (40 km/h) for approximately 5 minutes. This could also occur when your vehicle is new, there is a battery voltage issue or if the steering system has been serviced.

### **What does it mean if the system does not detect a trailer when configured for a fifth-wheel or gooseneck trailer?**

Verify that the sensor is properly connected. See **Trailer Sensor Installation** (page 344). Repeat calibration on a different route if you have verified sensor installation.

### **What does it mean if the system requires you to pull forward to initialize?**

This occurs when the vehicle has not moved during the current key cycle after you connect and select the trailer in the instrument cluster display or you operate the system at speeds below 1 mph (1 km/h) for an extended period of time. Drive forward above 2 mph (3 km/h) and the system indicates when it initializes.

## Trailer Backup Assistance (If Equipped)

---

### **What does it mean if the trailer is at its maximum angle or the system deactivated by trailer angle when using a conventional trailer?**

The system uses your measurements to determine sticker position and establish system limits. Accurate sticker placement and trailer measurements provide the best system performance. If you are consistently receiving this warning, it is likely there is an issue with sticker placement or the entered measurements. Make sure that the sticker is placed correctly and the measurements were made correctly. See **Applying the Trailer Reversing Aid Sticker** (page 341). To change the sticker location or change trailer measurements, change the sticker option in the instrument cluster display. If the sticker location needs to be changed, the previous sticker must be removed and a new sticker needs to be placed on the trailer. Only one sticker should be placed on the trailer for proper system function.

### **What does it mean if the trailer is at its maximum angle or the system deactivated by trailer angle when using a fifth-wheel or gooseneck trailer?**

You are at the maximum controllable trailer angle for the system. Place your vehicle in drive (D) and pull forward to get the truck and trailer back to an in-line position. If this message consistently displays, this could indicate the sensor is incorrectly installed, the trailer needs to be recalibrated or the drawbar or the trailer dimensions are outside of the supported range. The system is designed to work with drawbars that have a license plate to hitch ball center measurement of 9–20 in (23–52 cm) when installed. The system is designed to work with trailers that have a hitch point to center of the axle or axles measurement of 6–33 ft (1.85–10.05 m). Do not attempt to use drawbars or trailers that have a length outside of this range as the system performance degrades and could cause improper system function. Check that the correct trailer is selected in the instrument cluster display. Verify the sensor is installed according to the instructions included in the sensor kit and check that the drawbar and the trailer dimensions are within the allowed range. Then, delete the trailer from the system and repeat the setup process to calibrate the trailer.

## Trailer Backup Assistance (If Equipped)

---

### What does it mean when the system tells you to take control of the steering wheel?

The system is no longer steering the vehicle and you must take over steering. There are four reasons the system could display this message. The first reason the system could display this message is that you have touched the steering wheel when the system is steering. The second reason the system could display this message is that you have exceeded the maximum speed for the feature. The third reason the system could display this message is that the trailer is not detected. The final reason the system could display this message is that an internal condition for system operation is not met that requires your vehicle to return to manual control of the steering.

### What does it mean if the system circles something besides the sticker or cannot find the sticker?

The system requires a clear view of the sticker placed on the trailer and accurate measurements to locate the sticker. Remove any items that may be blocking the view of the sticker. Depending on your trailer configuration and any equipment mounted to your trailer, it is possible for the sticker to be blocked from view of the camera as it rotates on the hitch ball but not be blocked during setup. It may be necessary to remove the sticker from its current location if the obstruction cannot be cleared. The sticker location must still meet the requirements noted the setup instructions. See **Applying the Trailer Reversing Aid Sticker** (page 341). Verify the measurements you entered into the system are accurate. To change the sticker location or change trailer measurements, change the sticker option in the instrument cluster display. If the system cannot initially detect the trailer, it could be necessary for you to change the lighting conditions by moving your vehicle and trailer or waiting until the conditions change. Some trailers are not compatible with the sticker and camera system. Only one sticker can be placed on the trailer for correct system function.

**Note:** *The system is designed to be used with the same trailer connection every time you choose the trailer from the instrument cluster display. When using a different drawbar or a different pin hole on drawbars with more than one, connecting the drawbar to your vehicle affects the trailer measurements. Take the measurements again and update if required.*

# Trailer Reverse Guidance (If Equipped)

## WHAT IS TRAILER REVERSE GUIDANCE

Trailer reverse guidance provides views and graphics on the touchscreen to help you steer your vehicle when you backup a trailer.

## HOW DOES TRAILER REVERSE GUIDANCE WORK

Trailer reverse guidance uses a sticker or sensor attached to the trailer to detect the trailer angle relative to the towing vehicle and provides instructions, graphics and camera views on the touchscreen.

## TRAILER REVERSE GUIDANCE PRECAUTIONS



**WARNING:** Driving while distracted can result in loss of vehicle control, crash and injury. We strongly recommend that you use extreme caution when using any device that may take your focus off the road. Your primary responsibility is the safe operation of your vehicle. We recommend against the use of any hand-held device while driving and encourage the use of voice-operated systems when possible. Make sure you are aware of all applicable local laws that may affect the use of electronic devices while driving.



**WARNING:** This system is an extra driving aid. It does not replace your attention and judgment, or the need to apply the brakes. This system does NOT automatically brake your vehicle. If you fail to press the brake pedal when necessary, you may collide with another vehicle.

**Note:** The system is not a substitute for safe driving practices. Always be aware of your vehicle and trailer combination, and the surrounding environment.

**Note:** The system does not detect or prevent your vehicle or trailer from making contact with obstacles in the surrounding environment.

**Note:** The front end of your vehicle swings out when changing the direction of the trailer.

**Note:** In certain conditions, the trailer could turn faster or the trailer angle could increase more than anticipated. Always monitor the clearance between the trailer and vehicle and the surroundings.

## SETTING UP TRAILER REVERSE GUIDANCE FOR A CONVENTIONAL TRAILER

### CONFIGURING THE TRAILER

You must configure a trailer in the system to use trailer reverse guidance. This is a one-time setup process and the trailer information is saved in the system for the next time you use that trailer.

The following illustration shows examples of conventional trailers on the left-hand side.

**Note:** Trailer reverse guidance camera views are available with no trailer setup. However, complete functionality including graphics and automatic view switching is enabled by setup. Setup is required to enable trailer backup assistance.



# Trailer Reverse Guidance (If Equipped)

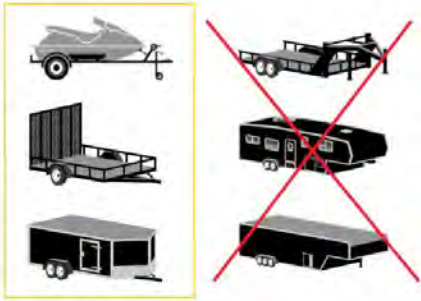

## Positioning the Trailer

Hitch the trailer to your vehicle and connect the electrical wiring harness. Check to make sure that the wiring is working. See **Connecting a Trailer** (page 323).



Park your vehicle and hitched trailer on a level surface.

For best results, make sure that your trailer rides level with the ground when you hitch your vehicle. See **Connecting a Trailer** (page 323).



Make sure that the trailer and your vehicle are in line with each other. You can do this by putting the transmission in drive (D) and pulling straight forward.

## Configuring the Trailer in the Instrument Cluster Display

1. Shift to reverse (R).
2. Press the camera view button.
3. Press the trailer view icon.
4. Using the instrument cluster controls on the steering wheel, select **Add Trailer**.
5. Add a personalized name for the trailer using the instrument cluster display prompts. Use the down arrow to scroll to the preferred letter and then press the right arrow to advance to the next letter. Press the **OK** button.
6. Select the trailer brake type.

**Note:** Select **Default Electric/Surge/None** if the trailer has electric, surge or no brakes.

7. Select the trailer brake effort.

**Note:** The default value is **Low** and is the recommended setting for most trailers. Select a different setting if your trailer's brakes require more initial voltage, or you prefer more aggressive trailer braking.

8. Select the trailer type.

**Note:** The system could prompt you to setup **Trailer Blind Spot** before continuing the setup process.

9. Select whether you want to add the feature.

# Trailer Reverse Guidance (If Equipped)

## APPLYING THE TRAILER REVERSE AID STICKER

### Placing the Sticker

Place the sticker in an area visible by the rear view camera. The entire sticker must be within 7–20 in (17–51 cm) from the center of the hitch ball, as shown in the following illustration.

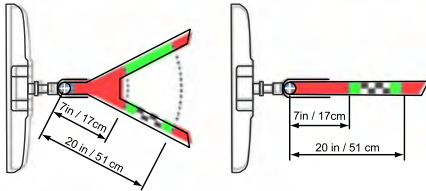

Use the supplied sticker placement card, a tape measure and pen to carefully mark the area to attach the sticker. The sticker is in the back cover pocket of your quick start guide. Make sure the entire sticker is within the green zone between the two arcs or distance markers on the diagram, and is also visible in the rear view camera display.

Once you have found the correct location, place the sticker.

**Note:** Make sure nothing can obstruct the rear view camera's view of the sticker such as a jack handle or wiring.

**Note:** Position the sticker on a flat, dry and clean horizontal surface. For best results, apply the sticker when temperatures are above 32°F (0°C).

**Note:** Do not move stickers after placing them. Do not re-use any stickers if removed.

**Note:** See your authorized dealer to purchase additional stickers.

### Taking the Measurements

After you place the sticker on your trailer, you must take some measurements.

The measurement card requires recording four distances: A, B, C and D. Record the trailer name for these measurements.

**Note:** Use consistent metric or imperial units as required by your country or vehicle.

**Note:** The system requires accurate measurements to properly operate.

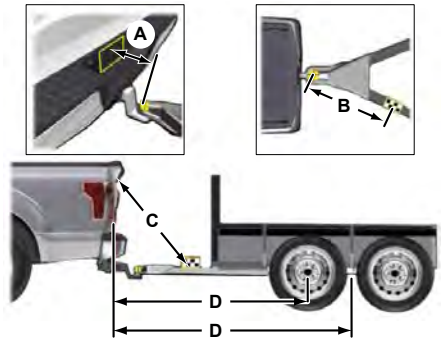

- A The horizontal distance from the license plate to the center of the ball hitch on the trailer.
- B The horizontal distance from the center of the ball hitch to the center of the sticker.
- C The point to point distance from the rear view camera to the center of the sticker.
- D The horizontal distance from the tailgate to the center of the trailer axle or axles.

**Note:** Distance D is the center of the axles for trailers with more than one axle.

**Note:** Round distance D to the nearest inch or centimeter.

# Trailer Reverse Guidance (If Equipped)

**Note:** When rounding in inches, round upward if the measured length is a quarter inch or greater. Round downward if the measured length is less than a quarter inch. For example, 12.25 in (31.11 cm) would be rounded up to 12.50 in (31.75 cm). 12.13 in (30.8 cm) would be rounded down to 12.00 in (30.48 cm).

**Note:** When rounding in centimeters, round to the nearest whole centimeter. If the measurement is less than 0.2 in (0.5 cm) round downward. If the measurement is more than or equal to 0.2 in (0.5 cm) round upward. For example, 11.9 in (30.3 cm) would be rounded down to 11.8 in (30 cm). 12.0 in (30.5 cm) would be rounded up to 12.2 in (31 cm).

## Entering the Measurements

Follow the prompts in the instrument cluster display to enter each of the measurements. Use the up and down arrows to increase or decrease the numbers, as necessary. Press OK to confirm each measurement. When you add the last measurement, the instrument cluster display shows all the measurements entered. You can choose to confirm or change the measurements.

## Confirming the Sticker Placement

Check the rear view camera display to see if the system identifies the sticker. The system marks the sticker with a red circle. Confirm that the red circle shows over the sticker image in the rear view camera display.

**Note:** If the system cannot locate the sticker, try cleaning the camera lens. Make sure the sticker is within the green zone.

## CALIBRATING THE SYSTEM

Calibrating the system requires driving straight forward. Follow the instructions in the instrument cluster display to complete the calibration process.

**Note:** Calibrating the system requires an area where you can safely drive forward. An open parking lot is an ideal place to perform the calibration.

**Note:** Keep the steering wheel straight when instructed to by the instrument cluster display. If the steering wheel is in a turned position during this instruction, the calibration pauses.

**Note:** The system is designed to work with drawbars that have a license plate to hitch ball center measurement of 9–20 in (23–52 cm) when installed. Do not attempt to use drawbars or trailers that have a length outside of this range as the system performance degrades and could cause improper system function.

**Note:** The instrument cluster display shows if you are going too slow or fast. Calibration pauses if the speed is outside the required range of 4–24 mph (6–39 km/h).

**Note:** For best results, do not calibrate the system at night when calibrating the system with the sticker.

## SETTING UP TRAILER REVERSE GUIDANCE FOR A FIFTH-WHEEL OR GOOSENECK TRAILER

### CONFIGURING THE TRAILER

You must configure a trailer in the system to use trailer reverse guidance. This is a one-time setup process and the trailer information is saved in the system for the next time you use that trailer.

## Trailer Reverse Guidance (If Equipped)

The following illustration shows examples of fifth-wheel and gooseneck trailers.

**Note:** Trailer reverse guidance camera views are available with no trailer setup. However, complete functionality including graphics and automatic view switching is enabled by setup. Setup is required to enable trailer backup assistance.



### Configuring the Trailer in the Instrument Cluster Display

1. Shift to reverse (R).
2. Press the camera view button.
3. Press the trailer view icon.
4. Using the instrument cluster controls on the steering wheel, select **Add Trailer**.
5. Add a personalized name for the trailer using the instrument cluster display prompts. Use the down arrow to scroll to the preferred letter and then press the right arrow to advance to the next letter. Press the **OK** button.
6. Select the trailer brake type.

**Note:** Select **Default Electric/Surge/None** if the trailer has electric, surge or no brakes.

7. Select the trailer brake effort.

**Note:** The default value is **Low** and is the recommended setting for most trailers. Select a different setting if your trailer's brakes require more initial voltage, or you prefer more aggressive trailer braking.

8. Select the trailer type.

**Note:** The system could prompt you to setup **Trailer Blind Spot** before continuing the setup process.

9. Select whether you want to add the feature.

### TRAILER SENSOR INSTALLATION

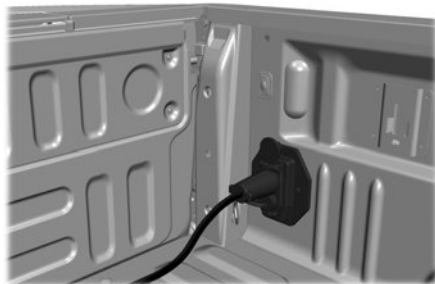

## Trailer Reverse Guidance (If Equipped)

To use the system with a fifth-wheel or gooseneck trailer, you must install a sensor. Refer to the instructions in the sensor kit for proper installation.

**Note:** Make sure the arrows on the sensor housing are facing up. Mount the sensor to a vertical part of the trailer that pivots and moves when you turn your vehicle. Do not mount to a stationary surface or to the truck side of the fifth-wheel trailer hitch.

**Note:** You need to replace the 7/4 way connector in the bumper with the recommended 7/12 pin connector if your vehicle did not come with the fifth-wheel prep package. See your authorized dealer.

**Note:** If your vehicle has the fifth-wheel prep package, you have everything you need. If your vehicle does not have the fifth-wheel prep package, see your authorized dealer to purchase the sensor kit and the 7/12 pin connector.

### CALIBRATING THE SYSTEM

Calibrating the system requires driving forward and turning left or right. Follow the instructions on the instrument cluster display and touchscreen to complete the calibration process.

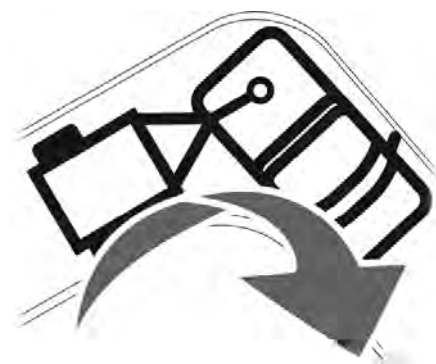

**Note:** Calibrating the system requires an area where you can safely drive forward and turn left or right. An open parking lot is an ideal place to perform the calibration.

**Note:** Keep the steering wheel straight when instructed to by the instrument cluster display and touchscreen. If the steering wheel is in a turned position during this instruction, the calibration pauses.

**Note:** During calibration, the system determines the trailer length. The system supports trailer lengths of 10–39 ft (3–11.94 m) distance from the hitch point to the center of the axle or axles.

**Note:** The instrument cluster display and touchscreen shows if you are going too slow or fast. Calibration pauses if the speed is outside the required range of 2–16 mph (4–25 km/h).

**Note:** You need to complete at least a 90° turn, and longer trailers could require a 180° turn.

### SWITCHING TRAILER REVERSE GUIDANCE ON AND OFF

Shift into reverse (R), press the rear camera button to expand the menu, press the trailer icon and use the instrument cluster display controls to select the connected trailer.

**Note:** If the trailer was connected just prior to turning the system on, you may need to drive forward to initialize the system. Follow the instructions in the instrument cluster display to activate the system.

# Trailer Reverse Guidance (If Equipped)

## USING TRAILER REVERSE GUIDANCE VIEWS

Up to seven camera views could be available when using trailer reverse guidance. Use the view that helps you the most when reversing your vehicle and trailer.



**360° camera view.** Shows a 360° view on the right-hand side of the touchscreen with a rear camera view on the left-hand side of the touchscreen.



**Rear view camera view.** Shows your trailer hitch or what is directly behind your vehicle.



**Rear split view camera view.** Shows a 180° degree view of what is behind your vehicle.



**Bed camera view.** Shows the truck bed.



**Trailer AUX camera view.** Shows a rear view camera image of what is behind your trailer. You need to separately purchase this camera and have it installed.



**Trailer reverse guidance view.** Shows you a view of the sides of your truck and the trailer. In auto mode, this view moves as the trailer moves so that you do not have to adjust the camera as you turn. Left and right arrows let you see other camera views.



**Straight backup mode.** Shows which way to turn your steering wheel to keep the trailer straight. Use this view when you want to keep your trailer completely in line with your truck.

**Note:** *It may be helpful to shift your vehicle into drive (D), pull forward and straighten out the vehicle and trailer before engaging straight backup mode.*



This takes you back to the 360° camera system and out of the trailer reverse guidance feature.



Auto. Press to return to auto view.

**Note:** *Auto mode is the default setting.*

## Hitch Angle Graphic

The hitch angle graphic shows a small representation of your truck and trailer with visual feedback to help you monitor the trailer. The graphic shows two different colored lines for the trailer hitch angle. A black line shows you where your trailer is in relation to your vehicle. The white line represents the amount the trailer can turn based on steering wheel position.

The graphic shows a yellow and red zone for the hitch angle to warn you of a high angle condition that could require you to pull forward to reduce the hitch angle. The angle limits for each zone vary based on the trailer length.

The yellow zone indicates you are approaching the maximum controllable trailer angle for the system. When the trailer enters this zone, it is more difficult to reduce the trailer turn when backing up. It may be necessary to put your vehicle back into drive (D) and pull forward to get the truck and trailer back to an in-line position.

The red zone indicates you have exceeded the maximum controllable trailer angle for the system. Immediately stop reversing. Put your vehicle into drive (D) and pull forward until the trailer is no longer in the red zone.

# Trailer Reverse Guidance (If Equipped)

## TRAILER REVERSE GUIDANCE – TROUBLESHOOTING

### TRAILER REVERSE GUIDANCE – INFORMATION MESSAGES

Message	Description
Detecting Trailer Please Wait...	Displays when the system turns on and is initializing.
Trailer Reverse Guidance System is Not Available	A condition exists that prevents the system from turning on. If the message continues to display, visit your authorized dealer to have your vehicle checked.
Trailer Reverse Guidance Driving Required to Initialize Steering Press OK to Exit	The steering system needs to learn internal parameters to fully enable the feature. Drive your vehicle straight forward above 25 mph (40 km/h) for approximately 5 minutes.
Stop now. Deactivated by trailer angle.	Displays when you exceed the maximum controllable trailer angle for the system. Place your vehicle in drive (D) and pull forward to get your vehicle and trailer back to an in-line position, then activate the system by selecting the connected trailer and following the instructions in the instrument cluster display. If this message consistently displays, you may need to repeat the trailer setup and calibration. Delete the trailer from the system and repeat the setup and calibration process.
Trailer Reverse Guidance Sensor Not Detected Refer to Owner's Manual Press OK to Exit	Displays when the system does not detect the sensor. Check the sensor connection, that there is no damaged wiring between the connector and sensor and that there is only one sensor connected.
Trailer Reverse Guidance Trailer Not Detected. Refer to Owner's Manual. Press OK to Exit	Displays when the system does not detect the trailer. Check that the sensor is correctly installed and the trailer length is within the allowed range. If these messages continue to display, visit your authorized dealer to have your vehicle checked.

## Trailer Reverse Guidance (If Equipped)

---

<b>Message</b>	<b>Description</b>
Trailer Reverse Guidance Trailer Not Detected Pull Forward to Initialize Press OK to Exit	Displays when your vehicle has not moved after the trailer sensor is connected or extended operation below 1 mph (1 km/h). Drive forward above 2 mph (3 km/h) to initialize the system.



# Trailer Reverse Guidance (If Equipped)

---

## TRAILER REVERSE GUIDANCE – FREQUENTLY ASKED QUESTIONS

### What does it mean if Measurement A has reached maximum or minimum value?

The system is designed to work with drawbars that have a license plate to hitch ball center measurement of 9–20 in (23–52 cm) when installed. Do not attempt to use drawbars that have a length outside this range as the system performance degrades and could cause improper system function. Make sure that the measurement being made is the horizontal distance only from the license plate to the hitch ball center. A straight line distance that includes any vertical rise or drop increases the measurement and makes it inaccurate. Inaccurate measurements degrade system performance and could cause improper system function. See **Applying the Trailer Reverse Aid Sticker** (page 359).

### What does it mean if Measurement B has reached its maximum or minimum value?

Make sure that the sticker is properly placed. Stickers placed outside the allowed zone adversely affects the system performance and could cause improper feature function. Make sure that the measurement being made is the horizontal distance only from center of the sticker to the hitch ball center. A straight line distance that includes any vertical rise or drop increases the measurement and causes an inaccurate value to be entered into the system. See **Applying the Trailer Reverse Aid Sticker** (page 359).

### What does it mean if Measurement C has reached its maximum or minimum value?

Make sure you follow the sticker placement instructions. Stickers placed outside the allowed zone adversely affect the system performance and could cause improper feature function. If you have met all the criteria for sticker placement and you see this message, the sticker is either too far below or too close to the camera to properly recognize the sticker. For the system to correctly operate, lower the sticker height if you receive the minimum warning or raise the sticker height if you receive the maximum warning. Only one sticker can be placed on the trailer for correct system function. The previous sticker must be removed or covered so only one sticker is visible to the camera. Measurement B and C must be measured again if a new sticker is placed on the trailer. See **Applying the Trailer Reverse Aid Sticker** (page 359).

### What does it mean if Measurement D has reached its maximum or minimum value?

Make sure that the measurement being made is the horizontal distance only from tailgate to the center of the single axle or the center of all the axles on the trailer. The system does not support trailer lengths outside the range allowed by the information display. See **Applying the Trailer Reverse Aid Sticker** (page 359).

# Trailer Reverse Guidance (If Equipped)

---

## **Why does the trailer not reverse straight when using a conventional trailer?**

Factors such as the drawbar connection to the hitch receiver, road camber, road grade and compliance in the trailer suspension can influence how straight the system is able to reverse your trailer when the knob is not turned. You can compensate for the trailer drifting to the right or left by slowly turning the knob until the trailer is following your preferred path and then holding the knob in that position. If you would like to recalibrate the system for straight backing, change the sticker option in the instrument cluster display. Confirm the measurements, and the system prompts you to perform the calibration procedure.

## **Why does the trailer not reverse straight when using a fifth-wheel or gooseneck trailer?**

Verify the sensor is correctly installed. Other factors such as the hitch connection, road camber, road slope and trailer suspension could influence how straight the system can reverse the trailer when the control knob is not turned. You can compensate for the trailer drifting to the right or left by slowly turning the knob until the trailer is following your desired path and then holding the knob in that position.

## **Why does the system not detect a sensor?**

There could be an issue with the connection, the wiring harness could be damaged, you could have multiple sensors connected or the sensor could be incorrectly installed. Check that the 12-way connector is fully inserted into the 12-way socket. The red rubber seal is not visible when the connector is fully inserted. Also check that the wiring harness sensor connection is fully inserted at the trailer sensor, and check for damaged wiring between the 12-way connector and the trailer sensor. Also, check that the sensor is installed on a vertical surface with the arrows pointing straight up.

## **What does it mean if the system remains on one message for an extended time during calibration when setting up the system with a conventional trailer?**

The camera could need to be cleaned, the sticker could be blocked, the drawbar could be outside the allowed range of 4–19 in (10–48 cm) or you could need to move to a different area to change the lighting and background. Verify the sticker is in the proper location. See **Applying the Trailer Reverse Aid Sticker** (page 359). You can move to a different area or change the direction you are driving or setup the system at a different time of day. Some trailers are not compatible with the sticker and camera system.

## **What does it mean if the system pauses during calibration?**

There could be steering input or trailer movement during the straight drive portion of the calibration process.

# Trailer Reverse Guidance (If Equipped)

---

## **What does it mean if the system remains on one message for an extended time during calibration when setting up the system with a fifth-wheel or gooseneck trailer?**

The sensor could be incorrectly installed, the trailer length could be outside the allowed range or the road surface could be too rough or bumpy.

## **What does it mean if the system displays hold steering steady during turn?**

Part of the calibration process for the sticker setup requires a steady turn. If you are continually moving the steering wheel during the turn, this delays the calibration process. To enable the calibration process, hold the steering wheel at the same position when turning.

## **What does it mean if the system displays that it is not available?**

There could be a sub-system that the system uses that is not correctly operating or there could be a battery voltage issue. If the system continues to display it is not available, visit your authorized dealer to have your vehicle checked.

## **What does it mean if the system displays that driving is required to initialize steering?**

The steering system needs to learn internal parameters to fully turn on the feature. Drive your vehicle straight forward above 25 mph (40 km/h) for approximately 5 minutes. This could also occur when your vehicle is new, there is a battery voltage issue or if the steering system has been serviced.

## **What does it mean if the system does not detect a trailer when configured for a fifth-wheel or gooseneck trailer?**

Verify that the sensor is properly connected. See **Trailer Sensor Installation** (page 344). Repeat calibration on a different route if you have verified sensor installation.

## **What does it mean if the system requires you to pull forward to initialize?**

This occurs when the vehicle has not moved during the current key cycle after you connect and select the trailer in the instrument cluster display or you operate the system at speeds below 1 mph (1 km/h) for an extended period of time. Drive forward above 2 mph (3 km/h) and the system indicates when it initializes.

## Trailer Reverse Guidance (If Equipped)

---

### **What does it mean if the trailer is at its maximum angle or the system deactivated by trailer angle when using a conventional trailer?**

The system uses your measurements to determine sticker position and establish system limits. Accurate sticker placement and trailer measurements provide the best system performance. If you are consistently receiving this warning, it is likely there is an issue with sticker placement or the entered measurements. Make sure that the sticker is placed correctly and the measurements were made correctly. See **Applying the Trailer Reverse Aid Sticker** (page 359). To change the sticker location or change trailer measurements, change the sticker option in the instrument cluster display. If the sticker location needs to be changed, the previous sticker must be removed and a new sticker needs to be placed on the trailer. Only one sticker should be placed on the trailer for proper system function.

### **What does it mean if the trailer is at its maximum angle or the system deactivated by trailer angle when using a fifth-wheel or gooseneck trailer?**

You are at the maximum controllable trailer angle for the system. Place your vehicle in drive (D) and pull forward to get the truck and trailer back to an in-line position. If this message consistently displays, this could indicate the sensor is incorrectly installed, the trailer needs to be recalibrated or the drawbar or the trailer dimensions are outside of the supported range. The system is designed to work with drawbars that have a license plate to hitch ball center measurement of 9–20 in (23–52 cm) when installed. The system is designed to work with trailers that have a hitch point to center of the axle or axles measurement of 6–33 ft (1.85–10.05 m). Do not attempt to use drawbars or trailers that have a length outside of this range as the system performance degrades and could cause improper system function. Check that the correct trailer is selected in the instrument cluster display. Verify the sensor is installed according to the instructions included in the sensor kit and check that the drawbar and the trailer dimensions are within the allowed range. Then, delete the trailer from the system and repeat the setup process to calibrate the trailer.

# Trailer Reverse Guidance (If Equipped)

---

## What does it mean when the system tells you to take control of the steering wheel?

The system is no longer steering the vehicle and you must take over steering. There are four reasons the system could display this message. The first reason the system could display this message is that you have touched the steering wheel when the system is steering. The second reason the system could display this message is that you have exceeded the maximum speed for the feature. The third reason the system could display this message is that the trailer is not detected. The final reason the system could display this message is that an internal condition for system operation is not met that requires your vehicle to return to manual control of the steering.

## What does it mean if the system circles something besides the sticker or cannot find the sticker?

The system requires a clear view of the sticker placed on the trailer and accurate measurements to locate the sticker. Remove any items that may be blocking the view of the sticker. Depending on your trailer configuration and any equipment mounted to your trailer, it is possible for the sticker to be blocked from view of the camera as it rotates on the hitch ball but not be blocked during setup. It may be necessary to remove the sticker from its current location if the obstruction cannot be cleared. The sticker location must still meet the requirements noted the setup instructions. See **Applying the Trailer Reverse Aid Sticker** (page 359). Verify the measurements you entered into the system are accurate. To change the sticker location or change trailer measurements, change the sticker option in the instrument cluster display. If the system cannot initially detect the trailer, it could be necessary for you to change the lighting conditions by moving your vehicle and trailer or waiting until the conditions change. Some trailers are not compatible with the sticker and camera system. Only one sticker can be placed on the trailer for correct system function.

**Note:** *The system is designed to be used with the same trailer connection every time you choose the trailer from the instrument cluster display. When using a different drawbar or a different pin hole on drawbars with more than one, connecting the drawbar to your vehicle affects the trailer measurements. Take the measurements again and update if required.*

# Driving Hints

---

## OFF-ROAD DRIVING

### WHAT IS OFF-ROAD DRIVING

Off-road driving is driving your vehicle on unsurfaced roads or trails, made from dirt, rocks, sand and mud.

### BASIC OFF-ROAD DRIVING TECHNIQUES

#### Off-road Driving Hints

Before taking your vehicle off-roading, a basic vehicle inspection should be done to make sure that the vehicle is in top working condition. It is always recommended that at least two vehicles are used while off-roading. The buddy system helps make sure that help is close at hand should a vehicle become stuck or damaged. It is also wise to take supplies such as a first aid kit, supply of water, tow strap, cell or satellite phone with you any time an off-road excursion is planned.

1. Grip the steering wheel with thumbs on the outside of the rim. This will reduce the risk of injury due to abrupt steering wheel motions that occur when negotiating rough terrain.
2. Throttle, brake and steering inputs should be made in a smooth and controlled manner. Sudden inputs to the controls can cause loss of traction or upset the vehicle, especially while on loose terrain or while crossing obstacles such as rocks or logs.
3. Look ahead on your route noting upcoming obstacles, or any other factors which may indicate a change in available traction, and adjust the vehicle speed and route accordingly.

4. When driving off-road, if the front or rear suspension is bottoming out and/or excessive contact with the skid-plates is encountered, reduce vehicle speed to avoid potential damage to the vehicle.
5. When with other vehicles, it is recommended that communication is used, and the lead vehicle notify other vehicles of obstacles that could cause potential vehicle damage.
6. Always keep available ground clearance in mind and pick a route that minimizes the risk of catching the underside of the vehicle on an obstacle.
7. When negotiating low speed obstacles, applying light brake pressure in conjunction with the throttle will help prevent the vehicle from jerking and will allow you to negotiate the obstacle in a more controlled manner. Using 4L will also help with this.
8. Off-roading requires a high degree of concentration. Even if your local law does not prohibit alcohol use while driving off-road, Ford strongly recommends against drinking if you plan to off-road.

#### Crossing Obstacles

- Review the path ahead before attempting to cross any obstacle. It is best if the obstacle is reviewed from outside the vehicle so that there is a good understanding of terrain condition both in front of and behind the obstacle.
- Approach obstacles slowly.

# Driving Hints

- If a large obstacle such as a rock cannot be avoided, choose a path that places the rock directly under the tire rather than the undercarriage of the vehicle. This will help prevent damage to the vehicle.
- Ditches and washouts should be crossed at a 45° angle, allowing each wheel to independently cross the obstacle.

## Hill Climbing



**WARNING:** Extreme care should be used when steering the vehicle in reverse down a slope so as not to cause the vehicle to swerve out of control.

- Always attempt to climb a steep hill along the fall line of the slope and not diagonally.
- If the vehicle is unable to make it up the hill, DO NOT attempt to turn back down the slope. Place the vehicle in low range and slowly back down in reverse.
- When descending a steep slope, select low gear and engage hill descent control. Use the throttle and brake pedals to control your descent speed.

**Note:** *Hill descent control is functional in reverse and should be used in this situation.*

## DRIVING THROUGH WATER LIMITATIONS - TREMOR

Model	Maximum Wading Depth
All.	33 in (837 mm)

When you are driving through water do not exceed 4 mph (7 km/h).

## AFTER DRIVING YOUR VEHICLE OFF-ROAD



**WARNING:** After off-road use, before returning to the road, check the wheels and tires for damage. Off-road use may cause damage to your wheels and tires that can lead to tire failure, loss of vehicle control, serious injury or death.

Driving off-road places more stress on your vehicle than most on-road driving. After driving off-road check for damage to your vehicle and, if necessary, have your vehicle fixed as soon as possible.

Inspect the underbody of your vehicle by checking tires, body structure, steering, suspension, and exhaust system for damage.

Check the radiator for mud and debris and clean as needed.

Remove accumulations of plants or brush. These things could be a fire hazard or hide damage to the fuel lines, brake hoses, and propeller shafts.

After extended operation in mud, sand, water, or similar dirty conditions, inspect the underbody and clean your vehicle as soon as possible.

If you experience unusual vibration after driving in mud, slush or similar conditions, check the wheels for impacted material. Impacted material can cause vibrations while driving and wheel imbalance. Remove the material to resolve the problem.

# Driving Hints

## COLD WEATHER PRECAUTIONS

The functional operation of some components and systems can be affected at temperatures below approximately -13°F (-25°C).

## BREAKING-IN

Your vehicle requires a break-in period. For the first 1,000 mi (1,600 km), avoid driving at high speeds, heavy braking, aggressive shifting or using your vehicle to tow. During this time, your vehicle may exhibit some unusual driving characteristics.

## DRIVING ECONOMICALLY

The following helps to improve fuel consumption:

- Drive smoothly, accelerate gently and anticipate the road ahead to avoid heavy braking.
- Regularly check your tire pressures and make sure that they are inflated to the correct pressure.
- Follow the recommended maintenance schedule and carry out the recommended checks.
- Plan your journey and check the traffic before you set off. It is more efficient to combine errands into a single trip whenever possible.
- Avoid idling the engine in cold weather or for extended periods. Start the engine only when you are ready to set off.
- Do not carry unnecessary weight in your vehicle as extra weight wastes fuel.

- Do not add unnecessary accessories to the exterior of your vehicle, for example running boards. If you use a roof rack, remember to fold it down or remove it when not in use.
- Do not shift into neutral when you are braking or when your vehicle is slowing down.
- Shut all windows when driving at high speeds.
- Switch off all electric systems when not in use, for example air conditioning. Make sure that you unplug any accessories from the auxiliary power points when not in use.

## DRIVING THROUGH SHALLOW WATER



**WARNING:** Do not attempt to cross a deep or flowing body of water. Failure to follow this instruction could result in the loss of control of your vehicle, personal injury or death.

**Note:** *Driving through standing water can cause vehicle damage.*

**Note:** *Engine damage can occur if water enters the air filter.*

Before driving through standing water, check the depth. Never drive through water that is higher than the bottom of the wheel hubs.



# Driving Hints

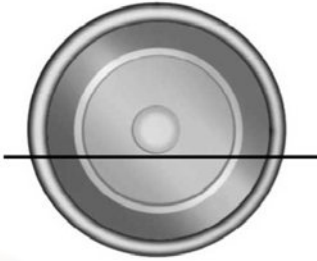

When driving through standing water, drive very slowly and do not stop your vehicle. Your brake performance and traction could be limited. After driving through water and as soon as it is safe to do so:

- Lightly press the brake pedal to dry the brakes and to check that they work.
- Turn the steering wheel to check that the steering power assist works.

Check the function of the following:

- Horn
- Exterior lights

## FLOOR MATS

**WARNING:** Use a floor mat designed to fit the footwell of your vehicle that does not obstruct the pedal area. Failure to follow this instruction could result in the loss of control of your vehicle, personal injury or death.

**WARNING:** Pedals that cannot move freely can cause loss of vehicle control and increase the risk of serious personal injury.

**WARNING:** Secure the floor mat to both retention devices so that it cannot slip out of position and interfere with the pedals. Failure to follow this instruction could result in the loss of control of your vehicle, personal injury or death.

**WARNING:** Do not place additional floor mats or any other covering on top of the original floor mats. This could result in the floor mat interfering with the operation of the pedals. Failure to follow this instruction could result in the loss of control of your vehicle, personal injury or death.

**WARNING:** Always make sure that objects cannot fall into the driver foot well while your vehicle is moving. Objects that are loose can become trapped under the pedals causing a loss of vehicle control.



To install floor mats that have eyelets, position the floor mat eyelet over the retention post and press down to lock in position. Repeat for all eyelets on the floor mat.

To remove the floor mats, reverse the installation procedure.

# Driving Hints

---

**Note:** *Regularly check the floor mats to make sure they are secure.*

# Snow Plowing

## SNOW PLOWING PRECAUTIONS



**WARNING:** Modifying or adding equipment to the front of your vehicle could affect the performance of the airbag system, increasing the risk of injury. This includes the hood, bumper system, frame, front body structure, tow hooks, hood pins, push bar and snowplows.



**WARNING:** Do not attempt to service, repair, or modify the supplementary restraint system or associated components. Failure to follow this instruction could result in personal injury or death.



**WARNING:** All occupants of your vehicle, including the driver, should always properly wear their seatbelts, even when an airbag supplemental restraint system is provided. Failure to properly wear your seatbelt could seriously increase the risk of injury or death.



**WARNING:** Do not spin the wheels at over 34 mph (55 km/h). The tires may fail and injure a passenger or bystander.

**Note:** Look for an alterer's label on your vehicle from the snowplow installer certifying that the installation meets all applicable Federal Motor Vehicle Safety Standards (FMVSS).

**Note:** Federal and some local regulations require additional exterior lamps for snowplow-equipped vehicles. Contact an authorized dealer for additional information.

**Note:** Do not remove or defeat the tripping mechanisms designed into the snow removal equipment by its manufacturer. Doing so could cause damage to your vehicle and the snow removal equipment as well as possible airbag deployment.

## OPERATING YOUR VEHICLE WITH A SNOWPLOW

Ford Motor Company recommends the snowplow package if using your vehicle for snow removal. Weight limits and guidelines for selecting and installing the snowplow are in the Ford Truck Body Builders Layout Book. For additional information, visit [www.fordbbas.com/home](http://www.fordbbas.com/home).

A typical snowplow installation affects the following:

- The total accessory reserve capacity, which is the weight of permanently-attached auxiliary equipment, such as snowplow frame-mounting hardware, that you can add to the vehicle and satisfy Ford Motor Company compliance certification. This weight is on the lower right-hand side of the vehicle's Safety Compliance Certification Label and applies to Ford Motor Company-completed vehicles of 10,000 lb (4,536 kg) gross vehicle weight rating or less. Exceeding this weight could require additional safety certification responsibility for the auxiliary equipment installer. See **Locating the Safety Compliance Certification Labels** (page 312).
- Front gross axle weight rating. See **What Is the Gross Axle Weight Rating** (page 312).
- Gross vehicle weight rating. See **What Is the Gross Vehicle Weight Rating** (page 312).

# Snow Plowing

---

- Braking and steering.
- Front wheel toe. See the **Ford Workshop Manual**.
- Headlight aim. See **Adjusting the Headlamps** (page 411).
- Tire air pressure. See **Information on the Tire Sidewall** (page 430).

**Note:** Do not exceed the front gross axle weight rating or gross vehicle weight rating.

**Note:** Your vehicle may require rear ballast weight for proper braking and steering.

Your vehicle has a driver and passenger airbag supplemental restraint system. The supplemental restraint system activates in certain frontal and offset frontal collisions when the vehicle sustains sufficient longitudinal deceleration.

When operating your vehicle with a snowplow:

- Do not exceed 45 mph (72 km/h).
- Your engine could run at a higher temperature than normal.
  - If you are driving more than 15 mi (24 km) at temperatures above freezing, angle the plow blade either full left or full right to provide maximum airflow to the radiator.
  - If you are driving less than 15 mi (24 km) at speeds up to 45 mph (72 km/h) in cold weather, you do not need to worry about blade position to provide maximum airflow.
- Shift to **4L** when plowing in small areas at speeds below 5 mph (8 km/h).
- Shift to **4H** when plowing larger areas or light snow at higher speeds above 5 mph (8 km/h). Do not exceed 15 mph (24 km/h).
- Do not shift the transmission from a forward gear to reverse (R) until the engine is at idle and the wheels have stopped.

**Note:** Careless or high-speed driving when snowplowing, which results in significant vehicle decelerations, can deploy the airbag. Such driving also increases the risk of accidents.

**Note:** Drive your vehicle at least 500 mi (800 km) before using your vehicle for snowplowing.

**Note:** Follow the severe duty schedule for engine oil and transmission fluid change intervals. See **Special Operating Conditions Scheduled Maintenance** (page 631).

# Crash and Breakdown Information

---

## ROADSIDE ASSISTANCE

### Vehicles Sold in the United States: Getting Roadside Assistance

To fully assist you should you have a vehicle concern, Ford Motor Company offers a complimentary roadside assistance program. This program is separate from the New Vehicle Limited Warranty.

The service is available:

- 24 hours a day, seven days a week.
- For the coverage period supplied with your vehicle.

Roadside Assistance covers:

- A flat tire change with a good spare (except vehicles supplied with a tire inflation kit).
- Battery jump start.
- Lock-out assistance (key replacement cost is the customer's responsibility).
- Fuel delivery — independent service contractors, if not prohibited by state, local or municipal law, shall deliver up to 2 gal (8 L) of gasoline or 5 gal (20 L) of diesel fuel to a disabled vehicle. Roadside assistance limits fuel delivery service to two no-charge occurrences within a 12-month period.
- Winch out — available within 100 ft (30 m) of a paved or county maintained road, no recoveries.

- Towing — independent service contractors, if not prohibited by state, local or municipal law, shall tow Ford eligible vehicles to an authorized dealer within 35 mi (56 km) of the disablement location or to the nearest authorized dealer. If a member requests a tow to an authorized dealer that is more than 35 mi (56 km) from the disablement location, the member shall be responsible for any mileage costs in excess of 35 mi (56 km).
- Roadside Assistance includes up to \$200 for a towed trailer if the disabled eligible vehicle requires service at the nearest authorized dealer. If the towing vehicle is operational but the trailer is not, then the trailer does not qualify for any roadside services.

### Vehicles Sold in the United States: Using Roadside Assistance

Complete the roadside assistance identification card and place it in your wallet for quick reference. This card is in the Owner's Manual kit.

United States vehicle customers who require Roadside Assistance, call 1-800-241-3673.

If you need to arrange roadside assistance for yourself, Ford Motor Company reimburses a reasonable amount for towing to the nearest dealership within 35 mi (56 km). To obtain reimbursement information, United States vehicle customers call 1-800-241-3673. Customers need to submit their original receipts.

# Crash and Breakdown Information

## Vehicles Sold in Canada: Getting Roadside Assistance

To fully assist you should you have a vehicle concern, Ford Motor Company of Canada, Limited offers a complimentary roadside assistance program. This program is eligible within Canada or the continental United States.

The service is available 24 hours a day, seven days a week.

This program is separate from the New Vehicle Limited Warranty, but the coverage is concurrent with the powertrain coverage period of your vehicle. Canadian roadside coverage and benefits may differ from the U.S. coverage.

If you require more information, please call us in Canada at 1-800-665-2006, or visit our website at [www.ford.ca](http://www.ford.ca).

## SWITCHING THE HAZARD FLASHERS ON AND OFF



The hazard flasher button is on the instrument panel. Press the button to switch the hazard flashers on if your vehicle is creating a safety hazard for other road users.

When you switch the hazard flashers on, all front and rear direction indicators flash.

**Note:** *The hazard flashers operate when the ignition is in any position, or if the key is not in the ignition. The battery loses charge and could have insufficient power to restart your vehicle.*

Press the button again to switch them off.

## JUMP STARTING THE VEHICLE

### JUMP STARTING PRECAUTIONS



**WARNING:** Batteries normally produce explosive gases which can cause personal injury. Therefore, do not allow flames, sparks or lighted substances to come near the battery. When working near the battery, always shield your face and protect your eyes. Always provide correct ventilation.



**WARNING:** Keep batteries out of reach of children. Batteries contain sulfuric acid. Avoid contact with skin, eyes or clothing. Shield your eyes when working near the battery to protect against possible splashing of acid solution. In case of acid contact with skin or eyes, flush immediately with water for a minimum of 15 minutes and get prompt medical attention. If acid is swallowed, call a physician immediately.



**WARNING:** Use only adequately sized cables with insulated clamps.



**WARNING:** Make sure that the cables are clear of any moving parts and fuel delivery system parts.



**WARNING:** Connect batteries with only the same nominal voltage.



**WARNING:** If the engine is running while the hood is open, stay clear of moving engine components. Failure to follow this warning could result in serious personal injury or death.

Do not attempt to push-start an automatic transmission vehicle. This could cause transmission damage.

# Crash and Breakdown Information

Do not disconnect the battery of the disabled vehicle. This could damage your vehicle's electrical system.

## PREPARING THE VEHICLE

Use only a 12 volt supply to start your vehicle.

Park the booster vehicle close to the hood of the disabled vehicle, making sure the two vehicles do not touch.

## JUMP STARTING THE VEHICLE

### Connecting the Jumper Cables



**WARNING:** Do not connect the negative jumper cable to any other part of your vehicle. Use the ground point.

**Note:** If you are using a jump pack or booster box, follow the manufacturer's instructions.

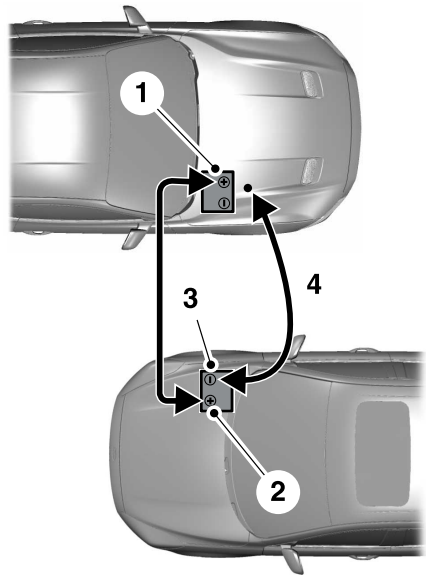

1. Pull the red rubber boot backward. Connect the positive (+) jumper cable to the positive (+) terminal of the discharged battery.
2. Connect the other end of the positive (+) jumper cable to the positive (+) terminal of the booster vehicle battery.
3. Connect the negative (-) jumper cable to the negative (-) terminal of the booster vehicle battery.
4. Make the final connection of the negative (-) jumper cable to an exposed metal part of the disabled vehicle's engine, as shown in the following illustration, away from the battery and fuel injection system, or connect the negative (-) jumper cable to a ground connection point if available.

# Crash and Breakdown Information

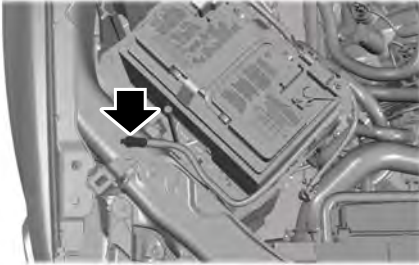

## HOW DOES THE POST-CRASH ALERT SYSTEM WORK

The system is designed to turn the hazard flashers on and to intermittently sound the horn in the event of a serious impact that deploys an airbag or the seatbelt pretensioners.

## POST-CRASH ALERT SYSTEM LIMITATIONS

Depending on applicable laws in the country your vehicle was built for, the horn does not sound in the event of a serious impact.

## SWITCHING THE POST-CRASH ALERT SYSTEM OFF

Press the hazard flasher switch or the unlock button on the remote control to switch the system off.

**Note:** *The alert turns off when the vehicle battery runs out of charge.*

## Starting the Engine

1. Start the engine of the booster vehicle and moderately rev the engine, or gently press the accelerator to keep the engine speed between 2000 and 3000 RPM, as shown in your tachometer.
2. Start the engine of the disabled vehicle.
3. Once you start the disabled vehicle, run both vehicle engines for an additional three minutes before disconnecting the jumper cables.

## Removing the Jumper Cables

Remove the jumper cables in the reverse order that they were connected.

**Note:** *Do not switch the headlamps on when disconnecting the cables. The peak voltage could blow the bulbs.*

## POST-CRASH ALERT SYSTEM

### WHAT IS THE POST-CRASH ALERT SYSTEM

The system helps draw attention to your vehicle in the event of a serious impact.

## AUTOMATIC CRASH SHUTOFF

### WHAT IS AUTOMATIC CRASH SHUTOFF

The automatic crash shutoff is designed to stop the fuel going to the engine in the event of a moderate or severe crash.

**Note:** *Not every impact causes a shutoff.*



# Crash and Breakdown Information

## AUTOMATIC CRASH SHUTOFF PRECAUTIONS



**WARNING:** If your vehicle has been involved in a crash, have the fuel system checked. Failure to follow this instruction could result in fire, personal injury or death.

## RE-ENABLING YOUR VEHICLE

1. Switch the ignition off.
2. Attempt to start your vehicle.
3. Switch the ignition off.
4. Attempt to start your vehicle.

**Note:** *If your vehicle does not start after the third attempt, have your vehicle checked as soon as possible.*

## RECOVERY TOWING

### ACCESSING THE FRONT TOWING POINT



**WARNING:** Using recovery hooks is dangerous and should only be done by a person familiar with proper vehicle recovery safety practices. Improper use of recovery hooks may cause hook failure or separation from the vehicle and could result in serious injury or death.



**WARNING:** Slowly remove the slack from the recovery strap prior to pulling. Failure to do so can introduce significantly higher loads which can cause the recovery hooks to break off, or the recovery strap to fail which can cause serious injury or death.



**WARNING:** Never link two straps together with a clevis pin. These heavy metal objects could become projectiles if the strap breaks and can cause serious injury or death.

Your vehicle has frame-mounted front recovery hooks.

**Note:** *Do not apply a load to the recovery hooks that is greater than the gross vehicle weight rating of your vehicle.*

Before using recovery hooks:

- Make sure all attaching points are secure and capable of withstanding the applied load.
- Do not use chains, cables or tow straps with metal hook ends.
- Only use recovery straps that have a minimum breaking strength two to three times the gross vehicle weight of the stuck vehicle.
- Make sure the recovery strap is in good condition and free of visible cuts, tears or damage.
- Use a damper device such as a tarp, heavy blanket or piece of carpet, and place it over the recovery strap to help absorb the energy in the event the strap breaks.
- Make sure the stuck vehicle is not loaded heavier than its gross vehicle weight rating specified on the certification label.
- Align the tow vehicle and stuck vehicle in a straight line, within 10 degrees.
- Keep bystanders to the sides of the vehicle, at a distance of at least twice the length of the recovery strap. This helps avoid injury from the hazard of a recovery hook or strap breaking, or a vehicle lurching into their path.

# Crash and Breakdown Information

---

## TRANSPORTING THE VEHICLE

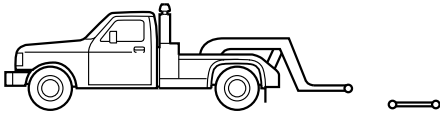

All-wheel or four-wheel drive vehicles require that all wheels be off the ground using a wheel lift and dollies or flatbed equipment. This prevents damage to the transmission and drive system.

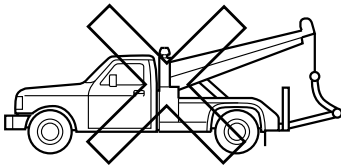
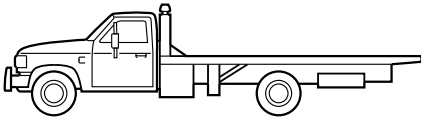

If you need to tow your vehicle, contact a professional towing service or your roadside assistance service provider.

Your manufacturer produces a towing manual for all authorized tow truck operators. Have your tow truck operator refer to this manual for proper hook-up and towing procedures.

We recommend the use of a wheel lift and dollies or flatbed equipment to tow your vehicle. Vehicle damage could occur if towed incorrectly, or by any other means.

Front-wheel and rear-wheel drive vehicles must have their designated drive wheels off the ground regardless of towing direction. Use tow dollies to prevent damage to the transmission.

# Towing Your Vehicle

## TOWING YOUR VEHICLE PRECAUTIONS

Use the following guidelines when towing your vehicle. Failure to follow this instruction could result in vehicle damage not covered by the vehicle warranty.

**Note:** Make sure you properly secure your vehicle to the tow vehicle.

**Note:** If you are unsure of the vehicle's configuration, contact an authorized dealer.

## RECREATIONALLY TOWING YOUR VEHICLE - 4X4



**WARNING:** Do not disconnect the battery when recreationally towing your vehicle. This prevents the transfer case from shifting properly and could cause the vehicle to roll, even if the transmission is in park (P).



**WARNING:** Placing the transfer case in its neutral position could cause your vehicle to freely roll. Make sure you press and hold the brake pedal and the vehicle is in a secure, safe position when you place the transfer case in its neutral position.

Follow these guidelines if you have a need for recreational towing. An example of recreational towing would be towing your vehicle behind a motorhome. These guidelines are to make sure that you do not damage the transmission.

You can only tow your vehicle with all wheels on the ground by placing the transfer case in its neutral position and engaging the recreational tow feature. Perform the following steps after positioning your vehicle behind the tow vehicle and properly securing them together.

**Note:** Put your climate control system in recirculated air mode to prevent exhaust fumes from entering your vehicle.

**Note:** Failure to put the transfer case in its neutral position can damage vehicle components.

**Note:** You can check the towing status at any time by opening the driver door or turning the ignition to the accessory or on position. **Neutral Tow Enabled Leave Transmission in Neutral** appears in the instrument cluster display to confirm you can recreationally tow your vehicle.

**Note:** If your vehicle has an anti-theft alarm, make sure you switch perimeter sensing on when towing. See **Setting the Alarm Security Level** (page 107).

### Switching Neutral Tow On

1. Place your vehicle in accessory mode by pressing the push button ignition switch once without pressing the brake pedal or by turning the ignition key to the on position.
2. Press and hold the brake pedal.
3. Rotate the four-wheel drive control to **2H**.
4. Shift into neutral (N).
5. Using the instrument cluster controls on the steering wheel, select **Settings**.
6. Select **Advanced Settings**.
7. Select **Vehicle**.
8. Select **Neutral Tow**.

# Towing Your Vehicle

---

9. Press and hold the **OK** button until a confirmation message appears in the information display.

**Note:** If completed successfully, the information display shows **Neutral Tow Enabled Leave Transmission in Neutral**. This indicates that your vehicle is safe to tow with all wheels on the ground.

**Note:** If you do not see a confirmation message in the instrument cluster display, you must perform the procedure again from the beginning.

**Note:** You may hear noise as the transfer case shifts into its neutral position. This is normal.

10. Leave the transmission in neutral (N) and switch your vehicle off by pressing the push button ignition switch once without pressing the brake pedal or turning the key as far toward the off position.

**Note:** Vehicles with keys do not turn to the off position when the transmission is in neutral (N). You must leave the key in the ignition when towing. Use the keyless entry keypad or an extra set of keys to lock and unlock your vehicle.

## Switching Neutral Tow Off

1. With your vehicle properly secured to the tow vehicle, place your vehicle in accessory mode by pressing the push button ignition switch once without pressing the brake pedal or by turning the ignition key to the on position.
2. Press and hold the brake pedal.
3. Shift out of neutral (N).
4. Release the brake pedal.

**Note:** If completed successfully, the instrument cluster displays **2H** and **Neutral Tow Disabled**.

**Note:** You must perform the switching neutral tow on and switching neutral tow off procedures again from the beginning if the indicator light and message do not display.

**Note:** You may hear a noise as the transfer case shifts out of its neutral position. This is normal.

5. Apply the parking brake, then disconnect your vehicle from the tow vehicle.
6. Release the parking brake, start the engine, and shift into drive (D) to make sure the transfer case is out of the neutral tow position.
7. If the transfer case does not successfully shift out of its neutral position, set the parking brake. Have your vehicle checked as soon as possible.

## Resolving the Shift Delayed Pull Forward Message

1. Press and hold the brake pedal.
2. Start your vehicle.
3. Shift into neutral (N).
4. With the vehicle running, shift into drive (D) and let the vehicle roll forward up to 3 ft (1 m).

**Note:** You may hear a noise as the transfer case shifts out of its neutral position. This is normal.

5. Make sure the instrument cluster displays **Neutral Tow Disabled**.

# Towing Your Vehicle

## RECREATIONALLY TOWING YOUR VEHICLE - 4X2

You cannot recreational tow your vehicle with all wheels on the ground because vehicle or transmission damage could occur. You must recreational tow your vehicle with all four wheels off the ground, such as when using a car-hauling trailer. Otherwise, you cannot recreational tow your vehicle.

## EMERGENCY TOWING

If your vehicle becomes inoperable without access to wheel dollies or a vehicle transport trailer, it can be flat-towed with all wheels on the ground, regardless of the powertrain and transmission configuration, under the following conditions:

- Your vehicle is facing forward for towing in a forward direction.
- The transmission is in neutral (N). If you cannot move the transmission into neutral (N), use the brake shift interlock procedure. See **Using Brake Shift Interlock** (page 226). Failure to do so could result in damage to the transmission.
- Maximum speed is 35 mph (56 km/h).
- Maximum distance is 50 mi (80 km).

## TOWING YOUR VEHICLE – TROUBLESHOOTING

## TOWING YOUR VEHICLE – INFORMATION MESSAGES

Message	Details
Neutral Tow Enabled Leave Transmission in Neutral	The transfer case is in the neutral position and your vehicle is safe to tow with all four wheels on the ground.
Shift Delayed Pull Forward	There is a transfer case gear tooth blockage present. With your vehicle on, shift the transmission into drive (D) and let the vehicle roll forward, up to 3 ft (1 m).
Neutral Tow Disabled	The transfer case is not in the neutral position and your vehicle is not safe to tow with all four wheels on the ground.

# Fuses

## FUSE PRECAUTIONS



**WARNING:** Always disconnect the battery before servicing high current fuses.



**WARNING:** To reduce risk of electrical shock, always replace the cover to the power distribution box before reconnecting the battery or refilling fluid reservoirs.



**WARNING:** Always replace a fuse with one that has the specified amperage rating. Using a fuse with a higher amperage rating can cause severe wire damage and could start a fire.

## UNDER HOOD FUSE BOX

### LOCATING THE UNDER HOOD FUSE BOX

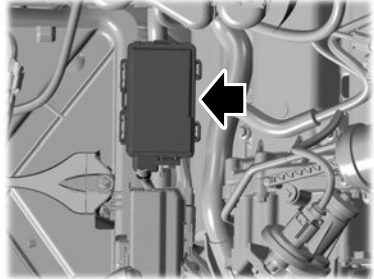

### ACCESSING THE UNDER HOOD FUSE BOX

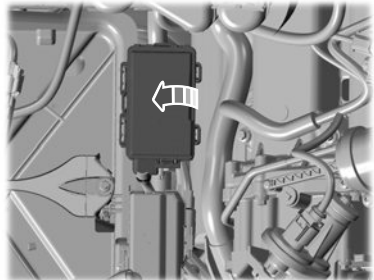

# Fuses

## IDENTIFYING THE FUSES IN THE UNDER HOOD FUSE BOX

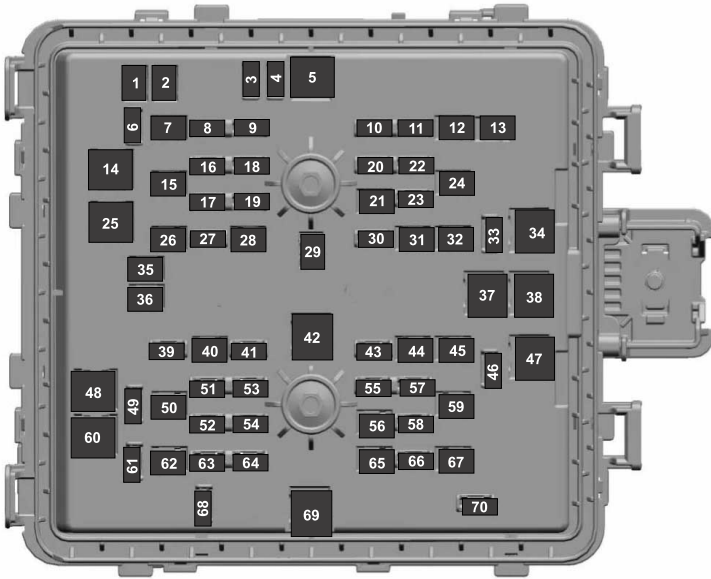

Item	Rating	Protected Component
1	20 A	Power point 4.
2	20 A	Power point 3.
3	10 A	Spot light module.
4	10 A	Four-wheel drive vacuum solenoid.
5	40 A	Active front steering.
6	10 A	Snow plow.
7	30 A	Trailer tow battery charge.
8	10 A	Anti-lock brake system module.

# Fuses

Item	Rating	Protected Component
9	10 A	Electronic power assisted steering module.
10	30 A	Trailer tow park lamps.
11	20 A	Horn.
12	30 A	Torque overlay.
13	30 A	Power sliding rear window.
14	40 A	Body control module - battery power in feed 1.
15	30 A	Passenger seat power.
16	10 A	Powertrain control module. Transmission control module.
17	10 A	Blind spot information system.
18	10 A	Four-wheel drive module.
19	5 A	Adaptive cruise control.
20	15 A	Heated mirrors.
21	40 A	Heated rear window.
22	10 A	On-board diagnostic module. Smart data link connector.
23	15 A	Transmission control module.
24	30 A	Driver power seat.
25	25 A	Voltage quality module.
26	30 A	Trailer tow battery charge.
27	20 A	Rear heated seats.
28	25 A	Glow plug (diesel).
	—	Not used (gas).
29	40 A	Electric power assisted steering motor.



# Fuses

<b>Item</b>	<b>Rating</b>	<b>Protected Component</b>
30	—	Not used.
31	20 A	Power point 5.
32	25 A	Four-wheel drive module.
33	10 A	Alternator sense line 2.
34	50 A	Electric cooling fan (gas). Supplemental air heater (diesel).
35	20 A	Power point 2.
36	20 A	Power point 1.
37	60 A	Anti-lock brake system pump.
38	60 A	Inverter.
39	25 A	Four-wheel drive module.
40	30 A	Starter motor solenoid.
41	10 A	Tailgate release solenoid.
42	40 A	Blower motor.
43	10 A	Trailer tow backup lamps.
44	40 A	Trailer tow lighting module.
45	30 A	Anti-lock brake system valve.
46	30 A	Compressed natural gas module power.
47	50 A	Supplemental air heater (diesel).
	—	Not used (gas).
48	50 A	Supplemental air heater (diesel).
	—	Not used (gas).
49	—	Not used.
50	30 A	Heated and cooled seats.

# Fuses

<b>Item</b>	<b>Rating</b>	<b>Protected Component</b>
51	20 A	Powertrain control module.
52	15 A	Compressed natural gas (gas). Fuel rail pressure relief control (diesel).
53	20 A	Exhaust gas recirculation stepper motor (gas). Universal exhaust gas oxygen sensors (gas). Exhaust gas recirculation cooler bypass (diesel). Urea pump motor controller (diesel). Oxygen sensors.
54	20 A	A/C clutch relay power. Fan clutch.
55	5 A	Rain sensor.
56	30 A	Windshield wipers.
57	10 A	Upfitter interface module.
58	10 A	Alternator sense line.
59	30 A	Power running boards.
60	40 A	Body control module - battery power in feed 2.
61	10 A	Telescopic mirror motors.
62	40 A	Trailer brake control. Aftermarket e-brake access.
63	15 A	Multi-contour seats.
64	20 A	Ignition coil (gas). Glow plug module (diesel). Nitrogen oxide module (diesel). Urea level and quality sensor (diesel).
65	30 A	Fuel pump.
66	10 A	A/C clutch solenoid.

# Fuses

Item	Rating	Protected Component
67	40 A	Auxiliary lighting module.
68	10 A	Powertrain control module.
69	60 A	Body control module power.
70	30 A	Trailer tow stoplamp and turn lamps.

## BODY CONTROL MODULE FUSE BOX

### LOCATING THE BODY CONTROL MODULE FUSE BOX

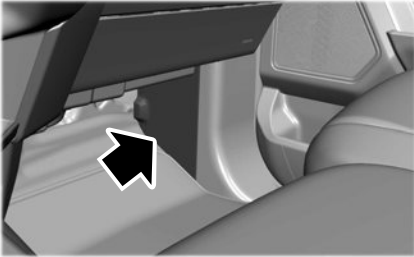

### ACCESSING THE BODY CONTROL MODULE FUSE BOX

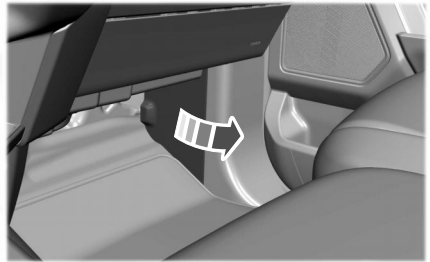

# Fuses

## IDENTIFYING THE FUSES IN THE BODY CONTROL MODULE FUSE BOX

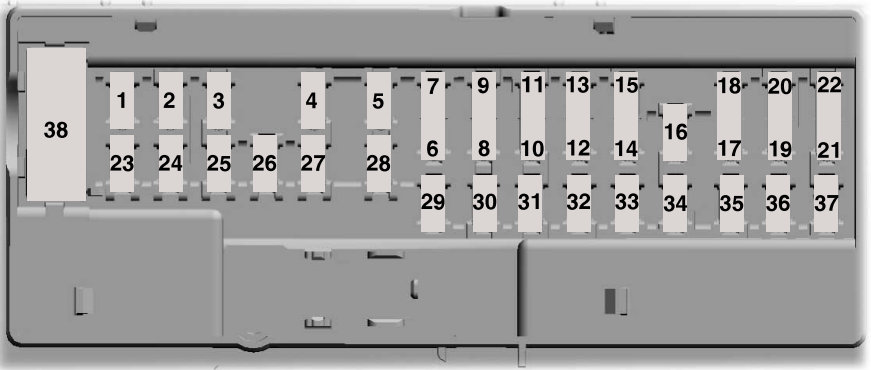

Item	Rating	Protected Component
1	—	Not used.
2	10 A	Driver door pack switch. Power sliding rear window switch.
3	7.5 A	Seat memory switch. Power lumbar motor. Wireless charging module.
4	20 A	Not used (spare).
5	—	Not used.
6	10 A	Power telescoping mirrors switch. Front power windows switch.
7	10 A	Brake on-off switch.
8	5 A	Embedded modem.
9	5 A	Combined sensor module.

## Fuses

Item	Rating	Protected Component
10	—	Not used.
11	—	Not used.
12	7.5 A	On-board diagnostic module. Smart data link connector. Climate control module.
13	7.5 A	Steering column control module. Instrument cluster.
14	15 A	Not used.
15	15 A	SYNC. Display.
16	—	Not used.
17	7.5 A	Active front steering module. Park aid module.
18	7.5 A	Selectable drive modes switch. Select shift switch.
19	5 A	Head up display.
20	5 A	Ignition switch. Key inhibit solenoid.
21	5 A	Head up display. In-vehicle temperature and humidity sensor.
22	5 A	Upfitter switches.
23	30 A	Driver front door module.
24	30 A	Moonroof.
25	20 A	Not used (spare).
26	30 A	Passenger front door module.
27	30 A	Not used (spare).
28	30 A	Amplifier.

# Fuses

Item	Rating	Protected Component
29	15 A	Adjustable pedals switch.
30	5 A	Brake on-off output to trailer brake controller and customer access circuits.
31	10 A	Remote keyless entry.
32	20 A	Radio.
33	—	Not used.
34	30 A	Run/start relay.
35	5 A	Not used (spare).
36	15 A	Camera module. Lane keeping system. Auto-dimming interior mirror. Rear heated seats.
37	20 A	Heated steering wheel.
38	30 A	Power windows.

## IDENTIFYING FUSE TYPES

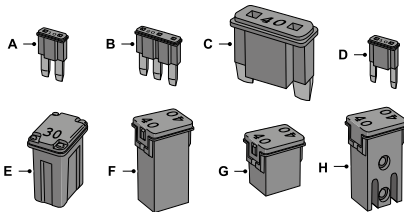

- A Micro 2.
- B Micro 3.
- C Maxi.
- D Mini.
- E M Case.

- F J Case.
- G J Case Low Profile.
- H Slotted M Case.

## FUSES – TROUBLESHOOTING

### FUSES – FREQUENTLY ASKED QUESTIONS

#### When do I need to check a fuse?

If electrical components in the vehicle are not working.

#### When do I need to replace a fuse?

If a fuse has blown.

#### How do I identify a blown fuse?

You can identify a blown fuse by a broken wire within the fuse.

# Maintenance

## MAINTENANCE PRECAUTIONS

Service your vehicle regularly to help maintain its roadworthiness and resale value. There is a large network of authorized dealers that are there to help you with their professional servicing expertise. We believe that their specially trained technicians are best qualified to service your vehicle properly and expertly. They are supported by a wide range of highly specialized tools developed specifically for servicing your vehicle.

If your vehicle requires professional service, an authorized dealer can provide the necessary parts and service. Check your warranty information to find out which parts and services are covered.

Use only recommended fuels, lubricants, fluids and service parts conforming to specifications. See **Capacities and Specifications** (page 467).

- Do not work on a hot engine.
- Make sure that nothing gets caught in moving parts.
- Do not work on a vehicle with the engine running in an enclosed space, unless you are sure you have enough ventilation.
- Keep all open flames and other burning material, such as cigarettes, away from the battery and all fuel related parts.
- Set the parking brake, shift the transmission to park (P) and block the wheels.

## OPENING AND CLOSING THE HOOD

1. Inside the vehicle, pull the hood release handle located under the left hand side of the instrument panel.



2. Go to the front of your vehicle and locate the secondary release lever under the front of the hood near the center of your vehicle.

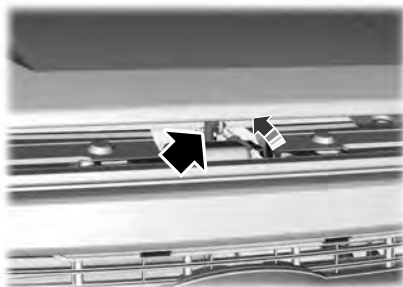

3. Raise the hood until the lift cylinders hold it open.
4. To close, lower the hood and make sure that it is closed properly and fully latched.

# Maintenance

## UNDER HOOD OVERVIEW - 6.2L

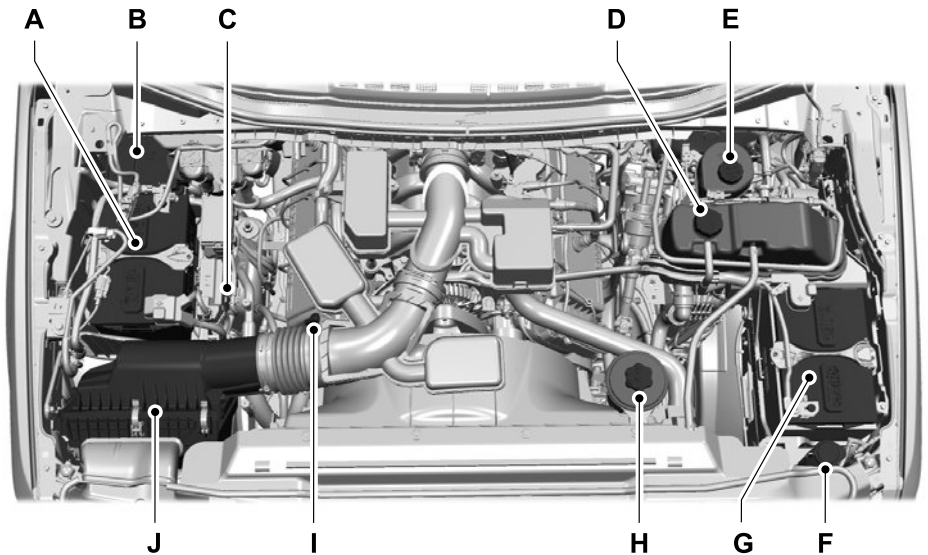

- A Battery. See **Changing the 12V Battery** (page 409).
- B Engine compartment fuse box. See **Fuse Precautions** (page 387).
- C Engine oil dipstick. See **Engine Oil Dipstick Overview** (page 400).
- D Engine coolant reservoir. See **Checking the Coolant** (page 402).
- E Brake fluid reservoir. See **Checking the Brake Fluid** (page 240).
- F Windshield washer fluid reservoir. See **Adding Washer Fluid** (page 117).
- G Battery. See **Changing the 12V Battery** (page 409).
- H Power steering fluid reservoir. See **Checking the Hydraulic Power Steering Fluid** (page 257).
- I Engine oil fill cap. See **Checking the Engine Oil Level** (page 400).
- J Air filter. See **Changing the Engine Air Filter** (page 405).



# Maintenance

## UNDER HOOD OVERVIEW - 6.7L DIESEL

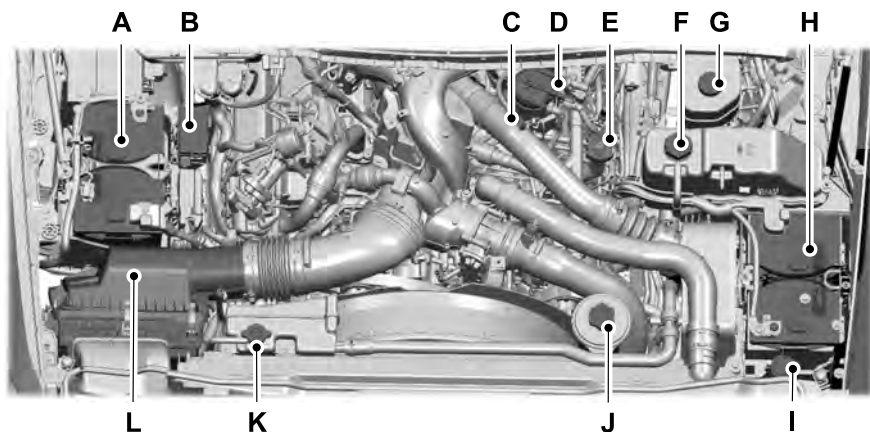

- A Battery. See **Changing the 12V Battery** (page 409).
- B Under hood fuse box. See **Accessing the Under Hood Fuse Box** (page 387).
- C Engine oil dipstick. See **Engine Oil Dipstick Overview** (page 400).
- D Secondary fuel filter.
- E Engine oil filler cap. See **Checking the Engine Oil Level** (page 400).
- F Engine cooling system coolant reservoir - primary high-temperature cooling system. See **Checking the Coolant** (page 402).
- G Brake fluid reservoir. See **Checking the Brake Fluid** (page 240).
- H Battery. See **Changing the 12V Battery** (page 409).
- I Windshield washer fluid reservoir. See **Adding Washer Fluid** (page 117).
- J Power steering fluid reservoir. See **Checking the Hydraulic Power Steering Fluid** (page 257).
- K Secondary cooling system coolant reservoir. See **Checking the Coolant** (page 402).
- L Air filter assembly. See **Changing the Engine Air Filter** (page 405).

# Maintenance

## UNDER HOOD OVERVIEW - 7.3L

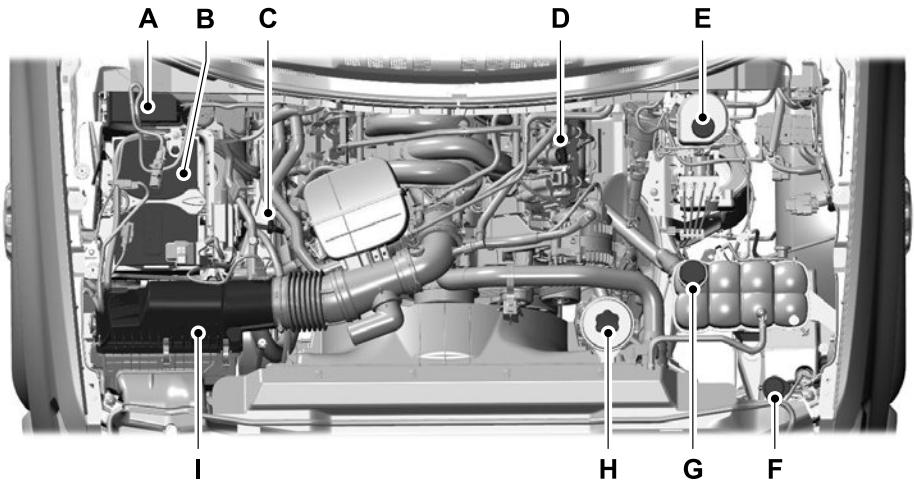

- A Under hood fuse box. See **Accessing the Under Hood Fuse Box** (page 387).
- B Battery. See **Changing the 12V Battery** (page 409).
- C Engine oil dipstick. See **Engine Oil Dipstick Overview** (page 400).
- D Engine oil filler cap. See **Adding Engine Oil** (page 401).
- E Brake fluid reservoir. See **Checking the Brake Fluid** (page 240).
- F Windshield washer fluid reservoir. See **Adding Washer Fluid** (page 117).
- G Engine coolant reservoir. See **Checking the Coolant** (page 402).
- H Power steering fluid reservoir. See **Checking the Hydraulic Power Steering Fluid** (page 257).
- I Air cleaner assembly. See **Changing the Engine Air Filter** (page 405).

# Maintenance

## ENGINE OIL

### ENGINE OIL DIPSTICK OVERVIEW - 6.2L

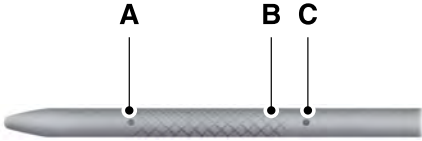

- A Minimum.
- B Nominal.
- C Maximum.

### ENGINE OIL DIPSTICK OVERVIEW - 6.7L DIESEL

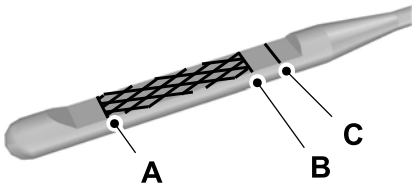

- A Minimum.
- B Nominal.
- C Maximum.

### ENGINE OIL DIPSTICK OVERVIEW - 7.3L

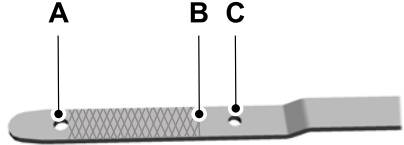

- A Minimum.
- B Nominal.
- C Maximum.

### CHECKING THE ENGINE OIL LEVEL

1. Make sure that your vehicle is on level ground.
2. Check the oil level before starting the engine, or switch the engine off after warming up and wait 10 minutes for the oil to drain into the oil pan.
3. Remove the dipstick and wipe it with a clean, lint-free cloth.
4. Reinstall the dipstick and make sure it is fully seated.
5. Remove the dipstick again to check the oil level.

**Note:** *If the oil level is between the maximum and minimum marks, the oil level is acceptable. Do not add oil.*

6. If the oil level is at the minimum mark, immediately add oil.
7. Reinstall the dipstick. Make sure it is fully seated.

# Maintenance

**Note:** The oil consumption of new engines reaches its normal level after approximately 3,000 mi (5,000 km).

## ADDING ENGINE OIL



**WARNING:** Do not remove the filler cap when the engine is running.



**WARNING:** Do not add engine oil when the engine is hot. Failure to follow this instruction could result in personal injury.

Do not use supplemental engine oil additives because they are unnecessary and could lead to engine damage that the vehicle warranty may not cover.

1. Clean the area surrounding the engine oil filler cap before you remove it.
2. Remove the engine oil filler cap.
3. Add engine oil that meets our specifications. See **Engine Oil** (page 401).
4. Reinstall the engine oil filler cap. Turn it clockwise until you feel a strong resistance.

**Note:** Do not add oil further than the maximum mark. Oil levels above the maximum mark may cause engine damage.

**Note:** Immediately soak up any oil spillage with an absorbent cloth.

## RESETTING THE ENGINE OIL CHANGE REMINDER - VEHICLES WITH: 2.3 INCH SCREEN/4.2 INCH SCREEN

1. Press the Menu button on the steering wheel to enter the information display main menu.
2. Select **Truck Info**.
3. Select **Oil Life**.

4. Select **Reset Oil Life**.
5. Press and hold the **OK** button until the system reset confirmation appears.

## RESETTING THE ENGINE OIL CHANGE REMINDER - VEHICLES WITH: 8 INCH SCREEN

Depending on your cluster, there are two paths to reset the engine oil change reminder.

### Path 1

1. Press the Menu button on the steering wheel to enter the information display main menu.
2. Select **Settings**.
3. Select **Vehicle Maintenance**.
4. Select **Oil Life**.
5. Press and hold the **OK** button until the system reset confirmation appears.

### Path 2

1. Press the Menu button on the steering wheel to enter the information display main menu.
2. Select **Truck Info**.
3. Select **Engine Information**.
4. Press and hold the **OK** button until the system reset confirmation appears.

## ENGINE OIL CAPACITY AND SPECIFICATION

For filling information, please refer to the Capacities and Specifications section of your owner's manual. See **Engine Oil Capacity and Specification** (page 401).

# Maintenance

## CHECKING THE COOLANT

When the engine is cold, check the concentration and level of the coolant at the intervals listed in the scheduled maintenance information. See **Scheduled Maintenance** (page 622).

**Note:** Make sure that the coolant level is between the minimum and maximum marks on the coolant reservoir.

**Note:** Coolant expands when it is hot. The level may extend beyond the **MAX** mark.

If the coolant level is at or below the minimum mark, add prediluted coolant immediately.

Maintain coolant concentration within 48% to 50%, which equates to a freeze point between -29°F (-34°C) and -35°F (-37°C). Coolant concentration should be checked using a refractometer. We do not recommend the use of hydrometers or coolant test strips for measuring coolant concentration.

## Adding Coolant



**WARNING:** Do not remove the coolant reservoir cap when the engine is on or the cooling system is hot. Wait 10 minutes for the cooling system to cool down. Cover the coolant reservoir cap with a thick cloth to prevent the possibility of scalding and slowly remove the cap. Failure to follow this instruction could result in personal injury.



**WARNING:** Do not add engine coolant when the engine is on or the cooling system is hot. Failure to follow this instruction could result in personal injury.



**WARNING:** Do not add coolant further than the **MAX** mark.



**WARNING:** Do not put coolant in the windshield washer reservoir. If sprayed on the windshield, coolant could make it difficult to see through the windshield.

**Note:** Do not use stop leak pellets, cooling system sealants, or non-specified additives as they can cause damage to the engine cooling or heating systems. Resulting component damage may not be covered by the vehicle Warranty.

**Note:** Automotive fluids are not interchangeable.

It is very important to use prediluted coolant approved to the correct specification in order to avoid plugging the small passageways in the engine cooling system. See **Capacities and Specifications** (page 467). Do not mix different colors or types of coolant in your vehicle. Mixing of engine coolants or using an incorrect coolant may harm the engine or cooling system components and could void the vehicle Warranty.

**Note:** If prediluted coolant is not available, use the approved concentrated coolant diluting it to 50/50 with deionized or distilled water. See **Capacities and Specifications** (page 467). Using water that has not been deionized may contribute to deposit formation, corrosion and plugging of the small cooling system passageways.

To top up the coolant level do the following:

1. Unscrew the cap slowly. Any pressure escapes as you unscrew the cap.
2. Add enough prediluted coolant to reach the correct level.

**Note:** We do not recommend the use of recycled coolant.

# Maintenance

3. Replace the coolant reservoir cap. Turn the cap clockwise until it contacts the hard stop.
4. Check the coolant level in the coolant reservoir the next few times you drive your vehicle. If necessary, repeat step 2.

If you have to add more than 1.1 qt (1 L) of engine coolant per month, have your vehicle checked as soon as possible. Operating an engine with a low level of coolant can result in engine overheating and possible engine damage.

In case of emergency, you can add a large amount of water without engine coolant in order to reach a vehicle service location. Service your vehicle as soon as possible.

Water alone, without engine coolant, can cause engine damage from corrosion, overheating or freezing.

Do not use the following as a coolant substitute, as they can cause engine damage from overheating or freezing:

- Alcohol.
- Methanol.
- Brine.
- Any coolant mixed with alcohol or methanol antifreeze.

Do not add extra inhibitors or additives to the coolant. These can be harmful and compromise the corrosion protection of the coolant.

## Severe Climates

If you drive in extremely cold climates, you may need to increase the coolant concentration above 50%.

**Note:** *A coolant concentration of 60% provides improved freeze point protection. Coolant concentrations above 60% decrease the overheat protection characteristics of the coolant and could cause engine damage.*

If you drive in extremely hot climates, you may need to decrease the coolant concentration to 40%.

**Note:** *A coolant concentration of 40% provides improved overheat protection. Coolant concentrations below 40% decrease the overheat and corrosion protection characteristics of the coolant and could cause engine damage.*

## Coolant Change

Change the coolant at specific mileage intervals. Refer to the scheduled maintenance information. See **Normal Scheduled Maintenance** (page 628).

**Note:** *Dispose of used coolant in the appropriate manner.*

Follow your community's regulations and standards for recycling and disposing of automotive fluids.

## Fail-Safe Cooling

Fail-safe cooling allows you to temporarily drive your vehicle before any incremental component damage occurs. The fail-safe distance depends on ambient temperature, vehicle load and terrain.

### How Fail-Safe Cooling Works



If the engine begins to overheat, the coolant temperature gauge moves toward the red zone:



A warning lamp illuminates and a message may appear in the information display.

If the engine reaches a preset over-temperature condition, the engine automatically switches to alternating cylinder operation. Each disabled cylinder acts as an air pump and cools the engine.

# Maintenance

When this occurs, your vehicle still operates, however:

- Engine power is limited.
- The air conditioning system turns off.

Continued operation increases the engine temperature, causing the engine to completely shut down. Your steering and braking effort increases in this situation.

When the engine temperature cools, you can re-start the engine. Have your vehicle checked as soon as possible to minimize engine damage.

## When Fail-Safe Mode Is Activated



**WARNING:** Fail-safe mode is for use during emergencies only. Operate your vehicle in fail-safe mode only as long as necessary to bring your vehicle to rest in a safe location and seek immediate repairs. When in fail-safe mode, your vehicle will have limited power, will not be able to maintain high-speed operation, and may completely shut down without warning, potentially losing engine power, power steering assist, and power brake assist, which may increase the possibility of a crash resulting in serious injury.



**WARNING:** Do not remove the coolant reservoir cap when the engine is on or the cooling system is hot. Wait 10 minutes for the cooling system to cool down. Cover the coolant reservoir cap with a thick cloth to prevent the possibility of scalding and slowly remove the cap. Failure to follow this instruction could result in personal injury.

Your vehicle has limited engine power when in the fail-safe mode, drive your vehicle with caution. Your vehicle does not maintain high-speed operation and the engine could operate poorly.

Remember that the engine is capable of automatically shutting down to prevent engine damage. In this situation:

1. Pull off the road as soon as safely possible and switch the engine off.
2. If you are a member of a roadside assistance program, we recommend that you contact your roadside assistance service provider.
3. If this is not possible, wait for a short period of time for the engine to cool.
4. Check the coolant level. If the coolant level is at or below the minimum mark, add prediluted coolant immediately.
5. When the engine temperature cools, you can re-start the engine. Have your vehicle checked as soon as possible to minimize engine damage.

**Note:** *Driving your vehicle without repair increases the chance of engine damage.*

## Engine Coolant Temperature Management (If Equipped)



**WARNING:** To reduce the risk of crash and injury, be prepared that the vehicle speed may reduce and the vehicle may not be able to accelerate with full power until the coolant temperature reduces.

If you tow a trailer with your vehicle, the engine may temporarily reach a higher temperature during severe operating conditions, for example ascending a long or steep grade in high ambient temperatures.

At this time, you may notice the coolant temperature gauge moves toward the red zone and a message may appear in the information display.

# Maintenance

You may notice a reduction in vehicle speed caused by reduced engine power in order to manage the engine coolant temperature. Your vehicle may enter this mode if certain high-temperature and high-load conditions take place. The amount of speed reduction depends on vehicle loading, grade and ambient temperature. If this occurs, there is no need to stop your vehicle. You can continue to drive.

The air conditioning may automatically turn on and off during severe operating conditions to protect the engine from overheating. When the coolant temperature decreases to the normal operating temperature, the air conditioning turns on.

If the coolant temperature gauge moves fully into the red zone, or if the coolant temperature warning or service engine soon messages appear in your information display, do the following:

1. Stop your vehicle as soon as it is safe to do so. Fully apply the parking brake, shift into park (P) or neutral (N).
2. Leave the engine running until the coolant temperature gauge needle returns to the normal position. If the temperature does not drop after several minutes, follow the remaining steps.
3. Switch the engine off and wait for it to cool. Check the coolant level.
4. If the coolant level is at or below the minimum mark, add prediluted coolant immediately.
5. If the coolant level is normal, restart the engine and continue.

## ENGINE AIR FILTER

### CHANGING THE ENGINE AIR FILTER

 **WARNING:** To reduce the risk of vehicle damage and personal burn injuries, do not start your engine with the air cleaner removed and do not remove it while the engine is running.

Use the correct specification air filter element. See **Motorcraft Parts** (page 469).

**Note:** *Failure to use the correct air filter element may result in severe engine damage. Resulting component damage may not be covered by the vehicle Warranty.*

Change the air filter element at the correct service interval. See **Scheduled Maintenance** (page 622).

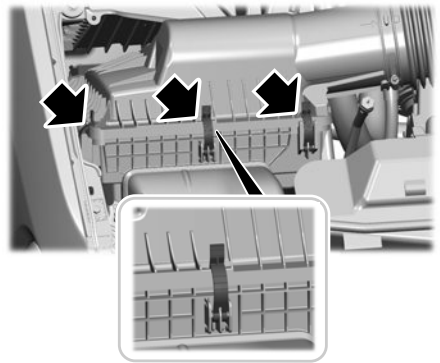

1. Disconnect the mass air flow sensor electrical connector, if required.



# Maintenance

- Remove the clips (x3) that secure the air filter housing cover. Remove the air filter housing cover. Disconnect and pull the air intake tube away, as needed.

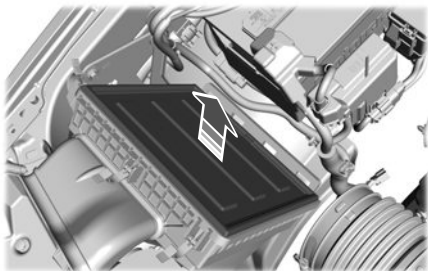

- Remove the air filter element from the air filter housing.
- Remove the auxiliary foam filter from the air filter housing, if required.

- To install, reverse the removal procedure. You can oscillate the housing cover slightly left to right to assist with installation as needed, until positioned such that all three clips can be re-engaged.

After operating your vehicle during heavy snowfall or extreme rain, do the following:

- Snow:** At the earliest opportunity, open the hood, clear any snow and ice from the air filter housing inlet and reset the air filter restriction gauge.
- Extreme rain:** The air filter element dries out after approximately 15–30 minutes of driving at highway speeds. At the earliest opportunity, open the hood and reset the air filter restriction gauge.

**Note:** Do not remove the foam filter.

## ENGINE AIR FILTER - INFORMATION MESSAGES

Message	Action
Filter OK	Indicates the engine air filter is performing as expected.
Check Filter See Manual	Indicates that there is a higher than expected restriction across the engine air filter, which could represent an air filter at full useful life or a filter with an obstruction. When this displays, inspect the engine air filter and replace if necessary. After the inspection or engine air filter replacement, you must reset the system in order to change the status from Check Filter to Filter OK.
System Fault See Manual	Indicates that there is an error within the electronic air filter maintenance minder system requiring service.

# Maintenance

## DRAINING THE FUEL FILTER WATER TRAP - DIESEL



**WARNING:** Do not drain the water-in-fuel separator while the engine is running. Failure to follow this warning may result in fire, serious injury, death or property damage.



**WARNING:** Do not dispose of fuel in the household refuse or the public sewage system. Use an authorized waste disposal facility.

Your vehicle has a diesel fuel conditioner module. The module is mounted between the outboard side of the fuel tank and the frame rail.

**Note:** The module is at the front of the fuel tank or at the front of the aft-axle fuel tank on some models.



You should drain water from the module assembly whenever the warning light illuminates or a message appears in the information display advising you to drain the water separator. This occurs when approximately 6.76 fl oz (200 ml) of water accumulates in the module. If you allow the water level to exceed this level, the water may pass through to the engine and may cause fuel injection equipment damage.

### Filter Location

Use the tables below to find the location of your filter.

#### Pick-up Truck

Cab Type	Box Length	Filter Location
Regular.	8 ft (2.4 m)	Left side of fuel tank.
SuperCab.	6.75 ft (2.057 m)	
	8 ft (2.4 m)	In front of fuel tank.
Super Crew Cab.	6.75 ft (2.057 m)	
	8 ft (2.4 m)	Left side of fuel tank.

#### Chassis Cab

Cab Type	Fuel Tank Type	Filter Location
Chassis Cab.	Single midship fuel tank	Right side of fuel tank.
Chassis Cab.	Aft axle/midship fuel tanks	Right side of midship fuel tank.
Chassis Cab.	Single aft axle fuel tank	Front of fuel tank.

# Maintenance

## Draining the Diesel Fuel Conditioner Module

1. Switch the engine off.
2. Access the underside of your vehicle.

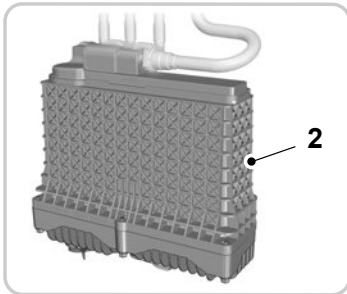
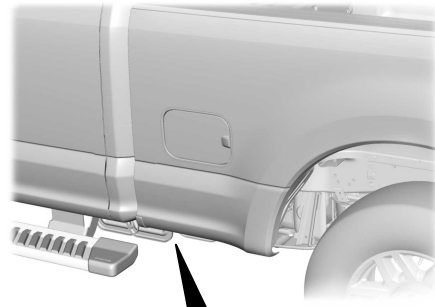

3. Use the table to find the location of your fuel filter.

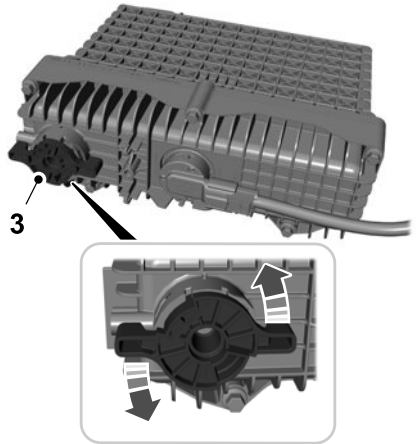

4. Drain the diesel fuel conditioner module. Turn the drain plug counterclockwise until it stops. Do not use any tools to loosen the drain plug. Drain the filter, approximately 0.5 gal (2 L), into an appropriate container. Do not re-use the fuel drained from the module.
5. Tighten the drain plug, turn it clockwise until it stops and you feel a strong resistance. Do not use any tools to tighten the drain plug.
6. Prime the system by turning the key to the on position for 30 seconds. Turn the key to the off position, then the on position again for another 30 seconds. Repeat this twice.

## CHANGING THE FUEL FILTER - DIESEL

Your fuel filters must be changed at the correct service interval or when you see the low fuel pressure message appear. Refer to scheduled maintenance for the correct service interval.

# Maintenance

## CHANGING THE FUEL FILTER - GASOLINE

Your vehicle has a lifetime fuel filter that integrates with the fuel tank. It does not need regular maintenance or replacement.

## CHANGING THE 12V BATTERY



**WARNING:** Batteries normally produce explosive gases which can cause personal injury. Therefore, do not allow flames, sparks or lighted substances to come near the battery. When working near the battery, always shield your face and protect your eyes. Always provide correct ventilation.



**WARNING:** When lifting a plastic-cased battery, excessive pressure on the end walls could cause acid to flow through the vent caps, resulting in personal injury and damage to the vehicle or battery. Lift the battery with a battery carrier or with your hands on opposite corners.



**WARNING:** Keep batteries out of reach of children. Batteries contain sulfuric acid. Avoid contact with skin, eyes or clothing. Shield your eyes when working near the battery to protect against possible splashing of acid solution. In case of acid contact with skin or eyes, flush immediately with water for a minimum of 15 minutes and get prompt medical attention. If acid is swallowed, call a physician immediately.



**WARNING:** Battery posts, terminals and related accessories contain lead and lead compounds, chemicals known to the State of California to cause cancer and reproductive harm. **Wash your hands after handling.**



**WARNING:** This vehicle may have more than one battery. Removing the battery cables from only one battery does not disconnect your vehicle electrical system. Make sure you disconnect the battery cables from all batteries when disconnecting power. Failure to do so may cause serious personal injury or property damage.

The battery is in the engine compartment. See **Under Hood Overview** (page 397).

Your vehicle has a maintenance-free battery. It does not require additional water during service.

For longer, trouble-free operation, keep the top of the battery clean and dry and the battery cables tightly fastened to the battery terminals. If any corrosion is present on the battery or terminals, remove the cables from the terminals and clean with a wire brush. You can neutralize the acid with a solution of baking soda and water.

We recommend that you disconnect the negative battery cable terminal from the battery if you plan to store your vehicle for an extended period.

**Note:** *If you only disconnect the negative battery cable terminal, make sure it is isolated or placed away from the battery terminal to avoid unintended connection or arcing.*

# Maintenance

To maintain correct operation of the battery management system, if you add any electrical devices to your vehicle, do not connect the ground connection directly to the negative battery terminal. A connection at the negative battery terminal can cause inaccurate measurements of the battery condition and potential incorrect system operation.

**Note:** *If you add electrical accessories or components to your vehicle this may adversely affect battery performance, durability and the performance of other electrical systems on your vehicle.*

If you replace the battery make sure it matches the electrical requirements of your vehicle.

If you disconnect or replace the battery and your vehicle has an automatic transmission, it must relearn its adaptive strategy. Because of this, the transmission may shift firmly when first driven. This is normal operation while the transmission fully updates its operation to optimum shift feel.

## Remove and Reinstall the Battery

To disconnect or remove the battery, do the following:

1. Apply the parking brake and switch the ignition off.
2. Switch all electrical equipment off, for example lights and radio.
3. Wait a minimum of two minutes before disconnecting the battery.

**Note:** *The engine management system has a power hold function and remains powered for a period of time after you switch the ignition off. This is to allow diagnostic and adaptive tables to be stored. Disconnecting the battery without waiting can cause damage not covered by the vehicle Warranty.*

4. Disconnect the negative battery cable terminal.
5. Disconnect the positive battery cable terminal.
6. Remove the battery securing clamp.
7. Remove the battery.
8. To install, reverse the removal procedure.

**Note:** *Before reconnecting the battery, make sure the ignition remains switched off.*

**Note:** *Make sure the battery cable terminals are fully tightened.*

**Note:** *After cleaning or replacing the battery, make sure you reinstall the battery cover or shield.*

If you disconnect or replace the vehicle battery, you must reset the following features:

- Window bounce-back. See **Window Bounce-Back** (page 126).
- Clock Settings.
- Pre-set radio stations.
- Steering Angle Sensor.

**Note:** *To calibrate the steering angle sensor, drive the vehicle above 30 mph (50 km/h) for a minimum of 1.2 mi (2 km). Make sure to drive straight ahead for a minimum of 30 seconds. Several vehicle functions are disabled and a warning light could appear until the sensor is calibrated.*

## Battery Management System

The battery management system monitors battery conditions and takes actions to extend battery life. If excessive battery drain is detected, the system temporarily disables some of the following features:

- Heated rear window.
- Heated seats.
- Climate control.
- Heated steering wheel.

# Maintenance

- Audio unit.
- Navigation system.

A message may appear in the information display to alert you that battery protection actions are active.

After battery replacement, or in some cases after charging the battery with an external charger, the battery management system requires eight hours of vehicle sleep time to relearn the battery state of charge. During this time your vehicle must remain fully locked with the ignition off.

**Note:** *If you add electrical accessories or components to the vehicle, it may adversely affect battery performance and durability. This may also affect the performance of other electrical systems in the vehicle.*

## Battery Disposal



Make sure that you dispose of old batteries in an environmentally friendly way. Seek advice from your local authority about recycling old batteries.

## ADJUSTING THE HEADLAMPS

### Vertical Aim Adjustment

The headlamps on your vehicle are properly aimed at the assembly plant. If your vehicle has been in an accident, have your vehicle checked as soon as possible.

### Headlamp Aiming Target

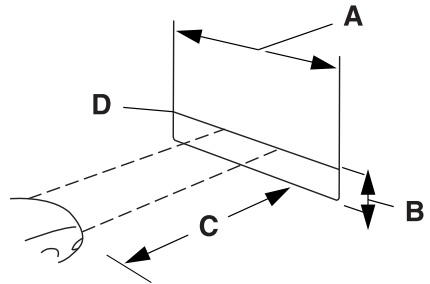

- A 8 ft (2.4 m).
- B Center height of lamp to ground.
- C 25 ft (7.6 m).
- D Horizontal reference line.

1. Park your vehicle directly in front of a wall or screen on a level surface, approximately 25 ft (7.6 m) away.
2. Measure the height from the center of your headlamp, indicated by a 3 millimeter circle on the lens, to the ground and mark an 8 ft (2.4 m) horizontal reference line on the vertical wall or screen at this height, a piece of masking tape works well.
3. Switch on the low beam headlamps to illuminate the wall or screen and open the hood. Cover one of the headlamps so no light hits the wall.

# Maintenance



4. On the wall or screen, observe a light pattern with a distinct horizontal edge toward the right. If this edge is not at the horizontal reference line, adjust the beam so the edge is at the same height as the horizontal reference line.

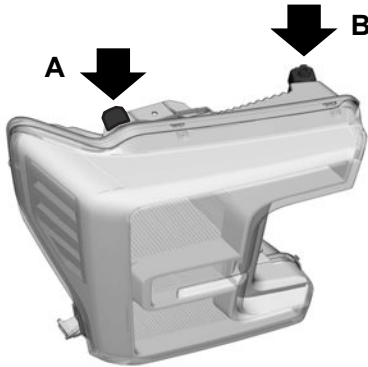

5. Locate the vertical adjuster on each headlamp. Using a Phillips #2 screwdriver, turn the adjuster either clockwise or counterclockwise in order to adjust the vertical aim of the headlamp.

**Note:** A. LED headlamp.

B. Halogen headlamp.

6. Repeat steps 3 thru 5 to adjust the other headlamp.  
7. Close the hood and turn off the lamps.

## Horizontal Aim Adjustment

Horizontal aim is not required for this vehicle and is not adjustable.

## EXTERIOR BULBS

### EXTERIOR BULB SPECIFICATION CHART

Replacement bulbs are specified in the chart below. Headlamp bulbs must be marked with an authorized D.O.T. marking for North America to make sure they have the proper lamp performance, light brightness, light pattern and safe visibility. The correct bulbs will not damage the lamp assembly or void the lamp assembly warranty and will provide quality bulb illumination time.

Lamp	Specification	Power (Watt)
Headlamp.	H13/9008	60/55
Headlamp.	LED	LED
Front side marker lamp.	W5W	5
Front fog lamp.	9140	40
Front fog lamp. <sup>3</sup>	LED	LED

# Maintenance

Lamp	Specification	Power (Watt)
Front turn signal and parking lamp.	T20/7444NA	28/8
Rear lamp, brake lamp, and rear side marker lamp. Low/Mid series. <sup>1</sup>	3157K	27/7
Rear turn signal lamp. Low/Mid series. <sup>1</sup>	WTY21W	21
Rear lamp, brake lamp, rear turn signal, rear side marker lamp and reverse lamp. High series. <sup>1</sup>	LED	LED
Rear lamp, brake lamp, rear turn signal and rear side marker lamp. <sup>2</sup>	3157K	27/7
Reversing lamp. Low/Mid series.	WT21W	21
License plate lamp. Low series.	168	5
License plate lamp. High series.	LED	LED
Central high mounted cargo lamp.	912	12.8
Central high mounted cargo lamp.	LED	LED
Side turn signal and mirror clearance lamp.	LED	LED
Front clearance lamp.	LED	LED
Rear clearance lamp.	LED	LED
Front identification lamp.	LED	LED
Rear identification lamp.	LED	LED
Underhood lamp.	LED	LED

<sup>1</sup>Pickup only.

<sup>2</sup>Chassis cab only.

<sup>3</sup>U.S. and Canada only

**Note:** LED lamps are not serviceable. See an authorized dealer if they fail.



# Maintenance

## REMOVING A REAR LAMP ASSEMBLY - VEHICLES WITHOUT: PICKUP BED



1. Switch all of the lamps and the ignition off.
2. Remove the screws and the lamp lens from lamp assembly.
3. To install, reverse the removal procedure.

## REMOVING A REAR LAMP ASSEMBLY - VEHICLES WITH: PICKUP BED

1. Make sure the headlamps are off.
2. Open the tailgate to access the rear lamp assemblies.

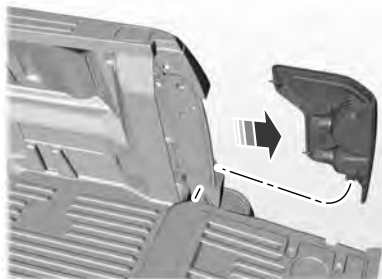

3. Remove the bolts from the tail lamp assembly.

4. Carefully pull the lamp assembly from the tailgate pillar by releasing the two retaining tabs.
5. To install, reverse the removal procedure.

## CHANGING A HEADLAMP BULB



**WARNING:** Make sure the bulbs have cooled down before removing them. Failure to follow this warning could result in serious personal injury.

**Note:** To access the right-hand side bulbs, remove the air intake pipe. See **Changing the Engine Air Filter** (page 405).

For vehicles with diesel engines, to access the left-hand side bulbs, remove the washer reservoir filler tube.

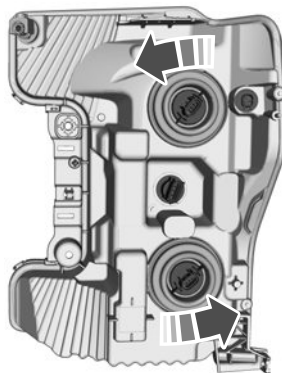

1. Switch all of the lamps and the ignition off.
2. Disconnect the electrical connector.
3. Turn the bulb holder counterclockwise and remove it.

**Note:** You cannot separate the bulb from the bulb holder.

# Maintenance

- To install, reverse the removal procedure.

**Note:** Handle a halogen headlamp bulb carefully and keep out of children's reach. Grasp the bulb only by its plastic base and do not touch the glass. The oil from your hand could cause the bulb to break the next time you operate the headlamps.

## CHANGING A FRONT TURN SIGNAL LAMP BULB



**WARNING:** Make sure the bulbs have cooled down before removing them. Failure to follow this warning could result in serious personal injury.

**Note:** To access the right-hand side bulbs, remove the air intake pipe. See **Changing the Engine Air Filter** (page 405).

To access the left-hand side bulbs, remove the washer reservoir filler tube. Vehicles with diesel engine only.

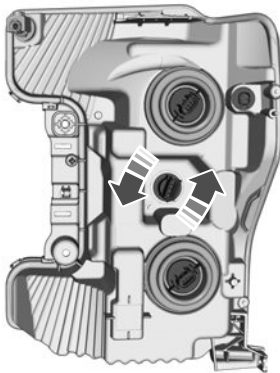

- Switch all of the lamps and the ignition off.
- Disconnect the electrical connector.
- Turn the bulb holder counterclockwise and remove it.

**Note:** You cannot separate the bulb from the bulb holder.

- To install, reverse the removal procedure.

## CHANGING A FRONT FOG LAMP BULB

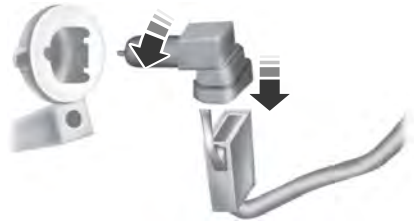

- Make sure the fog lamps are off.
- Disconnect the electrical connector from the fog lamp bulb.
- Turn the bulb counterclockwise and remove it from the fog lamp.
- To install, reverse the removal procedure.

# Maintenance

## CHANGING A REAR LAMP BULB

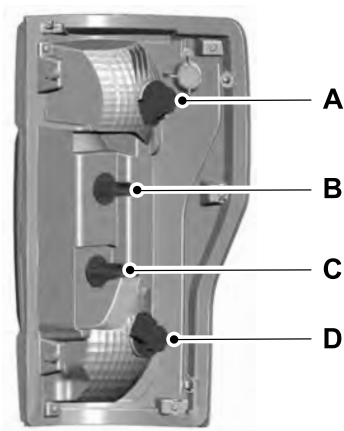

- A Stoplamp and rear lamp bulb.
- B Turn signal lamp bulb.
- C Reversing lamp bulb.
- D Stoplamp and rear lamp bulb.

1. Remove the rear lamp assembly. See **Removing a Rear Lamp Assembly** (page 414).
2. Turn the bulb holder counterclockwise and remove it.
3. Remove the bulb by pulling it straight out.
4. To install, reverse the removal procedure.

## CHANGING A STOPLAMP BULB

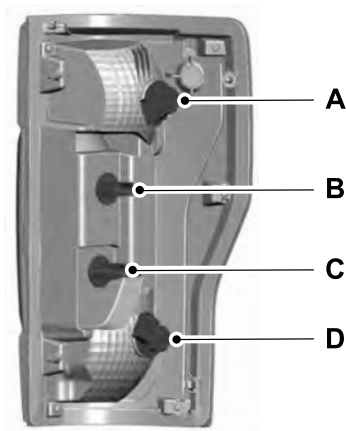

- A Stoplamp and rear lamp bulb.
- B Turn signal lamp bulb.
- C Reversing lamp bulb.
- D Stoplamp and rear lamp bulb.

1. Remove the rear lamp assembly. See **Removing a Rear Lamp Assembly** (page 414).
2. Turn the bulb holder counterclockwise and remove it.
3. Remove the bulb by pulling it straight out.
4. To install, reverse the removal procedure.

# Maintenance

## CHANGING A REAR TURN SIGNAL LAMP BULB

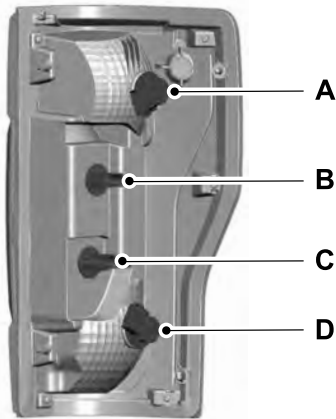

- A Stoplamp and rear lamp bulb.
- B Turn signal lamp bulb.
- C Reversing lamp bulb.
- D Stoplamp and rear lamp bulb.

1. Remove the rear lamp assembly. See **Removing a Rear Lamp Assembly** (page 414).
2. Turn the bulb holder counterclockwise and remove it.
3. Remove the bulb by pulling it straight out.
4. To install, reverse the removal procedure.

## CHANGING A REVERSING LAMP BULB - VEHICLES WITHOUT: BLIND SPOT INFORMATION SYSTEM

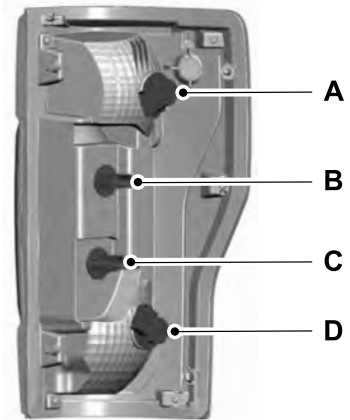

- A Stoplamp and rear lamp bulb.
- B Turn signal lamp bulb.
- C Reversing lamp bulb.
- D Stoplamp and rear lamp bulb.

1. Remove the rear lamp assembly. See **Removing a Rear Lamp Assembly** (page 414).
2. Turn the bulb holder counterclockwise and remove it.
3. Remove the bulb by pulling it straight out.
4. To install, reverse the removal procedure.

# Maintenance

## CHANGING A REVERSING LAMP BULB - VEHICLES WITH: BLIND SPOT INFORMATION SYSTEM

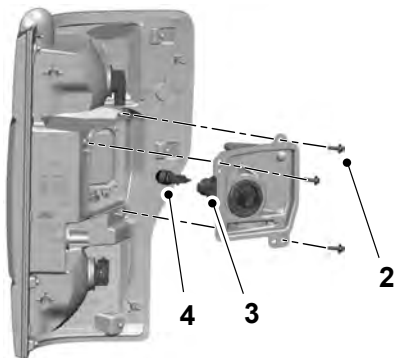

1. Remove the rear lamp assembly. See **Removing a Rear Lamp Assembly** (page 414).
2. Remove the screws from the blind spot information system module cover.
3. Turn the bulb holder counterclockwise and remove it.
4. Remove the bulb by pulling it straight out.
5. To install, reverse the removal procedure.

## CHANGING A HIGH MOUNTED STOPLAMP BULB

1. Make sure the lamps are off.
2. Remove the four screws and move the lamp assembly away from the vehicle to expose the bulb sockets.



3. Remove the bulb socket by rotating it counterclockwise and pulling it out of the lamp assembly.
4. Pull the bulb straight out of the socket.
5. To install, reverse the removal procedure.

## CHANGING A LICENSE PLATE LAMP BULB

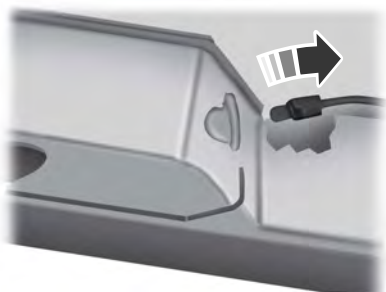

1. Switch all of the lamps and the ignition off.
2. To access the bulb, reach behind the bumper.
3. Turn the bulb holder counterclockwise and remove it.
4. Remove the bulb by pulling it straight out.

# Maintenance

5. To install, reverse the removal procedure.

## INTERIOR BULBS

### INTERIOR BULB SPECIFICATION CHART

Your vehicle has LED lamps. These are not serviceable items. See an authorized dealer if they fail.

## DRIVE BELT ROUTING - 6.2L

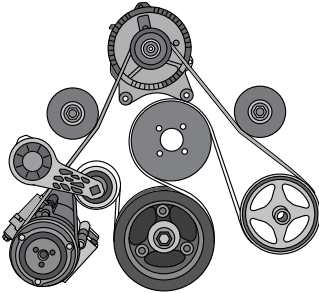

## DRIVE BELT ROUTING - 6.7L DIESEL, VEHICLES WITH: DUAL GENERATORS

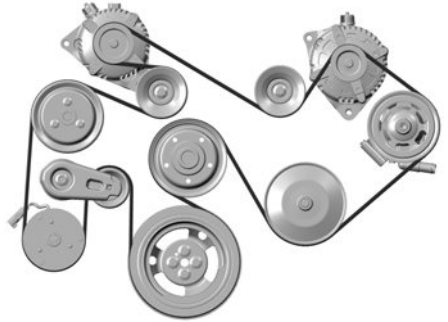

## DRIVE BELT ROUTING - 6.7L DIESEL, VEHICLES WITH: SINGLE GENERATOR

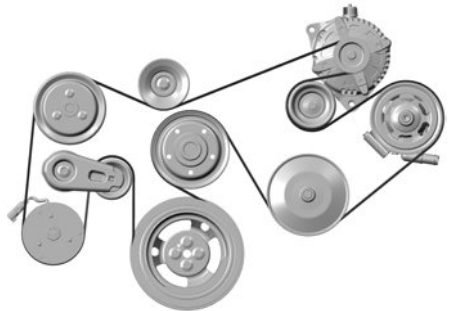

# Maintenance

---

## DRIVE BELT ROUTING - 7.3L, VEHICLES WITH: DUAL GENERATORS

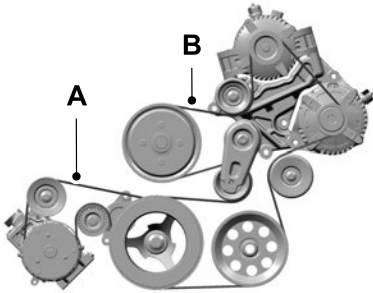

- A Drivebelt closest to the engine.
- B Drivebelt furthest from the engine.

## DRIVE BELT ROUTING - 7.3L, VEHICLES WITH: SINGLE GENERATOR

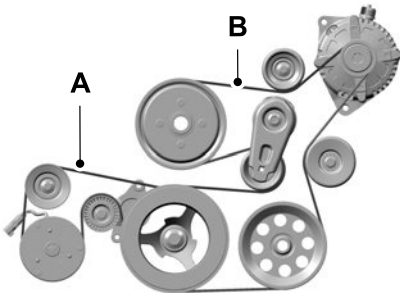

- A Drivebelt closest to the engine.
- B Drivebelt furthest from the engine.

# Vehicle Care

## CLEANING PRODUCTS

### Materials

For best results, use the following products

or products of equivalent quality:

For additional information and assistance, we recommend that you contact an authorized dealer.

Name	Specification
Motorcraft® Bug and Tar Remover, ZC-42 (U.S. & Canada)	
Motorcraft® Custom Bright Metal Cleaner, ZC-15 (U.S. & Canada)	ESR-M5B194-B
Motorcraft® Detail Wash, ZC-3-A (U.S. & Canada)	ESR-M14P4-A
Motorcraft® Engine Shampoo and Degreaser, ZC-20 (U.S.)	ESR-M14P3-A
Motorcraft® Engine Shampoo, CXC-66-A (Canada)	
Motorcraft® Premium Leather and Vinyl Cleaner, ZC-56 (U.S. & Canada)	
Motorcraft® Multi-Purpose Cleaner, CXC-101 (Canada)	
Motorcraft® Premium Windshield Wash Concentrate with Bitterant, ZC-32-B2 (U.S.)	WSS-M14P19-A
Motorcraft® Premium Quality Windshield Washer Fluid, CXC-37-F/M (Canada)	WSS-M14P19-A
Motorcraft® Professional Strength Carpet & Upholstery Cleaner, ZC-54 (U.S. & Canada)	
Motorcraft® Premium Glass Cleaner, CXC-100 (Canada)	ESR-M14P5-A
Motorcraft® Spot and Stain Remover, ZC-14 (U.S.)	
Motorcraft® Ultra-Clear Spray Glass Cleaner, ZC-23 (U.S.)	ESR-M14P5-A
Motorcraft® Wheel and Tire Cleaner, ZC-37-A (U.S. & Canada)	

## CLEANING THE EXTERIOR

Remove any exterior accessories, for example antennas, before entering a car wash.

### CLEANING THE EXTERIOR PRECAUTIONS

Immediately remove fuel spillages, AdBlue residuals, bird droppings, insect deposits and road tar. These may cause damage to your vehicle's paintwork or trim over time.

### CLEANING HEADLAMPS AND REAR LAMPS

We recommend that you only use cold or lukewarm water containing car shampoo to clean the headlamps and the rear lamps.



# Vehicle Care

---

Do not scrape the lamps.

Do not wipe lamps when they are dry.

## CLEANING WINDOWS AND WIPER BLADES

To clean the windshield and wiper blades:

- Clean the windshield with a non-abrasive glass cleaner.

**Note:** *When cleaning the interior of the windshield, avoid getting any glass cleaner on the instrument panel or door panels. Wipe any glass cleaner off these surfaces immediately.*

- Clean the wiper blades with washer fluid or water applied with a soft sponge or cloth.

**Note:** *Do not use razor blades or other sharp objects to clean or remove decals from the inside of the heated rear window. This can cause damage not covered by the vehicle Warranty.*

## CLEANING CHROME, ALUMINIUM OR STAINLESS STEEL

We recommend that you only use a car shampoo, a soft cloth and water on bumpers and other chrome, aluminium or stainless steel parts.

**Note:** *For additional information and assistance, we recommend that you contact an authorized dealer.*

**Note:** *Rinse the area well after cleaning.*

**Note:** *Do not use abrasive materials, for example steel wool or plastic pads, as they can scratch these surfaces.*

**Note:** *Do not use chrome cleaner, metal cleaner or polish on wheels or wheel covers.*

## CLEANING WHEELS

Only use a recommended wheel and tire cleaner to clean the wheels weekly. For additional information and assistance, we recommend that you contact an authorized dealer.

1. Use a sponge to remove heavy deposits of dirt and brake dust.
2. Rinse well after cleaning.

**Note:** *Do not apply a cleaning chemical to warm or hot wheel rims and covers.*

If you intend on parking your vehicle for an extended period after cleaning the wheels with a wheel cleaner, drive your vehicle for a few minutes before parking your vehicle. This reduces the risk of corrosion of the brake discs, brake pads and linings.

Do not clean the wheels when they are hot.

**Note:** *Some car washes could damage wheel rims and covers.*

**Note:** *Using non-recommended cleaners, harsh cleaning products, chrome wheel cleaners or abrasive materials could damage wheel rims and covers.*

## CLEANING THE ENGINE COMPARTMENT

Use a vacuum cleaner to remove debris from the screen area below windshield.

**Note:** *If you are not familiar with the parts around the engine do not wash the engine compartment. Avoid frequent engine washes.*

When washing the engine compartment:

- Never wash or rinse the engine while it is hot or running.
- Never wash or rinse any ignition coil, spark plug wire or spark plug well.
- Cover the battery, power distribution box, and air filter assembly to prevent water damage.

# Vehicle Care

**Note:** If your vehicle has an engine cover remove the cover before application of shampoo and degreaser.

- Spray an approved engine shampoo and degreaser on all parts that require cleaning and rinse with water.

## CLEANING STRIPES OR GRAPHICS

It is recommended to wash your vehicle by hand however, pressure washing may be used under the following conditions:

- Use a spray with a 40° wide spray angle pattern.
- Keep the nozzle at a 12 in (305 mm) distance and 90° angle to your vehicle's surface.
- Do not use water pressure higher than 2,000 psi (14,000 kPa).
- Do not use water hotter than 179°F (82°C).

**Note:** Holding the pressure washer nozzle at an angle to the vehicle's surface may damage graphics and cause the edges to peel away from the vehicle's surface.

## CLEANING CAMERA LENSES AND SENSORS

We recommend that you only use lukewarm or cold water and a soft cloth to clean the camera lens and sensors.

**Note:** Do not pressure wash camera lens and sensors.

## CLEANING THE UNDERBODY

Flush the complete underside of your vehicle frequently. Keep body and door drain holes free from packed dirt.

Rear suspension components may require regular cleaning with a power washer or a thorough rinse with a strong stream of water if the vehicle is operated in dusty or muddy environments. Rear leaf springs or other suspension components may emit squeaking or popping noises while operating the vehicle if particles, such as dirt, rocks, or other debris, are present in the components.

## CLEANING THE EXHAUST

 **WARNING:** Do not modify or remove the exhaust tailpipe. Blocked holes may result in increased exhaust gas temperatures, vehicle damage, property damage or personal injury.

 **WARNING:** Failure to keep the holes in the exhaust tailpipe clean and free of debris or foreign material may result in blocked holes. Blocked holes may result in increased exhaust gas temperatures, vehicle damage, property damage or personal injury.

 **WARNING:** The normal operating temperature of the exhaust system is very high. Never work around or attempt to repair any part of the exhaust system until it has cooled. Use special care when working around the diesel oxidation catalytic converter or the diesel particulate filter. The diesel oxidation catalytic converter and the diesel particulate filter heat up to very high temperatures after only a short period of engine operation and remain hot after you switch the engine off.

# Vehicle Care

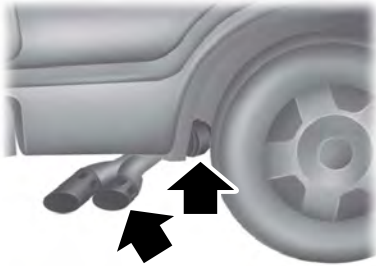

The visible holes in the exhaust tip and the holes under the shield just inboard of the right rear tire(s) are functional. Keep the holes clear of mud, debris or foreign material to maintain proper function of the exhaust system. Clean and remove debris or foreign material if present as needed. Spraying with a hose during regular washing of vehicle should help keep holes clean and clear of debris or foreign material.

## CLEANING THE INTERIOR

### CLEANING THE INSTRUMENT PANEL



**WARNING:** Do not use chemical solvents or strong detergents when cleaning the steering wheel or instrument panel to avoid contamination of the airbag system.

We recommend that you only clean the instrument panel and cluster lens with a damp soft cloth. Dry the area with a clean, soft cloth.

For additional information and assistance, we recommend that you contact an authorized dealer.

**Note:** Avoid cleaners or polishes that increase the gloss of the upper portion of the instrument panel. The dull finish in this area helps protect you from undesirable windshield reflection.

### CLEANING PLASTIC

We recommend that you only use a mild soap and water solution on a soft cloth. Dry the area with a clean, soft cloth.

### CLEANING DISPLAYS AND SCREENS

We recommend that you only use a microfiber cloth in a circular motion to clean off the fingerprint or dust.

If dirt or fingerprints are still on the screen, apply a small amount of alcohol to the cloth and try to clean it again.

**Note:** Do not pour or spray alcohol onto the touchscreen.

**Note:** Do not use detergent or any type of solvent to clean the touchscreen.

### CLEANING SEATS AND THE HEADLINER



**WARNING:** On vehicles equipped with seat-mounted airbags, do not use chemical solvents or strong detergents. Such products could contaminate the side airbag system and affect performance of the side airbag in a crash.

### Cleaning Fabric Seats and the Headliner

We recommend that you only clean the fabric seats and headliners in the following way:

1. Remove dust and loose dirt with a vacuum cleaner.

# Vehicle Care

---

2. Wipe the surface with a soft, damp cloth and a mild soap and water solution. Dry the area with a clean, soft cloth.
3. For additional information and assistance, we recommend that you contact an authorized dealer.

For heavy stains, spot clean the area. If a ring forms on the fabric, immediately clean the entire area, but do not oversaturate or the ring could set.

## Cleaning Vinyl and Leather

We recommend that you only clean the leather and vinyl surfaces in the following way:

1. Remove dust and loose dirt with a vacuum cleaner.
2. Wipe the surface with a soft, damp cloth and a mild soap and water solution. Dry the area with a clean, soft cloth.
3. For additional information and assistance, we recommend that you contact an authorized dealer.

## With King Ranch Edition

Your vehicle has seating covered in premium, top-grain leather that is extremely durable, but still requires special care and maintenance in order to preserve longevity and comfort.

Regular cleaning and conditioning maintains the appearance of the leather.

## Scratches

Because the leather in the seat comes from genuine steer hides, there may be evidence of naturally occurring markings, such as small scars. These markings give character to the seating covers and are considered to be proof of a genuine leather product.

To lessen the appearance of certain scratches and other wear marks, apply conditioner on the affected area.

## Conditioning

- Clean the surfaces using the steps outlined in the cleaning leather and vinyl section.
- Make sure the leather is dry then apply a nickel-sized amount of conditioner to a clean, dry cloth.
- Rub the conditioner into the leather until it disappears. Allow the conditioner to dry, then repeat the process for the entire interior. If a film appears, wipe it off with a dry, clean cloth.

For additional information, visit: [www.krsaddleshop.com](http://www.krsaddleshop.com)

## CLEANING CARPETS AND FLOOR MATS

We recommend that you only clean your carpets in the following way:

1. Remove dust and loose dirt with a vacuum cleaner.
2. Wipe the surface with a soft, damp cloth and a mild soap and water solution. Dry the area with a clean, soft cloth.
3. For additional information and assistance, we recommend that you contact an authorized dealer.

For heavy stains, spot clean the area. If a ring forms on the fabric, clean the entire area immediately, but do not oversaturate or the ring could set.

We recommend that you only clean your floor mats in the following way:

1. Remove dust and loose dirt with a vacuum cleaner.

# Vehicle Care

---

2. Wash rubber floor mats using mild soap and lukewarm or cold water.
3. Completely dry the floor mat before placing them back in your vehicle.

## CLEANING SEATBELTS



**WARNING:** Do not use cleaning solvents, bleach or dye on the vehicle's seatbelts, as these actions may weaken the belt webbing.

1. Wipe the surface with a soft, damp cloth and a mild soap and water solution. Dry the area with a clean, soft cloth.

## CLEANING MOONROOF TRACKS

1. Remove debris from the tracks with a vacuum cleaner.
2. Wipe the bulb seal and mating painted roof metal surface with a soft, damp cloth and a mild soap and water solution.

## REPAIRING MINOR PAINT DAMAGE

Authorized dealers have touch-up paint to match your vehicle's color. Your vehicle color code is printed on a sticker on the front, left-hand side door jamb. Take your color code to your authorized dealer to make sure you get the correct color.

Before repairing minor paint damage, use a cleaner to remove particles such as bird droppings, tree sap, insect deposits, tar spots, road salt and industrial fallout.

Read the instructions before using cleaning products.

## WAXING YOUR VEHICLE

Wax the high-gloss painted surface of your prewashed vehicle once or twice a year.

We recommend that you only use an approved quality wax that does not contain abrasives. Follow the manufacturer's instructions to apply and remove the wax. For additional information and assistance, we recommend that you contact an authorized dealer.

When washing and waxing, park your vehicle in a shaded area out of direct sunlight.

**Note:** *Avoid waxing unpainted or low-gloss black colored parts, they discolor over time.*

# Storing Your Vehicle

---

## PREPARING YOUR VEHICLE FOR STORAGE

If you plan on storing your vehicle for 30 days or more, the following maintenance recommendations ensures your vehicle stays in good operating condition.

Under various conditions, long-term storage may lead to degraded engine performance or failure unless you use specific precautions to preserve your vehicle.

### General

- Store all vehicles in a dry, ventilated place.
- If vehicles are stored outside, they require regular maintenance to protect against rust and weather damage.
- Make sure all linkages, cables, levers and pins under your vehicle are covered with grease to prevent rust.
- Move vehicles at least 25 ft (7.5 m) every 15 days to lubricate working parts and prevent corrosion.
- Fill the fuel tank with high-quality fuel until the first automatic shutoff of the fuel pump nozzle.

### Engine

- Change the engine oil and filter prior to storage because used engine oil contains contaminants which may cause engine damage.
- Start the engine every 15 days for a minimum of 15 minutes. Run at fast idle with the climate controls set to defrost until the engine reaches normal operating temperature.
- With your foot on the brake, shift through all the gears while the engine is running.

### Body

- Wash your vehicle thoroughly to remove dirt, grease, oil, tar or mud from exterior surfaces, rear-wheel housings and the underside of front fenders.
- Periodically wash your vehicle if it is stored in exposed locations.
- Touch-up exposed or primed metal to prevent rust.
- Cover chrome and stainless steel parts with a thick coat of auto wax to prevent discoloration. Re-wax as necessary when you wash your vehicle.
- Lubricate all hood, door and luggage compartment hinges and latches with a light grade oil.
- Cover interior trim to prevent fading.
- Keep all rubber parts free from oil and solvents.

### Hybrid Battery Systems

We recommend the following actions for your vehicle:

- When storing your vehicle for greater than 30 days the state of charge should be approximately 50%. Additionally we recommend disconnecting the 12V battery which will reduce system loads on the HV battery.

### 12 Volt Battery

- Check and recharge as necessary. Keep connections clean.

**Note:** *It is necessary to reset memory features if you disconnect the battery cables.*

### Brakes

Make sure the brakes and parking brake release fully.

# Storing Your Vehicle

---

**Note:** *If you intend on parking your vehicle for an extended period after cleaning the wheels with a wheel cleaner, drive your vehicle for a few minutes before doing so to reduce the risk of increased corrosion of the brake discs, brake pads and linings.*

## Tires

- Maintain recommended air pressure.

**Note:** *If you intend on parking your vehicle for an extended period after cleaning the wheels with a wheel cleaner, drive your vehicle for a few minutes before doing so. This reduces the risk of corrosion of the brake discs, brake pads and linings.*

- Check fluid levels (including coolant, oil and gas) to make sure there are no leaks, and fluids are at recommended levels.
- If you remove the battery, clean the battery cable ends and check for damage.

Contact an authorized dealer if you have any concerns or issues.

## REMOVING YOUR VEHICLE FROM STORAGE

When your vehicle is ready to come out of storage, do the following:

- We recommend that you change the engine oil before you use your vehicle again.
- Wash your vehicle to remove any dirt or grease film build-up on window surfaces.
- Check windshield wipers for any deterioration.
- Check under the hood for any foreign material that may have collected during storage such as mice or squirrel nests.
- Check the exhaust for any foreign material that may have collected during storage.
- Check tire pressures and set tire inflation per the Tire Label.
- Check brake pedal operation. Drive your vehicle 15 ft (4.5 m) back and forth to remove rust build-up.

# Wheel and Tire Information

## LOCATING THE TIRE LABEL

You will find a Tire Label containing tire inflation pressure by tire size and other important information located on the B-Pillar or the edge of the driver's door. See **Locating the Safety Compliance Certification Labels** (page 312).

## DEPARTMENT OF TRANSPORTATION UNIFORM TIRE QUALITY GRADES



Tire Quality Grades apply to new pneumatic passenger car tires. The Quality grades can be found where applicable on the tire sidewall between tread shoulder and maximum section width. For example: **Treadwear 200 Traction AA Temperature A.**

These Tire Quality Grades are determined by standards that the United States Department of Transportation has set.

Tire Quality Grades apply to new pneumatic passenger car tires. They do not apply to deep tread, winter-type snow tires, space-saver or temporary use spare tires, light truck or LT type tires, tires with nominal rim diameters of 10 to 12 inches or limited production tires as defined in Title 49 Code of Federal Regulations Part 575.104 (c)(2).

**U.S. Department of Transportation Tire quality grades:** The U.S. Department of Transportation requires us to give you the following information about tire grades exactly as the government has written it.

### Treadwear

The treadwear grade is a comparative rating based on the wear rate of the tire when tested under controlled conditions on a specified government test course. For example, a tire graded 150 would wear 1½ times as well on the government course as a tire graded 100. The relative performance of tires depends upon the actual conditions of their use, however, and may depart significantly from the norm due to variations in driving habits, service practices, and differences in road characteristics and climate.



# Wheel and Tire Information

## Traction AA A B C



**WARNING:** The traction grade assigned to this tire is based on straight-ahead braking traction tests, and does not include acceleration, cornering, hydroplaning or peak traction characteristics.

The traction grades, from highest to lowest are AA, A, B, and C. The grades represent the tire's ability to stop on wet pavement as measured under controlled conditions on specified government test surfaces of asphalt and concrete. A tire marked C may have poor traction performance.

## Temperature A B C



**WARNING:** The temperature grade for this tire is established for a tire that is properly inflated and not overloaded. Excessive speed, underinflation, or excessive loading, either separately or in combination, can cause heat buildup and possible tire failure.

The temperature grades are A (the highest), B and C, representing the tire's resistance to the generation of heat and its ability to dissipate heat when tested under controlled conditions on a specified indoor laboratory

test wheel. Sustained high temperature can cause the material of the tire to degenerate and reduce tire life, and excessive temperature can lead to sudden tire failure. The grade C corresponds to a level of performance which all passenger car tires must meet under the Federal Motor Vehicle Safety Standard No. 139. Grades B and A represent higher levels of performance on the laboratory test wheel than the minimum required by law.

## INFORMATION ON THE TIRE SIDEWALL

Both United States and Canada Federal regulations require tire manufacturers to place standardized information on the sidewall of all tires. This information identifies and describes the fundamental characteristics of the tire and also provides a U.S. DOT Tire Identification Number for safety standard certification and in case of a recall.

# Wheel and Tire Information

## Information on P Type Tires

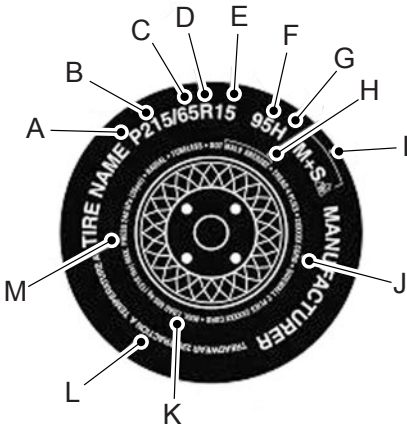

P215/65R15 95H is an example of a tire size, load index and speed rating. The definitions of these items are listed below. (Note that the tire size, load index and speed rating for your vehicle may be different from this example.)

**A. P:** Indicates a tire, designated by the Tire and Rim Association, that may be used for service on cars, sport utility vehicles, minivans and light trucks. **Note:** If your tire size does not begin with a letter this may mean it is designated by either the European Tire and Rim Technical Organization or the Japan Tire Manufacturing Association.

**B. 215:** Indicates the nominal width of the tire in millimeters from sidewall edge to sidewall edge. In general, the larger the number, the wider the tire.

**C. 65:** Indicates the aspect ratio which gives the tire's ratio of height to width.

**D. R:** Indicates a radial type tire.

**E. 15:** Indicates the wheel or rim diameter in inches. If you change your wheel size, you will have to purchase new tires to match the new wheel diameter.

**F. 95:** Indicates the tire's load index. It is an index that relates to how much weight a tire can carry. You may find this information in your owner's manual. If not, contact a local tire dealer.

**Note:** You may not find this information on all tires because it is not required by federal law.

**G. H:** Indicates the tire's speed rating. The speed rating denotes the speed at which a tire is designed to be driven for extended periods of time under a standard condition of load and inflation pressure. The tires on your vehicle may operate at different conditions for load and inflation pressure. These speed ratings may need to be adjusted for the difference in conditions. The ratings range from 81 mph (130 km/h) to 186 mph (299 km/h). These ratings are listed in the following chart.

## Wheel and Tire Information

**Note:** You may not find this information on all tires because it is not required by federal law.

Letter rating	Speed rating
M	81 mph (130 km/h)
N	87 mph (140 km/h)
Q	99 mph (159 km/h)
R	106 mph (171 km/h)
S	112 mph (180 km/h)
T	118 mph (190 km/h)
U	124 mph (200 km/h)
H	130 mph (210 km/h)
V	149 mph (240 km/h)
W	168 mph (270 km/h)
Y	186 mph (299 km/h)

**Note:** For tires with a maximum speed capability over 149 mph (240 km/h), tire manufacturers sometimes use the letters ZR. For those with a maximum speed capability over 186 mph (299 km/h), tire manufacturers always use the letters ZR.

**H. U.S. DOT Tire Identification Number (TIN):** This begins with the letters DOT and indicates that the tire meets all federal standards. The next two numbers or letters are the plant code designating where it was manufactured, the next two are

the tire size code and the last four numbers represent the week and year the tire was built. For example, the numbers 317 mean the 31st week of 1997. After 2000, the numbers go to four digits. For example, 2501 means the 25th week of 2001. The numbers in between are identification codes used for traceability. This information is used to contact customers if a tire defect requires a recall.

**I. M+S or M/S:** Mud and Snow, or

**AT:** All Terrain, or

**AS:** All Season.

**J. Tire Ply Composition and Material Used:** Indicates the number of plies or the number of layers of rubber-coated fabric in the tire tread and sidewall. Tire manufacturers also must indicate the ply materials in the tire and the sidewall, which include steel, nylon, polyester, and others.

**K. Maximum Load:** Indicates the maximum load in kilograms and pounds that can be carried by the tire. See the Safety Compliance Certification Label (affixed to either the door hinge pillar, door-latch post, or the door edge that meets the door-latch post, next to the driver's seating position), for the correct tire pressure for your vehicle.

**L. Treadwear, Traction and Temperature Grades:**

## Wheel and Tire Information

**\*Treadwear:** The treadwear grade is a comparative rating based on the wear rate of the tire when tested under controlled conditions on a specified government test course. For example, a tire graded 150 would wear one and one-half times as well on the government course as a tire graded 100.

**\*Traction:** The traction grades, from highest to lowest are AA, A, B, and C. The grades represent the tire's ability to stop on wet pavement as measured under controlled conditions on specified government test surfaces of asphalt and concrete. A tire marked C may have poor traction performance.

**\*Temperature:** The temperature grades are A (the highest), B and C, representing the tire's resistance to the generation of heat and its ability to dissipate heat when tested under controlled conditions on a specified indoor laboratory test wheel.

**M. Maximum Inflation Pressure:** Indicates the tire manufacturers' maximum permissible pressure or the pressure at which the maximum load can be carried by the tire. This pressure is normally higher than the vehicle manufacturer's recommended cold inflation pressure which can be found on the Safety Compliance Certification Label (affixed to either the door hinge pillar,

door-latch post, or the door edge that meets the door-latch post, next to the driver's seating position), or Tire Label which is located on the B-Pillar or the edge of the driver's door. The cold inflation pressure should never be set lower than the recommended pressure on the vehicle label.

The tire suppliers may have additional markings, notes or warnings such as standard load or radial tubeless.

### Additional Information Contained on the Tire Sidewall for LT Type Tires

**Note:** *Tire Quality Grades do not apply to this type of tire.*

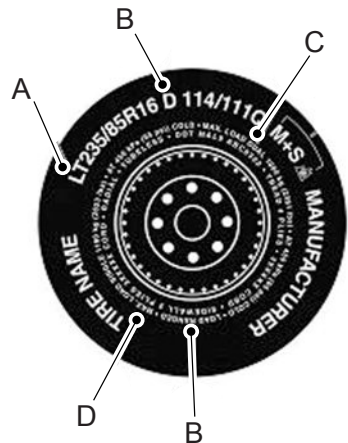

## Wheel and Tire Information

LT type tires have some additional information beyond those of P type tires; these differences are described below.

A. **LT:** Indicates a tire, designated by the Tire and Rim Association, that is intended for service on light trucks.

B. **Load Range and Load Inflation Limits:** Indicates the tire's load-carrying capabilities and its inflation limits.

C. **Maximum Load Dual lb (kg) at psi (kPa) cold:** Indicates the maximum load and tire pressure when the tire is used as a dual, defined as four tires on the rear axle (a total of six or more tires on the vehicle).

D. **Maximum Load Single lb (kg) at psi (kPa) cold:** Indicates the maximum load and tire pressure when the tire is used as a single, defined as two tires (total) on the rear axle.

### Information on T Type Tires

T145/80D16 is an example of a tire size.

**Note:** *The temporary tire size for your vehicle may be different from this example. Tire Quality Grades do not apply to this type of tire.*

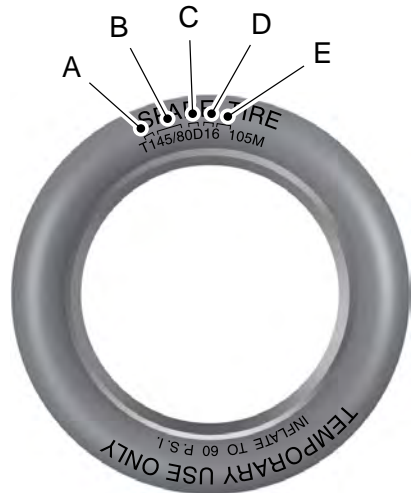

T type tires have some additional information beyond those of P type tires; these differences are described below:

A. **T:** Indicates a type of tire, designated by the Tire and Rim Association, that is intended for temporary service on cars, sport utility vehicles, minivans and light trucks.

B. **145:** Indicates the nominal width of the tire in millimeters from sidewall edge to sidewall edge. In general, the larger the number, the wider the tire.

# Wheel and Tire Information

---

C. **80:** Indicates the aspect ratio which gives the tire's ratio of height to width. Numbers of 70 or lower indicate a short sidewall.

D. **D:** Indicates a diagonal type tire.

**R:** Indicates a radial type tire.

E. **16:** Indicates the wheel or rim diameter in inches. If you change your wheel size, you will have to purchase new tires to match the new wheel diameter.

## GLOSSARY OF TIRE TERMINOLOGY

\***Tire label:** A label showing the original equipment tire sizes, recommended inflation pressure and the maximum weight the vehicle can carry.

\***Tire Identification Number (TIN):** A number on the sidewall of each tire providing information about the tire brand and manufacturing plant, tire size and date of manufacture. Also referred to as DOT code.

\***Inflation pressure:** A measure of the amount of air in a tire.

\***Standard load:** A class of P-metric or Metric tires designed to carry a maximum load at set pressure. For example: For P-metric tires 35 psi (2.4 bar) and for Metric tires 36 psi (2.5 bar). Increasing the inflation pressure beyond this pressure will not increase the tire's load carrying capability.

\***Extra load:** A class of P-metric or Metric tires designed to carry a heavier maximum load at 42 psi (2.9 bar). Increasing the inflation pressure beyond this pressure will not increase the tire's load carrying capability.

\***kPa:** Kilopascal, a metric unit of air pressure.

\***PSI:** Pounds per square inch, a standard unit of air pressure.

\***Cold tire pressure:** The tire pressure when the vehicle has been stationary and out of direct sunlight for an hour or more and prior to the vehicle being driven for 1 mi (1.6 km).

\***Recommended inflation pressure:** The cold inflation pressure found on the Safety Compliance Certification Label (affixed to either the door hinge pillar, door-latch post, or the door edge that meets the door-latch post, next to the driver's seating position), or Tire Label located on the B-Pillar or the edge of the driver door.

\* **B-pillar:** The structural member at the side of the vehicle behind the front door.

\***Bead area of the tire:** Area of the tire next to the rim.

\* **Sidewall of the tire:** Area between the bead area and the tread.

# Wheel and Tire Information

**\*Tread area of the tire:** Area of the perimeter of the tire that contacts the road when mounted on the vehicle.

**\*Rim:** The metal support (wheel) for a tire or a tire and tube assembly upon which the tire beads are seated.

## TIRE REPLACEMENT REQUIREMENTS

### AGE



**WARNING:** Tires degrade over time depending on many factors such as weather, storage conditions, and conditions of use (load, speed, inflation pressure) the tires experience throughout their lives.

In general, tires should be replaced after six years regardless of tread wear. However, heat caused by hot climates or frequent high loading conditions can accelerate the aging process and may require tires to be replaced more frequently.

You should replace your spare tire when you replace the road tires or after six years due to aging even if it has not been used.

## U.S. DOT Tire Identification Number

Both United States and Canada Federal regulations require tire manufacturers to place standardized information on the sidewall of all tires. This information identifies and describes the fundamental characteristics of the tire and also provides a U.S. DOT Tire Identification Number for safety standard certification and in case of a recall.

This begins with the letters DOT and indicates that the tire meets all federal standards. The next two numbers or letters are the plant code designating where it was manufactured, the next two are the tire size code and the last four numbers represent the week and year the tire was built. For example, the numbers 317 mean the 31st week of 1997. After 2000, the numbers go to four digits. For example, 2501 means the 25th week of 2001. The numbers in between are identification codes used for traceability. This information is used to contact customers if a tire defect requires a recall.

## Tire Replacement Requirements

Your vehicle is equipped with tires designed to provide a safe ride and handling capability.

## Wheel and Tire Information



**WARNING:** Only use replacement tires and wheels that are the same size, load index, speed rating and type (such as P-metric versus LT-metric or all-season versus all-terrain) as those originally provided by Ford. The recommended tire and wheel size may be found on either the Safety Compliance Certification Label (affixed to either the door hinge pillar, door-latch post, or the door edge that meets the door-latch post, next to the driver's seating position), or the Tire Label which is located on the B-Pillar or edge of the driver's door. If this information is not found on these labels, then you should contact your authorized dealer as soon as possible. Use of any tire or wheel not recommended by Ford can affect the safety and performance of your vehicle, which could result in an increased risk of loss of vehicle control, vehicle rollover, personal injury and death.



**WARNING:** To reduce the risk of serious injury, when mounting replacement tires and wheels, you should not exceed the maximum pressure indicated on the sidewall of the tire to set the beads without additional precautions listed below. If the beads do not seat at the maximum pressure indicated, re-lubricate and try again.



**WARNING:** For a mounting pressure more than 20 psi (1.38 bar) greater than the maximum pressure, a Ford dealer or other tire service professional should do the mounting.



**WARNING:** Always inflate steel carcass tires with a remote air fill with the person inflating standing at a minimum of 12 ft (3.66 m) away from the wheel and tire assembly.



**WARNING:** When inflating the tire for mounting pressures up to 20 psi (1.38 bar) greater than the maximum pressure on the tire sidewall, the following precautions must be taken to protect the person mounting the tire:

- Make sure that you have the correct tire and wheel size.
- Lubricate the tire bead and wheel bead seat area again.



# Wheel and Tire Information

- Stand at a minimum of 12 ft (3.66 m) away from the wheel and tire assembly.
- Use both eye and ear protection.

**Important:** Remember to replace the wheel valve stems when the road tires are replaced on your vehicle.

It is recommended that the two front tires or two rear tires generally be replaced as a pair if the worn tires still have usable depth.

To avoid potential Four-Wheel Drive (4WD) malfunction or (4WD) system damage, it is recommended to replace all four tires rather than mixing significantly worn tires with new tires.

The tire pressure sensors mounted in the wheels (originally installed on your vehicle) are not designed to be used in aftermarket wheels.

The use of wheels or tires not recommended may affect the operation of your tire pressure monitoring system.

If the tire pressure monitoring system indicator is flashing, your system is malfunctioning. Your replacement tire might be incompatible with your tire pressure monitoring system, or some component of the system may be damaged.

Tire can be damaged during off-road use, so inspection after off-road use is also recommended.

## Replacing a Tire That Is Greenhouse Gas Certified

The tires installed on this vehicle at the factory as original equipment are certified for Greenhouse Gas and Fuel Efficiency regulations. Replacement tires must be of equal or lower rolling resistance level (TRRL or Crr). Consult with your tire supplier(s) for appropriate replacement tires.

## USING SNOW CHAINS

 **WARNING:** Do not exceed 30 mph (50 km/h). Failure to follow this instruction could result in the loss of control of your vehicle, personal injury or death.

 **WARNING:** Do not use snow chains on snow-free roads.

 **WARNING:** Only fit snow chains to specified tires.

 **WARNING:** If your vehicle is fitted with wheel trims, remove them before fitting snow chains.

 **WARNING:** Wheels and tires must be the same size, load index and speed rating as those originally fitted on the vehicle. Use of any other tire or wheel can affect the safety and performance of your vehicle. Additionally, the use of non-recommended tires and wheels can

# Wheel and Tire Information

cause steering, suspension, axle, transfer case or power transfer unit failure. Follow the recommended tire inflation pressures found on the Safety Compliance Certification label, or the Tire Label on the B-Pillar or the edge of the driver door. Failure to follow this instruction could result in loss of vehicle control, vehicle rollover, or personal injury or death.

**Note:** Do not use snow chains on vehicles with LT275/65R20 or LT 285/75R18 sized tires.

**Note:** The suspension insulation and bumpers will help prevent vehicle damage. Do not remove these components from your vehicle when using snow tires and chains.

The tires on your vehicle have all-weather treads to provide traction in rain and snow. However, in some climates, you may need to use snow tires and cables. If you need to use cables, we recommend that you use steel wheels of the same size and specification, as cables may chip aluminum wheels.

Follow these guidelines when using snow tires and chains:

- If possible, avoid fully loading your vehicle.
- Use only SAE Class S chains.
- Install chains securely, verifying that the chains do not touch any wiring, brake lines or fuel lines.
- Only install snow chains on the rear axle.
- For Dual Rear Wheel (DRW) vehicles, only install snow chains on the outer wheel of each pair.
- Drive cautiously. If you hear the chains rub or bang against your vehicle, stop and retighten the chains. If this does not work, remove the chains to prevent damage to your vehicle.
- Remove the tire chains when you no longer need them. Do not use tire chains on dry roads.

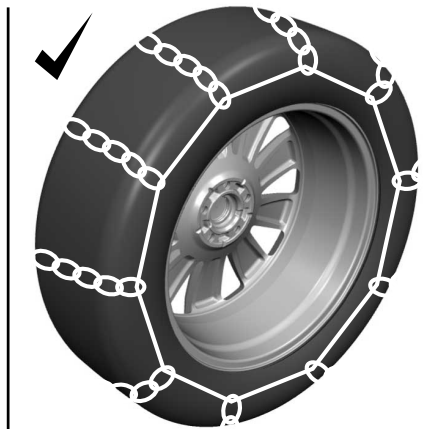
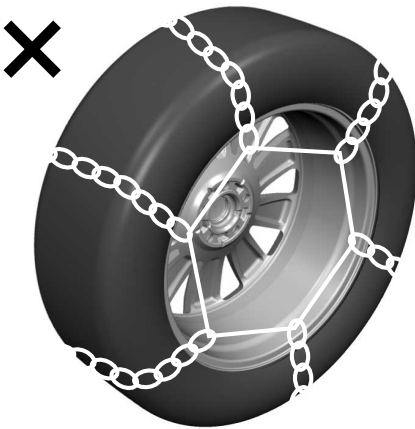

## Wheel and Tire Information

---

Use snow chains that fit against the sidewall of the tire to prevent the chains from touching the wheel rims or suspension. Refer to the previous illustration.

If you have any questions regarding snow chains, please contact your authorized dealer.

# Tire Care

## CHECKING THE TIRE PRESSURES

Safe operation of your vehicle requires that your tires are properly inflated. Every day before you drive, check your tires.

At least once a month and before long trips, inspect each tire and check the tire pressure with a tire gauge. Inflate all tires to the recommended inflation pressure. See **Inflating the Tires** (page 441).

## INFLATING THE TIRES



**WARNING:** Under-inflation is the most common cause of tire failures and may result in severe tire cracking, tread separation or blowout, with unexpected loss of vehicle control and increased risk of injury. Under-inflation increases sidewall flexing and rolling resistance, resulting in heat buildup and internal damage to the tire. It also may result in unnecessary tire stress, irregular wear, loss of vehicle control and accidents. A tire can lose up to half of its air pressure and not appear to be flat!

Use the recommended cold inflation pressure for optimum tire performance and wear. Under-inflation or over-inflation may cause uneven treadwear patterns.

Always inflate your tires to the recommended inflation pressure even if it is less than the maximum inflation pressure information found on the tire. You will find a Tire Label containing the manufacturer's recommended tire inflation pressure by the tire size and other important information located on the B-Pillar or the edge of the driver door.

The recommended tire inflation pressure is also found on the Safety Compliance Certification Label, affixed to either the door hinge pillar, door-latch post, or the door edge that meets the door-latch on the B-pillar, or on the edge of the driver door.

Failure to follow the tire pressure recommendations can cause uneven treadwear patterns and adversely affect the way your vehicle handles.

**Note:** *If you have to drive a distance to get air for your tire(s), check and record the tire pressure first and add the appropriate air pressure when you get to the pump. It is normal for tires to heat up and the air pressure inside to go up as you drive.*

To check the pressure in your tire(s):

# Tire Care

---

1. Make sure the tires are cool, meaning they are not hot from driving even a mile.

**Note:** *If you are checking tire pressure when the tire is hot, (for example, driven more than 1 mile [1.6 kilometers]), never bleed or reduce air pressure. The tires are hot from driving and it is normal for pressures to increase above recommended cold pressures. A hot tire at or below recommended cold inflation pressure could be significantly under-inflated.*

2. Remove the cap from the valve on one tire, then firmly press the tire gauge onto the valve and measure the pressure.

3. Add enough air to reach the recommended air pressure.

**Note:** *If you overfill the tire, release air by pressing on the metal stem in the center of the valve. Then recheck the pressure with your tire gauge.*

4. Replace the valve cap.

5. Repeat this procedure for each tire, including the spare.

**Note:** *Some spare tires operate at a higher inflation pressure than the other tires. For T type mini-spare tires, (see the Dissimilar spare wheel and tire assembly information for a description. Store and maintain at 60 psi (4.15 bar) 60 psi (4.15 bar). For full-size and dissimilar spare tires, see the Dissimilar spare wheel and tire assembly information for a description. Store and maintain at the higher of the front and rear inflation pressure as shown on the Safety Compliance Certification Label or Tire Label.*

**Note:** *Do not reduce tire pressure to change the ride characteristics of the vehicle. If you do not maintain the inflation pressure at the levels specified by Ford, your vehicle may experience a condition known as shimmy. Shimmy is a severe vibration and oscillation in the steering wheel after the vehicle travels over a bump or dip in the road that does not dampen out by itself. Shimmy may result from significant under-inflation of the tires, improper tires (load range, size, or type), or vehicle modifications such as lift-kits. In the event that your vehicle experiences shimmy, you should slowly reduce speed by either lifting off the accelerator pedal or lightly applying the brakes. The shimmy will cease as the vehicle speed decreases.*

# Tire Care

---

When weather temperature changes occur, tire inflation pressures also change. A 10°F (6°C) temperature drop can cause a corresponding drop of 1 psi (7 kPa) in inflation pressure. Check your tire pressures frequently and adjust them to the proper pressure which can be found on the Safety Compliance Certification Label or Tire Label.

## Steel Carcass Plies



**WARNING:** An inflated tire and rim can be very dangerous if improperly used, serviced or maintained. To reduce the risk of serious injury, never attempt to re-inflate a tire which has been run flat or seriously under-inflated without first removing the tire from the wheel assembly for inspection. Do not attempt to add air to tires or replace tires or wheels without first taking precautions to protect persons and property.

All tires with Steel Carcass Plies (if equipped):

This type of tire utilizes steel cords in the sidewalls. As such, they cannot be treated like normal light truck tires. Tire service, including adjusting tire pressure, must be performed by personnel trained, supervised and equipped according to Federal Occupational Safety and Health Administration regulations. For example, during any procedure involving tire inflation, the technician or individual must utilize a remote inflation device, and ensure that all persons are clear of the trajectory area.



**WARNING:** Always inflate steel carcass tires with a remote air fill with the person inflating standing at a minimum of 12 ft (3.66 m) away from the wheel and tire assembly.

# Tire Care

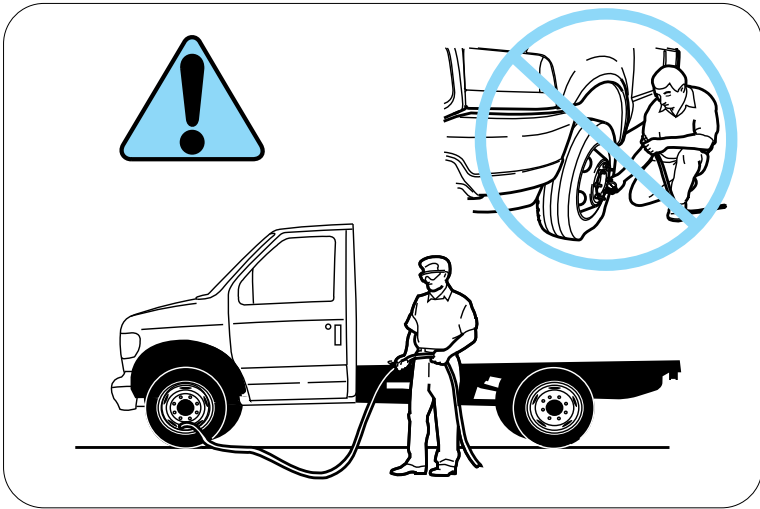

## INSPECTING THE TIRE FOR WEAR

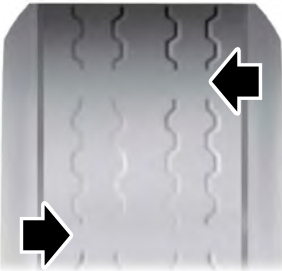

When the tread is worn down to one sixteenth of an inch (2 mm), tires must be replaced to help prevent your vehicle from skidding and hydroplaning. Built-in treadwear indicators, or wear bars, which look like narrow strips of smooth rubber across the tread will appear on the tire when the tread is worn down to one sixteenth of an inch (2 mm).

When the tire tread wears down to the same height as these wear bars, the tire is worn out and must be replaced.

# Tire Care

The tires should also be balanced periodically. An unbalanced tire and wheel assembly may result in irregular tire wear.

Periodically inspect the tire treads for uneven or excessive wear and remove objects such as stones, nails or glass that may be wedged in the tread grooves.

## INSPECTING THE TIRE FOR DAMAGE

Inspect the tire sidewalls for cracking, cuts, bruises and other signs of damage or excessive wear. If internal damage to the tire is suspected, have the tire dismantled and inspected in case it needs to be repaired or replaced. For your safety, tires that are damaged or show signs of excessive wear should not be used because they are more likely to blow out or fail.

Periodically inspect the tire treads and sidewalls for damage, such as bulges in the tread or sidewalls, cracks in the tread groove and separation in the tread or sidewall. If damage is observed or suspected, have the tire inspected by a tire professional.

Tires can be damaged during off-road use, so inspection after off-road use is also recommended.

## Safety Practices



**WARNING:** If your vehicle is stuck in snow, mud or sand, do not rapidly spin the tires; spinning the tires can tear the tire and cause an explosion. A tire can explode in as little as three to five seconds.



**WARNING:** Do not spin the wheels at over 34 mph (55 km/h). The tires may fail and injure a passenger or bystander.

## Highway Hazards

No matter how carefully you drive, there is always the possibility that you could eventually have a flat tire on the highway. Drive slowly to the closest safe area out of traffic. This could further damage the flat tire, but your safety is more important.

If you feel a sudden vibration or ride disturbance while driving, or you suspect your tire or vehicle has been damaged, immediately reduce your speed. Drive with caution until you can safely pull off the road. Stop and inspect the tires for damage. If a tire is under-inflated or damaged, deflate it, remove the wheel and replace it with your spare tire and wheel. If you cannot detect a cause, have the vehicle towed to the nearest repair facility or tire dealer to have the vehicle inspected.



# Tire Care

## Tire and Wheel Alignment

A bad jolt from hitting a curb or pothole can cause the front end of your vehicle to become misaligned or cause damage to your tires. If your vehicle seems to pull to one side when you are driving, the wheels could be out of alignment. Have an authorized dealer check the wheel alignment periodically.

Wheel misalignment in the front or the rear can cause uneven and rapid treadwear of your tires and should be corrected by an authorized dealer.

## INSPECTING THE WHEEL VALVE STEMS

Check the valve stems for holes, cracks, or cuts that may permit air leakage and replace the valve stem if damaged.

**Note:** A new valve stem (including new nut, new washer & new screw) must be installed whenever a new tire or wheel is installed.

## TIRE ROTATION



**WARNING:** If the tire label shows different tire pressures for the front and rear tires and the vehicle has a tire pressure monitoring system, then you need to update the settings for the system sensors. Always

perform the system reset procedure after tire rotation. If you do not reset the system, it may not provide a low tire pressure warning when necessary.

Rotating your tires at the recommended interval will help your tires wear more evenly, providing better tire performance and longer tire life.

**Note:** If your tires show any uneven wear have the alignment checked by an authorized dealer before rotating tires.

**Note:** If you have a dissimilar spare wheel and tire assembly, it is intended for temporary use only and should not be used in a tire rotation.

**Note:** After having your tires rotated, inflation pressure must be checked and adjusted to the vehicle requirements.

## Tire Rotation Diagram

Follow the diagram indicating the correct tire locations for rotating the tires.

## Tire Care

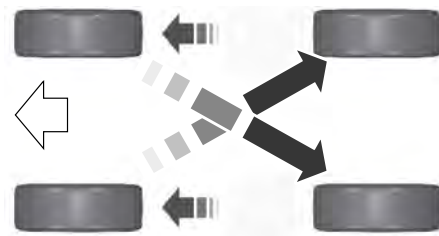

Rear-wheel drive vehicles and four-wheel drive vehicles (front tires at left of diagram).

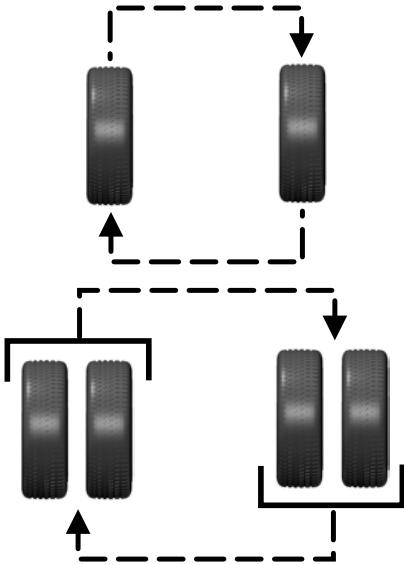

Dual rear wheel drive vehicle - six tire rotation (front tires at top of diagram).

If your vehicle is equipped with dual rear wheels it is recommended that the front and rear tires (in pairs) be rotated only side to side. We do not recommend splitting up the dual rear wheels. Rotate them side to side as a set. After tire rotation, inflation pressures must be adjusted for the tires' new positions in accordance with vehicle requirements.

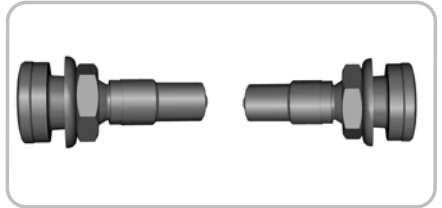

**Note:** When installing 17-inch dual rear wheels, align the valve stems facing each other.

# Tire Pressure Monitoring System (If Equipped)

## WHAT IS THE TIRE PRESSURE MONITORING SYSTEM



The tire pressure monitoring system measures the vehicle's tire pressures. A warning lamp illuminates if one or more tires are significantly underinflated or if there is a system malfunction.

## TIRE PRESSURE MONITORING SYSTEM OVERVIEW



**WARNING:** If the tire pressure monitor sensor becomes damaged it may not function.



**WARNING:** Under-inflation is the most common cause of tire failures and may result in severe tire cracking, tread separation or blowout, with unexpected loss of vehicle control and increased risk of injury. Under-inflation increases sidewall flexing and rolling resistance, resulting in heat buildup and internal damage to the tire. It also may result in unnecessary tire stress, irregular wear, loss of vehicle control and accidents. A tire can lose up to half of its air pressure and not appear to be flat!



**WARNING:** To determine the required pressure(s) for your vehicle, see the Safety Compliance Certification Label (on the door hinge pillar, door-latch post or the door edge that meets the door-latch post, next to the driver seat) or the Tire Label on the B-Pillar or the edge of the driver door.

Each tire, including the spare (if provided), should be checked monthly when cold and inflated to the inflation pressure recommended by the vehicle manufacturer on the vehicle placard or tire inflation pressure label. (If your vehicle has tires of a different size than the size indicated on the vehicle placard or tire inflation pressure label, you should determine the proper tire inflation pressure for those tires).

As an added safety feature, your vehicle has been equipped with a Tire Pressure Monitoring System (TPMS) that illuminates a low tire pressure telltale when one or more of your tires is significantly under-inflated. Accordingly, when the low tire pressure telltale illuminates, you should stop and check your tires as soon as possible, and inflate them to the proper pressure. Driving on a significantly under-inflated tire causes the tire to overheat and can lead to tire failure. Under-inflation also reduces fuel efficiency and tire tread life, and may affect the vehicle's handling and stopping ability.

Please note that the TPMS is not a substitute for proper tire maintenance, and it is the driver's responsibility to maintain correct tire pressure, even if under-inflation has not reached the level to trigger illumination of the TPMS low tire pressure telltale.

Your vehicle has also been equipped with a TPMS malfunction indicator to indicate when the system is not operating properly. The TPMS malfunction indicator is combined with the low tire pressure telltale. When the system detects a malfunction, the telltale will flash for approximately one minute and then remain continuously illuminated. This sequence will continue upon subsequent vehicle start-ups as long as the malfunction exists.

# Tire Pressure Monitoring System (If Equipped)

When the malfunction indicator is illuminated, the system may not be able to detect or signal low tire pressure as intended. TPMS malfunctions may occur for a variety of reasons, including the installation of replacement or alternate tires or wheels on the vehicle that prevent the TPMS from functioning properly. Always check the TPMS malfunction telltale after replacing one or more tires or wheels on your vehicle to ensure that the replacement or alternate tires and wheels allow the TPMS to continue to function properly.



**WARNING:** Changes or modifications not expressly approved by the party responsible for compliance could void the user's authority to operate the equipment. The term "IC:" before the radio certification number only signifies that Industry Canada technical specifications were met.

This device complies with Part 15 of the FCC Rules and with License exempt RSS Standards of Industry Canada. Operation is subject to the following two conditions:

1. This device may not cause harmful interference, and
2. This device must accept any interference received, including interference that may cause undesired operation.

## TIRE PRESSURE MONITORING SYSTEM PRECAUTIONS



**WARNING:** The tire pressure monitoring system is not a substitute for manually checking tire pressures. You should periodically check tire pressures using a pressure gauge. Failure to correctly maintain tire pressures could increase the risk of tire failure, loss of control, vehicle rollover and personal injury.



**WARNING:** Do not use the tire pressure displayed in the information display as a tire pressure gauge. Failure to follow this instruction could result in personal injury or death.

**Note:** *The use of tire sealants can damage the tire pressure monitoring system.*

## TIRE PRESSURE MONITORING SYSTEM LIMITATIONS

When the outside temperature drops significantly, the tire pressure could decrease and activate the low tire pressure warning lamp.

The warning lamp could also illuminate when you use a spare wheel, or tire sealant from the inflator kit.

**Note:** *Regularly checking the vehicle tire pressures can reduce the possibility for the warning lamp to illuminate due to outside air temperature changes.*

**Note:** *After you inflate the tires to the recommended pressure it could take up to two minutes of driving over 20 mph (32 km/h) for the warning indicator to turn off.*

# Tire Pressure Monitoring System (If Equipped)

## VIEWING THE TIRE PRESSURES



Using the information display arrow keys navigate to the truck info section where you can view the tire pressures.

## RESETTING TIRE PRESSURE MONITORING SYSTEM

### Tire Pressure Monitoring System Reset Procedure



**WARNING:** To determine the required pressure(s) for your vehicle, see the Safety Compliance Certification Label (on the door hinge pillar, door-latch post or the door edge that meets the door-latch post, next to the driver seat) or the Tire Label on the B-Pillar or the edge of the driver door.

You must reset the tire pressure monitoring system after each tire rotation on vehicles that require different recommended tire pressures in the front tires as compared to the rear tires.

**Note:** To reduce the chances of interference from another vehicle, perform the system reset procedure at least three feet, one meter, away from another vehicle undergoing the system reset procedure at the same time.

**Note:** Do not wait more than two minutes between resetting each tire sensor or the system can time-out and you need to repeat the entire procedure on all four wheels.

1. Drive the vehicle above 20 mph (32 km/h) for at least two minutes, then park in a safe location where you can easily get to all four tires and have access to an air pump.
2. Switch the ignition off.
3. Switch the ignition on but do not start the engine.
4. Switch the hazard flashers on then off three times.

**Note:** You must accomplish this within 10 seconds. If you successfully enter the reset mode, the horn sounds once, the system indicator flashes and a message shows in the information display.

## Tire Pressure Monitoring System (If Equipped)

**Note:** If the system does not enter reset mode, try again starting at Step 2. If after repeated attempts to enter the reset mode, the horn does not sound, the system indicator does not flash and no message shows in the information display, contact your authorized dealer.

5. Remove the valve cap from the valve stem on the left front tire. Decrease the air pressure until the horn sounds.

**Note:** The single horn tone confirms that the sensor identification code has been learned by the module for this position. If the horn sounds twice, the reset procedure was unsuccessful, and you must repeat it.

6. Remove the valve cap from the valve stem on the right front tire. Decrease the air pressure until the horn sounds.
7. Repeat the previous step on the right rear tire and then on the left rear tire.
8. Switch the ignition off.

**Note:** If the horn sounds twice again after switching the ignition off, and repeating the procedure, contact your authorized dealer and have your vehicle checked as soon as possible.

9. Set all four tires to the recommended air pressure as indicated on the Safety Compliance Certification Label.

## Trailer Tire Pressure Monitoring System (If Equipped)

**Note:** Additional equipment may be required for your vehicle to support trailer tire pressure and temperature monitoring. See your authorized dealer for more information.

**Note:** The trailer tire pressure monitoring system is not a substitute for proper tire maintenance. It is your responsibility to maintain correct tire pressures at all times.

**Note:** If a trailer tire is repaired, replaced or broken down for service, the screw and valve on the trailer tire pressure sensor should be replaced. See your authorized dealer for details.



The trailer tire pressure monitoring system is an added safety feature that allows you to view your trailer tire pressures and temperatures through the information display. See **Tire Pressure Monitoring System – Information Messages** (page 454). Tire

## Tire Pressure Monitoring System (If Equipped)

---

pressure sensors are mounted into each tire on your trailer. The sensors send a message to your vehicle indicating the current trailer tire pressure and temperature.

If the trailer tire pressure monitoring system detects that a tire is low, a warning message appears in the information display. The trailer tire information screen in the information display highlights the tire with a low pressure.

If the trailer tire pressure monitoring system detects that a tire temperature is over temp, a warning message appears in the Information display. The trailer tire information screen in the information display highlights the tire with a high temperature.

The main function of the trailer tire pressure monitoring system is to warn you when your trailer tires need air or if the tires are experiencing high temperatures. It can also warn you in the event the system is no longer capable of functioning as intended. See

**Tire Pressure Monitoring System – Information Messages** (page 454).

### **When a Temporary Spare or New Tire is Installed**

If you have replaced a trailer tire with a new or spare tire, a warning message appears and pressure readings are no longer displayed for that tire.

To restore the full function of the trailer tire pressure monitoring system:

- Have the damaged wheel and tire assembly repaired and remounted to your trailer.
- Install the trailer tire pressure monitoring sensor into the new wheel and tire assembly.
- Perform the trailer tire pressure monitoring system reset procedure.

### **Trailer Tire Pressure Monitoring System Reset Procedure**

**Note:** *You need to perform the tire pressure monitoring system reset procedure after each tire rotation, or when a new trailer tire pressure sensor is installed into a trailer tire.*

The trailer tire pressure monitoring system can be reset through the menu in the information display. See **Tire Pressure Monitoring System – Information Messages** (page 454). Performing the trailer setup process also resets the trailer tire pressure monitoring system.

# Tire Pressure Monitoring System (If Equipped)

## TIRE PRESSURE MONITORING SYSTEM – TROUBLESHOOTING



The low tire pressure warning lamp has combined functions, as it warns you when your tires need air, and when the system is no longer capable of functioning as intended.

## TIRE PRESSURE MONITORING SYSTEM – WARNING LAMPS

Warning Lamp	Possible Cause	Action Required
Solid warning lamp	One or more tires are significantly under inflated	After inflating your tires to the manufacturer's recommended pressure as shown on the Tire Label, on the edge of driver door or the B-Pillar, drive your vehicle for at least two minutes over 20 mph (32 km/h) before the light turns off.
Solid warning lamp or flashing warning lamp	Temporary spare wheel in use	Repair the damaged road wheel and tire and refit it to your vehicle to restore operation of the system.
	Tire pressure monitoring system malfunction	If the tires are inflated to the recommended tire pressures and the temporary spare wheel is not in use, the system detected a fault that requires service. Have your vehicle checked as soon as possible.



# Tire Pressure Monitoring System (If Equipped)

## TIRE PRESSURE MONITORING SYSTEM – INFORMATION MESSAGES

Message	Action
Tire Pressure Low	After inflating your tires to the manufacturer's recommended pressure as shown on the Tire Label, on the edge of the driver door or the B-Pillar, drive your vehicle for at least two minutes over 20 mph (32 km/h) before the light turns off.
Tire Pressure Monitor Fault	The system has detected a fault that requires service. Have your vehicle checked as soon as possible.
Tire Pressure Sensor Fault	The system has detected a fault that requires service or a spare tire is in use. Have your vehicle checked as soon as possible.

## Trailer Tire Pressure Monitoring System

Message	Action
Trailer Tire Low Specified:	One or more tires on your trailer is below the specified tire pressure.
Trailer Tire Over Temperature	Displays when one or more tires on your trailer is above the recommended temperature.
Trailer Tire Pressure Sensor Fault	A trailer tire pressure sensor is malfunctioning. If the warning stays on or continues to come on, contact an authorized dealer as soon as possible.
Trailer Tire Pressure Monitor Fault	The trailer tire pressure monitoring system is malfunctioning. If the warning stays on or continues to come on, contact an authorized dealer.
Trailer Tire Pressure Monitor Capability Not Detected	The system cannot detect the trailer tire pressure monitoring system.
Trailer Tire Pressure Indication Not Setup See Manual	The trailer tire pressure monitoring system is not setup. See <b>Tire Pressure Monitoring System</b> (page 448).

# Changing a Road Wheel

## CHANGING A FLAT TIRE



**WARNING:** If the tire pressure monitor sensor becomes damaged it may not function.

**Note:** *The use of tire sealant may damage your tire pressure monitoring system and should only be used in roadside emergencies.*

**Note:** *The tire pressure monitoring system indicator light illuminates when the spare tire is in use. To restore the full function of the monitoring system, all road wheels equipped with tire pressure monitoring sensors must be mounted on this vehicle.*

If you get a flat tire when driving, do not apply the brake heavily. Instead, gradually decrease your speed. Hold the steering wheel firmly and slowly move to a safe place on the side of the road.

Have a flat serviced by an authorized dealer to prevent damage to the system sensors. See **Tire Pressure Monitoring System Precautions** (page 449). Replace the spare tire with a road tire as soon as possible. During repairing or replacing the flat tire, have the authorized dealer inspect the system sensor for damage.

## Dissimilar Spare Wheel and Tire Assembly Information



**WARNING:** Failure to follow these guidelines could result in an increased risk of loss of vehicle control, injury or death.

If you have a dissimilar spare wheel and tire, then it is intended for temporary use only. This means that if you need to use it, you should replace it as soon as possible with a road wheel and tire assembly that is the same size and type as the road tires and wheels that were originally provided by Ford. If the dissimilar spare tire or wheel is damaged, it should be replaced rather than repaired.

A dissimilar spare wheel and tire assembly is defined as a spare wheel and tire assembly that is different in brand, size or appearance from the road tires and wheels.

### Full-size dissimilar spare

When driving with the full-size dissimilar spare wheel and tire assembly, do not:

- Exceed 70 mph (113 km/h).
- Use more than one dissimilar spare wheel and tire assembly at a time.
- Use snow chains on the end of the vehicle with the dissimilar spare wheel and tire assembly.

When driving with the full-size dissimilar spare wheel and tire assembly, 4WD functionality may be limited. You may experience the following:

- Additional noise from the transfer case or other drive components.
- Difficulty shifting out of a mechanically locked 4WD mode.

When driving with the full-size dissimilar spare wheel and tire assembly, it is recommended that you do not:

- Exceed 50 mph (80 km/h) in 4WD.
- Engage 4WD unless the vehicle is stationary.
- Use 4WD on dry pavement.

# Changing a Road Wheel

The usage of a full-size dissimilar spare wheel and tire assembly can lead to impairment of the following:

- Handling, stability and braking performance.
- Comfort and noise.
- Ground clearance and parking at curbs.
- Winter weather driving capability.
- Wet weather driving capability.
- Four-wheel drive capability.

When driving with the full-size dissimilar spare wheel and tire assembly additional caution should be given to:

- Towing a trailer.
- Driving vehicles equipped with a camper body.
- Driving vehicles with a load on the cargo rack.

Drive cautiously when using a full-size dissimilar spare wheel and tire assembly and seek service as soon as possible.

## Location of the Spare Tire and Tools

See the following table for their locations:

Item	Location
Spare tire - pick-up trucks only	Under the vehicle, just forward of the rear bumper.
Jack	Fastened to the floor pan behind the rear-most seat on the passenger side.
Jack handle, lug wrench, lug wrench extension - only provided on dual rear wheel vehicles.	Regular Cab: Fastened to floor behind the driver seat. Super Cab and Crew Cab: Fastened to the floor under the rear seat on the driver's side.

## Tire Change Procedure



**WARNING:** The jack supplied with this vehicle is only intended for changing wheels. Do not use the vehicle jack other than when you are changing a wheel in an emergency.

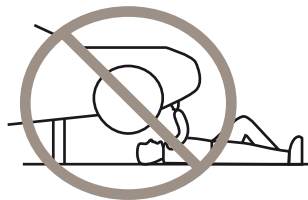

# Changing a Road Wheel

**WARNING:** To help prevent your vehicle from moving when changing a wheel, shift the transmission into park (P), set the parking brake and use an appropriate block or wheel chock to secure the wheel diagonally opposite to the wheel being changed. For example, when changing the front left wheel, place an appropriate block or wheel chock on the right rear wheel.

**WARNING:** Always use the jack provided as original equipment with your vehicle. If using a jack other than the one provided, make sure the jack capacity is adequate for the vehicle weight, including any vehicle cargo or modifications. If you are unsure if the jack capacity is adequate, contact the authorized dealer.

**WARNING:** Failure to follow these guidelines could result in an increased risk of loss of vehicle control, injury or death.

**WARNING:** Never place anything between the vehicle jack and your vehicle.

**WARNING:** Never place anything between the vehicle jack and the ground.

**WARNING:** Park your vehicle so that you do not obstruct the flow of traffic or place yourself in any danger and set up a warning triangle.

**WARNING:** The jack supplied with this vehicle is only intended for changing a flat tire in an emergency. Do not attempt to do any other work on your vehicle when it is supported by the jack, as your vehicle could slip off the jack. Failure to follow this instruction could result in personal injury or death.

**WARNING:** Do not attempt to change a tire on the side of the vehicle close to moving traffic. Pull far enough off the road to avoid the danger of being hit when operating the jack or changing the wheel.

**WARNING:** Only use the spare wheel carrier to stow wheels provided with your vehicle.

**Note:** Do not use impact tools or power tools operating at over 200 RPM on the spare wheel carrier winch, which may cause it to malfunction and result in the wheel and tire not being securely stowed.

**Note:** Passengers should not remain in the vehicle when the vehicle is being jacked.

1. Park the vehicle on a level firm ground and activate the hazard flashers.
2. Apply the parking brake, place the transmission in park (P), switch the engine off.
3. Block the wheel diagonally opposite the flat tire. For example, if the left front tire is flat, block the right rear wheel.

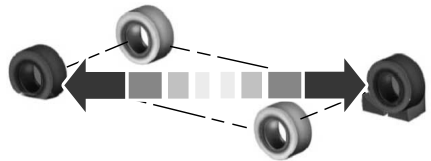

4. You can find the jack on the floor behind the rear-most seat on the passenger side. Turn the retainers counterclockwise to remove the jack.

# Changing a Road Wheel

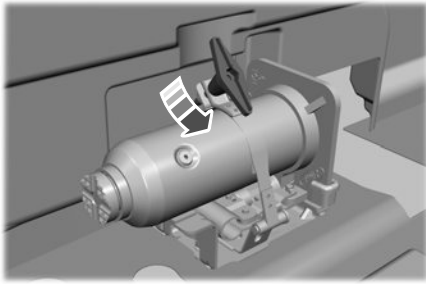

5. You can find the tool kit on the floor under the driver seat for regular cab or under the rear seat on the driver side. Turn the retainers counterclockwise to remove the tool kit.

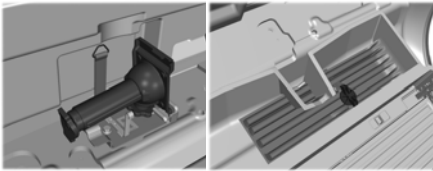

6. Use the ignition key to open the lock at the rear bumper.
7. One or more handle extensions are used to operate the spare tire carrier. To assemble, align the button with the hole and slide the parts together. To disconnect, press the button and pull apart.

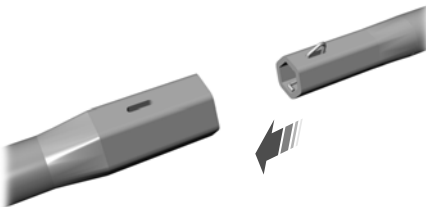

8. The lug wrench is used to turn the handle extensions and the jack handle; slide the square end of the handle extension into the square hold of the lug wrench until it clicks in place.

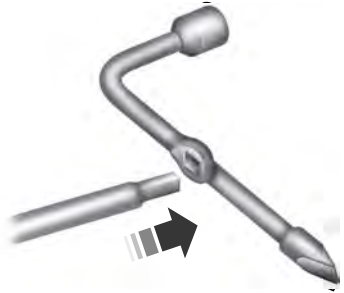

9. Fully insert the jack handle, with one extension, through the bumper hole and into the guide tube. Additional extensions will be needed if the tailgate is in the lowered position and cannot be raised. Turn the handle counterclockwise and lower the spare tire until you can slide the tire rearward and the cable is slack. You will feel some resistance when you turn the jack handle assembly. If not replacing the spare or flat tire to the underbody storage area, raise the wheel retainer up into the installed position. Do not store spare or flat tire at other locations.
10. Slide the retainer through the center of the spare tire wheel and remove the spare tire.

# Changing a Road Wheel

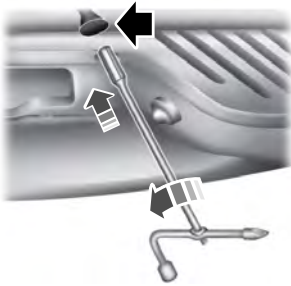

11. Remove the wheel trim with the lug wrench tip, or use the wheel trim tool described later in this section.
12. Loosen each wheel lug nut one-half turn counterclockwise, but do not remove them until the wheel is raised off the ground. For dual rear wheel, assemble the lug wrench and extension tool together to access the lug nuts.

## Vehicles With Dual Rear Alloy Wheels

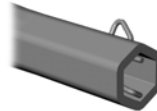
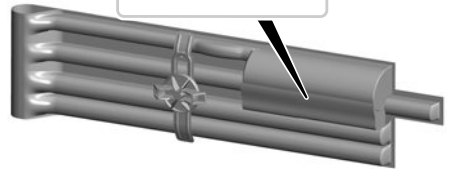

13. Position the jack under the correct jacking points.

## Removing Wheel Trim With Single Wheels

1. Insert the flat end of the lug wrench between the wheel rim and the wheel trim.
2. Carefully remove the wheel trim.

The wheel trim removal tool is in the storage bag near the lug wrench.

# Changing a Road Wheel

## Rear Wheel Trim

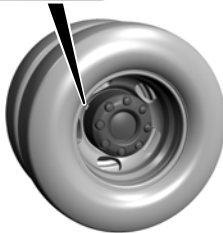

1. Locate the notch in the wheel trim.

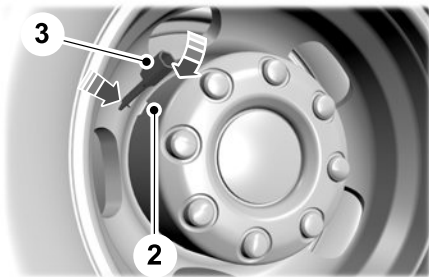

2. Insert the wheel trim removal tool into the notch in the wheel trim.
3. Rotate the wheel trim removal tool and remove the wheel trim.

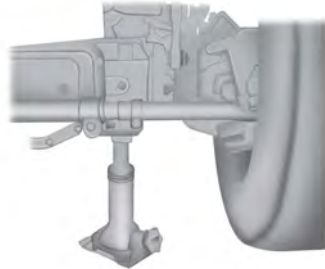

## Jacking the Vehicle

F-250 and F-350 Single Rear Wheel Vehicles

# Changing a Road Wheel

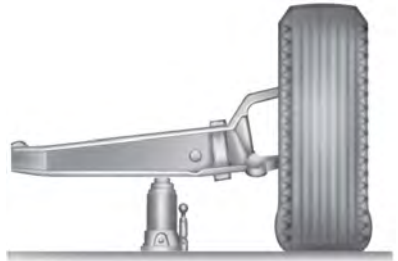

Front (4x2):F350 Dual rear wheel

**Note:** Place the jack directly under the I-beam.

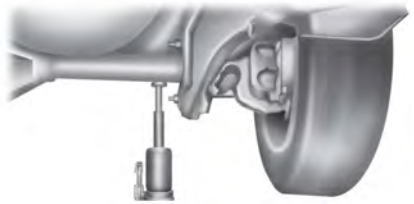
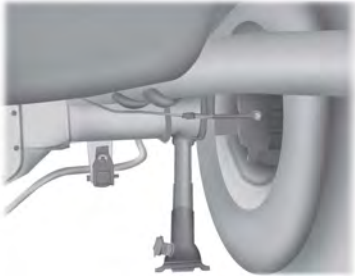

F-350 Dual Rear Wheel, F-450 and F-550 Vehicles

Front passenger side (4x4): F-350 dual rear wheel

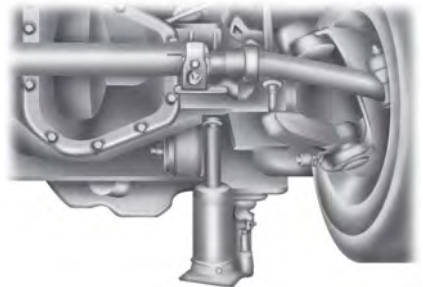

Front driver side (4x4): F-350 dual rear wheel



# Changing a Road Wheel

**Note:** Make sure the jack fits onto the flat area on the outboard side of the differential housing.

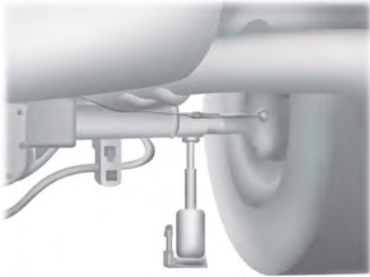

Rear: F-350 dual rear wheel

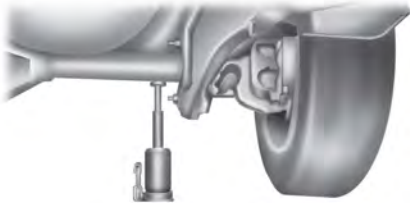

Front: F-450 and F-550

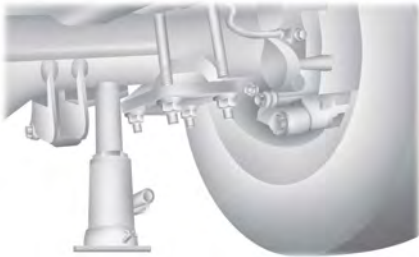

Rear: F-450 and F-550

Insert the hooked end of the jack handle into the jack and turn the jack handle clockwise. For hydraulic jacks, operate the handle up-and-down until the wheel is completely off the ground and high enough to install the spare tire.

**Note:** Hydraulic jacks have a pressure relief valve that prevents lifting loads which exceed the jack's rated capacity.

## F-250 and F-350 Single Rear Wheel Vehicles



## F-350 Dual Rear Wheel Vehicles

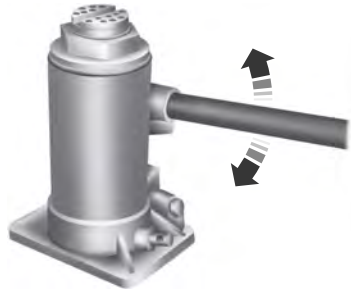

# Changing a Road Wheel

Remove the lug nuts with the lug wrench, replace the flat tire with the spare, making sure the valve stem of the spare is facing outward when replacing a front wheel. For the rear wheel position on vehicles with single rear wheel fitments, install the spare with the valve stem facing outward. For vehicles with dual rear wheels, the valve stem of the spare must face outward when replacing an inner wheel, but must face inward when replacing an outboard wheel.

Reinstall the lug nuts until the wheel is snug against the hub. Do not fully tighten the lug nuts until the wheel has been lowered.

Lower the vehicle completely by turning the jack handle counterclockwise until the vehicle is completely lowered.

**Note:** For F-350 Dual Rear Wheel, F-450 and F-550 Vehicles, insert the notched end of the jack handle to the release valve, open the release valve slightly by turning the handle counterclockwise. Stop turning the release valve when vehicle start to lower. Make sure to close the valve when you completely lower your vehicle.

## F-350 Dual Rear Wheel, F-450 and F-550 Vehicles.



## Installing the lug Nuts and Ornaments



8-lug nut torque sequence



10-lug nut torque sequence

**Note:** When installing the wheel center retention ornaments, make sure that the ornament retention towers on the back side of the ornament are aligned with the studs or nuts and retain to the flange on the lug nuts.

# Changing a Road Wheel

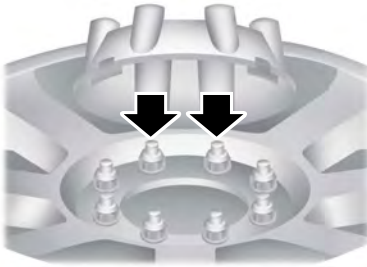

**Note:** For dual rear wheels, align the ornament with the lug nuts. (A) is the clip in the ornament and (B) is the flange of the lug nut. Make sure that each of the retention clips are sitting on a lug nut flange.

Use your hand or a rubber mallet to tap the ornament until the retention clips snap over the lug nut flanges. Tap in a star pattern until the ornament seats fully onto the wheel. There should be an even gap between the ornament and the wheel when it is properly installed.

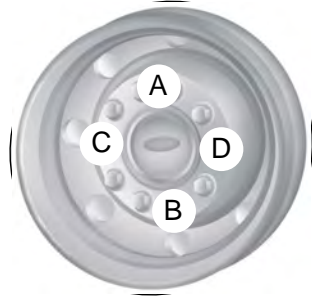
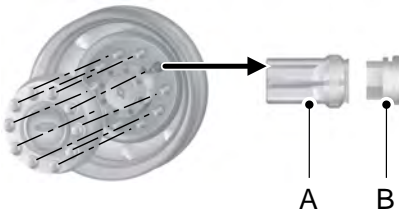

**Note:** If the ornament retention clips are aligned between the studs or lug nuts, the ornament will be improperly installed. This improper installation may appear and sound correct, but will not keep the ornament on the vehicle. Ornaments improperly installed in this manner may become loose or fall off during driving.

## Stowing the Flat Tire or Spare Tire

1. Place the tire on end with the valve stem facing toward the front of the vehicle. Lay the tire on the ground, near the rear of the vehicle, with the valve stem side facing up.

# Changing a Road Wheel



- Slide the wheel partially under the vehicle and install the retainer through the wheel center. If equipped, you may have to remove the wheel center cap prior to pushing the retainer through the center of the wheel. To remove the center cap, press it off with the lug wrench tip from the inner side of the wheel. Pull on the cable to align the components at the end of the cable.
- Reinsert the lug wrench extension(s) through the rear bumper and guide tube and turn the lug wrench clockwise until the tire is raised to its stowed position underneath the vehicle. The wrench will become harder to turn and the spare tire winch will ratchet or slip when the tire is raised to maximum tightness. You will hear a clicking sound from the winch indicating that the tire is properly stowed, tighten until a minimum of three clicks are heard. Check that the tire lies flat against the frame and is secure.
- Carefully place all tools back in the tool kit bag.
- Reinstall the tool kit bag and tighten the wing nut.
- Properly reinstall the jack into the bracket and tighten the wing nut.

## WHEEL NUTS

**WARNING:** When you install a wheel, always remove any corrosion, dirt or foreign materials present on the mounting surfaces of the wheel or the surface of the wheel hub, brake drum or brake disc that contacts the wheel. Make sure to secure any fasteners that attach the rotor to the hub so they do not interfere with the mounting surfaces of the wheel. Installing wheels without correct metal-to-metal contact at the wheel mounting surfaces can cause the wheel nuts to loosen and the wheel to come off while your vehicle is in motion, resulting in loss of vehicle control, personal injury or death.

Bolt Size	lb.ft (Nm) <sup>1</sup>
M14 x 1.5	150 lb.ft (204 Nm)

<sup>1</sup>Torque specifications are for nut and bolt threads free of dirt and rust. Use only our recommended replacement wheel nuts and or wheel bolts.

Retighten the wheel nuts to the specified torque within 100 mi (160 km) after any wheel disturbance, such as tire rotation, changing a flat tire or wheel removal.

On vehicles equipped with dual rear wheels, retighten the wheel lug nuts to the specified torque at 100 mi (160 km), and again at 500 mi (800 km) of new vehicle operation and after any wheel disturbance, such as tire rotation, changing a flat tire, or wheel removal.

It is important to follow the proper wheel mounting and lug nut torque procedures.

# Changing a Road Wheel

---



A Hub pilot bore.

Inspect the wheel pilot hole and mounting surface prior to installation. Remove any visible corrosion or loose particles.

# Capacities and Specifications

## ENGINE SPECIFICATIONS - 6.2L

Engine	6.2L V8 Engine
Displacement.	379 in <sup>3</sup> (6,210 cm <sup>3</sup> )
Required fuel.	Minimum 87 octane
Firing order.	1-5-4-8-6-3-7-2
Ignition system.	Coil on plug
Spark plug gap.	0.041 in (1.04 mm) - 0.047 in (1.2 mm)
Compression ratio.	9.8:1

## Drivebelt Routing

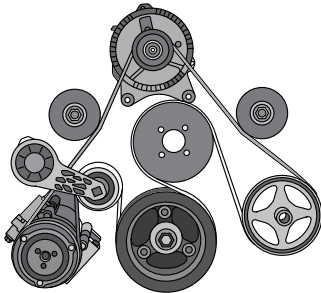

## ENGINE SPECIFICATIONS - 6.7L DIESEL

Engine	6.7L V8 Diesel Engine
Displacement.	406 in <sup>3</sup> (6,651 cm <sup>3</sup> )
Required fuel.	Ultra Low Sulfur Diesel up to B20
Firing order.	1-3-7-2-6-5-4-8
Compression ratio.	15.8:1

# Capacities and Specifications

## Drivebelt Routing Single Alternator

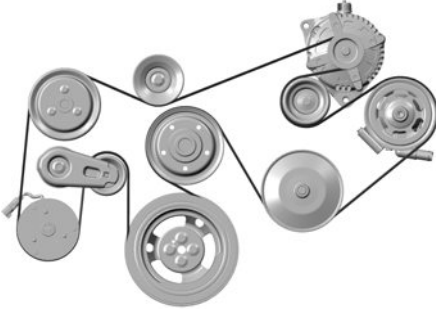

## Dual Alternator

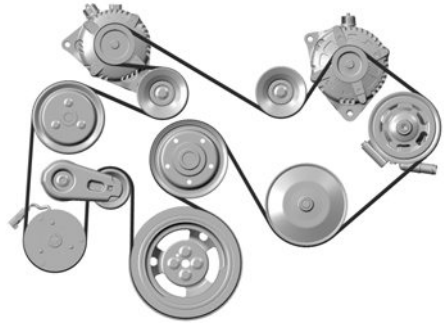

## ENGINE SPECIFICATIONS - 7.3L

Engine	7.3L V8 Engine
Displacement.	445 in <sup>3</sup> (7,293 cm <sup>3</sup> )
Required fuel.	Minimum 87 octane
Firing order.	1-5-4-8-6-3-7-2
Ignition system.	Coil near spark plug with spark plug wire
Spark plug gap.	0.049 in (1.25 mm) - 0.053 in (1.35 mm)
Compression ratio.	10.5:1

# Capacities and Specifications

## Drivebelt Routing

### Single Alternator

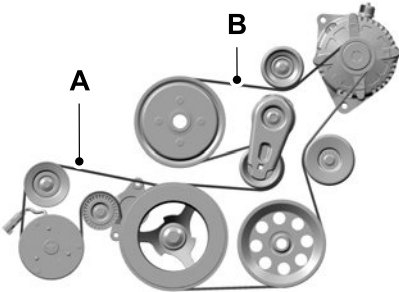

- A Drivebelt closest to the engine.
- B Drivebelt furthest from the engine.

### Dual Alternator

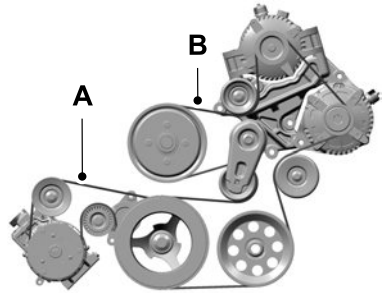

- A Drivebelt closest to the engine.
- B Drivebelt furthest from the engine.

## MOTORCRAFT PARTS - 6.2L

Component	Motorcraft Part number
Air filter element.	FA-1950
Battery (XL).	BXT-65-650
Battery (all except XL).	BXT-65-750
Cabin air filter.	FP-79
Engine oil filter. <sup>1</sup>	FL-820-S
Spark plugs. <sup>2</sup>	SP-526
Six-speed automatic transmission fluid filter (6R100).	FT-188



## Capacities and Specifications

---

Component	Motorcraft Part number
Ten-speed automatic transmission fluid filter (10R140).	FT-221
Windshield wiper blades.	WW-2248

<sup>1</sup>If a Motorcraft® oil filter is not available, use an oil filter that meets industry performance specification SAE/USCAR-36/USC-D.

<sup>2</sup>For spark plug replacement, contact your authorized dealer. Replace the spark plugs at the recommended intervals. See **Normal Scheduled Maintenance** (page 628).

We recommend Motorcraft® parts that are available at your authorized dealer or at [www.fordparts.com](http://www.fordparts.com). These parts are engineered for your vehicle, and meet or exceed our specifications. Use of other parts could impact vehicle performance, emissions and durability. Your warranty could be void for any damage related to use of other parts.

## Capacities and Specifications

---

### MOTORCRAFT PARTS - 6.7L DIESEL

<b>Component</b>	<b>Motorcraft Part number</b>
Air filter.	FA-2031
Foam pre-filter.	FA-1952
Battery (two required).	BXT-65-750
Cabin air filter.	FP-92
Engine oil filter. <sup>1</sup>	FL-2051-S
Fuel filter.	FD-4625AA
Ten-speed automatic transmission fluid filter (10R140).	FT-221
Windshield wiper blades.	WW-2248

<sup>1</sup>If a Motorcraft® oil filter is not available, use an oil filter that meets industry performance specification SAE/USCAR-36.

We recommend Motorcraft® parts that are available at your authorized dealer or at [www.fordparts.com](http://www.fordparts.com). These parts are engineered for your vehicle, and meet or exceed our specifications. Use of other parts could impact vehicle performance, emissions and durability. Your warranty could be void for any damage related to use of other parts.

## Capacities and Specifications

---

### MOTORCRAFT PARTS - 7.3L

<b>Component</b>	<b>Motorcraft Part Number</b>
Air filter element.	FA-1950
Battery.	BXT-65-750
Cabin air filter.	FP-79
Engine oil filter. <sup>1</sup>	FL-820-S
Spark plugs.	SP-589
Ten-speed automatic transmission fluid filter (10R140).	FT-221
Windshield wiper blades.	WW-2248

<sup>1</sup>If a Motorcraft® oil filter is not available, use an oil filter that meets industry performance specification SAE/USCAR-36.

We recommend Motorcraft parts that are available at your authorized dealer or at [www.fordparts.com](http://www.fordparts.com). We engineer these parts for your vehicle to meet or exceed our specifications. Use of other parts could impact vehicle performance, emissions and durability. Your warranty could be void for any damage related to use of other parts.

# Capacities and Specifications

## ENGINE OIL CAPACITY AND SPECIFICATION - 6.2L

Use oil that meets the defined specification and viscosity grade.

If you do not use oil that meets the defined specification and viscosity grade, it could result in:

- Component damage that your vehicle warranty does not cover.
- Longer engine cranking periods.
- Increased emission levels.
- Reduced vehicle performance.
- Reduced fuel economy.



An oil that displays this symbol conforms to current engine, emission system and fuel economy performance standards of ILSAC.

We recommend Motorcraft motor oil for your vehicle. If Motorcraft oil is not available, use motor oils of the recommended viscosity grade that display the API Certification Mark for gasoline engines.

Do not use supplemental engine oil additives because they are unnecessary and could lead to engine damage that your vehicle warranty does not cover.

### Capacities

Variant	Including the Oil Filter
All.	7.0 qt (6.6 L)

### Materials

Name	Specification
Motorcraft® SAE 5W-30 Synthetic Blend Motor Oil(U.S.) Motorcraft® SAE 5W-30 Super Premium Motor Oil / Huile moteur de très haute qualité SAE 5W-30 Motorcraft®(Canada) XO-5W30-Q1SP(U.S.) CXO-5W30-LSP6(Canada)	WSS-M2C961-A1

# Capacities and Specifications

## Alternative Engine Oil for Extremely Cold Climates

To improve engine cold start performance,

we recommend that you use the following alternative engine oil in extremely cold climates, where the ambient temperature reaches  $-22^{\circ}\text{F}$  ( $-30^{\circ}\text{C}$ ) or below.

### Materials

Name	Specification
Engine Oil - SAE 0W-30 - Synthetic Blend	WSS-M2C963-A1

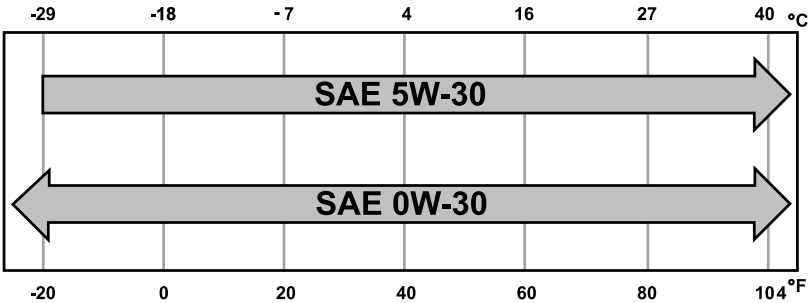

## ENGINE OIL CAPACITY AND SPECIFICATION - 6.7L DIESEL

Use oil that meets the defined specification and viscosity grade.

If you do not use oil that meets the defined specification and viscosity grade, it could result in:

- Component damage that your vehicle warranty does not cover.
- Longer engine cranking periods.
- Increased emission levels.
- Reduced vehicle performance.
- Reduced fuel economy.

## Engine Oil

We recommend Motorcraft motor oil for your vehicle. If Motorcraft motor oil is not available, use motor oil of the recommended viscosity grade that meets our specification WSS-M2C171-F1. You can find the list of approved motor oils at [www.motorcraft.com](http://www.motorcraft.com).

Do not use supplemental engine oil additives because they are unnecessary and could lead to engine damage that your vehicle warranty does not cover.

# Capacities and Specifications

The use of correct oil viscosities for diesel engines is important for satisfactory operation. Determine which oil viscosity best suits the temperature range you expect to encounter for the next service interval from the SAE Viscosity Grades chart.

**Note:** An engine block heater is recommended at temperatures below  $-9^{\circ}\text{F}$  ( $-23^{\circ}\text{C}$ ).

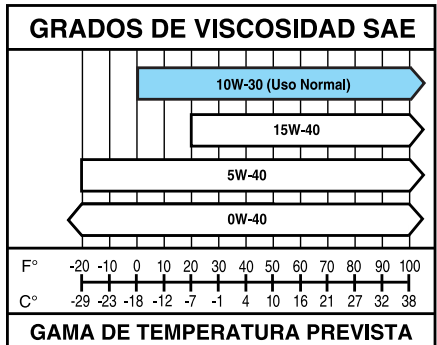
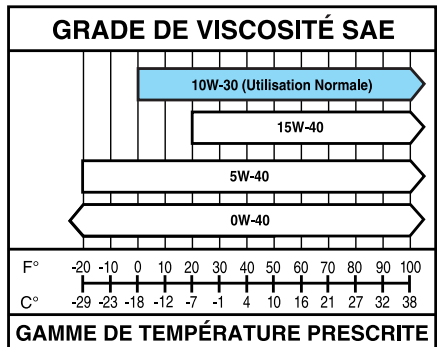
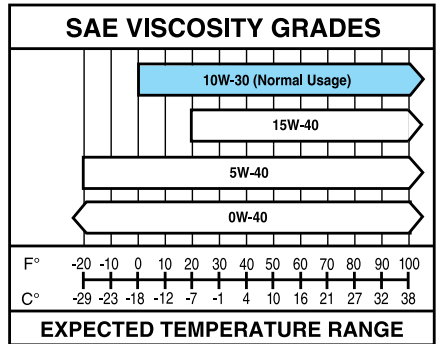

# Capacities and Specifications

## Capacities

Variant	Including the Oil Filter
All.	13.0 qt (12.3 L)

## Materials

Name	Specification
Motorcraft® SAE 10W-30 Super Duty Diesel Motor Oil(U.S.) Motorcraft® Super Duty Motor Oil SAE 10W-30 / Huile moteur Super Duty SAE 10W-30 Motor- craft®(Canada) XO-10W30-QSDF(U.S.) CXO-10W30-LSD12(Canada)	WSS-M2C171-F1

## Alternative Engine Oil for Extremely Cold Climates

To improve engine cold start performance, we recommend that you use the following alternative engine oil in extremely cold climates, where the ambient temperature reaches -22.0°F (-30°C) or below.

## Materials

Name	Specification
Engine Oil - SAE 0W-40	WSS-M2C171-F1

## Alternative Engine Oil for Biodiesel Fuel Blends (B20 Max)

# Capacities and Specifications

## Materials

Name	Specification
Motorcraft® SAE 5W-40 Full Synthetic Diesel Motor Oil (U.S.) (Canada) XO-5W40-5Q3SD (U.S.)	WSS-M2C171-F1
Motorcraft® SAE 15W-40 Super Duty Diesel Motor Oil (U.S.) Motorcraft® Super Duty Motor Oil SAE 15W-40 / Huile moteur Super Duty SAE 15W-40 Motorcraft® (Canada) XO-15W40-QSDF (U.S.) CXO-15W40-LSD12 (Canada)	WSS-M2C171-F1

## Alternative Engine Oil for Severe Duty Service

### Materials

Name	Specification
Motorcraft® SAE 5W-40 Full Synthetic Diesel Motor Oil (U.S.) (Canada) XO-5W40-5Q3SD (U.S.)	WSS-M2C171-F1

## ENGINE OIL CAPACITY AND SPECIFICATION - 7.3L

Use oil that meets the defined specification and viscosity grade.

If you do not use oil that meets the defined specification and viscosity grade, it could result in:

- Component damage that your vehicle warranty does not cover.
- Longer engine cranking periods.
- Increased emission levels.
- Reduced vehicle performance.
- Reduced fuel economy.



An oil that displays this symbol conforms to current engine, emission system and fuel economy performance standards of ILSAC.



# Capacities and Specifications

We recommend Motorcraft motor oil for your vehicle. If Motorcraft oil is not available, use motor oils of the recommended viscosity grade that display the API Certification Mark for gasoline

engines.

Do not use supplemental engine oil additives because they are unnecessary and could lead to engine damage that your vehicle warranty does not cover.

## Capacities

Variant	Including the Oil Filter
All.	8.0 qt (7.57 L)

## Materials

Name	Specification
Motorcraft® SAE 5W-30 Synthetic Blend Motor Oil(U.S.) Motorcraft® SAE 5W-30 Super Premium Motor Oil / Huile moteur de très haute qualité SAE 5W-30 Motorcraft®(Canada) XO-5W30-Q1SP(U.S.) CXO-5W30-LSP6(Canada)	WSS-M2C961-A1

## Alternative Engine Oil for Extremely Cold Climates

To improve engine cold start performance, we recommend that you use the following alternative engine oil in extremely cold climates, where the ambient temperature reaches -22°F (-30°C) or below.

## Materials

Name	Specification
Engine Oil - SAE 0W-30 - Synthetic Blend	WSS-M2C963-A1

# Capacities and Specifications

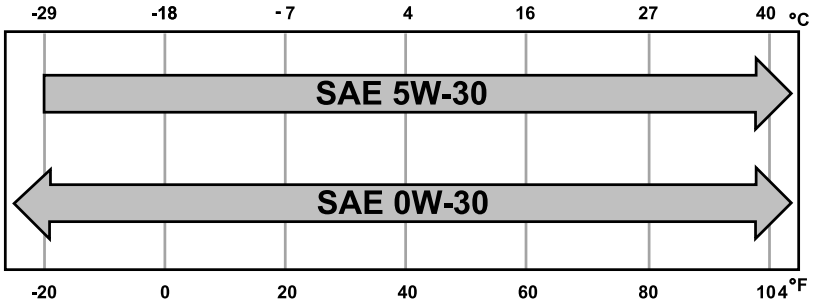

## COOLING SYSTEM CAPACITY AND SPECIFICATION - 6.2L

Use coolant that meets the defined specification.

If you do not use coolant that meets the defined specification, it could result in:

- Component damage that your vehicle warranty does not cover.
- Reduced vehicle performance.

### Capacities

Variant	Quantity
All.	24.6 qt (23.3 L)

### Materials

Name	Specification
Motorcraft® Yellow Prediluted Antifreeze/Coolant(U.S.) Motorcraft® Yellow Prediluted Antifreeze/Coolant / Antigel/liquide de refroidissement prédilué jaune Motorcraft®(Canada) VC-13DL-G(U.S.) CVC-13DL-G(Canada)	WSS-M97B57-A2

# Capacities and Specifications

## COOLING SYSTEM CAPACITY AND SPECIFICATION - 6.7L DIESEL

Use coolant that meets the defined specification.

If you do not use coolant that meets the defined specification, it could result in:

- Component damage that your vehicle warranty does not cover.
- Reduced vehicle performance.

**Note:** *An engine block heater is recommended at temperatures below-9°F (-23°C).*

### Capacities

Variant	Quantity
Primary cooling system.	31.7 qt (30 L)
Secondary cooling system.	8.1 qt (7.7 L)

### Materials

Name	Specification
Motorcraft® Yellow Prediluted Antifreeze/Coolant (U.S.) Motorcraft® Yellow Prediluted Antifreeze/Coolant / Antigel/liquide de refroidissement prédilué jaune Motorcraft® (Canada) VC-13DL-G (U.S.) CVC-13DL-G (Canada)	WSS-M97B57-A2

## COOLING SYSTEM CAPACITY AND SPECIFICATION - 7.3L

Use coolant that meets the defined specification.

If you do not use coolant that meets the defined specification, it could result in:

- Component damage that your vehicle warranty does not cover.
- Reduced vehicle performance.

### Capacities

Variant	Quantity
All.	22.5 qt (21.3 L)

# Capacities and Specifications

## Materials

Name	Specification
Motorcraft® Yellow Prediluted Antifreeze/ Coolant (U.S.) Motorcraft® Yellow Prediluted Antifreeze/Coolant / Antigel/liquide de refroidissement prédilué jaune Motorcraft® (Canada) VC-13DL-G (U.S.) CVC-13DL-G (Canada)	WSS-M97B57-A2

## FUEL TANK CAPACITY - DIESEL

### Capacities

Variant	Quantity
Complete vehicle-142 inch and 148 inch wheelbase, middle location.	29.0 gal (109.8 L)
Complete vehicle-160 inch and 164 inch wheelbase, middle location.	34.0 gal (128.7 L)
Complete vehicle-176 inch wheelbase, middle location.	48.0 gal (181.7 L)
Incomplete vehicle, middle location.	26.5 gal (100.3 L)
Incomplete vehicle, aft- axle -location.	40.0 gal (151.4 L)
Incomplete vehicle, middle and aft- axle - locations.	66.5 gal (251.7 L)

# Capacities and Specifications

---

## FUEL TANK CAPACITY - GASOLINE

### Capacities

Variant	Quantity
Complete vehicle-all except 176 inch wheelbase and incomplete vehicles.	34.0 gal (128.7 L)
Complete vehicle-176 inch wheelbase.	48.0 gal (181.7 L)
Incomplete vehicle, aft- axle -location.	40.0 gal (151.4 L)
Incomplete vehicle, middle location.	26.5 gal (100.3 L)

# Capacities and Specifications

## AIR CONDITIONING SYSTEM CAPACITY AND SPECIFICATION - 6.2L



**WARNING:** The air conditioning refrigerant system contains refrigerant under high pressure. Only qualified personnel should service the air conditioning refrigerant system. Opening

the air conditioning refrigerant system can cause personal injury.

Use refrigerant and oil that meets the defined specifications.

If you do not use refrigerant and oil that meets the defined specifications, it could result in:

- Component damage that your vehicle warranty does not cover.
- Reduced vehicle performance.

### Capacities

Variant	Refrigerant	Refrigerant Oil
With six-speed automatic transmission.	27 oz (0.765 kg)	4.1 fl oz (120 ml)
With ten-speed automatic transmission.	27 oz (0.765 kg)	3.7 fl oz (110 ml)

### Materials

Name	Specification
Motorcraft® R-134a Refrigerant(U.S.) R-134a Refrigerant / Frigorigène R-134a(Canada) YN-19(U.S.) CYN-19-R(Canada)	WSH-M17B19-A
Motorcraft® PAG Refrigerant Compressor Oil(U.S.) Motorcraft® PAG Refrigerant Compressor Oil / Huile PAG pour compresseur frigorifique Motor- craft®(Canada) YN-12-D(U.S. & Canada)	WSH-M1C231-B

# Capacities and Specifications

## AIR CONDITIONING SYSTEM CAPACITY AND SPECIFICATION - 6.7L DIESEL



**WARNING:** The air conditioning refrigerant system contains refrigerant under high pressure. Only qualified personnel should service the air conditioning refrigerant system. Opening

the air conditioning refrigerant system can cause personal injury.

Use refrigerant and oil that meets the defined specifications.

If you do not use refrigerant and oil that meets the defined specifications, it could result in:

- Component damage that your vehicle warranty does not cover.
- Reduced vehicle performance.

### Capacities

Variant	Refrigerant	Refrigerant Oil
All.	27 oz (0.765 kg)	3.7 fl oz (110 ml)

### Materials

Name	Specification
Motorcraft® R-134a Refrigerant(U.S.) R-134a Refrigerant / Frigorigène R-134a(Canada) YN-19(U.S.) CYN-19-R(Canada)	WSH-M17B19-A
Motorcraft® PAG Refrigerant Compressor Oil(U.S.) Motorcraft® PAG Refrigerant Compressor Oil / Huile PAG pour compresseur frigorifique Motor- craft®(Canada) YN-12-D(U.S. & Canada)	WSH-M1C231-B

# Capacities and Specifications

## AIR CONDITIONING SYSTEM CAPACITY AND SPECIFICATION - 7.3L



**WARNING:** The air conditioning refrigerant system contains refrigerant under high pressure. Only qualified personnel should service the air conditioning refrigerant system. Opening

the air conditioning refrigerant system can cause personal injury.

Use refrigerant and oil that meets the defined specifications.

If you do not use refrigerant and oil that meets the defined specifications, it could result in:

- Component damage that your vehicle warranty does not cover.
- Reduced vehicle performance.

### Capacities

Variant	Refrigerant	Refrigerant Oil
All.	27 oz (0.765 kg)	3.7 fl oz (110 ml)

### Materials

Name	Specification
Motorcraft® R-134a Refrigerant(U.S.) R-134a Refrigerant / Frigorigène R-134a(Canada) YN-19(U.S.) CYN-19-R(Canada)	WSH-M17B19-A
Motorcraft® PAG Refrigerant Compressor Oil(U.S.) Motorcraft® PAG Refrigerant Compressor Oil / Huile PAG pour compresseur frigorifique Motor- craft®(Canada) YN-12-D(U.S. & Canada)	WSH-MIC231-B

## WASHER FLUID SPECIFICATION

### Capacities

Variant	Quantity
All.	Fill as required.



# Capacities and Specifications

## Materials

Name	Specification
Motorcraft® Premium Windshield Wash Concentrate with Bitterant(U.S.) Motorcraft® Premium Quality Windshield Washer Fluid / Liquide lave-glace de haute qualité Motorcraft®(Canada) ZC-32-B2(U.S.) CXC-37-F/M(Canada)	WSS-M14P19-A

## DIESEL EXHAUST FLUID CAPACITY AND SPECIFICATION

Use fluid that meets the defined specification.

### Capacities

Variant	Quantity
Complete vehicle.	7.4 gal (28 L)
Incomplete vehicle.	7.2 gal (27.3 L)

## Materials

Name	Specification
Motorcraft® Diesel Exhaust Fluid(U.S.) Motorcraft® Diesel Exhaust Fluid / Fluide pour échappement diesel Motorcraft®(Canada) PM-27-GAL,PM-27-JUG(U.S.) CPM-27-J(Canada)	WSS-M99C130-A

If you do not use fluid that meets the defined specification, it could result in:

- Component damage that your vehicle warranty does not cover.
- Reduced vehicle performance.

# Capacities and Specifications

## AUTOMATIC TRANSMISSION FLUID CAPACITY AND SPECIFICATION - DIESEL

Use fluid that meets the defined specification.

If you do not use fluid that meets the defined specification, it could result in:

- Component damage that your vehicle warranty does not cover.
- Reduced vehicle performance.

**Note:** Only use MERCON ULV transmission fluid for automatic transmissions that require MERCON ULV transmission fluid. The use of any other fluid could cause transmission damage.

### Capacities

Variant	Quantity
All.	18.1 qt (17.1 L) <sup>1</sup>

<sup>1</sup> Approximate dry fill capacity. Actual amount could vary during fluid changes.

### Materials

Name	Specification
Motorcraft® MERCON® ULV Automatic Transmission Fluid (U.S.) Motorcraft® MERCON® ULV Automatic Transmission Fluid / MERCON® ULV huile pour boîtes automatique Motorcraft® (Canada) XT-12-QULV (U.S. & Canada)	WSS-M2C949-A, MERCON® ULV

## AUTOMATIC TRANSMISSION FLUID CAPACITY AND SPECIFICATION - GASOLINE

Use fluid that meets the defined specification.

If you do not use fluid that meets the defined specification, it could result in:

- Component damage that your vehicle warranty does not cover.
- Reduced vehicle performance.

### Six-Speed Automatic Transmission

**Note:** Only use MERCON LV transmission fluid for automatic transmissions that require MERCON LV transmission fluid. The use of any other fluid could cause transmission damage.

# Capacities and Specifications

## Capacities

Variant	Quantity
6.2L.	13.9 qt (13.2 L) <sup>1</sup>

<sup>1</sup> Approximate dry fill capacity. Actual amount could vary during fluid changes.

## Materials

Name	Specification
Motorcraft® MERCON® LV Automatic Transmission Fluid (U.S.) Motorcraft® MERCON® LV Automatic Transmission Fluid / Huile pour boîte automatique MERCON® LV Motorcraft® (Canada) XT-10-QLVC (U.S.) CXT-10-LV6 (Canada)	WSS-M2C938-AMERCON® LV,

## Ten-Speed Automatic Transmission

**Note:** Only use MERCON ULV transmission fluid for automatic transmissions that require MERCON ULV transmission fluid. The use of any other fluid could cause transmission damage.

## Capacities

Variant	Quantity
6.2L.	18.2 qt (17.2 L) <sup>1</sup>
7.3L .	18.2 qt (17.2 L) <sup>1</sup>

<sup>1</sup> Approximate dry fill capacity. Actual amount could vary during fluid changes.

# Capacities and Specifications

## Materials

Name	Specification
Motorcraft® MERCON® ULV Automatic Transmission Fluid (U.S.) Motorcraft® MERCON® ULV Automatic Transmission Fluid / MERCON® ULV huile pour boîtes automatique Motorcraft® (Canada) XT-12-QULV (U.S. & Canada)	WSS-M2C949-A, MERCON® ULV

## BRAKE FLUID SPECIFICATION

Use fluid that meets the defined specification and viscosity grade.

If you do not use fluid that meets the defined specification and viscosity grade, it could result in:

- Component damage that your vehicle warranty does not cover.
- Reduced brake performance.

**Note:** We recommend you use Dot 4 Low Viscosity (LV) High Performance Brake Fluid meeting WSS-M6C65-A2 specifications or ISO 4925 Class 6 standards. If you use any fluid other than the recommended fluid, it could cause reduced brake performance and not meet our performance standards. Keep brake fluid clean and dry. Contamination with dirt, water, petroleum products or other materials could result in brake system damage and possible failure.

## Capacities

Variant	Quantity
All.	Fill as required.

## Materials

Name	Specification
Motorcraft® DOT 4 LV High Performance Motor Vehicle Brake Fluid (U.S.) Motorcraft® DOT 4 LV High Performance Motor Vehicle Brake Fluid / Liquide de frein automobile haute performance DOT 4 LV Motorcraft® (Canada) PM-20 (U.S. & Canada)	WSS-M6C65-A2

# Capacities and Specifications

## TRANSFER CASE FLUID CAPACITY AND SPECIFICATION

Use fluid that meets the defined specification.

If you do not use fluid that meets the defined specification, it could result in:

- Component damage that your vehicle warranty does not cover.
- Reduced vehicle performance.

### Capacities

Variant	Quantity
All.	1.9 qt (1.8 L)

### Materials

Name	Specification
Motorcraft® MERCON® LV Automatic Transmission Fluid(U.S.) Motorcraft® MERCON® LV Automatic Transmission Fluid / Huile pour boîte automatique MERCON® LV Motorcraft®(Canada) XT-10-QLVC(U.S.) CXT-10-LV6(Canada)	WSS-M2C938-AMERCON® LV,

## FRONT AXLE FLUID CAPACITY AND SPECIFICATION

Use fluid that meets the defined specification and viscosity grade.

If you do not use fluid that meets the defined specification and viscosity grade, it could result in:

- Component damage that your vehicle warranty does not cover.
- Reduced vehicle performance.

### Capacities

Variant	Quantity
Four-wheel drive without limited slip.	2.75 qt (2.6 L)
Four-wheel drive with limited slip.	2.75 qt (2.6 L) <sup>1</sup>

<sup>1</sup>For complete refill of limited slip axles, add 5.4 fl oz. (160 ml) of Additive Friction Modifier XL-3 or equivalent, meeting specification EST-M2C118-A. Include this friction modifier in the total lube volume of 2.75 qt (2.6 L).

# Capacities and Specifications

## Materials

Name	Specification
Motorcraft® Additive Friction Modifier(U.S.) Motorcraft® Additive Friction Modifier / Additif modificateur de friction Motorcraft®(Canada) XL-3(U.S.) CXL-3(Canada)	EST-M2C118-A
Motorcraft® SAE 80W-90 Premium Rear Axle Lubricant(U.S.) Motorcraft® SAE 80W-90 Premium Axle Lubricant / Lubrifiant pour essieux de très haute qualité SAE 80W-90 Motorcraft®(Canada) XY-80W90-QL(U.S.) CXY-80W90-1L(Canada)	WSP-M2C197-A

## REAR AXLE FLUID CAPACITY AND SPECIFICATION - DIESEL

Use fluid that meets the defined specification and viscosity grade.

If you do not use fluid that meets the defined specification and viscosity grade, it could result in:

- Component damage that your vehicle warranty does not cover.
- Reduced vehicle performance.

## Rear Axle - 10.5

### Capacities

Variant	Quantity
With Electronic Locking Differential.	3.3–3.5 qt (3.1–3.3 L)
Without Electronic Locking Differential.	3.5–3.6 qt (3.3–3.4 L)

## Materials

Name	Specification
Motorcraft® SAE 75W-85 Premium Synthetic Hypoid Gear Lubricant(U.S.) Motorcraft® SAE 75W-85 Premium Synthetic Hypoid Gear Lubricant / Huile synthétique de haute qualité pour engrenages hypoides SAE 75W-85 Motorcraft®(Canada) XY-75W85-QL(U.S. & Canada)	WSS-M2C942-A

# Capacities and Specifications

## Rear Axle - 10.8

### Capacities

Variant	Quantity
All.	3.6 qt (3.42 L)

### Materials

Name	Specification
Motorcraft® SAE 75W-140 Synthetic Rear Axle Lubricant(U.S.) Motorcraft® SAE 75W-140 Synthetic Rear Axle Lubricant / Lubrifiant synthétique pour pont arrière SAE 75W-140 Motorcraft®(Canada) XY-75W140-QL(U.S.) CXY-75W140-1L(Canada)	WSL-M2C192-A

## Rear Axle - 11.8

### Capacities

Variant	Quantity
All.	3.78 qt (3.58 L) <sup>1</sup>

<sup>1</sup>For complete refill of limited slip axles, add 7.1 fl oz. (210 ml) of Additive Friction Modifier XL-3 or equivalent, meeting Ford Specification EST-M2C118-A. Include this friction modifier in the total lube volume of 3.78 qt (3.58 L).

# Capacities and Specifications

## Materials

Name	Specification
Motorcraft® Additive Friction Modifier(U.S.) Motorcraft® Additive Friction Modifier / Additif modificateur de friction Motorcraft®(Canada) XL-3(U.S.) CXL-3(Canada)	EST-M2C118-A
Motorcraft® SAE 75W-140 Synthetic Rear Axle Lubricant(U.S.) Motorcraft® SAE 75W-140 Synthetic Rear Axle Lubricant / Lubrifiant synthétique pour pont arrière SAE 75W-140 Motorcraft®(Canada) XY-75W140-QL(U.S.) CXY-75W140-1L(Canada)	WSL-M2C192-A

## REAR AXLE FLUID CAPACITY AND SPECIFICATION - GASOLINE

Use fluid that meets the defined specification and viscosity grade.

### Rear Axle - 10.5

#### Capacities

Variant	Quantity
With Electronic Locking Differential.	3.3–3.5 qt (3.1–3.3 L)
Without Electronic Locking Differential.	3.5–3.6 qt (3.3–3.4 L)

If you do not use fluid that meets the defined specification and viscosity grade, it could result in:

- Component damage that your vehicle warranty does not cover.
- Reduced vehicle performance.



# Capacities and Specifications

## Materials

Name	Specification
Motorcraft® SAE 75W-85 Premium Synthetic Hypoid Gear Lubricant (U.S.) Motorcraft® SAE 75W-85 Premium Synthetic Hypoid Gear Lubricant / Huile synthétique de haute qualité pour engrenages hypoides SAE 75W-85 Motorcraft® (Canada) XY-75W85-QL (U.S. & Canada)	WSS-M2C942-A

## Rear Axle - 10.8

### Capacities

Variant	Quantity
7.3L.	3.6 qt (3.42 L)

## Materials

Name	Specification
Motorcraft® SAE 75W-140 Synthetic Rear Axle Lubricant (U.S.) Motorcraft® SAE 75W-140 Synthetic Rear Axle Lubricant / Lubrifiant synthétique pour pont arrière SAE 75W-140 Motorcraft® (Canada) XY-75W140-QL (U.S.) CXY-75W140-1L (Canada)	WSL-M2C192-A

## Rear Axle - 11.8

### Capacities

Variant	Quantity
All.	3.78 qt (3.58 L) <sup>1</sup>

<sup>1</sup> For complete refill of limited slip axles, add 7.1 fl. oz. (210 ml) of Additive Friction Modifier XL-3 or equivalent, meeting Ford Specification EST-M2C118-A. Include this friction modifier in the total lube volume of 3.78 qt (3.58 L).

# Capacities and Specifications

## Materials

Name	Specification
Motorcraft® Additive Friction Modifier(U.S.) Motorcraft® Additive Friction Modifier / Additif modificateur de friction Motorcraft®(Canada) XL-3(U.S.) CXL-3(Canada)	EST-M2C118-A
Motorcraft® SAE 80W-90 Premium Rear Axle Lubricant(U.S.) Motorcraft® SAE 80W-90 Premium Axle Lubricant / Lubrifiant pour essieux de très haute qualité SAE 80W-90 Motorcraft®(Canada) XY-80W90-QL(U.S.) CXY-80W90-1L(Canada)	WSP-M2C197-A

## Rear Axle - 11.8 (With Heavy Duty Tow Option)

### Capacities

Variant	Quantity
7.3L.	3.78 qt (3.58 L) <sup>1</sup>

<sup>1</sup> For complete refill of limited slip axles, add 7.1 fl. oz. (210 ml) of Additive Friction Modifier XL-3 or equivalent, meeting specification EST-M2C118-A. Include this friction modifier in the total lube volume of 3.78 qt (3.58 L).

## Materials

Name	Specification
Motorcraft® Additive Friction Modifier(U.S.) Motorcraft® Additive Friction Modifier / Additif modificateur de friction Motorcraft®(Canada) XL-3(U.S.) CXL-3(Canada)	EST-M2C118-A
Motorcraft® SAE 75W-140 Synthetic Rear Axle Lubricant(U.S.) Motorcraft® SAE 75W-140 Synthetic Rear Axle Lubricant / Lubrifiant synthétique pour pont arrière SAE 75W-140 Motorcraft®(Canada) XY-75W140-QL(U.S.) CXY-75W140-1L(Canada)	WSL-M2C192-A

# Capacities and Specifications

## HYDRAULIC POWER STEERING FLUID CAPACITY AND SPECIFICATION

Use fluid that meets the defined specification.

If you do not use fluid that meets the defined specification, it could result in:

- Component damage that your vehicle warranty does not cover.
- Reduced vehicle performance.

### Capacities

Variant	Quantity
All.	Fill as required.

### Materials

Name	Specification
Motorcraft® MERCON® LV Automatic Transmission Fluid(U.S.) Motorcraft® MERCON® LV Automatic Transmission Fluid / Huile pour boîte automatique MERCON® LV Motorcraft®(Canada) XT-10-QLVC(U.S.) CXT-10-LV6(Canada)	WSS-M2C938-AMERCON® LV,

# Vehicle Identification

## VEHICLE IDENTIFICATION NUMBER

### LOCATING THE VEHICLE IDENTIFICATION NUMBER

The vehicle identification number is on the left-hand side of the instrument panel.

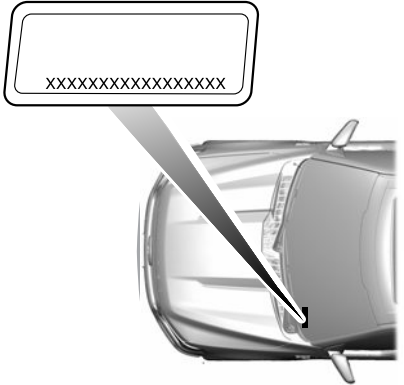

**Note:** In the illustration, XXXX is representative of your vehicle identification number.

### VEHICLE IDENTIFICATION NUMBER OVERVIEW

The vehicle identification number contains the following information:

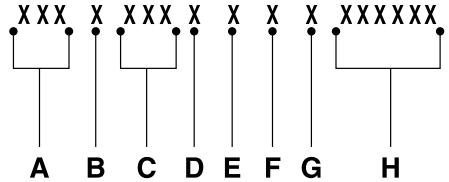

- A World manufacturer identifier.
- B Brake system, gross vehicle weight rating, restraint devices and their locations.
- C Make, vehicle line, series, body type.
- D Engine or motor type.
- E Check digit.
- F Model year.
- G Assembly plant.
- H Production sequence number.

# Connected Vehicle - Vehicles With: SYNC 3

## WHAT IS A CONNECTED VEHICLE

A connected vehicle has technology that allows your vehicle to connect to a mobile network and for you to access a range of features. When used in conjunction with the FordPass app, it could allow you to monitor and control your vehicle further, for example checking the tire pressures, the fuel level and the vehicle location. For additional information, refer to the local Ford website.

## CONNECTED VEHICLE REQUIREMENTS

Connected service and related feature functionality requires a compatible vehicle network.

Some remote features require additional service activation. Log in to your Ford account for details. Some restrictions, third party terms and message or data rates may apply.

## CONNECTED VEHICLE LIMITATIONS

Evolving technology, cellular networks, or regulations could affect functionality and availability, or continued provision of some features. These changes could even stop some features from functioning.

## CONNECTING THE VEHICLE TO A MOBILE NETWORK

### WHAT IS THE MODEM



The modem allows access to a range of features built into your vehicle.

## ENABLING AND DISABLING THE MODEM - VEHICLES WITH: MODEM

1. Press **Settings**.
2. Press **FordPass Connect**.
3. Press **Connectivity Settings**.
4. Switch connectivity features on or off.

## ENABLING AND DISABLING THE MODEM - VEHICLES WITH: SYNC 3

1. Select **Settings**.
2. Select **Connectivity Features**.
3. Select **Data sharing**.
4. Switch connectivity features on or off.

## CONNECTING FORDPASS TO THE MODEM

1. Make sure that the modem is enabled using the vehicle settings menu.
2. Open the FordPass app on your device and log in.
3. Add your vehicle or select your vehicle if already added.
4. Select the option for vehicle details.
5. Select the option to activate your vehicle.
6. Make sure that the name on the screen matches the name shown in your FordPass account.
7. Confirm that FordPass account is connected to the modem.

## CONNECTING THE VEHICLE TO A WI-FI NETWORK

1. Press **Settings**.
2. Press **Wi-Fi**.

## Connected Vehicle - Vehicles With: SYNC 3

---

3. Switch **Wi-Fi** on.

4. Press **View Available Networks**.

5. Select an available Wi-Fi network.

**Note:** *Enter the network password to connect to a secure network.*

## CONNECTED VEHICLE – TROUBLESHOOTING - VEHICLES WITH: MODEM

Symptom	Possible Cause and Resolution
I cannot confirm the connection of my FordPass account to the modem.	<ul style="list-style-type: none"><li>- Modem is not enabled.<ul style="list-style-type: none"><li>• Switch connectivity features on.</li></ul></li><li>- Weak network signal.<ul style="list-style-type: none"><li>• Move your vehicle closer to a place where the network signal is not obstructed.</li></ul></li></ul>

## Connected Vehicle - Vehicles With: SYNC 3

### CONNECTED VEHICLE – TROUBLESHOOTING - VEHICLES WITH: SYNC 3

Symptom	Possible Cause and Resolution
I cannot connect to a Wi-Fi network.	<ul style="list-style-type: none"> <li>– Password error.                             <ul style="list-style-type: none"> <li>• Enter the correct network password.</li> </ul> </li> <li>– Weak network signal.                             <ul style="list-style-type: none"> <li>• Move your vehicle closer to the Wi-Fi hotspot or to a place where the network signal is not obstructed.</li> </ul> </li> <li>– Multiple access points in range with the same SSID.                             <ul style="list-style-type: none"> <li>• Use a unique name for your SSID. Do not use the default name unless it contains a unique identifier, for example as part of the MAC address.</li> </ul> </li> </ul>
The Wi-Fi connection disconnects after successful connection.	<ul style="list-style-type: none"> <li>– Weak network signal.                             <ul style="list-style-type: none"> <li>• Move your vehicle closer to the Wi-Fi hotspot or to a place where the network signal is not obstructed.</li> </ul> </li> </ul>
I am close to a Wi-Fi hotspot but the network signal strength is weak.	<ul style="list-style-type: none"> <li>– Obstructed network signal.                             <ul style="list-style-type: none"> <li>• If your vehicle has a heated windshield, position your vehicle so that the windshield is not facing the Wi-Fi hotspot.</li> <li>• If your vehicle has metallic tinting on the windows but not on the windshield, position your vehicle so that the windshield is facing the Wi-Fi hotspot or open the windows that are facing the hotspot.</li> <li>• If your vehicle has metallic tinting on the windows and the windshield, open the windows that are facing the hotspot.</li> <li>• If your vehicle is in a garage and you have the garage door closed, open the garage door.</li> </ul> </li> </ul>
I cannot see a network in the list of available networks that I expect to see.	<ul style="list-style-type: none"> <li>– Hidden network.                             <ul style="list-style-type: none"> <li>• Make the network visible and try again.</li> </ul> </li> </ul>

## Connected Vehicle - Vehicles With: SYNC 3

<b>Symptom</b>	<b>Possible Cause and Resolution</b>
I cannot see the Wi-Fi hotspot name when I search for Wi-Fi networks on my cell phone or other device.	<ul style="list-style-type: none"> <li>– System limitation.                             <ul style="list-style-type: none"> <li>• Make sure Wi-Fi hotspot visibility is on.</li> <li>• The system does not provide a Wi-Fi hotspot at this time.</li> </ul> </li> </ul>
Software downloads take too long.	<ul style="list-style-type: none"> <li>– Weak network signal.                             <ul style="list-style-type: none"> <li>• Move your vehicle closer to the Wi-Fi hotspot or to a place where the network signal is not obstructed.</li> </ul> </li> <li>– Wi-Fi hotspot in high demand or has a slow Internet connection.                             <ul style="list-style-type: none"> <li>• Use a more reliable Wi-Fi hotspot.</li> </ul> </li> </ul>
The system seems to connect to a Wi-Fi network and the signal strength is excellent but the software does not update.	<ul style="list-style-type: none"> <li>– No software update available.</li> <li>– Wi-Fi network requires a subscription or acceptance of terms and conditions.                             <ul style="list-style-type: none"> <li>• Test the connection using another device. If the network requires a subscription or acceptance of terms and conditions, contact the network service provider.</li> </ul> </li> </ul>



# Connected Vehicle - Vehicles With: SYNC 4

## WHAT IS A CONNECTED VEHICLE

A connected vehicle has technology that allows your vehicle to connect to a mobile network and for you to access a range of features. When used in conjunction with the FordPass app, it could allow you to monitor and control your vehicle further, for example checking the tire pressures, the fuel level and the vehicle location. For additional information, refer to the local Ford website.

## CONNECTED VEHICLE REQUIREMENTS

Connected service and related feature functionality requires a compatible vehicle network.

Some remote features require additional service activation. Log in to your Ford account for details. Some restrictions, third party terms and message or data rates may apply.

## CONNECTED VEHICLE LIMITATIONS

Evolving technology, cellular networks, or regulations could affect functionality and availability, or continued provision of some features. These changes could even stop some features from functioning.

## CONNECTING THE VEHICLE TO A MOBILE NETWORK

### WHAT IS THE MODEM



The modem allows access to a range of features built into your vehicle.

## ENABLING AND DISABLING THE MODEM

1. Press **Settings**.
2. Press **Connectivity**.
3. Press **Connected Vehicle Features**.
4. Switch vehicle connectivity on or off.

## CONNECTING FORDPASS TO THE MODEM

1. Make sure that the modem is enabled using the vehicle settings menu.
2. Open the FordPass app on your device and log in.
3. Add your vehicle or select your vehicle if already added.
4. Select the option for vehicle details.
5. Select the option to activate your vehicle.
6. Make sure that the name on the screen matches the name shown in your FordPass account.
7. Confirm that FordPass account is connected to the modem.

## CONNECTING THE VEHICLE TO A WI-FI NETWORK



Select the settings option on the feature bar.

1. Press **Connectivity**.
2. Press **Manage Wi-Fi Networks**.
3. Switch **Wi-Fi** on.
4. Press **View Available Networks**.
5. Select an available Wi-Fi network.

**Note:** Enter the network password to connect to a secure network.

# Connected Vehicle - Vehicles With: SYNC 4

---

## CONNECTED VEHICLE – TROUBLESHOOTING

### CONNECTED VEHICLE – FREQUENTLY ASKED QUESTIONS

Symptom	Possible Cause and Resolution
I cannot confirm the connection of my FordPass account to the modem.	<ul style="list-style-type: none"><li>- Modem is not enabled.<ul style="list-style-type: none"><li>• Switch vehicle connectivity on.</li></ul></li><li>- Weak network signal.<ul style="list-style-type: none"><li>• Move your vehicle closer to a place where the network signal is not obstructed.</li></ul></li></ul>

## Connected Vehicle - Vehicles With: SYNC 4

### CONNECTED VEHICLE – FREQUENTLY ASKED QUESTIONS

Symptom	Possible Cause and Resolution
I cannot connect to a Wi-Fi network.	<ul style="list-style-type: none"> <li>– Password error.               <ul style="list-style-type: none"> <li>• Enter the correct network password.</li> </ul> </li> <li>– Weak network signal.               <ul style="list-style-type: none"> <li>• Move your vehicle closer to the Wi-Fi router or to a place where the network signal is not obstructed.</li> </ul> </li> <li>– Multiple access points in range with the same network name.               <ul style="list-style-type: none"> <li>• Use a unique name for your network name. Do not use the default name unless it contains a unique identifier, for example as part of the MAC address.</li> </ul> </li> </ul>
The Wi-Fi connection disconnects after successful connection.	<ul style="list-style-type: none"> <li>– Weak network signal.               <ul style="list-style-type: none"> <li>• Move your vehicle closer to the Wi-Fi router or to a place where the network signal is not obstructed.</li> </ul> </li> </ul>
I am close to a Wi-Fi router but the network signal strength is weak.	<ul style="list-style-type: none"> <li>– Obstructed network signal.               <ul style="list-style-type: none"> <li>• If your vehicle has a heated windshield, position your vehicle so that the windshield is not facing the Wi-Fi router.</li> <li>• If your vehicle has metallic tinting on the windows but not on the windshield, position your vehicle so that the windshield is facing the Wi-Fi router or open the windows that are facing the router.</li> <li>• If your vehicle has metallic tinting on the windows and the windshield, open the windows that are facing the router.</li> <li>• If your vehicle is in a garage and you have the garage door closed, open the garage door as it may block the signal.</li> </ul> </li> </ul>
I cannot see a network in the list of available networks that I expect to see.	<ul style="list-style-type: none"> <li>– Hidden network.               <ul style="list-style-type: none"> <li>• Make the network visible and try again, or use the Add Network Manually option in Wi-Fi settings menu.</li> </ul> </li> <li>– Unsupported security type.               <ul style="list-style-type: none"> <li>• Some network security types are not supported, for example WEP.</li> </ul> </li> </ul>

## Connected Vehicle - Vehicles With: SYNC 4

<b>Symptom</b>	<b>Possible Cause and Resolution</b>
I cannot see the Wi-Fi hotspot name when I search for Wi-Fi networks on my cell phone or other device.	<ul style="list-style-type: none"> <li>– System limitation.                             <ul style="list-style-type: none"> <li>• Make sure Wi-Fi hotspot visibility is on.</li> <li>• The system does not provide a Wi-Fi hotspot at this time.</li> </ul> </li> </ul>
Software downloads take too long.	<ul style="list-style-type: none"> <li>– Weak network signal                             <ul style="list-style-type: none"> <li>• Move your vehicle closer to the Wi-Fi router or to a place where the network signal is not obstructed.</li> </ul> </li> <li>– Wi-Fi hotspot in high demand or has a slow Internet connection.                             <ul style="list-style-type: none"> <li>• Use a more reliable Wi-Fi hotspot.</li> </ul> </li> </ul>
The system seems to connect to a Wi-Fi network and the signal strength is excellent but the software does not update.	<ul style="list-style-type: none"> <li>– No software update available.</li> <li>– Wi-Fi network requires a subscription or acceptance of terms and conditions.                             <ul style="list-style-type: none"> <li>• Test the connection using another device. If the network requires a subscription or acceptance of terms and conditions, contact the network service provider.</li> </ul> </li> </ul>

# Vehicle Wi-Fi Hotspot

## CREATING A VEHICLE WI-FI HOTSPOT

You can create a Wi-Fi hotspot in your vehicle and allow devices to connect to it for access to the Internet.



Select the settings option on the feature bar.

1. Press **Vehicle Hotspot**.

**Note:** The vehicle hotspot default setting is on.

2. Press **Settings**.
3. Press **Edit**.
4. Press **Hotspot visibility**.

**Note:** The hotspot visibility default setting is on.

## Finding the Wi-Fi Hotspot Name and Password



Select the settings option on the feature bar.

1. Press **Vehicle Hotspot**.
2. Press **Settings**.

**Note:** The network name is the hotspot name.

3. Press **View Password**.

## Connecting a Device to the Wi-Fi Hotspot

1. On your device, switch Wi-Fi on and select the hotspot from the list of available Wi-Fi networks.
2. When prompted, enter the password.

## Purchasing a Data Plan

1. Connect a device to the hotspot.

**Note:** The vehicle network carrier's portal opens on your device.

2. If the portal does not open on your device, open a website and it redirects to the vehicle network carrier's portal.

**Note:** Secure websites do not redirect.

3. Follow the instructions on the carrier portal to purchase a plan.

**Note:** If you have an active plan, the system does not redirect to the vehicle network carrier's portal when you connect a device. Visit the vehicle network carrier's website to purchase more data.

**Note:** If data usage information is available in the vehicle hotspot menu, it is approximate.

**Note:** If you carry out a master reset, the system does not remove your vehicle from your vehicle network carrier's account. To remove your vehicle from the account, contact your vehicle network carrier.

**Note:** The vehicle network carrier provides Vehicle Hotspot services, subject to your vehicle network carrier agreement, coverage and availability.

## CHANGING THE VEHICLE WI-FI HOTSPOT NAME OR PASSWORD



Select the settings option on the feature bar.

1. Press **Vehicle Hotspot**.
2. Press **Settings**.
3. Press **Edit**.
4. Press **Change Network Name**.
5. Enter your required network name.
6. Press **Done**.
7. Press **Change Password**.
8. Enter your required password.
9. Press **Done**.

# Vehicle Wi-Fi Hotspot

---

## Changing the Wi-Fi Hotspot Frequency

**Note:** *The Vehicle Hotspot frequency band is selectable depending upon your device capabilities. You will be unable to connect your device to the Vehicle Hotspot if it does not support the selected frequency band.*



Select the settings option on the feature bar.

1. Press **Vehicle Hotspot**.
2. Press **Settings**.
3. Press **Edit**.
4. Select a frequency.
5. Press **Done**.

# Audio System - Vehicles With: SYNC

## GENERAL INFORMATION



**WARNING:** Driving while distracted can result in loss of vehicle control, crash and injury. We strongly recommend that you use extreme caution when using any device that may take your focus off the road. Your primary responsibility is the safe operation of your vehicle. We recommend against the use of any

hand-held device while driving and encourage the use of voice-operated systems when possible. Make sure you are aware of all applicable local laws that may affect the use of electronic devices while driving.

## Radio Frequencies and Reception Factors

**Note:** *Listening to loud audio for long periods of time could damage your hearing.*

### Radio Reception Factors

<b>Distance and strength</b>	The further you travel from an AM or FM station, the weaker the signal and the weaker the reception.
<b>Terrain</b>	Hills, mountains, tall buildings, bridges, tunnels, freeway overpasses, parking garages, dense tree foliage and thunderstorms can interfere with the reception.
<b>Station overload</b>	When you pass a ground-based broadcast repeating tower, a stronger signal may overtake a weaker one and result in the audio system muting.

## AUDIO UNIT



**WARNING:** Driving while distracted can result in loss of vehicle control, crash and injury. We strongly recommend that you use extreme caution when using any device that may take your focus off the road. Your primary responsibility is the safe operation of your vehicle. We recommend against the use of any hand-held device while driving and encourage the use of voice-operated systems when possible. Make sure you are aware of all applicable local laws that may affect the use of electronic devices while driving.



**Note:** *Depending on your vehicle option package, the controls may look different from what you see here.*

# Audio System - Vehicles With: SYNC

**Note:** Some features, such as satellite radio, may not be available in your location. Check with an authorized dealer.

## Accessing the Apps Menu



Press and release the button to access the apps menu. Follow the on-screen prompts to make your selection.

## Accessing the Clock Settings



Press and release the button to access the clock setting.

Use the center arrow controls to change the hours and minutes.

## Accessing the Media Source Menu



Press and release the button to open the media source menu.

You can press this multiple times to change to a SYNC-Media device or scroll through the media sources using the arrow buttons. Press **OK** to select a source.

## Accessing the Phone Features



Press and release the button to access the phone features of the SYNC system.

## Accessing the Sound Settings



Press and release the button to access settings for Treble, Midrange, Bass, Fade and Balance.

## Accessing the Settings Menu



Press and release the button to access the settings menu.

Follow the on-screen prompts to make your selection.

## Adjusting the Volume

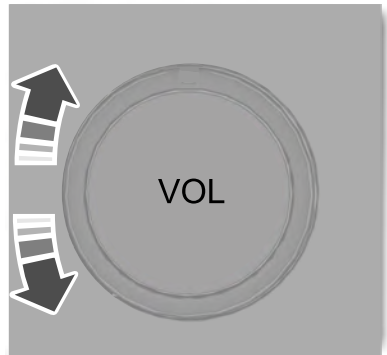

Turn to adjust the volume.

## Changing Radio Stations

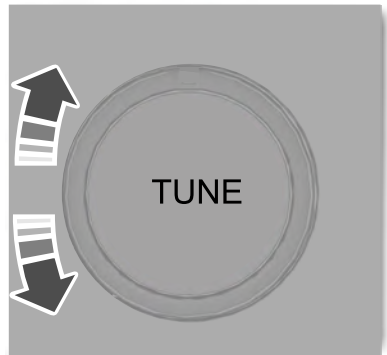

In radio mode, turn to search through the radio frequency band.

In satellite radio mode, turn to find the previous or next available satellite radio station.



# Audio System - Vehicles With: SYNC

## Listening to the Radio

 Press and release the button to listen to the radio or change radio stations.

## Playing or Pausing Media

 Press and release the button to either play or pause current media source.

## Switching the Audio Unit On and Off

 Press and release the button.

## Switching the Display On and Off

 Press and release the button.

## Switching Radio Text On and Off

 Press and release the button to display extra information, for example, artist name.

**Note:** *Extra information may not always be available.*

## Switching Repeat Mode On and Off

 Press and release the button to repeat the current media source.

## Switching Shuffle Mode On and Off

 Press and release the button to shuffle the current media source.

## Using the Display Control

Use the up and down arrow buttons to select the various settings. When you make your selection, press the left and right arrow buttons to change the settings.

 Press and release to confirm a selection.

Press and release the function buttons below the display to select different functions of the audio system depending on which mode you are in.

## Using the Number Block

In radio mode, store and recall your favorite radio stations. To store a favorite station, press and hold until the sound returns. In phone mode, enter a phone number.

## Using Seek, Fast Forward and Reverse



In radio mode, select a frequency band and press and release either button. The system stops at the first station it finds in that direction.

In satellite radio mode, press and release to select the next or previous satellite radio station. If you select a specific category, such as jazz, rock or news, press to find the next or previous station in that category.

## DIGITAL RADIO

**Note:** *HD Radio broadcasts are not available in all markets.*

## Audio System - Vehicles With: SYNC

---

HD Radio technology is the digital evolution of analog AM/FM radio. Your system has a special receiver that allows it to receive digital broadcasts, where available, in addition to the analog broadcasts, it already receives. Digital broadcasts provide a better sound quality than analog broadcasts with free, crystal-clear audio and no static or distortion. For more information, and a guide to available stations and programming, please visit [www.hdradio.com](http://www.hdradio.com).

When HD Radio is on and you tune to a station broadcasting HD Radio technology, you may notice the HD Radio logo on your screen. When this logo is available, you may also see Title and Artist fields on-screen.

The multicast indicator appears in FM mode, only, if the current station is broadcasting multiple digital broadcasts. The highlighted numbers signify available digital channels where new or different content is available. HD1 signifies the main programming status and is available in analog and digital broadcasts. Other multicast stations, HD2 through HD7, are only available digitally.

When HD Radio broadcasts are active, you can access the following functions:

- **Memory presets** allow you to save an active channel as a memory preset. Touch and hold a memory preset slot until the sound returns. There is a brief mute while the radio saves the station. Sound returns when finished. When switching to an HD2 or HD3 memory preset, the sound mutes before the digital audio plays, because the system has to reacquire the digital signal.

**Note:** *As with any saved radio station, you cannot access the saved station if your vehicle is outside the station's reception area.*

# Audio System - Vehicles With: SYNC

## HD Radio Reception and Station Troubleshooting

<b>Potential reception issues</b>	
Reception area	If you are listening to a multicast station and you are on the fringe of the reception area, the station may mute due to weak signal strength.
	If you are listening to HD1, the system switches back to the analog broadcast until the digital broadcast is available again. However, if you are listening to any of the possible HD2-HD7 multicast channels, the station mutes and stays muted unless it is able to connect to the digital signal again.
Station blending	When the system first receives a station, aside from HD2-HD7 multicast stations, it first plays the station in the analog version. Once the receiver verifies the station is an HD Radio station, it shifts to the digital version. Depending on the station quality, you may hear a slight sound change when the station changes from analog to digital. Blending is the shift from analog to digital sound or digital back to analog sound.

In order to provide the best possible experience, use the contact form to report any station issues found while listening to a station broadcasting with HD Radio technology. Independent entities own and operate each station. These stations are responsible for the accuracy of all audio streams and data fields.

## Audio System - Vehicles With: SYNC

<b>Potential station issues</b>		
<b>Issues</b>	<b>Cause</b>	<b>Action</b>
Echo, stutter, skip or repeat in audio. Increase or decrease in audio volume.	This is poor time alignment by the radio broadcaster.	No action required. This is a broadcast issue.
Sound fading or blending in and out.	The radio is shifting between analog and digital audio.	No action required. The reception issue may clear up as you continue to drive.
There is an audio mute delay when selecting HD2 or HD3, multicast preset or <b>Direct Tune</b> .	The digital multicast is not available until the HD Radio broadcast is decoded. Once decoded, the audio is available.	No action required. This is normal behavior. Wait until the audio is available.
Cannot access HD2 or HD3 multicast channel when recalling a preset or from a direct tune.	The previously stored multicast preset or direct tune is not available in your current reception area.	No action required. The station is not available in your current location.
Text information does not match currently playing audio.	Data service issue by the radio broadcaster.	Fill out the station issue form at website listed below. <sup>1</sup>
There is no text information shown for currently selected frequency.	Data service issue by the radio broadcaster.	Fill out the station issue form at website listed below. <sup>1</sup>

<sup>1</sup> <http://hdradio.com/stations/feedback>

HD Radio Technology manufactured under license from iBiquity Digital Corporation and foreign patents. HD Radio and the HD and HD Radio logos are proprietary trademarks of DTS Ford Motor Company and DTS are not responsible for the content sent using HD Radio technology. Content may be changed, added or deleted at any time at the station owner's discretion.

### SATELLITE RADIO

SiriusXM® Satellite Radio broadcasts a variety of music, news, sports, weather, traffic and entertainment satellite radio channels. For more information and a complete list of SiriusXM satellite radio channels, visit [www.siriusxm.com](http://www.siriusxm.com) in the United States, [www.siriusxm.ca](http://www.siriusxm.ca) in Canada, or call SiriusXM at 1-888-539-7474.

**Note:** *This receiver includes the eCos real-time operating system. eCos is published under the eCos License.*

# Audio System - Vehicles With: SYNC

## Satellite Radio Reception Factors

Potential Satellite Radio Reception Issues	
Antenna obstructions	For optimal reception performance, keep the antenna clear of snow and ice build-up and keep luggage and other material as far away from the antenna as possible.
Terrain	Hills, mountains, tall buildings, bridges, tunnels, freeway overpasses, parking garages, dense tree foliage and thunderstorms can interfere with your reception.
Station overload	When you pass a ground-based broadcast-repeating tower, a stronger signal may overtake a weaker one and the audio system may mute.
Satellite radio signal interference	Your display may show ACQUIRING . . . to indicate the interference and the audio system may mute.

## SiriusXM Satellite Radio Service

**Note:** *SiriusXM reserves the unrestricted right to change, rearrange, add or delete programming including canceling, moving or adding particular channels, and its prices, at any time, with or without notice to you. Neither SiriusXM and its affiliates nor Ford Motor Company and its affiliates will be liable to you or any third party for any such modification, suspension or termination.*



SiriusXM satellite radio is a subscription-based satellite radio service that broadcasts a variety of music, sports, news, weather, traffic and entertainment programming. Your factory-installed SiriusXM satellite radio system includes hardware and a limited subscription term, which begins on the date of sale or lease of your vehicle. See an authorized dealer for availability.

For more information on extended subscription terms (a service fee is required), the online media player and a complete list of SiriusXM satellite radio channels, and other features, please visit [www.siriusxm.com](http://www.siriusxm.com) in the United States, [www.siriusxm.ca](http://www.siriusxm.ca) in Canada, or call SiriusXM at 1-888-539-7474.

## Satellite Radio Electronic Serial Number (ESN)

You need your ESN to activate, modify or track your satellite radio account.

### Locating Your ESN

1. Select SiriusXM as the audio source.
2. Tune to channel 0.

# Audio System - Vehicles With: SYNC

## Troubleshooting

Message	Condition	Action
Acquiring...	Radio requires more than two seconds to produce audio for the selected channel.	No action required. This message should disappear shortly.
Satellite antenna fault SIRIUS system failure	There is an internal module or system failure present.	If this message does not clear shortly, or with an ignition key cycle, your receiver may have a fault. See an authorized dealer for service.
Invalid Channel	The channel is no longer available.	Tune to another channel or choose another preset.
Unsubscribed Channel	Your subscription does not include this channel.	Contact SiriusXM at 1-888-539-7474 to subscribe to the channel, or tune to another channel.
No Signal	The signal is lost from the SiriusXM satellite or SiriusXM tower to your vehicle antenna.	The signal is blocked. When you move into an open area, the signal should return.
Updating...	Update of channel programming in progress.	No action required. The process may take up to three minutes.
Questions? Call 1-888-539-7474	Your satellite service is no longer available.	Contact SiriusXM at 1-888-539-7474 to resolve subscription issues.
None found Check Channel Guide	All the channels in the selected category are either skipped or locked.	Use the channel guide to turn off the Lock or Skip function on that station.
Subscription Updated	SiriusXM has updated the channels available for your vehicle.	No action required.

# Audio System - Vehicles With: SYNC

## USB PORT



**WARNING:** Driving while distracted can result in loss of vehicle control, crash and injury. We strongly recommend that you use extreme caution when using any device that may take your focus off the road. Your primary responsibility is the safe operation of your vehicle. We recommend against the use of any hand-held device while driving and encourage the use of voice-operated systems when possible. Make sure you are aware of all applicable local laws that may affect the use of electronic devices while driving.

## USB A



## USB C



The USB port allows you to plug in media playing devices, memory sticks and charge devices.

**Note:** We recommend using only USB-IF certified cables and adapters. Non-certified cables and adapters may not work.

## Locating the USB Ports

The USB ports may be in the following locations:

- Inside the media bin.
- Inside the center console.
- On the lower instrument panel.

**Note:** The number and type of USB ports may vary depending on your vehicle.

**Note:** Not all USB ports in your vehicle have data transfer capabilities. See **What Is the Power Outlet** (page 182).

# Audio System - Vehicles With: SYNC 3

## GENERAL INFORMATION



**WARNING:** Driving while distracted can result in loss of vehicle control, crash and injury. We strongly recommend that you use extreme caution when using any device that may take your focus off the road. Your primary responsibility is the safe operation of your vehicle. We recommend against the use of any

hand-held device while driving and encourage the use of voice-operated systems when possible. Make sure you are aware of all applicable local laws that may affect the use of electronic devices while driving.

## Radio Frequencies and Reception Factors

**Note:** *Listening to loud audio for long periods of time could damage your hearing.*

### Radio Reception Factors

<b>Distance and strength</b>	The further you travel from an AM or FM station, the weaker the signal and the weaker the reception.
<b>Terrain</b>	Hills, mountains, tall buildings, bridges, tunnels, freeway overpasses, parking garages, dense tree foliage and thunderstorms can interfere with the reception.
<b>Station overload</b>	When you pass a ground-based broadcast repeating tower, a stronger signal may overtake a weaker one and result in the audio system muting.

## AUDIO UNIT



**WARNING:** Driving while distracted can result in loss of vehicle control, crash and injury. We strongly recommend that you use extreme caution when using any device that may take your focus off the road. Your primary responsibility is the safe operation of your vehicle. We recommend against the use of any hand-held device while driving and encourage the use of voice-operated systems when possible. Make sure you are aware of all applicable local laws that may affect the use of electronic devices while driving.



**Note:** *Depending on your vehicle option package, the controls could look different from what you see here.*

**Note:** *Some features, such as satellite radio, may not be available in your location. Check with an authorized dealer.*

**Note:** *The touchscreen system controls most of the audio features.*



# Audio System - Vehicles With: SYNC 3

## Adjusting the Volume

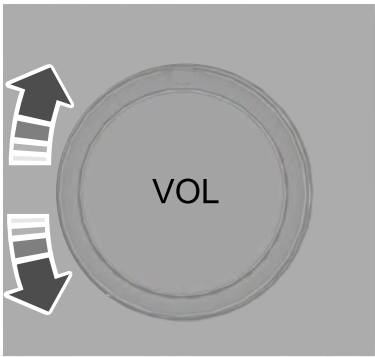

Turn to adjust the volume.

Some vehicles may be able to adjust the volume using buttons on the steering wheel.

## Changing Radio Stations

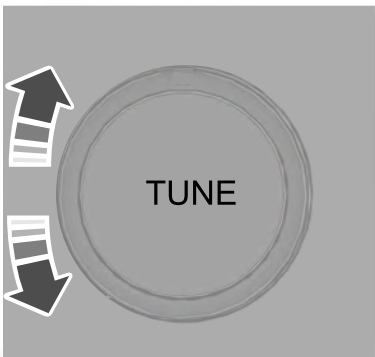

In radio mode, turn to search through the radio frequency band.

In satellite radio mode, turn to find the previous or next available satellite radio station.

## Selecting the Audio Modes

**MEDIA** Press and release the button to access different audio modes, for example AM and FM.

## Setting a Memory Preset

Tune to a station, then press and hold one of the memory preset buttons on the touchscreen. The audio briefly mutes while the system saves the station and returns once the station is stored.

## Switching the Audio Unit On and Off

 Press and release the button.

## Using Seek, Fast Forward and Reverse



In radio mode, select a frequency band and press and release either button. The system stops at the first station it finds in that direction.

In satellite radio mode, press and release to select the next or previous satellite radio station. If you select a specific category, such as jazz, rock or news, press to find the next or previous station in that category.

## DIGITAL RADIO

**Note:** *HD Radio broadcasts are not available in all markets.*

## Audio System - Vehicles With: SYNC 3

---

HD Radio technology is the digital evolution of analog AM/FM radio. Your system has a special receiver that allows it to receive digital broadcasts, where available, in addition to the analog broadcasts, it already receives. Digital broadcasts provide a better sound quality than analog broadcasts with free, crystal-clear audio and no static or distortion. For more information, and a guide to available stations and programming, please visit [www.hdradio.com](http://www.hdradio.com).

When HD Radio is on and you tune to a station broadcasting HD Radio technology, you may notice the HD Radio logo on your screen. When this logo is available, you may also see Title and Artist fields on-screen.

The multicast indicator appears in FM mode, only, if the current station is broadcasting multiple digital broadcasts. The highlighted numbers signify available digital channels where new or different content is available. HD1 signifies the main programming status and is available in analog and digital broadcasts. Other multicast stations, HD2 through HD7, are only available digitally.

When HD Radio broadcasts are active, you can access the following functions:

- **Memory presets** allow you to save an active channel as a memory preset. Touch and hold a memory preset slot until the sound returns. There is a brief mute while the radio saves the station. Sound returns when finished. When switching to an HD2 or HD3 memory preset, the sound mutes before the digital audio plays, because the system has to reacquire the digital signal.

**Note:** *As with any saved radio station, you cannot access the saved station if your vehicle is outside the station's reception area.*

# Audio System - Vehicles With: SYNC 3

## HD Radio Reception and Station Troubleshooting

<b>Potential reception issues</b>	
Reception area	If you are listening to a multicast station and you are on the fringe of the reception area, the station may mute due to weak signal strength.
	If you are listening to HD1, the system switches back to the analog broadcast until the digital broadcast is available again. However, if you are listening to any of the possible HD2-HD7 multicast channels, the station mutes and stays muted unless it is able to connect to the digital signal again.
Station blending	When the system first receives a station, aside from HD2-HD7 multicast stations, it first plays the station in the analog version. Once the receiver verifies the station is an HD Radio station, it shifts to the digital version. Depending on the station quality, you may hear a slight sound change when the station changes from analog to digital. Blending is the shift from analog to digital sound or digital back to analog sound.

In order to provide the best possible experience, use the contact form to report any station issues found while listening to a station broadcasting with HD Radio technology. Independent entities own and operate each station. These stations are responsible for the accuracy of all audio streams and data fields.

## Audio System - Vehicles With: SYNC 3

Potential station issues		
Issues	Cause	Action
Echo, stutter, skip or repeat in audio. Increase or decrease in audio volume.	This is poor time alignment by the radio broadcaster.	No action required. This is a broadcast issue.
Sound fading or blending in and out.	The radio is shifting between analog and digital audio.	No action required. The reception issue may clear up as you continue to drive.
There is an audio mute delay when selecting HD2 or HD3, multicast preset or <b>Direct Tune</b> .	The digital multicast is not available until the HD Radio broadcast is decoded. Once decoded, the audio is available.	No action required. This is normal behavior. Wait until the audio is available.
Cannot access HD2 or HD3 multicast channel when recalling a preset or from a direct tune.	The previously stored multicast preset or direct tune is not available in your current reception area.	No action required. The station is not available in your current location.
Text information does not match currently playing audio.	Data service issue by the radio broadcaster.	Fill out the station issue form at website listed below. <sup>1</sup>
There is no text information shown for currently selected frequency.	Data service issue by the radio broadcaster.	Fill out the station issue form at website listed below. <sup>1</sup>

<sup>1</sup> <http://hdradio.com/stations/feedback>

HD Radio Technology manufactured under license from iBiquity Digital Corporation and foreign patents. HD Radio and the HD and HD Radio logos are proprietary trademarks of DTS Ford Motor Company and DTS are not responsible for the content sent using HD Radio technology. Content may be changed, added or deleted at any time at the station owner's discretion.

### SATELLITE RADIO

SiriusXM® Satellite Radio broadcasts a variety of music, news, sports, weather, traffic and entertainment satellite radio channels. For more information and a complete list of SiriusXM satellite radio channels, visit [www.siriusxm.com](http://www.siriusxm.com) in the United States, [www.siriusxm.ca](http://www.siriusxm.ca) in Canada, or call SiriusXM at 1-888-539-7474.

**Note:** *This receiver includes the eCos real-time operating system. eCos is published under the eCos License.*

# Audio System - Vehicles With: SYNC 3

## Satellite Radio Reception Factors

Potential Satellite Radio Reception Issues	
Antenna obstructions	For optimal reception performance, keep the antenna clear of snow and ice build-up and keep luggage and other material as far away from the antenna as possible.
Terrain	Hills, mountains, tall buildings, bridges, tunnels, freeway overpasses, parking garages, dense tree foliage and thunderstorms can interfere with your reception.
Station overload	When you pass a ground-based broadcast-repeating tower, a stronger signal may overtake a weaker one and the audio system may mute.
Satellite radio signal interference	Your display may show ACQUIRING . . . to indicate the interference and the audio system may mute.

## SiriusXM Satellite Radio Service

**Note:** *SiriusXM reserves the unrestricted right to change, rearrange, add or delete programming including canceling, moving or adding particular channels, and its prices, at any time, with or without notice to you. Neither SiriusXM and its affiliates nor Ford Motor Company and its affiliates will be liable to you or any third party for any such modification, suspension or termination.*



SiriusXM satellite radio is a subscription-based satellite radio service that broadcasts a variety of music, sports, news, weather, traffic and entertainment programming. Your factory-installed SiriusXM satellite radio system includes hardware and a limited subscription term, which begins on the date of sale or lease of your vehicle. See an authorized dealer for availability.

For more information on extended subscription terms (a service fee is required), the online media player and a complete list of SiriusXM satellite radio channels, and other features, please visit [www.siriusxm.com](http://www.siriusxm.com) in the United States, [www.siriusxm.ca](http://www.siriusxm.ca) in Canada, or call SiriusXM at 1-888-539-7474.

## Satellite Radio Electronic Serial Number (ESN)

You need your ESN to activate, modify or track your satellite radio account.

### Locating Your ESN

1. Select SiriusXM as the audio source.
2. Tune to channel 0.

## Audio System - Vehicles With: SYNC 3

### Troubleshooting

Message	Condition	Action
Acquiring...	Radio requires more than two seconds to produce audio for the selected channel.	No action required. This message should disappear shortly.
Satellite antenna fault SIRIUS system failure	There is an internal module or system failure present.	If this message does not clear shortly, or with an ignition key cycle, your receiver may have a fault. See an authorized dealer for service.
Invalid Channel	The channel is no longer available.	Tune to another channel or choose another preset.
Unsubscribed Channel	Your subscription does not include this channel.	Contact SiriusXM at 1-888-539-7474 to subscribe to the channel, or tune to another channel.
No Signal	The signal is lost from the SiriusXM satellite or SiriusXM tower to your vehicle antenna.	The signal is blocked. When you move into an open area, the signal should return.
Updating...	Update of channel programming in progress.	No action required. The process may take up to three minutes.
Questions? Call 1-888-539-7474	Your satellite service is no longer available.	Contact SiriusXM at 1-888-539-7474 to resolve subscription issues.
None found Check Channel Guide	All the channels in the selected category are either skipped or locked.	Use the channel guide to turn off the Lock or Skip function on that station.
Subscription Updated	SiriusXM has updated the channels available for your vehicle.	No action required.

# Audio System - Vehicles With: SYNC 3

## USB PORT



**WARNING:** Driving while distracted can result in loss of vehicle control, crash and injury. We strongly recommend that you use extreme caution when using any device that may take your focus off the road. Your primary responsibility is the safe operation of your vehicle. We recommend against the use of any hand-held device while driving and encourage the use of voice-operated systems when possible. Make sure you are aware of all applicable local laws that may affect the use of electronic devices while driving.

## USB A



## USB C



The USB port allows you to plug in media playing devices, memory sticks and charge devices.

**Note:** We recommend using only USB-IF certified cables and adapters. Non-certified cables and adapters may not work.

## Locating the USB Ports

The USB ports may be in the following locations:

- Inside the media bin.
- Inside the center console.
- On the lower instrument panel.

**Note:** The number and type of USB ports may vary depending on your vehicle.

**Note:** Not all USB ports in your vehicle have data transfer capabilities. See **What Is the Power Outlet** (page 182).

# Audio System - Vehicles With: SYNC 4

## AUDIO SYSTEM PRECAUTIONS



**WARNING:** Driving while distracted can result in loss of vehicle control, crash and injury. We strongly recommend that you use extreme caution when using any device that may take your focus off the road. Your primary responsibility is the safe operation of your vehicle. We recommend against the use of any hand-held device while driving and encourage the use of voice-operated systems when possible. Make sure you are aware of all applicable local laws that may affect the use of electronic devices while driving.

Listening to loud audio for long periods of time could damage your hearing.

## SWITCHING THE AUDIO UNIT ON AND OFF



Press the button on the volume control.

## SELECTING THE AUDIO SOURCE

### Audio Unit



Press to open the media source menu.

You can press this multiple times to change the audio source or scroll through the media sources.

### Touchscreen

Press **Sources** on the touchscreen to open the media source menu.

## PLAYING OR PAUSING THE AUDIO SOURCE

### Audio Unit



Press the button to pause playback. Press again to resume playback.

### Touchscreen



Press the button to pause playback. Press again to resume playback.

**Note:** *Not all sources can be paused.*

## ADJUSTING THE VOLUME

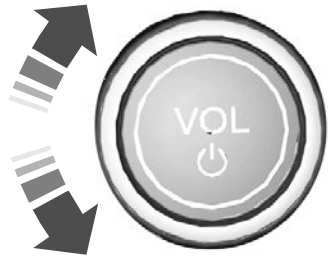

Turn to adjust the volume.

Some vehicles may be able to adjust the volume using buttons on the steering wheel.



# Audio System - Vehicles With: SYNC 4

## SWITCHING SHUFFLE MODE ON AND OFF



Press the button on the touchscreen to switch shuffle mode on or off.

**Note:** *Not all sources have shuffle mode.*

## SWITCHING REPEAT MODE ON AND OFF



Press the button on the touchscreen to switch repeat mode on or off.

**Note:** *Not all sources have repeat mode.*

## SETTING A MEMORY PRESET

1. Select a station or channel.
2. Press and hold a memory preset button on the touchscreen.

**Note:** *The audio mutes briefly while the system saves the preset and returns once it is stored.*

**Note:** *You can save presets from multiple sources to the memory preset bar.*

## MUTING THE AUDIO



Press to mute the signal. Press again to restore the signal.

## ADJUSTING THE SOUND SETTINGS

### Balance and Fade (If Equipped)

1. Press **Settings** on the touchscreen.
2. Press **Sound Settings**.
3. Press **Balance / Fade**.

4. Press the arrows to adjust the settings.

### Tone Settings

1. Press **Settings** on the touchscreen.
2. Press **Sound Settings**.
3. Press **Tone Settings**.
4. Press the arrows or slider bar to adjust the settings.

### Speed Compensated Volume

1. Press **Settings** on the touchscreen.
2. Press **Sound Settings**.
3. Press **Speed Compensated Volume**.
4. Press a setting.

### Occupancy Mode (If Equipped)

1. Press **Settings** on the touchscreen.
2. Press **Sound Settings**.
3. Press **Occupancy Mode**.
4. Press a setting.

### Sound Mode (If Equipped)

1. Press **Settings** on the touchscreen.
2. Press **Sound Settings**.
3. Press **Sound Mode**.
4. Press a setting.

## SETTING THE CLOCK AND DATE

1. Press **Settings** on the touchscreen.
2. Press **Clock Settings**.
3. Set the time.

**Note:** *The AM and PM options are not available if 24-hour mode is on.*

# Audio System - Vehicles With: SYNC 4

## Switching Automatic Time Updates On and Off

1. Press **Settings** on the touchscreen.
2. Press **Clock Settings**.
3. Switch **Automatic time zone update** on or off.

## AM/FM RADIO

### AM/FM RADIO LIMITATIONS

The further you travel from an AM or FM station, the weaker the signal and the weaker the reception.

Hills, mountains, tall buildings, bridges, tunnels, freeway overpasses, parking garages, dense tree foliage and thunderstorms can interfere with the reception.

When you pass a ground-based broadcast repeating tower, a stronger signal may overtake a weaker one and result in the audio system muting.

## SELECTING A RADIO STATION

### Manually Selecting a Radio Station

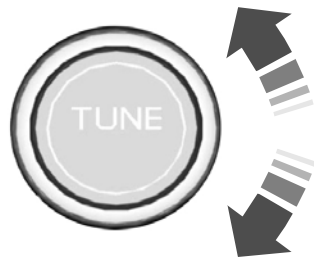

Turn to search through the radio frequency band.

### Using Direct Tune

1. Press **Direct Tune** to open the number pad.
2. Enter the station you prefer.

**Note:** *You can only enter a valid station for the audio source you are currently listening to.*

### Using Seek



Press either button. The system stops at the first station it finds in that direction.

### Using the Station List

1. Press **Browse**.

**Note:** *Available on FM radio only.*

2. Press a station.

# Audio System - Vehicles With: SYNC 4

## SWITCHING THE DISPLAY ON AND OFF

### Audio Unit



Press the button.

### Touchscreen

To switch the display off:

1. Press **Settings** on the touchscreen.
2. Press **Display Settings**.
3. Press **Display Off**.

**Note:** The display defaults to on each time you switch your vehicle on.

To switch the display on, press anywhere on the touchscreen.

## DIGITAL RADIO

### WHAT IS DIGITAL RADIO

HD Radio™ technology is the digital evolution of analog AM/FM radio.

For additional information, visit [www.HDRadio.com](http://www.HDRadio.com).

HD Radio Technology is manufactured under license from iBiquity Digital Corporation and foreign patents. HD Radio and the HD and HD Radio logos are proprietary trademarks of DTS. The vehicle manufacturer and DTS are not responsible for the content sent using HD Radio technology. Content may be changed, added or deleted at any time at the station owner's discretion.

### HOW DOES DIGITAL RADIO WORK

Your system has a special receiver that allows it to receive digital broadcasts in addition to analog broadcasts.

HD1 signifies the main programming status and is available in both analog and digital broadcasts. Other multicast stations are only available digitally and could contain new or different content.

**Note:** When the system first receives an HD1 station, it plays the station in the analog version until it verifies the station is an HD Radio station. Then it shifts to the digital version.

**Note:** There is an audio mute delay when switching to an HD2 or HD3 station because the system has to reacquire and decode the digital signal.

### DIGITAL RADIO LIMITATIONS

If you are outside the reception area, the system could not work.

If you are on the fringe of the reception area, the station could mute due to weak signal strength.

**Note:** If you are listening to HD1, the system changes back to the analog broadcast until the digital broadcast is available again. If you are listening to any other multicast channels, the station mutes and stays muted unless it is able to connect to the digital signal again.

Depending on the station quality, you could hear a slight sound change when the station changes between analog and digital audio.

You cannot access a saved HD station if your vehicle is outside the station's reception area.

### SWITCHING DIGITAL RADIO RECEPTION ON AND OFF

1. Press **Settings** on the touchscreen.
2. Press **Radio Settings**.
3. Switch **AM HD Radio** or **FM HD Radio** on or off.

# Audio System - Vehicles With: SYNC 4

## DIGITAL RADIO INDICATORS

### HD Radio Indicator

The indicator appears when HD Radio is on and you tune to a station broadcasting HD Radio technology.



The color of the indicator changes to indicate the system status.

Gray indicates the system is acquiring a digital station.

Orange indicates digital audio is playing.

### Multicast Indicator

The multicast indicator appears if the current station is broadcasting multiple digital broadcasts. The highlighted numbers indicate additional digital channels available.

**Note:** For stations that have more than one HD multicast, the HD indicator and radio text appears as a button. Press the button to cycle through all of the HD stations on that specific frequency.

## SATELLITE RADIO

### WHAT IS SATELLITE RADIO

Your factory-installed SiriusXM radio system includes a limited subscription term, which begins on the date of sale or lease of your vehicle. See an authorized dealer for availability.

For additional information about extended subscription terms, visit [www.SiriusXM.com](http://www.SiriusXM.com) in the United States, [www.SiriusXM.ca](http://www.SiriusXM.ca) in Canada, or call SiriusXM at 1-888-539-7474.

**Note:** SiriusXM reserves the unrestricted right to change, rearrange, add or delete programming including canceling, moving or adding particular channels, and its prices, at any time, with or without notice to you. Neither SiriusXM and its affiliates nor Ford Motor Company and its affiliates will be liable to you or any third party for any such modification, suspension or termination.

## SATELLITE RADIO LIMITATIONS

For optimal reception performance, keep the antenna clear of snow and ice build-up and keep luggage and other material as far away from the antenna as possible. Placing luggage over the antenna may reduce performance.

Hills, mountains, tall buildings, bridges, tunnels, freeway overpasses, parking garages, dense tree foliage and thunderstorms can interfere with your reception.

When you pass a ground-based broadcast-repeating tower, a stronger signal may overtake a weaker one and could result in the audio system muting. Your display could show an error message to indicate the interference.

## LOCATING THE SATELLITE RADIO IDENTIFICATION NUMBER

1. Select SiriusXM as the audio source.
2. Tune to channel 0.

# Audio System - Vehicles With: SYNC 4

## SELECTING A CHANNEL

### Manually Selecting a Channel



Press the button to find the previous or next available radio channel.



### Linear Tuner

The linear tuner is displayed when manually selecting a channel. You can swipe left or right on the linear tuner carousel to navigate through the channel list. Tap on a channel title to listen to it.

### Using Direct Tune

1. Press the channel up or down button to open the linear tuner screen.
2. Press **Direct Tune** to open the number pad.
3. Enter the channel you prefer.

### Using Browse

1. Press **Browse**.
2. Select a channel.

## SATELLITE RADIO SETTINGS

### Subscription

Your subscription status is displayed. You can subscribe or manage your subscription directly from the touchscreen.

### Listener Add/Switch

You can create up to five listener profiles per SiriusXM account. Each listener profile can be personalized with a name and profile image.

**Note:** Requires a trial or active subscription to use.

**Note:** A default profile is available when no listener profiles are created.

### SiriusXM Favorites

SiriusXM Favorites are shown for the active listener profile. While you are listening to SiriusXM, you can save favorites by:

- Tapping the currently tuned channel or show logo on the SiriusXM audio screen. A favorite icon appears next to the logo when it is saved as a favorite.
- Tuning to a channel or show you want to save as a favorite. Navigate to the SiriusXM Favorites screen and press the Add Current button. The currently tuned channel or show is saved as a favorite.
- Saving a radio preset. This saves the currently tuned SiriusXM channel or show as a favorite.

**Note:** Requires a trial or active subscription to use.

### Listening History

Listening history is a list of recently listened to SiriusXM content and is shown for the active listener profile. You can view, manage and reset the listening history using the controls on the touchscreen.

**Note:** Requires a trial or active subscription to use.

### Listener Settings

Listener settings apply to the active listener profile.

**Note:** Requires a trial or active subscription to use.

**Note:** A default profile is available when no listener profiles are created.

# Audio System - Vehicles With: SYNC 4

---

## Help and Support

You can contact SiriusXM Customer Care

directly from SYNC and view information required to manage your SiriusXM account.

# Audio System - Vehicles With: SYNC 4

## AUDIO SYSTEM – TROUBLESHOOTING

### AUDIO SYSTEM – INFORMATION MESSAGES

#### Satellite Radio Troubleshooting

Error Message	Potential Effects	Recommended Action
Connectivity Disabled	Internet streaming and On Demand shows are unavailable and some SiriusXM features are disabled.	Internet connectivity is turned off. See <b>Connected Vehicle</b> (page 498).
No Internet	Audio system may mute. "Switch to Satellite" button may be displayed on the SiriusXM audio screen if the channel is also available via satellite.	SYNC will attempt to connect. See <b>Satellite Radio Limitations</b> (page 529). Switch to a satellite connection for the current channel if the option is available.
No Satellite Signal	Audio system may mute. "Switch to Internet" button may be displayed on the SiriusXM audio screen if the channel is also available via streaming.	Antenna may be obstructed or satellite reception is weak in your location. See <b>Satellite Radio Limitations</b> (page 529). Switch to an internet connection for the current channel if the option is available.
Slow Network Connection	Audio system may mute while audio attempts to load.	Allow some time for audio to load or tune to a different channel.
Channel Unavailable	Audio system may mute. Radio may tune to a different channel.	A temporary update may be in progress. Allow some time before retrying to tune to the channel. If issue persists, the channel may no longer be available.
Episode Unavailable	Audio system may mute. Radio may tune to a different channel.	A temporary update may be in progress. Allow some time before retrying to play the episode. If issue persists, the episode may no longer be available.

## Audio System - Vehicles With: SYNC 4

Something went wrong	Audio system may mute. Radio may tune to a different channel.	Retry action after some time or tune to a different channel.
Subscribe to Listen	Cannot listen to selected content. Content may appear grayed out and some features may be disabled.	<p>Your subscription has expired or you have not yet subscribed for access to the listed content. Navigate to Subscription under the Satellite Radio Settings menu. If you have an active subscription which includes the listed channel or content and you see this error, you may need to refresh your radio. To refresh your SiriusXM radio, visit <a href="http://www.siriusxm.com/refresh">www.siriusxm.com/refresh</a> in the US, or <a href="http://www.siriusxm.ca/refresh">www.siriusxm.ca/refresh</a> in Canada.</p> <p>You may need to provide your SiriusXM Radio identification number. See <b>Locating the Satellite Radio Identification Number</b> (page 529).</p>



## Audio System - Vehicles With: SYNC 4

Upgrade to Listen	Cannot listen to selected content. Content may appear grayed out and some features may be disabled.	Your subscription does not include access to the listed content. You may need to upgrade your subscription. Navigate to Subscription under the Satellite Radio Settings menu. If you have an active subscription which includes the listed channel or content and you see this error, you may need to refresh your radio. To refresh your SiriusXM radio, visit <a href="http://www.siriusxm.com/refresh">www.siriusxm.com/refresh</a> in the US, or <a href="http://www.siriusxm.ca/refresh">www.siriusxm.ca/refresh</a> in Canada. You may need to provide your SiriusXM Radio identification number. See <b>Locating the Satellite Radio Identification Number</b> (page 529).
Location Restricted Content	Audio may mute. “Not available in your location” or “Unable to determine your location” may be displayed.	Content is not available in your location or SiriusXM is unable to determine your location. Tuning to a different channel may resolve the issue.
Channel Blocked	Audio may mute. Radio may tune to a different channel.	The Block Explicit Content filter is turned on. Navigate to Listener Settings under the Satellite Radio Settings menu to access the Block Explicit Content filter. Navigate to Listener Settings. See <b>Satellite Radio Settings</b> (page 530).
Antenna Problem or Hardware Problem	Audio may mute. Access to SiriusXM features may be unavailable.	If issue persists, you may need to visit an authorized dealer for service.

## Audio System - Vehicles With: SYNC 4

SiriusXM Updating...	Audio may mute.	Allow SiriusXM some time to complete updating.
Loading...	Audio may mute. Content may be temporarily unavailable while loading.	No action necessary. If loading time is longer than usual, See <b>Satellite Radio Limitations</b> (page 529).
SiriusXM Loading...	Audio may mute. Content and controls may be temporarily unavailable.	No action necessary. Allow SiriusXM some time to finish loading.

### IDENTIFYING THE AUDIO UNIT



Depending on your vehicle options, the controls may look different from what you see here.

## GENERAL INFORMATION

SYNC is an in-vehicle communications system that works with your Bluetooth enabled cellular phone and portable media player. This allows you to:

- Make and receive calls.
- Access and play music from your portable music player.
- Use 911 Assist or Emergency Assistance and applications via SYNC AppLink.\*
- Access phonebook contacts and music using voice commands.
- Stream music from your connected phone.
- Text message.
- Use the advanced voice recognition system.
- Charge your USB device (if your device supports this).

\*These features are not available in all markets and may require activation. Available AppLink enabled apps vary by market.

Make sure that you review your device's manual before using it with SYNC.

## Support

SYNC support is available at your regional Ford website. See **SYNC™ Troubleshooting** (page 542).

## SYNC Owner Account

Why do I need a SYNC owner account?

- Essential for keeping up with the latest software downloads available for SYNC.
- Access to customer support for any questions you may have.

## Driving Restrictions

For your safety, certain features are speed-dependent and restricted when your vehicle is traveling over 3 mph (5 km/h).

## Safety Information



**WARNING:** Driving while distracted can result in loss of vehicle control, crash and injury. We strongly recommend that you use extreme caution when using any device that may take your focus off the road. Your primary responsibility is the safe operation of your vehicle. We recommend against the use of any hand-held device while driving and encourage the use of voice-operated systems when possible. Make sure you are aware of all applicable local laws that may affect the use of electronic devices while driving.

When using SYNC:

- Do not operate playing devices if the power cords or cables are broken, split or damaged. Place cords and cables out of the way, so they do not interfere with the operation of pedals, seats, compartments or safe driving abilities.
- Do not leave playing devices in your vehicle during extreme conditions as it could cause them damage. See your device's manual for further information.
- Do not attempt to service or repair the system. See an authorized dealer.

## Privacy Information

When a cellular phone is connected to SYNC, the system creates a profile within your vehicle that is linked to that cellular phone. This profile is created in order to offer you more cellular features and to operate more efficiently. Among other things, this profile may contain data about your cellular phone book, text messages

(read and unread), and call history, including history of calls when your cellular phone was not connected to the system. In addition, if you connect a media device, the system creates and retains an index of supported media content. The system also records a short development log of approximately 10 minutes of all recent system activity. The log profile and other system data may be used to improve the system and help diagnose any problems that may occur.

The cellular profile, media device index, and development log will remain in the vehicle unless you delete them and are generally accessible only in the vehicle when you connect the cellular phone or media player. If you no longer plan to use the system or the vehicle, we recommend you perform a Master Reset to erase all stored information.

No one can access system data without special equipment and access to the vehicle's SYNC module. Ford Motor Company and Ford of Canada will not access the system data for any purpose other than as described absent consent, a

court order, or where required by law enforcement, other government authorities, or other third parties acting with lawful authority. Other parties may seek to access the information independently of Ford Motor Company and Ford of Canada. For further privacy information, see the section on 911 Assist. See **SYNC™ Applications and Services** (page 540).

## USING VOICE RECOGNITION

This system helps you control many features using voice commands. This allows you to keep your hands on the wheel and focus on what is around you.

### Initiating a Voice Session



Press the voice button. A list of available voice commands appears in the display.

### Global Voice Commands

These voice commands are always available. You can say them at any time.

Global voice commands	
Help	Gives you available commands you can use on the current screen.
List of Commands	Gives you a list of possible voice commands.
Cancel	This command ends the voice session. You can also cancel a session by pressing seek up, seek down, or holding the voice button for two or more seconds.

## Helpful Hints

- Make sure the interior of your vehicle is as quiet as possible. Wind noise from open windows and road vibrations may prevent the system from correctly recognizing spoken commands.
- Before giving a voice command, wait for the system announcement to finish, followed by a single tone. Any command spoken before this does not register with the system.
- Speak naturally, without long pauses between words.
- You can interrupt the system at any time while it is speaking by pressing the voice button. You can cancel a voice session by pressing and holding the voice button.

## System Interaction and Feedback

The system provides feedback through audible tones, prompts, questions and spoken confirmations depending on the situation and the chosen level of interaction. You can customize the voice recognition system to provide more or less instruction and feedback.

The default setting is to a higher level of interaction in order to help you learn to use the system. You can change these settings at any time.

### Adjusting the Interaction Level



Press the voice button. When prompted, say:

Voice Command	Action and Description
Interaction Mode Standard	Provides more detailed interaction and guidance. (Recommended for first time users.)
Interaction Mode Advanced	Provides less audible interaction and guidance.

## Phone Confirmation

Using phone confirmations the system asks you to verify before placing any calls.

**To adjust this setting press the voice button, when prompted say:**

Voice Command	Action and Description
Phone Confirmation Off	When enabled, this feature will prompt you to confirm any voice initiated call command prior to the call being placed.
Phone Confirmation On	The system will make a best guess; you may still occasionally be asked to confirm settings.

## USING SYNC™ WITH YOUR PHONE

Hands-free calling is one of the main features of SYNC. While the system supports a variety of features, many are dependent on your cellular phone's functionality. At a minimum, most cellular phones with Bluetooth wireless technology support the following functions:

- Answering an incoming call.
- Ending a call.
- Dialing a number.
- Redialing.
- Call waiting notification.
- Caller identification.

Other features, such as text messaging using **Bluetooth®** and automatic phonebook download, are phone-dependent features.

### Pairing a Phone

Wirelessly pairing your phone with SYNC allows you to make and receive hands-free calls.

**Note:** Make sure to switch on the ignition and the radio. Shift the transmission into park (P) for automatic transmission or neutral (N) for manual transmission.

### Using the Audio System

**Note:** To scroll through the menus, press the up and down arrows on your audio system.

1. Make sure to switch on your phone's **Bluetooth®** feature before starting the search. See your device's manual if necessary.
2. Press the **Settings** button.
3. Select Bluetooth from the menu.
4. Press the **OK** button.

5. Select the option to add. This starts the pairing process.
6. When a message to begin pairing appears in the center display, search for SYNC on your device.

Depending on your phone's capability and your market, the system may prompt you with questions, such as setting the current phone as the primary phone and downloading your phonebook.

### Using Voice Commands



Make sure to switch on your phone's **Bluetooth®** feature before starting the search. See your device's manual if necessary.

### Press the voice button and when prompted say:

Voice Command	Action and Description
Pair Phone	Follow the instructions on the center display.

### Phone Voice Commands



Press the voice button. You can do things like place a phone call and access text messages. When prompted, say a command. See the following table for examples of commands.

Voice Command
___ List of Commands
Help
Call ___
Dial ___
Text Messages

\_\_ is a dynamic listing, meaning that it could be the name of anything, such as a contact or phone number.

## Phone Controls

Use the phone buttons on your steering wheel to answer, reject, or hang up a call.

## Accessing Features through the Phone Menu

You can access your call history, phonebook, sent text messages, as well as access phone and system settings.

1. Press the **PHONE** button to enter the phone menu.
2. Scroll through the menu to view contacts, text messages, and the phone dialer.

## SYNC™ APPLICATIONS AND SERVICES

- SYNC AppLink: Allows you to connect to and use certain applications (if your phone is compatible).

These features may require activation. Available AppLink enabled apps vary by market.

## SYNC Mobile Apps

The system enables voice and steering wheel control of SYNC AppLink enabled smartphone apps. When an app is running through AppLink, you can control main features of the app through voice commands and steering wheel controls.

**Note:** You must pair and connect your smartphone to SYNC to access AppLink.

**Note:** Android users need to connect the phone to SYNC using **Bluetooth®**.

**Note:** For information on available apps, supported smartphone devices and troubleshooting tips please visit the Ford website.

**Note:** Availability of SYNC AppLink enabled Apps will vary by region.

**Note:** Make sure you have an active account for the app that you have downloaded. Some apps work automatically with no setup. Other apps want you to configure your personal settings and personalize your experience by creating stations or favorites. We recommend you do this at home or outside of your vehicle.

## To Access Using the SYNC Menu

**Press the Mobile Apps button to access the menu on-screen. Then select:**

Menu Item	Action and Description
Find Mobile Apps	Scroll through the list of available applications and select a particular app.

**Note:** If you cannot find a compatible SYNC AppLink app, make sure the required app is running on the mobile device.

## To Access Using Voice Commands

**Press the voice button, then when prompted say:**

Voice Command	Action and Description
Mobile Applications	Say the name of the application after the tone. The app should start. When an app is running through SYNC, you can press the voice button and speak commands specific to the app, for example "Play Playlist Road Trip".
List Applications	SYNC lists all of the currently available mobile apps.
Find Applications	Searches your connected mobile device for SYNC-compatible mobile apps.
Help	Use this command to discover the available voice commands.

## App Permissions

App permissions are organized by groups. You can grant these group permissions individually. You can change a permission group status any time when not driving, by using the settings menu.

When you launch an app using SYNC, the system may ask you to grant certain permissions, for example:

- To allow your vehicle to provide vehicle information to the app such as, but not limited to: Fuel level, fuel economy, fuel consumption, engine speed, rain sensor, odometer, VIN, external temperature, gear position, tire pressure, and head lamp status.
- To allow your vehicle to provide driving characteristic information such as, but not limited to: MyKey, seatbelt status, engine revolutions per minute, gear position, braking events, steering wheel angle, and accelerator pedal position.

- To allow your vehicle to provide location information, including: GPS and speed.
- To allow the app to send push notifications using the vehicle display and voice capabilities while running in a background state. Push notifications may be particularly useful for news or location based apps.

**Note:** *You only need to grant permissions the first time you use an app with SYNC.*

**Note:** *Ford is not responsible or liable for any damages or loss of privacy relating to usage of an app, or dissemination of any vehicle data that you approve Ford to provide to an app.*

## Enabling SYNC Mobile Apps

In order to enable mobile apps, SYNC requires user consent to send and receive app authorization information and updates using the data plan associated with the connected device.



Data is sent to Ford in the United States through the connected device. The information is encrypted and includes, for example, the vehicle identification number of your vehicle, the SYNC module serial number, odometer, enabled apps, usage statistics and debugging information. Updates may take place.

**Note:** You must enable mobile apps for each connected device the first time you select a mobile app using the system.

**Note:** Standard data rates apply. Ford is not responsible for any additional charges you may receive from your service provider, when your vehicle sends or receives data through the connected device. This includes any additional charges incurred due to driving in areas when roaming out of a home network.

## USING SYNC™ WITH YOUR MEDIA PLAYER

SYNC supports digital media sources including: iPod, **Bluetooth®** devices, and most USB drives. SYNC also supports audio formats, such as MP3, WMA, WAV and ACC.

### Media Sources

The **AUX** or **MEDIA** button allows you to view and select available media sources.

Press the **AUX** or **MEDIA** button to view your sources. Use the directional arrows and OK button to select your source. You can also use the steering wheel audio controls.

## Audio Voice Commands



Press the voice button. You can do things like play a specific song or album, or tune to a radio station. When prompted, say a command. See the following table for example commands. Not all commands may be available on your vehicle.

Command
___ List of Commands
Help
Pause
Play
AM ___
FM ___
CD Player
Sirius Channel ___
USB
Bluetooth Audio

\_\_\_ is a dynamic listing, meaning that it could be the name of anything, such as an artist, station, or media source.

## SYNC™ TROUBLESHOOTING

Your SYNC system is easy to use. However, should questions arise, see the tables below.

Use your local Ford website at any time to check your phone's compatibility, register your account and set preferences as well as access a customer representative via an online chat (during certain hours).

# SYNC™

Market	Website(s)
North America	www.SYNCMyRide.com www.SYNCMyRide.ca www.syncmaroute.ca

Phone Issues		
Issue	Possible Cause(s)	Possible Solution(s)
There is excessive background noise during a phone call.	The audio control settings on your phone may be affecting SYNC performance.	Review your phone's manual about audio adjustments.
During a call, I can hear the other person but they cannot hear me.	This may be a possible phone malfunction.	Try turning off the device, resetting the device, removing the device's battery, then trying again.
SYNC is not able to download my phonebook.	This is a phone-dependent feature.  This may be a possible phone malfunction.	Go to the website to review your phone's compatibility.  Try turning off the device, resetting the device or removing the device's battery, then trying again.  Try pushing your phonebook contacts to SYNC by using the Add Contacts feature.  Use the SYNCmyphone feature available on the website.
The system says Phonebook Downloaded but the phonebook in SYNC is empty or missing contacts.	This may be a limitation on your phone's capability.	Try pushing your phonebook contacts to SYNC by using the Add Contacts feature.  If the missing contacts are stored on your SIM card, try moving them to the device memory.

Phone Issues		
Issue	Possible Cause(s)	Possible Solution(s)
		<p>Remove any pictures or special ring tones associated with the missing contact.</p> <p>Depending upon your phone, you may have to grant SYNC permission to access your phonebook contacts. Make sure to confirm when prompted by your phone during the phonebook download.</p>
<p>I am having trouble connecting my phone to SYNC.</p>	<p>This is a phone-dependent feature.</p> <p>This may be a possible phone malfunction.</p>	<p>Go to the website to review your phone's compatibility.</p> <p>Try turning off the device, resetting the device or removing the device's battery, then trying again.</p> <p>Try deleting your device from SYNC, deleting SYNC from your device and trying again.</p> <p>Check the security and auto accept and prompt always settings relative to the SYNC <b>Bluetooth®</b> connection on your phone.</p> <p>Update your device's firmware.</p> <p>Turn off the Auto phonebook download setting.</p>

# SYNC™

Phone Issues		
Issue	Possible Cause(s)	Possible Solution(s)
Text messaging is not working on SYNC.	<p>This is a phone-dependent feature.</p> <p>This may be a possible phone malfunction.</p>	<p>Go to the website to review your phone's compatibility.</p> <p>Try turning off the device, resetting the device or removing the device's battery, then trying again.</p>
I cannot return to the Phone menu when selecting a contact.	You are on the Select a Character screen.	Press the Phone button to return to the Phone menu.

USB and Media Issues		
Issue	Possible Cause(s)	Possible Solution(s)
I am having trouble connecting my device.	This may be a possible device malfunction.	<p>Try turning off the device, resetting the device, removing the device's battery, then trying again.</p> <p>Make sure you are using the manufacturer's cable.</p> <p>Make sure you insert the USB cable correctly into the device and the USB port.</p> <p>Make sure that the device does not have an auto-install program or active security settings.</p>
SYNC does not recognize my device when I turn on the car.	This is a device limitation.	Make sure you are not leaving the device in your vehicle during very hot or cold temperatures.
<b>Bluetooth</b> ® audio does not stream.	This is a phone-dependent feature.	Review the device compatibility chart on the SYNC website to confirm your phone supports the <b>Bluetooth</b> ® audio streaming function.

# SYNC™

<b>USB and Media Issues</b>		
<b>Issue</b>	<b>Possible Cause(s)</b>	<b>Possible Solution(s)</b>
	The device is not connected.	Make sure you correctly connect the device to SYNC, and that you have pressed play on your device.
SYNC does not recognize music that is on my device.	Your music files may not contain the correct artist, song title, album or genre information. The file may be corrupted. The song may have copy-right protection, which does not allow it to play.	Make sure that all song details are populated.  Some devices require you to change the USB settings from mass storage to MTP class.
I cannot change the Sirius station.	Sirius Replay is active.	Switch radio bands and return to Sirius or switch the feature off. You can then change the Sirius station using the directional buttons.

<b>Voice Command Issues</b>		
<b>Issue</b>	<b>Possible Cause(s)</b>	<b>Possible Solution(s)</b>
SYNC does not understand what I am saying.	You may be using the wrong voice commands.  You may be speaking too soon or at the wrong time.	Review the phone voice commands and the media voice commands at the beginning of their respective sections.  After pressing the voice icon, wait until after the tone sounds and Listening appears before saying a command. Any command spoken before this does not register with the system.
SYNC does not understand the name of a song or artist.	You may be using the wrong voice commands.	Review the media voice commands at the beginning of the media section.

# SYNC™

<b>Voice Command Issues</b>		
<b>Issue</b>	<b>Possible Cause(s)</b>	<b>Possible Solution(s)</b>
	<p>You may be saying the name differently than the way you saved it.</p> <p>The system may not be reading the name the same way you are saying it.</p>	<p>Say the song or artist exactly as listed. If you say "Play Artist Prince", the system does not play music by Prince and the Revolution or Prince and the New Power Generation.</p> <p>Make sure you are saying the complete title, such as "California remix featuring Jennifer Nettles".</p> <p>If the song titles are in all CAPS, you have to spell them. LOLA requires you to say "L-O-L-A".</p> <p>Do not use special characters in the title. The system does not recognize them.</p>
<p>SYNC does not understand or is calling the wrong contact when I want to make a call.</p>	<p>You may be using the wrong voice commands.</p> <p>You may be saying the name differently than the way you saved it.</p>	<p>Review the Phone voice commands at the beginning of the phone section.</p> <p>Make sure you are saying the contacts exactly as they are listed. For example, if you save a contact as Joe Wilson, say "Call Joe Wilson".</p> <p>Using the SYNC phone menu, open the phonebook and scroll to the name SYNC is having trouble understanding. SYNC will read the name to you, giving you some idea of the pronunciation SYNC is expecting.</p>

# SYNC™

<b>Voice Command Issues</b>		
<b>Issue</b>	<b>Possible Cause(s)</b>	<b>Possible Solution(s)</b>
	<p>The system may not be reading the name the same way you are saying it.</p> <p>Contacts in your phonebook may be very short and similar, or they may contain special characters.</p> <p>Your phonebook contacts may be in CAPS.</p>	<p>The system works better if you list full names, such as "Joe Wilson" rather than "Joe".</p> <p>Do not use special characters, such as 123 or ICE, as the system does not recognize them.</p> <p>If a contact is in CAPS, you have to spell it. JAKE requires you to say "Call J-A-K-E".</p>

<b>AppLink Issues</b>		
<b>Issue</b>	<b>Possible Cause(s)</b>	<b>Possible Solution(s)</b>
<p>AppLink Mobile Applications: When I select "Find New Apps," SYNC does not find any applications.</p>	<p>An AppLink capable phone is not connected to SYNC.</p>	<p>Ensure you have a compatible smartphone; an Android with OS 2.3 or higher or an iPhone 3GS or newer with iOS 5.0 or higher. Additionally, ensure your phone is paired and connected to SYNC in order to find AppLink-capable apps on your device. iPhone users must also connect to SYNC's USB port with an Apple USB cable.</p>
<p>My phone is connected, but I still cannot find any apps.</p>	<p>AppLink-enabled apps are not installed and running on your mobile device.</p>	<p>Ensure you have downloaded and installed the latest version of the app from your phone's app store. Ensure the app is running on your phone. Some apps require you to register or</p>

# SYNC™

<b>AppLink Issues</b>		
<b>Issue</b>	<b>Possible Cause(s)</b>	<b>Possible Solution(s)</b>
		login on the app on the phone before using them with AppLink. Also, some may have a Ford SYNC setting, so check the app's settings menu on the phone.
My phone is connected, my app(s) are running, but I still cannot find any apps.	Sometime apps do not properly close and re-open their connection to SYNC, over ignition cycles, for example.	<p>Closing and restarting apps may help SYNC find the application if you cannot discover it inside the vehicle.</p> <p>On an Android device, if apps have an Exit or Quit option, select that then restart the app. If the app does not have that option, you can also manually Force Close the app by going to the phone's settings menu, selecting Apps, then finding the particular app and choosing Force stop. Remember to restart the app afterwards, then select Find New Apps on SYNC.</p> <p>On an iPhone with iOS7+, to force close an app, double tap the home button then swipe up on the app to close it. Touch the home button again, then select the app again to restart it. After a few seconds, the app should appear in the SYNC Mobile App menu.</p>



AppLink Issues		
Issue	Possible Cause(s)	Possible Solution(s)
My Android phone is connected, my app(s) are running, I restarted them, but I still cannot find any apps.	There is a <b>Bluetooth®</b> bug on some older versions of the Android operating system that may cause apps that were found on your previous vehicle drive to not be found again if you have not turned off <b>Bluetooth®</b> .	Reset the <b>Bluetooth®</b> on your phone by turning it off and then turning <b>Bluetooth®</b> back on. If you are in your vehicle, SYNC should be able to automatically re-connect to your phone if you press the Phone button.
My iPhone phone is connected, my app is running, I restarted the app but I still cannot find it on SYNC.	The USB connection to SYNC may need to be reset.	Unplug the USB cable from the phone, wait a moment, and plug the USB cable back in to the phone. After a few seconds, the app should appear in SYNC's Mobile Apps Menu. If not, "Force Close" the application and restart it.
I have an Android phone. I found and started my media app on SYNC, but there is no sound or the sound is very low.	The <b>Bluetooth®</b> volume on the phone may be low.	Try increasing the <b>Bluetooth®</b> volume of the device by using the device's volume control buttons which are most often found on the side of the device.
I can only see some of the AppLink apps running on my phone listed in SYNC's Mobile Apps Menu.	Some Android devices have a limited number of <b>Bluetooth®</b> links apps can use to connect. If you have more AppLink apps on your phone than the number of available <b>Bluetooth®</b> links, you will not see all of your apps listed in SYNC's mobile apps menu.	Force close or uninstall the apps you do not want SYNC to find. If the app has a "Ford SYNC" setting, disable that setting in the app's settings menu on the phone.

## **SYNC System Reset**

The SYNC system in your vehicle has System Reset feature that can be performed if the function of a SYNC feature is lost. This reset is intended to restore functionality and will not erase any information previously stored in the system (Such as paired devices, phonebook, call history, text messages, or user settings). To perform a System Reset, press and hold the Seek Up (>>) button while pressing and holding the Radio Power button. Release both buttons after 2-3 seconds. Please allow a few minutes for the reset to complete. After a few minutes has passed you can resume using the SYNC system.

## GENERAL INFORMATION



**WARNING:** Driving while distracted can result in loss of vehicle control, crash and injury. We strongly recommend that you use extreme caution when using any device that may take your focus off the road. Your primary responsibility is the safe operation of your vehicle. We recommend against the use of any hand-held device while driving and encourage the use of voice-operated systems when possible. Make sure you are aware of all applicable local laws that may affect the use of electronic devices while driving.

### About SYNC

The system allows you to interact with the entertainment, information and communication systems on your vehicle using voice commands and a touchscreen. The system provides easy interaction with audio, phone, navigation, mobile apps and settings.

**Note:** You can switch the system on and use it for up to an hour without switching the ignition on.

**Note:** You can use the system after you switch the ignition off for up to 10 minutes or until you open a door.

**Note:** For your safety, some features are speed-dependent. Their use is limited to when your vehicle speed is less than 3 mph (5 km/h).

## Using the Touchscreen

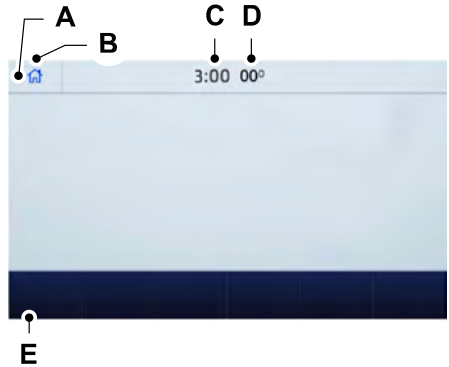

- A Status bar.
- B Home screen.
- C Clock. See **Settings** (page 582).
- D Outside air temperature.
- E Feature bar.

### Status Bar

-  Cell phone microphone muted.
-  Audio system muted.
-  Software update installed.
-  Wi-Fi connected.
-  Cell phone roaming.
-  Text message received.

## SYNC™ 3 (If Equipped)



Automatic crash notification system off.



Cell phone network signal strength.



Vehicle data sharing on.



Vehicle location sharing on.



Vehicle data and vehicle location sharing on.



Wireless charger active.

### Feature Bar



Select to use the radio, a USB, a media player or a **Bluetooth®** device. See **Entertainment** (page 560).



Select to adjust climate settings. See **Climate** (page 570).



Select to make calls and access the phonebook on your cell phone. See **Phone** (page 572).



Select to use the navigation system. See **Navigation** (page 574).



Select to search for and use compatible apps on your iOS or Android device. See **Apps** (page 580).



Select to adjust system settings. See **Settings** (page 582).

### Cleaning the Touchscreen

See **Cleaning the Instrument Panel** (page 424).

## Updating the System

### Updating the System Using a USB Drive

#### Downloading an Update

1. Go to the SYNC update page on the local Ford website.
2. Download the update.

**Note:** *The website notifies you if an update is available.*

3. Insert a USB drive into your computer.

**Note:** *The USB drive needs to be empty and meet the minimum requirements detailed on the website.*

4. Follow the instructions provided to download the update to the USB drive.

#### Installing an Update

**Note:** *You can use the system when an installation is in progress.*

1. Disconnect all other USB devices from the USB ports.
2. Connect the USB drive with the update to a USB port.

**Note:** *Installation starts automatically within 10 minutes.*

### Updating the System Using a Wi-Fi Network Connection

#### Connecting to a Wi-Fi Network



Select the settings option on the feature bar.

1. Select **Automatic Updates**.
2. Select **System Wi-Fi**.
3. Switch **System Wi-Fi** on.
4. Select **Available Wi-Fi Networks**.
5. Select an available Wi-Fi network.

**Note:** *Enter the network password to connect to a secure network.*

## Switching Automatic System Updates On



Select the settings option on the feature bar.

1. Select **Automatic Updates**.
2. Switch **Automatic System Updates** on.

The system is now set to check for and receive system updates when it is connected to a Wi-Fi network.

**Note:** You can use the system when a download is in progress.

**Note:** If the system is disconnected from the Wi-Fi network when a download is in progress, the download continues the next time the system is connected to a Wi-Fi network.

## Additional Information and Assistance

For additional information and assistance, we recommend that you contact an authorized dealer or refer to the local Ford website.

## USING VOICE RECOGNITION

The system allows you to interact with the entertainment, information and communication systems on your vehicle using voice commands. This allows you to keep your hands on the steering wheel and focus on what is in front of you.



Press the voice control button on the steering wheel and wait for the voice prompt.

**Note:** Press the voice control button again to interrupt a voice prompt and begin speaking.

**Note:** Turn the volume control when a voice prompt plays to adjust the volume.

**Note:** Press and hold the voice control button on the steering wheel to use Siri on your iOS device.

The following voice commands are designed to help you from any screen:

- **List of Commands**
- **Help**

The following tables list some of the more frequently used voice commands. For a complete list of voice commands, refer to our website.

## General

Voice Command	Description
___ List of Commands	Get a list of voice commands for a specific feature. <sup>1</sup>
Cancel	Cancel an active voice session.
___ Help	Get a list of voice commands for a specific feature. <sup>1</sup>
Go back	Return to the previous screen.
Main Menu	Go to the main menu.

## SYNCTM 3 (If Equipped)

Voice Command	Description
Next Page	Go to the next page.
Previous Page	Go to the previous page.

<sup>1</sup> Add the name of the feature to the command.

### Entertainment

#### Audio Source

Voice Command	Description
Radio	Use the radio.
CD Player	Use the CD player.
Bluetooth Stereo	Use a <b>Bluetooth</b> ® device.
USB	Use a USB or media player.

#### Radio

Voice Command	Description
AM	Listen to AM radio.
AM ____	Tune to a specific AM frequency. <sup>1</sup>
Sirius Channel ____	Listen to SiriusXM radio. <sup>2</sup>
FM	Listen to FM radio.
FM ____	Tune to a specific FM frequency. <sup>1</sup>

<sup>1</sup> Add the radio frequency to two decimal places to the command.

<sup>2</sup> You can say the Sirius channel name or number such as "Sirius Channel 16" or "Sirius The Pulse".

# SYNC™ 3 (If Equipped)

## USB and Media Player

Voice Command	Description
Play Album ___	Play your music by category. <sup>1</sup>
Play Artist ___	
Play Genre ___	
Play Playlist ___	
Play Song ___	
Play Audiobook ___	
Play Podcast ___	
Browse All Albums	Browse music on a USB device.
Browse All Artists	
Browse All Audiobooks	
Browse All Genres	
Browse All Playlists	
Browse All Podcasts	
Browse All Songs	
Browse Album ___	Browse your music by category on a USB device. <sup>1</sup>
Browse Artist ___	
Browse Audiobook ___	
Browse Genre ___	
Browse Playlist ___	
Browse Podcast ___	

<sup>1</sup> Add an album name, artist name, audiobook name, genre name, playlist name, podcast name or track name to the command. Say the name exactly as it appears on your device.

## Climate (If Equipped)

You can control the temperature of the vehicle using voice commands.

\_\_\_ is a dynamic listing, meaning that for climate voice commands it can be the desired degrees for the temperature setting.

## SYNCTM 3 (If Equipped)

### To adjust the temperature, say:

Voice command	Description
Set Temperature ___	Adjust the temperature between 60–85°F (15.5–29.5°C).

### Phone

Voice Command	Description
Pair Phone	Pair a cell phone or <b>Bluetooth</b> ®-enabled device.
Redial	Redial the last number that you dialed.
Dial ___	Dial a number. <sup>1</sup>
Call ___	Call a specific contact from your phonebook. <sup>2</sup>
Call ___ ___	Call a specific contact from your phonebook at a specific location. <sup>3</sup>
Listen to Message	Listen to a text message.
Listen to Message ___	Listen to a specific text message from a list of text messages.
Reply to Message	Reply to the last text message.

<sup>1</sup> Add the number you want to dial to the command.

<sup>2</sup> Add a contact name from your phonebook to the command. Say the first and last name of your contact exactly as it appears on your device.

<sup>3</sup> Add a contact name and location from your phonebook to the command. Say the first and last name of your contact exactly as it appears on your device.



# SYNC™ 3 (If Equipped)

## Navigation (If Equipped)

### Setting a Destination

Voice Command	Description
Find an Address	Enter a destination address. When prompted, provide the house number, the street and city.
Find a Place	Search for a point of interest by name or by category.
Find the Next ___	Search for a nearby point of interest by category. <sup>1</sup>
Find a POI Category	Search for a point of interest category. <sup>1</sup>
Drive Home	Set your saved home address as your destination.
Drive to Work	Set your saved place of work as your destination.
Show Previous Destinations	Display and select from a list of previous destinations.
Show Favorites	Display and select from a list of favorite destinations.

<sup>1</sup> Add a point of interest category or the name of a major brand or chain to the command.

### Route Guidance

Voice Command	Description
Cancel Route	Cancel the current route.
Detour	Select an alternate route.
Repeat Instruction	Repeat the last guidance prompt.
Show Route	Display an overview of the route.
Show Traffic	Display a list of traffic events on your route.
Show Map	Display the map on the touchscreen.
North Up	Display a two-dimensional map with north toward the top of the touchscreen.
Heading Up	Display a two-dimensional map with the direction you are traveling toward the top of the touchscreen.
Show 3D	Display a three-dimensional map with the direction you are traveling toward the front.

# SYNCTM 3 (If Equipped)

## Apps

### General

Voice Command	Description
Mobile Applications	Start an app. The system prompts you for the app name.
List Applications	Get a list of apps running on your device.
Find Applications	Search and connect to apps running on your device.

### Active App

Voice Command	Description
___ Help	Get a list of voice commands for a specific app. <sup>1</sup>
Exit ___	Close an app. <sup>1</sup>

<sup>1</sup>Add an app name to the command.

### SiriusXM Traffic and Travel Link (If Equipped)

Voice command	Description
Show Traffic	Displays a list of traffic incidents.
Show Weather Map	Displays the current weather map.
Show Fuel Prices	Displays a list of fuel prices.
Show 5 Day Forecast	Displays the 5 day weather forecast.

# SYNC™ 3 (If Equipped)

## Voice Settings

Voice Command	Description
Voice Settings	Go to the voice settings menu.
Interaction Mode Novice	Switch long voice prompts on.
Interaction Mode Advanced	Switch short voice prompts on.
Phone Confirmation On	Switch call confirmation on. The system prompts you to confirm before making a call.
Phone Confirmation Off	Switch call confirmation off. The system does not prompt you to confirm before making a call.
Voice Command Lists On	Switch the display of voice commands on.
Voice Command Lists Off	Switch the display of voice commands off.

## Automatic Blower Motor Speed Reduction

If necessary, the system decreases the blower motor speed when you are using voice commands to reduce the amount of background noise in your vehicle. It returns to normal when you are done.

## Switching Automatic Blower Motor Speed Reduction Off

Simultaneously press the **A/C** and recirculated air buttons.

## ENTERTAINMENT

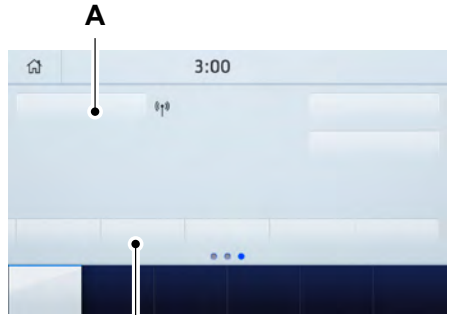

- A Audio source. Select to choose a different audio source.
- B Presets. Swipe left to view more presets.

You can access these options using the touchscreen or voice commands.

# SYNC™ 3 (If Equipped)

## Sources

Press this button to select the source of media you want to listen to.

Menu Item	
AM	
FM	
SIRIUS <sup>1</sup>	
CD	
USB	The name of the USB that is plugged in displays here.
Bluetooth Stereo	
Apps	If you have SYNC 3 compatible apps on your connected smart phone, they display here as individual source selections.

<sup>1</sup> This feature may not be available in all markets and requires an active subscription.

## AM/FM Radio

### Tuning a Station

You can use the tune or seek controls on the radio bezel to select a station.

### To tune a station using the touchscreen, select:

Menu Item
Direct Tune

A pop up appears, allowing you to type in the frequency of a station. You can only enter a valid station for the source you are currently listening to.

You can press the backspace button to delete the previously entered number.

### Once you have entered the station's call numbers, you can select:

Menu Item	Action and Description
Enter	Press to begin playing the station you have entered.
Cancel	Press to exit without changing the station.

## Presets

To set a new preset, tune to the station and then press and hold one of the memory preset buttons. The audio mutes briefly while the system saves the station and then returns.

You may be able to add additional preset pages using the settings option on the feature bar.

## SYNC™ 3 (If Equipped)

### SiriusXM® Satellite Radio (If Activated)

**Note:** *This feature may not be available in all markets and requires an active subscription.*



SiriusXM satellite radio is a subscription-based satellite radio service that broadcasts a variety of music, sports, news, weather, traffic and entertainment programming. Your factory-installed SiriusXM satellite radio system includes hardware and a limited subscription term that begins on the date of sale or lease of your vehicle. See an authorized dealer for availability.

For more information on extended subscription terms (a service fee is required), the online media player and a list of SiriusXM satellite radio channels, and other features, please visit [www.siriusxm.com](http://www.siriusxm.com) in the United States, [www.siriusxm.ca](http://www.siriusxm.ca) in Canada, or call SiriusXM at 1-888-539-7474.

**Note:** *SiriusXM reserves the unrestricted right to change, rearrange, add or delete programming. This includes canceling, moving or adding particular channels, and its prices, at any time, with or without notice to you. We are not responsible for any such programming changes.*

**Note:** *This receiver includes the eCos real-time operating system. eCos is published under the eCos License.*

### The following buttons are available for SiriusXM:

Menu Item	Action and Description	
Browse	Touch this button to see a list of available stations.	
Direct Tune	A pop-up appears, allowing you to type in the call numbers of a station. Once you enter the stations call numbers, you can select:	
	Enter	The system tunes to the station you select.
	Cancel	You exit the pop-up and the current station continues to play.
	You can press the backspace button to delete the previous number.	

## SYNCTM 3 (If Equipped)

Menu Item	Action and Description	
Replay	Replay audio on the current channel. You can replay approximately 45 minutes of audio as long as you remain tuned to the current station. Changing stations erases the previous audio.	
	Live	When you are in replay mode, you are not able to select a different preset until you return to live audio. Pressing this button returns you to the live broadcast.
ALERT	Save the current song, artist, or team as a favorite. The system alerts you when it plays again on any channel. Selecting this button allows you to enable and edit alerts.	

### Memory Presets

To set a preset, tune to the station then press and hold one of the memory preset buttons. The audio mutes briefly while the system saves the station and returns once the station is stored.

You may be able to add additional preset pages using the settings option on the feature bar.

### SiriusXM Satellite Radio Reception Factors and Troubleshooting

Potential Reception Issues	
Antenna obstructions	For optimal reception performance, keep the antenna clear of snow and ice build-up and keep luggage and other materials as far away from the antenna as possible.
Terrain	Hills, mountains, tall buildings, bridges, tunnels, freeway overpasses, parking garages, dense tree foliage and thunderstorms can interfere with your reception.
Station overload	When you pass a ground-based broadcast-repeating tower, a stronger signal may overtake a weaker one and the audio system may mute.
Satellite radio signal interference	Your display may show ACQUIRING... to indicate the interference and the audio system may mute.

## SYNC™ 3 (If Equipped)

Troubleshooting Tips		
Message	Cause	Action
Acquiring Signal	Radio requires more than two seconds to produce audio for the selected channel.	No action required. This message should disappear shortly.
Satellite antenna fault SIRIUS system failure	There is an internal module or system failure present.	If this message does not clear shortly, or with an ignition key cycle, your receiver may have a fault. See an authorized dealer for service.
Invalid Channel	The channel is no longer available.	Tune to another channel or choose another preset.
Unsubscribed Channel	Your subscription does not include this channel.	Contact SiriusXM at 1-888-539-7474 to subscribe to the channel, or tune to another channel.
Satellite acquiring signal...	The signal is lost from the SiriusXM satellite or SiriusXM tower to your vehicle antenna.	The signal is blocked. When you move into an open area, the signal should return.
Updating...	Update of channel programming in progress.	No action required. The process may take up to three minutes.
Questions? Call 1-888-539-7474	Your satellite service is no longer available.	Contact SiriusXM at 1-888-539-7474 to resolve subscription issues.
None found. Check channel guide.	All the channels in the selected category are either skipped or locked.	Use the channel guide or the Sirius XM Settings tile to turn off the Lock or Skip function on that station.
SIRIUS Subscription updated	SiriusXM has updated the channels available for your vehicle.	No action required.

**Note:** HD Radio broadcasts are not available in all markets.

### HD Radio™ Information (If Available)

To activate HD radio, please see the Radio Settings in the Settings Chapter. See **Settings** (page 582).

## SYNCTM 3 (If Equipped)

HD Radio technology is the digital evolution of analog AM/FM radio. Your system has a special receiver that allows it to receive digital broadcasts (where available) in addition to the analog broadcasts, it already receives. Digital broadcasts provide a better sound quality than analog broadcasts with free, crystal-clear audio and no static or distortion. For more information, and a guide to available stations and programming, please visit:

<b>Website</b>
<a href="http://www.hdradio.com">www.hdradio.com</a>

When HD Radio is on and you tune to a station broadcasting HD Radio technology, you may notice the following indicators on your screen:



The HD logo is grey when acquiring a digital station, and then changes to orange when digital audio is playing. When this logo is available, you may also see Title and Artist fields on-screen.

The multicast indicator appears in FM mode (only) if the current station is broadcasting multiple digital broadcasts. The highlighted numbers signify available digital channels where new or different content is available. HD1 signifies the main programming status and is available in analog and digital broadcasts. Other multicast stations (HD2 through HD7) are only available digitally.

**Note:** *There is also an additional feature for stations that have more than 1 HD multicast (For example, HD1 or HD2). The HD logo and Radio text appears as a button. Pressing this button allows you to cycle through all of the HD stations on that specific frequency. For example, if you are on 101.1 and it has HD1, HD2, HD3, pressing the button repeatedly causes the radio to cycle through the HD stations in a cyclic increasing order.*

### When HD Radio broadcasts are active, you can access the following functions:

Message	Action and Description
Presets	Allows you to save an active channel as a memory preset. Touch and hold a memory preset slot until the sound returns. There is a brief mute while the radio saves the station. Sound returns when the channel saves. When switching to an HD2 or HD3 memory preset, the sound mutes before the digital audio plays, because the system has to reacquire the digital signal.

**Note:** *As with any station you save, you cannot access the saved station if your vehicle is outside the station's reception area.*



# SYNC™ 3 (If Equipped)

## HD Radio Reception and Station Troubleshooting

Potential Reception Issues	
Reception area	<p>If you are listening to a multicast station and you are on the fringe of the reception area, the station may mute due to weak signal strength.</p> <p>If you are listening to HD1, the system changes back to the analog broadcast until the digital broadcast is available again. However, if you are listening to any of the possible HD2-HD7 multicast channels, the station mutes and stays muted unless it is able to connect to the digital signal again.</p>
Station blending	<p>When the system first receives a station (aside from HD2-HD7 multicast stations), it first plays the station in the analog version. Once the receiver verifies the station is an HD Radio station, it shifts to the digital version. Depending on the station quality, you may hear a slight sound change when the station changes from analog to digital. Blending is the shift from analog to digital sound or digital back to analog sound.</p>

In order to provide the best possible experience, use the contact form to report any station issues found while listening to a station broadcasting with HD Radio technology. Independent entities own and operate each station. These stations are responsible for ensuring all audio streams and data fields are accurate.

Potential Station Issues		
Issues	Cause	Action
Echo, stutter, skip or repeat in audio. Increase or decrease in audio volume.	This is poor time alignment by the radio broadcaster.	No action required. This is a broadcast issue.
Sound fading or blending in and out.	The radio is shifting between analog and digital audio.	No action required. The reception issue may clear up as you continue to drive.
There is an audio mute delay when selecting HD2 or HD3, multicast preset or Direct Tune.	The digital multicast is not available until the HD Radio broadcast is decoded. Once decoded, the audio is available.	No action required. This is normal behavior. Wait until the audio is available.

## SYNCTM 3 (If Equipped)

Potential Station Issues		
Issues	Cause	Action
Cannot access HD2 or HD3 multicast channel when recalling a preset or from a direct tune.	The previously stored multicast preset or direct tune is not available in your current reception area.	No action required. The station is not available in your current location.
Text information does not match currently playing audio.	Data service issue by the radio broadcaster.	Fill out the station issue form. <sup>1</sup>
There is no text information shown for currently selected frequency.	Data service issue by the radio broadcaster.	Fill out the station issue form. <sup>1</sup>

<sup>1</sup> You can find the form here:

Website
<a href="http://hdradio.com/stations/feedback">http://hdradio.com/stations/feedback</a>

HD Radio Technology manufactured under license from iBiquity Digital Corporation and foreign patents. HD Radio and the HD and HD Radio logos are proprietary trademarks of DTS. The vehicle manufacturer and DTS are not responsible for the content sent using HD Radio technology. Content may be changed, added or deleted at any time at the station owner's discretion.

### CD (If Equipped)

Once you select this option, the system returns you to the main audio screen.

The current audio information appears on the screen.

### The following buttons are also available:

Button	Function
Browse	You can use the browse button to select a track.
Repeat	Select this button and a small number one displays to indicate the track is set to repeat.

## SYNC™ 3 (If Equipped)

Button	Function
	For MP3 CDs, this button allows you to toggle through repeat off, repeat one track (a small number one displays), and repeat current folder (a small folder displays).
Shuffle	Select the shuffle symbol to have the audio on the disk play in random order.

You can use the forward, reverse, pause or play buttons to control the audio playback.

### **Bluetooth® Stereo or USB**

**Bluetooth®** Stereo and USB allow you to access media that you store on your **Bluetooth®** device or USB device such as music, audio books or podcasts.

### **The following buttons are available for Bluetooth® and USB:**

Button	Function
Repeat	Pressing the repeat button toggles the repeat setting through three modes: repeat off (button not highlighted), repeat all (button highlighted) and repeat track (button highlighted with a small number one).
Shuffle	Play the tracks in random order.

You can use the forward, reverse, pause or play buttons to control the audio playback.

To get more information about the currently playing track, press the cover art or Info button.

For some devices, SYNC 3 is able to provide 30-second skip buttons when you listen to audio books or podcasts. These buttons allow you to skip forward or backward within a track.

While playing audio from a USB device you can look for certain music by selecting the following:

Button	Function
Browse	If available, displays the list of tracks in the Now Playing playlist.
New Search	This option, which is available under browse, allows you to play all tracks or to filter the available media into one of the below categories.
	Play All

# SYNCTM 3 (If Equipped)

Button	Function
	Playlists
	Artist
	Albums
	Songs
	Genres
	Podcasts
	Audio books
	Composers
A-Z Jump	This button allows you to choose a specific letter to view within the category you are browsing.
Explore Device	If available, this allows you to browse the folders and files on your USB device.

## USB Ports



E211463

The USB ports are in the center console or behind a small access door in the instrument panel.

This feature allows you to plug in USB media devices, memory sticks, flash drives or thumb drives, and charge devices if they support this feature.

Select this option to play audio from your USB device.

## Apps

The system supports the use of certain audio apps such as iHeartRadio through a USB or **Bluetooth**®-enabled device.

Each app gives you different on-screen options depending on the app's content. See **Apps** (page 580).

## Supported Media Players, Formats and Metadata Information

The system is capable of hosting nearly any digital media player, including iPod, iPhone, and most USB drives.

Supported audio formats include MP3, WMA, WAV, AAC, and FLAC.

Supported audio file extensions include MP3, WMA, WAV, M4A, M4B, AAC, and FLAC.

# SYNC™ 3 (If Equipped)

Supported USB file systems include: FAT, exFAT, and NTFS.

SYNC 3 is also able to organize the media from your USB device by metadata tags. Metadata tags, which are descriptive software identifiers embedded in the media files, provide information about the file.

If your indexed media files contain no information embedded in these metadata tags, SYNC 3 may classify the empty metadata tags as unknown.

SYNC 3 is capable of indexing up to 50,000 songs per USB device, for up to 10 devices.

## CLIMATE

Touch the climate button on the touchscreen to access your climate control features.

**Note:** You can switch temperature units between Fahrenheit and Celsius. See **Settings** (page 582).

### Accessing the Climate Control Menu



Touch the button to access additional controls for the front climate system.

### Directing the Airflow



Touch the button to direct airflow to the windshield air vents and de-mister.



Touch the button to direct airflow to the instrument panel air vents.



Touch the button to direct airflow to the footwell air vents.

You can direct air through any combination of these air vents.

### Setting the Blower Motor Speed



Touch up or down to increase or decrease the volume of air that circulates in your vehicle.

### Setting the Temperature

Touch up or down on the left-hand temperature control to set the left-hand temperature.

**Note:** This control also adjusts the right-hand side temperature when you switch off dual zone mode.

Touch up or down on the right-hand temperature control to set the right-hand temperature.

### Switching Auto Mode On and Off



Touch the button to switch on automatic operation, then set the temperature.

The system adjusts the blower motor speed, air distribution, air conditioning operation, and outside or recirculated air to reach and maintain the temperature you have set.

### Switching the Air Conditioning On and Off



A pop-up appears on the screen to display the air conditioning options.

**MAX A/C:** Touch the button to activate and maximize cooling. The driver and passenger temperatures are set to LO, recirculated air flows through the instrument panel vents, air conditioning automatically turns on and the fan automatically adjusts to the highest speed.

**A/C:** Touch to switch the air conditioning on or off. Use A/C with recirculated air to improve cooling performance and efficiency.

**Note:** In certain conditions, such as maximum defrost, the air conditioning compressor may continue to operate even though you switch off the air conditioning.

## Switching the Climate Control On and Off



Touch the button.

## Switching the Climate Controlled Seats On and Off



Touch the button to cycle through the various climate controlled seat settings.

## Switching Dual Zone Mode On and Off



Touch the button to switch on temperature control for the right-hand side of the vehicle.

## Switching the Heated Exterior Mirrors On and Off



Touch the button.

## Switching the Heated Windshield On and Off



Touch the button to clear the windshield of thin ice and fog. The heated windshield turns off after a short period of time.

## Switching the Heated Rear Window On and Off



Touch the button to clear the rear window of thin ice and fog.

## Switching the Heated Seats On and Off



Touch the button to cycle through the various heat settings.

## Switching the Heated Steering Wheel On and Off



Touch the button.

## Switching Maximum Air Conditioning On and Off



Touch the button for maximum cooling.

Recirculated air flows through the instrument panel air vents, air conditioning turns on and the blower motor adjusts to the highest speed.

## Switching Maximum Defrost On and Off



Touch the button for maximum defrosting.

Air flows through the windshield air vents, and the blower motor adjusts to the highest speed.

You can also use this setting to defog and clear the windshield of a thin covering of ice.

**Note:** To prevent window fogging, you cannot select recirculated air when maximum defrost is on.

## SYNC™ 3 (If Equipped)

**Note:** The heated rear window also turns on when you select maximum defrost.

### Switching Recirculated Air On and Off



Touch the button to switch between outside air and recirculated air.

The air currently in the passenger compartment recirculates. This may reduce the time needed to cool the interior, when used with **A/C**, and reduce unwanted odors from entering your vehicle.

**Note:** Recirculated air may turn off, or prevent you from switching on, in all air flow modes except **MAX A/C** to reduce the risk of fogging. Recirculation may also turn on and off in various air distribution control combinations during hot weather to improve cooling efficiency.

### Switching the Ventilated Seats On and Off



Touch the button to cycle through the various ventilated seat settings.

### Accessing Rear Climate Controls



Touch the button to access additional controls for the rear climate system.

### Rear Climate Control Lock Indicator



Touch the button.

When on, you can only operate the rear passenger settings through the front controls.

### Switching Rear Auto Mode On and Off



Touch the button to switch on rear automatic operation, then set the temperature.

### Switching the Rear Climate Controlled Seats On and Off



Touch the button to cycle through the various climate controlled seat settings.

### Switching the Rear Heated Seats On and Off



Touch the button to cycle through the various heat settings.

### Switching the Rear Ventilated Seats On and Off



Touch the button to cycle through the various ventilated seat settings.

## PHONE



**WARNING:** Driving while distracted can result in loss of vehicle control, crash and injury. We strongly recommend that you use extreme caution when using any device that may take your focus off the road. Your primary responsibility is the safe operation of your vehicle. We recommend against the use of any hand-held device while driving and encourage the use of voice-operated systems when possible. Make sure you are aware of all applicable local laws that may affect the use of electronic devices while driving.

Check the compatibility of your device on the regional website.

## Pairing Your Cell Phone for the First Time

Go to the settings menu on your cell phone and switch Bluetooth on.



Select the phone option on the feature bar.

1. Select **Add Phone**.

**Note:** A prompt alerts you to search for your vehicle on your cell phone.

2. Select your vehicle on your cell phone.

**Note:** A number appears on your cell phone and on the touchscreen.

3. Confirm that the number on your cell phone matches the number on the touchscreen.

**Note:** The touchscreen indicates that you have successfully paired your cell phone.

4. Download the phonebook from your cell phone when you are prompted.

**Note:** If you pair more than one cell phone, use the phone settings to specify the primary phone. You can change this setting at any time.

## Using Your Cell Phone

This menu becomes available after pairing a phone.

### Recent Call List

Display and select an entry from a list of previous calls.

### Contacts

Display a smart search form to look up your contacts. Use the List button to alphabetically sort your contacts.

### Favorites

Display the list of favorite contacts that are set up on your phone.

### Messaging

Displays the list of text messages to read, listen to, or respond to.

### Email

Displays the list of emails to read, listen to, or respond to.

### Phone List

Display the list of paired or connected devices that you can select.

**Note:** Up to 12 devices can be stored.

### Do Not Disturb

Reject incoming calls and switch ring tones and alerts off.

### Phone Keypad

Directly dial a number.

### Voice Control

Say a command to use the Google or Siri voice assistant available on your connected phone to access supported features.

**Note:** Some features under the phone menu may not be available if the feature is not supported through the phone.

### Text Messaging

### Setting Text Message Notification

#### iOS

1. Go to the settings menu on your cell phone.
2. Select Bluetooth.
3. Select the information icon to the right of your vehicle.



## SYNC™ 3 (If Equipped)

4. Switch text message notification on.

2. Select Bluetooth.

3. Select the profiles option.

4. Select the phone profile.

5. Switch text message notification on.

### Android

1. Go to the settings menu on your cell phone.

### Using Text Messaging

Menu Item	Description
Hear It	Hear the text message.
View	View the text message.
Call	Call the sender.
Reply	Reply to the text message with a standard text message.

### Apple CarPlay (If Equipped)

1. Connect your device to a USB port.
2. Follow the instructions on the touchscreen.

**Note:** Certain features of the system are not available when you are using Apple CarPlay.

### Switching Apple CarPlay Off



Select the settings option on the feature bar.

1. Select **Apple CarPlay Preferences**.
2. Switch **Apple CarPlay** off.

### Android Auto (If Equipped)

1. Connect your device to a USB port.
2. Follow the instructions on the touchscreen.

**Note:** You might need to enable Android Auto from the settings menu.

**Note:** Certain features of the system are not available when you are using Android Auto.

### Switching Android Auto Off



Select the settings option on the feature bar.

1. Select **Android Auto**.
2. Switch **Android Auto** off.

### NAVIGATION (IF EQUIPPED)

**Note:** For more information, refer to our website.



Select the navigation option on the feature bar.

## SYNC™ 3 (If Equipped)

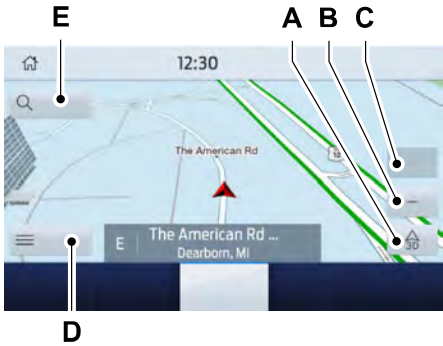

- A Map view menu.
- B Zoom out.
- C Zoom in.
- D Route guidance menu.
- E Destination entry menu.

### Setting a Destination

#### Destination Entry Menu

Item	Description
Search	Enter a destination address.
Previous Destinations	Display and select from a list of previous destinations.
Home	Set your saved home address as your destination
Work	Set your saved place of work as your destination.
Favorites	Display and select from a list of favorite destinations.

## Setting a Destination Using the Text Entry Screen

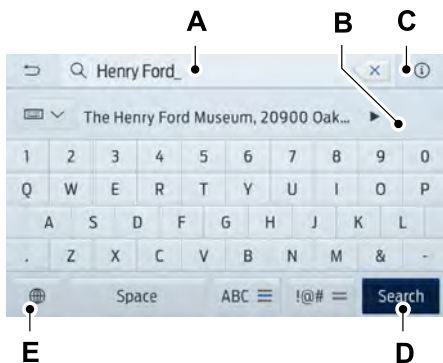

- A Text entry field.
- B Automatic suggestions based on the text you enter.
- C Information icon.
- D Search.
- E Keyboard settings.

**Note:** Select one of the suggestions to copy the detail to the text entry field.

You can search by entering all or part of the destination, such as the Address, POI Category or Name, Intersection, City, Latitude/Longitude, etc. **Tips:** If you do not specify a location, the system will use the current vehicle location. You can specify a location by address, city, state or zip code. For additional search support, please visit: [support.ford.com](http://support.ford.com).

**Note:** Press the button in the top right-hand corner of the main map to display estimated time of arrival, remaining travel time or distance to destination.

## Setting a Destination Using the Map Screen



- A Re-center the map.
- B Selected location.
- C 3D map rotation. Swipe left or right.
- D Start route guidance.
- E Destination name.

Select the location on the map.  
Select **Start** to begin route guidance.

## Changing the Format of the Map

Display the map in one of the following formats:

- A two-dimensional map with the direction you are traveling toward the top of the screen.
- A two-dimensional map with north toward the top of the screen.
- A three-dimensional map with the direction you are traveling toward the front.

## Zoom

Display more or less detail on the map.

## SYNC™ 3 (If Equipped)

**Note:** You can use pinch gestures to zoom in and out. Place two fingers on the screen and move them apart to zoom in. Place two fingers on the screen and bring them together to zoom out.

### Route Guidance

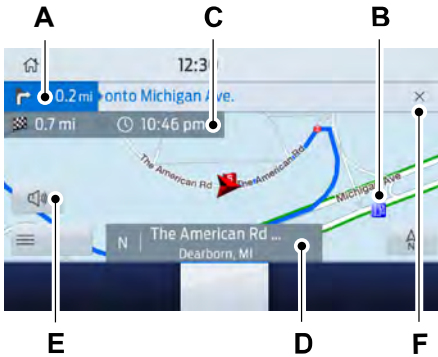

- C Estimated time of arrival, distance to destination or time to destination.
- D Current road.
- E Mute guidance prompts.
- F Cancel route guidance.

**Note:** To change guidance prompt volume, turn the volume control when a guidance prompt plays.

- A Turn indicator. Select to hear the last voice prompt.
- B Point of interest.

### Route Guidance Menu

Menu Item	Description
Screen View	Adjust your map preferences for when route guidance is active.
Full Map	View a full screen map when route guidance is active.
Highway Exit Info	View highway exit information for your current route.
Turn List	View the turn list for your current route. Select a road to avoid it.
Traffic List	You can find the SiriusXM Traffic and Travel Link information by pressing this button. This information requires an active subscription to SiriusXM Traffic and Travel Link. When a route is not active, a list of nearby traffic incidents displays. When a route is active, you can choose to display a list of traffic nearby or on the route.

# SYNC™ 3 (If Equipped)

Menu Item	Description
Navigation Settings	Adjust navigation settings. See <b>Settings</b> (page 582).
Where Am I?	View information about your current location.
Cancel Route	Cancel route guidance.
View Route	View the entire current route on the map.
Detour	View an alternative route compared to your current one.
Edit Waypoints	Change the order or remove waypoints.
Optimize Order	The system determines the order of waypoints for you.
Go	Go to the next screen and start the new route.

## Adjusting the Guidance Prompt Volume

Turn the volume control when a guidance prompt plays to adjust the volume.

**Note:** *If you have inadvertently adjusted the volume to zero, press the turn indicator button to play the last voice prompt and then adjust the volume to the desired level.*

## Muting Guidance Prompts



Select the mute option on the screen to mute guidance prompts.

**Note:** *The system mutes the next and all future guidance prompts.*

## Adding Waypoints

You can add a waypoint to a navigation route as a destination along your route. You can add up to five waypoints.

1. Select the search option on the map.
2. Set a destination.
3. Select **Add Waypoint**.
4. Select **Go**.

## Canceling Route Guidance



Select the route guidance menu option on the active guidance screen.

Select **Cancel Route**.

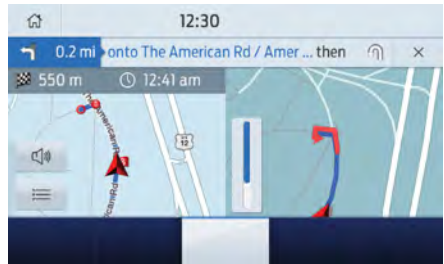

**Note:** *The route guidance menu option is always in the bottom right-hand corner of the main map.*

## cityseeker (If Equipped)

**Note:** *cityseeker point of interest (POI) information is limited to approximately 1,110 cities (1,049 in the United States, 36 in Canada and 15 in Mexico).*



E225487

cityseeker, when available, is a service that provides more information about certain points of interest such as restaurants, hotels and attractions.

When you have selected a point of interest, the location and information appear, such as address, phone number and a star rating.

Press **More Information** to see a photo, a review, a list of services and facilities, the average room or meal price and the web address. This screen displays the point of interest icons.

For restaurants, cityseeker can provide information such as star rating, average cost, review, handicap access, hours of operation, and website address.

For hotels, cityseeker can provide information such as star rating, price category, review, check-in and checkout times, hotel service icons and website address. Hotel service icons include:

- Restaurant
- Business center
- Handicap facilities
- Laundry
- Refrigerator
- 24 hour room service
- Fitness center
- Internet access
- Pool
- Wi-Fi

Attractions include nearby landmarks, amusement parks, historic buildings and more. cityseeker can provide information such as star rating, reviews, hour of operation and admission price.

### **SiriusXM Traffic and Travel Link (If Equipped)**

SiriusXM Traffic and Travel Link is available on vehicles equipped with navigation and only in select markets. You must activate and subscribe to receive SiriusXM Traffic and Travel Link information. It helps you locate the best gas prices, find movie listings, get current traffic alerts, view the weather map, get accurate ski conditions and see current sports scores.

The system calculates a reasonable efficient route based on available speed limits, traffic, and road conditions. You may know a local short cut that is more efficient at a given time than the route provided by SYNC 3, but you should expect a slight difference in minutes or miles with the SYNC 3 route.

### **Michelin Travel Guide (If Equipped)**

The Michelin travel guide is a service which provides additional information about certain places of interest, for example restaurants, hotels and tourist sites. Points of interest that have Michelin travel guide information display a button to show you more information. Push the button to see the additional information. If you have paired your phone with the system, you can press the phone button to directly establish a call with the selected point of interest.

## Navigation Map Accuracy and Updates

HERE is the digital map provider for the navigation application. If you find map data errors, you may report them directly to HERE by going to [www.here.com](http://www.here.com). HERE evaluates all reported map errors and responds with the result of their investigation by e-mail.

The navigation system map data may contain inaccurate or incomplete information due to the passage of time, changing circumstances, sources used and the nature of collecting comprehensive geographic data, any of which may lead to incorrect results. Inaccurate speed limit information, turn restrictions and other road attributes may affect the determined route and associated guidance.

Annual navigation map updates are available for purchase through your dealership. Depending on your purchase agreement, you might be eligible for free Map update. You can choose to download the Map data update onto a USB, order a USB, or use Wi-Fi to deliver automatic updates. To update your Map data over Wi-Fi, your vehicle must be connected to a Wi-Fi access point. Map Data files are large, so it is highly recommended to perform the update when free Wi-Fi is available otherwise high data rates may apply. For USB updates, free map update eligibility, and other details, contact dealers at 1-866-462-8837 in the United States and Canada or 01-800-557-5539 in Mexico or visit our local website for more information.

## APPS

The system allows you interact with select mobile apps while keeping your eyes on the road. Voice commands, your steering wheel buttons, or a quick tap on your touchscreen give you advanced control of compatible mobile apps. You can also stream your favorite music or podcasts, share your time of arrival with friends, and keep connected safely.

When you start an app through the system for the first time, you could be asked to grant certain permissions. You can review and change the permissions that you have granted at any time when your vehicle is not moving. We recommend that you check your data plan before using your apps through the system. Using them could result in additional charges. We also recommend that you check the app provider's terms and conditions and privacy policy before using their app. Make sure that you have an active account for apps that you want to use through the system. Some apps will work with no setup. Others require you to configure some personal settings before you can use them.

**Note:** For more information about available apps, visit [catalog.ford.com](http://catalog.ford.com).

### Using Apps on an iOS Device



Select the apps option on the feature bar.

1. If your device is connected via USB, switch Apple CarPlay off. See **Phone** (page 572).
2. Connect your device to a USB port or pair and connect using Bluetooth.
3. If prompted to enable CarPlay, select **Disable**.
4. Start the apps on your device that you want to use through SYNC.

## SYNC™ 3 (If Equipped)

**Note:** If you close the apps on your device, you will not be able to use them through the system.

4. Select the app that you want to use on the touchscreen.

**Note:** Connect your device to a USB port if you want to use a navigation app. When using a navigation app, keep your device unlocked and the app open.

### Using Apps on an Android Device



Select the apps option on the feature bar.

1. If your device is connected via USB, switch Android Auto off. See **Phone** (page 572).
2. Pair your device. See **Phone** (page 572).
3. Start the apps on your device that you want to use through SYNC.

**Note:** If you close the apps on your device, you will not be able to use them through the system.

4. Select **Find Mobile Apps**.

**Note:** The system searches and connects to compatible apps that are running on your device.

5. Select the app that you want to use on the touchscreen.

**Note:** Mobile Apps on your device use the USB port to establish a connection with SYNC. Some devices may lose the ability to play music over USB when Mobile Apps are enabled.

### Using Mobile Navigation on an Android Device

1. Connect your device to a USB port.
2. Switch Android Auto off. See **Phone** (page 572).
3. Switch on **Enable Mobile Apps via USB** in the Mobile Apps Settings tile.

4. Select the apps option on the feature bar.
5. Select the navigation app that you want to use on the touchscreen.

**Note:** When using a navigation app, keep your device unlocked and the app open.

### SiriusXM Traffic and Travel Link (If Equipped)



**WARNING:** Driving while distracted can result in loss of vehicle control, crash and injury. We strongly recommend that you use extreme caution when using any device that may take your focus off the road. Your primary responsibility is the safe operation of your vehicle. We recommend against the use of any hand-held device while driving and encourage the use of voice-operated systems when possible. Make sure you are aware of all applicable local laws that may affect the use of electronic devices while driving.

**Note:** SiriusXM Traffic and Travel Link may not be available in all markets.

**Note:** In order to use SiriusXM Traffic and Travel Link, your vehicle must have navigation.

**Note:** A paid subscription is required to access and use these features. Go to [www.siriusxm.com/travellink](http://www.siriusxm.com/travellink) for more information.

**Note:** Visit [www.siriusxm.com/traffic](http://www.siriusxm.com/traffic) and click on Coverage map and details for a complete listing of all traffic areas covered by SiriusXM Traffic and Travel Link.

**Note:** Neither Sirius nor Ford is responsible for any errors or inaccuracies in the SiriusXM Traffic and Travel Link services or its use in vehicles.



## SYNC™ 3 (If Equipped)

When you subscribe to SiriusXM Traffic and Travel Link, it can help you locate the best gas prices, find movie listings, get

current traffic alerts, view the current weather map, get accurate ski conditions and see scores to current sports games.

Menu Item	Action and Description	
Traffic on Route	Touch these buttons to identify traffic incidents on your route, near your vehicle's current location or near any of your favorite places, if programmed.	
Traffic Nearby		
Fuel Prices	Touch this button to view fuel prices at stations close to your vehicle's location or on an active navigation route.	
Movie Listings	Touch this button to view nearby movie theaters and their show times, if available.	
Weather	Touch this button to view the nearby weather, current weather, or the five-day forecast for the chosen area.	
	Map	Select to see the weather map, which can show storms, radar information, charts and winds.
	Area	Select to choose from a listing of weather locations.
Sports Info	Touch this button to view scores and schedules from a variety of sports. You can also save up to 10 favorite teams for easier access. The score automatically refreshes when a game is in progress.	
Ski Conditions	Touch this button to view ski conditions for a specific area.	

## SETTINGS



Press the button to enter the settings menu.



Once you select a tile, press the button next to a menu item to view an explanation of the feature or setting.

### Sound

Select this tile to adjust the sound settings.

### Clock

Select this tile to adjust the clock settings.

### Bluetooth®

Select this tile to switch **Bluetooth®** on and off and adjust the settings.

### Phone

Select this tile to connect, disconnect, and manage the connected device settings.

### Audio

Select this tile to adjust the audio settings.

# SYNCTM 3 (If Equipped)

---

## **Driver Assist (If Equipped)**

Select this tile to adjust Driver Assist features like Parking Aids, Lane Keeping System, Pedestrian Detection, and Auto-Start-Stop.

## **Vehicle**

Select this tile to adjust vehicle settings like windows, alarm, lighting, and MyKey settings.

## **FordPass (If Equipped)**

Select this tile to adjust the FordPass settings

## **General**

Select this tile to adjust settings like language, measurement units, or to reset the system.

## **911 Assist (If Equipped)**

Select this tile to switch 911 Assist on and off.

## **Automatic Updates**

Select this tile to adjust the automatic update settings.

## **Mobile Apps**

Select this tile to adjust permissions, enable, disable, and update mobile apps.

## **Display**

Select this tile to adjust display settings like brightness and auto dim.

## **Charge Settings (If Equipped)**

Select this tile to adjust the electric vehicle charge settings.

## **Voice Control**

Select this tile to adjust voice control settings like command confirmations and displayed lists.

## **Navigation (If Equipped)**

Select this tile to adjust navigation settings like map preferences and route guidance.

## **Seats (If Equipped)**

Select this tile to adjust the lumbar function and massage function of your multi contour seats.

## **Message Center (If Equipped)**

Select this tile to view vehicle messages.

## **Personal Profiles (If Equipped)**

Select this tile to adjust recalled memory features when using personal profiles.

## **Valet Mode (If Equipped)**

Select this tile to enable and disable valet mode.

## **Ambient Lighting (If Equipped)**

Select this tile to change the color or intensity of the interior lighting.

## SYNC™ 3 TROUBLESHOOTING

### Voice Recognition

Symptom	Possible Cause and Resolution
The system does not understand what I am saying.	<ul style="list-style-type: none"> <li>- You might not be using supported voice commands.                             <ul style="list-style-type: none"> <li>• See <b>Using Voice Recognition</b> (page 554).</li> <li>• For a complete list of voice commands, refer to our website.</li> </ul> </li> <li>- You might be speaking too soon.                             <ul style="list-style-type: none"> <li>• Wait for the voice prompt before you speak.</li> </ul> </li> </ul>
The system does not understand the name of a track or artist.	<ul style="list-style-type: none"> <li>- Device limitation. <b>Bluetooth®</b> does not support voice commands.                             <ul style="list-style-type: none"> <li>• Connect your device to a USB port.</li> <li>• If you have an iOS device, press and hold the voice control button on the steering wheel to use Siri to play specific tracks.</li> </ul> </li> <li>- You might not be using supported voice commands.                             <ul style="list-style-type: none"> <li>• See <b>Using Voice Recognition</b> (page 554).</li> <li>• For a complete list of voice commands, refer to our website.</li> </ul> </li> <li>- You might not be saying the name exactly as it appears on your device.                             <ul style="list-style-type: none"> <li>• Say the name of the track or artist exactly as it appears on your device. Spell out any abbreviations in the name.</li> </ul> </li> <li>- The name contains special characters, for example *, - or +.                             <ul style="list-style-type: none"> <li>• Rename the files on your device or use the touchscreen to select and play the track.</li> </ul> </li> </ul>
The system does not understand the name of a contact in the phonebook on my device and calls the wrong contact.	<ul style="list-style-type: none"> <li>- You might not be saying the name exactly as it appears on your device.                             <ul style="list-style-type: none"> <li>• Say the first and last name of the contact exactly as it appears on your device. Spell out any abbreviations in the name.</li> </ul> </li> <li>- The name contains special characters, for example *, - or +.                             <ul style="list-style-type: none"> <li>• Rename the contact on your device or use the touchscreen to select and call the contact.</li> </ul> </li> </ul>

## SYNCTM 3 (If Equipped)

Symptom	Possible Cause and Resolution
The system does not understand certain names of contacts in the phonebook on my device.	<ul style="list-style-type: none"><li>– You might not be saying the name exactly as it appears on your device.<ul style="list-style-type: none"><li>• Say the first and last name of the contact exactly as it appears on your device. The system applies phonetic pronunciation rules of the selected language to the names of contacts in the phonebook on your device. Select the name of the contact on the touchscreen and use the Hear it option to get an idea of how the system expects you to pronounce it.</li></ul></li></ul>
The system voice prompts and the pronunciation of some words do not seem to be very accurate.	<ul style="list-style-type: none"><li>– Device limitation.<ul style="list-style-type: none"><li>• The system uses text-to-speech technology and uses a synthetically generated voice rather than pre-recorded human voice.</li></ul></li></ul>

### USB and Bluetooth® Audio

Symptom	Possible Cause and Resolution
I cannot connect my device.	<ul style="list-style-type: none"><li>– Device malfunction.<ul style="list-style-type: none"><li>• Disconnect your device. Switch your device off and on to reset it and try again.</li></ul></li><li>– Cable connection issue.<ul style="list-style-type: none"><li>• Correctly connect the cable to your device and the vehicle USB port.</li></ul></li><li>– Incompatible cable.<ul style="list-style-type: none"><li>• Use the cable recommended by the manufacturer of your device.</li></ul></li></ul>

## SYNC™ 3 (If Equipped)

Symptom	Possible Cause and Resolution
	<ul style="list-style-type: none"> <li>– Incorrect device settings.               <ul style="list-style-type: none"> <li>• Make sure that your device does not have an auto-install program or active security settings.</li> <li>• Check that your device is not set only to charge.</li> </ul> </li> <li>– Device lock screen enabled.               <ul style="list-style-type: none"> <li>• Unlock your device before connecting it.</li> </ul> </li> </ul>
<p>The system does not recognize my device.</p>	<ul style="list-style-type: none"> <li>– Device limitation.               <ul style="list-style-type: none"> <li>• Do not leave your device in your vehicle during very hot or very cold weather conditions.</li> </ul> </li> <li>– Cable connection issue.               <ul style="list-style-type: none"> <li>• Correctly connect the cable to your device and the vehicle USB port.</li> </ul> </li> <li>– Incompatible cable.               <ul style="list-style-type: none"> <li>• Use the cable recommended by the manufacturer of your device.</li> </ul> </li> </ul>
<p>The system does not understand the name of a track or artist.</p>	<ul style="list-style-type: none"> <li>– Device limitation. <b>Bluetooth®</b> does not support voice commands.               <ul style="list-style-type: none"> <li>• Connect your device to a USB port.</li> <li>• If you have an iOS device, press and hold the voice control button on the steering wheel to use Siri to play specific tracks.</li> </ul> </li> </ul>
<p>I cannot stream audio from my <b>Bluetooth®</b> device.</p>	<ul style="list-style-type: none"> <li>– Incompatible device.               <ul style="list-style-type: none"> <li>• Check the compatibility of your device on our website.</li> </ul> </li> <li>– Device not connected.               <ul style="list-style-type: none"> <li>• Pair your device. See <b>Phone</b> (page 572).</li> </ul> </li> <li>– Media player not running.               <ul style="list-style-type: none"> <li>• Start the media player on your device.</li> </ul> </li> </ul>
<p>The system does not recognize the music on my device.</p>	<ul style="list-style-type: none"> <li>– Missing or incorrect audio file metadata, for example artist, song title, album or genre.               <ul style="list-style-type: none"> <li>• Repair the files on your device.</li> </ul> </li> <li>– Corrupt files.               <ul style="list-style-type: none"> <li>• Repair the files on your device.</li> </ul> </li> </ul>

## SYNC™ 3 (If Equipped)

Symptom	Possible Cause and Resolution
	<ul style="list-style-type: none"> <li>– Copyright-protected files.               <ul style="list-style-type: none"> <li>• Use a device that contains files that are not copyright protected.</li> </ul> </li> <li>– Unsupported file format.               <ul style="list-style-type: none"> <li>• Repair or convert the files to a supported format. See <b>Entertainment</b> (page 560).</li> </ul> </li> <li>– Device indexing required.               <ul style="list-style-type: none"> <li>• Re-index your device. See <b>Settings</b> (page 582).</li> </ul> </li> <li>– Device lock screen enabled.               <ul style="list-style-type: none"> <li>• Unlock your device before connecting it.</li> </ul> </li> </ul>
Sometimes I cannot hear a track playing on my device.	<ul style="list-style-type: none"> <li>– Device malfunction.               <ul style="list-style-type: none"> <li>• Disconnect your device. Switch your device off and on to reset it and try again.</li> </ul> </li> </ul>
When I disconnect my iOS device the audio volume is set to maximum.	<ul style="list-style-type: none"> <li>– Device limitation.               <ul style="list-style-type: none"> <li>• Turn the volume down on your device.</li> </ul> </li> </ul>
The system does not play the tracks on my USB drive in the correct order.	<p>If the system does not play the tracks on your USB device in the correct order, the following information could help:</p> <ul style="list-style-type: none"> <li>– If you are selecting USB as the audio source when the system is still indexing, SYNC plays tracks sorted alphabetically by file name in the root directory.</li> <li>– If you are selecting USB as the audio source after the system has finished indexing, SYNC plays all tracks sorted alphabetically by the title in the ID3 tag regardless of where they are located. SYNC uses the file name if the title in the ID3 tag does not exist.</li> <li>– If you are selecting the option to play all tracks from the browsing menu, SYNC plays all tracks sorted alphabetically by the title in the ID3 tag regardless of where they are located. SYNC uses the file name if the title in the ID3 tag does not exist.</li> <li>– If you are selecting a track when using the explore device option, SYNC plays tracks sorted alphabetically by file name in the folder you have selected. SYNC then plays all tracks in any subfolders in the folder you have selected.</li> </ul>

## SYNC™ 3 (If Equipped)

### Phone

Symptom	Possible Cause and Resolution
During a call, I can hear excessive background noise.	<ul style="list-style-type: none"><li>– Incorrect cell phone settings.<ul style="list-style-type: none"><li>• Check and adjust the audio settings on your cell phone. Refer to your cell phone's user manual.</li></ul></li></ul>
During a call, I can hear the other person but they cannot hear me.	<ul style="list-style-type: none"><li>– Cell phone malfunction.<ul style="list-style-type: none"><li>• Switch your cell phone on and off, and vehicle <b>Bluetooth®</b> on and off and try again.</li></ul></li><li>– Cell phone microphone muted.<ul style="list-style-type: none"><li>• Unmute your cell phone microphone.</li></ul></li></ul>
During a call, I cannot hear the other person and they cannot hear me.	<ul style="list-style-type: none"><li>– System restart required.<ul style="list-style-type: none"><li>• Switch the ignition off and open the door. Close the door and lock the vehicle. Wait until the touchscreen is off and any illuminated USB ports are not illuminated. Unlock the vehicle, switch the ignition on and try again.</li></ul></li></ul>
I cannot download a phonebook.	<ul style="list-style-type: none"><li>– Incompatible cell phone.<ul style="list-style-type: none"><li>• Check the compatibility of your cell phone on our website.</li></ul></li><li>– Incorrect cell phone settings.<ul style="list-style-type: none"><li>• Allow the system to retrieve contacts from your cell phone. Refer to your cell phone's user manual.</li></ul></li><li>– Incorrect system settings.<ul style="list-style-type: none"><li>• Switch automatic phonebook download on. See <b>Settings</b> (page 582).</li></ul></li><li>– Cell phone malfunction.<ul style="list-style-type: none"><li>• Switch your cell phone off and on to reset it and try again.</li></ul></li></ul>

## SYNC™ 3 (If Equipped)

Symptom	Possible Cause and Resolution
<p>A message displays suggesting that my phonebook has downloaded but it is empty or it has missing contacts.</p>	<ul style="list-style-type: none"> <li>– Incorrect cell phone settings.               <ul style="list-style-type: none"> <li>• Allow the system to retrieve contacts from your cell phone. Refer to your cell phone's user manual.</li> <li>• Check the location of the missing contacts on your cell phone. If they are stored on the SIM card, move them to the cell phone memory.</li> </ul> </li> <li>– Incorrect system settings.               <ul style="list-style-type: none"> <li>• Switch automatic phonebook download on. See <b>Settings</b> (page 582).</li> </ul> </li> </ul>
<p>I cannot connect my cell phone.</p>	<ul style="list-style-type: none"> <li>– Incompatible cell phone.               <ul style="list-style-type: none"> <li>• Check the compatibility of your cell phone on our website.</li> </ul> </li> <li>– Cell phone malfunction.               <ul style="list-style-type: none"> <li>• Switch your cell phone off and on to reset it and try again.</li> <li>• Install the latest cell phone firmware.</li> <li>• Delete your device from the system and delete SYNC from your device and try again.</li> <li>• Switch automatic phonebook download off. See <b>Settings</b> (page 582).</li> </ul> </li> </ul>
<p>Text messaging does not work.</p>	<ul style="list-style-type: none"> <li>– You might not have switched on text message notifications.               <ul style="list-style-type: none"> <li>• Switch text message notifications on. See <b>Phone</b> (page 572).</li> </ul> </li> <li>– Incompatible cell phone.               <ul style="list-style-type: none"> <li>• Check the compatibility of your cell phone on our website.</li> </ul> </li> <li>– Cell phone malfunction.               <ul style="list-style-type: none"> <li>• Switch your cell phone off and on to reset it and try again.</li> </ul> </li> </ul>
<p>I cannot hear text messages.</p>	<ul style="list-style-type: none"> <li>– Device message sharing is not enabled.               <ul style="list-style-type: none"> <li>• Check the permissions on your device to ensure text message sharing is enabled.</li> </ul> </li> <li>– Incompatible cell phone.               <ul style="list-style-type: none"> <li>• Check the compatibility of your cell phone on our website.</li> </ul> </li> </ul>



# SYNC™ 3 (If Equipped)

## Navigation (If Equipped)

Symptom	Possible Cause and Resolution
I cannot enter a street name when I am abroad.	<ul style="list-style-type: none"><li>- Incorrect entry method.<ul style="list-style-type: none"><li>• Enter the street name with the country.</li></ul></li></ul>
The system does not recognize coordinates.	<ul style="list-style-type: none"><li>- Using the wrong coordinates format.<ul style="list-style-type: none"><li>• Use the format ##. #####, ##. ##### (for N/S, E/W). Add a minus before coordinates if the direction is West and keep a positive value if the direction is East, for example 12.5412 means East and -12.5412 means West.</li></ul></li></ul>

# SYNC™ 3 (If Equipped)

## Apps

Symptom	Possible Cause and Resolution
The system cannot find any apps.	<ul style="list-style-type: none"><li>– Incompatible device.<ul style="list-style-type: none"><li>• You need an Android device with OS 4.3 or higher or an iOS device with iOS 8.0 or higher. Pair and connect your Android device to find compatible apps. Connect your iOS device to a USB port or pair and connect using <b>Bluetooth®</b>.</li></ul></li></ul>
I have a compatible device and it is correctly connected but the system still cannot find any apps.	<ul style="list-style-type: none"><li>– Compatible apps are not installed on your device.<ul style="list-style-type: none"><li>• Download and install the latest version of the app.</li></ul></li><li>– Compatible apps are not running on your device.<ul style="list-style-type: none"><li>• Start the apps to allow the system to find them and make sure you sign in to any apps if required.</li></ul></li><li>– Incorrect app settings.<ul style="list-style-type: none"><li>• Check and adjust the app settings on your device and allow SYNC to access the app if required.</li></ul></li></ul>
I have a compatible device, it is correctly connected and my apps are running but the system still cannot find any apps.	<ul style="list-style-type: none"><li>– Apps failed to fully close.<ul style="list-style-type: none"><li>• Restart the apps and try again.</li><li>• If you have an Android device with apps that have an exit or quit option, use this and then restart the apps. Alternatively, use the force stop option in the settings menu on your device.</li><li>• If you have an iOS device with iOS 8.0 or higher, tap the home button on your device twice and then swipe the app upward to close it.</li></ul></li></ul>
I have an Android device that is correctly connected, I have restarted my apps and they are running but the system still cannot find them.	<ul style="list-style-type: none"><li>– An issue on some older versions of the Android operating system could result in apps not being found.<ul style="list-style-type: none"><li>• Switch <b>Bluetooth®</b> off and on again to force the system to reconnect to your device.</li></ul></li></ul>

## SYNC™ 3 (If Equipped)

Symptom	Possible Cause and Resolution
I have an iOS device that is correctly connected, I have restarted my apps and they are running but the system still cannot find them.	<ul style="list-style-type: none"><li>– Cable connection issue.<ul style="list-style-type: none"><li>• Disconnect the cable from your device, wait for a moment and then connect it again to force the system to reconnect to your device.</li></ul></li></ul>
I have an Android device running a media app which the system has found but I cannot hear the sound or the sound is very quiet.	<ul style="list-style-type: none"><li>– Device volume is low.<ul style="list-style-type: none"><li>• Turn the volume up on your device.</li></ul></li></ul>
I have an Android device running a number of compatible apps but the system cannot find all of them.	<ul style="list-style-type: none"><li>– Device limitation. If you have more apps running on your device than the number of available <b>Bluetooth®</b> links, the system cannot find all of them.<ul style="list-style-type: none"><li>• Close some of the apps to allow the system to find those that you want to use.</li></ul></li></ul>

## SYNCTM 3 (If Equipped)

### Wi-Fi Connectivity

Symptom	Possible Cause and Resolution
I cannot connect to a Wi-Fi network.	<ul style="list-style-type: none"><li>– Password error.<ul style="list-style-type: none"><li>• Enter the correct network password.</li></ul></li><li>– Weak network signal.<ul style="list-style-type: none"><li>• Move your vehicle closer to the Wi-Fi hotspot or to a place where the network signal is not obstructed.</li></ul></li><li>– Multiple access points in range with the same SSID.<ul style="list-style-type: none"><li>• Use a unique name for your SSID. Do not use the default name unless it contains a unique identifier, for example as part of the MAC address.</li></ul></li></ul>
The Wi-Fi connection disconnects after successful connection.	<ul style="list-style-type: none"><li>– Weak network signal.<ul style="list-style-type: none"><li>• Move your vehicle closer to the Wi-Fi hotspot or to a place where the network signal is not obstructed.</li></ul></li></ul>
I am close to a Wi-Fi hotspot but the network signal strength is weak.	<ul style="list-style-type: none"><li>– Obstructed network signal.<ul style="list-style-type: none"><li>• If your vehicle has a heated windshield, position your vehicle so that the windshield is not facing the Wi-Fi hotspot.</li><li>• If your vehicle has metallic tinting on the windows but not on the windshield, position your vehicle so that the windshield is facing the Wi-Fi hotspot or open the windows that are facing the hotspot.</li><li>• If your vehicle has metallic tinting on the windows and the windshield, open the windows that are facing the hotspot.</li><li>• If your vehicle is in a garage and you have the garage door closed, open the garage door.</li></ul></li></ul>
I cannot see a network in the list of available networks that I expect to see.	<ul style="list-style-type: none"><li>– Hidden network.<ul style="list-style-type: none"><li>• Make the network visible and try again.</li></ul></li></ul>

## SYNC™ 3 (If Equipped)

Symptom	Possible Cause and Resolution
I cannot see SYNC when I search for Wi-Fi networks on my cell phone or other device.	<ul style="list-style-type: none"> <li>– System limitation.                             <ul style="list-style-type: none"> <li>• SYNC does not provide a Wi-Fi hotspot at this time.</li> </ul> </li> </ul>
Software downloads take too long.	<ul style="list-style-type: none"> <li>– Weak network signal                             <ul style="list-style-type: none"> <li>• Move your vehicle closer to the Wi-Fi hotspot or to a place where the network signal is not obstructed.</li> </ul> </li> <li>– Wi-Fi hotspot in high demand or has a slow Internet connection.                             <ul style="list-style-type: none"> <li>• Use a more reliable Wi-Fi hotspot.</li> </ul> </li> </ul>
The system seems to connect to a Wi-Fi network and the signal strength is excellent but the software does not update.	<ul style="list-style-type: none"> <li>– No software update available.</li> <li>– Wi-Fi network requires a subscription or acceptance of terms and conditions.                             <ul style="list-style-type: none"> <li>• Test the connection using another device. If the network requires a subscription or acceptance of terms and conditions, contact the network service provider.</li> </ul> </li> </ul>

## Personal Profiles (If Equipped)

Symptom	Possible Cause and Resolution
I cannot create a profile.	You might not have set up Personal Profiles.
	You might have entered an invalid profile.
	You might not have selected a memory button when prompted.
	You might not have the ignition on or in park (P), or you shifted out park (P) when creating a profile.
	Personal Profiles has been switched off.
I cannot link a remote control.	You might not have selected the lock button on the remote control.
	The remote control selected was already associated with another profile and the system declined to overwrite.
	The system performed a profile recall when linking a remote control.

## SYNCTM 3 (If Equipped)

<b>Symptom</b>	<b>Possible Cause and Resolution</b>
	You might not have the ignition on or in park (P), or you shifted out park (P) when creating a profile.
	You might be using the old linking method.
My personalized settings do not save.	Personal Profiles does not support your unsaved settings.
	A different personal profile is active.
	Another user changed the settings for the wrong personal profile.
My profile will not recall.	You might not have created a personal profile.
	Personal Profiles is turned off.
	The profile you requested is already active.
	You might not have linked the memory button you are using to a profile.
	You might not have linked the remote control you are using to a profile.
	You might be using the wrong remote control.
	You might be pressing a button other than the unlock or remote start on a linked remote control.
	You might have deleted the personal profile.
My preset positions recall, but my profile does not.	Personal Profiles is turned off.
My profile recalls but my preset positions do not.	The vehicle is in motion.
	The preset positions are the same as the guest or previously active profile.
I lost a remote control.	Unlink and relink your remote control in the Personal Profiles menu. You may need to see your authorized dealer.
I lost all profiles.	You might have erased and reprogrammed the remote controls. This could happen if you let a dealership add a new remote control to replace a lost one.
	Someone performed a master reset.

## Resetting the System

1. Simultaneously press and hold the seek up and the audio unit power buttons until the screen goes black.
2. Wait three minutes to allow the system to complete the reset.
3. Press the audio unit power button to switch the system on.

**Note:** *You can reset the system to restore functionality that has stopped working. The system reset is designed to restore functionality and not delete any data that you have stored.*

## Additional Information and Assistance

For additional information and assistance, we recommend that you contact an authorized dealer or refer to our website.

# Center Display Overview - Vehicles With: SYNC 4

## CENTER DISPLAY PRECAUTIONS



**WARNING:** Driving while distracted can result in loss of vehicle control, crash and injury. We strongly recommend that you use extreme caution when using any device that may take your focus off the road. Your primary responsibility is the safe operation of your vehicle. We recommend against the use of any hand-held device while driving and encourage the use of voice-operated systems when possible. Make sure you are aware of all applicable local laws that may affect the use of electronic devices while driving.

## CENTER DISPLAY LIMITATIONS

### Speed-restricted Features

For your safety, some features are not available while the vehicle is in motion at or above 6 mph (10 km/h). Settings that are not critical while driving your vehicle will be shown as restricted on your display. See below for examples:

- System Updates.
- Personal Profiles Setup.
- Valet Mode Setup.
- Driver Assistance Settings.
- Auto-Start-Stop Speed Threshold.

### Vehicle Settings

- 30 Minute Max Idle.
- MyKey Setup.
- Door Keypad Code Setup.
- Backup Start Passcode Setup.

These restricted features will become available when your vehicle is no longer in motion.

## STATUS BAR

The bar is on top of the display and indicates the status of your vehicle's features.

### Audio System



Audio system muted.

### Connected Device



Cell phone microphone muted.



Phone call in progress.



Media player connected.



Cell phone network signal strength.



Cell phone roaming.



Text message received.



Unread email message.



Automatic crash notification system off.



Cell phone battery status.



# Center Display Overview - Vehicles With: SYNC 4

## Vehicle Data



Wi-Fi available.



Wi-Fi connected.



Vehicle data sharing on.



Vehicle data sharing off.



Vehicle location sharing on.



Vehicle data and vehicle location sharing on.

## Vehicle System Update



Vehicle system update available.



Vehicle system update requires schedule.



Vehicle system update requires consent.



Vehicle system update requires Wi-Fi.



Vehicle system update schedule reminder.



Vehicle system update not successful.



Vehicle system update successful.

## Wireless Accessory Charger



Wireless accessory charger active.

## FEATURE BAR

The bar is on the bottom of the display and allows you to access vehicle features.



Select to use the radio, a USB, a media player or a **Bluetooth®** device.



Select to make calls and access the phonebook on your cell phone.



Select to use the navigation system.



Select to view favorites.



Select to search for and use compatible apps on your iOS or Android device.



Select to adjust system settings.



Select to view features.



**Note:** The icon may be different depending on your vehicle.

# Center Display Overview - Vehicles With: SYNC 4

---

## INFORMATION ON DEMAND SCREEN

The Information on Demand screen displays cards on the side of the display and allows you to see information from different features.



Select the button to view the next card.



Select the button to view the previous card.



Select the button to view available cards.

# Voice Interaction - Vehicles With: SYNC 4

## WHAT IS VOICE INTERACTION

Voice Interaction allows you to control vehicle features using conversational requests.

## SETTING THE WAKE WORD

1. Press the Settings option on the feature bar.
2. Press the Voice Control button.
3. Switch on Listen for Wake Word.
4. Press Preferred Wake Word
5. Select a wake word.

## BEGINNING A VOICE INTERACTION

Say the selected wake word.



Press the voice interaction button on the steering wheel.

## VOICE INTERACTION EXAMPLES

### General Examples

Command	Result
Start Over.	The system resets the current voice interaction.
Cancel.	The system ends the current voice interaction.
Next Page.	The system goes to the next page.
Previous Page.	The system goes to the previous page.
Help.	The system displays a list of available commands you can use on the current screen.

### Entertainment Examples

Command	Result
Play The Beatles.	The system plays the selected music.
Show music by The Beatles.	The system shows the selected music.
Tune to FM 101.9.	The system tunes the radio to 101.9 FM.
Set the station to Sirius Channel 2.	The system tunes the radio to Sirius Channel 2.

# Voice Interaction - Vehicles With: SYNC 4

## Climate Examples

Command	Result
Set the temperature to low.	The system sets the temperature to the minimum.
Set the temperature to 72°F (22°C).	The system sets the temperature to 72°F (22°C).

## Phone Examples

Command	Result
Call Henry.	The system calls Henry using your connected device.
Dial (phone number).	The system dials the selected phone number.
Send a text message to Henry.	The system begins a dictated text message.
Read my message from Henry.	The system reads you the most recent message from Henry.

## Apps Examples

Command	Result
Mobile Apps.	The system prompts you to say the name of an app to start it on the system.
List Mobile Apps.	The system will list all of the currently available Mobile Apps.
Find Mobile Apps	The system will search and connect to compatible apps running on your mobile device.

## Navigation Examples

Command	Result
Say the address that you're looking for, like '125 Main Street, New York'.	The system begins guided navigation to the address.
Where is ____	The system searches for the requested point of interest.
Show me directions to Oakwood Boulevard and Pelham Road.	The system shows directions to the selected intersection.
Cancel route.	The system ends guided navigation to the destination.

# Phone - Vehicles With: SYNC 4

## PHONE PRECAUTIONS



**WARNING:** Driving while distracted can result in loss of vehicle control, crash and injury. We strongly recommend that you use extreme caution when using any device that may take your focus off the road. Your primary responsibility is the safe operation of your vehicle. We recommend against the use of any hand-held device while driving and encourage the use of voice-operated systems when possible. Make sure you are aware of all applicable local laws that may affect the use of electronic devices while driving.

## CONNECTING YOUR PHONE

Go to the settings menu on your device and switch **Bluetooth®** on.



Select the phone option on the feature bar.

1. Select **Add Phone**.

**Note:** A prompt alerts you to search for your vehicle on your cell phone.

2. Select your vehicle on your cell phone.

**Note:** A number appears on your cell phone and on the touchscreen.

3. Confirm that the PIN (personal identification number) on your cell phone matches the number on the touchscreen.

**Note:** The touchscreen indicates that you have successfully paired your cell phone.

4. Download the phonebook from your cell phone when you are prompted.

**Note:** If you pair more than one cell phone, use the phone settings to specify the primary phone. You can change this setting at any time.

## PHONE MENU

This menu becomes available after pairing a phone.

### **Recent Call List**

Display and select an entry from a list of previous calls.

### **Contacts**

Display a smart search form to look up your contacts. Use the List button to alphabetically sort your contacts.

### **Favorites**

Display the list of favorite contacts that are set up on your phone.

### **Messaging**

Displays the list of text messages to read, listen to, or respond to.

### **Email**

Displays the list of emails to read, listen to, or respond to.

### **Phone List**

Display the list of paired or connected devices that you can select.

**Note:** Up to 12 devices can be stored.

### **Do Not Disturb**

Reject incoming calls and switch ring tones and alerts off.

### **Phone Keypad**

Directly dial a number.

# Phone - Vehicles With: SYNC 4

---

## Voice Control

Say a command to use the Google or Siri voice assistant available on your connected phone to access supported features.

**Note:** *Some features under the phone menu may not be available if the feature is not supported through the phone.*

# Phone - Vehicles With: SYNC 4

## MAKING AND RECEIVING A PHONE CALL

### Making Calls

#### To call a number in your contacts, select:

Menu Item	Action and Description
Contacts	You can then select the name of the contact you want to call. Any numbers stored for that contact display along with any stored contact photos. You can then select the number that you want to call. The system begins the call.

#### To call a number from your recent calls, select:

Menu Item	Action and Description
Recent Call List	You can then select an entry that you want to call. The system begins the call.

#### To call a number from your favorites, select:

Menu Item	Action and Description
Favorites	You can then select an entry that you want to call. The system begins the call.

#### To call a number that is not stored in your phone, select:

Menu Item	Action and Description
Phone Keypad	Select the digits of the number you wish to call.
Call	The system begins the call.

Pressing the backspace button deletes the last digit you typed.

### Receiving Calls

During an incoming call, an audible tone sounds. Caller information appears in the display if it is available.

#### To accept the call, select:

Menu Item
Accept

**Note:** You can also accept the call by pressing the phone button on the steering wheel.

#### To reject the call, select:

Menu Item
Reject

Ignore the call by doing nothing. The system logs it as a missed call.

### During a Phone Call

During a phone call, the contacts name and number display on the screen along with the call duration.

The phone status items are also visible:

- Signal Strength.
- Battery.

You can select any of the following during an active phone call:

## Phone - Vehicles With: SYNC 4

---

Item	
End Call	Immediately end a phone call. You can also press the button on the steering wheel.
Keypad	Press this to access the phone keypad.

Item	
Mute	You can switch the microphone off so the caller does not hear you.
Privacy	Transfer the call to the cell phone or back to the touch-screen.

### SENDING AND RECEIVING A TEXT MESSAGE

Menu Item	Description
Hear It	Hear the text message.
View	View the text message.
Call	Call the sender.
Reply	Reply to the text message with a standard text message.



# Phone - Vehicles With: SYNC 4

---

## SWITCHING TEXT MESSAGE NOTIFICATION ON AND OFF

### IOS

1. Go to the settings menu on your cell phone.
2. Select **Bluetooth®**.
3. Select the information icon to the right of your vehicle.
4. Switch text message notification on or off.

### Android

1. Go to the settings menu on your cell phone.
2. Select **Bluetooth®**.
3. Select the profiles option.
4. Select the phone profile.
5. Switch text message notification on or off.

# Bluetooth® - Vehicles With: SYNC 4

## CONNECTING A BLUETOOTH® DEVICE

1. Make sure **Bluetooth®** is enabled on your device.
2. Press **Settings** on the touchscreen.
3. Press **Connectivity**.
4. Press **Bluetooth**.
5. Press **Add a Bluetooth Device**.

**Note:** A prompt alerts you to search for your vehicle on your device.

6. Select your vehicle on your device.

**Note:** A number appears on your device and on the touchscreen.

7. Confirm that the number on your device matches the number on the touchscreen.

**Note:** The touchscreen indicates that you have successfully paired your device.

The **Bluetooth®** word mark and logos are registered trademarks owned by **Bluetooth SIG, Inc.** and any use of such marks by Ford Motor Company is under license. Other trademarks and trade names are those of their respective owners.

## PLAYING MEDIA USING BLUETOOTH®



**WARNING:** Driving while distracted can result in loss of vehicle control, crash and injury. We strongly recommend that you use extreme caution when using any device that may take your focus off the road. Your primary responsibility is the safe operation of your vehicle. We recommend against the use of any

hand-held device while driving and encourage the use of voice-operated systems when possible. Make sure you are aware of all applicable local laws that may affect the use of electronic devices while driving.

Connect your device.



Press the audio button on the feature bar.



Press **Sources**.



Press the **Bluetooth®** option.



Press to play a track. Press again to pause the track.



Press to skip to the next track. Press and hold to fast forward through the track.



Press once to return to the beginning of a track. Repeatedly press to return to previous tracks.

Press and hold to fast rewind through the track.

# Apps - Vehicles With: SYNC 4

## APP PRECAUTIONS



**WARNING:** Driving while distracted can result in loss of vehicle control, crash and injury. We strongly recommend that you use extreme caution when using any device that may take your focus off the road. Your primary responsibility is the safe operation of your vehicle. We recommend against the use of any hand-held device while driving and encourage the use of voice-operated systems when possible. Make sure you are aware of all applicable local laws that may affect the use of electronic devices while driving.

## APP REQUIREMENTS

When you start an app through the system for the first time, you could be asked to grant certain permissions. You can review and change the permissions that you have granted at any time when your vehicle is not moving. We recommend that you check your data plan before using your apps through the system. Using them could result in additional charges. We also recommend that you check the app provider's terms and conditions and privacy policy before using their app. Make sure that you have an active account for apps that you want to use through the system. Some apps will work with no setup. Others require you to configure some personal settings before you can use them.

## ACCESSING APPS



Select the apps option on the feature bar.

## ENABLING APPS ON AN IOS DEVICE



Select the apps option on the feature bar.

1. Select Mobile Apps Help.
2. Follow the instructions to pair and connect your device via **Bluetooth®** or with a USB cable.
3. Start the apps on your device that you want to use.
4. Select the app that you want to use on the touchscreen.

**Note:** Some apps may run through Apple CarPlay if it is enabled.

**Note:** Closing an app on your device will close it on the touchscreen.

**Note:** For troubleshooting assistance select Mobile Apps List under Mobile Apps Help.

## ENABLING APPS ON AN ANDROID DEVICE



Select the apps option on the feature bar.

1. Select Mobile Apps Help.
2. Follow the instructions to pair and connect your device via **Bluetooth®** or with a USB cable.
3. Start the apps on your device that you want to use.
4. Select **Find Mobile Apps**.
5. Select the app that you want to use on the touchscreen.

**Note:** Some devices may lose the ability to play music over USB when Mobile Apps are enabled.

**Note:** Some apps may run through Android Auto if it is enabled.

# Apps - Vehicles With: SYNC 4

**Note:** Closing an app on your device will close it on the touchscreen.

**Note:** For troubleshooting assistance select Mobile Apps List under Mobile Apps Help.

## SWITCHING APPLE CARPLAY ON AND OFF

### Enabling Apple CarPlay with USB

1. Connect your device to a USB port.
2. Follow the instructions on your device and the touchscreen.

**Note:** Selecting "Enable Wireless CarPlay" on your device will prepare the device for wireless carplay when you re-enter the vehicle.

### Enabling Apple CarPlay with Wireless

1. Pair your device to **Bluetooth®**.
2. Follow the instructions on your device and the touchscreen.

### Disabling Apple CarPlay



Select the settings option on the feature bar.

1. Press Phone List.
2. Select your device from the list.
3. Press Disable.

### Re-Enabling Apple CarPlay



Select the settings option on the feature bar.

1. Press Phone List.
2. Select your device from the list.
3. Press Connect to Apple CarPlay.

## SWITCHING ANDROID AUTO ON AND OFF

### Enabling Android Auto with USB

(If Equipped)

1. Connect your device to a USB port.
2. Follow the instructions on the touchscreen.

**Note:** Certain features of the system are not available when you are using Android Auto.

### Enabling Android Auto with Wireless

1. Pair your device to **Bluetooth®**.
2. Follow the instructions on your device and the touchscreen.

**Note:** Certain Android Devices do not support Android Auto Wireless. Please check your Android OS version for compatibility.

### Disabling Android Auto



Select the settings option on the feature bar.

1. Press Phone List.
2. Select your device from the list.
3. Press Disable.

### Re-Enabling Android Auto



Select the settings option on the feature bar.

1. Press Phone List.
2. Select your device from the list.
3. Press Connect to Android Auto.

# Navigation - Vehicles With: SYNC 4

## ACCESSING NAVIGATION



Press the button to access Navigation.

**Note:** *As the driver, be aware of all local traffic regulations and road attributes, and operate your vehicle in a safe and legal manner.*

## NAVIGATION MAP UPDATES

To update your Map data over Wi-Fi, your vehicle must be connected to a Wi-Fi access point. For USB updates and other details, contact dealers at 1-866-462-8837 in the United States and Canada, or 01-800-557-5539 in Mexico.

**Note:** *If you find map data errors, you may report them by going to [www.here.com/mapcreator](http://www.here.com/mapcreator).*

## ADJUSTING THE MAP

### ZOOMING THE MAP IN AND OUT

You can use pinch gestures to zoom in and out. Place two fingers on the screen and move them apart to zoom in. Place two fingers on the screen and bring them together to zoom out.

### CHANGING THE FORMAT OF THE MAP



Press the Menu button.

1. Press the Map Orientation tile.
2. Select a map orientation.

## LIVE TRAFFIC

### WHAT IS LIVE TRAFFIC

You can observe real-time road congestion when live traffic is on.

### SWITCHING LIVE TRAFFIC ON AND OFF



Press the Menu button.

1. Press the Traffic on Map tile.
2. Press Traffic on or Traffic Off.

## SETTING A DESTINATION

### SETTING A DESTINATION USING THE TEXT ENTRY SCREEN

1. Press the search bar at the top of the screen.
2. Enter your destination using the keyboard.
3. Press Search.
4. Select a destination from the list.
5. Press Start to begin navigation.

### SETTING A DESTINATION USING THE MAP SCREEN

Press and hold on the map to place a pin at that location. Information about the location of the pin appears on the screen.



Press the button to begin navigation to the pin.

# Navigation - Vehicles With: SYNC 4

## SETTING A DESTINATION USING A PREDICTIVE DESTINATION

Press the predicted destination card on the screen to navigate to it. These appear when the navigation system has learned your driving habits.

## SETTING A DESTINATION USING A RECENT DESTINATION



Press the Menu button.

1. Press the Recents tile.
2. Select a destination from the list.

## SETTING A DESTINATION USING A SAVED DESTINATION



Press the Menu button.

1. Press Saved Places.
2. Select a saved destination.

**Note:** Press the star icon next when viewing location details to save the location.

## SETTING A DESTINATION USING A POINT OF INTEREST

Press and hold on a point of interest icon on the map. Information about the location of the point of interest appears on the screen.



Press the button to begin navigation to the point of interest.

## WAYPOINTS

### ADDING A WAYPOINT



Press the Add Waypoint button when in an active navigation session.

1. Enter your waypoint on the keyboard.
2. Press Search.
3. Select a waypoint from the list.
4. Press Add to Trip.

### EDITING WAYPOINTS

1. Press the waypoint you would like to edit.
2. Select an option to reorder or delete the waypoint.

## ROUTE GUIDANCE

### ADJUSTING THE GUIDANCE PROMPT VOLUME

Turn the volume control when a guidance prompt plays to adjust the volume.

### REPEATING AN INSTRUCTION

Press the turn indicator to hear the last voice instruction.

### CANCELING ROUTE GUIDANCE



Press the button to cancel route guidance to the selected location.

## TRAILER TOWING NAVIGATION

When you have an active subscription and Trailer Towing Navigation is switched on, the system will calculate the best route for trailer towing by avoiding dangerous road conditions based on the dimensions of your trailer.

### Switching Trailer Towing Navigation On and Off

1. Press the **Navigation** button on the feature bar.
2. Press the **Menu** button.
3. Press **Trailer Routing**.
4. Switch **Trailer-optimized Routing** on or off.

### Entering Trailer Dimensions

1. Press the **Navigation** button on the feature bar.
2. Press the **Menu** button.
3. Press **Trailer Routing**.
4. Press **Towing Menu**.
5. Press **Add Trailer**.
6. Follow the instructions on the screen to enter the type and dimensions of the trailer into the system.

### Navigation Alerts

Alerts will appear on the navigation map while driving. An orange alert triangle indicates you should proceed with caution. When not following active guidance to a destination, a red alert triangle may appear and indicates you should avoid the road and find a detour.

# Vehicle System Updates - Vehicles With: SYNC 4

## UPDATING THE VEHICLE SYSTEMS WIRELESSLY



Over-the-Air Updates allow you to update your vehicle system software wirelessly. To make sure you receive all updates, set a recurring schedule and connect to Wi-Fi. See **Connected Vehicle** (page 498). Updates may take longer if not connected to Wi-Fi, or may not download at all. Multiple connections may be required to complete a download.

### Enabling Over-the-Air Updates



Press the settings option on the feature bar.

1. Press the **System Update** tile.
2. Switch **Automatic Updates** on.

**Note:** *Over-the Air Updates are enabled by default.*

**Note:** *If you do not want to receive Over-the-Air Updates you can turn them off. You will not be notified of new updates.*

### Scheduling an Update

Scheduling an update allows you to set a convenient time for the update to complete. We recommend updating overnight when your vehicle is not in use. Ensure Vehicle Connectivity and Automatic Over-the-Air Updates are enabled. Once you complete these steps, your schedule will be saved for future updates. As long as an update is not in process you can adjust your schedule.

**Note:** *Some updates may be applied outside of your set schedule. Information about the unscheduled update appears on the touchscreen after it is applied.*

### Using the Settings Menu



Press the settings option on the feature bar.

1. Press the **System Update** tile.
2. Press **Schedule Update**.
3. Use the controls to set the time and day of the update.
4. Save the schedule.

**Note:** *You can set the updates to occur at any time.*

### Using the Status Bar Icon



When an update is available, tap the notification icon and follow the prompts on the screen.

Additional Over-the-Air Update icons may appear on the status bar. See **Status Bar** (page 597).

### Applying an Over-the-Air Update

You can see the progress of the update on the touchscreen. An update cannot be canceled once it has been started.

During scheduled updates you will not be able to drive your vehicle, start the vehicle, use remote controls to lock and unlock the vehicle. The alarm, central locks, and door tones are disabled. The electronic door lock will not function during an update. You can open the doors using the mechanical latch if child locks are not on. Pull the handle until it stops to use the mechanical latch. Some updates may not allow you to use your vehicle during the update process.

**Note:** *Some updates can complete in the background, but more complex updates can take up to 45 minutes.*

**Note:** *Double locking is switched off and central locking is switched on during and after an update.*



# Vehicle System Updates - Vehicles With: SYNC 4

---

**Note:** *If your vehicle is plugged in, charging will stop during an update and resume when the update is complete.*

## Over-the-Air Update Requirements

If these requirements are not met during a scheduled update the update will be postponed. You can update your schedule if you want to retry the update sooner.

- Your vehicle is not running.
- Your vehicle is stopped.
- Your vehicle is parked.
- The hazard indicators are switched off.
- The alarm is not sounding.
- The doors are closed.
- The parking lights are switched off.
- You are not pressing the brake pedal.
- An emergency call is not in progress.
- The Stop Safely lamp is not illuminated. See **Instrument Cluster Warning Lamps** (page 137).

## Viewing Update Information

If an update is successful, the touchscreen will provide additional details or statuses about the update. You can also access this information under the System Update tile.

If an update is not successful, follow the prompt that appears on the touchscreen.

## PERFORMING A MASTER RESET



Press the settings option on the feature bar.

1. Press the **Reset** tile.
2. Press **Master Reset**.
3. Follow the prompts on the screen to complete the reset.

# Accessories

For a complete listing of the accessories that are available for your vehicle, please contact your authorized dealer or visit the online store web site:

<b>Web Address (United States)</b>
<a href="http://www.Accessories.Ford.com">www.Accessories.Ford.com</a>

<b>Web Address (Canada)</b>
<a href="http://www.Accessories.Ford.ca">www.Accessories.Ford.ca</a>

We will repair or replace any properly authorized dealer-installed Ford Original Accessory found to be defective in factory-supplied materials or workmanship during the warranty period, as well as any component damaged by the defective accessories.

We will warrant your Ford Original Accessory through the warranty that provides the greatest benefit:

- 24 months, unlimited mileage.
- The remainder of your new vehicle limited warranty.

Contact an authorized dealer for details and a copy of the warranty.

Ford Licensed Accessories are the accessory manufacturer's designs. The manufacturer develops and therefore warrants Ford Licensed Accessories, and does not design or test these accessories to Ford Motor Company engineering requirements. Contact an authorized Ford dealer for the manufacturer's limited warranty details, and request a copy of the Ford Licensed Accessories product limited warranty from the accessory manufacturer.

For maximum vehicle performance, keep the following information in mind when adding accessories or equipment to your vehicle:

- When adding accessories, equipment, passengers and luggage to your vehicle, do not exceed the total weight capacity of the vehicle or of the front or rear axle (GVWR or GAWR as indicated on the Safety Compliance Certification label). Ask an authorized dealer for specific weight information.
- The Federal Communications Commission (FCC) and Canadian Radio Telecommunications Commission (CRTC) regulate the use of mobile communications systems that are equipped with radio transmitters, for example two-way radios, telephones and theft alarms. Any such equipment installed in your vehicle should comply with Federal Communications Commission (FCC) and Canadian Radio Telecommunications Commission (CRTC) regulations and should be installed only by an authorized dealer.
- An authorized dealer needs to install mobile communications systems. Improper installation may harm the operation of your vehicle, particularly if the manufacturer did not design the mobile communication system specifically for automotive use.
- If you or an authorized Ford dealer add any non-Ford electrical or electronic accessories or components to your vehicle, you may adversely affect battery performance and durability. In addition, you may also adversely affect the performance of other electrical systems in the vehicle.

# Accessories

## AUXILIARY SWITCHES

The auxiliary switchboard on the overhead console makes aftermarket customization easier with six prewired switches connected to the power distribution box. Each circuit is individually fused for connection of electrical accessories.



The switches are labeled AUX 1 through AUX 6. They only operate when the ignition is in the on position, whether the engine is running or not. We recommend that you leave the engine running to maintain battery charge when using the switches for an extended time or when using higher current draw accessories. When a switch is turned on, the indicator light on the switch illuminates and the circuit provides power to the device wired to that switch.

**Note:** *AUX switch 1 is dedicated to the off-road lamps when your vehicle is equipped with this option.*

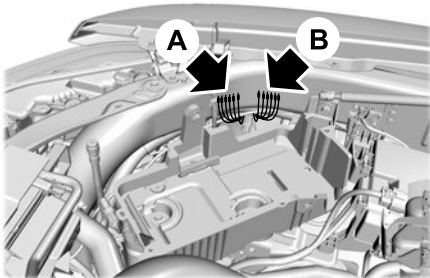

There are three sets of blunt-cut and sealed circuits. Two sets are under the hood and behind the battery tray, and one set is inside your vehicle at the passenger footwell.

The powered set (A) is taped behind the battery tray and is marked with a red spot tape.

The second set (B) is also under the hood. It is taped behind the battery tray and is marked with a white spot tape. This set routes to the interior passenger footwell.

Remove the battery and battery tray to access the under hood circuits.

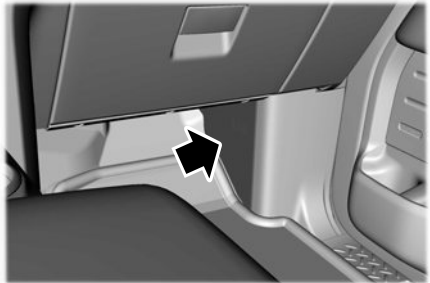

The interior set is taped on a wire harness by the passenger side footwell. This set is the other end of the circuits taped behind the battery tray marked with a white spot tape.

Remove the fuse panel access door in the kick panel to access the wires. If you do not see them, you may need to pull them down.

See the Fuses chapter of your Owner's Manual for information on fuse and relay locations. See your authorized dealer for service.

# Accessories

---

The relays are coded as follows:

<b>Power Distribution Box</b>	<b>Wire Color</b>	<b>Under-hood Pass Through</b>	<b>Wire Color</b>	<b>Passenger Footwell</b>	<b>Wire Size</b>	<b>Fuse</b>
AUX 1	Violet/Green	AUX 1	Violet/Green	AUX 1	1.0 mm <sup>2</sup>	10A
AUX 2	Green/Brown	AUX 2	Green/Brown	AUX 2	1.0 mm <sup>2</sup>	15A
AUX 3	Green/Blue	AUX 3	Green/Blue	AUX 3	1.0 mm <sup>2</sup>	15A
AUX 4	Brown	AUX 4	Brown	AUX 4	1.0 mm <sup>2</sup>	10A
AUX 5	Blue/Orange	AUX 5	Blue/Orange	AUX 5	1.0 mm <sup>2</sup>	5A
AUX 6	Yellow/Orange	AUX 6	Yellow/Orange	AUX 6	1.0 mm <sup>2</sup>	5A

# Auxiliary Switches

## WHAT ARE THE AUXILIARY SWITCHES

The auxiliary switchboard on the overhead console makes aftermarket customization easier with six prewired switches connected to the power distribution box. Each circuit is individually fused for connection of electrical accessories.

## LOCATING THE AUXILIARY SWITCHES

The switches are labeled AUX 1 through AUX 6. They only operate when the ignition is in the on position or in the off position when Delay Accessory is active, whether the engine is running or not. We recommend that you leave the engine running to maintain battery charge when using the switches for an extended time or when using higher current draw accessories. When a switch is turned on, the indicator light on the switch illuminates and the circuit provides power to the device wired to that switch.



## LOCATING THE AUXILIARY SWITCH WIRING

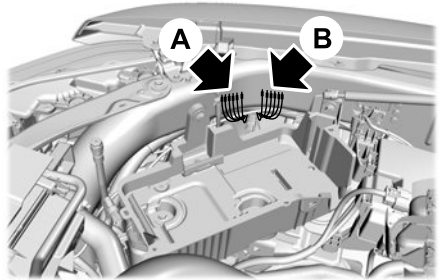

There are three sets of blunt-cut and sealed circuits. Two sets are under the hood and behind the battery tray, and one set is inside your vehicle at the passenger footwell.

The powered set (A) is taped behind the battery tray and has a red spot tape mark.

The second set (B) is also under the hood. It is taped behind the battery tray and has a white spot tape mark. This set routes to the interior passenger footwell.

Remove the battery and battery tray to access the under hood circuits.

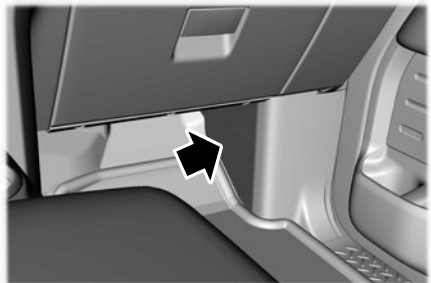

## Auxiliary Switches

The interior set is taped on a wire harness by the passenger side footwell. This set is the other end of the circuits taped behind the battery tray, with a white spot tape mark.

Remove the fuse panel access door in the kick panel to access the wires. If you do not see them, you may need to pull them down.

Additional information on fuse and relay locations is available. See **Fuses** (page 387). See your authorized dealer for service.

### IDENTIFYING THE AUXILIARY SWITCH WIRING

The relays are coded as follows:

Power Distribution Box	Wire Color	Under-hood Pass Through	Wire Color	Passenger Footwell	Wire Size	Fuse
AUX 1	Violet/Green	AUX 1	Violet/Green	AUX 1	1.0 mm <sup>2</sup>	10A
AUX 2	Green/Brown	AUX 2	Green/Brown	AUX 2	1.0 mm <sup>2</sup>	15A
AUX 3	Green/Blue	AUX 3	Green/Blue	AUX 3	1.0 mm <sup>2</sup>	15A
AUX 4	Brown	AUX 4	Brown	AUX 4	1.0 mm <sup>2</sup>	10A
AUX 5	Blue/Orange	AUX 5	Blue/Orange	AUX 5	1.0 mm <sup>2</sup>	5A
AUX 6	Yellow/Orange	AUX 6	Yellow/Orange	AUX 6	1.0 mm <sup>2</sup>	5A

# Ford Protect

---

## WHAT IS FORD PROTECT

Protect yourself from the rising cost of vehicle repairs with a Ford Protect extended service plan.

### **Ford Protect Extended Service Plans - United States Only**

Ford Protect extended service plans mean peace of mind. Extended service plans are backed by Ford Motor Company, and provide more protection beyond the New Vehicle Limited Warranty coverage. When you visit your Ford Dealer, insist on the Ford Protect extended service plan.

### **Ford Protect Can Quickly Pay for Itself**

One trip to the service center could easily exceed the price of your Ford Protect extended service plan. With the Ford Protect extended service plan, you minimize your risk for unexpected repair bills and rising repair costs.

### **Up to 1,000+ Covered Vehicle Components**

There are four mechanical Ford Protect extended service plans with different levels of coverage. Ask your authorized dealer for details.

1. PremiumCARE - Our most comprehensive coverage. With over 1,000 covered components, this plan is so complete it is probably easier to list what is not covered.
2. ExtraCARE - Covers 113 components, and includes many high-tech items.
3. BaseCARE - Covers 84 components.
4. PowertrainCARE - Covers 29 critical components.

Ford Protect extended service plans are honored by all authorized Ford dealers in the United States, Canada and Mexico.

That means you get:

- Reliable, quality service at any Ford or Lincoln dealership.
- Repairs performed by factory trained technicians, using genuine parts.

### **Rental Car Reimbursement**

#### ***First Day Rental Benefit***

If you bring your car into your dealer for service, we will give you a rental vehicle to use for the day.

#### ***Extended Rental Benefits***

If your vehicle is kept overnight for covered repairs, you are eligible for rental car coverage, warranty repairs, and field service actions.

### **Roadside Assistance**

Exclusive 24/7 roadside assistance, including:

- Towing, flat-tire change and battery jump starts.
- Out of fuel and lock-out assistance.
- Travel expense reimbursement for lodging, meals and rental car.
- Assistance for taxi, shuttle, rental car coverage or other transportation.

### **Transferable Coverage**

If you sell your vehicle before your Ford Protect extended service plan coverage expires, you can transfer any remaining coverage to the new owner. This should give you and your potential buyer peace of mind.

# Ford Protect

---

## Less Cost to Properly Maintain Your Vehicle

The Ford Protect extended service plan also offers a Premium Maintenance Plan that covers all scheduled maintenance, and selected wear items. The coverage is prepaid, so you never have to worry about the cost of your vehicle's maintenance.

Covered maintenance includes:

- Windshield wiper blades.
- Spark plugs.
- The clutch disc (if equipped).
- Brake pads and linings.
- Shock absorbers.
- Struts.
- Engine belts.
- Engine coolant hoses, clamps and o-rings.
- Diesel exhaust fluid replenishment (if equipped).
- Cabin air filter replacement every 20,000 mi (32,000 km) for electric vehicles only.

## Interest Free Finance Options

Just a 5% down payment provides you with an affordable, no interest, no fee payment program allowing you all the security and benefits Ford Protect extended service plan has to offer while paying over time. You are pre-approved with no credit check or hassles. To learn more, call our Ford Protect extended service plan specialists at 800-367-3377.

Ford Protect Extended Service Plan  
P.O. Box 321067  
Detroit, MI 48232

## Ford Protect Extended Service Plan (Canada Only)

You can get more protection for your vehicle by purchasing a Ford Protect extended service plan. Ford Protect extended service plan is the only service contract backed by Ford Motor Company of Canada, Limited. Depending on the plan you purchase, Ford Protect extended service plan provides benefits such as:

- Rental reimbursement.
- Coverage for certain maintenance and wear items.
- Protection against repair costs after your New Vehicle Limited Warranty Coverage expires.
- Roadside Assistance benefits.

There are several Ford Protect extended service plans available in various time, distance and deductible combinations. Each plan is tailored to fit your own driving needs, including reimbursement for towing and rental. When you purchase Ford Protect extended service plan, you receive added peace-of-mind protection throughout Canada, the United States and Mexico, provided by a network of participating authorized Ford Motor Company dealers.

**Note:** *Repairs performed outside of Canada and the United States are not eligible for Ford Protect extended service plan coverage.*

This information is subject to change. Visit your local Ford of Canada dealer or [www.ford.ca](http://www.ford.ca) to find the Ford Protect extended service plan that is right for you.



# Scheduled Maintenance

---

## GENERAL MAINTENANCE INFORMATION

### Why Maintain Your Vehicle?

Carefully following the maintenance schedule helps protect against major repair expenses resulting from neglect or inadequate maintenance and may help to increase the value of your vehicle when you sell or trade it. Keep all receipts for completed maintenance with your vehicle.

It is important that you have your vehicle serviced at the proper times. These intervals serve two purposes: first is to maintain the reliability of your vehicle and the second is to keep the cost of owning your vehicle down.

It is your responsibility to have all scheduled maintenance performed and to make sure that the materials used meet the specifications identified in this owner's manual. See **Capacities and Specifications** (page 467).

Failure to perform scheduled maintenance and regularly inspect your vehicle may result in vehicle damage not covered by the vehicle Warranty.

### Why Maintain Your Vehicle at Your Dealership?

#### Our Genuine Replacement Parts

Dealerships stock our parts and our authorized branded re-manufactured replacement parts. These parts meet or exceed our specifications. Parts installed at your dealership carry a nationwide 24-month or unlimited mile (kilometer) parts and labor limited warranty.

If you do not use our authorized parts they may not meet our specifications and could affect emissions compliance.

### Protecting Your Investment

Maintenance is an investment that pays dividends in the form of improved reliability, durability and resale value. To maintain the proper performance of your vehicle and its emission control systems, make sure you have scheduled maintenance performed at the designated intervals.

Your vehicle comes with the Intelligent Oil-Life Monitor system, a message appears in the information display at the proper oil change interval. This interval may be up to one year or 10,000 mi (16,000 km), hybrid vehicles could exceed 10,000 mi (16,000 km).

When the oil change message appears in the information display, it is time for an oil change. Make sure you perform the oil change within two weeks or 500 mi (800 km) of the message appearing. Make sure to reset the Intelligent Oil-Life Monitor after each oil change. See **Resetting the Engine Oil Change Reminder** (page 401).

If your information display resets prematurely or becomes inoperative, you should perform the oil change interval at six months or 5,000 mi (8,000 km) from your last oil change. Never exceed one year or 10,000 mi (16,000 km) between oil change intervals.

You can drive high performance vehicles in such a way that may lead to higher oil consumption including extended time at high engine speeds, high loads, engine braking, hard cornering maneuvers, track and off-road usage. Under these conditions, oil consumption of approximately 1 quart per 500 miles (1 liter per 800 km) is possible. Check the engine oil level at every refueling and adjust to maintain proper levels to avoid engine damage.

# Scheduled Maintenance

It is important to rely upon your dealership to properly diagnose and repair your vehicle.

We strongly recommend only using our genuine or our authorized re-manufactured replacement parts engineered for your vehicle.

## Additives and Chemicals

We do not recommend using chemicals or additives not approved by us as part of your vehicle's normal maintenance. Please consult your warranty information.

## Oils, Fluids and Flushing

In many cases, fluid discoloration is a normal operating characteristic and, by itself, does not necessarily indicate a concern or that the fluid needs to be changed. Have discolored fluids that also show signs of overheating or foreign material contamination checked immediately.

Make sure to change the vehicle's oils and fluids at the specified intervals or in conjunction with a repair. Flushing is a viable way to change fluid for many vehicle sub-systems during scheduled maintenance. It is critical that systems are flushed only with new fluid that is the same as that required to fill and operate the system or using our approved flushing chemical.

## Owner Checks and Services

Make sure you perform the following basic maintenance checks and inspections.

<b>Check Every Month</b>
The air filter restriction gauge. <sup>1</sup>
The engine oil level.
Function of all interior and the exterior lights.
The tires including the spare for wear and proper pressure.
The windshield washer fluid level.
The fuel and water separator. Drain if necessary or if indicated by the information display. <sup>1</sup>
The holes and slots in the tail pipe to make sure they are functional and clear of debris. <sup>1</sup>

<sup>1</sup> Diesel vehicles only.

# Scheduled Maintenance

<b>Check Every Six Months</b>
The battery connections. Clean if necessary.
The body and door drain holes for obstructions. Clean if necessary.
The cooling system fluid level and the coolant system strength.
The door weatherstrips for wear. Lubricate if necessary.
The hinges, latches and outside locks for proper operation. Lubricate if necessary.
The parking brake for proper operation.
The seatbelts and seat latches for wear and function.
Safety warning lamps, brake, ABS, airbag and seatbelt for operation.
The washer spray and wiper operation. Clean or replace blades as necessary.

## Multi-Point Inspection

It is important to have the systems on your vehicle regularly checked. This can help identify potential issues and prevent major problems. We recommend having the following multi-point inspection performed at every scheduled maintenance interval to help make sure your vehicle keeps running great.

<b>Multi-Point Inspection</b>	
Accessory drive belt or belts	Hazard warning system operation
Battery performance	Horn operation
Engine air filter	Radiator, cooler, heater and air conditioning hoses
Exhaust system	Suspension components for leaks or damage
Exterior lamps operation	Steering and linkage
Fluid levels <sup>1</sup> ; fill if necessary	Tires including the spare for wear and proper pressure <sup>2</sup>

# Scheduled Maintenance

Multi-Point Inspection	
For oil and fluid leaks	Windshield for cracks, chips or pits
Half-shaft dust boots	Washer spray and wiper operation

<sup>1</sup> Brake, coolant recovery reservoir, automatic transmission and window washer.

<sup>2</sup> If your vehicle has a temporary mobility kit, check the tire sealant expiration Use By date on the canister. Replace as needed.

Be sure to ask your dealership service advisor or technician about the multi-point vehicle inspection. It is a comprehensive way to perform a thorough inspection of your vehicle. Your checklist gives you immediate feedback on the overall condition of your vehicle.

Your vehicle lets you know when an oil change is due by displaying a message in the information display.

The following table provides examples of vehicle use and its impact on oil change intervals. It is a guideline only. Actual oil change intervals depend on several factors and generally decrease with severity of use.

## NORMAL SCHEDULED MAINTENANCE - DIESEL

### Oil Change Reminder

Your vehicle comes with an oil change reminder that determines when you should change the engine oil based on how you use your vehicle.

When to Expect the Message Prompting You to Change Your Oil	
mi (km)	Vehicle Use and Example
7,500–10,000 mi (12,000–16,000 km)	Normal
	Normal commuting with highway driving. No, or moderate, load or towing. Flat to moderately hilly roads. No extended idling.
5,000–7,500 mi (8,000–12,000 km)	Severe
	Moderate to heavy load or towing. Mountainous or off-road conditions. Extended idling, 200-300 hours. Extended hot or cold operation.

# Scheduled Maintenance

When to Expect the Message Prompting You to Change Your Oil	
mi (km)	Vehicle Use and Example
2,500–5,000 mi (4,000–8,000 km)	Extreme
	Maximum load or towing. Extreme hot or cold operation. Use of high sulfur diesel fuel.

**Note:** Use the appropriate special operating condition for maintenance information when using high sulfur diesel fuels, operating your vehicle off-road or in dusty conditions, such as unpaved roads.

**Note:** For every hour that your vehicle idles, it accumulates the equivalent of approximately 25 mi (40 km).

## Normal Maintenance Intervals

At Every Oil Change Interval as Indicated by the Information Display <sup>1</sup>
Change the engine oil and filter. <sup>2</sup>
Fuel and water separator. Drain if necessary or if indicated by the information display.
Refill the diesel exhaust fluid tank.
Rotate the tires, inspect the tires for wear and measure the tread depth. <sup>4</sup>
Perform a multi-point inspection, recommended.
Inspect the air filter restriction gauge. Replace the air filter if necessary. <sup>3</sup>
Inspect the brake pads, shoes, rotors, drums, brake linings, hoses and the parking brake.
Inspect the engine and secondary cooling system coolant concentration freeze-point protection, level and the hoses.
Inspect the exhaust system and heat shields.

# Scheduled Maintenance

## At Every Oil Change Interval as Indicated by the Information Display<sup>1</sup>

Inspect the front axle and U-joints. Lubricate any grease fittings. Four-wheel drive vehicles.

Inspect the steering linkage, ball joints, suspension, tie-rod ends, driveshaft and the U-joints. Lubricate any grease fittings.

<sup>1</sup> Do not exceed one year/10,000 mi (16,000 km) or 350 engine hours between service intervals.

<sup>2</sup> Reset the Intelligent Oil-Life Monitor after engine oil and filter changes.

<sup>3</sup> Reset the engine air filter information monitor after you replace the air filter.

<sup>4</sup> Rotate the front wheels on vehicles with dual rear wheels when specified. Only rotate the rear wheels if you notice unusual wear.

## Brake Fluid Maintenance<sup>1</sup>

Every three years

Change the brake fluid.<sup>2</sup>

<sup>1</sup> Perform this maintenance item every three years. Do not exceed the designated time for the interval.

<sup>2</sup> Brake fluid servicing requires special equipment available at your authorized dealer.

## Other Maintenance Items<sup>1</sup>

Every 20,000 mi  
(32,000 km)

Replace the cabin air filter.

Every 30,000 mi  
(48,000 km)

Replace the engine air filter.<sup>2</sup>  
Replace the engine-mounted and frame-mounted fuel filters. Inspect the engine and secondary cooling system coolant concentration freeze-point protection, additive corrosion inhibitor strength, coolant level, and hoses. Add coolant additive if necessary.

Every 50,000 mi  
(80,467 km)

Replace the engine air inlet foam filter.

Every 60,000 mi  
(96,000 km)

Replace the front wheel bearing grease and grease seal if using non-sealed bearings. Two-wheel drive vehicles.

At 90,000 mi  
(144,000 km)

Inspect the accessory drive belt or belts.<sup>3</sup>

# Scheduled Maintenance

Other Maintenance items <sup>1</sup>	
Every 150,000 mi (240,000 km)	Change the automatic transmission fluid and filter. Consult dealer for requirements.
	Replace the accessory drive belt or belts if not replaced within the last 100,000 mi (160,000 km)
	Replace the front wheel bearings and seals if using non-sealed bearings. Two-wheel drive vehicles.
	Change the axle(s) fluid. See exceptions.
	Change the transfer case fluid, if equipped.
At 200,000 mi (320,000 km)	Change the engine and secondary cooling system coolant. <sup>4</sup>

<sup>1</sup>You can perform these maintenance items within 3,000 mi (4,800 km) of the last oil change. Do not exceed the designated distance for the interval.

<sup>2</sup>Reset the engine air filter information monitor after you replace the air filter.

<sup>3</sup>Perform follow-up inspections every 15,000 mi (24,000 km) after the initial inspection. Replace the belt or belts at 150,000 mi (240,000 km).

<sup>4</sup>Initial replacement at 10 years or 200,000 mi (320,000 km), then every 5 years or 100,000 mi (160,000 km).

## NORMAL SCHEDULED MAINTENANCE - GASOLINE

### Oil Change Reminder

Your vehicle comes with an oil change reminder that determines when you should change the engine oil based on how you use your vehicle.

Your vehicle lets you know when an oil change is due by displaying a message in the information display.

The following table provides examples of vehicle use and its impact on oil change intervals. It is a guideline only. Actual oil change intervals depend on several factors and generally decrease with severity of use.

When to Expect the Message Prompting You to Change Your Oil	
mi (km)	Vehicle Use and Example
7,500–10,000 mi (12,000–16,000 km)	<b>Normal</b>
	Normal commuting with highway driving. No, or moderate, load or towing. Flat to moderately hilly roads.

# Scheduled Maintenance

When to Expect the Message Prompting You to Change Your Oil	
mi (km)	Vehicle Use and Example
	No extended idling.
5,000–7,500 mi (8,000–12,000 km)	<b>Severe</b>
	Moderate to heavy load or towing. Mountainous or off-road conditions. Extended idling, 200-300 hours. Extended hot or cold operation.
2,500–5,000 mi (4,000–8,000 km)	<b>Extreme</b>
	Maximum load or towing. Extreme hot or cold operation. Use of high sulfur diesel fuel.

**Note:** For every hour that your vehicle idles, it accumulates the equivalent of approximately 25 mi (40 km).

## Normal Maintenance Intervals

10,000 mi (16,000 km) / 450 Engine Hours or 12 Months - Whichever Comes First
Change the engine oil and filter. <sup>1</sup>
Rotate the tires, inspect tire wear and measure the tread depth. <sup>2</sup>
Inspect the wheels and related components for abnormal noise, wear, looseness or drag.
Perform multi-point inspection - recommended.
Inspect the brake pads, shoes, rotors, drums, brake linings, hoses and the parking brake.
Inspect the engine coolant concentration, freeze-point protection, level and the hoses.
Inspect the exhaust system and heat shields.
Inspect the front axle and U-joints. If applicable, lubricate the grease fittings. Four-wheel drive vehicles.
Inspect the steering linkage, ball joints, suspension, tie-rod ends, driveshaft and the U-joints. If applicable, lubricate the grease fittings.

<sup>1</sup> Reset the Intelligent Oil-Life Monitor after engine oil and filter changes.

<sup>2</sup> Rotate the front wheels on vehicles with dual rear wheels when specified. Only rotate the rear wheels if you notice unusual wear.



# Scheduled Maintenance

<b>Brake Fluid Maintenance<sup>1</sup></b>	
Every three years	Change the brake fluid. <sup>2</sup>

<sup>1</sup> Perform this maintenance item every three years. Do not exceed the designated time for the interval.

<sup>2</sup> Brake fluid servicing requires special equipment available at your authorized dealer.

<b>Other Maintenance Items</b>	
Every 20,000 mi (32,180 km)	Replace the cabin air filter.
Every 30,000 mi (48,000 km)	Replace the engine air filter.
Every 60,000 mi (96,000 km)	Replace the front wheel bearing grease and grease seal, if you use non-sealed bearings.
Every 100,000 mi (160,934 km)	Replace the spark plugs.
Every 100,000 mi (160,934 km)	Inspect the accessory drive belt or belts. <sup>1</sup>
Every 150,000 mi (240,000 km)	Change the automatic transmission fluid and filter on 6-speed transmission. Consult dealer for requirements.
	Replace the accessory drive belt or belts if not replaced within the last 100,000 mi (160,000 km).
	Replace the front wheel bearings and seals if you use non-sealed bearings.
	Change the axle(s) fluid. See exceptions.
	Change the transfer case fluid, if applicable.
At 200,000 mi (320,000 km)	Change the engine coolant. <sup>2</sup>

<sup>1</sup> If not replaced, inspect the belt or belts every 15,000 mi (24,000 km).

<sup>2</sup> Initial replacement at 10 years or 200,000 mi (320,000 km), then every 5 years or 100,000 mi (160,000 km).

## Scheduled Maintenance

### SPECIAL OPERATING CONDITIONS SCHEDULED MAINTENANCE - DIESEL

If you operate your vehicle primarily in any of the following conditions, you need to

perform extra maintenance as indicated. If you operate your vehicle occasionally under any of these conditions, it is not necessary to perform the extra maintenance. For specific recommendations, see your dealership service advisor or technician.

<b>Towing a Trailer or Using a Car-top Carrier</b>	
As required	Change the engine oil and filter as indicated by the information display, and perform the services listed in the scheduled maintenance chart.
	See the axle maintenance items under <b>Exceptions</b> .
Every 15,000 mi (24,000 km) or six months, 600 engine hours	Replace the engine-mounted and frame-mounted fuel filters.
Every 30,000 mi (48,000 km)	Replace the wheel bearing grease and grease seals if using non-sealed bearings. (Two-wheel drive vehicles)
At 60,000 mi (96,000 km) or 2400 engine hours	Flush and refill the coolant.

**Note:** After the initial coolant flush and fill at 60,000 mi (96,000 km) or 2400 engine hours, flush and fill every 45,000 mi (72,000 km) or 1800 engine hours thereafter.

<b>Frequent or Extended Idling (Over 10 Minutes Per Hour of Normal Driving) or Frequent Low-speed Operation if your Vehicle is Used for Stationary Operation</b>	
As required	Change the engine oil and filter as indicated by the information display, and perform the services listed in the scheduled maintenance chart.
Every 15,000 mi (24,000 km), six months or 600 engine hours	Replace the engine-mounted and frame-mounted fuel filters.
Every 60,000 mi (96,000 km) or 2400 engine hours	Flush and refill the coolant.

**Note:** After the initial coolant flush and fill at 60,000 mi (96,000 km) or 2400 engine hours, flush and fill every 45,000 mi (72,000 km) or 1800 engine hours thereafter.

## Scheduled Maintenance

<b>Frequent Low-speed Operation, Consistent Heavy Traffic Under 25 mph (40 km/h) or Long Rush-hour Traffic</b>	
As required	Change the engine oil and filter as indicated by the information display, and perform the services listed in the scheduled maintenance chart.
Every 15,000 mi (24,000 km), six months or 600 engine hours	Replace the engine-mounted and frame-mounted fuel filters.
Every 60,000 mi (96,000 km) or 2400 engine hours	Flush and refill the coolant.

**Note:** After the initial coolant flush and fill at 60,000 mi (96,000 km) or 2400 engine hours, flush and fill every 45,000 mi (72,000 km) or 1800 engine hours thereafter.

<b>Sustained High-speed Driving at Gross Vehicle Weight Rating (Maximum Loaded Weight for Vehicle Operation)</b>	
As required	Change the engine oil and filter as indicated by the information display, and perform the services listed in the scheduled maintenance chart.
Every 15,000 mi (24,000 km), six months or 600 engine hours	Replace the engine-mounted and frame-mounted fuel filters.
Every 30,000 mi (48,000 km)	Replace the wheel bearing grease and grease seals if using non-sealed bearings. (Two-wheel drive vehicles)
Every 60,000 mi (96,000 km) or 2400 engine hours	Flush and refill the coolant.

**Note:** After the initial coolant flush and fill at 60,000 mi (96,000 km) or 2400 engine hours, flush and fill every 45,000 mi (72,000 km) or 1800 engine hours thereafter.

## Scheduled Maintenance

<b>Operating in Sustained Ambient Temperatures Below -9°F (-23°C) or Above 100°F (38°C)</b>	
As required	Change the engine oil and filter as indicated by the information display, and perform the services listed in the scheduled maintenance chart.
Every 15,000 mi (24,000 km), six months or 600 engine hours	Replace the engine-mounted and frame-mounted fuel filters.
Every 30,000 mi (48,000 km)	Replace the wheel bearing grease and grease seals if using non-sealed bearings. (Two-wheel drive vehicles)

<b>Operating in Dusty or Sandy Conditions (Such as Unpaved or Dusty Roads)</b>	
Every 7,500 mi (12,000 km)	Rotate the tires, inspect the tires for wear and measure tread depth. <sup>1</sup>
	Inspect the brake system pads and rotors.
	Inspect the air filter restriction gauge. Replace the filter if necessary.
	Inspect the steering and suspension ball joints and tie rods. Lubricate any grease fittings.
Every 7,500 mi (12,000 km), six months or 300 engine hours	Change the engine oil and filter. <sup>2</sup>
	Inspect and lubricate the U-joints.
Every 15,000 mi (24,000 km), 6 months or 600 engine hours	Replace the engine-mounted and frame-mounted fuel filters.
Every 30,000 mi (48,000 km)	Replace the air inlet foam filter.
	Replace the wheel bearing grease and grease seals if using non-sealed bearings. (Two-wheel drive vehicles)

<sup>1</sup> Rotate the front wheels on vehicles with dual rear wheels when specified. Rotate the rear wheels if unusual wear is noted.

<sup>2</sup> Reset the Oil Change Reminder after engine oil and filter changes.

## Scheduled Maintenance

<b>Off-road Operation</b>	
As required	Inspect functional holes in each leg of the twin exhaust tips and the holes under the shield just inboard of the right rear tire to make sure they are clean and clear of debris or foreign materials. Refer to the Vehicle Care chapter of your owner's manual for more information.
	Inspect the steering and suspension ball joints and tie rods. Lubricate any grease fittings.
Every 7,500 mi (12,000 km), six months or 300 engine hours	Rotate the tires, inspect the tires for wear and measure tread depth. <sup>1</sup>
	Inspect the brake system pads and rotors.
	Inspect the air filter restriction gauge. Replace the filter if necessary.
Every 7,500 mi (12,000 km) or 300 engine hours	Change the engine oil and filter. <sup>2</sup>
Every 15,000 mi (24,000 km), six months or 600 engine hours	Replace the engine-mounted and frame-mounted fuel filters.
Every 30,000 mi (48,000 km)	Replace the air inlet foam filter.
	Replace the wheel bearing grease and grease seals if using non-sealed bearings. (Two-wheel drive vehicles).
Every 50,000 mi (80,000 km)	Change the rear axle fluid (Dana rear axles only - some F-350s; all F-450s and F-550s).
	Change the transfer case fluid. (Four-wheel drive vehicles)
	Inspect the front axle fluid. (Four-wheel drive vehicles)

<sup>1</sup>Vehicles with dual rear wheels should rotate the front wheels when specified; rear wheels only if unusual wear is noted.

<sup>2</sup>Reset the Oil Change Reminder after engine oil and filter changes.

# Scheduled Maintenance

<b>Using Biodiesel, up to and Including 20% Biodiesel (B20)</b>	
As required	Change the engine oil and filter as indicated by the information display, and perform the services listed in the scheduled maintenance chart.
Every 15,000 mi (24,000 km), six months or 300 engine hours	Replace the engine-mounted and frame-mounted fuel filters.

<b>Using Fuel Other Than Ultra-low Sulfur Diesel Fuel - Vehicles Operated Where Ultra-low Sulfur Diesel Fuel is not Required or Available</b>	
Every 2,500 mi (4,000 km) or three months (if using high sulfur fuel with more than 500 ppm sulfur)	Change engine oil and filter.
Every 5,000 mi (8,000 km) or six months (if using high sulfur fuel with fewer than 500 ppm sulfur)	Change engine oil and filter.

## Exceptions

### Axle and Transfer Case Maintenance

Axle(s) and transfer case (4X4 only) fluid changes or level checks are not required unless a leak is suspected or the assembly has been submerged in water. During long periods of trailer towing with outside temperatures above 70°F (21°C) or at wide-open throttle for long periods above 45 mph (72 km/h), change the rear axle fluid every 30,000 mi (48,000 km) if the rear axle is filled with non-synthetic fluid. This interval can be waived and the 150,000 mi (240,000 km) service interval can continue if the rear axle is filled with 75W140 synthetic gear fluid meeting Ford

specification WSL-M2C192-A, part number XY-75W140-QL, or equivalent. Add friction modifier XL-3 (EST-M2C118-A) or equivalent for complete refill of Traction-Lok rear axles. See **Capacities and Specifications** (page 467).

### Additional Axle Maintenance for Dual Rear Wheels

Change rear axle fluid every 250,000 mi (400,000 km) under normal driving conditions on all commercial applications. When operating your vehicle at or near maximum gross vehicle weights, change the rear axle fluid every 60,000 mi (96,000 km). In addition, follow this 60,000 mi (96,000 km) schedule when operating your vehicle under the special operating conditions where noted.

# Scheduled Maintenance

## California Fuel Filter Replacement

If you register your vehicle in California, the California Air Resources Board has determined that the failure to perform this maintenance item does not nullify the emission warranty or limit recall liability before the completion of your vehicle's useful life. Ford Motor Company, however, urges you to have all recommended maintenance services performed at the specified intervals and to record all vehicle service.

## Hot Climate Oil Change Intervals

Vehicles operating in the Middle East, North Africa, Sub-Saharan Africa or locations with similar climates using an American Petroleum Institute (API) Certified for Gasoline Engines (Certification mark) oil of SM or SN quality, the normal oil change interval is 3,000 mi (5,000 km).

If the available API SM or SN oils are not available, then the oil change interval is 2,000 mi (3,000 km).

## Engine Air Filter and Cabin Air Filter Replacement

The life of the engine air filter and cabin air filter is dependent on exposure to dusty and dirty conditions. Vehicles operated in these conditions require frequent inspection and replacement of the engine air filter and cabin air filter.

## Diesel Particulate Filter

Over time, a slight amount of ash builds up in the diesel particulate filter, which is not removed during the regeneration process. The filter may need to be replaced with a new or remanufactured part at approximately 250,000 mi (400,000 km). Actual mileage varies depending on engine and vehicle operating conditions.

In this case, the engine control system sets a service light (wrench icon) to inform you to bring your vehicle to the dealer for service. If there are any issues with the oxidation catalyst or particulate filter system, a service light (wrench or engine icon) sets by the engine control system to inform you to bring your vehicle into a dealer for service.

## SPECIAL OPERATING CONDITIONS SCHEDULED MAINTENANCE - GASOLINE

If you operate your vehicle primarily in any of the following conditions, you need to perform extra maintenance as indicated. If you operate your vehicle occasionally under any of these conditions, it is not necessary to perform the extra maintenance. For specific recommendations, see your dealership service advisor or technician.

Towing a Trailer or Using a Car-top Carrier	
Inspect frequently, service as required	Inspect and lubricate U-joints if equipped with grease fittings.
	See axle maintenance items under <b>Exceptions</b> .
Every 5,000 mi (8,000 km)	Inspect the wheels and related components for abnormal noise, wear, looseness or drag.
	Rotate tires, inspect tires for wear and measure tread depth. <sup>1</sup>

## Scheduled Maintenance

<b>Towing a Trailer or Using a Car-top Carrier</b>	
Every 5,000 mi (8,000 km) or six months.	Change engine oil and filter.
	Inspect and lubricate U-joints if equipped with grease fittings.
Every 30,000 mi (48,000 km)	Replace front wheel bearing grease and grease seals if non-sealed bearings are used.
Every 60,000 mi (96,000 km)	Change transfer case fluid (Four-wheel drive vehicles).
	Replace spark plugs.

<sup>1</sup> Rotate the front wheels on vehicles with dual rear wheels when specified. Rotate the rear wheels if unusual wear is noted.

<b>Extensive Idling or Low-speed Driving for Long Distances, as in Heavy Commercial Use (Such as Delivery, Taxi, Patrol Car or Livery)</b>	
Inspect frequently, service as required	Replace engine air filter.
	Replace cabin air filter.
Every 5,000 mi (8,000 km)	Inspect brake system.
	Inspect wheels and related components for abnormal noise, wear, looseness or drag.
	Lubricate control arm and steering ball joints if equipped with grease fittings.
	Rotate tires, inspect tires for wear and measure tread depth. <sup>1</sup>
Every 5,000 mi (8,000 km) or six months	Inspect and lubricate U-joints if equipped with grease fittings.
Every 5,000 mi (8,000 km) or six months or 200 engine hours.	Change engine oil and filter.
Every 30,000 mi (48,000 km)	Replace front wheel bearing grease and grease seals if non-sealed bearings are used.
Every 60,000 mi (96,000 km)	Replace spark plugs.

<sup>1</sup> Rotate the front wheels on vehicles with dual rear wheels when specified. Rotate the rear wheels if unusual wear is noted.



## Scheduled Maintenance

<b>Operating in Dusty or Sandy Conditions (Such as Unpaved or Dusty Roads)</b>	
Inspect frequently, service as required	Replace engine air filter.
	Replace cabin air filter.
Every 5,000 mi (8,000 km)	Inspect the wheels and related components for abnormal noise, wear, looseness or drag.
	Rotate tires, inspect tires for wear and measure tread depth. <sup>1</sup>
Every 5,000 mi (8,000 km) or six months	Change engine oil and filter.
	Inspect and lubricate U-joints if equipped with grease fittings.
Every 30,000 mi (48,000 km)	Replace front wheel bearing grease and grease seals if non-sealed bearings are used.

<sup>1</sup> Rotate the front wheels on vehicles with dual rear wheels when specified. Rotate the rear wheels if unusual wear is noted.

<b>Off-road operation</b>	
Inspect frequently, service as required	Inspect steering linkage, ball joints and U-joints, Lubricate if equipped with grease fittings.
	Replace engine air filter.
Every 5,000 mi (8,000 km) or six months	Change engine oil and filter.
	Replace cabin air filter.
	Inspect the wheels and related components for abnormal noise, wear, looseness or drag.
	Rotate tires, inspect tires for wear and measure tread depth. <sup>1</sup>
Every 30,000 mi (48,000 km)	Replace front wheel bearing grease and grease seals if non-sealed bearings are used.

<sup>1</sup> Rotate the front wheels on vehicles with dual rear wheels when specified. Rotate the rear wheels if unusual wear is noted.

# Scheduled Maintenance

## Exclusive use of E85 (Flex Fuel Vehicles Only)

Every oil change interval	If ran exclusively on E85, fill the fuel tank full with regular unleaded fuel.
---------------------------	--

## Exceptions

### Axle and Transfer Case Maintenance

Axle(s) and transfer case (4X4 only) fluid changes or level checks are not required unless a leak is suspected or the assembly has been submerged in water. During long periods of trailer towing with outside temperatures above 70°F (21°C) or at wide-open throttle for long periods above 45 mph (72 km/h), change the rear axle fluid every 30,000 mi (48,000 km) if the rear axle is filled with non-synthetic fluid. This interval can be waived and the 150,000 mi (240,000 km) service interval can continue if the rear axle is filled with 75W140 synthetic gear fluid meeting Ford specification WSL-M2C192-A, part number XY-75W140-QL, or equivalent. Add friction modifier XL-3 (EST-M2C118-A) or equivalent for complete refill of Traction-Lok rear axles. See **Capacities and Specifications** (page 467).

### Additional Axle Maintenance for Dual Rear Wheels

Change rear axle fluid every 250,000 mi (400,000 km) under normal driving conditions on all commercial applications. When operating your vehicle at or near maximum gross vehicle weights, change the rear axle fluid every 60,000 mi (96,000 km). In addition, follow this 60,000 mi (96,000 km) schedule when operating your vehicle under the special operating conditions where noted.

### California Fuel Filter Replacement

If you register your vehicle in California, the California Air Resources Board has determined that the failure to perform this maintenance item does not nullify the emission warranty or limit recall liability before the completion of your vehicle's useful life. Ford Motor Company, however, urges you to have all recommended maintenance services performed at the specified intervals and to record all vehicle service.

### Hot Climate Oil Change Intervals

Vehicles operating in the Middle East, North Africa, Sub-Saharan Africa or locations with similar climates using an American Petroleum Institute (API) Certified for Gasoline Engines (Certification mark) oil of SM or SN quality, the normal oil change interval is 3,000 mi (5,000 km).

If the available API SM or SN oils are not available, then the oil change interval is 2,000 mi (3,000 km).

### Engine Air Filter and Cabin Air Filter Replacement

The life of the engine air filter and cabin air filter is dependent on exposure to dusty and dirty conditions. Vehicles operated in these conditions require frequent inspection and replacement of the engine air filter and cabin air filter.

# Customer Information

---

## ROLLOVER WARNING



**WARNING:** Utility vehicles have a significantly higher rollover rate than other types of vehicles.



**WARNING:** Vehicles with a higher center of gravity (utility and four-wheel drive vehicles) handle differently than vehicles with a lower center of gravity (passenger cars). Avoid sharp turns, excessive speed and abrupt steering in these vehicles. Failure to drive cautiously increases the risk of losing control of your vehicle, vehicle rollover, personal injury and death.



**WARNING:** In a rollover crash, an unbelted person is significantly more likely to die than a person wearing a seatbelt.



**WARNING:** Do not become overconfident in the ability of four-wheel drive vehicles. Although a four-wheel drive vehicle may accelerate better than a two-wheel drive vehicle in low traction situations, it won't stop any faster than two-wheel drive vehicles. Always drive at a safe speed.

Utility vehicles and trucks handle differently than passenger cars in the various driving conditions that are encountered on streets, highways and off-road. Utility vehicles and trucks are not designed for cornering at speeds as high as passenger cars any more than low-slung sports cars are designed to perform satisfactorily under off-road conditions.

## OUR SUSTAINABILITY REPORT

You should play your part in protecting the environment. Correct vehicle usage and the authorized disposal of waste, cleaning and lubrication materials are significant steps toward this aim.

For additional information about our sustainability progress and initiatives, visit [www.sustainability.ford.com](http://www.sustainability.ford.com).

## THE BETTER BUSINESS BUREAU AUTO LINE PROGRAM - UNITED STATES OF AMERICA

Your satisfaction is important to Ford Motor Company and to your dealer. If a warranty concern has not been resolved using the three-step procedure outlined earlier in this chapter in the Getting the Services you need section, you may be eligible to participate in the BBB AUTO LINE program.

The BBB AUTO LINE program consists of two parts – mediation and arbitration. During mediation, a representative of the BBB will contact both you and Ford Motor Company to explore options for settlement of the claim. If an agreement is not reached during mediation or you do not want to participate in mediation, and if your claim is eligible, you may participate in the arbitration process. An arbitration hearing will be scheduled so that you can present your case in an informal setting before an impartial person. The arbitrator considers the testimony provided and makes a decision after the hearing.

## Customer Information

---

Disputes submitted to the BBB AUTO LINE program are usually decided within 40 days after you file your claim with the BBB. You are not bound by the decision, and may reject the decision and proceed to court where all findings of the BBB Auto Line dispute, and decision, are admissible in the court action. Should you choose to accept the BBB AUTO LINE decision, Ford is then bound by the decision, and must comply with the decision within 30 days of receipt of your acceptance letter.

BBB AUTO LINE Application: Using the information that follows, please call or write to request a program application. You will be asked for your name and address, general information about your new vehicle, information about your warranty concerns, and any steps you have already taken to try to resolve them. A Customer Claim Form will be mailed that needs to be completed, signed and returned to the BBB along with proof of ownership. Upon receipt, the BBB reviews the claim for eligibility under the Program Summary Guidelines.

**You can get more information by calling BBB AUTO LINE at 1-800-955-5100, or writing to:**

**BBB AUTO LINE a Division of BBB National Programs, Inc.  
1676 International Drive, Suite 550  
McLean, VA 22102**

BBB AUTO LINE applications can also be requested by calling the Ford Motor Company Customer Relationship Center at 1-800-392-3673.

For additional information, refer to the Better Business Bureau website.

**Note:** *Ford Motor Company reserves the right to change eligibility limitations, modify procedures, or to discontinue this process at any time without notice and without obligation.*

## THE MEDIATION AND ARBITRATION PROGRAM - CANADA

For vehicles delivered to authorized Canadian dealers. In those cases where you continue to feel that the efforts by Ford of Canada and the authorized dealer to resolve a factory-related vehicle service concern have been unsatisfactory, Ford of Canada participates in an impartial third party mediation/arbitration program administered by the Canadian Motor Vehicle Arbitration Plan (CAMVAP).

The CAMVAP program is a straightforward and relatively speedy alternative to resolve a disagreement when all other efforts to produce a settlement have failed. This procedure is without cost to you and is designed to eliminate the need for lengthy and expensive legal proceedings.

In the CAMVAP program, impartial third-party arbitrators conduct hearings at mutually convenient times and places in an informal environment. These impartial arbitrators review the positions of the parties, make decisions and, when appropriate, render awards to resolve disputes. CAMVAP decisions are fast, fair, and final as the arbitrator's award is binding on both you and Ford of Canada.

CAMVAP services are available in all Canadian territories and provinces. For more information, without charge or obligation, call your CAMVAP Provincial Administrator directly at 1-800-207-0685 or visit [www.camvap.ca](http://www.camvap.ca).

## ORDERING A CANADIAN FRENCH OWNER'S MANUAL

You can obtain a French owner's manual from an authorized dealer or by contacting Helm, LLC at:

## Customer Information

---

HELM, LLC  
47911 Halyard Drive, Suite 200  
Plymouth, Michigan 48170  
Attention: Customer Service

Call toll free: 1-800-782-4356

Monday-Friday 8:00 a.m. - 6:00 p.m. EST

For additional information, visit  
[www.helminc.com](http://www.helminc.com).

### REPORTING SAFETY DEFECTS IN THE UNITED STATES

If you believe that your vehicle has a defect which could cause a crash or could cause injury or death, you should immediately inform the National Highway Traffic Safety Administration (NHTSA) in addition to notifying Ford Motor Company.

If NHTSA receives similar complaints, it may open an investigation, and if it finds that a safety defect exists in a group of vehicles, it may order a recall and remedy campaign. However, NHTSA cannot become involved in individual problems between you, your dealer, or Ford Motor Company.

To contact NHTSA, you may call the Vehicle Safety Hotline toll-free at 1-888-327-4236 (TTY: 1-800-424-9153); go to [www.safercar.gov](http://www.safercar.gov); or write to:

Administrator

1200 New Jersey Avenue,  
Southeast

Washington, D.C. 20590

You can also obtain other information about motor vehicle safety from [www.safercar.gov](http://www.safercar.gov).

### REPORTING SAFETY DEFECTS IN CANADA

If you believe that your vehicle has a defect which could cause a crash or could cause injury or death, you should immediately inform Transport Canada and Ford of Canada.

Transport Canada Contact Information	
Website	<a href="http://tc.canada.ca/recalls">http://tc.canada.ca/recalls</a>
Website	<a href="http://tc.canada.ca/rappels">http://tc.canada.ca/rappels</a>
Phone	1-800-333-0510

# Customer Information

---

## Ford of Canada Contact Information

Website	<a href="http://www.ford.ca">www.ford.ca</a>
Phone	1-800-565-3673

## RADIO FREQUENCY CERTIFICATION LABELS

## BLIND SPOT INFORMATION SYSTEM SENSORS

### Argentina



### Belarus



### Brazil



### Canada

Short Range Radar Sensor SRR3-B  
IC ID: 4135A-SRR3B

# Customer Information

---

This device contains licence-exempt transmitter(s)/receiver(s) that comply with Innovation, Science and Economic Development Canada's licence-exempt RSS(s). Operation is subject to the following two conditions:

1. This device may not cause interference.
2. This device must accept any interference, including interference that may cause undesired operation of the device.

Radiofrequency radiation exposure information:

This equipment complies with radiation exposure limits set forth for an uncontrolled environment. This equipment should be installed and operated with minimum distance of 8 in (20 cm) between the radiator and the body of any persons, user or bystander.

L'émetteur/récepteur exempt de licence contenu dans le présent appareil est conforme aux CNR d'Innovation, Sciences et Développement économique Canada applicables aux appareils radio exempts de licence. L'exploitation est autorisée aux deux conditions suivantes:

1. L'appareil ne doit pas produire de brouillage;
2. L'appareil doit accepter tout brouillage radioélectrique subi, même si le brouillage est susceptible d'en compromettre le fonctionnement.

Cet équipement est conforme aux limites d'exposition aux rayonnements établies pour un environnement non contrôlé. Cet équipement doit être installé et utilisé avec un minimum de 8 in (20 cm) de distance entre la source de rayonnement et votre corps.

## Djibouti

AGREE PAR LE MCPT (REPUBLIQUE DE DJIBOUTI)  
Numéro d'agrément : 240/MCPT/SG/16  
Date d'agrément : 23/05/2016

## European Union EU



# Customer Information

---

## Ghana

NCA PRODUCT IDENTIFIER: 3R8-8M-7DF-231

## Mauritania

AGREE PAR L'ANE MAURITANIE  
Numéro d'agrément : 0727/ARE/2018  
Date d'agrément : 10/12/2019

## Jamaica

This product has been Type Approved  
by Jamaica: SMA - SRR3-B.

## Malaysia



RALM/24A/0715/S(15-2272)

## Mexico

IFETEL: RLVCSR15-0904

La operación de este equipo está sujeta a las siguientes  
dos condiciones:

- (1) es posible que este equipo o dispositivo no cause  
interferencia perjudicial y
- (2) este equipo o dispositivo debe aceptar cualquier  
interferencia, incluyendo la que pueda causar  
su operación no deseada.

## Moldova





# Customer Information

---

## Pakistan



## Serbia



## Paraguay



## Singapore

Complies with IMDA Standards

DA 00461

## Russia



## South Africa



# Customer Information

---

## South Korea



MSIP-CRM-8DC-SRR3B

## Taiwan, China

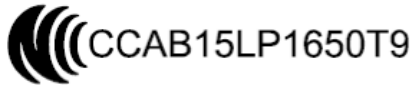

### 警語

經型式認證合格之低功率射頻電機，非經許可，公司、商號或使用者均不得擅自變更頻率、加大功率或變更原設計之特性及功能。

低功率射頻電機之使用不得影響飛航安全及干擾合法通信；經發現有干擾現象時，應立即停用，並改善至無干擾時方得繼續使用。

前項合法通信，指依電信法規定作業之無線電通信。低功率射頻電機須忍受合法通信或工業、科學及醫療用電波輻射性電機設備之干擾。

# Customer Information

## Ukraine



This one is a bit new. I requires the logo and the following text (both in attached also):

справжнім fIDC. Automotive Distance Control Systems GmbH заявляє, що тип радіообладнання SRR3 - В відповідає технічному регламенту радіообладнання ;

повний текст декларації про відповідність доступний на веб-сайті за такою адресою :

<http://continental.automotive-approvals.com/>

## United Arab Emirates (U.A.E.)

TRA  
REGISTERED No:  
ER62934

DEALER No:  
DA40068

## CAUTION TO USERS

Changes or modifications not expressly approved by the party responsible for compliance could void the user's authority to operate the equipment.

## Vietnam



## United States of America

FCC ID: OAYSRR3B

This device complies with Part 15 of the FCC Rules. Operation is subject to the following two conditions:

1. This device may not cause harmful interference, and
2. This device must accept any interference received, including interference that may cause undesired operation.

# Customer Information

---

## Zambia



## Ghana

NCA PRODUCT IDENTIFIER: ZRO-M8-7E3-281

## BODY CONTROL MODULE

### Argentina



## Jamaica

This product has been Type Approved by Jamaica: SMA - M3NA2C766336.

## Brazil



## Moldova



# Customer Information

---

## Morocco

AGREE PAR L'ANRT MAROC  
Numéro d'agrément: MR 20148 ANRT 2019  
Date d'agrément: 19/06/2019

## Singapore

Complies with IMDA Standards

DA 00461

## Paraguay



2019-01-I-000076

## Serbia



## South Africa



## Ukraine



# Customer Information

## United Arab Emirates (U.A.E.)

TRA  
REGISTERED No: ER68566/19  
DEALER No: DA37380/15

## Vietnam



## United States and Canada

 **WARNING:** Changes or modifications not expressly approved by the party responsible for compliance could void the user's authority to operate the equipment. The term "IC:" before the radio certification number only signifies that Industry Canada technical specifications were met.

FCC ID: M3NA2C766336

IC: 7812A-A2C766336

This device complies with Part 15 of the FCC Rules and with Innovation, Science and Economic Development Canada's licence-exempt RSS(s). Operation is subject to the following two conditions:

1. This device may not cause harmful interference, and
2. This device must accept any interference received, including interference that may cause undesired operation.

## Zambia



## CRUISE CONTROL MODULE

### Argentina



# Customer Information

---

## Brazil



0039-13-8645

Este equipamento não tem direito à proteção  
contra interferência prejudicial e não pode causar  
interferência em sistemas devidamente autorizados.

## China

CMIIT ID: 2013DJ5794

## Djibouti

AGREE PAR LE MCPT (REPUBLIQUE DE DJIBOUTI)  
Numéro d'agrément : 237/MCPT/SG/16  
Date d'agrément : 23/05/2016

## Ghana

NCA APPROVED: NCA/TA/16/15

## Jamaica

This product has been Type Approved by  
Jamaica: SMA – L2C0051TR

## Malaysia



CIDF18000193

## Mauritania

AGREE PAR L'ANE MAURITANIE  
Numéro d'agrément : 0473/ARE/2018  
Date d'agrément : 26/02/2018

# Customer Information

---

## Moldova



## Serbia



## Morocco

AGREE PAR L'ANRT MAROC  
Numéro d'agrément : MR 7677 ANRT 2012  
Date d'agrément : 28/11/2012

## Singapore

Complies with IMDA Standards  
  
DA105753

## Pakistan



## South Africa





# Customer Information

## South Korea



KCC-CRI-DPH-L20051TR

## Syria

SyTRA  
REGISTERED No:  
2015/0423

## Taiwan

 CCAB13LP0080T2

## Ukraine



## United Arab Emirates (U.A.E.)

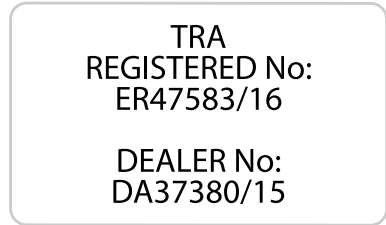

## United States and Canada

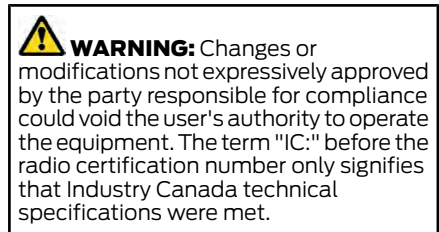

FCC ID: L2C0051TR

IC: 3432A-0051TR

# Customer Information

This device complies with Part 15 of the FCC Rules and with Innovation, Science and Economic Development Canada's licence-exempt RSS(s). Operation is subject to the following two conditions:

1. This device may not cause harmful interference, and
2. This device must accept any interference received, including interference that may cause undesired operation.

## Vietnam



## KEYS AND REMOTE CONTROLS

### Argentina



## Djibouti

AGREE PAR LE MCPT (REPUBLIQUE DE DJIBOUTI)  
Numéro d'agrément : 289/MCPT/SC/116  
Date d'agrément : 02/07/2016

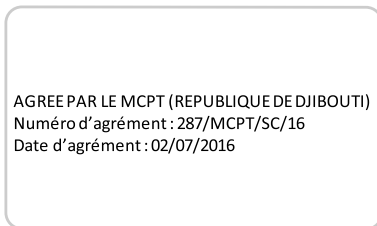

## Ghana

**NCA APPROVED: 2R9-1H-7E0-01A**

# Customer Information

---

## Mauritania

NCA APPROVED: 2R9-8M-7E0-x94

AGREE PAR L'ANE MAURITANIE  
Numéro d'agrément : 0323/ARE/2016  
Date d'agrément : 07/03/2016

## Jamaica

**This product has been Type Approved  
by Jamaica: SMA – A2C93142100**

This product has been Type Approved  
by Jamaica: SMA – A2C97102000

## Moldova



## Malaysia



F17000176

## Morocco

AGREE PAR L'ANRT MAROC  
Numéro d'agrément : MR 12433 ANRT 2016  
Date d'agrément : 31/08/2016

AGREE PAR L'ANRT MAROC  
Numéro d'agrément : MR 12432 ANRT 2016  
Date d'agrément : 31/08/2016

# Customer Information

---

## Pakistan

Pakistan Telecommunication Authority



Approved by PTA 2016

## Singapore

Complies with IMDA Standards

DA 00461

## South Africa

## Paraguay



NR: 2016-9-I-000220

NR: 2016-9-I-000222

## Serbia



## Customer Information

---

### South Korea



TRA  
REGISTERED No: ER47690/16  
DEALER No: DA37380/15

MSIP-CRM-TAL-A2C97102000

### Ukraine



TRA  
REGISTERED No:  
ER37535/15  
  
DEALER No:  
DA37380/15

### United Arab Emirates (U.A.E.)

TRA  
REGISTERED No:  
ER46754/16  
  
DEALER No:  
DA37380/15

TRA  
REGISTERED NO: ER49357/16  
DEALER NO: DA37380/15

# Customer Information

## United States and Canada



**WARNING:** Changes or modifications not expressly approved by the party responsible for compliance could void the user's authority to operate the equipment. The term "IC:" before the radio certification number only signifies that Industry Canada technical specifications were met.

FCC ID: M3N-A2C931426

FCC ID: M3N-A2C931423

IC: 7812A-A2C931426

IC: 7812A-A2C913423

This device complies with Part 15 of the FCC Rules and with Innovation, Science and Economic Development Canada's licence-exempt RSS(s). Operation is subject to the following two conditions:

1. This device may not cause harmful interference, and
2. This device must accept any interference received, including interference that may cause undesired operation.

## Vietnam



## Zambia



## PASSIVE ANTI-THEFT SYSTEM

## Argentina



# Customer Information

## Brazil



0106-14-03199

Este equipamento opera em caráter secundário, isto é, não tem direito a proteção contra interferência prejudicial, mesmo de estações do mesmo tipo, e não pode causar interferência a sistemas operando em caráter primário.

## Canada and United States of America



**WARNING:** Changes or modifications not expressly approved by the party responsible for compliance could void the user's authority to operate the equipment. The term "IC:" before the radio certification number only signifies that Industry Canada technical specifications were met.

FCC ID: OUC11545917

IC: 850K-11545917

This device complies with Part 15 of the FCC Rules and with Innovation, Science and Economic Development Canada's licence-exempt RSS(s). Operation is subject to the following two conditions:

1. This device may not cause harmful interference, and
2. This device must accept any interference received, including interference that may cause undesired operation.

## Djibouti

AGREE PAR LE MCPT (REPUBLIQUE DE DJIBOUTI)  
Numéro d'agrément: 243/MCPT/SC/16  
Date d'agrément: 23/05/16

## Ghana

NCA APPROVED: NCA/TA/16/22

## Indonesia

SERTIFIKAT NOMOR : 44714/SDPPI/2016  
PLG ID: 4941

# Customer Information

---

## Jamaica

This product has been Type Approved by Jamaica: SMA- OUC11545917

## Moldova



## Malaysia



## Morocco

AGREE PAR L'ANRT MAROC  
Numéro d'agrément: MR 8922 ANRT 2014  
Date d'agrément: 04/02/2014

CIDF18000209

## Mauritania

AGREE PAR L'ANE MAURITANIE  
Numéro d'agrément: 0231/ARE/2014  
Date d'agrément: 14/11/2014

## Pakistan





# Customer Information

---

## Paraguay

NR: 2017-09-10000292



## South Africa

TA-2013/1617

APPROVED



## Serbia



И011 16

## South Korea



MSIP-RRM-OAC-OUC11541917

## Singapore

Complies with IMDA Standards

DA 00461

## Syria

SyTRA  
REGISTERED No:  
1510/4NK

# Customer Information

## Taiwan, China

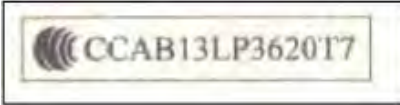

## Vietnam



## Ukraine



## RADIO TRANSCEIVER MODULE

### Argentina



## United Arab Emirates (U.A.E.)

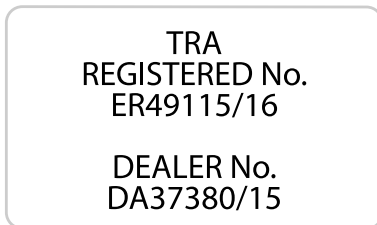

## Djibouti

AGREE PAR LE MCPT (REPUBLIQUE DE DJIBOUTI)  
Numéros d'agrément : 033/DDTIC/2020  
Date d'agrément : 07/06/2020

AGREE PAR LE MCPT (REPUBLIQUE DE DJIBOUTI)  
Numéros d'agrément : 034/DDTIC/2020  
Date d'agrément : 07/06/2020

# Customer Information

---

## Ghana

NCA APPROVED: SRO-1M-7E4-108

NCA APPROVED: SRO-1M-7E4-114

AGREE PAR L'ANE MAURITANIE  
Numéro d'agrément : 0802/ARE/2020  
Date d'agrément : 03/06/2020

## Jamaica

This product has been Type Approved by  
Jamaica: SMA - FO1-RX315UDA.

This product has been Type Approved by  
Jamaica: SMA - FO1-TR903BDA.

## Mauritania

AGREE PAR L'ANE MAURITANIE  
Numéro d'agrément: 0803/ARE/2020  
Date d'agrément: 03/06/2020

## Moldova



## Morocco

AGREE PAR L'ANE MAROC  
Numéro d'agrément : MR 24102 ANRT 2020  
Date d'agrément : 18/05/2020

# Customer Information

---

## Pakistan



## Ukraine



## Serbia



## Taiwan



## South Africa



## United Arab Emirates (U.A.E.)

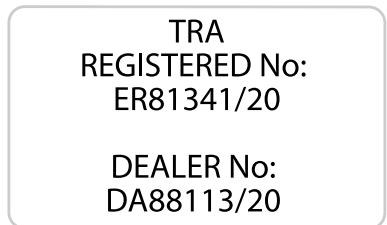

# Customer Information

## Zambia

TRA  
REGISTERED No:  
ER81342/20

DEALER No:  
DA88113/20



## United States and Canada



**WARNING:** Changes or modifications not expressly approved by the party responsible for compliance could void the user's authority to operate the equipment. The term "IC:" before the radio certification number only signifies that Industry Canada technical specifications were met.

FCC ID: L2C0082R

FCC ID: L2C0083TR

IC: 342A-0083TR

This device complies with Part 15 of the FCC Rules and with Innovation, Science and Economic Development Canada's licence-exempt RSS(s). Operation is subject to the following two conditions:

1. This device may not cause harmful interference, and
2. This device must accept any interference received, including interference that may cause undesired operation.

## SYNC - VEHICLES WITH: SYNC 4

### Argentina

The image shows the CNC logo, which consists of a globe icon on the left and the text "CNC" in large, bold, black letters on the right. To the right of "CNC" is the text "COMISIÓN NACIONAL DE COMUNICACIONES" in a smaller font.

CNC COMISIÓN NACIONAL  
DE COMUNICACIONES

CNC ID: C-24008

The image shows the CNC logo, which consists of a globe icon on the left and the text "CNC" in large, bold, black letters on the right. To the right of "CNC" is the text "COMISIÓN NACIONAL DE COMUNICACIONES" in a smaller font.

CNC COMISIÓN NACIONAL  
DE COMUNICACIONES

CNC ID: C-24009

# Customer Information

---

## Brazil



08657-19-01505

Este equipamento não tem direito à proteção  
contra interferência prejudicial e não pode causar  
interferência em sistemas devidamente autorizados.



08658-19-01505

Este equipamento não tem direito à proteção  
contra interferência prejudicial e não pode causar  
interferência em sistemas devidamente autorizados.

AGREE PAR LE MCPT (REPUBLIQUE DE DJIBOUTI)  
Numéro d'agrément : 125/DDTIC/2019  
Date d'agrément : 07/08/2019

## European Union EU



## Ghana

## Djibouti

AGREE PAR LE MCPT (REPUBLIQUE DE DJIBOUTI)  
Numéro d'agrément : 124/DDTIC/2019  
Date d'agrément : 07/08/2019

NCA APPROVED: ZRO-1H-7E3-182

NCA APPROVED: ZRO-1H-7E3-180

# Customer Information

---

## Jamaica

This product has been Type Approved by  
Jamaica: SMA – SYNC-G4.



## Mauritania

**AGREE PAR L'ANE MAURITANIE**  
**Numéro d'agrément : 0692/ARE/2018**  
**Date d'agrément : 08/08/2019**



## Malaysia



SQASI/TA/19/4047

SQASI/TA/19/4046

## Moldova



# Customer Information

---

## Morocco

AGREE PAR L'ANRT MAROC  
N° D'AGRÉMENT: MR 20608 ANRT 2019  
07 AOUT 2019

## Paraguay



2020-03-I-00192

2020-03-I-00193

## Serbia

AGREE PAR L'ANRT MAROC  
N° D'AGRÉMENT: MR 20606 ANRT 2019  
07 AOUT 2019



I005 20

## Pakistan

Pakistan Telecommunication Authority



Approved by PTA 2019

## Singapore

Complies with IMDA Standards

DA 00461



# Customer Information

## South Africa



## Taiwan

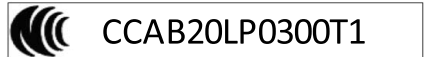

## South Korea



## Ukraine



# Customer Information

## United Arab Emirates (U.A.E.)



This device complies with Part 15 of the FCC Rules and with Innovation, Science and Economic Development Canada's licence-exempt RSS(s). Operation is subject to the following two conditions:

1. This device may not cause harmful interference, and
2. This device must accept any interference received, including interference that may cause undesired operation.

## Zambia

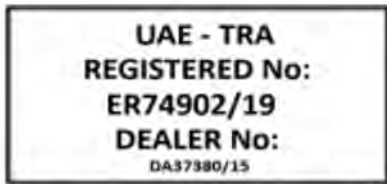

## United States and Canada

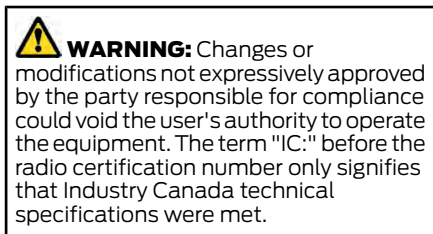

FCC ID: KMH-SYNCG4

FCC ID: KMH-SYNCG4L

IC: 1422A-SYNCG4

IC: 1422A-SYNCG4L

# Customer Information

---

## SYNC - VEHICLES WITH: SYNC 3

### Argentina



### Djibouti

AGREE PAR LE MCPT (REPUBLIQUE DE DJIBOUTI)  
Numéro d'agrément: 634/MCPT/DPT/17  
Date d'agrément: 04/12/2017

### Brazil



### European Union EU



### China

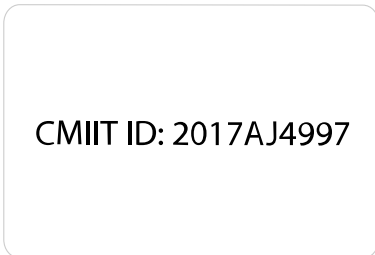

### Ghana

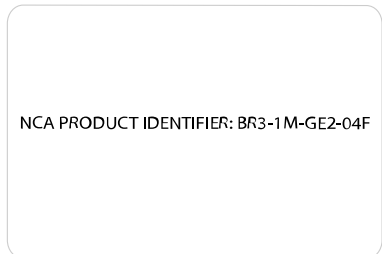

# Customer Information

---

## Jamaica

This product has been Type Approved  
by Jamaica: SMA - FG-185-SG32-MH.

## Malaysia



RBAB/57H/0318/S(18-0624)

## Mauritania

AGREE PAR L'ANE MAURITANIE  
Numéro d'agrément: 0442/ARE/2017  
Date d'agrément: 21/11/2017

## Moldova



## Morocco

AGREE PAR L'ANRT MAROC  
Numéro d'agrément: MR 15193 ANRT 2017  
Date d'agrément: 22/11/2017

## Pakistan

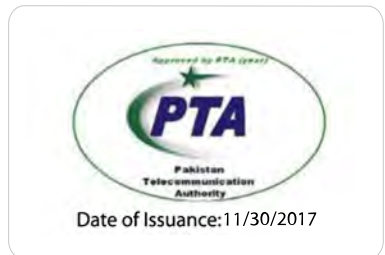

# Customer Information

---

## Paraguay



NR: 2017-12-I-0000413

## Serbia



## Singapore

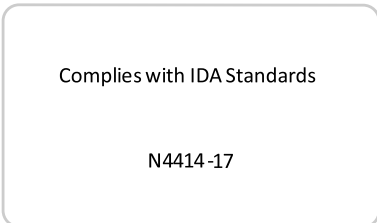

## South Africa



## South Korea



MSIP-CMM-pAs-FA-170-BCAR-HS

## Taiwan

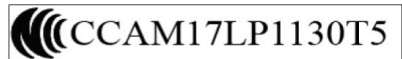

# Customer Information

## Ukraine



This device complies with Part 15 of the FCC Rules and with Innovation, Science and Economic Development Canada's licence-exempt RSS(s). Operation is subject to the following two conditions:

1. This device may not cause harmful interference, and
2. This device must accept any interference received, including interference that may cause undesired operation.

## Vietnam

## United Arab Emirates (U.A.E.)

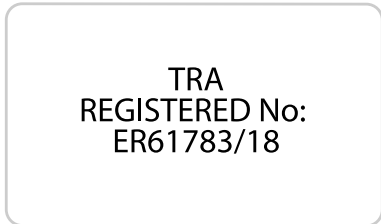

## Zambia

## United States and Canada

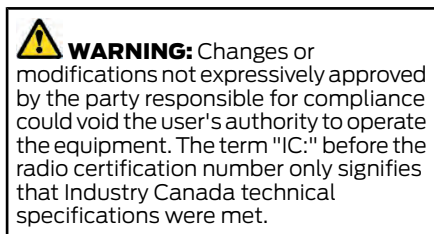

FCC ID: ACJ-FG-185-SG32MH

IC: 216B-FG185SG32MH

# Customer Information

## TELEMATICS CONTROL UNIT

United Arab Emirates (U.A.E.)

TRA

REGISTERED No:

ER87741/20

DEALER No:

DA83047/19

## TIRE PRESSURE MONITORING SYSTEM SENSORS - VEHICLES WITH: 315 MHZ SENSORS

Argentina

**CNC** COMISIÓN NACIONAL  
DE COMUNICACIONES

CNC ID: H-24068

## United States and Canada



**WARNING:** Changes or modifications not expressly approved by the party responsible for compliance could void the user's authority to operate the equipment. The term "IC:" before the radio certification number only signifies that Industry Canada technical specifications were met.

FCC ID: KMH-14H074-NA1

IC: 1422A-14H074NA1

This device complies with Part 15 of the FCC Rules and with Innovation, Science and Economic Development Canada's licence-exempt RSS(s). Operation is subject to the following two conditions:

1. This device may not cause harmful interference, and
2. This device must accept any interference received, including interference that may cause undesired operation.

Brazil



05160-16-08001

Este equipamento opera em caráter secundário, isto é, não tem direito a proteção contra interferência prejudicial, mesmo de estações do mesmo tipo, e não pode causar interferência a sistemas operando em caráter primário.

# Customer Information

## Jamaica

This product has been Type Approved by Jamaica: SMA – FP3

## Mexico

IFT: RLVSCFP16-1400  
"La operación de este equipo está sujeta a las siguientes dos condiciones:  
(1) es posible que este equipo o dispositivo no cause interferencia perjudicial y  
(2) este equipo o dispositivo debe aceptar cualquier interferencia, incluyendo la que pueda causar su operación no deseada."

## Paraguay



## United States and Canada

 **WARNING:** Changes or modifications not expressly approved by the party responsible for compliance could void the user's authority to operate the equipment. The term "IC:" before the radio certification number only signifies that Industry Canada technical specifications were met.

FCC ID: MRXFP3

IC: 2546A-FP3

This device complies with Part 15 of the FCC Rules and with Innovation, Science and Economic Development Canada's licence-exempt RSS(s). Operation is subject to the following two conditions:

1. This device may not cause harmful interference, and
2. This device must accept any interference received, including interference that may cause undesired operation.

## TIRE PRESSURE MONITORING SYSTEM SENSORS - VEHICLES WITH: 433 MHZ SENSORS

## Argentina





# Customer Information

---

## China

CMIIT ID: 2016DJ6033

## Jordan

Model: FP4  
Manufacturer: Schrader Electronics Ltd  
Type Approval No: TRC/LPD/2017/360  
Equipment Type: Low Power Device (LPD)

## Djibouti

AGREE PAR LE MCPT  
(REPUBLIQUE DE DJIBOUTI)  
Numéro d'agrément : 547/MCPT/DPT/16  
Date d'agrément : 27/09/16

## Mauritania

AGREE PAR L'ANE MAURITANIE  
Numéro d'agrément : 0358/ARE/2016  
Date d'agrément : 04/10/2016

## Ghana

NCA APPROVED: 2R9-8M-7E0-0BE

## Moldova



# Customer Information

---

## Nigeria

Connection and use of this communications equipment is permitted by the Nigerian Communications Commission

## Paraguay



## Oman

OMAN TRA  
TA-R/3591/16  
D080134

## Serbia

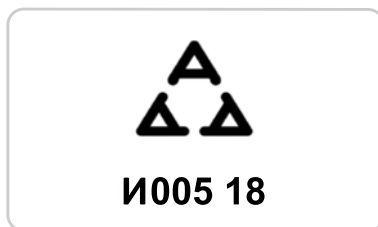

## Pakistan

Pakistan Telecommunication Authority



Approved by PTA 2016

## Singapore

Complies with  
IMDA Standards  
DA 107968

## South Korea



# Customer Information

---

## Ukraine



## WIRELESS ACCESSORY CHARGING MODULE

## Argentina



## United Arab Emirates

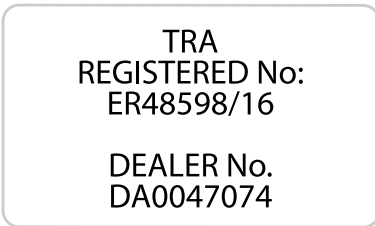

## Brazil



## Djibouti



# Customer Information

---

## European Union EU

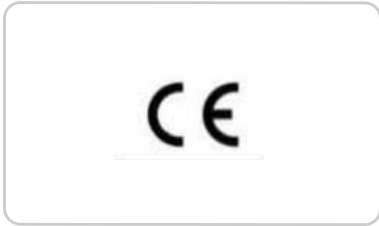

## Malaysia



SQASI/TA/19/4129

## Ghana

NCA APPROVED: 1R3-1M-7E1-174

## Mauritania



## Jamaica

This product has been Type Approved  
by Jamaica: SMA - WACM.

## Jordan

Type Approval No: TRC/LPD/2017/418  
Equipment Type: Low Power Device (LPD)

## Moldova



# Customer Information

---

## Morocco

AGREE PAR L'ANRT MAROC  
Numéro d'agrément : MR 15474 ANRT 2017  
Date d'agrément : 25/12/2017

## Singapore

Complies with IMDA Standards

DA 00461

## Paraguay



2017-10-I-0000333

## Serbia



## South Africa



## South Korea



# Customer Information

## Taiwan, China

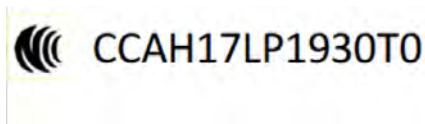

## United States

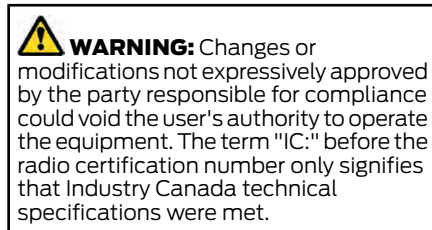

FCC ID: L2C0066T

This device complies with Part 15 of the FCC Rules and with Innovation, Science and Economic Development Canada's licence-exempt RSS(s). Operation is subject to the following two conditions:

1. This device may not cause harmful interference, and
2. This device must accept any interference received, including interference that may cause undesired operation.

## Ukraine



## Vietnam

## United Arab Emirates (U.A.E.)

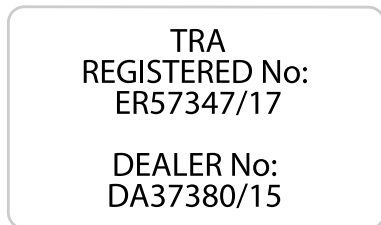

# Customer Information

---

## Zambia



## PERCHLORATE

Certain components in your vehicle such as airbag modules, seatbelt pretensioners and remote control batteries may contain perchlorate material. Special handling may apply for service or vehicle end of life disposal.

For more information visit:  
[www.dtsc.ca.gov/hazardouswaste/perchlorate](http://www.dtsc.ca.gov/hazardouswaste/perchlorate).

## REPLACEMENT PARTS RECOMMENDATION

We have built your vehicle to the highest standards using quality parts. We recommend that you demand the use of genuine Ford and Motorcraft parts whenever your vehicle requires scheduled maintenance or repair. You can clearly identify genuine Ford and Motorcraft parts by looking for the Ford, FoMoCo or Motorcraft branding on the parts or their packaging.

## Scheduled Maintenance and Mechanical Repairs

One of the best ways for you to make sure that your vehicle provides years of service is to have it maintained in line with our recommendations using parts that conform to the specifications detailed in this Owner's Manual.

Genuine Ford and Motorcraft parts meet or exceed these specifications.

## Collision Repairs

We hope that you never experience a collision, but accidents happen sometimes.

Genuine Ford replacement collision parts meet our stringent requirements for fit, finish, structural integrity, corrosion protection and dent resistance. During vehicle development we validate that these parts deliver the intended level of protection as a whole system. A great way to know for sure you are getting this level of protection is to use genuine Ford replacement collision parts.

## Warranty on Replacement Parts

Genuine Ford and Motorcraft replacement parts are the only replacement parts that benefit from a Ford Warranty.

The Ford Warranty may not cover damage caused to your vehicle as a result of failed non-Ford parts.

For additional information, refer to the terms and conditions of the Ford Warranty.

# Customer Information

## MOBILE COMMUNICATIONS EQUIPMENT



**WARNING:** Driving while distracted can result in loss of vehicle control, crash and injury. We strongly recommend that you use extreme caution when using any device that may take your focus off the road. Your primary responsibility is the safe operation of your vehicle. We recommend against the use of any hand-held device while driving and encourage the use of voice-operated systems when possible. Make sure you are aware of all applicable local laws that may affect the use of electronic devices while driving.

Using mobile communications equipment is becoming increasingly important in the conduct of business and personal affairs. However, you must not compromise your own or others' safety when using such equipment. Mobile communications can enhance personal safety and security when appropriately used, particularly in emergency situations. Safety must be paramount when using mobile communications equipment to avoid negating these benefits. Mobile communication equipment includes, but is not limited to, cellular phones, pagers, portable email devices, text messaging devices and portable two-way radios.

## END USER LICENSE AGREEMENT

### VEHICLE SOFTWARE END USER LICENSE AGREEMENT (EULA)

- You ("You" or "Your" as applicable) have acquired a vehicle having several devices, including SYNC ® and various control modules, ("DEVICES") that include software licensed or owned by Ford Motor Company and its affiliates ("FORD MOTOR COMPANY"). Those software products of FORD MOTOR COMPANY origin, as well as associated media, printed materials, and "online" or electronic documentation ("SOFTWARE") are protected by international intellectual property laws and treaties. The SOFTWARE is licensed, not sold. All rights reserved.
- The SOFTWARE may interface with and/or communicate with, or may be later upgraded to interface with and/or communicate with additional software and/or systems provided by FORD MOTOR COMPANY.

**IF YOU DO NOT AGREE TO THIS END USER LICENSE AGREEMENT ("EULA") DO NOT USE THE DEVICES OR COPY THE SOFTWARE. ANY USE OF THE SOFTWARE, INCLUDING BUT NOT LIMITED TO USE ON THE DEVICES, WILL CONSTITUTE YOUR AGREEMENT TO THIS EULA (OR RATIFICATION OF ANY PREVIOUS CONSENT).**

**GRANT OF SOFTWARE LICENSE:** This EULA grants you the following license:

- You may use the SOFTWARE as installed on the DEVICES and as otherwise interfacing with systems and/or services provide by or through FORD MOTOR COMPANY or its third party software and service providers.



# Customer Information

---

## Description of Other Rights and Limitations

- **Speech Recognition:** If the SOFTWARE includes speech recognition component(s), you should understand that speech recognition is an inherently statistical process and that recognition errors are inherent in the process. Neither FORD MOTOR COMPANY nor its suppliers shall be liable for any damages arising out of errors in the speech recognition process. It is your responsibility to monitor any speech recognition functions included in the system.
- **Limitations on Reverse Engineering, Decompilation and Disassembly:** You may not reverse engineer, decompile, translate, disassemble or attempt to discover any source code or underlying ideas or algorithms of the SOFTWARE nor permit others to reverse engineer, decompile or disassemble the SOFTWARE, except and only to the extent that such activity is expressly permitted by applicable law notwithstanding this limitation or to the extent as may be permitted by the licensing terms governing use of any open source components included with the SOFTWARE.
- **Limitations on Distributing, Copying, Modifying and Creating Derivative Works:** You may not distribute, copy, make modifications to or create derivative works based on the SOFTWARE, except and only to the extent that such activity is expressly permitted by applicable law notwithstanding this limitation or to the extent as may be permitted by the licensing terms governing use of any open source components included with the SOFTWARE.
- **Single EULA:** The end user documentation for the DEVICES and related systems and services may contain multiple EULAs, such as multiple translations and/or multiple media versions (e.g., in the user documentation and in the software). Even if you receive multiple EULAs, you are licensed to use only one (1) copy of the SOFTWARE.
- **SOFTWARE Transfer:** You may permanently transfer your rights under this EULA only as part of a sale or transfer of the DEVICES, provided you retain no copies, you transfer all of the SOFTWARE (including all component parts, the media and printed materials, any upgrades, and, if applicable, the Certificate(s) of Authenticity), and the recipient agrees to the terms of this EULA. If the SOFTWARE is an upgrade, any transfer must include all prior versions of the SOFTWARE.
- **Termination:** Without prejudice to any other rights, FORD MOTOR COMPANY may terminate this EULA if you fail to comply with the terms and conditions of this EULA.
- **Internet-Based Services Components:** The SOFTWARE may contain components that enable and facilitate the use of certain Internet-based services. You acknowledge and agree that FORD MOTOR COMPANY, third party software and service suppliers, its affiliates and/or its designated agent may automatically check the version of the SOFTWARE and/or its components that you are utilizing and may provide upgrades or supplements to the SOFTWARE that may be automatically downloaded to your DEVICES.

## Customer Information

---

- **Additional Software/Services:** The SOFTWARE may permit FORD MOTOR COMPANY, third party software and service suppliers, its affiliates and/or its designated agent to provide or make available to you SOFTWARE updates, supplements, add-on components, or Internet-based services components of the SOFTWARE after the date you obtain your initial copy of the SOFTWARE ("Supplemental Components".) SOFTWARE updates may cause you to incur additional charges from your wireless service provider. If FORD MOTOR COMPANY or third party software and services suppliers provide or make available to you Supplemental Components and no other EULA terms are provided along with the Supplemental Components, then the terms of this EULA shall apply. FORD MOTOR COMPANY, its affiliates and/or its designated agent reserve the right to discontinue without liability any Internet-based services provided to you or made available to you through the use of the SOFTWARE.
- **Links to Third Party Sites:** The SOFTWARE may provide you with the ability to link to third party sites. The third party sites are not under the control of FORD MOTOR COMPANY, its affiliates and/or its designated agent. Neither FORD MOTOR COMPANY nor its affiliates nor its designated agent are responsible for (i) the contents of any third party sites, any links contained in third party sites, or any changes or updates to third party sites, or (ii) webcasting or any other form of transmission received from any third party sites. If the SOFTWARE provides links to third party sites, those links are provided to you only as a convenience, and the inclusion of any link does not imply an endorsement of the third party site by FORD MOTOR COMPANY, its affiliates and/or its designated agent.
- **Obligation to Drive Responsibly:** You recognize your obligation to drive responsibly and keep attention on the road. You will read and abide with the DEVICES operating instructions particularly as they pertain to safety and you agree to assume any risk associated with the use of the DEVICES.

### **UPGRADES AND RECOVERY MEDIA:**

If the SOFTWARE is provided by FORD MOTOR COMPANY separate from the DEVICES on media such as a ROM chip, CD ROM disk(s) or via web download or other means, and is labeled "For Upgrade Purposes Only" or "For Recovery Purposes Only" you may install one (1) copy of such SOFTWARE onto the DEVICES as a replacement copy for the existing SOFTWARE, and use it in accordance with this EULA, including any additional EULA terms accompanying the upgrade SOFTWARE.

# Customer Information

---

## **INTELLECTUAL PROPERTY RIGHTS:**

All title and intellectual property rights in and to the SOFTWARE (including but not limited to any images, photographs, animations, video, audio, music, text and "applets" incorporated into the SOFTWARE), the accompanying printed materials, and any copies of the SOFTWARE, are owned by FORD MOTOR COMPANY, or its affiliates or suppliers. The SOFTWARE is licensed, not sold. You may not copy the printed materials accompanying the SOFTWARE. All title and intellectual property rights in and to the content which may be accessed through use of the SOFTWARE is the property of the respective content owner and may be protected by applicable copyright or other intellectual property laws and treaties. This EULA grants you no rights to use such content outside its intended use. All rights not specifically granted under this EULA are reserved by FORD MOTOR COMPANY, its affiliates, and third party software and service providers and suppliers. Use of any on-line services which may be accessed through the SOFTWARE may be governed by the respective terms of use relating to such services. If this SOFTWARE contains documentation that is provided only in electronic form, you may print one copy of such electronic documentation.

## **EXPORT RESTRICTIONS:**

You acknowledge that the SOFTWARE is subject to U.S. and European Union export jurisdiction. You agree to comply with all applicable international and national laws that apply to the SOFTWARE, including the U.S. Export Administration Regulations, as well as end-user, end-use and destination restrictions issued by U.S. and other governments.

**TRADEMARKS:** This EULA does not grant you any rights in connection with any trademarks or service marks of FORD MOTOR COMPANY, its affiliates, and third party software and service providers.

**PRODUCT SUPPORT:** Please refer to FORD MOTOR COMPANY instructions provided in the documentation for the DEVICES product support, such as the vehicle owner guide.

Should you have any questions concerning this EULA, or if you desire to contact FORD MOTOR COMPANY for any other reason, please refer to the address provided in the documentation for the DEVICES.

## **No Liability for Certain Damages:**

EXCEPT AS PROHIBITED BY LAW, FORD MOTOR COMPANY, ANY THIRD PARTY SOFTWARE OR SERVICES SUPPLIERS, AND THEIR AFFILIATES SHALL HAVE NO LIABILITY FOR ANY INDIRECT, SPECIAL, CONSEQUENTIAL OR INCIDENTAL DAMAGES ARISING FROM OR IN CONNECTION WITH THE USE OR PERFORMANCE OF THE SOFTWARE. THIS LIMITATION SHALL APPLY EVEN IF ANY REMEDY FAILS OF ITS ESSENTIAL PURPOSE. THERE ARE NO WARRANTIES OTHER THAN THOSE THAT MAY BE EXPRESSLY PROVIDED FOR YOUR NEW VEHICLE.

## **SYNC® Automotive Important Safety Information Read and follow instructions:**

- Before using your SYNC® system, read and follow all instructions and safety information provided in this end user manual ("Owner Guide".) Not following precautions found in the Owner Guide can lead to an accident or other serious injuries.

# Customer Information

---

## General Operation

- **Voice Command Control:** Certain functions within the SYNC® system may be accomplished using voice commands. Using voice commands while driving helps you to operate the system without removing your hands from the wheel or eyes from the road.
- **Prolonged Views of Screen:** Do not access any function requiring a prolonged view of the screen while you are driving. Pull over in a safe and legal manner before attempting to access a function of the system requiring prolonged attention.
- **Volume Setting:** Do not raise the volume excessively. Keep the volume at a level where you can still hear outside traffic and emergency signals while driving. Driving while unable to hear these sounds could cause an accident.
- **Navigation Features:** Any navigation features included in the system are intended to provide turn by turn instructions to get you to a desired destination. Please make certain all persons using this system carefully read and follow instructions and safety information fully.
- **Distraction Hazard:** Any navigation features may require manual (non-verbal) setup. Attempting to perform such set-up or insert data while driving can distract your attention and could cause an accident or other serious injury. Stop the vehicle in a safe and legal manner before attempting these operations.
- **Let Your Judgment Prevail:** Any navigation features are provided only as an aid. Make your driving decisions based on your observations of local conditions and existing traffic regulations. Any such feature is not a substitute for your personal judgment. Any route suggestions made by this system should never replace any local traffic regulations or your personal judgment or knowledge of safe driving practices.
- **Route Safety:** Do not follow the route suggestions if doing so would result in an unsafe or illegal maneuver, if you would be placed in an unsafe situation, or if you would be directed into an area that you consider unsafe. The driver is ultimately responsible for the safe operation of the vehicle and therefore, must evaluate whether it is safe to follow the suggested directions.
- **Potential Map Inaccuracy:** Maps used by this system may be inaccurate because of changes in roads, traffic controls or driving conditions. Always use good judgment and common sense when following the suggested routes.
- **Emergency Services:** Do not rely on any navigation features included in the system to route you to emergency services. Ask local authorities or an emergency services operator for these locations. Not all emergency services such as police, fire stations, hospitals and clinics are likely to be contained in the map database for such navigation features.

# Customer Information

---

## Your Responsibilities and Assumptions of Risk

- You agree to each of the following: (a) Any use of the SOFTWARE while driving an automobile or other vehicle in violation of applicable law or otherwise driving in an unsafe manner presents a significant risk of distracted driving and should not be attempted under any circumstances; (b) Use of the SOFTWARE at excessive volume poses a significant risk of hearing damage and should not be attempted under any circumstances; (c) The SOFTWARE may not be compatible with new or different versions of an operating system, third party software, or third party services, and the SOFTWARE may potentially cause a critical failure of an operating system, third party software, or third party service. (d) Any third party service accessed by or third party software used with the SOFTWARE (I) may charge an additional fee for access, (ii) may not work correctly, on an uninterrupted basis, or error free, (iii) may change streaming formats or discontinue operation, (iv) may contain adult, profane or offensive content; and (v) may contain inaccurate, false or misleading traffic, weather, financial or safety information or other content; and (e) Use of the SOFTWARE may cause you to incur additional charges from your wireless service provider (WSP) and any data or minute calculators that may be included in the software program are for reference only, are not warranted in any way and should not be relied upon in anyway.
- When using the SOFTWARE, you agree to be responsible for and assume the entire risk to the items set forth in Section (a) – (e) above.

## Disclaimer of Warranty

YOU EXPRESSLY ACKNOWLEDGE AND AGREE THAT USE OF THE DEVICES AND SOFTWARE IS AT YOUR SOLE RISK AND THAT THE ENTIRE RISK AS TO SATISFACTORY QUALITY, PERFORMANCE, COMPATIBILITY, ACCURACY AND EFFORT IS WITH YOU. TO THE MAXIMUM EXTENT PERMITTED BY APPLICABLE LAW, THE SOFTWARE AND ANY THIRD PARTY SOFTWARE OR THIRD-PARTY SERVICES ARE PROVIDED "AS IS" AND "AS AVAILABLE", WITH ALL FAULTS AND WITHOUT WARRANTY OF ANY KIND, AND FORD MOTOR COMPANY HEREBY DISCLAIMS ALL WARRANTIES AND CONDITIONS WITH RESPECT TO THE SOFTWARE, THIRD PARTY SOFTWARE, AND THIRD-PARTY SERVICES, EITHER EXPRESS, IMPLIED OR STATUTORY, INCLUDING, BUT NOT LIMITED TO, THE IMPLIED WARRANTIES AND/OR CONDITIONS OF MERCHANTABILITY, OF SATISFACTORY QUALITY, OF FITNESS FOR AN PARTICULAR PURPOSE, OF ACCURACY, OF QUIET ENJOYMENT, AND NON-INFRINGEMENT OF THIRD-PARTY RIGHTS. FORD MOTOR COMPANY DOES NOT WARRANT (a) AGAINST INTERFERENCE WITH YOUR ENJOYMENT OF THE SOFTWARE, THIRD PARTY SOFTWARE, OR THIRD-PARTY SERVICES, (b) THAT THE SOFTWARE, THIRD PARTY SOFTWARE, OR THIRD-PARTY SERVICES WILL MEET YOUR REQUIREMENTS, (c) THAT THE OPERATION OF THE SOFTWARE, THIRD PARTY SOFTWARE, OR THIRD-PARTY SERVICES WILL BE UNINTERRUPTED OR ERROR-FREE, (d) OR THAT DEFECTS IN THE SOFTWARE, THIRD PARTY SOFTWARE, OR THIRD-PARTY SERVICES WILL BE CORRECTED. NO ORAL OR WRITTEN INFORMATION OR ADVICE GIVEN BY FORD MOTOR COMPANY OR ITS AUTHORIZED REPRESENTATIVE SHALL

# Customer Information

---

CREATE A WARRANTY. SHOULD THE SOFTWARE, THIRD PARTY SOFTWARE, OR THIRD-PARTY SERVICES PROVE DEFECTIVE, YOU ASSUME THE ENTIRE COST OF ALL NECESSARY SERVICING, REPAIR OR CORRECTION. SOME JURISDICTIONS DO NOT ALLOW THE DISCLAIMER OF IMPLIED WARRANTIES OR LIMITATIONS ON APPLICABLE STATUTORY RIGHTS OF A CONSUMER, SO THE ABOVE DISCLAIMER MAY NOT FULLY APPLY TO YOU. THE SOLE WARRANTY PROVIDED BY FORD MOTOR COMPANY SHALL BE FOUND IN THE WARRANTY INFORMATION INCLUDING WITH YOUR OWNER GUIDE. TO THE EXTENT THAT THERE IS ANY CONFLICT BETWEEN THE TERMS OF THIS SECTION AND THE WARRANTY BOOKLET, THE WARRANTY BOOKLET SHALL CONTROL.

## Applicable Law, Venue, Jurisdiction

- The laws of the State of Michigan govern this EULA and Your use of the SOFTWARE. Your use of the SOFTWARE may also be subject to other local, state, national, or international laws. Any litigation arising out of or related to this EULA shall be brought and maintained exclusively in a court of the State of Michigan located in Wayne County or in the United States District Court for the Eastern District of Michigan. You hereby consent to submit to the personal jurisdiction of a court in the State of Michigan located in Wayne County and the United States District Court for the Eastern District of Michigan for any dispute arising out of or relating to this EULA.

## Binding Arbitration and Class Action Waiver

**(a) Application.** This Section applies to any dispute EXCEPT IT DOES NOT INCLUDE A DISPUTE RELATING TO COPYRIGHT INFRINGEMENT, OR TO THE ENFORCEMENT OR VALIDITY OF YOUR, FORD MOTOR COMPANY, OR ANY OF FORD MOTOR COMPANY'S LICENSORS' INTELLECTUAL PROPERTY RIGHTS.

Dispute means any dispute, action, or other controversy between You and FORD MOTOR COMPANY, other than the exceptions listed above, concerning the SOFTWARE (including its price) or this EULA, whether in contract, warranty, tort, statute, regulation, ordinance, or any other legal or equitable basis.

**(b) Notice of Dispute.** In the event of a Dispute, You or FORD MOTOR COMPANY must give the other a "Notice of Dispute", which is a written statement of the name, address, and contact information of the party giving it, the facts giving rise to the dispute, and the relief requested. You and FORD MOTOR COMPANY will attempt to resolve any dispute through informal negotiation within 60 days from the date the Notice of Dispute is sent. After 60 days, You or FORD MOTOR COMPANY may commence arbitration.

**(c) Small claims court.** You may also litigate any dispute in small claims court in your county of residence or FORD MOTOR COMPANY'S principal place of business, if the dispute meets all requirements to be heard in the small claims court. You may litigate in small claims court whether or not You negotiated informally first.

**(d) Binding arbitration.** If You and FORD MOTOR COMPANY, do not resolve any dispute by informal negotiation or in small claims court, any other effort to resolve the dispute will be conducted exclusively by binding arbitration. You are giving up

## Customer Information

---

the right to litigate (or participate in as a party or class member) all disputes in court before a judge or jury. Instead, all disputes will be resolved before a neutral arbitrator, whose decision will be final except for a limited right of appeal under the Federal Arbitration Act. Any court with jurisdiction over the parties may enforce the arbitrator's award.

**(e) Class action waiver.** Any proceedings to resolve or litigate any dispute in any forum will be conducted solely on an individual basis. Neither you nor FORD MOTOR COMPANY, will seek to have any dispute heard as a class action, as a private attorney general action, or in any other proceeding in which any party acts or proposes to act in a representative capacity. No arbitration or proceeding will be combined with another without the prior written consent of all parties to all affected arbitrations or proceedings.

**(f) Arbitration procedure.** Any arbitration will be conducted by the American Arbitration Association (the "AAA"), under its Commercial Arbitration Rules. If You are an individual and use the SOFTWARE for personal or vehicle use, or if the value of the dispute is \$75,000 or less whether or not You are an individual or how You use the SOFTWARE, the AAA Supplementary Procedures for Consumer-Related Disputes will also apply. To commence arbitration, submit a Commercial Arbitration Rules Demand for Arbitration form to the AAA. You may request a telephonic or in-person hearing by following the AAA rules. In a dispute involving \$10,000 or less, any hearing will be telephonic unless the arbitrator finds good cause to hold an in-person hearing instead. For more information, see [adr.org](http://adr.org) or call 1-800-778-7879. You agree to commence arbitration only in your county of residence or FORD MOTOR COMPANY'S principal place of business. The arbitrator

may award the same damages to You individually as a court could. The arbitrator may award declaratory or injunctive relief only to You individually, and only to the extent required to satisfy Your individual claim.

### **(g) Arbitration fees and incentives.**

- I. Disputes involving \$75,000 or less. FORD MOTOR COMPANY will promptly reimburse your filing fees and pay the AAA's and arbitrator's fees and expenses. If you reject FORD MOTOR COMPANY'S last written settlement offer made before the arbitrator was appointed ("last written offer"), your dispute goes all the way to an arbitrator's decision (called an "award"), and the arbitrator awards you more than the last written offer, FORD MOTOR COMPANY will give you three incentives: (1) pay the greater of the award or \$1,000; (2) pay twice your reasonable attorney's fees, if any; and (3) reimburse any expenses (including expert witness fees and costs) that your attorney reasonably accrues for investigating, preparing, and pursuing your claim in arbitration. The arbitrator will determine the amounts.
- ii. Disputes involving more than \$75,000. The AAA rules will govern payment of filing fees and the AAA's and arbitrator's fees and expenses.
- iii. Disputes involving any amount. In any arbitration you commence, FORD MOTOR COMPANY will seek its AAA or arbitrator's fees and expenses, or Your filing fees it reimbursed, only if the arbitrator finds the arbitration frivolous or brought for an improper purpose. In any arbitration FORD MOTOR COMPANY commences, it will pay all

# Customer Information

---

filing, AAA, and arbitrator's fees and expenses. It will not seek its attorney's fees or expenses from you in any arbitration. Fees and expenses are not counted in determining how much a dispute involves.

**(h) Claims or disputes must be filed within one year.** To the extent permitted by law, any claim or dispute under this EULA to which this Section applies must be filed within one year in small claims court (Section c) or in arbitration (Section d). The one-year period begins when the claim or dispute first could be filed. If such a claim or dispute is not filed within one year, it is permanently barred.

**(i) Severability.** If the class action waiver (Section e) is found to be illegal or unenforceable as to all or some parts of a dispute, then that portion of Section e will not apply to those parts. Instead, those parts will be severed and proceed in a court of law, with the remaining parts proceeding in arbitration. If any other provision of that portion Section e is found to be illegal or unenforceable, that provision will be severed with the remainder of Section e remaining in full force and effect.

## **Telenav Software End User License Agreement**

Please read these terms and conditions carefully before you use the TeleNav Software. Your use of the TeleNav Software indicates that you accept these terms and conditions. If you do not accept these terms and conditions, do not break the seal of the package, launch, or otherwise use the TeleNav Software. TeleNav may revise this Agreement and the privacy policy at any time, with or without notice to you. You agree to visit <http://www.telenav.com> from time to time to review the then current version of this Agreement and of the privacy policy.

## **1. Safe and Lawful Use**

You acknowledge that devoting attention to the TeleNav Software may pose a risk of injury or death to you and others in situations that otherwise require your undivided attention, and you therefore agree to comply with the following when using the TeleNav Software:

- (a) observe all traffic laws and otherwise drive safely;
  - (b) use your own personal judgment while driving. If you feel that a route suggested by the TeleNav Software instructs you to perform an unsafe or illegal maneuver, places you in an unsafe situation, or directs you into an area that you consider to be unsafe, do not follow such instructions;
  - (c) do not input destinations, or otherwise manipulate the TeleNav Software, unless your vehicle is stationary and parked;
  - (d) do not use the TeleNav Software for any illegal, unauthorized, unintended, unsafe, hazardous, or unlawful purposes, or in any manner inconsistent with this Agreement;
  - (e) arrange all GPS and wireless devices and cables necessary for use of the TeleNav Software in a secure manner in your vehicle so that they will not interfere with your driving and will not prevent the operation of any safety device (such as an airbag).
- You agree to indemnify and hold TeleNav harmless against all claims resulting from any dangerous or otherwise inappropriate use of the TeleNav Software in any moving vehicle, including as a result of your failure to comply with the directions above.



# Customer Information

---

## 2. Account Information

You agree: (a) when registering the TeleNav Software, to provide TeleNav with true, accurate, current, and complete information about yourself, and (b) to inform TeleNav promptly of any changes to such information, and to keep it true, accurate, current and complete.

## 3. Software License

- Subject to your compliance with the terms of this Agreement, TeleNav hereby grants to you a personal, non-exclusive, non-transferable license (except as expressly permitted below in connection with your permanent transfer of the TeleNav Software license), without the right to sublicense, to use the TeleNav Software (in object code form only) in order to access and use the TeleNav Software. This license shall terminate upon any termination or expiration of this Agreement. You agree that you will use the TeleNav Software only for your personal business or leisure purposes, and not to provide commercial navigation services to other parties.

### 3.1 License Limitations

- **(a)** reverse engineer, decompile, disassemble, translate, modify, alter or otherwise change the TeleNav Software or any part thereof; **(b)** attempt to derive the source code, audio library or structure of the TeleNav Software without the prior express written consent of TeleNav; **(c)** remove from the TeleNav Software, or alter, any of TeleNav's or its suppliers' trademarks, trade names, logos, patent or copyright notices, or other notices or markings; **(d)**

distribute, sublicense or otherwise transfer the TeleNav Software to others, except as part of your permanent transfer of the TeleNav Software; or **(e)** use the TeleNav Software in any manner that

- i. infringes the intellectual property or proprietary rights, rights of publicity or privacy or other rights of any party,
- ii. violates any law, statute, ordinance or regulation, including but not limited to laws and regulations related to spamming, privacy, consumer and child protection, obscenity or defamation, or
- iii. is harmful, threatening, abusive, harassing, tortuous, defamatory, vulgar, obscene, libelous, or otherwise objectionable; and (f) lease, rent out, or otherwise permit unauthorized access by third parties to the TeleNav Software without advanced written permission of TeleNav.

## 4. Disclaimers

- To the fullest extent permissible pursuant to applicable law, in no event will TeleNav, its licensors and suppliers, or agents or employees of any of the foregoing, be liable for any decision made or action taken by you or anyone else in reliance on the information provided by the TeleNav Software. TeleNav also does not warrant the accuracy of the map or other data used for the TeleNav Software. Such data may not always reflect reality due to, among other things, road closures, construction, weather, new roads and other changing conditions. You are responsible for the entire risk arising out of your use of the TeleNav Software. For example but without limitation, you agree not to rely on the TeleNav Software for critical navigation in areas where the well-being or survival of you or others

# Customer Information

---

is dependent on the accuracy of navigation, as the maps or functionality of the TeleNav Software are not intended to support such high risk applications, especially in more remote geographical areas.

- TELENAV EXPRESSLY DISCLAIMS AND EXCLUDES ALL WARRANTIES IN CONNECTION WITH THE TELENAV SOFTWARE, WHETHER STATUTORY, EXPRESS OR IMPLIED, INCLUDING ALL WARRANTIES WHICH MAY ARISE FROM COURSE OF DEALING, CUSTOM OR TRADE AND INCLUDING, BUT NOT LIMITED TO, THE IMPLIED WARRANTIES OF MERCHANTABILITY, FITNESS FOR A PARTICULAR PURPOSE AND NON-INFRINGEMENT OF THIRD PARTY RIGHTS WITH RESPECT TO THE TELENAV SOFTWARE.
- Certain jurisdictions do not permit the disclaimer of certain warranties, so this limitation may not apply to you.

## 5. Limitation of Liability

- TO THE EXTENT PERMITTED UNDER APPLICABLE LAW, UNDER NO CIRCUMSTANCES SHALL TELENAV OR ITS LICENSORS AND SUPPLIERS BE LIABLE TO YOU OR TO ANY THIRD PARTY FOR ANY INDIRECT, INCIDENTAL, CONSEQUENTIAL, SPECIAL OR EXEMPLARY DAMAGES (INCLUDING IN EACH CASE, BUT NOT LIMITED TO, DAMAGES FOR THE INABILITY TO USE THE EQUIPMENT OR ACCESS DATA, LOSS OF DATA, LOSS OF BUSINESS, LOSS OF PROFITS, BUSINESS INTERRUPTION OR THE LIKE) ARISING OUT OF THE USE OF OR INABILITY TO USE THE TELENAV SOFTWARE, EVEN IF TELENAV HAS BEEN ADVISED OF THE POSSIBILITY OF SUCH DAMAGES. NOTWITHSTANDING ANY DAMAGES THAT YOU MIGHT INCUR FOR ANY

REASON WHATSOEVER (INCLUDING, WITHOUT LIMITATION, ALL DAMAGES REFERENCED HEREIN AND ALL DIRECT OR GENERAL DAMAGES IN CONTRACT, TORT (INCLUDING NEGLIGENCE) OR OTHERWISE), THE ENTIRE LIABILITY OF TELENAV AND OF ALL OF TELENAV'S SUPPLIERS SHALL BE LIMITED TO THE AMOUNT ACTUALLY PAID BY YOU FOR THE TELENAV SOFTWARE. SOME STATES AND/OR JURISDICTIONS DO NOT ALLOW THE EXCLUSION OR LIMITATION OF INCIDENTAL OR CONSEQUENTIAL DAMAGES, SO THE ABOVE LIMITATIONS OR EXCLUSIONS MAY NOT APPLY TO YOU.

## 6. Arbitration and Governing Law

- You agree that any dispute, claim or controversy arising out of or relating to this Agreement or the TeleNav Software shall be settled by independent arbitration involving a neutral arbitrator and administered by the American Arbitration Association in the County of Santa Clara, California. The arbitrator shall apply the Commercial Arbitration Rules of the American Arbitration Association, and the judgment upon the award rendered by the arbitrator may be entered by any court having jurisdiction. Note that there is no judge or jury in an arbitration proceeding and the decision of the arbitrator shall be binding upon both parties. You expressly agree to waive your right to a jury trial. This Agreement and performance hereunder will be governed by and construed in accordance with the laws of the State of California, without giving effect to its conflict of law provisions. To the extent judicial action is necessary in connection with the binding arbitration, both TeleNav and you agree to submit

# Customer Information

---

to the exclusive jurisdiction of the courts of the County of Santa Clara, California. The United Nations Convention on Contracts for the International Sale of Goods shall not apply.

## **7. Assignment**

- You may not resell, assign, or transfer this Agreement or any of your rights or obligations, except in totality, in connection with your permanent transfer of the TeleNav Software, and expressly conditioned upon the new user of the TeleNav Software agreeing to be bound by the terms and conditions of this Agreement. Any such sale, assignment or transfer that is not expressly permitted under this paragraph will result in immediate termination of this Agreement, without liability to TeleNav, in which case you and all other parties shall immediately cease all use of the TeleNav Software. Notwithstanding the foregoing, TeleNav may assign this Agreement to any other party at any time without notice, provided the assignee remains bound by this Agreement.

## **8. Miscellaneous**

### **8.1**

This Agreement constitutes the entire agreement between TeleNav and you with respect to the subject matter hereof.

### **8.2**

Except for the limited licenses expressly granted in this Agreement, TeleNav retains all right, title and interest in and to the TeleNav Software, including without limitation all related intellectual property rights. No licenses or other rights which are not expressly granted in this Agreement are intended to, or shall be, granted or

conferred by implication, statute, inducement, estoppel or otherwise, and TeleNav and its suppliers and licensors hereby reserve all of their respective rights other than the licenses explicitly granted in this Agreement.

### **8.3**

By using the TeleNav Software, you consent to receive from TeleNav all communications, including notices, agreements, legally required disclosures or other information in connection with the TeleNav Software (collectively, "Notices") electronically. TeleNav may provide such Notices by posting them on TeleNav's Website or by downloading such Notices to your wireless device. If you desire to withdraw your consent to receive Notices electronically, you must discontinue your use of the TeleNav Software.

### **8.4**

TeleNav's or your failure to require performance of any provision shall not affect that party's right to require performance at any time thereafter, nor shall a waiver of any breach or default of this Agreement constitute a waiver of any subsequent breach or default or a waiver of the provision itself.

### **8.5**

If any provision herein is held unenforceable, then such provision will be modified to reflect the intention of the parties, and the remaining provisions of this Agreement will remain in full force and effect.

# Customer Information

---

## 8.6

The headings in this Agreement are for convenience of reference only, will not be deemed to be a part of this Agreement, and will not be referred to in connection with the construction or interpretation of this Agreement. As used in this Agreement, the words "include" and "including" and variations thereof, will not be deemed to be terms of limitation, but rather will be deemed to be followed by the words "without limitation".

## 9. Other Vendors Terms and Conditions

- The Telenav Software utilizes map and other data licensed to Telenav by third party vendors for the benefit of you and other end users. This Agreement includes end-user terms applicable to these companies (included at the end of this Agreement), and thus your use of the Telenav Software is also subject to such terms. You agree to comply with the following additional terms and conditions, which are applicable to Telenav's third party vendor licensors.

### 9.1 End User Terms Required by HERE North America, LLC

The data ("Data") is provided for your personal, internal use only and not for resale. It is protected by copyright, and is subject to the following terms and conditions which are agreed to by you, on the one hand, and Telenav ("Telenav") and its licensors (including their licensors and suppliers) on the other hand.

© 2013 HERE. All rights reserved.

The Data for areas of Canada includes information taken with permission from Canadian authorities, including: © Her Majesty the Queen in Right of Canada, © Queen's Printer for Ontario, © Canada Post Corporation, GeoBase®, © Department of Natural Resources Canada.

HERE holds a non-exclusive license from the United States Postal Service® to publish and sell ZIP+4® information.

©United States Postal Service® 2014. Prices are not established, controlled or approved by the United States Postal Service®. The following trademarks and registrations are owned by the USPS: United States Postal Service, USPS, and ZIP+4

The Data for Mexico includes certain data from Instituto Nacional de Estadística y Geografía.

### 9.2 End User Terms Required by NAV2 (Shanghai) Co., Ltd

The data ("Data") is provided for your personal, internal use only and not for resale. It is protected by copyright, and is subject to the following terms and conditions which are agreed to by you, on the one hand, and NAV2 (Shanghai) Co., Ltd ("NAV2") and its licensors (including their licensors and suppliers) on the other hand. 20xx. All rights reserved

### Terms and Conditions

**Permitted Use.** You agree to use this Data together with the Telenav Software solely for the internal business and personal purposes for which you were licensed, and not for service bureau, time-sharing or other similar purposes. Accordingly, but subject to the restrictions set forth in the following paragraphs, you agree not to otherwise reproduce, copy, modify, decompile, disassemble, create any derivative works of, or reverse engineer any portion of this Data, and may not transfer or distribute it in any form, for any purpose, except to the extent permitted by mandatory laws.

## Customer Information

---

**Restrictions.** Except where you have been specifically licensed to do so by Telenav, and without limiting the preceding paragraph, you may not use this Data (a) with any products, systems, or applications installed or otherwise connected to or in communication with vehicles, capable of vehicle navigation, positioning, dispatch, real time route guidance, fleet management or similar applications; or (b) with or in communication with any positioning devices or any mobile or wireless-connected electronic or computer devices, including without limitation cellular phones, palmtop and handheld computers, pagers, and personal digital assistants or PDAs.

**Warning.** The Data may contain inaccurate or incomplete information due to the passage of time, changing circumstances, sources used and the nature of collecting comprehensive geographic data, any of which may lead to incorrect results.

**No Warranty.** This Data is provided to you “as is,” and you agree to use it at your own risk. Telenav and its licensors (and their licensors and suppliers) make no guarantees, representations or warranties of any kind, express or implied, arising by law or otherwise, including but not limited to, content, quality, accuracy, completeness, effectiveness, reliability, fitness for a particular purpose, usefulness, use or results to be obtained from this Data, or that the Data or server will be uninterrupted or error-free.

**Disclaimer of Warranty:** TELENAV AND ITS LICENSORS (INCLUDING THEIR LICENSORS AND SUPPLIERS) DISCLAIM ANY WARRANTIES, EXPRESS OR IMPLIED, OF QUALITY, PERFORMANCE, MERCHANTABILITY, FITNESS FOR A

PARTICULAR PURPOSE OR NON-INFRINGEMENT. Some States, Territories and Countries do not allow certain warranty exclusions, so to that extent the above exclusion may not apply to you.

**Disclaimer of Liability:** TELENAV AND ITS LICENSORS (INCLUDING THEIR LICENSORS AND SUPPLIERS) SHALL NOT BE LIABLE TO YOU: IN RESPECT OF ANY CLAIM, DEMAND OR ACTION, IRRESPECTIVE OF THE NATURE OF THE CAUSE OF THE CLAIM, DEMAND OR ACTION ALLEGING ANY LOSS, INJURY OR DAMAGES, DIRECT OR INDIRECT, WHICH MAY RESULT FROM THE USE OR POSSESSION OF THE INFORMATION; OR FOR ANY LOSS OF PROFIT, REVENUE, CONTRACTS OR SAVINGS, OR ANY OTHER DIRECT, INDIRECT, INCIDENTAL, SPECIAL OR CONSEQUENTIAL DAMAGES ARISING OUT OF YOUR USE OF OR INABILITY TO USE THIS INFORMATION, ANY DEFECT IN THE INFORMATION, OR THE BREACH OF THESE TERMS OR CONDITIONS, WHETHER IN AN ACTION IN CONTRACT OR TORT OR BASED ON A WARRANTY, EVEN IF TELENAV OR ITS LICENSORS HAVE BEEN ADVISED OF THE POSSIBILITY OF SUCH DAMAGES. Some States, Territories and Countries do not allow certain liability exclusions or damages limitations, so to that extent the above may not apply to you.

**Export Control.** You shall not export from anywhere any part of the Data or any direct product thereof except in compliance with, and with all licenses and approvals required under, applicable export laws, rules and regulations, including but not limited to the laws, rules and regulations administered by the Office of Foreign Assets Control of the U.S. Department of Commerce and the Bureau of Industry and Security of the U.S. Department of Commerce. To the extent that any such

# Customer Information

export laws, rules or regulations prohibit HERE from complying with any of its obligations hereunder to deliver or distribute Data, such failure shall be excused and shall not constitute a breach of this Agreement.

**Entire Agreement.** These terms and conditions constitute the entire agreement between Telenav (and its licensors, including their licensors and suppliers) and you pertaining to the subject matter hereof, and supersedes in their entirety any and all written or oral agreements previously existing between us with respect to such subject matter.

**Governing Law.** The above terms and conditions shall be governed by the laws of the State of Illinois [insert "Netherlands" where European HERE Data is used], without giving effect to (i) its conflict of laws provisions, or (ii) the United Nations Convention for Contracts for the International Sale of Goods, which is explicitly excluded. You agree to submit to the jurisdiction of the State of Illinois [insert "The Netherlands" where European HERE Data is used] for any and all disputes, claims and actions arising from or in connection with the Data provided to you hereunder.

**Government End Users.** If the Data is being acquired by or on behalf of the United States government or any other entity seeking or applying rights similar to those customarily claimed by the United States government, this Data is a "commercial item" as that term is defined at 48 C.F.R. ("FAR") 2.101, is licensed in accordance with these End-User Terms, and each copy of Data delivered or otherwise furnished shall be marked and embedded as appropriate with the following "Notice of Use," and shall be treated in accordance with such Notice:

NOTICE OF USE
CONTRACTOR (MANUFACTURER/SUPPLIER) NAME: HERE
CONTRACTOR (MANUFACTURER/SUPPLIER) ADDRESS: c/o Nokia, 425 West Randolph Street, Chicago, Illinois 60606
This Data is a commercial item as defined in FAR 2.101 and is subject to these End-User Terms under which this Data was provided.
© 1987 – 2014 HERE – All rights reserved.

If the Contracting Officer, federal government agency, or any federal official refuses to use the legend provided herein, the Contracting Officer, federal government agency, or any federal official must notify HERE prior to seeking additional or alternative rights in the Data.

## I. US/Canada Territory

A. United States Data. The End-User Terms for any Application containing Data for the United States shall contain the following notices:

"HERE holds a non-exclusive license from the United States Postal Service® to publish and sell ZIP+4® information."

"©United States Postal Service® 20XX. Prices are not established, controlled or approved by the United States Postal Service®. The following trademarks and registrations are owned by the USPS: United States Postal Service, USPS, and ZIP+4."

## Customer Information

---

B. Canada Data. The following provisions apply to the Data for Canada, which may include or reflect data from third party licensors (“Third Party Data”), including Her Majesty the Queen in Right of Canada (“Her Majesty”), Canada Post Corporation (“Canada Post”) and the Department of Natural Resources of Canada (“NRCan”):

1. Disclaimer and Limitation: Client agrees that its use of the Third Party Data is subject to the following provisions:

a. Disclaimer: The Third Party Data is licensed on an “as is” basis. The licensors of such data, including Her Majesty, Canada Post and NRCan, make no guarantees, representations or warranties respecting such data, either express or implied, arising by law or otherwise, including but not limited to, effectiveness, completeness, accuracy or fitness for a particular purpose.

b. Limitation on Liability: The Third Party Data licensors, including Her Majesty, Canada Post and NRCan, shall not be liable: (i) in respect of any claim, demand or action, irrespective of the nature of the cause of the claim, demand or action alleging any loss, injury or damages, direct or indirect, which may result from the use or possession of such Data; or (ii) in any way for loss of revenues or contracts, or any other consequential loss of any kind resulting from any defect in the Data.

2. Copyright Notice: In connection with each copy of all or any portion of the Data for the Territory of Canada, Client shall affix in a conspicuous manner the following copyright notice on at least one of: (i) the label for the storage media of the copy; (ii) the packaging for the copy; or (iii) other materials packaged with the copy, such as user manuals or end user license agreements: “This data includes information taken with permission from Canadian authorities, including © Her Majesty the Queen in Right of Canada, © Queen’s Printer for Ontario, © Canada Post Corporation, GeoBase®, © The Department of Natural Resources Canada. All rights reserved.”

3. End-User Terms: Except as otherwise agreed by the parties, in connection with the provision of any portion of the Data for the Territory of Canada to End-Users as may be authorized under the Agreement, Client shall provide such End-Users, in a reasonably conspicuous manner, with terms (set forth with other end user terms required to be provided under the Agreement, or as otherwise may be provided, by Client) which shall include the following provisions on behalf of the Third Party Data licensors, including Her Majesty, Canada Post and NRCan:

The Data may include or reflect data of licensors, including Her Majesty the Queen in the Right of Canada (“Her Majesty”), Canada Post Corporation (“Canada Post”) and the Department of Natural Resources Canada (“NRCan”). Such data is licensed on an “as is” basis. The licensors, including Her Majesty, Canada Post and NRCan, make no guarantees, representations or warranties respecting such data,

# Customer Information

---

either express or implied, arising by law or otherwise, including but not limited to, effectiveness, completeness, accuracy or fitness for a particular purpose. The licensors, including Her Majesty, Canada Post and NRCan, shall not be liable in respect of any claim, demand or action, irrespective of the nature of the cause of the claim, demand or action alleging any loss, injury or damages, direct or indirect, which may result from the use or possession of the data or the Data. The licensors, including Her Majesty, Canada Post and NRCan, shall not be liable in any way for loss of revenues or contracts, or any other consequential loss of any kind resulting from any defect in the data or the Data.

End User shall indemnify and save harmless the licensors, including Her Majesty, Canada Post and NRCan, and their officers, employees and agents from and against any claim, demand or action, irrespective of the nature of the cause of the claim, demand or action, alleging loss, costs, expenses, damages or injuries (including injuries resulting in death) arising out of the use or possession of the data or the Data.

4. Additional Provisions: The terms contained in this Section are in addition to all of the rights and obligations of the parties under the Agreement. To the extent that any of the provisions of this Section are inconsistent with, or conflict with, any other provisions of the Agreement, the provisions of this Section shall prevail.

II. Mexico. The following provision applies to the Data for Mexico, which includes certain data from the Instituto Nacional de Estadística y Geografía (“INEGI”):

A. Any and all copies of the Data and/or packaging containing Data for Mexico shall contain the following notice: “Fuente: INEGI (Instituto Nacional de Estadística y Geografía)”

III. Latin America Territory

A. Third Party Notices. Any and all copies of the Data and/or packaging relating thereto shall include the respective Third Party Notices set forth below and used as described below corresponding to the Territory (or portion thereof) included in such copy:

Territory	Notice
Argentina	IGN “INSTITUTO GEOGRAFICO NACIONAL ARGENTINO”
Ecuador	“INSTITUTO GEOGRAFICO MILITAR DEL ECUADOR AUTORIZACION N° IGM-2011-01- PCO-01 DEL 25 DE ENERO DE 2011” “source: © IGN 2009 - BD TOPO ®”
Guadeloupe, French Guiana and Martinique Mexico	“Fuente: INEGI (Instituto Nacional de Estadística y Geografía)”

IV. Middle East Territory



# Customer Information

---

A. Third Party Notices. Any and all copies of the Data and/or packaging relating thereto shall include the respective Third Party Notices set forth below and used as described below corresponding to the Territory (or portion thereof) included in such copy:

Country	Notice
Jordan	“© Royal Jordanian Geographic Centre”. The foregoing notice requirement for Jordan Data is a material term of the Agreement. If Client or any of its permitted sublicensees (if any) fail to meet such requirement, HERE shall have the right to terminate Client’s license with respect to the Jordan Data.

B. Jordan Data. Client and its permitted sublicensees (if any) are restricted from licensing and/or otherwise distributing HERE’s database for the country of Jordan (“Jordan Data”) for use in Enterprise Applications to (i) non-Jordanian entities for use of the Jordan Data solely in Jordan or (ii) Jordan-based customers. In addition, Client, its permitted sublicensees (if any) and End-Users are restricted from using the Jordan Data in Enterprise Applications if such party is (i) a non-Jordanian entity using the Jordan Data solely in Jordan or (ii) a Jordan-based customer. For purposes of the foregoing, “Enterprise Applications” shall mean Geomarketing applications, GIS applications, mobile business asset management applications, call center applications, telematics applications, public organization Internet applications or for providing geocoding services.

## V. Europe Territory

### A. Use of Certain Traffic Codes in Europe

1. General Restrictions Applicable to Traffic Codes. Client acknowledges and agrees that in certain countries of the Europe Territory, Client will need to obtain rights directly from third party RDS-TMC code providers to receive and use the Traffic Codes in the Data and to deliver to End-Users Transactions in any way derived from or based on such Traffic Codes. For such countries, HERE shall deliver the Data incorporating Traffic Codes to Client only after receiving certification from Client of its having obtained such rights.

2. Display of Third Party Rights Legends for Belgium. Client shall, for each Transaction that uses Traffic Codes for Belgium, provide the following notice to the End-User: “Traffic Codes for Belgium are provided by the Ministerie van de Vlaamse Gemeenschap and the Ministère de l’Equipeement et des Transports.”

B. Paper Maps. With respect to any license granted to Client relating to making, selling or distributing paper maps (i.e., a map fixed on a paper or paper-like medium): (a) such license with respect to Data for the Territory of Great Britain is conditioned on Client’s entering into and complying with a separate written agreement with the Ordnance Survey (“OS”) to create and sell paper maps, Client’s paying to the OS any and all applicable paper map royalties, and Client’s complying with the OS copyright notice requirements; (b) such license for selling or otherwise distributing for charge with respect to Data for the Territory of Czech Republic

## Customer Information

is conditioned on Client's obtaining prior written consent from Kartografie a.s.; (c) such license for selling or distributing with respect to Data for the Territory of Switzerland is conditioned on Client's obtaining a permit from Bundesamt für Landestopografie of Switzerland; (d) Client is restricted from using Data for the Territory of France to create paper maps with a scale between 1:5,000 and 1:250,000; and (e) Client is restricted from using any Data to create, sell or distribute paper maps that are the same or substantially similar, in terms of data content and specific use of color, symbols and scale, to paper maps published by the European national mapping agencies, including without limitation, Landervermessungämter of Germany, Topografische Dienst of the Netherlands, Nationaal Geografisch Instituut of Belgium, Bundesamt für Landestopografie of Switzerland, Bundesamt für Eich-und Vermessungswesen of Austria, and the National Land Survey of Sweden.

C. OS Enforcement. Without limiting Section IV(B) above, with respect to Data for the Territory of Great Britain, Client acknowledges and agrees that the Ordnance Survey ("OS") may bring a direct action against Client to enforce compliance with the OS copyright notice (see Section IV(D) below) and paper map requirements (see Section IV(B) above) contained in this Agreement.

D. Third Party Notices. Any and all copies of the Data and/or packaging relating thereto shall include the respective Third Party Notices set forth below and used as described below corresponding to the Territory (or portion thereof) included in such copy:

Country(ies) Notice

Austria	"© Bundesamt für Eich- und Vermessungswesen"
Croatia Cyprus, Estonia, Latvia, Lithuania, Moldova, Poland, Slovenia and/or Ukraine	"© EuroGeographics"
France	"source: © IGN 2009 – BD TOPO ®"
Germany	"Die Grundlagendaten wurden mit Genehmigung der zuständigen Behörden entnommen"
Great Britain	"Contains Ordnance Survey data © Crown copyright and database right 2010 Contains Royal Mail data © Royal Mail copyright and database right 2010"
Greece	"Copyright Geomatics Ltd."
Hungary	"Copyright © 2003; Top-Map Ltd."
Italy	"La Banca Dati Italiana è stata prodotta usando quale riferimento anche cartografia numerica ed al tratto prodotta e fornita dalla Regione Toscana."
Norway	"Copyright © 2000; Norwegian Mapping Authority"
Portugal	"Source: IgeoE – Portugal"

# Customer Information

Spain	“Información geográfica propiedad del CNIG”
Sweden	“Based upon electronic data © National Land Survey Sweden.”
Switzerland	“Topografische Grundlage: © Bundesamt für Landestopographie.”

E. Respective Country Distribution. Client acknowledges that HERE has not received approvals to distribute map data for the following countries in such respective countries: Albania, Belarus, Kyrgyzstan, Moldova and Uzbekistan. HERE may update such list from time to time. The license rights granted to Client under this TL with respect to the Data for such countries are contingent upon Client's compliance with all applicable laws and regulations, including, without limitation, any required licenses or approvals to distribute the Application incorporating such Data in such respective countries.

## VI. Australia Territory

A. Third Party Notices. Any and all copies of the Data and/or packaging relating thereto shall include the respective Third Party Notices set forth below and used as described below corresponding to the Territory (or portion thereof) included in such copy:

Copyright. Based on data provided under license from PSMA Australia Limited ([www.pasma.com.au](http://www.pasma.com.au)).

Product incorporates data which is © 20XX Telstra Corporation Limited, GM Holden Limited, Intelomatics Australia Pty Ltd and Continental Pty Ltd.

B. Third Party Notices for Australia. In addition to the foregoing, the End-User Terms for any Application containing RDS-TMC Traffic Codes for Australia shall contain the following notice: “Product incorporates traffic location codes which is © 20XX Telstra Corporation Limited and its licensors.”

## AT&T Vehicle Network Carrier Telematics Disclosure

END USER FOR PURPOSES OF THIS SECTION MEANS YOU AND YOUR HEIRS, EXECUTORS, LEGAL PERSONAL REPRESENTATIVES AND PERMITTED ASSIGNS. FOR PURPOSES OF THIS SECTION “UNDERLYING WIRELESS SERVICE CARRIER” INCLUDES ITS AFFILIATES AND CONTRACTORS AND THEIR RESPECTIVE OFFICERS, DIRECTORS, EMPLOYEES, SUCCESSORS AND ASSIGNS. END USER HAS NO CONTRACTUAL RELATIONSHIP WITH THE UNDERLYING WIRELESS SERVICE CARRIER AND END USER IS NOT A THIRD PARTY BENEFICIARY OF ANY AGREEMENT BETWEEN FORD AND UNDERLYING CARRIER. END USER UNDERSTANDS AND AGREES THAT THE UNDERLYING CARRIER HAS NO LEGAL, EQUITABLE, OR OTHER LIABILITY OF ANY KIND TO END USER. IN ANY EVENT, REGARDLESS OF THE FORM OF THE ACTION, WHETHER FOR BREACH OF CONTRACT, WARRANTY, NEGLIGENCE, STRICT LIABILITY IN TORT OR OTHERWISE, END USER'S EXCLUSIVE REMEDY FOR CLAIMS ARISING IN ANY WAY IN CONNECTION WITH THIS AGREEMENT, FOR ANY CAUSE WHATSOEVER, INCLUDING BUT NOT LIMITED TO ANY FAILURE OR

## Customer Information

---

DISRUPTION OF SERVICE PROVIDED HEREUNDER, IS LIMITED TO PAYMENT OF DAMAGES IN AN AMOUNT NOT TO EXCEED THE AMOUNT PAID BY END USER FOR THE SERVICES DURING THE TWO-MONTH PERIOD PRECEDING THE DATE THE CLAIM AROSE.

(ii) END USER AGREES TO INDEMNIFY AND HOLD HARMLESS THE UNDERLYING WIRELESS SERVICE CARRIER AND ITS OFFICERS, EMPLOYEES, AND AGENTS AGAINST ANY AND ALL CLAIMS, INCLUDING WITHOUT LIMITATION CLAIMS FOR LIBEL, SLANDER, OR ANY PROPERTY DAMAGE, PERSONAL INJURY OR DEATH, ARISING IN ANY WAY, DIRECTLY OR INDIRECTLY, IN CONNECTION WITH THIS AGREEMENT OR THE USE, FAILURE TO USE, OR INABILITY TO USE THE DEVICE EXCEPT WHERE THE CLAIMS RESULT FROM THE UNDERLYING CARRIER'S GROSS NEGLIGENCE OR WILLFUL MISCONDUCT. THIS INDEMNITY WILL SURVIVE THE TERMINATION OF THE AGREEMENT.

(iii) END USER HAS NO PROPERTY RIGHT IN ANY NUMBER ASSIGNED TO THE DEVICE.

(iv) END USER UNDERSTANDS THAT FORD AND THE UNDERLYING CARRIER CANNOT GUARANTY THE SECURITY OF WIRELESS TRANSMISSIONS, AND WILL NOT BE LIABLE FOR ANY LACK OF SECURITY RELATING TO THE USE OF THE SERVICES

THE SERVICE IS FOR [END USER'S] USE ONLY AND END USER MAY NOT RESELL THE SERVICE TO ANY OTHER PARTY END USER UNDERSTANDS THAT THE UNDERLYING CARRIER DOES NOT GUARANTEE ANY END USER UNINTERRUPTED SERVICE OR COVERAGE. THE UNDERLYING CARRIER DOES NOT WARRANT THAT END USERS CAN OR WILL BE LOCATED USING THE SERVICE. THE UNDERLYING CARRIER

MAKES NO WARRANTY, EXPRESS OR IMPLIED, OF MERCHANTABILITY OR FITNESS FOR A PARTICULAR PURPOSE, SUITABILITY, OR PERFORMANCE REGARDING ANY SERVICES OR GOODS, AND IN NO EVENT SHALL AT&T BE LIABLE, WHETHER OR NOT DUE TO ITS OWN NEGLIGENCE, FOR ANY: (A) ACT OR OMISSION OF A THIRD PARTY; (B) MISTAKES, OMISSIONS, INTERRUPTIONS, ERRORS, FAILURES TO TRANSMIT, DELAYS, OR DEFECTS IN THE SERVICE PROVIDED BY OR THROUGH THE UNDERLYING CARRIER; (C) DAMAGE OR INJURY CAUSED BY SUSPENSION OR TERMINATION BY THE UNDERLYING CARRIER; OR (D) DAMAGE OR INJURY CAUSED BY A FAILURE OR DELAY IN CONNECTING A CALL TO ANY ENTITY, INCLUDING 911 OR ANY OTHER EMERGENCY SERVICE. TO THE FULL EXTENT ALLOWED BY LAW, THE END USER RELEASES, INDEMNIFIES AND HOLDS THE UNDERLYING CARRIER HARMLESS FROM AND AGAINST ANY AND ALL CLAIMS OF ANY PERSON OR ENTITY FOR DAMAGES OF ANY NATURE ARISING IN ANY WAY FROM OR RELATING TO, DIRECTLY OR INDIRECTLY, SERVICES PROVIDED BY THE UNDERLYING CARRIER OR ANY PERSON'S USE THEREOF, INCLUDING CLAIMS ARISING IN WHOLE OR IN PART FROM THE ALLEGED NEGLIGENCE OF THE UNDERLYING CARRIER.

### **VII. China Territory**

#### ***Personal Use Only***

You agree to use this Data together with [insert name of Client Application] for the solely personal, non-commercial purposes for which you were licensed, and not for service bureau, time-sharing or other similar purposes. Accordingly, but subject to the restrictions set forth in the following paragraphs, you may copy this Data only as necessary for your personal use to (i)

# Customer Information

---

view it, and (ii) save it, provided that you do not remove any copyright notices that appear and do not modify the Data in any way. You agree not to otherwise reproduce, copy, modify, decompile, disassemble or reverse engineer any portion of this Data, and may not transfer or distribute it in any form, for any purpose, except to the extent permitted by mandatory laws.

## **Restrictions**

Except where you have been specifically licensed to do so by NAV2, and without limiting the preceding paragraph, you may not (a) use this Data with any products, systems, or applications installed or otherwise connected to or in communication with vehicles, capable of vehicle navigation, positioning, dispatch, real time route guidance, fleet management or similar applications; or (b) with or in communication with any positioning devices or any mobile or wireless-connected electronic or computer devices, including without limitation cellular phones, palmtop and handheld computers, pagers, and personal digital assistants or PDAs. You agree to cease using this Data if you fail to comply with these terms and conditions.

## **Limited Warranty**

NAV2 warrants that (a) the Data will perform substantially in accordance with the accompanying written materials for a period of ninety (90) days from the date of receipt, and (b) any support services provided by NAV2 shall be substantially as described in applicable written materials provided to you by NAV2, and NAV2's support engineers will make commercially reasonable efforts to solve any problem issues.

## **Customer Remedies**

NAV2 and its suppliers' entire liability and your exclusive remedy shall be, at NAV2's sole discretion, either (a) return of the price paid, if any, or (b) repair or replacement of the Data that do not meet NAV2's Limited Warranty and that are returned to NAV2 with a copy of your receipt. This Limited Warranty is void if failure of the Data has resulted from accident, abuse, or misapplication. Any replacement Data will be warranted for the remainder of the original warranty period or thirty (30) days, whichever is longer. Neither these remedies nor any product support services offered by NAV2 are available without proof of purchase from an authorized international source.

## **No Other Warranty:**

EXCEPT FOR THE LIMITED WARRANTY SET FORTH ABOVE AND TO THE EXTENT PERMITTED BY APPLICABLE LAW, NAV2 AND ITS LICENSORS (INCLUDING THEIR LICENSORS AND SUPPLIERS) DISCLAIM ANY WARRANTIES, EXPRESS OR IMPLIED, OF QUALITY, PERFORMANCE, MERCHANTABILITY, FITNESS FOR A PARTICULAR PURPOSE, OWNERSHIP OR NON-INFRINGEMENT. Certain warranty exclusions may not be permitted under applicable law, so to that extent the above exclusion may not apply to you.

## **Limited Liability:**

TO THE EXTENT PERMITTED BY APPLICABLE LAW, NAV2 AND ITS LICENSORS (INCLUDING THEIR LICENSORS AND SUPPLIERS) SHALL NOT BE LIABLE TO YOU: IN RESPECT OF ANY CLAIM, DEMAND OR ACTION, IRRESPECTIVE OF THE NATURE OF THE CAUSE OF THE CLAIM, DEMAND OR ACTION ALLEGING ANY LOSS, INJURY OR DAMAGES, DIRECT OR INDIRECT, WHICH MAY RESULT FROM THE USE OR POSSESSION OF THE INFORMATION; OR

# Customer Information

---

FOR ANY LOSS OF PROFIT, REVENUE, CONTRACTS OR SAVINGS, OR ANY OTHER DIRECT, INDIRECT, INCIDENTAL, SPECIAL OR CONSEQUENTIAL DAMAGES ARISING OUT OF YOUR USE OF OR INABILITY TO USE THIS INFORMATION, ANY DEFECT IN THE INFORMATION, OR THE BREACH OF THESE TERMS OR CONDITIONS, WHETHER IN AN ACTION IN CONTRACT OR TORT OR BASED ON A WARRANTY, EVEN IF NAV2 OR ITS LICENSORS HAVE BEEN ADVISED OF THE POSSIBILITY OF SUCH DAMAGES. UNDER NO CIRCUMSTANCES SHALL NAV2'S OR ITS SUPPLIERS' LIABILITY HEREUNDER EXCEED THE PRICE PAID. Certain liability exclusions may not be permitted under applicable law, so to that extent the above exclusion may not apply to you.

## **Export Control**

You agree not to export to anywhere any part of the Data provided to you or any direct product thereof except in compliance with, and with all licenses and approvals required under, applicable export laws, rules and regulations.

## **IP Protection**

The Data are owned by NAV2 or its suppliers and are protected by applicable copyright and other intellectual property law and treaties. The Data are provided solely on the basis of a license to use, not sale.

## **Entire Agreement**

These terms and conditions constitute the entire agreement between NAV2 (and its licensors, including their licensors and suppliers) and you pertaining to the subject matter hereof, and supersedes in their entirety any and all written or oral agreements previously existing between us with respect to such subject matter.

## **Governing Law.**

The above terms and conditions shall be governed by the laws of the People's Republic of China, without giving effect to (i) its conflict of laws provisions, or (ii) the United Nations Convention for Contracts for the International Sale of Goods, which is explicitly excluded. Any dispute arising from or in connection with the Data provided to you hereunder shall be submitted to the Shanghai International Economic and Trade Arbitration Commission for arbitration.

## **Gracenote® Copyright**

CD and music-related data from Gracenote, Inc., copyright©

2000-2007 Gracenote. Gracenote Software, copyright © 2000-2007 Gracenote. This product and service may practice one or more of the following U.S. Patents 5,987,525; 6,061,680; 6,154,773; 6,161,132; 6,230,192; 6,230,207; 6,240,459; 6,330,593 and other patents issued or pending. Some services supplied under license from Open Globe, Inc. for U.S. Patent 6,304,523.

Gracenote and CDDB are registered trademarks of Gracenote. The Gracenote logo and logotype, and the "Powered by Gracenote™" logo are trademarks of Gracenote.

## **Gracenote® End User License Agreement (EULA)**

This device contains software from Gracenote, Inc. of 2000 Powell Street Emeryville, California 94608 ("Gracenote").

The software from Gracenote (the "Gracenote Software") enables this device to do disc and music file identification and obtain music-related information, including name, artist, track, and title information ("Gracenote Data") from online servers

## Customer Information

---

("Gracenote Servers"), and to perform other functions. You may use Gracenote Data only by means of the intended End User functions of this device. This device may contain content belonging to Gracenote's providers. If so, all of the restrictions set forth herein with respect to Gracenote Data shall also apply to such content and such content providers shall be entitled to all of the benefits and protections set forth herein that are available to Gracenote. You agree that you will use the content from Gracenote ("Gracenote Content"), Gracenote Data, the Gracenote Software, and Gracenote Servers for your own personal, non-commercial use only. You agree not to assign, copy, transfer or transmit the Gracenote Content, Gracenote Software or any Gracenote Data (except in a Tag associated with a music file) to any third party. YOU AGREE NOT TO USE OR EXPLOIT GRACENOTE CONTENT, GRACENOTE DATA, THE GRACENOTE SOFTWARE, OR GRACENOTE SERVERS, EXCEPT AS EXPRESSLY PERMITTED HEREIN.

You agree that your non-exclusive licenses to use the Gracenote Content, Gracenote Data, the Gracenote Software, and Gracenote Servers will terminate if you violate these restrictions. If your licenses terminate, you agree to cease any and all use of the Gracenote Content, Gracenote Data, the Gracenote Software, and Gracenote Servers.

Gracenote, respectively, reserve all rights in Gracenote Data, the Gracenote Software, and the Gracenote Servers and Gracenote Content, including all ownership rights. Under no circumstances will either Gracenote become liable for any payment to you for any information that you provide,

including any copyrighted material or music file information. You agree that Gracenote may enforce its respective rights, collectively or separately, under this agreement against you, directly in each company's own name.

Gracenote uses a unique identifier to track queries for statistical purposes. The purpose of a randomly assigned numeric identifier is to allow Gracenote to count queries without knowing anything about who you are. For more information, see the web page at [www.gracenote.com](http://www.gracenote.com) for the Gracenote Privacy Policy.

THE GRACENOTE SOFTWARE, EACH ITEM OF GRACENOTE DATA AND THE GRACENOTE CONTENT ARE LICENSED TO YOU "AS IS". NEITHER GRACENOTE MAKES ANY REPRESENTATIONS OR WARRANTIES, EXPRESS OR IMPLIED, REGARDING THE ACCURACY OF ANY GRACENOTE DATA FROM THE GRACENOTE SERVERS OR GRACENOTE CONTENT. GRACENOTE COLLECTIVELY AND SEPARATELY RESERVE THE RIGHT TO DELETE DATA AND/OR CONTENT FROM THE COMPANIES' RESPECTIVE SERVERS OR, IN THE CASE OF GRACENOTE, CHANGE DATA CATEGORIES FOR ANY CAUSE THAT GRACENOTE DEEMS SUFFICIENT. NO WARRANTY IS MADE THAT EITHER GRACENOTE CONTENT OR THE GRACENOTE SOFTWARE OR GRACENOTE SERVERS ARE ERROR-FREE OR THAT THE FUNCTIONING OF THE GRACENOTE SOFTWARE OR GRACENOTE SERVERS WILL BE UNINTERRUPTED. GRACENOTE IS NOT OBLIGATED TO PROVIDE YOU WITH ANY ENHANCED OR ADDITIONAL DATA TYPES THAT GRACENOTE MAY CHOOSE TO PROVIDE IN THE FUTURE AND IS FREE TO DISCONTINUE ITS ONLINE SERVICES AT ANY TIME. GRACENOTE DISCLAIM ALL WARRANTIES EXPRESS OR IMPLIED, INCLUDING, BUT NOT LIMITED TO,

# Customer Information

IMPLIED WARRANTIES OF MERCHANTABILITY, FITNESS FOR A PARTICULAR PURPOSE, TITLE, AND NON-INFRINGEMENT. NEITHER GRACENOTE WARRANTS THE RESULTS THAT WILL BE OBTAINED BY YOUR USE OF THE GRACENOTE SOFTWARE OR ANY GRACENOTE SERVER. IN NO CASE WILL GRACENOTE BE LIABLE FOR ANY CONSEQUENTIAL OR INCIDENTAL DAMAGES OR FOR ANY LOST PROFITS OR LOST REVENUES FOR ANY REASON WHATSOEVER. © Gracenote 2007.

## Taiwan Territory

Note: In accordance with the management approach of low-power radio wave radiation motors:

Article 12: For approved and certified low-power radiation motor models, companies, firms or users must not alter the frequency, increase the power or change the characteristics and functions of the original design without authorization.

Article 14: The usage of low-power radio-frequency motors must not affect aviation safety and interfere with legal telecommunications. Should interference be detected, immediately stop using the device and only resume usage after ensuring that there is no longer any interference. For the legal telecommunication and wireless telecommunication of the telco, the low-power radio frequency motor must be able to tolerate legal limits of interference from telecommunication, industrial, scientific and radio wave equipment.

## SUNA TRAFFIC CHANNEL – TERMS AND CONDITIONS

By activating, using and/or accessing the SUNA Traffic Channel, SUNA Predictive or other content or material provided by Intellematics (together, **SUNA Products and/or Services**), you must accept certain terms and conditions. The following is a brief summary of the terms and conditions that apply to you. To view the full terms and conditions relevant to your use of the SUNA Products and/or Services, please consult:

Website
<a href="http://www.sunatrafic.com.au/termsandconditions/">www.sunatrafic.com.au/termsandconditions/</a>

### 1. Acceptance

By using SUNA Products and/or Services, you will be deemed to have accepted and agreed to be bound by the terms and conditions fully detailed at:

Website
<a href="http://www.sunatrafic.com.au/termsandconditions/">www.sunatrafic.com.au/termsandconditions/</a>

### 2. Intellectual Property

SUNA Products and/or Services are for your personal use. You may not record, or retransmit the content, nor use the content in association with any other traffic information or route guidance service or device not approved by Intellematics. You obtain no right of ownership in any Intellectual Property Rights (including copyright) in the data that is used to provide SUNA Products and/or Services.

### 3. Appropriate Use



# Customer Information

SUNA Products and/or Services are intended as an aid to personal motoring and travel planning, and do not provide comprehensive or accurate information on all occasions. On occasions, you may experience additional delay as a result of using SUNA Products and/or Services. You acknowledge that it is not intended, or suitable, for use in applications where time of arrival or driving directions may impact the safety of the public or yourself.

## 4. Use of SUNA Products and Services while driving

You, and other authorised drivers of the vehicle in which SUNA Products and/or Services are available or installed and active, remain at all times responsible for observing all relevant laws and codes of safe driving. In particular, you agree to only actively operate SUNA Products and/or Services when the Vehicle is at a complete stop and it is safe to do so.

## 5. Service Continuity and Reception of the SUNA Traffic Channel

We will use reasonable endeavours to provide the SUNA Traffic Channel 24 hours a day, 365 days a year. The SUNA Traffic Channel may occasionally be unavailable for technical reasons or for planned maintenance. We will try to perform maintenance at times when congestion is light. We reserve the right to withdraw SUNA Products and/or Services at any time.

Also, we cannot assure the uninterrupted reception of the SUNA Traffic Channel RDS-TMC signal at any particular location.

## 6. Limitation of Liability

Neither Intelematics (nor its suppliers or the manufacturer of your device (the **"Suppliers"**)) shall be liable to you or to any third party for any damages either direct, indirect, incidental, consequential or otherwise arising out of the use of or inability to use SUNA Products and/or

Services even if Intelematics or a Supplier has been advised of the possibility of such damages. You also acknowledge that the neither Intelematics nor any Supplier guarantees nor make any warranties that relate to the availability, accuracy or completeness of SUNA Products and/or Services, and to the extent which it is lawful to do so, both Intelematics and each Supplier excludes any warranties which might otherwise be implied by any State or Federal legislation in relation to SUNA Products and/or Services.

## 7. Please Note

Great care has been taken in preparing this manual. Constant product development may mean that some information is not entirely up-to-date. The information in this document is subject to change without notice.

## EMISSION LAW



**WARNING:** Do not remove or alter the original equipment floor covering or insulation between it and the metal floor of the vehicle. The floor covering and insulation protect occupants of the vehicle from the engine and exhaust system heat and noise. On vehicles with no original equipment floor covering insulation, do not carry passengers in a manner that permits prolonged skin contact with the metal floor. Failure to follow these instructions may result in fire or personal injury.

U.S. federal laws and certain state laws prohibit removing or rendering inoperative emission control system components. Similar federal or provincial laws may apply in Canada. We do not approve of any vehicle modification without first determining applicable laws.

# Customer Information



Tampering with emissions control systems including related sensors or the Diesel

Exhaust Fluid system can result in reduced engine power and the illumination of the service engine soon light.

## Tampering With a Noise Control System

Federal laws prohibit the following acts:

- Removal or rendering inoperative by any person other than for purposes of maintenance.
- Repair or replacement of any device or element of the design incorporated into a new vehicle for the purpose of noise control prior to its sale or delivery to the ultimate purchaser or while it is in use.
- The use of the vehicle after any person removes or renders inoperative any device or element of the design.

The U.S. Environmental Protection Agency may presume to constitute tampering as follows:

- Removal of hood blanket, fender apron absorbers, fender apron barriers, underbody noise shields or acoustically absorptive material.
- Tampering or rendering inoperative the engine speed governor, to allow engine speed to exceed manufacturer specifications.

If the engine does not start, runs rough, experiences a decrease in engine performance, experiences excess fuel consumption or produces excessive exhaust smoke, check for the following:

- A plugged or disconnected air inlet system hose.
- A plugged engine air filter element.
- Water in the fuel filter and water separator.

- A clogged fuel filter.
- Contaminated fuel.
- Air in the fuel system, due to loose connections.
- An open or pinched sensor hose.
- Incorrect engine oil level.
- Incorrect fuel for climatic conditions.
- Incorrect engine oil viscosity for climactic conditions.

**Note:** *Some vehicles have a lifetime fuel filter that is integrated with the fuel tank. Regular maintenance or replacement is not needed.*

**Note:** *If these checks do not help you correct the concern, have your vehicle checked as soon as possible.*

## Noise Emissions Warranty, Prohibited Tampering Acts and Maintenance

On January 1, 1978, Federal regulation became effective governing the noise emission on trucks over 10,000 lb (4,536 kg) Gross Vehicle Weight Rating (GVWR). The preceding statements concerning prohibited tampering acts and maintenance, and the noise warranty found in the Warranty Guide, are applicable to complete chassis cabs over 10,000 lb (4,536 kg) GVWR.

## EXPORT UNIQUE OPTIONS

For your particular global region, your vehicle may be equipped with features and options that are different from the features and options that are described in this Owner's Manual. A market unique supplement may be supplied that complements this book. By referring to the market unique supplement, if provided, you can properly identify those features, recommendations and specifications that are unique to your vehicle. This Owner's

## Customer Information

---

Manual is written primarily for the U.S. and Canadian markets. Features or equipment listed as standard may be different on units built for export. **Refer to this Owner's Manual for all other required information and warnings.**

# Appendices

## ELECTROMAGNETIC COMPATIBILITY



**WARNING:** Do not place objects or mount equipment on or near the airbag cover, on the side of the front or rear seatbacks, or in areas that may come into contact with a deploying airbag. Failure to follow these instructions may increase the risk of personal injury in the event of a crash.



**WARNING:** Do not fasten antenna cables to vehicle wiring, fuel pipes and brake pipes.



**WARNING:** Keep antenna and power cables at least 4 in (10 cm) from any electronic modules and airbags.

**Note:** We test and certify your vehicle to meet electromagnetic compatibility legislation. It is your responsibility to make sure that any equipment an authorized dealer installs on your vehicle complies with applicable local legislation and other requirements. Installation of some aftermarket electronic devices could degrade the performance of vehicle functions, which use radio frequency signals such as broadcast radio receiver, tire pressure monitoring system, push button start, **Bluetooth®** connectivity or satellite navigation.

**Note:** Any radio frequency transmitter equipment in your vehicle (such as cellular telephones and amateur radio transmitters) must keep to the parameters in the following illustrations and table. We do not provide any other special provisions or conditions for installations or use.

### Car/SUV

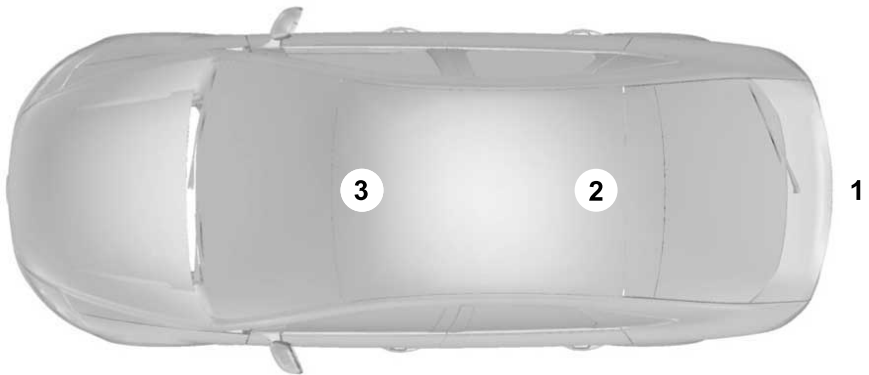

# Appendices

---

## Van



## Truck

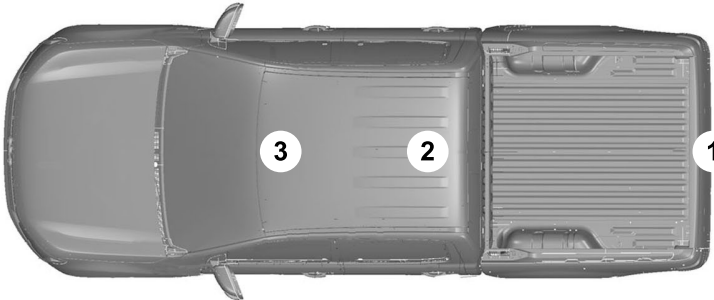

# Appendices

---

<b>Frequency Band MHz</b>	<b>Maximum output power Watt (Peak RMS)</b>	<b>Antenna Positions</b>
1-30	50	1
50-54	50	2, 3
68-88	50	2, 3
142-176	50	2, 3
380-512	50	2, 3
806-870	10	2, 3



# Index

## 3

360 Degree Camera.....	266
360 Degree Camera Settings.....	268
360 Degree Camera Guide Lines.....	267
360 Degree Camera Limitations.....	266
360 Degree Camera Precautions.....	266
360 Degree Camera Settings.....	268
Switching the 360 Degree Camera On and Off.....	268
Switching the 360 Degree Camera View.....	268

## 4

4WD	
See: Four-Wheel Drive.....	228

## 9

911 Assist.....	67
-----------------	----

## A

### A/C

See: Climate Control - Vehicles With: Automatic Temperature Control.....	149
See: Climate Control - Vehicles With: Manual Temperature Control.....	154
About This Publication.....	19

### ABS

See: Brakes.....	240
------------------	-----

Accessing Apps.....	608
---------------------	-----

Accessing Navigation.....	610
---------------------------	-----

Accessing the Passive Key Backup	
----------------------------------	--

Position.....	197
---------------	-----

Accessing the Trip Computer - Vehicles	
--	--

With: 2.3 Inch Screen.....	145
----------------------------	-----

Accessing the Trip Computer - Vehicles	
--	--

With: 4.2 Inch Screen.....	145
----------------------------	-----

Accessing the Trip Computer - Vehicles	
--	--

With: 8 Inch Screen.....	145
--------------------------	-----

Accessories.....	615
------------------	-----

Adaptive Cruise Control.....	272
------------------------------	-----

Adaptive Cruise Control – Troubleshooting.....	279
--	-----

Adaptive Cruise Control Automatic	
-----------------------------------	--

Cancellation.....	275
-------------------	-----

Adaptive Cruise Control Indicators.....	277
---	-----

Adaptive Cruise Control	
-------------------------	--

Limitations.....	273
------------------	-----

Adaptive Cruise Control	
-------------------------	--

Precautions.....	272
------------------	-----

Adaptive Cruise Control –	
---------------------------	--

Troubleshooting.....	279
----------------------	-----

Adaptive Cruise Control – Information	
---------------------------------------	--

Messages.....	279
---------------	-----

Adjustable Pedals.....	114
------------------------	-----

Adjusting the Exterior Mirrors.....	129
-------------------------------------	-----

Adjusting the Headlamps.....	411
------------------------------	-----

Adjusting the Instrument Panel Lighting	
---	--

Brightness.....	125
-----------------	-----

Adjusting the Integrated Trailer Brake	
--	--

Controller Mode.....	335
----------------------	-----

Adjusting the Map.....	610
------------------------	-----

Changing the Format of the Map.....	610
-------------------------------------	-----

Zooming the Map In and Out.....	610
---------------------------------	-----

Adjusting the Pedals.....	114
---------------------------	-----

Adjusting the Seatbelt Height.....	52
------------------------------------	----

Adjusting the Seatbelt Length.....	53
------------------------------------	----

Adjusting the Seatbelts During	
--------------------------------	--

Pregnancy.....	52
----------------	----

Adjusting the Sound Settings.....	526
-----------------------------------	-----

Adjusting the Steering Wheel - Vehicles	
---	--

With: Manual Adjustable Steering	
----------------------------------	--

Column.....	112
-------------	-----

Adjusting the Steering Wheel - Vehicles	
---	--

With: Power Adjustable Steering	
---------------------------------	--

Column.....	111
-------------	-----

Adjusting the Volume.....	525
---------------------------	-----

Airbag Precautions.....	59
-------------------------	----

Airbags.....	57
--------------	----

Air Conditioning	
------------------	--

See: Climate Control - Vehicles With:	
---------------------------------------	--

Automatic Temperature Control.....	149
------------------------------------	-----

See: Climate Control - Vehicles With: Manual	
--	--

Temperature Control.....	154
--------------------------	-----

Air Conditioning System Capacity and	
--------------------------------------	--

Specification - 6.2L.....	483
---------------------------	-----

Air Conditioning System Capacity and	
--------------------------------------	--

Specification - 6.7L Diesel.....	484
----------------------------------	-----

Air Conditioning System Capacity and	
--------------------------------------	--

Specification - 7.3L.....	485
---------------------------	-----

Alert Mode.....	288
-----------------	-----

Adjusting the Steering Wheel Vibration	
--	--

Intensity.....	289
----------------	-----



# Index

How Does Alert Mode Work.....	289	Auto-Dimming Interior Mirror.....	128
What Is Alert Mode.....	288	Auto-Dimming Interior Mirror Limitations.....	128
AM/FM Radio.....	527	What Is the Auto-Dimming Interior Mirror.....	128
AM/FM Radio Limitations.....	527	Autolamps.....	119
Selecting a Radio Station.....	527	Autolamp Settings.....	119
Ambient Lighting.....	125	What Are Autolamps.....	119
Adjusting Ambient Lighting.....	125	Autolock.....	84
Switching Ambient Lighting On and Off.....	125	Autolock Requirements.....	84
Anti-Lock Braking System.....	240	What Is Autolock.....	84
Anti-Lock Braking System Limitations.....	240	Automatic Crash Shutoff.....	381
Anti-Theft Alarm System.....	106	Automatic Crash Shutoff Precautions.....	382
Arming the Anti-Theft Alarm System.....	107	Re-Enabling Your Vehicle.....	382
Disarming the Anti-Theft Alarm System.....	107	What Is Automatic Crash Shutoff.....	381
How Does the Anti-Theft Alarm System Work.....	106	Automatic Emergency Braking.....	306
What Are the Inclination Sensors.....	106	Switching Automatic Emergency Braking On and Off.....	306
What Are the Interior Sensors.....	106	What Is Automatic Emergency Braking.....	306
What Is the Anti-Theft Alarm System.....	106	Automatic Engine Stop.....	196
What Is the Battery Backup Alarm.....	106	How Does Automatic Engine Stop Work.....	197
What Is the Perimeter Alarm.....	106	Overriding Automatic Engine Stop.....	197
Anti-Theft Alarm System Settings.....	107	Switching Automatic Engine Stop On and Off.....	197
Setting the Alarm Security Level.....	107	What Is Automatic Engine Stop.....	196
Switching Ask on Exit On and Off.....	107	Automatic High Beam Control.....	121
What Are the Alarm Security Levels.....	107	Automatic High Beam Control Indicators.....	123
What Is Ask on Exit.....	107	Automatic High Beam Control Limitations.....	122
Appendices.....	713	Automatic High Beam Control Precautions.....	122
Applying the Parking Brake.....	243	Automatic High Beam Control Requirements.....	122
App Precautions.....	608	How Does Automatic High Beam Control Work.....	121
App Requirements.....	608	Overriding Automatic High Beam Control.....	123
Apps.....	580	Switching Automatic High Beam Control On and Off.....	123
Audio System.....	508	Automatic High Beam Control – Troubleshooting.....	123
AM/FM Radio.....	527	Automatic High Beam Control – Information Messages.....	123
Audio System – Troubleshooting.....	532		
Digital Radio.....	528		
General Information.....	508		
Satellite Radio.....	529		
Audio System Precautions.....	525		
Audio System – Troubleshooting.....	532		
Audio System – Information Messages.....	532		
Audio Unit.....	508		
Auto-Dimming Exterior Mirror.....	130		
What Is the Auto-Dimming Exterior Mirror.....	130		

# Index

Automatic Locking Mode.....	51	Blind Spot Information System With Trailer Coverage.....	295
Disengaging Automatic Locking Mode.....	52	Blind Spot Information System Indicators.....	296
Engaging Automatic Locking Mode.....	52	Blind Spot Information System Limitations.....	293
What Is Automatic Locking Mode.....	51	Blind Spot Information System Precautions.....	293
When to Use Automatic Locking Mode.....	51	Blind Spot Information System Requirements.....	293
Automatic Transmission.....	224	Blind Spot Information System – Troubleshooting.....	297
Automatic Transmission Positions.....	224	Blind Spot Information System – Information Messages.....	297
Brake Shift Interlock.....	225	Blind Spot Information System With Trailer Coverage.....	295
Manually Shifting Gears.....	225	Blind Spot Information System With Trailer Coverage Limitations.....	295
Power Take-Off.....	227	Selecting a Trailer.....	296
Automatic Transmission Fluid Capacity and Specification - Diesel.....	487	Setting a Trailer Length.....	295
Automatic Transmission Fluid Capacity and Specification - Gasoline.....	487	What Is Blind Spot Information System with Trailer Coverage.....	295
Automatic Transmission Positions.....	224	Bluetooth®.....	607
Drive (D).....	224	Body Control Module Fuse Box.....	392
Manual (M).....	224	Accessing the Body Control Module Fuse Box.....	392
Neutral (N).....	224	Identifying the Fuses in the Body Control Module Fuse Box.....	393
Park (P).....	224	Locating the Body Control Module Fuse Box.....	392
Reverse (R).....	224	Bonnet Lock	
Automatic Transmission Precautions.....	224	See: Opening and Closing the Hood.....	396
Auto Mode.....	151	Booster Seats.....	46
Auto Mode Indicators.....	151	Brake Fluid Specification.....	241
Switching Auto Mode On and Off.....	151	Brake Over Accelerator.....	240
Switching Dual Mode On and Off.....	152	Brake Precautions.....	240
Autounlock.....	84	Brakes.....	240
Autounlock Requirements.....	84	Anti-Lock Braking System.....	240
Switching Autounlock On and Off.....	84	Brakes – Troubleshooting.....	241
What Is Autounlock.....	84	Brake Shift Interlock.....	225
Autowipers.....	115	Brake Shift Interlock Precautions.....	225
Adjusting the Sensitivity of the Rain Sensor.....	115	Using Brake Shift Interlock.....	226
Autowipers Settings.....	115	What Is Brake Shift Interlock.....	225
What Are Autowipers.....	115	Brakes – Troubleshooting.....	241
Auxiliary Switches.....	616	Brakes – Frequently Asked Questions.....	241
<b>B</b>		Brakes – Warning Lamps.....	241
Battery		Breaking-In.....	373
See: Changing the 12V Battery.....	409		
Bed Extender.....	96		
Bed Extender Precautions.....	96		
Using the Bed Extender.....	97		
Beginning a Voice Interaction.....	600		
Blind Spot Information System.....	293		
Blind Spot Information System – Troubleshooting.....	297		

# Index

## C

Calculating Payload.....	314
Calculating the Load Limit.....	314
Canceling the Set Speed.....	252
Capacities and Specifications.....	467
Catalytic Converter.....	223
Catalytic Converter – Troubleshooting.....	223
Catalytic Converter Precautions.....	223
Catalytic Converter – Troubleshooting.....	223
Catalytic Converter – Warning Lamps.....	223
Center Console.....	188
Opening the Center Console.....	188
Center Display Limitations.....	597
Center Display Overview.....	597
Center Display Precautions.....	597
Changing a Flat Tire.....	455
Changing a Road Wheel.....	455
Changing the 12V Battery.....	409
Changing the Fuel Filter - Diesel.....	408
Changing the Fuel Filter - Gasoline.....	409
Changing the Remote Control Battery.....	71
Changing the Remote Control Battery - Vehicles With: Flip Key.....	72
Changing the Vehicle Wi-Fi Hotspot Name or Password.....	506
Charging a Device.....	181
Charging a Wireless Device.....	185
Checking MyKey System Status.....	80
Checking the Brake Fluid.....	240
Checking the Coolant.....	402
Checking the Seatbelts.....	55
Checking the Selective Catalytic Reduction System Status.....	221
Checking the Tire Pressures.....	441
Checking the Wiper Blades.....	116
Children and Airbags.....	64
Child Restraint Anchor Points.....	36
Locating the Child Restraint Lower Anchor Points.....	36
Locating the Child Restraint Top Tether Anchor Points.....	37
What Are the Child Restraint Anchor Points.....	36
Child Restraints.....	38
Child Restraint Position Information.....	38
Child Restraints Recommendation.....	39
Child Safety.....	35
Child Restraint Anchor Points.....	36
Child Restraints.....	38
Installing Child Restraints.....	39
Child Safety Locks.....	48
Child Safety Precautions.....	35
Cleaning Products.....	421
Cleaning the Exterior.....	421
Cleaning Camera Lenses and Sensors.....	423
Cleaning Chrome, Aluminium or Stainless Steel.....	422
Cleaning Headlamps and Rear Lamps.....	421
Cleaning Stripes or Graphics.....	423
Cleaning the Engine Compartment.....	422
Cleaning the Exhaust.....	423
Cleaning the Exterior Precautions.....	421
Cleaning the Underbody.....	423
Cleaning Wheels.....	422
Cleaning Windows and Wiper Blades.....	422
Cleaning the Interior.....	424
Cleaning Carpets and Floor Mats.....	425
Cleaning Displays and Screens.....	424
Cleaning Moonroof Tracks.....	426
Cleaning Plastic.....	424
Cleaning Seatbelts.....	426
Cleaning Seats and the Headliner.....	424
Cleaning the Instrument Panel.....	424
Clearing All MyKeys.....	79
Clearing the Garage Door Opener.....	178
Climate.....	570
Climate Control.....	149
Auto Mode.....	151
Climate Control Hints.....	152
Cold Weather Precautions.....	373
Configuring the Trip Computer.....	145
Connected Vehicle.....	498
Connected Vehicle – Troubleshooting.....	503
Connecting the Vehicle to a Mobile Network.....	498

# Index

Connected Vehicle Data.....	26
Connected Vehicle Limitations.....	498
Connected Vehicle Requirements.....	498
Connected Vehicle – Troubleshooting.....	503
Connected Vehicle – Frequently Asked Questions.....	503
Connected Vehicle – Troubleshooting - Vehicles With: Modem.....	499
Connected Vehicle – Troubleshooting - Vehicles With: SYNC 3.....	500
Connecting a Bluetooth® Device.....	607
Connecting a Trailer.....	325
Connecting a Trailer – Troubleshooting.....	327
Hitches.....	323
Connecting a Trailer Precautions.....	323
Connecting a Trailer – Troubleshooting.....	327
Connecting a Trailer – Information Messages.....	327
Connecting the Vehicle to a Mobile Network.....	498
Connecting FordPass to the Modem.....	498
Enabling and Disabling the Modem.....	498
What Is the Modem.....	498
Connecting the Vehicle to a Wi-Fi Network.....	498
Connecting Your Phone.....	602
Contacting Us.....	17
Cooling System Capacity and Specification - 6.2L.....	479
Cooling System Capacity and Specification - 6.7L Diesel.....	480
Cooling System Capacity and Specification - 7.3L.....	480
Crash and Breakdown Information.....	378
Automatic Crash Shutoff.....	381
Jump Starting the Vehicle.....	379
Post-Crash Alert System.....	381
Recovery Towing.....	382
Crash Sensors and Airbag Indicator.....	65
Creating a MyKey.....	78
Creating a MyKey - Vehicles With: Flip Key.....	79
Creating a Vehicle Wi-Fi Hotspot.....	506
Cross Traffic Alert.....	298
Cross Traffic Alert – Troubleshooting.....	300
Cross Traffic Alert Indicators.....	300
Cross Traffic Alert Limitations.....	298
Cross Traffic Alert Precautions.....	298
Cross Traffic Alert – Troubleshooting.....	300
Cross Traffic Alert – Information Messages.....	300
Cruise Control.....	270
Cruise Control Indicators.....	271
Cup Holders.....	187
Cup Holder Precautions.....	187
Customer Information.....	640
Radio Frequency Certification Labels.....	643
Customizing the Instrument Cluster Display - Vehicles With: 8 Inch Screen.....	142
<b>D</b>	
Data Privacy.....	24
Department of Transportation Uniform Tire Quality Grades.....	429
Deploying and Stowing the Power Running Boards.....	110
Diesel Engine Exhaust Brake.....	244
Diesel Engine Exhaust Brake – Troubleshooting.....	245
Diesel Engine Exhaust Brake Indicators.....	245
Diesel Engine Exhaust Brake – Precautions.....	244
Diesel Engine Exhaust Brake – Troubleshooting.....	245
Diesel Engine Exhaust Brake – Warning Lamps.....	245
Diesel Exhaust Fluid Capacity and Specification.....	221
Diesel Particulate Filter.....	212
Diesel Particulate Filter Manual Regeneration.....	213
Diesel Particulate Filter – Troubleshooting.....	215

# Index

Diesel Particulate Filter Manual Regeneration.....	213
Diesel Particulate Filter Manual Regeneration Limitations.....	214
Diesel Particulate Filter Manual Regeneration Precautions.....	213
Diesel Particulate Filter Manual Regeneration Requirements.....	213
Starting Diesel Particulate Filter Manual Regeneration.....	214
What Is Diesel Particulate Filter Manual Regeneration.....	213
Diesel Particulate Filter Precautions.....	212
Diesel Particulate Filter Requirements.....	213
Diesel Particulate Filter – Troubleshooting.....	215
Diesel Particulate Filter – Information Messages.....	215
Diesel Particulate Filter – Warning Lamps.....	215
Digital Radio.....	510
Digital Radio Indicators.....	529
Digital Radio Limitations.....	528
How Does Digital Radio Work.....	528
Switching Digital Radio Reception On and Off.....	528
What Is Digital Radio.....	528
Directing the Flow of Air.....	150
Disposing of Airbags.....	66
Distance Alert.....	305
Adjusting the Sensitivity of Distance Alert.....	305
What Is Distance Alert.....	305
Distance Indication.....	304
Distance Indication Indicator.....	305
Switching Distance Indication On and Off.....	305
What Is Distance Indication.....	304
Doors and Locks Audible Warnings.....	84
Doors and Locks.....	83
Autolock.....	84
Autounlock.....	84
Doors and Locks – Troubleshooting.....	85
Mislock.....	84
Operating the Doors From Inside Your Vehicle.....	83
Operating the Doors From Outside Your Vehicle.....	83
Doors and Locks – Troubleshooting.....	85
Doors and Locks – Frequently Asked Questions.....	86
Doors and Locks – Information Messages.....	85
Doors and Locks – Warning Lamps.....	85
Draining the Fuel Filter Water Trap – Diesel.....	407
Drive Belt Routing - 6.2L.....	419
Drive Belt Routing - 6.7L Diesel, Vehicles With: Dual Generators.....	419
Drive Belt Routing - 6.7L Diesel, Vehicles With: Single Generator.....	419
Drive Belt Routing - 7.3L, Vehicles With: Dual Generators.....	420
Drive Belt Routing - 7.3L, Vehicles With: Single Generator.....	420
Drive Mode Control.....	281
Drive Mode Control – Troubleshooting.....	283
Drive Modes.....	282
Drive Mode Control – Troubleshooting.....	283
Drive Mode Control – Frequently Asked Questions.....	285
Drive Mode Control – Information Messages.....	284
Drive Mode Control – Warning Lamps.....	283
Drive Modes.....	282
Deep Snow/Sand.....	282
Eco.....	282
Normal.....	282
Rock Crawl.....	283
Tow/Haul.....	283
Driver Alert.....	309
Driver Alert – Troubleshooting.....	310
Driver Alert Limitations.....	309
Driver Alert Precautions.....	309
Driver Alert – Troubleshooting.....	310
Driver Alert – Information Messages.....	310
Driving Economically.....	373
Driving Hints.....	371
Off-Road Driving.....	371
Driving Through Shallow Water.....	373

# Index

## E

Easy Entry and Exit.....	93
Electromagnetic Compatibility.....	713
Electronic Locking Differential.....	237
Electronic Locking Differential – Troubleshooting.....	239
Electronic Locking Differential Indicators.....	239
Electronic Locking Differential Precautions.....	237
Electronic Locking Differential – Troubleshooting.....	239
Electronic Locking Differential – Information Messages.....	239
Emergency Call Limitations.....	68
Emergency Call Requirements.....	67
Emergency Call System Data.....	28
Emergency Towing.....	386
Emission Law.....	710
Enabling Apps on an Android Device.....	608
Enabling Apps on an iOS Device.....	608
Enabling Remote Start.....	146
End User License Agreement.....	685
Engine Air Filter.....	405
Changing the Engine Air Filter.....	405
Engine Air Filter - Information Messages.....	406
Engine Block Heater.....	194
Engine Block Heater Precautions.....	194
How Does the Engine Block Heater Work.....	195
Using the Engine Block Heater.....	195
Engine Oil Capacity and Specification - 6.2L.....	473
Engine Oil Capacity and Specification - 6.7L Diesel.....	474
Engine Oil Capacity and Specification - 7.3L.....	477
Engine Oil.....	400
Adding Engine Oil.....	401
Checking the Engine Oil Level.....	400
Engine Oil Capacity and Specification.....	401
Engine Oil Dipstick Overview.....	400
Resetting the Engine Oil Change Reminder.....	401
Engine Specifications - 6.2L.....	467
Engine Specifications - 6.7L Diesel.....	467
Engine Specifications - 7.3L.....	468
Entertainment.....	560
Event Data.....	25
Export Unique Options.....	711
Extending the Exterior Mirrors.....	130
Extending the Remote Start Duration.....	147
Exterior Bulbs.....	412
Changing a Front Fog Lamp Bulb.....	415
Changing a Front Turn Signal Lamp Bulb.....	415
Changing a Headlamp Bulb.....	414
Changing a High Mounted Stoplamp Bulb.....	418
Changing a License Plate Lamp Bulb.....	418
Changing a Rear Lamp Bulb.....	416
Changing a Rear Turn Signal Lamp Bulb.....	417
Changing a Reversing Lamp Bulb.....	417
Changing a Stoplamp Bulb.....	416
Exterior Bulb Specification Chart.....	412
Removing a Rear Lamp Assembly.....	414
Exterior Lamps.....	119
Exterior Lamp Audible Warning.....	121
Exterior Lamp Indicators.....	121
Switching the Cargo Lamps On.....	120
Switching the Daytime Running Lamps On and Off.....	120
Switching the Front Fog Lamps On and Off.....	120
Switching the Spot Lamps On and Off.....	121
Switching the Turn Signal Lamps On and Off.....	119
Exterior Lighting Control.....	118
Exterior Lighting.....	118
Autolamps.....	119
Automatic High Beam Control.....	121
Automatic High Beam Control – Troubleshooting.....	123
Exterior Lamps.....	119
Headlamps.....	118
Headlamps – Troubleshooting.....	118
Exterior Mirrors.....	129
Auto-Dimming Exterior Mirror.....	130

# Index

## F

Fastening and Unfastening the Seatbelts.....	50
Feature Bar.....	598
Filling the Selective Catalytic Reduction System Tank.....	219
Filling the Selective Catalytic Reduction System Tank in Cold Weather.....	219
Filling the Selective Catalytic Reduction System Tank Using a Fuel Station Pump.....	219
Filling the Selective Catalytic Reduction System Tank Using a Portable Container.....	220
Flat Tire See: Changing a Flat Tire.....	455
Floor Mats.....	374
Folding the Exterior Mirrors - Vehicles With: Manual Folding Mirrors.....	129
Folding the Exterior Mirrors - Vehicles With: Power Folding Mirrors.....	129
Foot Pedals See: Adjusting the Pedals.....	114
Ford Protect.....	620
Four-Wheel Drive Driving Hints.....	232
Driving In Sand.....	232
Driving on Hilly or Sloping Terrain.....	233
Driving on Snow and Ice.....	233
Driving Through Mud and Water.....	232
Emergency Maneuvers.....	232
Four-Wheel Drive.....	228
Four-Wheel Drive Driving Hints.....	232
Four-Wheel Drive Modes.....	231
Four-Wheel Drive – Troubleshooting.....	234
Four-Wheel Drive Indicators.....	232
Four-Wheel Drive Limitations.....	230
Four-Wheel Drive Modes.....	231
Four-Wheel Drive High.....	231
Four-Wheel Drive Low.....	231
Two-Wheel Drive High.....	231
Four-Wheel Drive Precautions.....	228
Four-Wheel Drive – Troubleshooting.....	234
Four-Wheel Drive – Information Messages.....	235
Four-Wheel Drive – Warning Lamps.....	234
Front Axle Fluid Capacity and Specification.....	490
Front Exterior.....	33
Front Seat Precautions.....	158
Front Seats.....	158
Heated Seats.....	165
Manual Seats.....	159
Massage Seats.....	164
Power Seats.....	161
Ventilated Seats.....	165
Fuel and Refueling.....	203
Fuel and Refueling – Troubleshooting.....	211
Fuel Quality.....	204
Refueling.....	209
Running Out of Fuel.....	208
Fuel and Refueling Precautions.....	203
Fuel and Refueling – Troubleshooting.....	211
Fuel and Refueling – Information Messages.....	211
Fuel and Refueling – Warning Lamps.....	211
Fuel Gauge.....	136
Fuel Gauge Limitations.....	136
Locating the Fuel Filler Door.....	136
What Is Distance to Empty.....	136
What Is the Fuel Gauge.....	136
What Is the Low Fuel Reminder.....	136
Fuel Quality.....	204
Selecting the Correct Fuel.....	204
Selecting the Correct Fuel for Cold Weather.....	205
Switching Between E85 and Gasoline.....	208
Fuel Tank Capacity - Diesel.....	481
Fuel Tank Capacity.....	211
Fuel Tank Capacity - Gasoline.....	482
Fuse Precautions.....	387
Fuses.....	387
Body Control Module Fuse Box.....	392
Fuses – Troubleshooting.....	395
Under Hood Fuse Box.....	387
Fuses – Troubleshooting.....	395
Fuses – Frequently Asked Questions.....	395

## G

Garage Door Opener.....	176
Garage Door Opener Limitations.....	176

# Index

Garage Door Opener Precautions.....	176
Garage Door Opener Radio Frequencies.....	179
General Maintenance Information.....	622
Glasses Holder.....	190
Locating the Glasses Holder.....	190
Glossary of Tire Terminology.....	435
Glove Compartment.....	187
Locking the Glove Compartment.....	187
Opening the Glove Compartment.....	187
<b>H</b>	
Headlamp Adjusting See: Adjusting the Headlamps.....	411
Headlamps.....	118
Headlamp Indicators.....	118
Using the High Beam Headlamps.....	118
Headlamps – Troubleshooting.....	118
Headlamps – Frequently Asked Questions.....	118
Heated Seats.....	165
Heated Seat Precautions.....	165
Switching the Heated Seats On and Off.....	165
Heating See: Climate Control - Vehicles With: Automatic Temperature Control.....	149
See: Climate Control - Vehicles With: Manual Temperature Control.....	154
Hill Descent Control.....	254
Hill Descent Control – Troubleshooting.....	255
Hill Descent Control Indicator.....	254
Hill Descent Control Precautions.....	254
Hill Descent Control – Troubleshooting.....	255
Hill Descent Control – Information Messages.....	255
Hill Start Assist.....	246
Hill Start Assist – Troubleshooting.....	246
Hill Start Assist Precautions.....	246
Hill Start Assist – Troubleshooting.....	246
Hill Start Assist – Information Messages.....	246
Hitches.....	323
Fifth-Wheel Trailer Hitch.....	325
Hooking Up a Trailer Using a Weight-Distributing Hitch.....	324
Installing a Hitch.....	323
Hood Lock See: Opening and Closing the Hood.....	396
Horn.....	112
How Does 911 Assist Work.....	67
How Does Adaptive Cruise Control Work.....	272
How Does Blind Spot Information System Work.....	293
How Does Cross Traffic Alert Work.....	298
How Does Drive Mode Control Work.....	281
How Does Driver Alert Work.....	309
How Does Easy Entry and Exit Work.....	93
How Does Four-Wheel Drive Work.....	228
How Does Hill Descent Control Work.....	254
How Does Hill Start Assist Work.....	246
How Does Pre-Collision Assist Work.....	301
How Does Stability Control Work.....	249
How Does the 360 Degree Camera Work.....	266
How Does the Diesel Particulate Filter Work.....	212
How Does the Electronic Locking Differential Work.....	237
How Does the Garage Door Opener Work.....	176
How Does the Lane Keeping System Work.....	286
How Does the Rear Occupant Alert System Work.....	171
How Does the Safety Canopy™ Work.....	58
How Does the Selective Catalytic Reduction System Work.....	217
How Does Traction Control Work.....	247
How Does Trailer Backup Assistance Work.....	339
How Does Trailer Reverse Guidance Work.....	357
How Does Trailer Sway Control Work.....	338



# Index

How Do the Front Airbags Work.....	57
How Do the Side Airbags Work.....	57
Hydraulic Power Steering Fluid Capacity and Specification.....	496
Hydraulic Power Steering.....	256
Checking the Hydraulic Power Steering Fluid.....	257
Hydraulic Power Steering Adaptive Steering.....	258
Hydraulic Power Steering Guidelines.....	256
Locating the Hydraulic Power Steering Fluid Reservoir.....	257
<b>I</b>	
Identifying Fuse Types.....	395
Identifying the Audio Unit.....	535
Identifying the Auxiliary Switch Wiring.....	619
Identifying the Climate Control Unit.....	149
Ignition Switch.....	191
Inflating the Tires.....	441
Information On Demand Screen.....	599
Information on the Tire Sidewall.....	430
Inspecting the Tire for Damage.....	445
Inspecting the Tire for Wear.....	444
Inspecting the Wheel Valve Stems.....	446
Installing Child Restraints.....	39
Attaching the Front Seat Tether Strap.....	44
Attaching the Rear Seat Tether Strap.....	45
Combining the Seatbelt and Lower Anchors for Attaching Child Restraints.....	44
Installing a Child Restraint in a Center Seat.....	43
Using Lower Anchors and Tethers for Children.....	43
Using Seatbelts.....	39
Using Tether Straps.....	44
Instrument Cluster Display.....	141
Personalized Settings.....	142
Instrument Cluster Display Main Menu - Vehicles With: 2.3 Inch Screen.....	141
Instrument Cluster Display Main Menu - Vehicles With: 4.2 Inch Screen.....	141
Instrument Cluster Display Main Menu - Vehicles With: 8 Inch Screen.....	142
Instrument Cluster Indicators.....	138
Instrument Cluster.....	133
Fuel Gauge.....	136
Instrument Cluster Overview - Vehicles With: 2.3 Inch Screen.....	133
Instrument Cluster Overview - Vehicles With: 4.2 Inch Screen.....	134
Instrument Cluster Overview - Vehicles With: 8 Inch Screen.....	135
Instrument Cluster Warning Lamps.....	137
Instrument Panel.....	31
Integrated Trailer Brake Controller.....	334
Integrated Trailer Brake Controller - Troubleshooting.....	336
Integrated Trailer Brake Controller Precautions.....	334
Integrated Trailer Brake Controller - Troubleshooting.....	336
Integrated Trailer Brake Controller - Frequently Asked Questions.....	337
Integrated Trailer Brake Controller - Information Messages.....	336
Interior Air Quality.....	157
Interior Bulbs.....	419
Interior Bulb Specification Chart.....	419
Interior Lamp Function.....	124
Switching the Interior Lamp Function On and Off.....	124
What Is the Interior Lamp Function.....	124
Interior Lighting.....	124
Ambient Lighting.....	125
Interior Lamp Function.....	124
Interior Lighting - Troubleshooting.....	125
Interior Lighting - Troubleshooting.....	125
Interior Lighting - Frequently Asked Questions.....	125
Interior Mirror.....	128
Auto-Dimming Interior Mirror.....	128
Interior Mirror Precautions.....	128
Introduction.....	19
<b>J</b>	
Jump Starting the Vehicle.....	379
Jump Starting Precautions.....	379
Jump Starting the Vehicle.....	380

# Index

Preparing the Vehicle.....	380	Launching or Retrieving a Boat or Personal Watercraft.....	330
<b>K</b>		Live Traffic.....	610
Keyless Entry.....	87	Switching Live Traffic On and Off.....	610
Keyless Entry – Troubleshooting.....	88	What Is Live Traffic.....	610
Keyless Entry Keypad.....	89	Load Carrying.....	311
Keyless Entry Keypad –		Load Carrying Precautions.....	311
Troubleshooting.....	91	Loading Your Trailer.....	329
Keyless Entry Keypad Limitations.....	89	Locating the 360 Degree	
Keyless Entry Keypad Master Access		Cameras.....	266
Code.....	89	Locating the Auxiliary Switches.....	618
Keyless Entry Keypad Personal Access		Locating the Auxiliary Switch	
Codes.....	90	Wiring.....	618
Keyless Entry Keypad –		Locating the Blind Spot Information	
Troubleshooting.....	91	System Sensors.....	294
Keyless Entry Keypad – Frequently Asked		Locating the Brake Fluid Reservoir.....	240
Questions.....	91	Locating the Cross Traffic Alert	
Keyless Entry Limitations.....	87	Sensors.....	299
Keyless Entry Settings.....	87	Locating the Keyless Entry Keypad.....	89
Keyless Entry – Troubleshooting.....	88	Locating the Memory Function	
Keyless Entry – Frequently Asked		Buttons.....	174
Questions.....	88	Locating the Power Outlet.....	182
Keys and Remote Controls.....	69	Locating the Pre-Collision Assist	
Keys and Remote Controls –		Sensors.....	303
Troubleshooting.....	76	Locating the Rear View Camera.....	263
Keys and Remote Controls –		Locating the Safety Compliance	
Troubleshooting.....	76	Certification Labels.....	312
Keys and Remote Controls – Information		Locating the Tire label.....	429
Messages.....	76	Locating the USB Ports.....	180
		Locating the Wireless Accessory	
<b>L</b>		Charger.....	185
Lane Keeping System Indicators.....	289	Locating Your Vehicle.....	70
Lane Keeping System.....	286	Locking and Unlocking the Tailgate.....	94
Lane Keeping System –		Locking the Rear Window Controls.....	127
Alert Mode.....	288		
Lane Keeping System –		<b>M</b>	
Troubleshooting.....	290	Maintenance.....	396
Lane Keeping System Limitations.....	286	Engine Air Filter.....	405
Lane Keeping System		Engine Oil.....	400
Precautions.....	286	Exterior Bulbs.....	412
Lane Keeping System –		Interior Bulbs.....	419
Troubleshooting.....	290	Maintenance Precautions.....	396
Lane Keeping System – Frequently Asked		Making and Receiving a Phone	
Questions.....	291	Call.....	604
Lane Keeping System – Information		Manually Dimming the Interior	
Messages.....	290	Mirror.....	128

# Index

Manually Shifting Gears.....	225
Shifting Using the Buttons on the Selector Level.....	225
Manual Seats.....	159
Adjusting the Head Restraint.....	159
Adjusting the Lumbar Support.....	161
Adjusting the Seat Backrest.....	161
Folding the Seats.....	168
Head Restraint Components.....	159
Installing the Head Restraint.....	160
Moving the Seat Backward and Forward.....	160
Removing the Head Restraint.....	160
Unfolding the Seats.....	168
Massage Seats.....	164
Adjusting the Massage Seat Settings.....	164
Massage Seat Limitations.....	164
Memory Function.....	174
Memory Function Precautions.....	174
Mislock.....	84
Mislock Limitations.....	84
Switching Mislock On and Off.....	84
What Is Mislock.....	84
Mobile Communications	
Equipment.....	685
Mobile Device Data - Vehicles With:	
SYNC 3.....	27
Mobile Device Data - Vehicles With:	
SYNC 4.....	27
Moonroof Bounce-Back.....	132
Overriding Moonroof Bounce-Back.....	132
What Is Moonroof Bounce-Back.....	132
Moonroof.....	131
Moonroof Bounce-Back.....	132
Motorcraft Parts - 6.2L.....	469
Motorcraft Parts - 6.7L Diesel.....	471
Motorcraft Parts - 7.3L.....	472
Muting the Audio.....	526
MyKey Settings.....	77
Configurable MyKey Settings.....	77
Non-Configurable MyKey Settings.....	77
MyKey – Troubleshooting.....	80
MyKey – Frequently Asked Questions.....	82
MyKey – Information Messages.....	80
MyKey™.....	77
MyKey Settings.....	77
MyKey – Troubleshooting.....	80

## N

Navigation Map Updates.....	610
Navigation.....	574
Adjusting the Map.....	610
Live Traffic.....	610
Route Guidance.....	611
Setting a Destination.....	610
Waypoints.....	611
Normal Scheduled Maintenance - Diesel.....	625
Normal Scheduled Maintenance - Gasoline.....	628

## O

Off-Road Driving.....	371
After Driving Your Vehicle Off-Road.....	372
Basic Off-Road Driving Techniques.....	371
Driving Through Water Limitations.....	372
What Is Off-Road Driving.....	371
Opening and Closing the Flip Key.....	69
Opening and Closing the Hood.....	396
Opening and Closing the Moonroof.....	131
Opening and Closing the Sliding Windows.....	127
Opening and Closing the Sun Shade.....	131
Opening and Closing the Windows.....	126
Opening the Tailgate.....	94
Opening the Tailgate From Inside Your Vehicle.....	99
Opening the Tailgate From Outside Your Vehicle.....	94
Opening the Tailgate Using the Remote Control.....	99
Operating the Doors From Inside Your Vehicle.....	83
Individually Unlocking and Locking the Doors Using the Locking Button.....	83
Opening the Doors From Inside Your Vehicle.....	84
Operating the Doors From Outside Your Vehicle.....	83
Unlocking and Locking the Doors Using the Key Blade.....	83
Unlocking and Locking the Doors Using the Remote Control.....	83

# Index

Operating Your Vehicle With a Snowplow.....	376
Ordering a Canadian French Owner's Manual.....	641
Our Sustainability Report.....	640
Overriding the Set Speed.....	277
<b>P</b>	
Parking Aid Precautions.....	260
Parking Aids.....	260
Parking Aids – Troubleshooting.....	261
Rear Parking Aid.....	260
Parking Aids – Troubleshooting.....	261
Parking Aids – Information Messages.....	261
Parking Brake.....	243
Parking Brake – Troubleshooting.....	243
Parking Brake – Troubleshooting.....	243
Parking Brake – Information Messages.....	243
Passive Anti-Theft System.....	106
How Does the Passive Anti-Theft System Work.....	106
What Is the Passive Anti-Theft System.....	106
Perchlorate.....	684
Performing a Master Reset.....	614
Personalized Settings.....	142
Changing the Instrument Cluster Display Language.....	142
Changing the Measure Unit.....	143
Changing the Temperature Unit.....	143
Changing the Tire Pressure Unit.....	143
Phone Menu.....	602
Phone.....	572
Phone Precautions.....	602
Pickup Bed Anchor Points.....	317
Installing and Removing the Pickup Bed Tie-Down Cleats.....	318
Locating the Pickup Bed Anchor Points.....	317
Pickup Bed Anchor Point Load Capacities.....	318
Pickup Bed Anchor Point Precautions.....	317
Pickup Bed.....	317
Pickup Bed Anchor Points.....	317
Pickup Bed Ramps.....	319
Tailgate Anchor Points.....	319
Pickup Bed Precautions.....	317
Pickup Bed Ramps.....	319
Installing and Removing the Pickup Bed Ramp Holder.....	320
Installing and Removing the Pickup Bed Ramps.....	320
Pickup Bed Ramp Precautions.....	319
Storing the Pickup Bed Ramps.....	321
Playing Media Using Bluetooth®.....	607
Playing Media Using the USB Port.....	180
Playing or Pausing the Audio Source.....	525
Post-Crash Alert System.....	381
How Does the Post-Crash Alert System Work.....	381
Post-Crash Alert System Limitations.....	381
Switching the Post-Crash Alert System Off.....	381
What Is the Post-Crash Alert System.....	381
Power Outlet Indicators.....	182
Power Outlet Limitations.....	182
Power Outlet.....	182
Power Outlet Precautions.....	182
Power Running Board Precautions.....	110
Power Running Board Settings.....	110
Power Running Boards.....	110
Power Running Boards – Troubleshooting.....	110
Power Running Boards – Troubleshooting.....	110
Power Running Boards – Frequently Asked Questions.....	110
Power Seats.....	161
Adjusting the Head Restraint.....	162
Adjusting the Lumbar Support.....	164
Adjusting the Seat Backrest.....	163
Adjusting the Seat Cushion.....	163
Adjusting the Seat Height.....	163
Head Restraint Components.....	161
Installing the Head Restraint.....	163
Moving the Seat Backward and Forward.....	163
Removing the Head Restraint.....	162
Power Take-Off.....	227
How Does the Power Take-Off Work.....	227
What is the Split Shaft Capability.....	227
Pre-Collision Assist Limitations.....	302
Pre-Collision Assist Precautions.....	301

# Index

Pre-Collision Assist.....	301	Rear Axle Fluid Capacity and Specification - Diesel.....	491
Automatic Emergency Braking.....	306	Rear Axle Fluid Capacity and Specification - Gasoline.....	493
Distance Alert.....	305	Rear Exterior.....	34
Distance Indication.....	304	Rear Occupant Alert System Audible Warnings.....	173
Pre-Collision Assist – Troubleshooting.....	307	Rear Occupant Alert System Indicators - Vehicles With: SYNC 3/SYNC 4.....	172
Pre-Collision Assist – Troubleshooting.....	307	Rear Occupant Alert System Indicators - Vehicles With: SYNC.....	172
Pre-Collision Assist – Frequently Asked Questions.....	308	Rear Occupant Alert System Limitations.....	171
Pre-Collision Assist – Information Messages.....	307	Rear Occupant Alert System Precautions.....	171
Preparing Your Vehicle for Storage.....	427	Rear Occupant Alert System.....	171
Programming a MyKey.....	79	Rear Parking Aid.....	260
Programming the Garage Door Opener to Your Garage Door Opener Motor.....	177	Locating the Rear Parking Aid Sensors.....	261
Programming the Garage Door Opener to Your Gate Opener Motor.....	178	Rear Parking Aid Audible Warnings.....	261
Programming the Garage Door Opener to Your Hand-Held Transmitter.....	177	Rear Parking Aid Limitations.....	260
Programming the Remote Control.....	74	What is the Rear Parking Aid.....	260
Programming the Remote Control - Vehicles With: Flip Key.....	75	Rear Seats.....	167
Properly Adjusting the Driver and Front Passenger Seats.....	64	Heated Seats.....	169
Puncture See: Changing a Flat Tire.....	455	Manual Seats.....	167
Push Button Ignition Switch.....	192	Rear View Camera Guide Lines.....	264
<b>R</b>		Rear View Camera Precautions.....	263
Radio Frequency Certification Labels.....	643	Rear View Camera.....	263
Blind Spot Information System Sensors.....	643	Rear View Camera Settings.....	264
Body Control Module.....	649	Rear View Camera Settings.....	264
Cruise Control Module.....	651	Switching Rear View Camera Delay On and Off.....	265
Keys and Remote Controls.....	655	Zooming the Rear View Camera In and Out.....	264
Passive Anti-Theft System.....	659	Recalling a Preset Position.....	174
Radio Transceiver Module.....	663	Recovery Towing.....	382
SYNC.....	666	Accessing the Front Towing Point.....	382
Telematics Control Unit.....	676	Recreationally Towing Your Vehicle - 4x2.....	386
Tire Pressure Monitoring System Sensors.....	676	Recreationally Towing Your Vehicle - 4x4.....	384
Wireless Accessory Charging Module.....	680	Refueling.....	209
		Refueling System Overview.....	209
		Refueling Your Vehicle.....	209
		Releasing the Parking Brake.....	243
		Remote Control Limitations.....	69
		Remotely Starting and Stopping the Vehicle.....	146

# Index

Remote Start Limitations.....	146
Remote Start Precautions.....	146
Remote Start Remote Control	
Indicators.....	147
Remote Start.....	146
Remote Start Settings.....	147
Remote Start Settings.....	147
Setting the Remote Start Duration.....	148
Switching Climate Control Auto Mode On and Off.....	147
Switching Climate Control Last Settings On and Off.....	147
Switching the Heated Seat Settings On and Off.....	147
Switching the Heated Steering Wheel Settings On and Off.....	148
Removing and Installing the Tailgate.....	94
Removing the Key Blade.....	70
Removing Your Vehicle From Storage.....	428
Repairing Minor Paint Damage.....	426
Replacement Parts	
Recommendation.....	684
Replacing a Lost Key or Remote Control.....	73
Replacing the Cabin Air Filter.....	157
Replacing the Front Wiper Blades.....	116
Reporting Safety Defects in Canada.....	642
Reporting Safety Defects in the United States.....	642
Reprogramming the Garage Door Opener.....	179
Resetting the Individual Trip Values.....	145
Resetting the Stopping Position - Vehicles With: Power Adjustable Steering Column.....	112
Resetting the Trip Computer.....	145
Resetting Tire Pressure Monitoring System.....	450
Resuming the Set Speed.....	271
Roadside Assistance.....	378
Rollover Warning.....	640
Route Guidance.....	611
Adjusting the Guidance Prompt Volume.....	611
Canceling Route Guidance.....	611
Repeating an Instruction.....	611
Running-In	
See: Breaking-In.....	373
Running Out of Fuel.....	208
Adding Fuel From a Portable Fuel Container.....	208
Filling a Portable Fuel Container.....	208
<b>S</b>	
Satellite Radio.....	513
Locating the Satellite Radio Identification Number.....	529
Satellite Radio Limitations.....	529
Satellite Radio Settings.....	530
Selecting a Channel.....	530
What Is Satellite Radio.....	529
Saving a Preset Position.....	174
Scheduled Maintenance.....	622
Seatbelt Extensions.....	56
Seatbelt Precautions.....	49
Seatbelt Reminder.....	53
How Does the Seatbelt Reminder Work.....	53
Seatbelt Reminder Audible Warnings.....	55
Seatbelt Reminder Indicators.....	55
Switching the Seatbelt Reminder On and Off.....	55
Seatbelts.....	49
Automatic Locking Mode.....	51
Seatbelt Reminder.....	53
Sensitive Locking Mode.....	51
Security.....	106
Anti-Theft Alarm System.....	106
Anti-Theft Alarm System Settings.....	107
Passive Anti-Theft System.....	106
Security – Troubleshooting.....	108
Security – Troubleshooting.....	108
Security – Frequently Asked Questions.....	109
Security – Information Messages.....	108
Selecting a Drive Mode.....	281
Selecting a Four-Wheel Drive Mode.....	230
Selecting the Audio Source.....	525
Selective Catalytic Reduction System Guidelines.....	218

# Index

Selective Catalytic Reduction System	
Precautions.....	217
Selective Catalytic Reduction System	
Requirements.....	218
Selective Catalytic Reduction	
System.....	217
Filling the Selective Catalytic Reduction	
System Tank.....	219
Selective Catalytic Reduction System –	
Troubleshooting.....	221
Selective Catalytic Reduction System –	
Troubleshooting.....	221
Selective Catalytic Reduction System –	
Information Messages.....	221
Selective Catalytic Reduction System –	
Warning Lamps.....	221
Sending and Receiving a Text	
Message.....	605
Sensitive Locking Mode.....	51
How Does Sensitive Locking Mode	
Work.....	51
What is Sensitive Locking Mode.....	51
Service Data.....	25
Setting a Destination.....	610
Setting a Destination Using a Point of	
Interest.....	611
Setting a Destination Using a Predictive	
Destination.....	611
Setting a Destination Using a Recent	
Destination.....	611
Setting a Destination Using a Saved	
Destination.....	611
Setting a Destination Using the Map	
Screen.....	610
Setting a Destination Using the Text Entry	
Screen.....	610
Setting a Memory Preset.....	526
Settings Data.....	26
Settings.....	582
Setting the Adaptive Cruise Control	
Gap.....	276
Setting the Adaptive Cruise Control	
Speed.....	275
Setting the Blower Motor Speed.....	150
Setting the Clock and Date.....	526
Setting the Cruise Control Speed.....	270
Setting the Hill Descent Speed.....	254
Setting the Temperature.....	150
Setting the Trail Control Speed.....	252
Setting the Wake Word.....	600
Setting Up the Trailer Backup Assistance	
for a Conventional Trailer.....	339
Applying the Trailer Reversing Aid	
Sticker.....	341
Calibrating the System.....	342
Configuring the Trailer.....	339
Setting Up the Trailer Backup Assistance	
for a Fifth-Wheel or Gooseneck	
Trailer.....	343
Calibrating the System.....	345
Configuring the Trailer.....	343
Trailer Sensor Installation.....	344
Setting Up Trailer Reverse Guidance for	
a Conventional Trailer.....	357
Applying the Trailer Reverse Aid	
Sticker.....	359
Calibrating the System.....	360
Configuring the Trailer.....	357
Setting Up Trailer Reverse Guidance for	
a Fifth-Wheel or Gooseneck	
Trailer.....	360
Calibrating the System.....	362
Configuring the Trailer.....	360
Trailer Sensor Installation.....	361
Shifting Your Vehicle Into Gear.....	224
Sitting in the Correct Position.....	158
Snow Plowing Precautions.....	376
Snow Plowing.....	376
Sounding the Panic Alarm.....	70
Special Operating Conditions Scheduled	
Maintenance - Diesel.....	631
Special Operating Conditions Scheduled	
Maintenance - Gasoline.....	636
Speed Control	
See: Cruise Control.....	270
Stability Control Indicator.....	251
Stability Control.....	249
Starter Switch	
See: Ignition Switch.....	191
Starting and Stopping the Engine –	
Precautions.....	191
Starting and Stopping the Engine.....	191
Automatic Engine Stop.....	196
Engine Block Heater.....	194
Starting and Stopping the Engine –	
Troubleshooting.....	198

# Index

Starting the Engine.....	192	Switching Android Auto On and Off.....	609
Stopping the Engine.....	195	Switching Apple CarPlay On and Off.....	609
Starting and Stopping the Engine – Troubleshooting.....	198	Switching Blind Spot Information System On and Off - Vehicles With: 4.2 Inch Screen.....	293
Starting and Stopping the Engine – Frequently Asked Questions.....	200	Switching Blind Spot Information System On and Off - Vehicles With: 8 Inch Screen.....	294
Starting and Stopping the Engine – Information Messages.....	199	Switching Climate Control On and Off.....	149
Starting and Stopping the Engine – Warning Lamps.....	198	Switching Cross Traffic Alert On and Off - Vehicles With: 4.2 Inch Screen.....	299
Starting the Engine.....	192	Switching Cross Traffic Alert On and Off - Vehicles With: 8 Inch Screen.....	299
Restarting the Engine After Stopping it.....	194	Switching Cruise Control On and Off.....	270
Starting a Diesel Engine.....	193	Switching Defrost On and Off.....	149
Starting a Gasoline Engine.....	192	Switching Driver Alert On and Off - Vehicles With: 4.2 Inch Screen.....	310
Status Bar.....	597	Switching Driver Alert On and Off - Vehicles With: 8 Inch Screen.....	310
Steering.....	256	Switching Easy Entry and Exit On and Off.....	93
Hydraulic Power Steering.....	256	Switching From Adaptive Cruise Control to Cruise Control - Vehicles With: 2.3 Inch Screen.....	278
Steering – Troubleshooting.....	258	Switching From Adaptive Cruise Control to Cruise Control - Vehicles With: 4.2 Inch Screen.....	278
Steering – Troubleshooting.....	258	Switching From Adaptive Cruise Control to Cruise Control - Vehicles With: 8 Inch Screen.....	278
Steering – Information Messages.....	259	Switching Hill Descent Control On and Off.....	254
Steering – Warning Indicators.....	258	Switching Maximum Cooling On and Off.....	150
Steering Wheel.....	111	Switching Maximum Defrost On and Off.....	149
Steering Wheel - Vehicles With: SYNC 3.....	30	Switching Pre-Collision Assist On and Off - Vehicles With: 2.3 Inch Screen.....	302
Steering Wheel - Vehicles With: SYNC 4.....	29	Switching Pre-Collision Assist On and Off - Vehicles With: 4.2 Inch Screen.....	303
Stopping the Engine.....	195		
Stopping the Engine When Your Vehicle is Moving.....	196		
Stopping the Engine When Your Vehicle is Stationary.....	195		
Storage.....	187		
Center Console.....	188		
Cup Holders.....	187		
Glasses Holder.....	190		
Glove Compartment.....	187		
Under Seat Storage.....	188		
Storing Your Vehicle.....	427		
Sunroof			
See: Moonroof.....	131		
Switching Adaptive Cruise Control On and Off.....	275		
Switching Air Conditioning On and Off.....	149		
Switching All of the Interior Lamps On and Off.....	124		



# Index

Switching Pre-Collision Assist On and Off - Vehicles With: 8 Inch Screen.....	303
Switching Rear Occupant Alert System On and Off - Vehicles With: SYNC 3.....	172
Switching Rear Occupant Alert System On and Off - Vehicles With: SYNC 4.....	172
Switching Rear Occupant Alert System On and Off - Vehicles With: SYNC.....	171
Switching Recirculated Air On and Off.....	149
Switching Repeat Mode On and Off.....	526
Switching Shuffle Mode On and Off.....	526
Switching Stability Control On and Off.....	250
Switching Text Message Notification On and Off.....	606
Switching the Audio Unit On and Off.....	525
Switching the Display On and Off.....	528
Switching the Electronic Locking Differential On and Off - 4x2.....	238
Switching the Electronic Locking Differential On and Off - 4x4.....	237
Switching the Front Interior Lamps On and Off.....	124
Switching the Hazard Flashers On and Off.....	379
Switching the Heated Mirrors On and Off.....	155
Switching the Heated Rear Window On and Off.....	150
Switching the Heated Steering Wheel On and Off.....	112
Switching the Lane Keeping System On and Off - Vehicles With: 4.2 Inch Screen.....	287
Switching the Lane Keeping System On and Off - Vehicles With: 8 Inch Screen.....	288
Switching the Passenger Airbag On and Off.....	60
Switching the Rear Interior Lamps On and Off.....	124
Switching Traction Control On and Off.....	247
Switching Trail Control On and Off.....	252
Switching Trailer Backup Assistance On and Off.....	346
Switching Trailer Reverse Guidance On and Off.....	362
Switching Trailer Sway Control On and Off.....	338
Symbols Glossary.....	21
Symbols Used on Your Vehicle.....	21
SYNC™ 3.....	552
General Information.....	552
SYNC™ 3 Troubleshooting.....	584
SYNC™ Applications and Services.....	540
SYNC™.....	536
General Information.....	536
SYNC™ Troubleshooting.....	542

## T

Tailgate Anchor Points.....	319
Locating the Tailgate Anchor Points.....	319
Tailgate Anchor Point Load Capacities.....	319
Tailgate Precautions.....	94
Tailgate Step.....	95
Accessing the Tailgate Step.....	95
Stowing the Tailgate Step.....	96
Tailgate.....	94
Bed Extender.....	96
Opening the Tailgate.....	94
Tailgate Step.....	95
Tailgate – Troubleshooting.....	104
Tailgate – Troubleshooting.....	104
Tailgate – Frequently Asked Questions.....	105
Tailgate – Information Messages.....	104
Technical Specifications See: Capacities and Specifications.....	467
The Better Business Bureau Auto Line Program - United States of America.....	640
The Mediation and Arbitration Program - Canada.....	641
Tire Care.....	441

# Index

Tire Pressure Monitoring System	
Limitations.....	449
Tire Pressure Monitoring System	
Overview.....	448
Tire Pressure Monitoring System	
Precautions.....	449
Tire Pressure Monitoring System.....	448
Tire Pressure Monitoring System –	
Troubleshooting.....	453
Tire Pressure Monitoring System –	
Troubleshooting.....	453
Tire Pressure Monitoring System –	
Information Messages.....	454
Tire Pressure Monitoring System – Warning	
Lamps.....	453
Tire Replacement Requirements.....	436
Tire Rotation.....	446
Towing a Trailer Limitations.....	329
Towing a Trailer Precautions.....	328
Towing a Trailer.....	328
Towing a Trailer – Troubleshooting.....	333
Towing Weights and Dimensions.....	331
Towing a Trailer –	
Troubleshooting.....	333
Towing a Trailer – Information	
Messages.....	333
Towing Weights and Dimensions.....	331
Calculating the Maximum Loaded Trailer	
Weight for Your Vehicle.....	332
Recommended Towing Weights.....	331
What Is the Maximum Loaded Trailer	
Weight.....	332
Towing Your Vehicle Precautions.....	384
Towing Your Vehicle.....	384
Towing Your Vehicle –	
Troubleshooting.....	386
Towing Your Vehicle –	
Troubleshooting.....	386
Towing Your Vehicle – Information	
Messages.....	386
Traction Control Indicator.....	247
Traction Control.....	247
Traction Control – Troubleshooting.....	248
Traction Control –	
Troubleshooting.....	248
Traction Control – Information	
Messages.....	248
Trail Control Indicators.....	252
Trail Control.....	252
Trail Control – Troubleshooting.....	253
Trail Control – Troubleshooting.....	253
Trail Control – Information	
Messages.....	253
Trailer Backup Assistance	
Precautions.....	339
Trailer Backup Assistance.....	339
Setting Up the Trailer Backup Assistance	
for a Conventional Trailer.....	339
Setting Up the Trailer Backup Assistance	
for a Fifth-Wheel or Gooseneck	
Trailer.....	343
Trailer Backup Assistance –	
Troubleshooting.....	349
Trailer Backup Assistance –	
Troubleshooting.....	349
Trailer Backup Assistance – Frequently	
Asked Questions.....	352
Trailer Backup Assistance – Information	
Messages.....	349
Trailer Brake Precautions.....	328
Trailer Reverse Guidance	
Precautions.....	357
Trailer Reverse Guidance.....	357
Setting Up Trailer Reverse Guidance for a	
Conventional Trailer.....	357
Setting Up Trailer Reverse Guidance for a	
Fifth-Wheel or Gooseneck Trailer.....	360
Trailer Reverse Guidance –	
Troubleshooting.....	364
Trailer Reverse Guidance –	
Troubleshooting.....	364
Trailer Reverse Guidance – Frequently	
Asked Questions.....	366
Trailer Reverse Guidance – Information	
Messages.....	364
Trailer Sway Control Precautions.....	338
Trailer Sway Control.....	338
Trailer Towing Hints.....	329
Trailer Towing Navigation.....	612
Transfer Case Fluid Capacity and	
Specification.....	490
Transporting the Vehicle.....	383
Trip Computer.....	145
Trip Data.....	145

# Index

<b>U</b>	
Under Hood Fuse Box.....387	
Accessing the Under Hood Fuse Box.....387	
Identifying the Fuses in the Under Hood Fuse Box.....388	
Locating the Under Hood Fuse Box.....387	
Under Hood Overview - 6.2L.....397	
Under Hood Overview - 6.7L	
Diesel.....398	
Under Hood Overview - 7.3L.....399	
Under Seat Storage.....188	
Locating the Under Seat Storage Compartment.....188	
Updating the Vehicle Systems	
Wirelessly.....613	
USB Ports.....180	
USB Port.....516	
Using a Slide-In Camper.....312	
Using Keyless Entry.....87	
Using MyKey With Remote Start Systems.....80	
Using Snow Chains.....438	
Using SYNC™ With Your Media Player.....542	
Using SYNC™ With Your Phone.....539	
Using the Diesel Engine Exhaust Brake.....244	
Using the Instrument Cluster Display Controls.....141	
Using the Integrated Trailer Brake Controller.....334	
Using the Keyless Entry Keypad.....91	
Using the Remote Control.....69	
Using the Trailer Backup Assistance Controller.....346	
Using the Trailer Backup Assistance Views.....347	
Using This Publication.....20	
Using Trailer Reverse Guidance Views.....363	
Using Voice Recognition.....537	
<b>V</b>	
Vehicle Care.....421	
Cleaning the Exterior.....421	
Cleaning the Interior.....424	
Vehicle Identification Number.....497	
Locating the Vehicle Identification Number.....497	
Vehicle Identification Number Overview.....497	
Vehicle Identification.....497	
Vehicle Identification Number.....497	
Vehicle Interior.....32	
Vehicle System Updates.....613	
Vehicle Wi-Fi Hotspot.....506	
Ventilated Seats.....165	
Switching the Ventilated Seats On and Off.....165	
Ventilated Seat Precautions.....165	
Ventilation	
See: Climate Control - Vehicles With: Automatic Temperature Control.....149	
See: Climate Control - Vehicles With: Manual Temperature Control.....154	
Venting the Moonroof.....131	
Viewing the Tire Pressures.....450	
Visual Search.....29	
Voice Interaction Examples.....600	
Voice Interaction.....600	
<b>W</b>	
Washer Fluid Specification.....485	
Washers.....116	
Adding Washer Fluid.....117	
Switching the Courtesy Wipe On and Off.....117	
Using the Windshield Washer.....117	
Washer Fluid Specification.....117	
Washer Precautions.....116	
Washers	
See: Wipers and Washers.....115	
Waxing Your Vehicle.....426	
Waypoints.....611	
Adding a Waypoint.....611	
Editing Waypoints.....611	
What Are the Auxiliary Switches.....618	
What Are the Instrument Cluster Indicators.....138	
What Are the Instrument Cluster Warning Lamps.....137	
What Is 911 Assist.....67	
What Is a Connected Vehicle.....498	

# Index

What Is Blind Spot Information System.....	293
What Is Cross Traffic Alert.....	298
What Is Cruise Control.....	270
What Is Drive Mode Control.....	281
What Is Driver Alert.....	309
What Is Ford Protect.....	620
What Is Hill Descent Control.....	254
What Is Hill Start Assist.....	246
What Is MyKey.....	77
What Is Pre-Collision Assist.....	301
What Is Remote Start.....	146
What Is the 360 Degree Camera.....	266
What Is the Cabin Air Filter.....	157
What Is the Catalytic Converter.....	223
What Is the Diesel Exhaust Fluid Gauge.....	136
What Is the Diesel Particulate Filter.....	212
What Is the Electronic Locking Differential.....	237
What Is the Engine Coolant Temperature Gauge.....	136
What Is the Engine Oil Pressure Gauge.....	136
What Is the Garage Door Opener.....	176
What Is the Gross Axle Weight Rating.....	312
What Is the Gross Combined Weight Rating.....	313
What Is the Gross Vehicle Weight Rating.....	312
What Is the Integrated Trailer Brake Controller.....	334
What Is the Keyless Entry Keypad.....	89
What Is the Lane Keeping System.....	286
What Is the Memory Function.....	174
What Is the Power Outlet.....	182
What is the Rear Occupant Alert System.....	171
What Is the Rear View Camera.....	263
What Is the Selective Catalytic Reduction System.....	217
What Is the Speedometer.....	135
What Is the Tachometer.....	135
What Is the Tire Pressure Monitoring System.....	448
What Is the Transmission Fluid Temperature Gauge.....	136
What Is the Turbo Boost Gauge.....	136
What Is the Wireless Accessory Charger.....	185
What Is Traction Control.....	247
What Is Trail Control.....	252
What is Trailer Backup Assistance.....	339
What Is Trailer Reverse Guidance.....	357
What is Voice Interaction.....	600
Wheel and Tire Information.....	429
Wheel Nuts.....	465
Window Bounce-Back.....	126
Overriding Window Bounce-Back.....	126
What Is Window Bounce-Back.....	126
Windows.....	126
Window Bounce-Back.....	126
Wipers and Washers – Troubleshooting.....	117
Wipers and Washers – Frequently Asked Questions.....	117
Wipers and Washers – Warning Lamps.....	117
Wipers and Washers.....	115
Autowipers.....	115
Washers.....	116
Wipers.....	115
Wipers and Washers – Troubleshooting.....	117
Wipers.....	115
Switching Windshield Wipers On and Off.....	115
Wiper Precautions.....	115
Wireless Accessory Charger Precautions.....	185
Wireless Accessory Charger.....	185