



FOREWORD

Dear Customer,

Thank you for selecting your new Kia vehicle.

As a global car manufacturer focused on building high-quality vehicles with exceptional value, Kia is dedicated to providing you with a customer service experience that exceeds your expectations.

An authorized Kia dealership where factory-trained technicians, recommended special tools, and genuine Kia replacement parts are provided can help if you need technical assistance.

This Owner's Manual will acquaint you with the operation of features and equipment that are either standard or optional on this vehicle, along with the maintenance needs of this vehicle. Therefore, you may find some descriptions and illustrations not applicable to your vehicle. You are advised to read this publication carefully and follow the instructions and recommendations. Please always keep this manual in the vehicle for your, and any subsequent owner's, reference.

All information contained in this Owner's Manual was accurate at the time of publication. However, as Kia continues to make improvements to its products, the company reserves the right to make changes to this manual or any of its vehicles at any time without notice and without incurring any obligations.

Please drive safely, and enjoy your Kia vehicle!

© 2021 Kia Canada Inc.

All rights reserved. Reproduction by any means, electronic or mechanical, including photocopying, recording, or by any information storage and retrieval system or translation in whole or part is not permitted without written authorization from Kia Canada Inc.

Printed in U.S.A.

How to use this manual

We want to help you get the greatest possible driving pleasure from your vehicle. Your Owner's Manual can assist you in many ways.

We strongly recommend that you read the entire manual. In order to minimize the chance of death or injury, you must read the WARNING and CAUTION sections in the manual.

Illustrations complement the words in this manual to best explain how to enjoy your vehicle. By reading your manual, you learn about features, important safety information, and driving tips under various road conditions.

The general layout of the manual is provided in the of Contents. Use the index when looking for a specific area or subject. The index has an alphabetical listing of all information in your manual.

Chapters: This manual has nine chapters plus an index. Each chapter begins with a brief list of contents so you can tell at a glance if that chapter has the information you want.

You will find various WARNINGS, CAUTIONS, and NOTICES in this manual. These WARNINGS were prepared to enhance your personal safety. You should carefully read

and follow ALL procedures and recommendations provided in these WARNINGS, CAUTIONS and NOTICES.

WARNING

A WARNING indicates a situation in which harm, serious bodily injury or death could result if the warning is ignored.

CAUTION

A CAUTION indicates a situation in which damage to your vehicle could result if the caution is ignored.

NOTICE

A NOTICE indicates interesting or helpful information is being provided.

Table of Contents

Introduction	1
Your vehicle at a glance	2
Safety features of your vehicle	3
Features of your vehicle	4
Driving your vehicle	5
What to do in an emergency	6
Maintenance	7
Specifications & Consumer information	8
Abbreviation	A
Index	I

Fuel requirements	1-2
Vehicle modifications	1-5
Vehicle break-in process	1-5
Risk of burns when parking or stopping vehicle.....	1-6
Vehicle handling instructions	1-6
Vehicle data collection and Event Data Recorders.....	1-7

Introduction

Fuel requirements

Your new vehicle is designed to use only unleaded fuel having a pump octane number $((R+M)/2)$ of 87 (Research Octane Number 91) or higher. (Do not use methanol blended fuels.)

Your new vehicle is designed to obtain maximum performance with UNLEADED FUEL, as well as minimize exhaust emissions and spark plug fouling.

Never add any fuel system cleaning agents to the fuel tank other than what has been specified. (Consult an authorized Kia dealer for details.)

- Tighten the cap until it clicks one time, otherwise the Check Engine



light will illuminate.

⚠ WARNING

Refueling

- Do not "top off" after the nozzle automatically shuts off. Attempts to force more fuel into the tank can cause fuel overflow onto you and the ground causing a risk of fire.
- Always check that the fuel cap is installed securely to prevent fuel spillage, especially in the event of an accident.

Gasoline containing alcohol and methanol

Gasohol, a mixture of gasoline and ethanol (also known as grain alcohol), and gasoline or gasohol containing methanol (also known as wood alcohol) are being marketed along with or instead of leaded or unleaded gasoline.

Do not use gasohol containing more than 15% ethanol, and do not use gasoline or gasohol containing any methanol.

Either of these fuels may cause drivability problems and damage to the fuel system, engine control system and emission control system.

Discontinue using gasohol of any kind if drivability problems occur.

Vehicle damage or drivability problems may not be covered by the manufacturer's warranty if they result from the use of:

1. Gasoline or gasohol containing methanol.
2. Leaded fuel or leaded gasohol.
3. Gasohol containing more than 15% ethanol.

"E85" fuel is an alternative fuel comprised of 85% ethanol and 15% gasoline, and is manufactured exclusively for use in Flexible Fuel Vehicles. "E85" is not compatible with your vehicle. Use of "E85" may result in poor engine performance

and damage to your vehicle's engine and fuel system. Kia recommends that customers do not use fuel with an ethanol content exceeding 15%.

* NOTICE

Your New Vehicle Limited Warranty does not cover damage to the fuel system or any performance problems caused by the use of "E85" fuel.

* NOTICE

Never use any fuel containing methanol. Discontinue use of any methanol containing product which may inhibit proper drivability.

Other fuels

Using fuels that contain Silicone (Si), MMT (Manganese, Mn), Ferrocene (Fe), and Other metallic additives, may cause vehicle and engine damage or cause misfiring, poor acceleration, engine stalling, catalyst melting, clogging, abnormal corrosion, life cycle reduction, etc.

Also, the Malfunction Indicator Lamp (MIL) may illuminate.

* NOTICE

Damage to the fuel system or performance problem caused by the use of these fuels may not be cov-

ered by your New Vehicle Limited Warranty.

Use of MTBE

Kia recommends avoiding fuels containing MTBE (Methyl Tertiary Butyl Ether) over 15.0% vol. (Oxygen Content 2.7% weight) in your vehicle.

Fuel containing MTBE over 15.0% vol. (Oxygen Content 2.7% weight) may reduce vehicle performance and produce vapor lock or hard starting.

* NOTICE

Your New Vehicle Limited Warranty may not cover damage to the fuel system and any performance problems that are caused by the use of fuels containing methanol or fuels containing MTBE (Methyl Tertiary Butyl Ether) over 15.0% vol. (Oxygen Content 2.7% weight.)

Gasoline containing MMT

Some gasoline contains harmful manganese- based fuel additives Such as MMT (Methylcyclopentadienyl Manganese Tricarbonyl). Kia does not recommend the use of gasoline containing MMT. This type of fuel can reduce vehicle performance and affect your emission control system. The Malfunction

Indicator Lamp (MIL) on the cluster may come on.

Do not use methanol

Fuels containing methanol (wood alcohol) should not be used in your vehicle. This type of fuel can reduce vehicle performance and damage components of the fuel system, engine control system and emission control system.

Fuel Additives

Kia recommends that you use good quality gasolines treated with detergent additives such as TOP TIER Detergent Gasoline, which help prevent deposit formation in the engine. These gasolines will help the engine run cleaner and enhance performance of the emission control system.

For more information on TOP TIER Detergent Gasoline, please go to the website (www.toptiergas.com) For customers who do not use TOP TIER Detergent Gasoline regularly, and have problems starting or the engine does not run smoothly, additives that you can buy separately may be added to the gasoline.

If TOP TIER Detergent Gasoline is not available, one bottle of additive should be added to the fuel tank at every 12,000 km (7,500 miles) or every engine oil change is recom-

mended. Additives are available from your authorized Kia dealer along with information on how to use them. Do not mix other additives.

Operation in foreign countries

If you are going to drive your vehicle in another country, be sure to:

- Observe all regulations regarding registration and insurance.
- Determine that accep fuel is available.

Vehicle modifications

This vehicle should not be modified.

Modification of your vehicle could affect its performance, safety or durability and may even violate governmental safety and emissions regulations. In addition, damage or performance problems resulting from any modification may not be covered under warranty.

- If you use unauthorized electronic devices, it may cause the vehicle to operate abnormally, wire damage, battery discharge and fire.

For your safety, do not use unauthorized electronic devices.

Vehicle break-in process

By following a few simple precautions for the first 1,000 km (600 miles) you may add to the performance, economy and life of your vehicle.

- Do not race the engine.
- While driving, keep your engine speed (rpm, or revolutions per minute) between 2,000 rpm and 4,000 rpm.
- Do not maintain a single speed for long periods of time, either fast or slow. Varying engine speed is needed to properly break-in the engine.
- Avoid hard stops, except in emergencies, to allow the brakes to seat properly.
- Don't tow a trailer during the first 2,000 km (1,200 miles) of operation.
- Fuel economy and engine performance may vary depending on vehicle break-in process and be stabilized after 6,000 km (4,000 miles). New engines may consume more oil during the vehicle break-in period.

Risk of burns when parking or stopping vehicle

- Do not park or stop the vehicle near flammable items such as leaves, paper, oil, and tire. Such items placed near the exhaust system can become a fire hazard.
- When an engine idles at a high rpm with the rear side of the vehicle in close proximity of the wall, heat of the exhaust gas can cause discoloration or fire. Keep enough space between the rear part of the vehicle and the wall.
- Be sure not to touch the exhaust/catalytic systems while the engine is running or right after the engine is turned off. There is a risk of burns since the systems are extremely hot.

Vehicle handling instructions

As with other vehicles of this type, failure to operate this vehicle correctly may result in loss of control, an accident or vehicle rollover. Specific design characteristics (higher ground clearance, track, etc.) give this vehicle a higher center of gravity than other types of vehicles. In other words they are not designed for cornering at the same speeds as conventional 2-wheel drive vehicles. Avoid sharp turns or abrupt maneuvers. Again, failure to operate this vehicle correctly may result in loss of control, an accident or vehicle rollover. Be sure to read the "Reducing the risk of a rollover" on page 5-146 of this manual.

Vehicle data collection and Event Data Recorders

This vehicle is equipped with an event data recorder (EDR). The main purpose of an EDR is to record, in certain crash or near crash-like situations, such as an air bag deployment or hitting a road obstacle, data that will assist in understanding how a vehicle's systems performed. The EDR is designed to record data related to vehicle dynamics and safety systems for a short period of time, typically 30 seconds or less. The EDR in this vehicle is designed to record such data as:

- How various systems in your vehicle were operating;
- Whether or not the driver and passenger safety belts were buckled/fastened;
- How far (if at all) the driver was depressing the accelerator and/or brake pedal; and,
- How fast the vehicle was traveling.

These data can help provide a better understanding of the circumstances in which crashes and injuries occur. NOTE: EDR data are recorded by your vehicle only if a non-trivial crash situation occurs; no data are recorded by the EDR under normal driving conditions and no personal data (e.g., name, gen-

der, age, and crash location) are recorded. However, other parties, such as law enforcement, could combine the EDR data with the type of personally identifying data routinely acquired during a crash investigation.

To read data recorded by an EDR, special equipment is required, and access to the vehicle or the EDR is needed. In addition to the vehicle manufacturer, other parties, such as law enforcement, that have the special equipment, can read the information if they have access to the vehicle or the EDR.

Exterior overview.....	2-2
Interior overview.....	2-5
Instrument panel overview	2-7
Engine compartment	2-9

Your vehicle at a glance

Exterior overview

Front view



00N011001L

* The actual shape may differ from the illustration.

1. Hood	4-42
2. Head lamp (Features of your vehicle)	4-120
Head lamp (Maintenance)	7-63
3. Front fog lamp (Features of your vehicle)	4-124
Front fog lamp (Maintenance)	7-65
4. Wheel and tire (Maintenance)	7-34
Wheel and tire (Specification)	8-5
5. Outside rearview mirror	4-67
6. Dual Wide Sunroof	4-48
Sunroof	4-54

7. Front windshield wiper blades (Features of your vehicle)	4-129
Front windshield wiper blades (Maintenance)	7-28
8. Windows	4-37
9. Front ultrasonic sensors	4-114

Rear view



00N011002L

* The actual shape may differ from the illustration.

1. Door locks	4-16
2. Fuel filler door	4-44
3. Rear combination lamp (Maintenance)	7-66, 7-67
4. High Mounted Stop Lamp (Maintenance)	7-67
5. Rear window wiper blade	4-130, 7-30
6. Liftgate	4-24, 4-27
7. Antenna	4-175
8. Liftgate open switch	4-24, 4-28
9. Rear view camera	4-108
10. Rear ultrasonic sensors	4-111, 4-114

Interior overview



OON011003L

* The actual shape may differ from the illustration.

1. Inside door handle	4-18
2. Driver position memory button	3-12
3. Outside rearview mirror folding	4-68
4. Outside rearview mirror selection	4-68
5. Outside rearview mirror control	4-68
6. Central Door lock/unlock switch	4-18
7. Power window switch	4-39
8. Power window lock switch	4-40
Electronic Child Safety Lock switch	4-20
9. Instrument panel illumination control switch	4-72
10. Blind-Spot Safety button	5-72
11. Lane Safety button	5-66
12. ESC Off button	5-37

13.Liftgate open/close button	4-28, 4-29
14.Steering wheel	4-58
15.Tilt and telescopic steering control lever	4-60
16.Brake pedal	5-26
17.Hood release lever	4-42
18.Inner fuse panel	7-48
19.Seat	3-5

Instrument panel overview



* The actual shape may differ from the illustration.

1. Driver's front air bag	3-65
2. Horn	4-61
3. Instrument cluster	4-71
4. Wiper and washer control lever	4-127
5. ENGINE START/STOP button	5-8
6. Driving Assist button	5-91
7. Hazard warning flasher	6-3
8. Climate control system	4-136, 4-140
9. Shift lever	5-12
10. Front seat warmer switch	4-161
11. Front seat air ventilation switch	4-162
12. Power outlet	4-164
13. USB port	4-175

14.USB charger	4-165
15.AWD mode dial	5-19
Drive mode dial	5-47
16.AUTO HOLD button	5-32
17.EPB switch	5-28
18.Parking Safety button	4-114
19.Parking/View button	4-109
20.ISG system Off button	5-44
21.AC inverter	4-166
22.Center console storage box	4-158
23.Cup holder	4-159
24.Glove box	4-158
25.Passenger's front air bag	3-65
26.Lighting control lever	4-121

Engine compartment

(Gasoline) 3.8 GDi



00N071001L

* The actual engine cover in the vehicle may differ from the illustration.

1. Engine coolant reservoir	7-20
2. Engine oil filler cap	7-18
3. Brake fluid reservoir	7-22
4. Air cleaner	7-25
5. Fuse box	7-49
6. Negative battery terminal	6-7, 7-31
7. Positive battery terminal	6-7, 7-31
8. Engine oil dipstick	7-18
9. Radiator cap	6-8, 7-20
10. Windshield washer fluid reservoir	7-24

Safety features of your vehicle **3**

Important safety precautions	3-3
Seat	3-5
• Feature of Seat Leather	3-9
• Front seat adjustment for manual seat	3-9
• Front seat adjustment for power seat	3-10
• Driver position memory system for power seat	3-12
• Headrest for front seat.....	3-15
• Seatback pocket	3-18
• Seatback hook.....	3-18
• Headrest for rear seat	3-19
• Armrest.....	3-21
• Folding the rear seat.....	3-21
Seat belts	3-27
• Seat belt restraint system	3-27
• Driver's seat belt warning.....	3-28
• Front passenger's seat belt warning	3-29
• Seat belt - Driver's 3-point system with emergency locking retractor	3-30
• Seat belts - Front passenger and rear seat 3-point system with combination locking retractor	3-31
• Rear center seat belt (3rd row).....	3-35
• Pre-tensioner seat belt.....	3-37
• Seat belt precautions.....	3-39
• Care of seat belts	3-41
Child Restraint System (CRS)	3-42
• Children always in the rear	3-42
• Selecting a CRS	3-43
• Installing a CRS.....	3-45
Air bag - advanced Supplemental Restraint System	3-53

3 Safety features of your vehicle

- How does the air bag system operate? 3-54
- Do not install a child restraint on the front passenger's seat 3-55
- Air bag warning light..... 3-56
- Supplemental Restraint System (SRS) components and functions 3-56
- Occupant Detection System (ODS)..... 3-59
- Driver's and passenger's front air bag..... 3-65
- Side air bag 3-68
- Curtain air bag..... 3-69
- Air bag collision sensors 3-71
- Why didn't my air bag go off in a collision? (Inflation and non-inflation conditions of the air bag)..... 3-72
- Supplemental Restraint System (SRS) care 3-75
- Adding equipment to or modifying your air bag-equipped vehicle 3-76
- Air bag warning label 3-76

Safety features of your vehicle

For the safety of the driver and vehicle passengers, you should become familiar with the vehicle's safety features.

Important safety precautions

You will find many safety precautions and recommendations throughout this section, and throughout this manual.

The safety precautions in this section are among the most important.

Always wear your seat belt

A seat belt is your best protection in all types of accidents. Air bags are designed to supplement seat belts, not replace them. So even though your vehicle is equipped with air bags, ALWAYS make sure you and your passengers wear your seat belts, and wear them properly.

Restrain all children

All children under age 13 should ride in your vehicle properly restrained in a rear seat, not the front seat. Infants and small children should be restrained in an appropriate child restraint. Larger children should use a booster seat with the lap/shoulder belt until they can use the seat belt properly without a booster seat.

Air bag hazards

While air bags can save lives, they can also cause serious or fatal injuries to occupants who sit too close to them, or who are not properly restrained. Infants, young children, and shorter adults are at the greatest risk of being injured by an inflating air bag. Follow all instructions and warnings in this manual.

Driver distraction

Driver distraction presents a serious and potentially deadly danger, especially for inexperienced drivers. Safety should be the first concern when behind the wheel and drivers need to be aware of the wide array of potential distractions, such as drowsiness, reaching for objects, eating, personal grooming, other passengers, and using cellular phones.

Drivers can become distracted when they take their eyes and attention off the road or their hands off the wheel to focus on activities other than driving. To reduce your risk of distraction or getting into an accident:

- ALWAYS set up your mobile devices (i.e., MP3 players, phones, navigation units, etc.) when your vehicle is parked or safely stopped.

- ONLY use your mobile device when allowed by laws and when conditions permit safe use. NEVER text or email while driving. Most countries have laws prohibiting drivers from texting. Some countries and cities also prohibit drivers from using handheld phones.
- NEVER let the use of a mobile device distract you from driving. You have a responsibility to your passengers and others on the road to always drive safely, with your hands on the wheel as well as your eyes and attention on the road.

Control your speed

Excessive speed is a major factor in crash injuries and deaths. Generally, the higher the speed, the greater the risk, but serious injuries can also occur at lower speeds. Never drive faster than is safe for current conditions, regardless of the maximum speed posted.

Keep your vehicle in safe condition

Having a tire blowout or a mechanical failure can be extremely hazardous. To reduce the possibility of such problems, check your tire pressures and condition frequently, and perform all regularly scheduled maintenance.

Seat

8 Seats

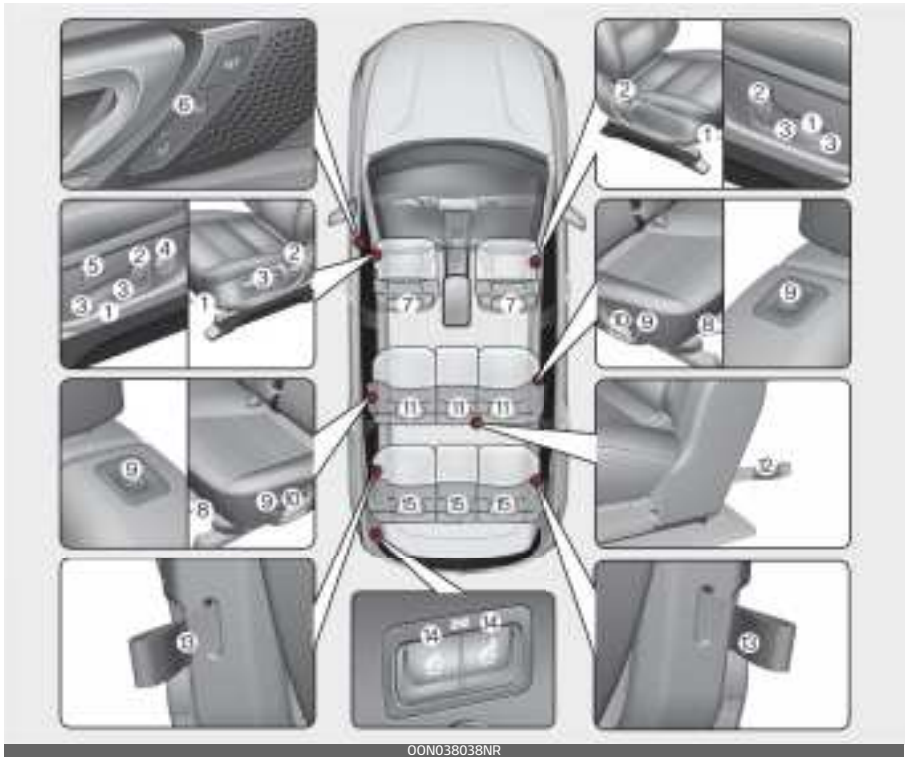

OON038038NR

Front seat

1. Forward and backward
2. Seatback angle
3. Seat cushion height*
4. Lumbar support (Driver's seat)*
5. Cushion extension (Driver's seat)*
6. Driver position memory system*
7. Headrest

2nd row seat

8. Forward and backward
9. Walk-in switch
10. Seatback angle

11. Headrest

12. Walk-in strap for emergency

3rd row seat

13. Seatback angle strap
14. 2nd row seat remote folding button
15. Headrest

*: if equipped

7 Seats

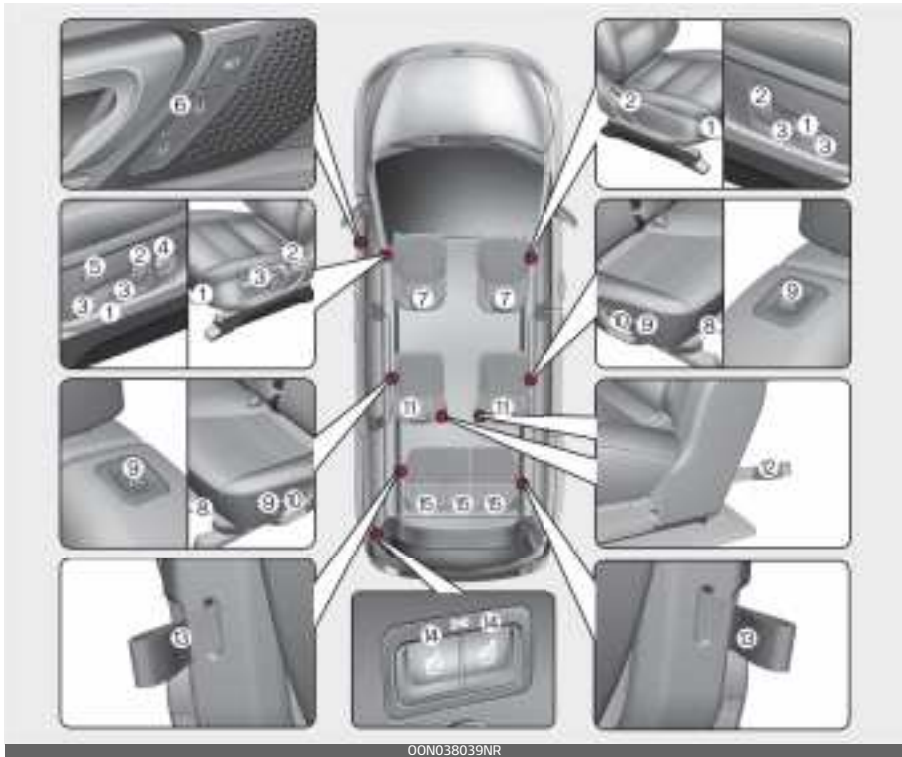

Front seat

- 1. Forward and backward
- 2. Seatback angle
- 3. Seat cushion height*
- 4. Lumbar support (Driver's seat)*
- 5. Cushion extension (Driver's seat)*
- 6. Driver position memory system*
- 7. Headrest

2nd row seat

- 8. Forward and backward
- 9. Walk-in switch
- 10. Seatback angle
- 11. Headrest
- 12. Walk-in strap for emergency

3rd row seat

- 13. Seatback angle strap
- 14. 2nd row seat remote folding button
- 15. Headrest

* : if equipped

⚠ WARNING

Loose objects

Do not place anything in the driver's footwell or under the front seats. Loose objects in the driver's foot

area could interfere with the operation of the foot pedals.

⚠ WARNING

Uprighting seat

Do not press the release lever on a manual seatback without holding and controlling the seatback. The seatback will spring upright possibly impacting you or other passengers.

⚠ WARNING

Driver responsibility for passengers



The driver must advise the passengers to keep the seatback in an upright position whenever the vehicle is in motion. If a seat is reclined during an accident, the restraint system's ability to restrain will be greatly reduced.

⚠ WARNING

Seat cushion

Occupants should never sit on after-market seat cushions or sitting cushions. The passenger Occupant Detection System may not operate properly, or passenger's hips may slide under the lap portion of the seat belt during an accident or a sudden stop.

⚠ WARNING

Driver's seat

- Never attempt to adjust the seat while the vehicle is moving. This could result in loss of control of your vehicle.
- Do not allow anything to interfere with the normal position of the seatback. Storing items against the seatback could result in serious or fatal injury in a sudden stop or collision.
- Sit as far back as possible from the steering wheel while still maintaining control of the your vehicle. A distance of at least 25 cm (10 inches) from your chest to the steering wheel is recommended. Failure to do so can result in air bag inflation injuries to the driver.

⚠ WARNING**Rear seatbacks**

Always lock the rear seatback before driving. Failure to do so could result in passengers or objects being thrown forward injuring vehicle occupants.

⚠ WARNING**Unexpected Seat Movement**

After adjusting a manual seat, always check that it is locked by shifting your weight to the front and back. Sudden or unexpected movement of the driver's seat could cause you to lose control of the vehicle.

⚠ WARNING**Seat adjustment**

- Do not adjust the seat while wearing seat belts. Moving the seat forward will cause strong pressure on the abdomen.
 - Do not place your hand near the seat bottom or seat track while adjusting the seat. Your hand could get caught in the seat mechanism.
-

⚠ WARNING**Luggage and Cargo**

Do not stack/pile luggage or cargo higher than the seatback in the cargo area. In an accident the cargo could strike and injure a passenger. If objects are large, heavy or must be piled, they must be secured in the cargo area.

⚠ WARNING**Cargo Area**

Do not allow passengers to ride in the cargo area under any circumstance. The cargo area is solely for the purpose of transporting luggage or cargo.

⚠ WARNING**Small Objects**

Use extreme caution when picking up small objects trapped under the seats or between the seat and the center console. Your hands might be cut or injured by the sharp edges of the seats mechanism.

Feature of Seat Leather

Leather is made from the outer skin of an animal, which goes through a special process to be available for use. Since it is a natural substance, each part differs in thickness or density.

- Wrinkles may appear as a natural result of stretching and shrinking depending on the temperature and humidity.
- The seat cover is made of stretchable material to improve comfort of passengers.
- The parts contacting the body are curved and the side supporting area is high which provides driving comfort and stability.

⚠ CAUTION

- Belts with metallic accessories, zippers or keys inside the back pocket may damage the seat fabric.
- Make sure not to wet the seat. It may change the nature of natural leather.
- Jeans or clothes which contain bleach may contaminate the surface of the seat covering fabric.

* NOTICE

Wrinkles or abrasions may appear naturally from usage. It is not a

fault of product. Wrinkles or abrasions are not covered by warranty.

Front seat adjustment for manual seat

The front seat can be adjusted by using the control levers located on the outside of the seat cushion.



Moving forward and backward

Adjust the seat before driving, and make sure the seat is locked securely by trying to move forward and backward without using the lever. If the seat moves, it is not locked properly.

To move the seat forward or backward:

1. Pull the seat slide adjustment lever up and hold it.
2. Slide the seat to the position you desire.
3. Release the lever and make sure the seat is locked in place.

Reclining seatback

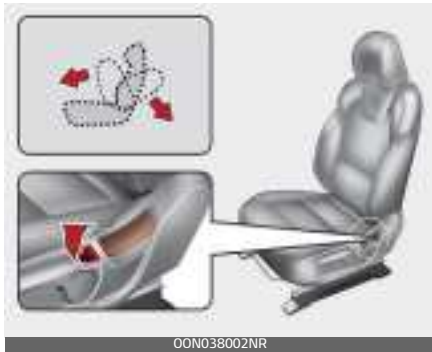

To recline the seatback:

1. Lean forward slightly and lift up the seatback recline lever.
2. Carefully lean back on the seat and adjust the seatback of the seat to the position you desire.
3. Release the lever and make sure the seatback is locked in place. (The lever **MUST** return to its original position for the seatback to lock.)

⚠ WARNING

Reclining seatback

Sitting in a reclined position when the vehicle is in motion can be dangerous. Even when buckled up, the protections of your restraint system (seat belts and/or air bags) is greatly reduced by reclining your seatback.

Seat belts must be snug against your hips and chest to work properly. When the seatback is reclined, the shoulder belt cannot do its job because it will not be snug against

your chest. Instead, it will be in front of you. During an accident, you could be thrown into the seat belt, causing neck or other injuries.

The more the seatback is reclined, the greater chance the passenger's hips will slide under the lap belt or the passenger's neck will strike the shoulder belt.

Changing seat cushion height (if equipped)

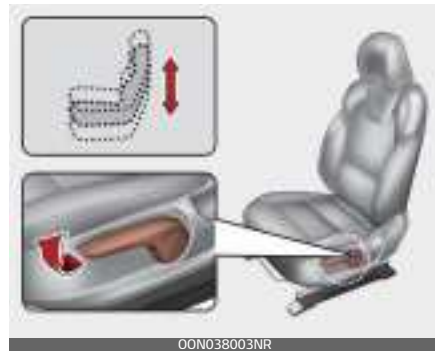

To change the height of the seat cushion, push the lever upwards or downwards.

- To lower the seat cushion, push down the lever several times.
- To raise the seat cushion, pull up the lever several times.

Front seat adjustment for power seat (if equipped)

The front seat can be adjusted by using the control switches located on the outside of the seat cushion.

Before driving, adjust the seat to the proper position so you can easily control the steering wheel, pedals and switches on the instrument panel.

CAUTION

Power seating adjustments

- The power seating controls function by electronic motor. Excessive operation may cause damage to the electrical equipment.
- Do not operate two or more power seat control switches at the same time. Doing so may damage the power seat motor or electrical components.

Reclining seatback



To recline the seatback:

1. Push the control switch forward or backward to move the seatback to the desired angle
2. Release the switch once the seat reaches the desired position.

Moving forward and backward

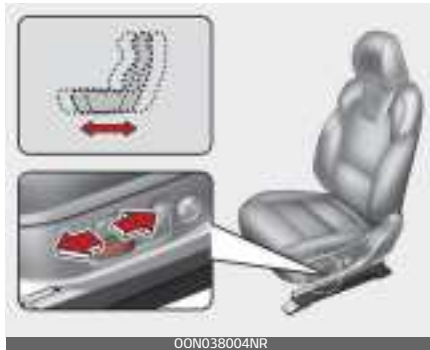

To move the seat forward or backward:

1. Push the control switch forward or backward to move the seat to the desired position.
2. Release the switch once the seat reaches the desired position.

Changing seat cushion tilt and height

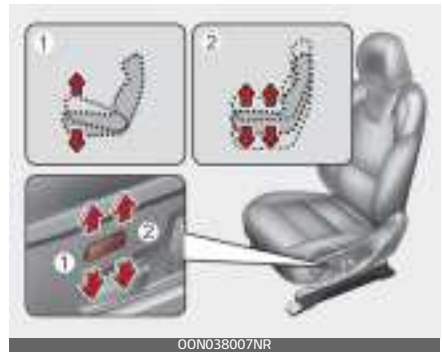

To change the height of the seat:

1. Pull the front portion (1) of the control switch up to raise or press down to lower the front part of the seat cushion.

2. Pull the rear portion (2) of the control switch up to raise or press down to lower the seat cushion.
3. Release the switch once the seat reaches the desired position.

Adjusting lumbar support for driver's seat (if equipped)



The lumbar support can be adjusted by pressing the lumbar support switch on the side of the seat.

1. Press the front portion of the switch to increase support, or the rear portion of the switch, to decrease support.
2. Release the switch once it reaches the desired position.

Adjusting cushion extension for driver's seat (if equipped)



1. Press the front portion of the switch to raise the cushion extension, or the rear portion of the switch to lower it.
2. Release the switch once the cushion extension reaches the desired position.

Driver position memory system for power seat (if equipped)

A driver position memory system is provided to store and recall the driver seat and outside rearview mirror position with a simple button operation.



By saving the desired position into the system memory, different drivers can reposition the driver seat based upon their driving preference. If the battery is disconnected, the desired seat position memory will need to be re-saved.

⚠ WARNING

Driver position memory system

Never attempt to operate the driver position memory system while the vehicle is moving.

This could result in loss of control, and an accident causing death or serious injury.

⚠ CAUTION

The driver position memory system requires a large amount of electric power.

Refrain from using the system when the engine is stopped to prevent battery discharge.

Storing driver's seat positions

1. Place the Engine Strat/Stop button is ON while the vehicle stop.
2. Adjust the driver's seat and outside rearview mirror comfor for the driver.
3. Press SET button on the control panel. The system will beep once.
4. Press one of the memory buttons (1 or 2) within 4 seconds after

pressing the SET button. The system will beep twice when memory has been successfully stored.

When recalling an adjustment memory button while sitting in the vehicle, you can be surprised by the setting chosen if the memory has been adjusted by someone else. If that occurs, immediately push the seat position control switch in the direction of the desired position to stop further undesired movement.

Recalling positions from memory

Operate the following steps while the vehicle is stopped:

- To recall a position already stored in the memory, press the desired memory button (1 or 2). The system will beep once, then the driver's seat will automatically adjust to the stored position.

If you adjust the control switch for the driver's seat while the system is recalling the stored position, the seat will stop and then move in the direction that the control switch is moved.

Setting the easy access function (if equipped)

The driver position memory system will move the driver's seat automatically as follows:

The driver can turn off or set the driver's seat settings in the user

settings mode in the instrument cluster.

1. Press the MODE button  several times on the steering wheel until 'User Settings' menu appears on the LCD.
 2. Select 'Convenience → Seat Easy Access → OFF/Normal/Extend' and 'Convenience → Seat upward/downward' with the MOVE switch (∧ / ∨) and the OK button on the steering wheel.
- It will move the driver's seat rearward when the ENGINE START/STOP button is changed to the OFF position.
 - It will move the driver's seat forward when the ENGINE START/STOP button is changed to the ACC or START position and front driver's door is opened.
 - It will move the driver's seat forward and upward when the ENGINE START/STOP button is in ON. It will move the driver's seat backward and downward when the ENGINE START/STOP button is in OFF.

You can activate or deactivate this feature. Refer to "User Settings mode" on page 4-79.

WARNING

Upward/downward movement of the seat may not work when passengers get on/off the vehicle in

order to prevent foot injuries in certain places.

Resetting the driver position memory system

If the driver position memory system reset fails to work, initialize the system as follows.

How to initialize:

1. Stop the car and open the driver's door with the ENGINE START/STOP button in ON and the automatic shift lever in P (parking) position.
2. Pull the driver's seat forward as far as possible and have the seatback upright as much as possible using driver's seat forward/backward adjustment and seatback angle (recline) movement switches.
3. Push SET button and seat forward movement switch button for 2 seconds simultaneously.

Initialization in the process:

1. Initialization begins as the alarm sounds.
2. The seat and seatback will automatically move backwards. The alarm sound will continue while the system is in operation.
3. Initialization will be all set after the seat and seatback move to the center with alarm sound being raised.

However, the initialization process will come to a stop and the alarm sound will stop as well.

- When pushing driving position memory system button
- When pushing driver's seat height adjustment switch
- When the driving speed exceeds 3 km/h (2 mph)
- When the driver's door is closed

* NOTICE

- When the operation of the driver's seat and alarm sound stop during the initialization process, start the process again.
- Make sure that there are no obstacles around the driver's seat before starting initialization.
- When the initialization is finished, adjust the seat to a position comfortable for the driver and save it to the driver position memory system.

Headrest for front seat

The driver's and front passenger's seats are equipped with a headrest for the occupant's safety and comfort.



00N03B108NR

The headrest not only provides comfort for the driver and front passenger, but also helps protect the head and neck in the event of a rear collision.

For maximum effectiveness in case of an accident, the headrest should be adjusted so the middle of the headrest is as high as the center of gravity of an occupant's head. Generally, the center of gravity of most people's head is similar with the height of the top of their eyes.

Also, adjust the headrest as close to your head as possible. For this reason, the use of a cushion that holds the body away from the seatback is not recommended.

⚠ WARNING

Headrest removal/adjustment

- Do not operate the vehicle with the headrests removed. Headrests can provide critical neck and head support in a crash.

- Do not adjust the headrest height while the vehicle is in motion. Driver may lose control of the vehicle.

⚠ CAUTION

Excessive pulling or pushing may damage the headrest.



Adjusting the height up and down



To raise the headrest:

1. Pull it up to the desired position (1).
2. To lower the headrest, push and hold the release button (2) on the headrest support.
3. Lower the headrest to the desired position (3).

*** NOTICE**

If you recline the seatback towards the front with the headrest and seat cushion raised, the headrest may come in contact with the sun visor or other parts of the vehicle.

Removing headrest

Type A



Type B



To remove the headrest:

1. Recline the seatback (2) with the recline lever or switch (1).
2. Raise headrest as far as it can go.
3. Press the headrest release button (3) while pulling the headrest up (4).

⚠ WARNING

Removing headrest

NEVER allow anyone to ride in a seat with the headrest removed or reversed. Headrests can provide critical neck and head support in a crash.

Reinstalling headrest

Type A



Type B



To reinstall the headrest:

1. Put the headrest poles (2) into the holes while pressing the release button (1).
2. Recline the seatback (4) with the recline lever or switch (3).
3. Adjust the headrest to the appropriate height.

⚠ WARNING

Headrest Reinstallation

To reduce the risk of injury to the head or neck, always make sure the headrest is locked into position and adjusted properly after reinstalling.

Seatback pocket

The seatback pocket is provided on the back of the front passenger's and driver's seatbacks.



⚠ WARNING

Seatback pockets

Do not put heavy or sharp objects in the seatback pockets. In an accident they could come loose from the pocket and injure vehicle occupants.

Seatback hook

1st row



3rd row



Use it when hanging light shopping-bags.

⚠ CAUTION

Hanging heavy clothing

Do not hang heavy clothes, since they may damage the hook.

Headrest for rear seat

The rear seat is equipped with headrests in all the seating positions for the occupant's safety and comfort.



The headrest not only provides comfort for passengers, but also helps protect the head and neck in the event of a collision.

To maximize the effectiveness in case of accidents, the headrest should be adjusted so the middle of the headrest is as high as the center of gravity of an occupant's head. Generally, the center of gravity of most people's heads is similar with the height as the top of their eyes.

Also, adjust the headrest as close to your head as possible. For this reason, the use of a cushion that holds the body away from the seatback is not recommended.

Adjusting the height up and down (2nd row seat and 3rd row center seat)

2nd row



3rd row center



- To raise the headrest, pull it up to the desired position (1).
- To lower the headrest, push and hold the release button (2) on the headrest support and lower the headrest to the desired position (3).

**Removing/reinstalling headrest
(2nd row seat and 3rd row center seat)**

2nd row



OON038020NR

3rd row center



OON038020NR

- To remove the headrest, raise it as far as it can go then press the release button (1) While pulling the headrest upward (2).
- To reinstall the headrest, put the headrest poles (3) into the holes while pressing the release button (1).
- Then adjust it to the appropriate height and ensure that it locks in position.

Folding 3rd row headrest (except for center)



OON038105NR



OON038106NR

The headrest will fold down automatically when folding the seatback.

To fold the headrest manually:

- Pull the strap.

To fold the headrest manually:

- Raise the headrest manually.

Always be sure the headrest has locked into position after you return the seatback.

⚠ WARNING

Close the liftgate carefully when the third-row seats are occupied. If you

close the liftgate too aggressively while the seat is occupied, you may hit the passenger in the head and cause injuries.



3

Armrest

For 7 seats

The 2nd row seats have the armrest located on the side of seatback.

- To use the armrest, swing down the armrest to the lowest position.

Then, adjust the armrest to the desired position while raising it.

When adjusting the position, the operating sound will be heard. This indicates normal operation, not malfunction.

For 8 seats

- To use the armrest, pull it forward from the seatback.



Folding the rear seat

The rear seatbacks may be folded to facilitate carrying long items or to increase the luggage capacity of the vehicle.

⚠ WARNING

Folded Seatback

The purpose of the fold-down rear seatbacks is to allow you to carry

longer objects that could not otherwise be accommodated.

- Never allow a passenger to sit on top of the folded down seatback while the car is moving. This is not a proper seating position since no seat belts are available for use. This could result in serious injury or death in case of an accident or sudden stop.

⚠ WARNING

When folding the seatback, be sure to hold the seatback or headrest with your hands.

⚠ CAUTION

When folding or unfolding a rear seat, make sure to lower the seat's headrest as much as possible and put the seatback of the seat in front of the rear seat in the upright position.

If there is any interference when folding or unfolding the seat, the interfered area of the seat may be damaged.

Folding down the rear seatback

1. Set the front seatback to the upright position and if necessary, slide the front seat forward.
2. Lower the rear headrests to the lowest position.

⚠ WARNING

Objects

Objects carried on the folded down seatback should not extend higher than the top of the front seatbacks. This could allow cargo to slide forward and cause injury or damage during sudden stops.

⚠ CAUTION

When the seats in the 2nd-row are folded to use the area as a cargo compartment, be sure to turn off the seat heater. (if equipped)

3. When folding the seatback, insert the rear seat belt buckle in the pocket between the rear seatback and cushion. Make sure both seat belts do not interfere with stowed luggage and cargo. Then, the seat belt webbing should be placed in the webbing guide to prevent the seat belt from being damaged by loaded cargo, etc. If the seat belt is loose, it may cause damage or noise. In that case, return the seatback to the upright position and put the webbing out from the guide to realign it.
4. Pull on the seatback folding lever (for 2nd row) or strap (for 3rd row), then fold the seat toward the front of the vehicle. When you return the seatback to its upright position, always be sure it has locked into position by pushing on the top of the seatback.

2nd row seat



3rd row seat



Unfolding the rear seat

2nd row seat



3rd row seat



5. To use the rear seat, lift and pull the seatback backward by pulling on the folding lever (for 2nd row) or strap (for 3rd row). Pull the seatback firmly until it clicks into place. Make sure the seatback is locked in place.
6. Return the rear seat belt to the proper position.

1. To use the rear seat, lift and pull the seatback backward. Pull the seatback firmly until it clicks into place. Make sure the seatback is locked in place. When you return the seatback to its upright position, always be sure it has locked into position by pushing on the top of the seatback.
If you cannot see the red line at the bottom of folding lever, it means the seatback is locked completely.

2. Return the rear seat belt to the proper position.
3. When the seatback is completely installed, check the seatback folding lever again.

Folding 2nd row seat



This feature allows you to fold seats in the 2nd row while the liftgate is open.

1. Press the folding switch of the seatback located on the left and right sides of the liftgate.
 - L: Folding the left seat in the 2nd-row
 - R: Folding the right seat in the 2nd-row

You can use additional space by folding the seatback forward.

2. If the seatback is not fully folded, try folding again to make it completely folded.

⚠ WARNING

Rear seat folding

Do not fold the rear seats (2nd & 3rd row seats), if passengers, pets or luggage are in the rear seats. It may cause injury or damage to passengers, pets, luggage.



⚠ WARNING

Never attempt to adjust using the 2nd row seat walk-in switch or strap while the vehicle is moving or seat is occupied as the seat may

suddenly move and cause the passenger on the seat to be injured.

7 seat



00N038027NR

8 seat



00N038086NR

- If the folding switch (1 or 2) in the 2nd row (in the upper part of the 2nd row seatback or the outer part of the seat) does not work, pull the strap (3) on the bottom left of the seat in the 2nd row. It works just like the folding switch and you can move the seat forward along with the seatback.

⚠ WARNING

Do not pull the strap (3) when the 2nd-row seat(s) is/are occupied. Sudden movement of the seat(s) may result in injury. Use the strap only when the folding switch in the 2nd row (in the upper part of the second-row seatback or the outer part of the seat) does not work.

- This strap (3) is for 3rd row passengers to exit the vehicle even if when the vehicle's battery power is in run-out emergency condition in an accident.

⚠ WARNING

Uprighting seat

When you return the seatback to its upright position, hold the seatback and return it slowly. If the seatback is returned without holding it, the back of the seat could spring forward, resulting in injury caused by being struck by the seatback.

⚠ WARNING

Rear seatback

To ensure maximum protection in the event of an accident or sudden stop, when returning the rear seat to the upright position:

- Be careful not to damage the seat belt webbing or buckle.

- Do not allow the seat belt webbing or buckle to become pinched or caught in the rear seat.
- Ensure the seatback is completely locked into its upright position by pushing on the top of the seatback.

Failure to adhere to any of these instructions could result in serious injury or death in the event of a crash.

⚠ CAUTION

Damaging rear seat belt buckles

When you fold the rear seatback, insert the buckle between the rear seatback and cushion. Doing so can prevent the buckle from being damaged by the rear seatback.

⚠ CAUTION

Rear seat belts

When returning the rear seatbacks to the upright position, remember to return the rear shoulder belts to their proper position.

⚠ WARNING

Unless the driver's position is properly set according to the driver's physical figure, do not fold the rear seat. It may increase bodily injuries in a sudden stop or collision.

⚠ CAUTION

Be careful when loading cargo through the rear passenger seats to prevent damage to the vehicle interior.

⚠ WARNING

Cargo

Cargo should always be secured to prevent it from being thrown about the vehicle in a collision and causing injury to the vehicle occupants. Do not place objects in the rear seats, since they cannot be properly secured and may hit the front seat occupants in a collision.

Cargo loading

Make sure the engine is off, the transmission is in P (Park) and the parking brake is securely applied whenever loading or unloading cargo. Failure to take these steps may allow the vehicle to move if the shift lever is inadvertently moved to another position.

Seat belts

Seat belts are designed to bear upon the bony structure of the body, and should be worn low across the front of the pelvis, chest and shoulders.

Seat belt restraint system

For maximum restraint system protection, the seat belts must always be used whenever the vehicle is moving.

- A properly positioned shoulder belt should be positioned midway over your shoulder across your collarbone.
- Never allow children to ride in the front passenger seat. See "Child Restraint System (CRS)" on page 3-42 for further discussion.

WARNING

Twisted seat belt

Make sure your seat belt is not twisted when worn. A twisted seat belt may not properly protect you in an accident and could even cut into your body.

WARNING

Shoulder Belt

- Never wear the shoulder belt under your arm or behind your back. An improperly positioned shoulder belt cannot protect the occupant in a crash.

- Always wear both the shoulder portion and lap portion of the lap/shoulder belt.

WARNING

Damaged seat belt

Any damage in webbing or hardware may lead to serious injury or death in a crash. For your safety, replace the entire seat belt assembly when any part of the webbing or hardware is damaged.

Seat belts are designed to bear upon the bony structure of the body, and should be worn low across the front of the pelvis, chest and shoulders, as applicable; wearing the lap section of the belt across the abdominal area must be avoided.

Seat belts should be adjusted as firmly as possible, consistent with comfort, to provide the protection for which they have been designed.

A slack belt will greatly reduce the protection afforded to the wearer.

Care should be taken to avoid contamination of the webbing with polishes, oils and chemicals, and particularly battery acid. Cleaning may safely be carried out using mild soap and water. The belt should be replaced if webbing becomes frayed, contaminated or damaged.

- No modifications or additions should be made by the user which would either prevent the seat belt adjusting devices from operating to remove slack, or prevent the seat belt assembly from being adjusted to remove slack.
- When you fasten the seat belt, be careful not to latch the seat belt in buckles of other seats. It is very dangerous and you may not be protected by the seat belt properly.
- Do not unfasten the seat belt and do not fasten and unfasten the seat belt repeatedly while driving. This could result in loss of control, and an accident causing death, serious injury, or property damage.
- When fastening the seat belt, make sure that the seat belt does not pass over objects that are hard or can break easily.

▲ WARNING

Seat belt buckle

Do not allow foreign material (gum, crumbs, coins, liquids, etc.) to obstruct the seat belt buckle. This may prevent the seat belt from fastening securely.

Driver's seat belt warning

As a reminder to the driver, the driver's seat belt warning lights will illuminate for approximately 6 seconds each time you turn the ENGINE START/STOP button ON regardless of belt fastening. If the seatbelt is not fastened, the warning chime will sound for about 6 seconds.



If you start to drive without the seat belt fastened or you unfasten the seat belt when you drive over 9 km/h (5 mph) and less than 20 km/h (12 mph), the corresponding warning light will illuminate. The warning light will turn off when the vehicle speed drops below 9 km/h (5 mph).

If you start to drive without the seat belt fastened or you unfasten the seat belt when you drive 20 km/h (12 mph) and faster, the warning light will blink and warning chime will sound for approximately 100 seconds. When the seat belt is unfastened during driving, the warning light will illuminate when the speed

is under 20 km/h (12 mph). When the speed is 20 km/h (12 mph) and faster, the warning light will blink and warning chime will sound for approximately 100 seconds.

Front passenger's seat belt warning



As a reminder to the front passenger, the front passenger's seat belt warning lights will illuminate for approximately 6 seconds each time you turn the ENGINE START/STOP button ON regardless of belt fastening. If you start to drive without the passenger seat belt fastened or the passenger unfastens the seat belt when you drive over 9 km/h (5 mph) and less than 20 km/h (12 mph), the corresponding warning light will illuminate. The warning light will turn off when the vehicle speed drops below 9 km/h (5 mph).

If you start to drive without the passenger seat belt fastened or you unfasten the seat belt when you drive 20 km/h (12 mph) and faster, the warning light will blink and warning chime will sound for approximately 100 seconds. When the passenger seat belt is unfastened during driving, the warning light will illuminate when the speed is under 20 km/h (12 mph). When the speed is 20 km/h (12 mph) and faster, the warning light will blink and warning chime will sound for approximately 100 seconds.

* NOTICE

- Even if the front passenger seat is not occupied, the seat belt warning light will illuminate for 6 seconds.
- The front passenger's seat belt warning may operate when luggage is placed on the front passenger seat.

Seat belt - Driver's 3-point system with emergency locking retractor

The following explains how to fasten and adjust the driver's seat belt.

Fastening the your seat belt:



- Pull it out of the retractor and insert the metal tab (1) into the buckle (2). There will be an audible "click" when the tab locks into the buckle.



your hips. If the lap belt is located too high on your waist, it may increase the chance of injury in the event of a collision.

The arm closest to the seat belt buckle should be over the belt while the other arm should be under the belt as shown in the illustration. Never wear the seat belt under the arm closest to the door.

The seat belt automatically adjusts to the proper length only after the lap belt portion is adjusted manually so that it fits snugly around your hips. If you lean forward in a slow, easy motion, the belt will extend and let you move around. If there is a sudden stop or impact, however, the belt will lock into position. It will also lock if you try to lean forward too quickly.

*** NOTICE**

If you are not able to pull out the seat belt from the retractor, firmly pull the belt out and release it. Then you will be able to pull the belt out smoothly.

⚠ WARNING

You should place the lap belt portion as low as possible and snugly across

Adjusting the height of shoulder belt

You can adjust the height of the shoulder belt anchor to one of the 4 positions for maximum comfort and safety.



The height of the adjusting seat belt should not be too close to your neck. The shoulder portion should be adjusted so that it lies across your chest and midway over your shoulder near the door and not your neck.

To adjust the height of the seat belt anchor, lower or raise the height adjuster into an appropriate position.

- To raise the height adjuster, pull it up (1).
- To lower it, push it down (3) while pressing the height adjuster button (2).

Release the button to lock the anchor into position. Try sliding the height adjuster to make sure that it has locked into position.

Improperly positioned seat belts can cause serious injuries in an accident.

⚠ WARNING

Shoulder belt positioning

Verify the shoulder belt anchor is locked into position at the appropriate height. Never position the shoulder belt across your neck or face. Improperly positioned seat belts can cause serious injuries in an accident.

⚠ WARNING

Seat belt replacement

Replace your seat belts after being in an accident. Failure to replace seat belts after an accident could leave you with damaged seat belts that will not provide protection in the event of another collision.

Seat belts - Front passenger and rear seat 3-point system with combination locking retractor

The following explains how to fasten the passenger's and rear seat belt.

Fastening your seat belt:

Combination retractor type seat belts are installed in the rear seat positions to help accommodate the installation of Child Restraint System. Although a combination

retractor is also installed in the front passenger seat position, it is strongly recommended that children always be seated in the rear seat. NEVER place any infant restraint system in the front seat of the vehicle.

This type of seat belt combines the features of both an emergency locking retractor seat belt and an automatic locking retractor seat belt.

- Pull it out of the retractor and insert the metal tab into the buckle. There will be an audible "click" when the tab locks into the buckle. When not securing a child restraint, the seat belt operates in the same way as the driver's seat belt (emergency locking retractor type).

It automatically adjusts to the proper length only after the lap belt portion of the seat belt is adjusted manually so that it fits snugly around your hips.

When the seat belt is fully extended from the retractor to allow the installation of a Child Restraint System, the seat belt operation changes to allow the belt to retract, but not to extend (automatic locking retractor type). Refer to "Securing a child restraint with a lap/shoulder belt" on page 3-50.

* NOTICE

Although the combination retractor provides the same level of protection for seated passengers in either emergency or automatic locking modes, have the seated passengers use the emergency locking feature for improved convenience. The automatic locking function is intended to facilitate child restraint installation. To convert from the automatic locking feature to the emergency locking operation mode, allow the unbuckled seat belt to fully retract.

⚠ CAUTION

Do NOT fold down the left portion of the rear seatback when the rear center seat belt is buckled. ALWAYS UNBUCKLE the rear center seat belt before folding down the left portion of the rear seatback. If the rear center seat belt is buckled when the left portion of the rear seatback is folded down, distortion and damage to the top portion of the seatback and seat belt garnish may result, causing the seatback to lock into the folded down position.

The seat belt should be locked into the buckle on each seat cushion to be properly fastened.

2nd row seat



3rd row seat

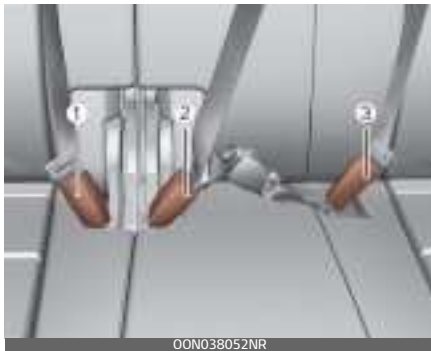

1. Rear right seat belt fastening buckle
2. Rear center seat belt fastening buckle
3. Rear left seat belt fastening buckle

⚠ WARNING

Prior to fastening the rear seat belts, ensure the latch matches the seat belt buckle. Forcefully fastening the left or right seat belt to the center buckle can result in an

improper fastening scenario that will not protect you in an accident.

When using the rear center seat belt, the buckle with the "CENTER" mark must be used.

2nd row seat



3rd row seat



Stowing the rear seat belt

The rear seat belt buckles can be stowed in the pocket between the rear seatback and cushion when not in use.

2nd row seat



3rd row seat

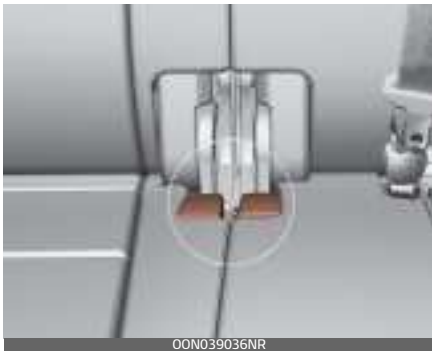

1. Route the seat belt webbing through the rear seat belt guides. It will help keep the belts from being trapped behind or under the seats.

2nd row seat



3rd row seat



2. After inserting the seat belt, tighten the belt webbing by pulling it up.

⚠ CAUTION

When pulling out to wear the seat belt, the tongue should be slowly pulled out of the seat belt guide so that the seat belt guide does not come off the trim.

⚠ WARNING

3rd center seat belt



Do not separate the mini tongue (1) and mini buckle (2) even if there is not an occupant.

If it is separated, It may hit the rear seat occupants in a collision or sudden stops.

Releasing the seat belt:



- The seat belt is released by pressing the release button (1) on the locking buckle.

When it is released, the belt should automatically draw back into the retractor. If this does not happen, check the belt to make sure it is not twisted, then try again.

Rear center seat belt (3rd row)

To fasten your seatbelt:

1. Extract the tongue plate (A) from the hole on the belt assembly cover.



2. Insert the tongue plate (A) into the buckle (A') until an audible "click" is heard, indicating the latch is locked. Make sure the belt is not twisted.



3. Pull out the tongue plate (B) from the pocket. Pull the tongue plate (B) and insert it into the buckle (B') until an audible "click" is heard, indicating the latch is locked. Make sure the belt is not twisted.

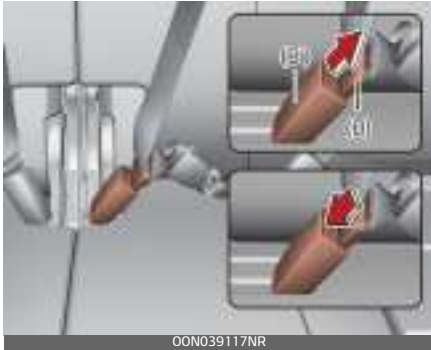

When using the rear center seat belt, the buckle with the "CENTER" mark must be used.

*** NOTICE**

If you are not able to pull out the safety belt from the retractor, firmly pull the belt out and release it. After release, you will be able to pull the belt out smoothly.

To release your seatbelt:

1. Press the release button on the buckle (B') and remove the tongue plate (B).



2. To retract the rear center seat-belt, insert the tongue plate into the web release hole (A'). Pull up on the seat belt web and allow the webbing to retract automatically. Insert the tongue plate (A) into the hole on the belt assembly cover.



Pre-tensioner seat belt



Your vehicle is equipped with pre-tensioner seat belts at the front outboard seating positions.

The purpose of the pre-tensioner is to make sure that the seat belts fit tightly against the occupant's body in certain collisions.

The pre-tensioner seat belts may be activated in a collision when the collision is severe enough.

When the vehicle stops suddenly, or if the occupant tries to lean forward too quickly, the seat belt retractor will lock into position. In certain frontal collisions, the pre-tensioner will activate and pull the seat belt into tighter contact against the occupant's body.

If the system senses excessive tension on the driver or passenger's seat belt when the pre-tensioner activates, the load limiter inside the pre-tensioner will release some of

the pressure on the affected seat belt. (if equipped)

⚠ WARNING

For your safety, be sure that the belt webbing is not loose or twisted and always sit properly on your seat.

* NOTICE

The pre-tensioner may activate not only in a frontal collision but also in a side collision, if the vehicle is equipped with a side or curtain air bag.



The seat belt pre-tensioner system consists mainly of the following components. Their locations are shown in the illustration:

1. Supplemental Restraint System (SRS) air bag warning light
2. Retractor pre-tensioner assembly
3. SRS Control Module

⚠ WARNING

For optimal usage pre-tensioner seat belt:

1. The seatbelt must be working correctly and adjusted to the proper position. Please read and follow all of the important information and precautions about your vehicle's occupant safety features – including seat belts and air bags – that are provided in this manual.
2. Be sure you and your passengers always wear seat belts properly.

*** NOTICE**

- When the pre-tensioner seat belts are activated, a loud noise may be heard and fine dust, which may appear to be smoke, may be visible in the passenger compartment. These are normal operating conditions and are not hazardous.
- Although it is harmless, the fine dust may cause skin irritation and should not be breathed for prolonged periods. Wash all exposed skin areas thoroughly after an accident in which the pre-tensioner seat belts were activated.
- Because the sensor that activates the SRS air bag is connected with the pre-tensioner seat belt, the SRS air bag warning light on the instrument panel will illuminate for approximately 6 seconds after

the ENGINE START/STOP button has been turned to the "ON" position, and then it should turn off.

⚠ CAUTION

If the pre-tensioner seat belt is not working properly, the SRS air bag warning light will illuminate even if there is no malfunction of the SRS air bag. If the SRS air bag warning light does not illuminate when the ENGINE START/STOP button is turned to ON, or if it remains illuminated after illuminating for approximately 6 seconds, or if it illuminates while the vehicle is being driven, have the system inspected by an authorized Kia dealer.

⚠ WARNING

- Pre-tensioners seat belts systems are designed to operate only one time. After activation, pre-tensioner seat belts must be replaced. All seat belts, of any type, should always be replaced after they have been worn during a collision.
- The pre-tensioner seat belt assembly mechanisms become hot during activation. Do not touch the pre-tensioner seat belt assemblies for several minutes after they have been activated.

- Do not attempt to inspect or replace the pre-tensioner seat belts yourself. Have the system inspected by an authorized Kia dealer.
- Do not attempt to service or repair the pre-tensioner seat belt system in any manner.
- Improper handling of the pre-tensioner seat belt assemblies, and failure to heed the warnings not to strike, modify, inspect, replace, service or repair the pre-tensioner seat belt assemblies may lead to improper operation or inadvertent activation and serious injury.
- Always wear the seat belts when driving or riding in a motor vehicle.
- If the vehicle or pre-tensioner seat belt must be discarded, contact a professional workshop. Kia recommends to visit an authorized Kia dealer.
- Body work on the front area of the vehicle may damage the pre-tensioner seat belt system. Therefore, have the system serviced by an authorized Kia dealer.

Seat belt precautions

Take the following precautions when using seat belts.

Infant or small child

Most countries have child restraint laws. You should be aware of the specific requirements in your country. Child and/or infant seats must be properly placed and installed in the rear seat. For more information about the use of these restraints, refer to "Child Restraint System (CRS)" on page 3-42.

* NOTICE

Small children are best protected from injury in an accident when properly restrained in the rear seat by a Child Restraint System that meets the requirements of the Safety Standards of your country. Before buying any Child Restraint System, make sure that it has a label certifying that it meets Safety Standards of your country. The restraint must be appropriate for your child's height and weight. Check the label on the child restraint for this information. Refer to "Child Restraint System (CRS)" on page 3-42.

Larger children

Children who are too large for Child Restraint System should always occupy the rear seat and use the available lap/shoulder belts. The lap portion should be fastened and snug on the hips as low as possible. Check

periodically to insure that the belt fits. A child's squirming could put the belt out of position. Children are given the most safety in the event of an accident when they are restrained by a proper restraint system in the rear seat. If a larger child (over age 13) must be seated in the front seat, the child should be securely restrained by the available lap/shoulder belt and the seat should be placed in the rearmost position. Children age 13 and under should be restrained securely in the rear seat. NEVER place a child age 13 and under in the front seat. NEVER place a rear facing child seat in the front seat of a vehicle.

If the shoulder belt portion slightly touches the child's neck or face, try placing the child closer to the center of the vehicle. If the shoulder belt still touches their face or neck they need to be returned to a Child Restraint System.

⚠ WARNING

Small children

Do not allow small children to ride in the vehicle without an appropriate Child Restraint System. If the shoulder belt comes in contact with your child's neck or face your child is too small to ride in the vehicle. In a crash the seat belt will inflict injury to your child's neck, throat and face.

Restraint of pregnant women

Pregnant women should wear lap/shoulder belt assemblies whenever possible according to specific recommendations by their doctors. The lap portion of the belt should be worn AS SECURELY AND LOW AS POSSIBLE.

⚠ WARNING

Pregnant women

Pregnant women must never place the lap portion of the seat belt above or on the abdomen where the fetus is located. The force of the seat belt during a collision will crush the fetus.

Injured person

A seat belt should be used when an injured person is being transported. When this is necessary, you should consult a physician for recommendations.

One person per belt

Two people (including children) should never attempt to use a single seat belt. This could increase the severity of injuries in case of an accident.

Do not lie down

To reduce the chance of injuries in the event of an accident and to achieve maximum effectiveness of the restraint system, all passengers should be sitting up and the front and rear seats should be in an upright position when the vehicle is moving. A seat belt cannot provide proper protection if the person is lying down in the rear seat or if the front and rear seats are in a reclined position.

Care of seat belts

Seat belt systems should never be disassembled or modified. In addition, care should be taken to assure that seat belts and belt hardware are not damaged by seat hinges, doors or other abuse.

⚠ WARNING**Pinched seat belt**

Make sure that the webbing and/or buckle does not get caught or pinched in the rear seat when returning the rear seatback to its upright position. A caught or pinched webbing/buckle may become damaged and could fail during a collision or sudden stop.

⚠ WARNING

Seatbelts can become hot in a vehicle that has been closed up in sunny weather. They could burn infants and children.

Periodic inspection

All seat belts should be inspected periodically for wear or damage of any kind. Any damaged parts should be replaced as soon as possible.

Keep belts clean and dry

Seat belts should be kept clean and dry. If belts become dirty, they can be cleaned by using a mild soap solution and warm water. Bleach, dye, strong detergents or abrasives should not be used because they may damage and weaken the fabric.

When to replace seat belts

The entire in-use seat belt assembly or assemblies should be replaced if the vehicle has been involved in an accident. This should be done even if no damage is visible. Additional questions concerning seat belt operation should be directed to an authorized Kia dealer.

Child Restraint System (CRS)

Infants and younger children must be restrained in an appropriate rear-facing or forward-facing Child Restraint System (CRS) that has first been properly secured to the rear seat of the vehicle.

Children always in the rear

Children under age 13 must always ride in the rear seats and must always be properly restrained to minimize the risk of injury in an accident, sudden stop or sudden maneuver.

WARNING

Restraint Location

Never install a child or infant seat on the front passenger's seat. A child riding in the front passenger seat can be forcefully struck by an inflating airbag and seriously injured.

WARNING

Hot Child Restraint

A Child Restraint System can become very hot if it is left in a closed vehicle on a sunny day. Be sure to check the seat cover, buckles and latches before placing a child in the restraint system.

According to accident statistics, children are safer when properly

restrained in the rear seats than in the front seat. Even with air bags, children can be seriously injured or killed. Children too large for a child restraint must use the seat belts provided.

Most countries have child restraint laws which require children to travel in approved child restraint devices.

The laws governing the age or height/weight restrictions at which seat belts can be used instead of child restraints differs among countries, so you should be aware of the specific requirements in your country, and where you are travelling.

The CRS must be properly placed and installed in the rear seat. You must use a commercially available CRS that meets the requirements of the Safety Standards of your country.

A CRS is generally designed to be secured in a vehicle seat by lap belt portion of a lap/shoulder belt, or by a LATCH system in the rear seats of the vehicle.

Child Restraint System (CRS)

Infants and younger children must be restrained in an appropriate rear-facing or forward-facing CRS that has first been properly secured to the rear seat of the vehicle. Read and comply with the instructions for

installation and use provided by the manufacturer of the CRS.

⚠ WARNING

Child Restraint Installation

An improperly secured child restraint can increase the risk of serious injury or death in an accident. Always take the following precautions when using a Child Restraint System:

- Always follow the Child Restraint System manufacturer's instructions for installation and use.
- Always properly restrain your child in the child restraint.
- If the vehicle head restraint prevents proper installation of a child seat (as described in the Child Restraint System manual), the head restraint of the respective seating position shall be readjusted or entirely removed.
- Do not use an infant carrier or a child safety seat that "hooks" over a seatback as it may not provide adequate protection in an accident.
- Be especially careful when installing a child restraint on the center seating position in the second row as it is narrower than the outboard positions. A wide child restraint installed on the center seat may cover the safety belt buckles for the other seating positions. Do not allow someone

to ride in a seating position where the safety belt buckle is covered by a child restraint.

- A child restraint in the center seating position may also contact or push up against the safety belt buckles, which can damage the buckles and make them unusable or unsafe. Always check that the child restraint does not contact any of the safety belt buckles. Check the placement of the child restraint regularly to make sure that it has not shifted and come into contact with any of the safety belt buckles.

*** NOTICE**

After an accident, have a Kia dealer check the Child Restraint System, seat belts, tether anchors and lower anchors.

Selecting a CRS

When selecting a CRS for your child, always:

- Make sure the CRS has a label certifying that it meets applicable Safety Standards of your country.
- Select a child restraint based on your child's height and weight. The required label or the instructions for use typically provide this information.

- Select a child restraint that fits the vehicle seating position where it will be used.
- Read and comply with the warnings and instructions for installation and use provided with the CRS.

⚠ WARNING

Holding Children

Never hold a child in your arms or lap when riding in a vehicle. The violent forces created during a crash will tear the child from your arms and throw the child against the car's interior. Always use a Child Restraint System which is appropriate for your child's height and weight.

⚠ WARNING

Unattended Children

Never leave children unattended in a vehicle. The car can heat up very quickly, resulting in injuries to the child in the vehicle.

⚠ WARNING

Seat Belt Use

Do not use one seat belt for two occupants at the same time. This will eliminate any safety benefit provided by the seat belt to the occupants.

CRS types

There are three main types of the CRS: rear-facing seats, forward-facing seats, and booster seats. They are classified according to the child's age, height and weight.

Rear-facing child seats



A rear-facing child seat provides restraint with the seating surface against the back of the child. The harness system holds the child in place, and in an accident, acts to keep the child positioned in the seat and reduces the stress to the neck and spinal cord.

All children under age one must always ride in a rear-facing infant child restraint.

Convertible and 3-in-1 child seats typically have higher height and weight limits for the rear-facing position, allowing you to keep your child rear-facing for a longer period of time.

Continue to use a rear-facing child seat for as long as your child will fit within the height and weight limits

allowed by the child seat manufacturer. It's the best way to keep them safe. Once your child has outgrown the rear-facing child restraint, your child is ready for a forward-facing child restraint with a harness.

Forward-facing child restraints



A forward-facing child seat provides restraint for the child's body with a harness. Keep children in a forward-facing child seat with a harness until they reach the top height or weight limit allowed by your child restraint's manufacturer. Once your child outgrows the forward-facing child restraint, your child is ready for a booster seat.

Booster seats

A booster seat is a restraint designed to improve the fit of the vehicle's seat belt system. A booster seat positions the seat belt so that it fits properly over the lap of your child.

Keep your child in a booster seat until they are big enough to sit in

the seat without a booster and still have the seat belt fit properly. For a seat belt to fit properly, the lap belt must lie snugly across the upper thighs, not the stomach. The shoulder belt should lie snug across the shoulder and chest and not across the neck or face. Children under age 13 must always ride in the rear seats and must always be properly restrained to minimize the risk of injury.

Installing a CRS

After selecting a proper child seat for your child, check to make sure it fits properly in your vehicle.

Follow the instructions provided by the manufacturer when installing the child seat. Note these general steps when installing the seat to your vehicle:

- **Properly secure the child restraint to the vehicle.** All child restraints must be secured to the vehicle with the lap part of a lap/shoulder belt or with the LATCH system.
- **Make sure the child restraint is firmly secured.** After installing a child restraint to the vehicle, push and pull the seat forward and from side-to-side to verify that it is securely attached to the seat. A child restraint secured with a seat belt should be installed as firmly as possible. However, some side-to-side movement can be expected.

- **Secure the child in the child restraint.** Make sure the child is properly strapped in the child restraint according to the manufacturer instructions.

Lower Anchors and Tether for Children (LATCH) system

The LATCH system holds a child restraint during driving and in an accident. This system is designed to make installation of the child restraint easier and reduce the possibility of improperly installing your child restraint. The LATCH system uses anchors in the vehicle and attachments on the child restraint. The LATCH system eliminates the need to use seat belts to secure the child restraint to the rear seats.

Lower anchors are metal bars built into the vehicle. There are two lower anchors for each LATCH seating position that will accommodate a child restraint with lower attachments.

To use the LATCH system in your vehicle, you must have a child restraint with LATCH attachments.

The child seat manufacturer will provide you with instructions on how to use the child seat with its attachments for the LATCH lower anchors.



LATCH anchors have been provided in the left and right outboard of 2nd row and the left outboard of 3rd row seating positions. Their locations are shown in the illustration.

For 8-seater vehicles, LATCH is not provided for the middle seat in the 2nd row.

For 7- or 8-seater vehicles, LATCH is not provided for the right seat in the 3rd row.

⚠ WARNING

LATCH Lower Anchors

Never attempt to attach a LATCH equipped seat in the center seating position. LATCH lower anchors are only to be used in the left and right outboard of 2nd row and the left outboard of 3rd row seating positions. You may damage the anchors or the anchors may fail and break in a collision if the seat is in the center seating position.

The lower anchor position indicator symbols are located on the left and right 2nd row rear seatbacks to identify the position of the lower anchors in your vehicle (see arrows in illustration).

7 seats 2nd row



8 seats 2nd row

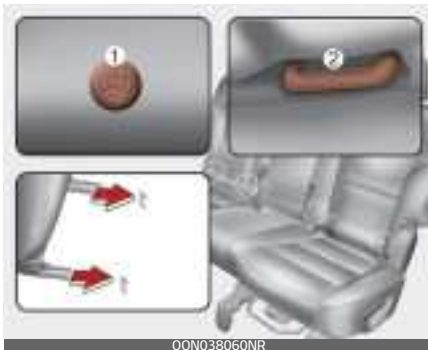

3rd row seat



1. Lower Anchor position indicator
2. Lower Anchor

The LATCH anchors are located between the seatback and the seat cushion of the left and right outboard of 2nd row and the left outboard of 3rd row seating positions.

Two LATCH anchors are also applied to the left of the 3rd row seats.

Securing a child restraint with the LATCH anchors system

To install a LATCH-compatible child restraint in either of the rear outboard seating positions:

1. Move the seat belt buckle away from the lower anchors. Otherwise, the webbing or buckle can be damaged by the latch anchor, which can make them become unusable or unsafe. (Especially 3rd row left outboard seating positions)

2. Move any other objects away from the anchors that could prevent a secure connection between the child restraint and the lower anchors.
 3. Adjust the seat back to the full rearward position.
 4. Place child restraint on the vehicle seat, then attach the seat to the lower anchors according to the instructions provided by the child restraint manufacturer.
 5. If the child seat includes a top tether strap, attach the tether connector to the seat tether anchor according to the instructions provided by the child restraint manufacturer.
 6. Rotate the seat back forward to a locked position that ensures good contact between the seat back and child restraint.
 7. Then follow the child restraint instructions for properly adjusting and tightening the attachments on the child restraint to the LATCH anchors.
- To prevent the child from reaching and taking hold of the unused seat belts, buckle all unused rear seat belts before the child is placed into the vehicle. Lock each unused seatbelt following the instructions in the "automatic locking mode" subsection, and place the webbing behind the child seat or against an unused seat-back. Children can be strangled if a shoulder belt becomes wrapped around their neck and the seat belt tightens.
 - NEVER attach more than one child restraint to a single anchor. This could cause the anchor or attachment to come loose or break.
 - Always have the LATCH system inspected by your authorized Kia dealer after an accident. An accident can damage the LATCH system and may not properly secure the child restraint.
-

WARNING

Take the following precautions when using the LATCH system:

- Read and follow all installation instructions provided with your Child Restraint System.

Securing a child restraint seat with "Tether Anchor" system

7 seats



00N038059NR

8 seats



00N039112NR

3rd row seat



00N039113NR

First secure the child restraint with the LATCH lower anchors or the seat belt. If the child restraint manufacturer recommends that the top tether strap be attached, attach and tighten the top tether strap to the top tether strap anchor.

Child restraint hook holders are located on the shelf behind the rear seats.

⚠ WARNING

Take the following precautions when installing the tether strap:

- Read and follow all installation instructions provided with your Child Restraint System.
- NEVER attach more than one child restraint to a single tether anchor. This could cause the anchor or attachment to come loose or break.
- Do not attach the tether strap to anything other than the correct tether anchor. It may not work properly if attached to something else.
- Do not use the tether anchors for adult seat belts or harnesses, or for attaching other items or equipment to the vehicle.
- Always fasten the seat belts behind the child restraint seat when they are not used to secure the child seat. Failure to do so may result in child strangulation.

To install the tether anchor:



1. Route the child restraint tether strap over the child restraint seatback. Route the tether strap under the head restraint and between the head restraint posts, or route the tether strap over the top of the vehicle seatback. Make sure the strap is not twisted.
2. Connect the tether strap hook to the tether anchor, then tighten the tether strap according to the child seat manufacturer's instructions to firmly secure the child restraint to the seat.
3. Check that the child restraint is securely attached to the seat by pushing and pulling the seat forward and from side-to-side.

Securing a child restraint with a lap/shoulder belt

When not using the LATCH system, all child restraints must be secured to a vehicle rear seat with the lap part of a lap/shoulder belt.

Automatic locking mode



All passenger seat belts move freely under normal conditions and only lock under extreme or emergency conditions (emergency locking mode). So, in order to secure a child restraint, you must manually pull the seat belt all the way out to shift the retractor to the "automatic locking" mode.

The "automatic locking" mode will help prevent the normal movement of the child in the vehicle from causing the seat belt to loosen and compromise the CRS.

To install a CRS on the rear seats, do the following:

1. Place the CRS on a rear seat and route the lap/shoulder belt around or through the child restraint, following the restraint manufacturer's instructions. Be sure the seat belt webbing is not twisted.
2. Fasten the lap/shoulder belt latch into the buckle. Listen for the distinct "click" sound.

Position the release button so that it is easy to access in case of an emergency.



3. Pull the shoulder portion of the seat belt all the way out. When the shoulder portion of the seat belt is fully extended, it will shift the retractor to the "automatic locking" (child restraint) mode.



4. Slowly allow the shoulder portion of the seat belt to retract and listen for an audible "clicking" or "ratcheting" sound. This indicates that the retractor is in the "automatic locking" mode. If no distinct sound is heard, repeat steps 3 and 4.



5. Remove as much slack from the belt as possible by pushing down on the CRS while feeding the shoulder belt back into the retractor.
6. Push and pull on the CRS to confirm that the seat belt is holding it firmly in place. If it is not, release the seat belt and repeat steps 2 through 6.
7. Double check that the retractor is in the "automatic locking" mode by attempting to pull more of the seat belt out of the retractor. If you cannot, the retractor is in the "automatic locking" mode.

If your CRS manufacturer instructs or recommends you to use a tether anchor with the lap/shoulder belt, refer to "Securing a child restraint with the LATCH anchors system" on page 3-47 for more information.

* NOTICE

When the seat belt is allowed to retract to its fully stowed position, the retractor will automatically

switch from the "automatic locking" mode to the emergency lock mode for normal adult usage.

⚠ WARNING

Auto lock mode

Set the retractor to Automatic Lock mode when installing any Child Restraint System. If the retractor is not in the automatic locking mode, the child restraint can move when your vehicle turns or stops suddenly. A child can be seriously injured or killed if the child restraint is not properly anchored in the car.

To remove the child restraint, press the release button on the buckle and then pull the lap/shoulder belt out of the restraint and allow the seat belt to retract fully.

Air bag - advanced Supplemental Restraint System

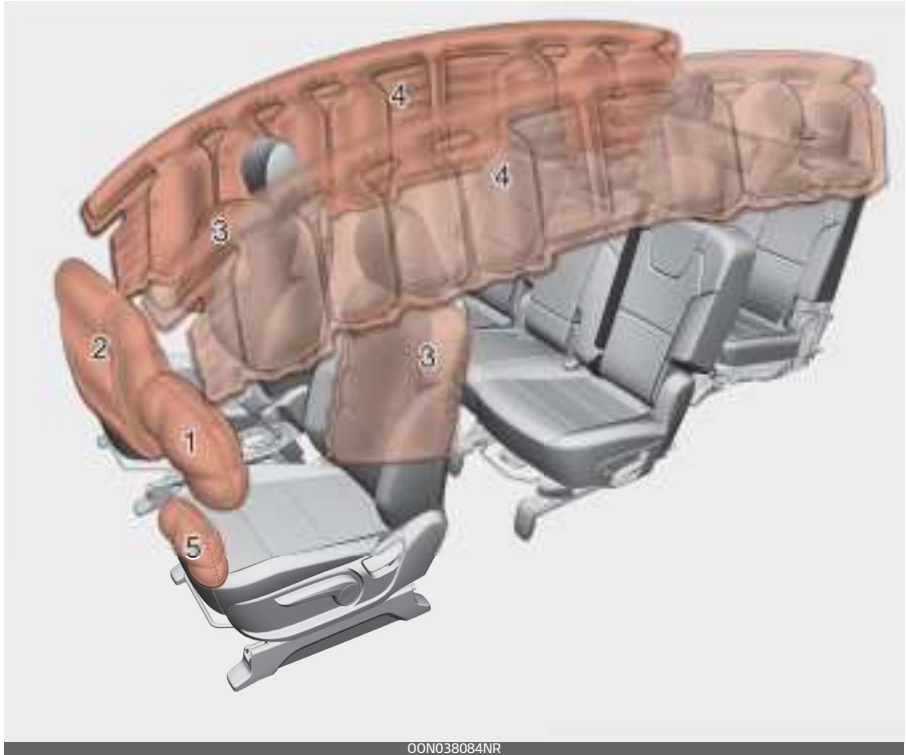

* The actual air bags in the vehicle may differ from the illustration.

1. Driver's front air bag
2. Passenger's front air bag
3. Side air bag
4. Curtain air bag
5. Driver's knee air bag

Even in vehicles with air bags, you and your passengers must always wear the safety belts provided in order to minimize the risk and severity of injury in the event of a collision or rollover.

How does the air bag system operate?

- Air bags are activated (able to inflate if necessary) only when the ENGINE START/STOP button has been turned to the ON position.
- The appropriate air bags inflate instantly in the event of a serious frontal collision or side collision in order to help protect the occupants from serious physical injury.
- There is no single speed at which the air bags will inflate. Generally, air bags are designed to inflate based upon the severity of a collision and its direction, etc. Several factors determine whether the sensors produce an electronic deployment / inflation signal.
- Air bags will not deploy in every crash or collision situations. Air bag deployment depends on a number of factors including vehicle speed, angles of impact, and, the density and stiffness of the vehicles or objects which your vehicle hits in the collision. The determining factors are not limited to those mentioned above.
- The front air bags will completely inflate and deflate in an instant. It is virtually impossible for you to see the air bags inflate during an accident. It is much more likely that you will simply see the deflated air bags hanging out of their storage compartments after the collision.
- In addition to inflating in serious side collisions, side and/or curtain air bags will inflate if the sensing system detects a rollover.
- When a rollover is detected, side and/or curtain airbags will remain inflated longer. This helps provide protection from ejection, especially when used in conjunction with the seat belts.
- In order to help provide protection, the air bags must inflate rapidly. The airbag inflates extremely fast between the occupant and the vehicle structures before the occupant impacts the vehicle structures. This speed of inflation reduces the risk of serious or life-threatening injuries and is thus a necessary part of the air bag design. However, airbag inflation can also cause injuries which can include fascial abrasions, bruises and broken bones. This is because the rapid inflation also causes the airbags to expand with a great deal of force.
- **There are even circumstances under which contact with the steering wheel or passenger air bag can cause fatal injuries, especially if the occupant is positioned excessively close to the steering wheel or passenger air bag.**

⚠ WARNING**Airbag inflation**

Sit as far back as possible from the steering wheel while still maintaining comfortable control of the vehicle. A distance of at least 25 cm (10 inches) from your chest to the steering wheel is recommended. Failure to do so can result in airbag inflation injuries to the driver.

Noise and smoke

When inflated, the air bags make a loud noise and leave smoke and powder in the air inside the vehicle. This is normal and is a result of the ignition of the air bag inflator. After the air bag inflates, you may feel substantial discomfort in breathing due to the contact of your chest with both the seat belt and the air bag, as well as from breathing the smoke and powder. **Open your doors and/or windows as soon as possible after impact in order to reduce discomfort and prevent prolonged exposure to the smoke and powder.**

Though smoke and powder are non-toxic, it may cause irritation to the skin (eyes, nose and throat, etc). If this is the case, wash and rinse with cold water immediately and consult a doctor if the symptom persists.

⚠ WARNING**Hot components**

Do not touch the air bag storage area's internal components immediately after airbag inflation. The air bag related parts in the steering wheel, instrument panel and the roof rails above the front and rear doors are very hot. Hot components can result in burn injuries.

⚠ WARNING

Do not install or place any accessories near air bag deployment areas, such as the instrument panel, windows, pillars, and roof rails.

Do not install a child restraint on the front passenger's seat

Never place a rear-facing child restraint in the front passenger's seat.



If the air bag deploys, it would impact the rear-facing child

restraint, causing serious or fatal injury.

In addition, do not place front-facing child restraints in the front passenger's seat. If the front passenger air bag inflates, it could cause serious or fatal injuries to the child.

▲ WARNING

Air bag deployment

When children are seated in the rear outboard seats of a vehicle equipped with side and/or curtain air bags, install the Child Restraint System as far away from the door side as possible. Inflation of the side and/or curtain air bags could impact the child.

Air bag warning light

The purpose of air bag warning light in your instrument panel is to alert you of a potential problem with your air bag system, which could include your side and/or curtain air bags used for rollover protection.



0DEEV068100NR

If the air bag warning light is illuminated for more than 6 seconds after the ENGINE START/STOP button has been turned to the ON position, or if it illuminates during vehicle opera-

tion, an SRS component may not be functioning properly and you should have your vehicle checked by an authorized Kia dealer.

If any of the following conditions occur, this indicates a malfunction in the air bag system. Have an authorized Kia dealer inspect the air bag system as soon as possible.

- The light does not turn on briefly when you turn the ENGINE START/STOP button to the ON position.
- The light stays on after illuminating for approximately 6 seconds.
- The light comes on while the vehicle is in motion.
- The light blinks when the ENGINE START/STOP button to the ON position.

Supplemental Restraint System (SRS) components and functions



00N038094NR

* The actual position of SRS components may differ from the illustration.

The SRS consists of the following components:

1. Driver's front air bag module
2. Passenger's front air bag module
3. Side air bag modules
4. Curtain air bag modules
5. Retractor pre-tensioner assemblies (if equipped)
6. Air bag warning light
7. SRS Control Module (SRSCM) / rollover sensor
8. Front impact sensors
9. Side impact sensors (if equipped)
10. Side pressure sensors (if equipped)
11. Occupant Detection System
12. Driver's knee air bag module

*: if equipped

Driver's front air bag (1)



The front air bag modules are located both in the center of the steering wheel and in the front passenger's panel above the glove box. When the SRSCM detects a sufficiently severe impact to the front of

the vehicle, it will automatically deploy the front air bags.

Driver's front air bag (2)



Upon deployment, tear seams molded directly into the pad covers will separate under pressure from the expansion of the air bags. Further opening of the covers then allows full inflation of the air bags.

Driver's front air bag (3)



A fully inflated airbag (with a properly fastened seat belt) slows the forward motion of the driver or passenger, reducing the risk of head and chest injury.

After complete inflation, the air bag immediately starts deflating, enabling the driver to maintain forward visibility and the ability to steer or operate other controls.

Passenger's front air bag



⚠ WARNING

Air bag obstructions

Do not install or place any accessories on the steering wheel, instrument panel, or on the front passenger's panel above the glove box in a vehicle. Such objects may become dangerous projectiles if the air bag deploys.

⚠ WARNING

Flying objects

Do not place any objects (an umbrella, bag, etc.) between the front door and the front seat. Such objects may become dangerous projectiles if the side airbag inflates.

- If an air bag deploys, there may be a loud noise followed by a fine dust released in the vehicle. These conditions are normal and are not hazardous – the air bags are packed in this fine powder. The dust generated during air bag deployment may cause skin or eye irritation as well as aggravate asthma for some persons. Always wash all exposed skin areas thoroughly with cold water and a mild soap after an accident in which the air bags were deployed.
- The SRS can function only when the ENGINE START/STOP button is in the ON position. The SRS is not working properly if any of the following situations occur:
 - the SRS airbag warning light does not illuminate
 - the SRS airbag warning light remains on continuously after illuminating for about 6 seconds when the ENGINE START/STOP button is turned to the ON position or after the vehicle is in ready mode
 - the SRS airbag warning light comes on while drivingIf this occurs, have your vehicle immediately inspected by an authorized Kia dealer.

*** NOTICE**

Before you replace a fuse or disconnect a battery terminal, change the

ENGINE START/STOP button to the OFF position. Never remove or replace the air bag related fuse(s) when the ENGINE START/STOP button is ON position. Failure to heed this warning will cause the SRS air bag warning light to illuminate.

Occupant Detection System (ODS)

Your vehicle is equipped with an Occupant Detection System (ODS) in the front passenger's seat.



The ODS is designed to detect the presence of a properly-seated front passenger and determine if the passenger's front air bag should be enabled (may inflate) or not. Only the front passenger front air bag is controlled by the ODS.

Do not put anything in front of the passenger air bag "OFF" indicator.

Main components of the ODS

- A detection device is located within the front passenger seat cushion.
- An electronic system which determines whether the passenger air bag systems should be activated or deactivated.
- An indicator light located on the instrument panel which illuminates the words PASSENGER AIR BAG "OFF" indicates the front passenger air bag system is deactivated.
- The instrument panel air bag warning light is interconnected with the ODS.

If the front passenger seat is occupied by a person that the system determines to be of appropriate size, and he/she sits properly (sitting upright with the seatback in an upright position, centered on the seat cushion with their seat belt on, legs comfortably extended and their feet on the floor), the PASSENGER AIR BAG "OFF" indicator will turn off and the front passenger's air bag will be able to inflate, if necessary, in frontal crashes.

You will find the PASSENGER AIR BAG "OFF" indicator on the center fascia panel. This system detects the conditions 1~4 in the following and activates or deactivates the

front passenger air bag based on these conditions.

Always be sure that you and all vehicle occupants are seated and restrained properly (sitting upright with the seat in an upright position, centered on the seat cushion, with the person's legs comfortably extended, feet on the floor, and wearing the safety belt properly) for the most effective protection by the air bag and the safety belt.

The ODS may not function properly if the passenger takes actions which

can defeat the detection system. These include:

1. Failing to sit in an upright position.
2. Leaning against the door or center console.
3. Sitting towards the sides or the front of the seat.
4. Putting legs on the dashboard or resting them on other locations which reduce the passenger weight on the front seat.
5. Improperly wearing the safety belt.
6. Reclining the seatback.

Conditions and operation of the front passenger ODS

Condition detected by the occupant classification system	Indicator/Warning light		Devices
	"PASSENGER AIR BAG OFF" indicator light	SRS warning light	Front passenger air bag
1. Adult*1	Off	Off	Activated
2. Child Restraint System (CRS) with child under 12 months old*2*3*4	On	Off	Deactivated
3. Unoccupied	On	Off	Deactivated
4. Malfunction in the system	Off	On	Activated

*1. The system judges a person of adult size as an adult. When a smaller adult sits in the front passenger seat, the system may recognize him/her as a child depending on his/her physique and posture.

*2. Do not allow children to ride in the front passenger seat. When a larger child who has outgrown a CRS sits in the front passenger seat, the system may recognize him/her as an adult depending upon his/her physique or sitting position.

*3. Never install a CRS on the front passenger seat.

*4. The PASSENGER AIR BAG  "OFF" indicator may turn on or off when a child above 12 months to 12 years old (with or without a CRS) sits in the front passenger seat. This is a normal condition.

⚠ WARNING

- Do not install a child restraint seat in the passenger seat when the seat is heavily soaked with any type of liquid.
- Do not alter or remodel the Occupant Detection System (ODS). This may damage the system and prevent its proper function in a collision.

*** NOTICE**

- Do not use car seat cushions that cover up the surface of the seat and aftermarket manufactured passenger seat heaters.
- After conducting car interior cleaning using steam or detergent, the seat should be dried properly. Afterward, check for normal operation of the PASSENGER AIR BAG "OFF" and air bag warning lights.
- Any service related to the passenger seat and the ODS must be done at an authorized Kia dealership.
- After the passenger seat has been removed or installed for repair purposes, check for normal operation of the PASSENGER AIR BAG "OFF" and air bag warning lights with a person seated or not seated in the passenger seat.

⚠ WARNING

When the PASSENGER AIR BAG "OFF" symbol is illuminated, the passenger air bag system will not operate. The passenger air bag system will operate when necessary if the symbol is not illuminated.

*** NOTICE**

Do not modify or replace the front passenger seat. Don't place anything on or attach anything such as a blanket, front seat cover or aftermarket seat heater to the front passenger seat. This can adversely affect the Occupant Detection System.

⚠ WARNING**Occupant Detection System**

Riding in an improper position adversely affects the Occupant Detection System and may result in the deactivation of the front passenger airbag. It is important for the driver to instruct the passenger as to the proper seating instructions as contained in this manual.

Safety features of your vehicle

Air bag – advanced Supplemental Restraint System

- Do not place a heavy load in the front passenger seatback pocket or on the front passenger seat.



- Do not place feet on the front passenger seatback.



- Never sit with hips shifted towards the front of the seat.



- Never excessively recline the front passenger seatback.



- Never place feet on the dashboard.



Safety features of your vehicle

- Never lean on the door or center console.
- Never sit on one side of the front passenger seat.



- Do not sit on the passenger seat wearing heavily padded clothes such as ski wear and hip protector.



- Do not place electronic devices such as laptops, DVD player, or conductive materials such as water bottles on the passenger seat.

Air bag - advanced Supplemental Restraint System

- Do not use electronic devices such as laptops and satellite radios which use inverter chargers.



- Wet passenger seat
Do not spill liquid in the passenger seat. Spilled liquid on the passenger seat may cause the air bag warning light to illuminate or malfunction. If any liquid is spilled, make sure the seat has been completely dried before driving the vehicle.



Proper position



When an adult is seated in the front passenger seat, if the PASSENGER AIR BAG "OFF" indicator is on, change the ENGINE START/STOP button to the OFF position and ask the passenger to sit properly (sitting upright with the seatback in an upright position, centered on the seat cushion with their seat belt on, legs comfortably extended and their feet on the floor). Restart the vehicle and have the person remain in that position. This will allow the system to detect the person and to enable the passenger air bag.

If the PASSENGER AIR BAG "OFF" indicator is still on, ask the passenger to move to the rear seat.

⚠ WARNING

PASSENGER AIR BAG "OFF" light

Do not allow an adult passenger to ride in the front seat when the PAS-

SENGER AIR BAG "OFF" indicator is illuminated, because the air bag will not deploy in the event of a crash. The driver must instruct the passenger to reposition himself in the seat. Failure to properly position yourself may lead to air bag deactivation resulting in air bag non-deployment in a collision. If the PASSENGER AIR BAG "OFF" indicator remains illuminated after the passenger repositions themselves properly and the car is restarted, it is recommended that passenger move to the rear seat because the passenger's front air bag will not deploy.

*** NOTICE**

The PASSENGER AIR BAG "OFF" indicator illuminates for about 4 seconds after the ENGINE START/STOP button is turned to the ON position after the vehicle is started. If the front passenger seat is occupied, the occupant detection sensor will then classify the front passenger after several more seconds.

- Even though your vehicle is equipped with the Occupant Detection System, never install a Child Restraint System in the front passenger's seat. A deploying air bag can forcefully strike a

child resulting in serious injuries or death.

Any child age 12 and under should ride in the rear seat. Children too large for child restraints should use the available lap/shoulder belts. No matter what type of crash, children of all ages are safer when restrained in the rear seat.

If the ODS is not working properly, the Supplemental Restraint System (SRS) air bag warning light on the instrument panel will illuminate because the passenger's front air bag is connected with the ODS. If there is a malfunction of the ODS the PASSENGER AIRBAG  "OFF" indicator will not illuminate. In this case, the passenger's front airbag will inflate in frontal impact crashes even if there is no occupant in the front passenger seat.

Driver's and passenger's front air bag

Your vehicle is equipped with an advanced supplemental restraint (air bag) system and lap/shoulder belts at both the driver and passenger seating position.

Driver's front air bag



Driver's knee air bag



Passenger's front air bag



The indication of the system's presence are the letters "AIR BAG" located on the air bag pad cover on

the steering wheel and the passenger's side front panel pad above the glove box.

The Supplemental Restraint System (SRS) consists of air bags installed under the pad covers in the center of the steering wheel and the passenger's side front panel above the glove box.

The purpose of the SRS is to provide the vehicle's driver and/or the front passenger with additional protection than that offered by the seat belt system alone in case of a frontal impact of sufficient severity. The SRS uses sensors to gather information about the driver's and front passenger's seat belt usage and impact severity.

The seat belt buckle sensor determines if the front passenger's seat belt is fastened.

These sensors provide the ability to control the SRS deployment based on whether or not the seat belts are fastened, and how severe the impact is.

The advanced SRS offers the ability to control the air bag inflation with two levels. A first stage level is provided for moderate-severity impacts. A second stage level is provided for more severe impacts.

According to the impact severity and seat belt usage, the SRS Control

Module (SRSCM) controls the air bag inflation. Failure to properly wear seat belts can increase the risk or severity of injury in an accident.

Additionally, your vehicle is equipped with an Occupant Detection System (ODS) in the front passenger's seat. The ODS detects the presence of a passenger in the front passenger's seat and will turn off the front passenger's air bag under certain conditions. For more detail, see "Occupant Detection System (ODS)" on page 3-59.

⚠ WARNING

Modification to the seat structure can cause the air bag to deploy at a different level than should be provided.

Manufacturers are required by government regulations to provide a contact point concerning modifications to the vehicle for persons with disabilities, which modifications may affect the vehicle's advanced air bag system. That contact is Kia's toll-free Customer Experience Department at 1-877-KIA-AUTO (1-877-542-2886). However, Kia does not endorse nor will it support any changes to any part or structure of the vehicle that could affect the advanced air bag system, including the ODS.

⚠ WARNING**Replacement/modifications**

The front passenger seat, dashboard or door should not be replaced except by an authorized Kia dealer using original Kia parts designed for this vehicle and model. Any other such replacement or modification could adversely affect the operation of the Occupant Detection System and your advanced air bags.

Advanced air bags are combined with pre-tensioner seat belts to help provide enhanced occupant protection in frontal crashes. Front air bags are not intended to deploy in collisions in which sufficient protection can be provided by the seat belt.

*** NOTICE**

Air bags can only be used once – have an authorized Kia dealer replace the air bag immediately after deployment.

Front air bags are not intended to deploy in side-impact, rear-impact or rollover crashes. However, when frontal deployment threshold is satisfied at side-impact, front air bags may deploy. In addition, front air bags will not deploy in frontal crashes below the deployment threshold.

⚠ WARNING**SRS Wiring**

Do not tamper with or disconnect SRS wiring or other components of the SRS system. Doing so could result in injury, due to accidental deployment of the air bags or by rendering the SRS inoperative.

⚠ WARNING**No attaching objects**

No objects (such as crash pad cover, cellular phone holder, cup holder, perfume or stickers) should be placed over or near the air bag modules on the steering wheel, instrument panel, windshield glass, and the front passenger's panel above the glove box. Such objects could cause harm if the vehicle is in a crash severe enough to cause the air bags to deploy.

Do not place any objects over the air bag or between the air bag and yourself.

Additionally, never place or insert any object into any small opening near side airbag labels attached to the vehicle seats.

When the air bag deploys, the object may affect the deployment and result in unexpected accident or bodily harm.

Side air bag

Your vehicle is equipped with a side air bag in each front seat.



* The actual air bags in the vehicle may differ from the illustration.

The purpose of the air bag is to provide the vehicle's driver and/or the front passenger with additional protection than that offered by the seat belt alone.

- The side air bags are designed to deploy during certain side-impact collisions, depending on the crash severity of impact.

- The side air bags may deploy on the side of the impact or on both sides.
- The side and/or curtain air bags on both sides of the vehicle will deploy if a rollover or possible rollover is detected.
- The side air bags are not designed to deploy in all side impact or rollover situations.

⚠ WARNING

Unexpected deployment

Avoid impact to the side impact air-bag sensor when the ENGINE START/STOP button is ON to prevent unexpected deployment of the side air bag.

- The side air bag is supplemental to the driver's and the passenger's seat belt systems and is not a substitute for them. Therefore your seat belts must be worn at all times while the vehicle is in operation.
- For best protection from the side air bag system and to avoid being injured by the deploying side air bag, both front seat occupants should sit in an upright position with the seat belt properly fastened. The driver's hands should be placed on the steering wheel at the 9:00 and 3:00 positions. The passenger's arms and hands should be placed on their laps.

⚠ WARNING**Deployment**

Do not install any accessories including seat covers, on the side or near the side air bag as this may affect the deployment of the side air bags.

- If seat or seat cover is damaged, have the vehicle checked and repaired by an authorized Kia dealer. Inform the dealer that your vehicle is equipped with side air bags and an Occupant Detection System (ODS).

⚠ WARNING**Flying objects**

Do not place any objects (an umbrella, bag, etc.) between the front door and the front seat. Such objects may become dangerous projectiles if the side airbag inflates.

⚠ WARNING**No attaching objects**

- Do not place any objects over the air bag or between the air bag and yourself. Also, do not attach any objects around the area the air bag inflates such as the door, side door glass, front and rear pillar.
- Do not put any objects between the side airbag label and seat cushion. It could cause harm if the

vehicle is in a crash severe enough to cause the air bags to deploy.

- Never place or insert any object into any small opening near side airbag labels attached to the vehicle seats. When the air bag deploys, the object may affect the deployment and result in unexpected accident or bodily harm.
- Do not install any accessories on the side or near the side air bags.

Curtain air bag

Curtain air bags are located along both sides of the roof rails above the front and rear doors.





* The actual air bags in the vehicle may differ from the illustration.

They are designed to help protect occupants in certain side impacts and to help prevent them from ejecting out of the vehicle as a result of a rollover, especially when the seatbelts are also in use.

- The curtain air bags are designed to deploy during certain side impact collisions, depending on the severity of impact. However, when side deployment threshold is satisfied at front-impact, side air bags may deploy.
- The curtain air bags may deploy on the side of the impact or on both sides.
- Also, the curtain air bags on both sides of the vehicle will deploy in certain rollover situations.
- The curtain air bags are not designed to deploy in all side impact or rollover situations.

Do not allow the passengers to lean their heads or bodies against the

doors, put their arms on the doors, stretch their arms out of the window or place objects between the doors and passengers when they are seated on seats equipped with side impact and/or curtain air bags.

* NOTICE

Never try to open or repair any components of the side and curtain air bag system. This should only be done by an authorized Kia dealer.

⚠ WARNING

No attaching objects

- Do not place any objects over the air bag. Also, do not attach any objects around the area the air bag inflates such as the door, side door glass, front and rear pillar, roof side rail.
- Do not hang hard, breakable, or heavy objects on the coat hooks for safety reasons.

Air bag collision sensors

The air bag collision sensors are located in the following positions



OON031070L



* The actual shape and position of sensors may differ from the illustration.

1. Supplemental Restraint System (SRS) control module / rollover sensor
2. Front impact sensor
3. Side pressure sensor
4. Side impact sensor
5. Side impact sensor

⚠ WARNING

Air bag sensors

- Do not hit or allow any objects to impact the locations where air bags or sensors are installed. This may cause unexpected air bag deployment, which could result in serious personal injury or death.
- If the installation location or angle of the sensors is altered in any way, the air bags may deploy when they should not or they may not deploy when they should. Therefore, do not try to perform maintenance on or around the air bag sensors. Have the vehicle checked and repaired by an authorized Kia dealer.
- Do not arbitrarily touch the front impact sensor. When the angle of the sensor is changed, the air bag system may malfunction.

Problems may arise if the sensor installation angles are changed due to the deformation of the front bumper, front end module, body or front doors where side collision sensors are installed. Have the vehicle checked and repaired by an authorized Kia dealer.

Installing bumper guards (or side step or running board) or replacing a bumper (or front door module) with

non-genuine parts may adversely affect your vehicle's collision and air bag deployment performance.

Why didn't my air bag go off in a collision? (Inflation and non-inflation conditions of the air bag)

There are many types of accidents in which the air bag would not be expected to provide additional protection.

These include rear impacts, second or third collisions in multiple impact accidents, as well as low speed impacts.

Air bag inflation conditions

Front air bags



Front air bags are designed to inflate in a frontal collision depending on several factors, including the severity of impact of the front collision.

Side and/or curtain air bags



OON031076L



OON038067NR

* The actual air bags in the vehicle may differ from the illustration. Side and/or curtain air bags are designed to inflate when an impact is detected by side collision sensors depending on several factors, including the severity of impact resulting from a side impact collision. Also, the side and curtain air bags are designed to inflate when a rollover is detected by a rollover sensor.

Although the front air bags (driver's and front passenger's air bags) are primarily designed to inflate in frontal collisions, they may inflate in other types of collisions if the front impact sensors detect a sufficient frontal force in another type of impact.

Similarly, although side and curtain air bags are designed to inflate in certain side impact collisions, they may inflate in other types of collisions where a side force is detected by the sensors. For instance, side air bag and/or curtain air bags may inflate if rollover sensors indicate the possibility of a rollover occurring (even if none actually occurs) or in other situations, including when the vehicle is tilted while being towed. Even if side and/or curtain air bags do not provide impact protection in a rollover, they will deploy to prevent ejection of occupants, especially those who are restrained with seat belts.

If the vehicle chassis is impacted by bumps or objects on unimproved roads, the air bags may deploy. Drive carefully on unimproved roads or on surfaces not designed for vehicle traffic to prevent unintended air bag deployment.

Air bag non-inflation conditions

- Air bags may not deploy in certain low-speed collisions where the air bag would not add any benefit beyond the protection already offered by the seat belts.



- Air bags are not designed to inflate in rear collisions, because occupants are moved backward by the force of the impact. In this case, inflated air bags would not be able to provide any additional benefit.



- Front airbags may not inflate in side impact collisions, because passengers move in the direction

of the collision. Thus, in side impacts, frontal airbag deployment would not provide additional occupant protection.



- In an angled collision, the force of impact may direct the occupants in a direction where the air bags would not be able to provide any additional benefit, and thus the sensors may not deploy any air bags.



- Just before impact, drivers often brake heavily. Such heavy braking lowers the front portion of the vehicle causing it to "ride" under a vehicle with a higher ground

clearance. Air bags may not inflate in this "under-ride" situation because deceleration forces that are detected by sensors may be significantly reduced by such "under-ride" collisions.



- Front air bags may not inflate in all rollover accidents when the SRS Control Module (SRSCM) indicates that the front air bag deployment would not provide additional occupant protection.

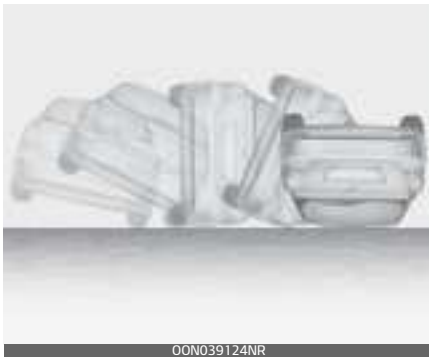

- Airbags may not inflate if the vehicle collides with an object such as a utility pole or tree. This is because the point of impact is

concentrated in one area and the full force of the impact is not delivered to the sensors.



Supplemental Restraint System (SRS) care

The Supplemental Restraint System (SRS) is virtually maintenance-free and so there are no parts you can safely service by yourself.

If the SRS air bag warning light does not illuminate, or continuously remains on, have your vehicle immediately inspected by an authorized Kia dealer.

Any work on the SRS, such as removing, installing, repairing, or any work on the steering wheel, the front passenger's panel, front seats and roof rails must be performed by an authorized Kia dealer. Improper handling of the SRS may result in serious personal injury.

For cleaning the air bag pad covers, use only a soft, dry cloth or one which has been moistened with

plain water. Solvents or cleaners could adversely affect the air bag covers and proper deployment of the system.

If components of the air bag system must be discarded, or if the vehicle must be scrapped, certain safety precautions must be observed. An authorized Kia dealer knows these precautions and can give you the necessary information. Failure to follow these precautions and procedures could increase the risk of bodily injury.

⚠ WARNING

Tampering with SRS

Do not tamper with or disconnect SRS wiring or other components of the SRS system. Doing so could result in the accidental inflation of the air bag or render the SRS inoperative.

⚠ WARNING

Towing Vehicle

Always have the ignition off when your vehicle is being towed. The side air bags may inflate if the vehicle is tilted such as when being towed because of the rollover sensors in the vehicle.

Adding equipment to or modifying your air bag-equipped vehicle

If you modify your vehicle by changing your vehicle's frame, bumper system, front end or side sheet metal or ride height, this may affect the operation of your vehicle's air bag system.

Air bag warning label

Air bag warning labels, some required by the Canada Motor Vehicle Safety Standards (CMVSS), are attached to the sun visor to alert the driver and passengers of potential risks of the air bag system.



Smart key	4-7
• Replacing smart key battery	4-12
• Smart key immobilizer system.....	4-13
• This device complies with Industry Canada licence-exempt RSS standard(s).	4-13
Theft-alarm system	4-14
• Armed stage.....	4-14
• Theft-alarm stage	4-15
• Disarmed stage.....	4-15
Door locks	4-16
• Operating door locks from outside the vehicle	4-16
• Operating door locks from inside the vehicle	4-18
• Door lock/unlock features.....	4-19
• Electronic child safety lock system.....	4-20
• Safe Exit Assist (SEA)	4-21
• Rear Occupant Alert (ROA) system.....	4-22
Manual liftgate	4-24
• Opening the manual liftgate.....	4-24
• Closing the manual liftgate.....	4-25
• Opening the manual liftgate in emergency	4-26
Power liftgate	4-27
• Opening the power liftgate	4-28
• Closing the power liftgate	4-29
• Power liftgate non-opening conditions.....	4-30
• Automatic reversal.....	4-31
• Setting the speed of opening/closing of power liftgate.....	4-32
• Resetting the power liftgate.....	4-32
• Setting the opening height of the power liftgate	4-33
Smart Power Liftgate	4-33

4 Features of your vehicle

• Using the smart power liftgate	4-33
• Deactivating the smart power liftgate with the smart key.....	4-35
• Detecting area.....	4-36
Windows	4-37
• Window opening and closing.....	4-39
• Power window lock switch.....	4-40
Hood	4-42
• Opening the hood	4-42
• Closing the hood	4-43
Fuel filler door	4-44
• Opening the fuel filler door	4-44
• Closing the fuel filler door	4-45
Dual Wide Sunroof	4-48
• Sunshade (Front)/Power sunshade (Rear)	4-49
• Tilt open/close (Front)	4-50
• Slide open/close (Front).....	4-51
• Automatic reversal.....	4-51
• Resetting the sunroof	4-52
• Sunroof open warning	4-53
Sunroof	4-54
• Sunshade.....	4-54
• Tilt open/close.....	4-55
• Slide open/close	4-55
• Automatic reversal.....	4-56
• Resetting the sunroof	4-57
• Sunroof open warning	4-58
Steering wheel.....	4-58
• Electric Power Steering (EPS) system.....	4-58

• Tilt & telescopic steering wheel	4-60
• Heated steering wheel	4-61
• Horn	4-61
Mirrors	4-62
• Inside rearview mirror	4-62
• Outside rearview mirror	4-67
Instrument cluster	4-71
• Instrument cluster control	4-72
• Gauges	4-72
• Transmission shift indicator	4-75
LCD display	4-76
• LCD Display Control	4-76
• LCD Display Modes	4-77
LCD displays	4-87
• Trip information (trip computer)	4-87
• Drive mode	4-90
• Service Modeservice mode	4-90
• Driving info display	4-90
• LCD display messages	4-91
Warning and indicator lights	4-96
• Warning lights	4-96
• Indicator lights	4-102
Head-Up Display (HUD)	4-106
Rear View Monitor (RVM)	4-108
• Rear View Monitor – Top view	4-108
360 ° camera monitoring system	4-109
Reverse Parking Distance Warning (PDW)	4-111
Forward/Reverse Parking Distance Warning (PDW)	4-114

4 Features of your vehicle

Blind-Spot View Monitor (BVM)	4-119
• To turn on Blind-Spot View Monitor	4-119
• To turn off Blind-Spot View Monitor	4-119
Lighting	4-120
• Battery saver function	4-120
• Daytime Running Light (DRL)	4-120
• Lighting control	4-121
• Operating high beam	4-122
• Operating turn signals and lane change signals.....	4-123
• Operating front fog light	4-124
• High Beam Assist (HBA)	4-124
Wipers and washers	4-127
• Operating windshield washer	4-129
• Operating rear window wiper and washer switch.....	4-130
Interior lights	4-131
• Automatic turn off function	4-131
• Map lamp	4-131
• Room lamp.....	4-132
• Liftgate room lamp	4-132
• Vanity mirror lamp.....	4-132
• Glove box lamp.....	4-133
Welcome system	4-133
Defroster	4-134
• Operating rear window defroster	4-134
• Operating outside mirror defroster	4-135
Climate control system	4-136
• System operation	4-136
• Climate control air filter	4-138

- Checking the amount of air conditioner refrigerant and compressor lubricant4-139
- Automatic climate control system4-140**
- Heating and air conditioning automatically4-141
- Heating and air conditioning manually4-142
- Controlling rear climate4-147
- Windshield defrosting and defogging4-152**
- Defogging inside windshield with manual climate control system.....4-152
- Defrosting outside windshield with manual climate control system.....4-153
- Defogging inside windshield with the automatic climate control4-153
- Defrosting outside windshield with automatic climate control.....4-154
- Defogging logic4-154
- Auto Defogging System (ADS) (only for automatic climate control system).....4-155
- Additional features of climate control4-156**
- Sunroof inside air recirculation4-156
- Automatic ventilation4-156
- Storage compartment4-157**
- Center console storage4-158
- Glove box.....4-158
- Sunglass holder4-158
- Luggage box4-159
- Interior features4-159**
- Cup holder4-159
- Seat warmer4-161

4 Features of your vehicle

• Air ventilation seat	4-162
• Sun visor	4-163
• Power outlet.....	4-164
• USB charger	4-165
• AC inverter	4-166
• Wireless smart phone charging system	4-167
• Coat hook	4-171
• Side curtain	4-171
• Floor mat anchor(s)	4-172
• Luggage net holder	4-172
Exterior features	4-173
• Roof rack.....	4-173
Audio system.....	4-175
• Antenna.....	4-175
• USB port.....	4-175
• How vehicle radio works.....	4-175
Declaration of Conformity.....	4-178
• IC.....	4-178

Features of your vehicle

Smart key

The mechanical key and various remote functions are integrated into the smart key for convenience to the driver.

Record your key number



The key code number is stamped on the bar code tag attached to the key set. Should you lose your keys, this number will enable an authorized Kia dealer to duplicate the keys easily. Remove the bar code tag and store it in a safe place. Also, record the code number and keep it in a safe and handy place, but not in the vehicle.

The key code number is stamped on the bar code tag

Smart key function

To remove the mechanical key, press and hold the release button (1) and remove the mechanical key (2).

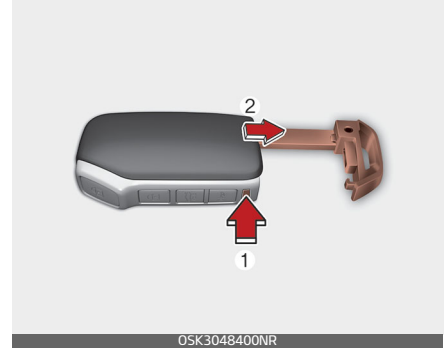

To reinstall the mechanical key, put the key into the hole and push it until a click sound is heard.

With a smart key, you can lock or unlock a door (and liftgate).

Refer to the following for more details.

⚠ WARNING

Smart key

Never leave the keys in your vehicle with unsupervised children. Leaving children unattended in a vehicle with the smart key is dangerous even if the ENGINE START/STOP button is not in the ACC or ON position. Children copy adults and they could press the ENGINE START/STOP button. The key would enable children to operate power windows or other

controls, or even make the vehicle move, which could result in serious bodily injury or death.

Locking



OON048002NR

Pressing the button of the front outside door handles with all doors (and liftgate) closed and any door unlocked, locks all the doors (and liftgate).

The hazard warning lights will blink once to indicate that all doors (and liftgate) are locked. The button will only operate when the smart key is within 0.7~1 m (28~40 inches) from the outside door handle. If you want to make sure that a door has locked or not, you should check the door lock button inside the vehicle or pull the outside door handle.

In some instances, when the outside door button is pressed the doors will not lock and an audible chime will sound if any of the following occurs:

- The smart key is in the vehicle.
- The ENGINE START/STOP button is in the ACC or ON position.

- Any door except the liftgate is opened.

Unlocking

Pressing the button of the front outside door handles, with all doors (and liftgate) closed and locked, unlocks all the doors (and liftgate). The hazard warning lights will blink twice to indicate that all doors (and liftgate) are unlocked. The button will only operate when the smart key is within 0.7~1 m (28~40 inches) from the outside door handle.

When the 2-press unlock function is activated:

- If you press the Door Unlock button (2) on the smart key, the driver's door will unlock.
- If you press the Door Unlock button (2) on the smart key within four seconds again, then all the doors will unlock.
- If you press the driver's outside door handle button, the driver's door will unlock.
- If you press the driver's outside door handle button within four seconds again, then all the doors will unlock.

* NOTICE

You can activate or deactivate the 2-press unlock function. Refer to "User Settings mode" on page 4-79.

Liftgate unlocking

If you are within 0.7~1 m (28~40 inches) from the outside liftgate handle, with your smart key in possession, the liftgate will unlock and open when you press the liftgate handle switch.

The hazard warning lights will blink twice to indicate that the liftgate is unlocked.

Also, once the liftgate is opened and then closed, the liftgate will lock automatically.



Lock (1)

All doors are locked if the lock button is pressed. If all doors are closed, the hazard warning lights will blink and the chime will sound once to indicate that all doors are locked. Also, if the lock button is pressed once more within 4 seconds, the hazard warning lights will blink and the chime will sound once to confirm that the door is locked.

However, if any door remains open, the hazard warning lights (and/or the chime) will not operate. But if all doors are closed after the lock but-

ton is pressed, the hazard warning lights will blink once.

Unlock (2)

The driver's door is unlocked if the unlock button is pressed once. The hazard warning lights will blink twice and the chime will sound twice to indicate that the driver's door is unlocked.

All doors are unlocked if the unlock button is pressed once more within 4 seconds. The hazard warning lights will blink (for smart key, the chime also sounds) twice again to indicate that all doors are unlocked. After pressing this button, the doors will lock automatically unless you open any door within 30 seconds. If you attempt to lock or unlock the door by pressing the door lock/unlock button in any of the following situations, the door will not be locked or unlocked.

- When you want to lock or unlock the door in the ACC or ON state.
- When you want to lock a door in a car with one or more doors open.

Depending on the vehicle, the driver can turn off or set the 2-press unlock setting function.

* NOTICE

If the keyless entry system is inoperative due to exposure to water or liquids, it will not be covered by your manufacturer's vehicle warranty.

Liftgate open (3)

If you press the button for longer than a second, the lock will be released or the lift gate will be opened according to the options of the vehicle.

Once the liftgate is opened and then closed, the liftgate will lock automatically.

Panic (4)

If you press the key's panic button in an emergency situation, the alarm system will be activated and alert others around you of the emergency situation.

1. Press the panic button (4) for a few seconds.
2. The horn sounds and hazard warning light flash for a few seconds.

To stop the horn and lights, press any button on the smart key.

Remote start (5)

You can start the engine and turn on the climate system by pressing the remote start button (5) outside the vehicle equipped with automatic transmission.

To start and stop engine remotely :

1. Press the door lock button (1), and then the hazard warning lights blink once to alert you.
2. Press the remote start button (5) for more than 2 seconds to start engine within 4 seconds after pressing the door lock button (1).
3. While remote starting, the hazard warning lights blink. If you want

to stop the engine, press the remote start button (5) again.

The climate system will be continuously maintained, as selected when the engine is restarted. If the climate system turned off before you stopped the engine, the climate system does not operate when you start the engine remotely.

Start-up

You can start the vehicle without inserting the key.

* For information, refer to "ENGINE START/STOP button" on page 5-8.

*** NOTICE****Loss of the smart key**

A maximum of 2 smart keys can be registered to a single vehicle.

If you happen to lose your smart key, you will not be able to start the vehicle. You should immediately take the vehicle and remaining key to your authorized Kia dealer (tow the vehicle, if necessary) to protect it from potential theft.

*** NOTICE****Smart key precautions**

The smart key will not work if any of the following occur:

- The smart key is close to a radio transmitter such as a radio station or an airport which can interfere with normal operation of the smart key.

- The smart key is near a mobile two-way radio system or a cellular phone.
- Another vehicle's smart key is being operated close to your vehicle.

When the smart key does not work correctly, open and close the door with the mechanical key and contact an authorized Kia dealer.

If the smart key is in close proximity to your cell phone or smart phone, the signal from the smart key could be blocked by normal operation of your cell phone or smart phone. This is especially important when the phone is active, such as when making calls, receiving calls, text messaging, and/or sending/receiving emails. Avoid placing the smart key and your cell phone or smart phone in the same pants or jacket pocket and maintain adequate distance between the two devices.

* NOTICE

To prevent the electronic key from becoming damaged by magnetic fields, do not leave it near the following electrical appliances:

- TVs
 - Personal computers
 - Cellular phones, cordless phones and battery chargers
 - Table lamps
 - Induction cookers
-

* NOTICE

If you have to leave the vehicle's key with a parking attendant, remove the mechanical key for your own use and provide the attendant with the electronic key only.

* NOTICE

When bringing a key with wireless remote control function onto an airplane, make sure you do not press any button on the key while inside the cabin. If you are carrying the key in your bag etc., make sure that the buttons cannot be pressed accidentally. If you press a button, the key may emit radio waves that could interfere with the operation of the aircraft.

Replacing smart key battery

A smart key battery should last for several years, but if the smart key is not working properly, try replacing the battery with a new one.



If you are unsure how to use your smart key or replace the battery, contact an authorized Kia dealer.

1. Remove the mechanical key.
2. Pry open the rear cover.
3. Replace the battery with a new battery (CR2032). When replacing the battery, make sure the battery is in the correct position.
4. Install the battery in the reverse order of removal.

The smart key is designed to give you years of trouble-free use, however, it can malfunction if exposed to moisture or static electricity. If you are unsure how to use or replace the battery, contact an authorized Kia dealer.

⚠ WARNING

THIS PRODUCT CONTAINS A BUT-TON BATTERY

If swallowed, a lithium button battery can cause severe or fatal injuries within 2 hours.

Keep batteries out of reach of children.

If you think batteries may have been swallowed or placed inside any part of the body, seek immediate medical attention.

Using the wrong battery can cause the smart key to malfunction. Be sure to use the correct battery.

To avoid damaging the smart key, don't drop it, get it wet, or expose it to heat or sunlight.



An inappropriately disposed battery can be harmful to the environment and human health. Dispose the battery according to your local law(s) or regulations.

⚠ CAUTION

Smart key damage

Do not drop, get wet or expose the smart key to heat or sunlight, or it will be damaged.

⚠ WARNING**IC WARNING**

This device complies with Industry Canada licence-exempt RSS standard(s). Operation is subject to the following two conditions:

1. This device may not cause interference, and
2. This device must accept any interference, including interference that may cause undesired operation of the device.

Smart key immobilizer system

The immobilizer system protects your vehicle from theft. If an improperly coded key (or other device) is used, the vehicle's power system is disabled.

When the ENGINE START/STOP button is placed in the ON position, the immobilizer system indicator should come on briefly, then go off. If the indicator starts to blink, the system does not recognize the coding of the key.

Place the ENGINE START/STOP button in the OFF position, then place the ENGINE START/STOP button in the ON position again.

If the system repeatedly does not recognize the coding of the key, it is recommended that you contact your Kia dealer.

Do not attempt to alter this system or add other devices to it. Electrical problems could result that may make your vehicle inoperable.

If the following objects are placed near the ENGINE START/STOP button, there may be a problem with starting the engine.

1. Metal accessories
2. Another registered key
3. Keys registered in other vehicles
4. Electronic device

*** NOTICE**

When starting the vehicle, do not use the key with other immobilizer keys around. Otherwise, the vehicle may not start or may stop soon after it starts. Keep each key separate in order to avoid a starting malfunction.

This device complies with Industry Canada licence-exempt RSS standard(s).

Operation is subject to the following two conditions:

1. This device may not cause interference, and
2. This device must accept any interference, including interference that may cause undesired operation of the device.

* NOTICE

Changes or modifications not expressly approved by the party responsible for compliance could void the user's authority to operate the equipment. If the smart key is inoperative due to changes or modifications not expressly approved by the party responsible for compliance, it will not be covered by your manufacturer's vehicle warranty.

Theft-alarm system

The theft-alarm system is designed to provide protection from unauthorized entry into the vehicle.

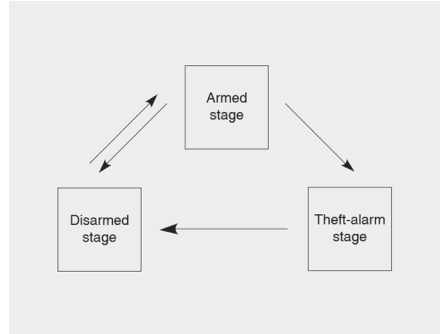

This system is operated in three stages: the first is the "Armed" stage, the second is the "Theft-alarm" stage, and the third is the "Disarmed" stage. If triggered, the system provides an audible alarm with blinking of the hazard warning lights.

⚠ CAUTION

Do not attempt to alter this system or add other devices to it.

Armed stage

Park the vehicle and stop the engine. Arm the system as described below.

1. Turn off the engine.
2. Make sure that all doors, the hood and liftgate are closed and latched.

- Lock the doors by pressing the button of the front outside door handle with the smart key in your possession.

After completion of the steps above, the hazard warning lights will operate once to indicate that the system is armed.

If any door (or liftgate) or hood remains open, the hazard warning lights and the chime will not operate and the theft-alarm will not arm. If all doors, liftgate and hood are closed after the lock button is pressed, the hazard warning lights blink once.

The system can also be armed by locking the doors with the key from the front doors; however, the hazard warning lights will not blink using this method.

- Lock the doors by pressing the lock button on the smart key. After completion of the steps above, the hazard warning lights will operate once to indicate that the system is armed.

* NOTICE

Do not arm the system until all passengers have left the vehicle. If the system is armed while a passenger(s) remains in the vehicle, the alarm may be activated when the remaining passenger(s) leaves the vehicle. If any door (or liftgate) or hood is opened within 30 seconds after the system enters the armed

stage, the system will be disarmed to prevent unnecessary alarm.

Theft-alarm stage

The alarm will be activated if any of the following occurs while the system is armed.

- A front or rear door is opened without using the smart key.
- The liftgate is opened without using the smart key.
- The hood is opened.

The horn will sound and the hazard warning lights will blink continuously for approximately 27 seconds, and the horn will repeat 3 times unless the system is disarmed. To turn off the system, unlock the doors with the transmitter (or smart key).

Disarmed stage

The system will be disarmed when:

- The door unlock button is pressed.
- The button of the front outside door is pressed while carrying the smart key.
- The engine is started. (within 3 seconds)

After pressing the unlock button, the hazard warning lights will blink and the chime will sound twice (in smart key) to indicate that the system is disarmed.

After pressing the unlock button, if any door (or liftgate) is not opened within 30 seconds, the system will be rearmed.

* NOTICE

- Avoid trying to start the engine while the alarm is activated. The vehicle starting motor is disabled during the theft-alarm stage. If the system is not disarmed with the transmitter, turn the ENGINE START/STOP button to the ON position and wait for 30 seconds. Then the system will be disarmed.
- If you lose your keys, consult your authorized Kia dealer.

Door locks

Get to know how to use the door lock so that you can lock or unlock the door if necessary.

Operating door locks from outside the vehicle



1. Pull out the door handle.
 2. Press the lever (1) located inside the bottom part of the cover with a key or flat-head screwdriver.
 3. Push out the cover (2) while pressing the lever.
 4. Turn the key toward the rear of the vehicle to unlock (A) and toward the front of the vehicle to lock (B).
- If you lock the driver's door with a key, only the driver's door will lock/unlock.

- From the driver's door, turn the key toward the rear of the vehicle once to unlock the driver's door and once more within 4 seconds to unlock all doors.
- Doors can also be locked and unlocked with the smart key.
- Once the doors are unlocked, they may be opened by pulling the door handle.
- When closing the door, push the door by hand. Make sure the doors are closed securely.
- Before pulling the outside door handle, remove the key to avoid damaging the paintwork.

* NOTICE

- In cold and wet climates, door lock and door mechanisms may not work properly due to freezing conditions.
- If the door is locked/unlocked multiple times in rapid succession with either the vehicle key or door lock switch, the system may stop operating temporarily in order to protect the circuit and prevent damage to system components.

⚠ WARNING

- Securely close your door before you begin driving. Failure to fully close your door may cause it to open during vehicle operation.
- Keep your body out of the way of the closing door to prevent injuries.

⚠ WARNING

If adult passengers must remain in the vehicle while it is very hot or cold outside, there is risk of injuries or danger to life. Do not lock the vehicle from the outside when there are adult passengers in the vehicle.

⚠ CAUTION

Do not unnecessarily open and close the door repeatedly or with excessive force. Such action can damage the vehicle door.

* NOTICE

Always place the ENGINE START/STOP button in the OFF position, engage the parking brake, close all windows, and lock all doors when leaving your vehicle unattended.

Operating door locks from inside the vehicle

You can operate door locks with the door lock button or central door lock switch.

With the door lock button



- To unlock a door, push the door lock button (1) to the "Unlock" position. The red mark on the door lock button will be visible.
- To lock a door, push the door lock button (1) to the "Lock" position. If the door is locked properly, the red mark on the door lock button will not be visible.
- To open a door, pull the door handle (2) outward.
- If the inner door handle of the driver's (or front passenger's) door is pulled when the door lock button is in the lock position, the button will unlock and the door will open.
- Doors cannot be locked if the smart key is in the vehicle and/or door is open.

Door lock malfunction

If a power door lock ever fails to function while you are in the vehicle, try one or more of the following techniques to exit:

- Operate the door unlock feature repeatedly (both electronic and manual) while simultaneously pulling on the door handle.
- Operate the other door locks and handles, front and rear.
- Lower a front window and use the key to unlock the door from outside.

⚠ WARNING

Do not pull the inner door handle of the driver's (or passenger's) door while the vehicle is moving.

With central door lock switch

Driver side



Passenger side



Operate by pressing the central door lock switch.

- When pressing the right portion (1) for the driver side or the upper portion (1) for the passenger side of the switch, all vehicle doors will lock.
- When pressing the left portion (2) for the driver side or the lower portion (2) for the passenger side of the switch, all vehicle doors will unlock.
- If the smart key is in the vehicle and any door is opened, the doors will not lock even though the right portion (1) for the driver side or upper portion (1) for the passenger side of the central door lock switch is pressed.

⚠ WARNING

Doors

- The doors should always be fully closed and locked while the vehicle is in motion to prevent accidental opening of a door.

- Be careful when opening doors and watch for vehicles, motorcycles, bicycles or pedestrians approaching the vehicle in the path of the door. Opening a door when something is approaching can cause damage or injury.

⚠ WARNING

Unattended children/animals

Never leave children or animals unattended in your vehicle. An enclosed vehicle can become extremely hot, causing death or severe injury to unattended children or animals who cannot escape the vehicle.

Door lock/unlock features

The vehicle is equipped with door lock/unlock features for the safety and convenience of passengers.

Impact sensing door unlock system

All doors will automatically unlock when an impact causes the air bags to deploy.

Speed sensing door lock system

All doors will automatically lock after the vehicle speed exceeds 15 km/h (10 mph).

You can activate or deactivate the auto door lock/unlock features in

the vehicle. Refer to "User Settings mode" on page 4-79.

Electronic child safety lock system

If you push the electronic child safety lock switch and the indicator illuminates, rear passengers cannot open the rear door from inside the vehicle.



To cancel the electronic child safety lock system, push the electronic child safety lock system switch one more time and then the indicator turns off.

Safe Exit Assist is operated when the electronic child safety lock system is activated and Safe Exit Assist is selected in the cluster. However, Safe Exit Assist does not automatically activate the electronic child safety lock system.

The electronic child safety lock system is always on when the ENGINE START/STOP button is in the ON or ignition ON state and for approxi-

mately 10 minutes after the engine is turned off.

If your vehicle is equipped with the Electronic child safety lock system, the Child-protector rear door locks, which are manually operated, are not provided.

If electronic child safety lock system is activated, rear passenger cannot open or close the rear window also. For more details, refer to "Windows" on page 4-37.

⚠ CAUTION

If the Electronic child safety lock system is not operated when pushing the Electronic child safety lock switch, the message is displayed and the alarm will sound.



If this occurs, have the system checked by a professional workshop. Kia recommends to visit an authorized Kia dealer.

Safe Exit Assist (SEA)

Safe Exit Assist is provided to help prevent passengers from opening their door by warning them when a vehicle approaching from the rear is detected after your vehicle has stopped.



When the function detects an approaching vehicle, the rear doors will not unlock even if the driver attempts to unlock them using the electronic child safety lock button.

The "Check surroundings then try again" warning message appears on the cluster and a warning sounds.

However if you press the switch within 10 seconds after the warning message appears (the indicator on the switch will turn off), the function determines that the driver has intentionally unlocked the doors, being aware of the rear status, and unlocks the doors regardless of the actual rear situation.

When the function detects an approaching vehicle the moment a door is opened, the "Watch for traffic" warning message appears on the cluster and a warning sounds.

- The above 2 and 3 functions are activated when you select 'Driver Assistance → Blind-Spot Safety → Safe Exit Assist (SEA)' from the User Settings mode in the cluster LCD display.
- The Electronic child safety lock system is always on when the ENGINE START/STOP button is in the ON or ignition ON state and for approximately 10 minutes after the engine is turned off. After about 10 minutes, the indicator on the switch turns off and you cannot deactivate the electronic child safety lock system. To deactivate the electronic child safety lock system, press the Electronic child safety lock switch again with the ENGINE START/STOP button in the ON position or after starting the engine.
- When the power is supplied again after removing/discharging the battery while the child safety lock was in the lock position, press the child safety lock switch once again. This makes the state of the indicator on the child safety lock switch correspond with the actual status of the electronic child safety lock system.

- If the airbag is activated while the child safety lock switch is ON (the indicator on the switch illuminates) it automatically switches OFF and the rear door is unlocked.

* NOTICE

- Safe Exit Assist may not operate normally if there is any vehicle or obstacle at the rear area of your vehicle.
- Safe Exit Assist may not operate normally when a vehicle is coming rapidly two lanes over from your vehicle or a vehicle is approaching at a fast speed from the rear in the lane next to your vehicle.
- Safe Exit Assist may be activated later than normal or may not operate normally if a vehicle is approaching fast from the rear of your vehicle.
- Safe Exit Assist will not operate if there is a malfunction with Blind-Spot Collision-Avoidance Assist as follows:
 - When Blind-Spot Collision-Avoidance Assist warning message appears.
When Blind-Spot Collision-Avoidance Assist sensor or the sensor surrounding is polluted or covered.
 - When Blind-Spot Collision-Avoidance Assist does not warn or warns wrongly.

For more details, refer to cautions and limitations in "Blind-Spot Collision-Avoidance Assist (BCA)" on page 5-72.

⚠ WARNING

- The function does not detect every obstacle approaching the vehicle exit.
- The driver and passenger are responsible for any obstacles while exiting the vehicle. Always check the surrounding before you exit the vehicle.

Rear Occupant Alert (ROA) system (if equipped)

The Rear Occupant Alert (ROA) is provided to help prevent exiting the vehicle with a rear passenger left in the vehicle.

- 1st alert
 - When you open the front door after opening and closing the rear door and turning off the engine, the "Check rear seats" warning message appears on the cluster.
- 2nd alert
 - After the 1st alert the 2nd alert operates when any movement is detected in the rear seat after the driver's door is closed and all the doors are locked. The horn will activate for about

25 seconds. If the system continues to detect a movement the alert operates up to 8 times.

- Unlock the door with the remote key or smart key to stop the alert.
- The system detects movement in the vehicle for 24 hours after the door is locked.

The 2nd alert is activated only after the prior activation of the 1st alert.

You can activate or deactivate the ROA from the User Settings mode in the cluster LCD display. The option can be found under the following menu:

User Settings → Convenience → Rear Occupant Alert

* NOTICE

- Make sure that all the windows are closed. If the window is open, the alert may activate by the sensor detecting an unintended movement (e.g., wind or bugs).
- If you do not want to use the Rear Occupant Alert (ROA) system, press OK button on the steering wheel when the 1st alert is displayed on the cluster. Doing so will deactivate the 2nd alert once.
- If boxes or objects are stacked in the vehicle, the system may not detect the obstacle. Also, the warning may generate if the box or object falls off.
- The sensor may not operate normally if the sensor is obscured by foreign substances.

Cluster



Steering wheel



- The alert may activate if movement in the driver or passenger seat is detected.
- The alert may activate with the doors locked due to car wash or surrounding vibration or noise.
- Inside movement detection is stopped under remote start status.

* NOTICE

- Even if your vehicle is equipped with the Rear Occupant Alert (ROA) system, always make sure you check the rear seat before you exit the vehicle.
The alert may not operate if:
 - The movement does not continue for a certain period of time or the movement is small.
 - If a child sits on a vehicle seat without a child car seat.
 - The rear passenger is covered with an obstacle such as a blanket.
 - Also, always be cautious of the passenger's safety as the detection function and 2nd alert may not operate depending on the surrounding environment and certain conditions.

Manual liftgate

When you open the liftgate, you will see a space where you can load the cargo.

Opening the manual liftgate

The liftgate is locked or unlocked when all doors are locked or unlocked with the key, smart key or central door lock/unlock switch.

⚠ CAUTION

Liftgate lift

Make certain that you close the liftgate before driving your vehicle. Possible damage may occur to the liftgate gas lifters and attached hardware if the liftgate is not closed prior to driving.



- Only the liftgate is unlocked if the liftgate unlock button on the transmitter or smart key is pressed for approximately 1 second.
- If unlocked, the liftgate can be opened by pressing the handle and pulling it up.
- Once the liftgate is opened and then closed, the liftgate locks automatically. (All doors must be locked.)

* NOTICE

In cold and wet climates, door lock and door mechanisms may not work properly due to freezing conditions.

⚠ WARNING

The liftgate swings upward. Make sure no objects or people are near the rear of the vehicle when opening the liftgate.

Closing the manual liftgate

Lower and push down the liftgate firmly. Make sure that the liftgate is securely latched.



Make sure your hands, feet and other parts of your body are safely out of the way before closing the liftgate.

⚠ WARNING

Exhaust Fumes

The liftgate should always be kept completely closed while the vehicle is in motion. If it is left open or ajar, poisonous exhaust gases may enter the car and serious illness or death may result.

Opening the manual liftgate in emergency

Your vehicle is equipped with the emergency liftgate safety release lever located on the bottom of the liftgate. When someone is inadvertently locked in the luggage compartment.



The liftgate can be opened by doing as follows:

1. Input the mechanical key into the hole.
2. Push the mechanical key to the right (1).
3. Push the liftgate upwards.

⚠ WARNING

- No one should be allowed to occupy the cargo area of the vehicle at any time. The cargo area is a very dangerous location in the event of a crash.
- Use the release lever for emergencies only. Use with extreme caution, especially while the vehicle is in motion.

⚠ CAUTION

Make sure there are no people or objects around the liftgate before opening or closing the liftgate. Wait until the liftgate is open fully and stopped before loading or unloading cargo from the vehicle.

⚠ WARNING

Do not grasp the part supporting the liftgate (gas lifter), as this may cause serious injury.



Power liftgate (if equipped)

When you open the liftgate, you will see a space where you can load the cargo.



1. Power liftgate open/close button
2. Power liftgate handle switch
3. Power liftgate close button
4. Power liftgate open/close button

* NOTICE

If ENGINE START/STOP button is in the ON position, the power liftgate can operate when the shift lever is in P (Park).

⚠ WARNING

Unattended children/pets

Never leave children or animals unattended in your vehicle. Children or animals might operate the power liftgate in such a way that could result in injury to themselves or others or damage to the vehicle.

* NOTICE

In cold and wet climates, power liftgate may not work properly due to freezing conditions.

* NOTICE

Do not attach heavy objects to the power liftgate when you operate the power liftgate. Additional weight on liftgate could cause damage to the system.

⚠ WARNING

Make sure that there are no passengers or objects in the path of the power liftgate (or smart power liftgate) prior to use. Serious injury, damage to the vehicle or damage to surrounding objects may result if contact with the power liftgate (or smart power liftgate) occurs.



The liftgate swings upwards when it is opened. Therefore, make sure

that there is sufficient clearance above the liftgate.

⚠ CAUTION

It is recommended to open and close the liftgate automatically. Do not apply excessive force when opening or closing the lift gate manually. It may damage the power liftgate system.

Opening the power liftgate

The power liftgate will open automatically by doing one of the following:

- Press the power liftgate open/close button on the smart key for approximately one second.



- Press the power liftgate open/close button for approximately one second.

- For emergency stop while power liftgate operating, press the power liftgate open/close button shortly.



- Press the liftgate handle switch with the smart key in your possession.



Closing the power liftgate

- Press the power liftgate open/close button for approximately one second when the liftgate is opened. The liftgate will close automatically.



- For emergency stop while power liftgate operating, press the power liftgate open/close button shortly.
- Press the power liftgate close button when the liftgate is opened. The liftgate will close automatically.



At the beginning of the closure, the buzzer will sound twice.

- Press the power liftgate open/close button on the transmitter or

smart key for approximately one second when the liftgate is opened. The liftgate will close automatically.



⚠ WARNING

Make sure there are no people or objects around the liftgate before opening or closing the power liftgate. Wait until the liftgate is open fully and stopped before loading or unloading cargo from the vehicle.

Power liftgate non-opening conditions

The power liftgate will not open or close automatically, when the vehicle is moving more than 3km/h (2mph) or the automatic shift lever is not in P (Park) position.

*** NOTICE**

The chime will sound continuously if you drive over 3 km/h (2 mph) with the liftgate opened. Stop your vehicle at a safe place as soon as possi-

ble to check if your liftgate is opened.

*** NOTICE**

Do not operate the power liftgate more than 5 times continuously. It may damage the power liftgate system. If you operate the power liftgate more than 5 times continuously, the chime will sound 3 times and the power liftgate will not operate. At this time, stop operating the liftgate and leave it for more than 1 minute.

*** NOTICE**

- The power liftgate can be operated when the engine is not running. However, the power liftgate operation consumes large amounts of vehicle electric power. To prevent the battery from being discharged, do not operate it excessively.
- To prevent the battery from being discharged, do not leave the power liftgate in the open position for a long time.
- Do not modify or repair any part of the power liftgate by yourself. This must be done by an authorized Kia dealer.
- When jacking up the vehicle to change a tire or repair the vehicle,

do not operate the power liftgate. This could cause the power liftgate to operate improperly.

- In cold and wet climates, the power liftgate may not work properly due to freezing conditions.
- It is recommended to wait until the power liftgate is fully closed before starting the vehicle. The power liftgate may not close fully if the vehicle is started during automatic closing.

⚠ CAUTION

Never operate the power lift gate with any heavy objects attached (e.g. bicycles) as it could become damaged.

Automatic reversal



During power opening and closing if the power liftgate is blocked by an object or part of the body, the

power liftgate will detect the resistance.

- If the resistance is detected while opening the liftgate, it will stop and move in the opposite direction.
- If the resistance is detected while closing the liftgate, it will stop and move in the opposite direction.

However, if the resistance is weak such as from an object that is thin or soft, or the liftgate is near the latched position, the automatic stop and reversal may not detect the resistance.

If the automatic reversal feature operates continuously more than twice during opening or closing operation, the power liftgate may stop at that position. At this time, close the liftgate manually and operate the liftgate automatically again.

⚠ WARNING

Never place any object or part of your body in the path of the power liftgate as it is operating. Doing so could result in personal injury.

Setting the speed of opening/closing of power liftgate

You can adjust the speed by yourself.

How to set the speed

- Select 'Door' → 'Power liftgate speed' → 'Fast/Normal' on the user settings of the instrument cluster.
- You cannot change the speed when the power liftgate function is turned off or the liftgate is not completely closed.
- The power liftgate speed is initially set as 'fast'.

Please refer to "User Settings mode" on page 4-79.

* NOTICE

If the power liftgate does not operate normally, check again if the gear position is in P (Park) position.

Resetting the power liftgate

If the battery has been discharged or disconnected, or if the related fuse has been replaced or disconnected, the power liftgate may not work properly. For the power liftgate to operate normally, reset the power liftgate as follows:



1. Put the automatic shift lever in P (Park).
2. While pressing the liftgate close button, press the liftgate handle switch for more than 3 seconds. (the chime will sound)
3. Close the liftgate manually.

If the power liftgate does not work properly after the above procedure, have the system checked by an authorized Kia dealer.

* NOTICE

If the power liftgate does not operate normally, first check the following condition before using the power liftgate.

Make sure the automatic shift lever is in P (Park).

Setting the opening height of the power liftgate



The driver may set the height of a fully opened liftgate by following the below instruction.

1. Position the liftgate manually to the preferred height.
2. Press the liftgate close button for more than 3 seconds.
3. Close the liftgate manually after hearing the buzzer sound.

The liftgate will open to the height the driver has set up.

Smart Power Liftgate (if equipped)



On a vehicle equipped with a smart key, the liftgate can be opened using the Smart Power Liftgate system.

Using the smart power liftgate

The liftgate can be opened with no-touch activation when all of the below conditions have been satisfied.

- 15 seconds have passed after all doors have been closed and locked.
- The smart key is positioned within the detecting area for more than 3 seconds.

*** NOTICE**

- The Smart Power Liftgate does not operate when:
 - The smart key is detected within 15 seconds after the doors are closed and locked, and is continuously detected.
 - The smart key is detected within 15 seconds after the doors are closed and locked, and within 1.5 m (60 inches) from the front door handles. (for vehicles equipped with Welcome Light)
 - A door is not locked or closed.
 - The smart key is in the vehicle.

To activate the Smart Power Liftgate

1. Press the MODE button (📄) several times on the steering wheel until 'User Settings' menu appears on the LCD.
2. Select 'Door → Smart Power Liftgate' with the MOVE switch (∧ / ∨) and the OK button on the steering wheel.

For more information, refer to "LCD display" on page 4-76.



Detect and Alert

If you are in the detecting area 50~100 cm (20~39 inches) behind the vehicle) carrying a smart key, the hazard warning lights will blink and the chime will sound for about 3 seconds. This alerts you that the smart key has been detected and the liftgate will open.

*** NOTICE**

Do not approach the detecting area if you do not want the liftgate to open. If you have unintentionally entered the detecting area and the hazard warning lights and chime starts to operate, leave the detecting area with the smart key. The liftgate will stay closed.

Automatic opening



The hazard warning lights will blink and chime will sound 2 times and then the liftgate will open.

Make sure you close the liftgate before driving your vehicle.

Make sure there are no people or objects around the liftgate before opening or closing the liftgate. Make sure objects in the liftgate do not come out when opening the liftgate on a slope. It may cause serious injury. Make sure to deactivate the Smart Power Liftgate when washing your vehicle. Otherwise, the liftgate may open inadvertently. The key should be kept out of reach of children. Children may inadvertently open the Smart Power Liftgate while playing around the rear area of the vehicle.

⚠ CAUTION

Liftgate lift

Make certain that you close the liftgate before driving your vehicle. Possible damage may occur to the liftgate gas lifters and attached

hardware if the liftgate is not closed prior to driving.

Deactivating the smart power liftgate with the smart key



1. Door lock
2. Door unlock
3. Liftgate open and close
4. Panic
5. Remote start

- If you press any button of the smart key during the Detect and Alert stage, the Smart Power Liftgate function will be deactivated.

Make sure to be aware of how to deactivate the Smart Power Liftgate function for emergency situations.

*** NOTICE**

- If you press the door unlock button (2), the Smart Power Liftgate function will be deactivated temporarily. But, if you do not open any door for 30 seconds, the

smart power liftgate function will be activated again.

- If you press the liftgate open button (3) for more than 1 second, the liftgate opens.
- If you press the door lock button (1) or liftgate open button (3) when the Smart Power Liftgate function is not in the Detect and Alert stage, the smart power liftgate function will not be deactivated.
- In case you have deactivated the Smart Power Liftgate function by pressing the smart key button and opened a door, the smart power liftgate function can be activated again by closing and locking all doors.

- The alert stops once the smart key is positioned outside the detecting area during the Detect and Alert stage.

*** NOTICE**

- The Smart Power Liftgate function will not work if any of the following occurs:
 - The smart key is close to a radio transmitter such as a radio station or an airport which can interfere with normal operation of the transmitter.
 - The smart key is near a mobile two-way radio system or a cellular phone.
 - Another vehicle's smart key is being operated close to your vehicle.
- The detecting range may decrease or increase when:
 - One side of the tire is raised to replace a tire or to inspect the vehicle.
 - The vehicle is parked on a slope or unpaved road, etc.

Detecting area



OON041068

- The Smart Power Liftgate operates with a welcome alert if the smart key is detected within 50~100 cm (20~39 inches) from the liftgate.

Windows

The doors of this vehicle are equipped with power windows that can be operated by a switch.

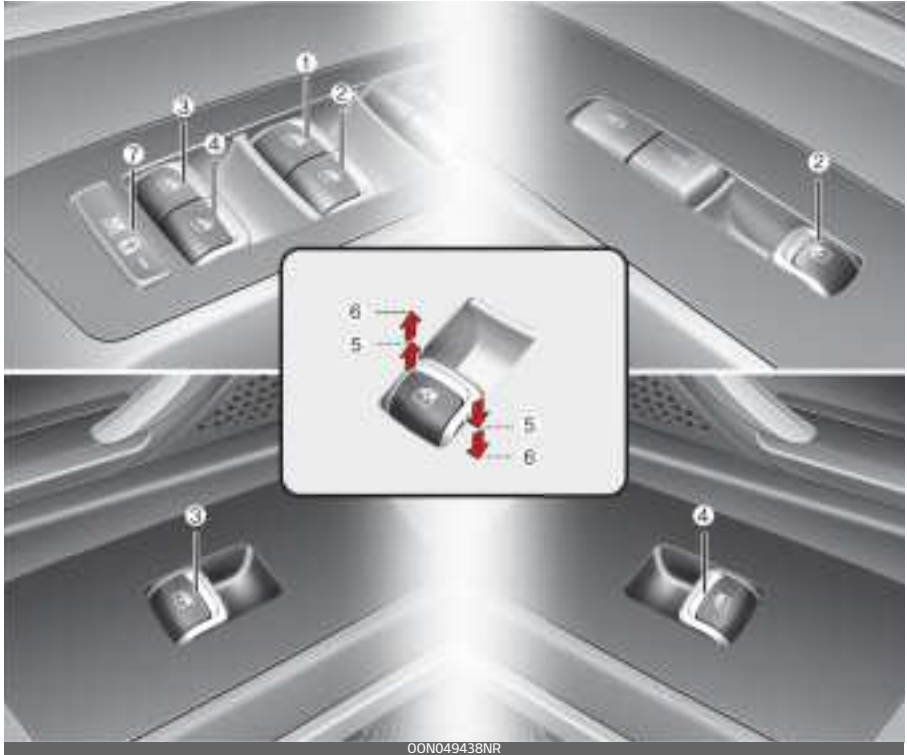

1. Driver's door power window switch
2. Front passenger's door power window switch
3. Rear door (left) power window switch
4. Rear door (right) power window switch
5. Window opening and closing
6. Automatic power window up/down
7. Power window lock switch

*** NOTICE**

In cold and wet climates, power windows may not work properly due to freezing conditions.

The ENGINE START/STOP button must be in the ON position for power windows to operate.

Each door has a power window switch that controls the door's window. The driver has a power window lock switch which can block the operation of rear passenger windows. The power windows can be operated for approximately 10 minutes after the ENGINE START/STOP button has been placed in the ON position. However, if the front doors are opened, the power windows cannot be operated even within the 10 minutes period.

The driver's door has a master power window switch that controls all the windows in the vehicle.

If the window cannot be closed because it is blocked by objects, remove the objects and close the window.

*** NOTICE**

While driving with the rear windows down or with the sunroof (if equipped) in an open (or partially open position), your vehicle may demonstrate a wind buffeting or pulsation noise. This noise is a normal occurrence and can be reduced or eliminated by taking the following actions. If the noise occurs with one or both of the rear windows down, partially lower both front windows approximately 2.5 cm (1 inch). If you experience the noise with the sunroof open, slightly reduce the size of the sunroof opening.

⚠ CAUTION

Do not install any accessories in the vehicle that extend into the open window area. Such objects will impact the proper function of the Automatic reversal "jam protection" feature.

*** NOTICE**

If you press the one-touch window button for micro adjustment, the glass will go down to a specific location to improve your convenience.

Window opening and closing

You can open and close windows using the power window switch.

Auto up/down window



Pressing or pulling up the power window switch momentarily to the second detent position (6) completely lowers or raises the window even when the switch is released. To stop the window at the desired position while the window is in operation, pull up or press down and release the switch.

If the power window does not operate normally, the automatic power window system must be reset as follows:

1. Place the ENGINE START/STOP button to the ON position.
2. Close the window and continue pulling up the power window switch for at least 1 second after the window is completely closed.

Automatic reversal

If the upward movement of the window is blocked by an object or part of the body, the window will detect the resistance and will stop upward movement. The window will then lower approximately 30 cm (11.8 inches) to allow the object to be cleared.



If the window detects the resistance while the power window switch is pulled up continuously, the window will stop upward movement then lower approximately 2.5 cm (1 inch).

If the power window switch is being continuously pulled up again within 5 seconds after the window was lowered by the automatic window reversal feature, the automatic window reversal will not operate.

* NOTICE

The automatic reverse feature for the window is only active when the "auto up" feature is used by fully

pulling up the switch. The automatic reverse feature will not operate if the window is raised using the half-way position on the power window switch.

⚠ WARNING

Always check for obstructions before raising any window to avoid injuries or vehicle damage. If an object less than 4 mm (0.16 of an inch) in diameter is caught between the window glass and the upper window channel, the automatic reverse window may not detect the resistance and will not stop and reverse direction.

⚠ WARNING

The automatic reverse feature doesn't activate while resetting the power window system. Make sure body parts or other objects are safely out of the way before closing the windows to avoid injuries.

⚠ WARNING

Do not install any accessories in the vehicle that extend into the open window area. Such objects could prevent the automatic reverse feature from functioning.

Power window lock switch

The driver can disable the power window switches on the rear passengers' doors by pressing the power window lock switch to the lock position (pressed).



When the power window lock switch is pressed:

- The driver's master control can operate the front passenger's power window and the rear passengers' power windows.
- The front passenger's control can operate the front passenger's power window.
- The rear passengers' control cannot operate the rear passengers' power window.

* If the power window lock switch is operated (indicator turns on), rear passenger cannot open the rear door (With the Electronic Child Safety Lock System). For more details, refer to "Electronic child safety lock system" on page 4-20.

Always double check to make sure all arms, hands, head and other obstructions are safely out of the way before closing a window.

If the window cannot be closed because it is blocked by objects, remove the objects and close the window.

WARNING

Power windows

- Do not allow children to play with the power windows. Keep the power window lock switch (on the driver's door) in the LOCK (pressed) position.
- Do not extend a face or arms outside the window opening while the vehicle is in motion. Doing so could result in significant bodily injury.

WARNING

- When exiting the vehicle, turn the engine switch off, take the key with you, and make sure that all children have also exited the vehicle. If a child is left alone inside the vehicle, they may accidentally operate the vehicle, which could lead to an accident or injury.
- Do not leave children, seniors, or animals in your vehicle with the doors and windows closed.

- Do not allow a child to hold both the remote control key and the mechanical key together.
-

Hood

The hood serves as a cover for the engine compartment. Open the hood if maintenance work needs to be performed in the engine compartment or if you need to look at the compartment.

Opening the hood

1. Pull the release lever to unlatch the hood. The hood should pop open slightly.



3. Raise the hood. It will completely rise by itself after it has been raised about halfway.

Hood open warning

A warning message will appear on the LCD display when hood is open.



⚠ WARNING

Open the hood after turning off the engine on a flat surface, shifting the shift lever to the P (Park) position and setting the parking brake.

2. Go to the front of the vehicle, raise the hood slightly, push the secondary latch (1) up side and lift the hood (2).

The warning chime will operate when the vehicle is being driven above 3 km/h (2 mph) with the hood open.

Closing the hood

1. Before closing the hood, check the following:
 - All filler caps in the engine compartment must be correctly installed.
 - Gloves, rags or any other combustible material must be removed from the engine compartment.
2. Lower the hood halfway and push down to securely lock in place.
3. Then double check to be sure the hood is secure.
 - If the hood can be raise slightly, it is not properly engaged.
 - Open it again and close it with a little more force.

CAUTION

Hood obstruction

Before closing the hood, ensure that all obstructions are removed from the hood opening. Closing the hood with an obstruction present in the hood opening may result in severe personal injury or property damage.

WARNING

Fire risk

Do not leave gloves, rags or any other combustible material in the motor compartment. Doing so may cause a heat-induced fire.

WARNING

Unsecured hood

Always double check to be sure that the hood is firmly latched before driving away. If it is not latched, the hood could fly open while the vehicle is being driven, causing a total loss of visibility, which might result in an accident.

Fuel filler door

The vehicle's fuel filler door must be opened and closed by hand from outside the vehicle.

Opening the fuel filler door



If the fuel filler door does not open because ice has formed around it, tap lightly or push on the lid to break the ice and release the lid. Do not apply excessive force to open the lid. If necessary, spray around the lid with an approved de-icer fluid (do not use radiator anti-freeze) or move the vehicle to a warm place and allow the ice to melt.

1. Stop the engine.
2. To open the fuel filler door, press the 3 o'clock position edge of the fuel filler door.

* NOTICE

The fuel filler door will unlock when driver's door is unlocked
To unlock fuel filler door:

- Press the unlock button on your smart key
- Press the Central Door unlock button on armrest trim of driver's door
- Pull the driver's inside door handle outward

The fuel filler door will lock when all doors are locked

To lock fuel filler door:

- Press the lock button on your smart key
- Press the Central Door lock button on armrest trim of driver's door

* All doors will automatically lock after the vehicle speed exceeds 15 km/h (9.3 mph) Fuel door is also locked when vehicle speed exceeds 15 km/h (9.3 mph)

3. Pull the fuel filler door (1) out to fully open.



4. To remove the fuel tank cap (2), turn it counterclockwise. You may hear a hissing noise as the pressure inside the tank equalizes.

- Place the cap on the fuel filler door.

Closing the fuel filler door

- To install the cap, turn it clockwise until it "clicks" one time. This indicates that the cap is securely tightened.
- Close the fuel filler door and push on the 3 o'clock position edge of the fuel filler door lightly gently to make sure that it is securely closed.

WARNING

Refueling

Always remove the fuel cap carefully and slowly. If the cap is venting fuel or if you hear a hissing sound, wait until the condition stops before completely removing the cap.

If pressurized fuel sprays out, it can cover your clothes or skin and subject you to the risk of fire and burns.

* NOTICE

When refueling on unlevel ground, the fuel gauge may not point to the F position. It is not a malfunction. If you move your vehicle to a level ground, the fuel gauge will move to the full position.

* NOTICE

Tighten the cap until it clicks one time, otherwise, the engine warning indicator light will illuminate.

Always check that the fuel cap is installed securely to prevent fuel spillage in the event of an accident.

WARNING

Fire/explosion risk

Read and follow all warnings posted at the gas station facility. Failure to follow all warnings will result in severe personal injury, severe burns or death due to fire or explosion.

WARNING

Static electricity

- Before touching the fuel nozzle, you should eliminate potentially dangerous static electricity discharge by touching another metal part of the vehicle, a safe distance away from the fuel filler neck, nozzle, or other gas source.
- Do not get back into a vehicle once you have begun refueling since you can generate static electricity by touching, rubbing or sliding against any item or fabric (polyester, satin, nylon, etc.) capable of producing static electricity. Static electricity discharge can ignite fuel vapors resulting in

rapid burning. If you must reenter the vehicle, you should once again eliminate potentially dangerous static electricity discharge by touching a metal part of the vehicle, away from the fuel filler neck, nozzle or other gasoline source.

WARNING

Portable fuel container

When using an approved portable fuel container, be sure to place the container on the ground prior to refueling. Static electricity discharge from the container can ignite fuel vapors causing a fire. Once refueling has begun, contact with the vehicle should be maintained until the filling is complete. Use only approved portable plastic fuel containers designed to carry and store gasoline.

WARNING

Cell phone fires

Do not use cellular phones while refueling. Electric current and/or electronic interference from cellular phones can potentially ignite fuel vapors causing a fire.

WARNING

Refueling & Vehicle fires

When refueling, always shut the engine off. Sparks produced by electrical components related to the engine can ignite fuel vapors causing a fire. Once refueling is complete, check to make sure the filler cap and filler door are securely closed, before starting the engine.

WARNING

Smoking

DO NOT use matches or a lighter and DO NOT SMOKE or leave a lit cigarette in your vehicle while at a gas station especially during refueling. Automotive fuel is highly flammable and can, when ignited, result in fire.

Make sure to refuel your vehicle according to "Fuel requirements" on page 1-2.

If the fuel filler cap requires replacement, use only a genuine Kia cap or the equivalent specified for your vehicle. An incorrect fuel filler cap can result in a serious malfunction of the fuel system or emission control system.

⚠ CAUTION**Exterior paint**

Do not spill fuel on the exterior surfaces of the vehicle. Any type of fuel spilled on painted surfaces may damage the paint.

⚠ WARNING

- Do not allow anyone that has not discharged static electricity from their body to come close to an open fuel tank.
- Do not inhale vaporized fuel.

⚠ WARNING**Risk of injury from fuel**

Fuels are poisonous and harmful to your health.

- Fuel contains substances that are harmful if inhaled.
- Do not swallow fuel or let it come into contact with skin, eyes or clothing.
- Do not inhale fuel vapors.
- Keep children away from fuel.

If you or other people come into contact with fuel, observe the following:

- Immediately rinse fuel off your skin with soap and water.
- If fuel comes into contact with your eyes, immediately rinse them thoroughly with clean

water. Seek medical attention immediately.

- If you swallow fuel, seek medical attention immediately. Do not induce vomiting.
- Change immediately out of clothing that has come into contact with fuel.

*** NOTICE****Damage caused by the wrong fuel**

Fuel that does not conform to the required quality can lead to increased wear as well as damage to the engine and exhaust system. Only use the fuel recommended.

*** NOTICE****Damage caused by the wrong fuel**

Vehicles with a gasoline engine: Even small amounts of the wrong fuel could result in damage to the fuel system, the engine and the emission control system.

*** NOTICE**

Do not use diesel to refuel vehicles with a gasoline engine.

*** NOTICE**

Do not switch on the ignition if you accidentally refuel with the wrong

fuel. Otherwise, fuel can enter the fuel system.

Even small amounts of the wrong fuel could result in damage to the fuel system and the engine. Have the system serviced by an authorized Kia dealer.

*** NOTICE**

Do not overfill the fuel tank

Do not overfill the fuel tank; otherwise fuel may slide, causing harm to the environment and damaging the vehicle.

Dual Wide Sunroof (if equipped)

If your vehicle is equipped with a sunroof, you can slide or tilt your sunroof with the sunroof switch located on the overhead console.



[A]: Front, [B]: Rear

The sunroof can only be operated when the ENGINE START/STOP button is in the ON or START position.

The sunroof can be operated for approximately 30 seconds after the ENGINE START/STOP button is in the ACC or OFF position. However, if the front door is open, the sunroof cannot be operated even within the 30 seconds period.

⚠ WARNING

- Never adjust the sunroof or sunshade while driving. This could result in loss of control and an accident that may cause injury, or property damage.
- Do not leave the engine running and the key in your vehicle with unsupervised children. Unattended children could operate the sunroof, which could result in serious injury.
- Do not sit on the top of the vehicle. It may cause injury or vehicle damage.

*** NOTICE**

Do not operate the sunroof when roof bars are installed on the vehicle or when there is luggage on the roof.

Sunshade (Front)/Power sunshade (Rear)

Use the power sunshade to block direct sunlight coming through the sunroof glass.

**Front**

Open or close the sunshade by hand.



The sunshade opens automatically when the sunroof glass is opened by pushing the sunroof switch (A) rearward, but the sunshade does not close automatically when the sunroof glass is closed. Also, only the sunshade cannot be closed when the sunroof glass is opened.

*** NOTICE**

Do not pull the sunshade up or down, or apply excessive force as such action may damage the sunshade or cause it to malfunction.

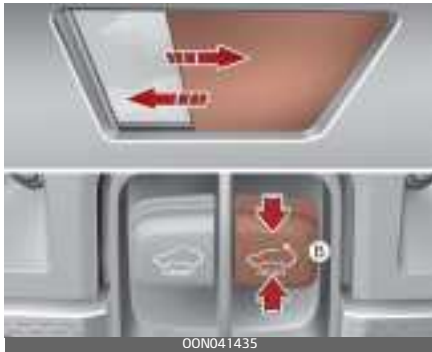

Rear

Push the power sunshade open switch (B), the power sunshade automatically slides open.

Push the power sunshade close switch (B), the power sunshade automatically closes.

*** NOTICE**

Do not pull or push the power sunshade by hand as such action may damage the power sunshade or cause it to malfunction.

*** NOTICE**

Wrinkles formed on the power sunshade are normal due to material characteristic.

Tilt open/close (Front)



- Push the sunroof switch upward, the sunroof glass tilts open.
- Push the sunroof switch forward, the sunroof glass automatically closes.

To stop the sunroof movement at any point, push the sunroof switch in any direction.

Slide open/close (Front)



- Push the sunroof switch rearward, the sunshade and sunroof glass slide open. Push the sunroof switch forward, only the sunroof glass closes.
- Push the sunroof switch forward or rearward to the first detent position, the sunroof glass moves until the switch is released.
- Push the sunroof switch forward or rearward to the second detent position, the sunroof glass operates automatically (auto slide feature). To stop the sunroof movement at any point, push the sunroof switch in any direction.

Automatic reversal



If the power sunshade or sunroof glass senses any obstacle while it is closing automatically, it will reverse direction then stop at a certain position.

The auto reverse function may not work if an object thin or soft is caught between the sliding power sunshade or sunroof glass and sunroof sash.

⚠ WARNING

- Make sure heads, hands, arms or any other body parts or objects are out of the way before operating the sunroof. Body parts or objects may get caught causing injuries or vehicle damage.
- Never deliberately use your body parts to test the automatic reversal function. The power sunshade or sunroof glass may reverse direction, but there is a risk of injury.

*** NOTICE**

- Do not continue to push the sunroof switch after the sunroof is fully opened, closed, or tilted. Damage to the sunroof motor could occur.
- Continuous operations such as slide open/close, tilt open/close, etc. may cause the motor or sunroof system to malfunction.
- Regularly remove any accumulated dust on the sunroof rail.
- Dust accumulated between the sunroof and roof panel can make noise. Open the sunroof and remove dust regularly using a clean cloth.
- Do not try to open the sunroof when the temperature is below freezing or when the sunroof is covered with snow or ice. The sunroof may not work properly and may break if opened by force.
- Do not open or drive with the sunroof glass open immediately after rain or washing the vehicle. Water may wet the interior of the vehicle.
- Do not extend any luggage outside the sunroof while driving. Vehicle damage may occur if the vehicle suddenly stops.

⚠ WARNING

Do not extend your head, arms, body parts or objects outside the sunroof while driving. Injuries may occur if the vehicle suddenly stops.

Resetting the sunroof

Front



Rear



In some circumstances resetting the sunroof operation may need to be performed. Some instances where resetting the sunroof may be required include:

- When the 12-volt battery is either disconnected or discharged
- When the sunroof fuse is replaced
- If the sunroof one-touch AUTO OPEN/CLOSE operation is not functioning properly

Sunroof resetting procedure:

1. It is recommended to perform the reset procedure with the vehicle engine running. Start the vehicle in P (Park).
2. Make sure the power sunshade or sunroof glass is in the fully closed position. If the power sunshade or sunroof glass is open, push the switch forward until the power sunshade and sunroof glass is fully closed.
3. Release the switch when the power sunshade or sunroof glass is fully closed.
4. Push the switch forward until the power sunshade or sunroof glass moves slightly. Then release the switch.
5. Once again push and hold the sunroof switch forward until the power sunshade or sunroof glass slides open and close. Do not release the switch until the operation is completed.
If you release the switch during operation, start the procedure again from step 2.

* NOTICE

If the sunroof is not reset when the vehicle battery is disconnected or discharged, or the sunroof fuse is blown, the sunroof may not operate normally.

Sunroof open warning



If the driver turns off the engine when the sunroof is not fully closed, the warning chime will sound for several seconds and the sunroof open warning will appear on the cluster LCD display. Close the sunroof securely when leaving your vehicle.

⚠ CAUTION

Make sure the sunroof is closed fully when leaving your vehicle. If the sunroof is left open, rain or snow may wet the interior of the vehicle. Also, leaving the sunroof open when the vehicle is unattended may invite theft.

Sunroof (if equipped)

If your vehicle is equipped with a sunroof, you can slide or tilt your sunroof with the sunroof switch located on the overhead console.



The sunroof can only be operated when the ENGINE START/STOP button is in the ON or START position.

The sunroof can be operated for approximately 30 seconds after the ENGINE START/STOP button is in the ACC or OFF position. However, if the front door is open, the sunroof cannot be operated even within the 30 seconds period.

⚠ WARNING

- Never adjust the sunroof or sunshade while driving. This could result in loss of control and an accident that may cause injury, or property damage.
- Do not leave the engine running and the key in your vehicle with unsupervised children. Unat-

tended children could operate the sunroof, which could result in serious injury.

- Do not sit on the top of the vehicle. It may cause injury or vehicle damage.

*** NOTICE**

Do not operate the sunroof when roof bars are installed on the vehicle or when there is luggage on the roof.

Sunshade

Use the power sunshade to block direct sunlight coming through the sunroof glass.



Open or close the sunshade by hand.



The sunshade opens automatically when the sunroof glass is opened by pushing the sunroof switch rearward, but the sunshade does not close automatically when the sunroof glass is closed. Also, only the sunshade cannot be closed when the sunroof glass is opened.

*** NOTICE**

Do not pull the sunshade up or down, or apply excessive force as such action may damage the sunshade or cause it to malfunction.

Tilt open/close



- Push the sunroof switch upward, the sunroof glass tilts open.
- Push the sunroof switch forward, the sunroof glass automatically closes.

To stop the sunroof movement at any point, push the sunroof switch in any direction.

Slide open/close



- Push the sunroof switch rearward, the sunshade and sunroof glass slide open. Push the sunroof switch forward, only the sunroof glass closes.

- Push the sunroof switch forward or rearward to the first detent position, the sunroof glass moves until the switch is released.
- Push the sunroof switch forward or rearward to the second detent position, the sunroof glass operates automatically (auto slide feature). To stop the sunroof movement at any point, push the sunroof switch in any direction.

Automatic reversal



If the power sunshade or sunroof glass senses any obstacle while it is closing automatically, it will reverse direction then stop at a certain position.

The auto reverse function may not work if an object thin or soft is caught between the sliding power sunshade or sunroof glass and sunroof sash.

⚠ WARNING

- Make sure heads, hands, arms or any other body parts or objects are out of the way before operating the sunroof. Body parts or objects may get caught causing injuries or vehicle damage.
- Never deliberately use your body parts to test the automatic reversal function. The sunroof glass may reverse direction, but there is a risk of injury.

* NOTICE

- Do not continue to push the sunroof switch after the sunroof is fully opened, closed, or tilted. Damage to the sunroof motor could occur.
- Continuous operations such as slide open/close, tilt open/close, etc. may cause the motor or sunroof system to malfunction.
- Regularly remove any accumulated dust on the sunroof rail.
- Dust accumulated between the sunroof and roof panel can make noise. Open the sunroof and remove dust regularly using a clean cloth.
- Do not try to open the sunroof when the temperature is below freezing or when the sunroof is covered with snow or ice. The sunroof may not work properly and may break if opened by force.

- Do not open or drive with the sunroof glass open immediately after rain or washing the vehicle. Water may wet the interior of the vehicle.
- Do not extend any luggage outside the sunroof while driving. Vehicle damage may occur if the vehicle suddenly stops.

⚠ WARNING

Do not extend your head, arms, body parts or objects outside the sunroof while driving. Injuries may occur if the vehicle suddenly stops.

Resetting the sunroof



In some circumstances resetting the sunroof operation may need to be performed. Some instances where resetting the sunroof may be required include:

- When the 12-volt battery is either disconnected or discharged.

- When the sunroof fuse is replaced.
- If the sunroof one-touch AUTO OPEN/CLOSE operation is not functioning properly.

Sunroof resetting procedure:

1. It is recommended to perform the reset procedure with the vehicle engine running. Start the vehicle in P (Park).
2. Make sure the sunroof glass is in the fully closed position. If the sunroof glass is open, push the switch forward until the sunroof glass is fully closed.
3. Release the switch when the sunroof glass is fully closed.
4. Push the switch forward until the sunroof glass moves slightly. Then release the switch.
5. Once again push and hold the sunroof switch forward until the sunroof glass slides open and close. Do not release the switch until the operation is completed. If you release the switch during operation, start the procedure again from step 2.

*** NOTICE**

If the sunroof is not reset when the vehicle battery is disconnected or discharged, or the sunroof fuse is blown, the sunroof may not operate normally.

Sunroof open warning



If the driver turns off the engine when the sunroof is not fully closed, the warning chime will sound for several seconds and the sunroof open warning will appear on the cluster LCD display. Close the sunroof securely when leaving your vehicle.

⚠ CAUTION

Make sure the sunroof is closed fully when leaving your vehicle. If the sunroof is left open, rain or snow may wet the interior of the vehicle. Also, leaving the sunroof open when the vehicle is unattended may invite theft.

Steering wheel

The steering wheel of this vehicle is equipped with the Electric Power Steering (EPS) system.

Electric Power Steering (EPS) system

Electric power steering is a device that uses an electric motor to help the driver provide less effort in steering the vehicle.

If the vehicle is off or if the Electric Power Steering (EPS) becomes inoperative, the vehicle may still be steered, but it will require increased steering effort.

The EPS is controlled by the power steering control unit which senses the steering wheel torque and vehicle speed to command the motor.

The steering effort becomes heavier as the vehicle's speed increases and becomes lighter as the vehicle's speed decreases for better control of the steering wheel.

Should you notice any change in the effort required to steer during normal vehicle operation, have the power steering checked by an authorized Kia dealer.

* NOTICE

The following symptoms may occur during normal vehicle operation:

- When the ENGINE START/STOP button is the ON position, the steering wheel enters normal operation mode after diagnosing the Electric Power Steering system (for about 3 seconds).
- A click noise may be heard from the EPS relay after turning the ENGINE START/STOP button is turned to the ON or OFF position.
- If the steering wheel is operated when the vehicle is not in motion or driven at a low speed, you may hear some noise.
- If the Electric Power Steering system does not operate normally, the warning light will illuminate or blink on the instrument cluster. If the power assistance of steering fails, you will need to use more force to steer.
- Operating the steering wheel at lower temperatures may require more force and accompany noise. However, when the temperature increases, it returns to normal.
- Take your vehicle to an authorized Kia dealer and have the vehicle checked as soon as possible.
- When the charging system warning light comes on due to the low voltage (when the alternator or battery does not operate normally or malfunctions), the steering wheel may require increased steering effort.

*** NOTICE**

When you continuously operate the steering wheel, the overcurrent protection device is activated and it requires more force to operate the steering wheel. However, this doesn't indicate a malfunction, and it works for your safety and will return to normal after some time.

*** NOTICE**

If the Electric Power Steering (EPS) system does not work or an error occurs, the warning light on the instrument panel may be turned on or blink and it may require more force to operate the steering wheel. In this case, please hold the steering wheel more tightly than usual and operate with greater force. And then immediately pull your vehicle over to a safe place and have your vehicle inspected by an authorized Kia dealer.

If the EPS does not operate normally, the warning light will illuminate on the instrument cluster. The steering wheel may become difficult to control or operate abnormally. In this case, have the system inspected by an authorized Kia dealer.

When you operate the steering wheel in low temperature, the

steering effort may be high and abnormal noise could occur. If temperature rises, the noise will disappear. This is a normal condition.

When the vehicle is stationary, and the steering wheel is turned all the way to the left or right continuously, the steering wheel becomes harder to turn. The power assist is limited to protect the motor from overheating.

As time passes, the steering wheel will return to its normal condition.

Tilt & telescopic steering wheel

A tilt and telescopic steering wheel allows you to adjust the steering wheel before you drive

You can also raise it to give your legs more room when you exit and enter the vehicle.

The steering wheel should be positioned so that it is comfortable for you to drive, while permitting you to see the instrument panel warning lights and gauges.

⚠ WARNING

Steering wheel adjustment

Never adjust the angle and height of the steering wheel while driving. You may lose steering control.

Adjusting steering wheel angle and height

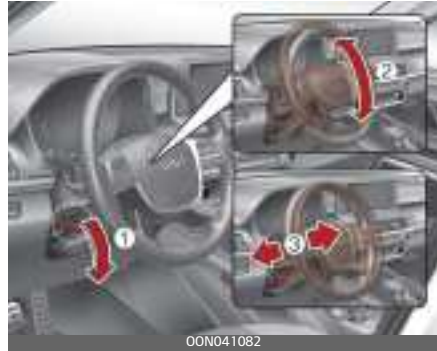

1. To change the steering wheel angle, pull down the lock release lever (1).
2. Adjust the steering wheel to the desired angle (2) and height (3).
3. Pull up the lock-release lever to lock the steering wheel in place.
4. Be sure to adjust the steering wheel to the desired position before driving.

*** NOTICE**

After adjustment, sometimes the lock-release lever may not lock the steering wheel.

It is not a malfunction. This occurs when two gears engage. In this case, adjust the steering wheel again and then lock the steering wheel.

Heated steering wheel (if equipped)

With the ENGINE START/STOP button in the ON position, pressing the heated steering wheel button warms the steering wheel. The indicator on the button will illuminate.



To turn the heated steering wheel off, press the button once again. The indicator on the button will turn off.

* NOTICE

The heated steering wheel will turn off automatically approximately 30 minutes after the heated steering wheel is turned on.

⚠ CAUTION

- Do not install any type of grip cover for the steering wheel, it may impair the function of the heated steering wheel system.
- When cleaning the heated steering wheel, do not use an organic solvent such as paint thinner,

benzene, alcohol and gasoline. Doing so may damage the surface of the steering wheel.

- If the surface of the steering wheel is damaged by a sharp object, damage to the heated steering wheel components could occur.

⚠ WARNING

If the steering wheel becomes too warm, turn the system off. The heated steering wheel may cause burns even at low temperatures, especially if used for long periods of time.

Horn

To sound the horn, press the area indicated by the horn symbol on your steering wheel (see illustration).



The horn will operate only when this area is pressed. Check the horn regularly to be sure it operates properly.

Mirrors

This vehicle is equipped with inside and outside rearview mirrors to provide views of objects behind the vehicle.

Inside rearview mirror

Adjust the rearview mirror so that the center view through the rear window is seen. Make this adjustment before you start driving.

Do not place objects in the rear seat or cargo area which would interfere with your vision through the rear window.

WARNING

Mirror adjustment

Do not adjust the rearview mirror while the vehicle is moving. This could result in loss of control.

NOTICE

Do not modify the inside mirror in any manner, including installing a wide mirror. Doing so could result in injury during an accident or deployment of the air bag.

CAUTION

Cleaning mirror

When cleaning the mirror, use a paper towel or similar material

dampened with glass cleaner. Do not spray glass cleaner directly on the mirror. It may cause the liquid cleaner to enter the mirror housing.

Electric Chromic Mirror (ECM) (if equipped)

The electric rearview mirror automatically controls the glare from the headlights of the vehicles behind you at night or in low-light driving conditions.

The sensor (3) mounted in the mirror senses the light level around the vehicle, and automatically controls the headlight glare from the vehicles behind you.

When the engine is running, the glare is automatically controlled by the sensor mounted in the rearview mirror. Whenever the shift lever is shifted into reverse (R), the mirror will automatically go to the brightest setting in order to improve the drivers view behind the vehicle.

CAUTION

Cleaning mirror

When cleaning the mirror, use a paper towel or similar material dampened with glass cleaner. Do not spray glass cleaner directly on the mirror. It may cause the liquid cleaner to enter the mirror housing.

Operating the electric rearview mirror

The mirror defaults to the ON position whenever the ENGINE START/STOP button is turned on.



- Press the ON/OFF button (1) to turn the automatic dimming function off. The mirror indicator light will turn off.
- Press the ON/OFF button (1) to turn the automatic dimming function on. The mirror indicator light (2) will illuminate.

Electric chromic mirror with HomeLink system (if equipped)

Operating the electric rearview mirror



- Press the I button (1) to turn the automatic- dimming function on. The mirror indicator light will illuminate.
- Press the O button (2) to turn the automatic- dimming function off. The mirror indicator light will turn off.

HomeLink® Wireless Control system



1. Homelink buttons
2. Indicator light

3. Glare detection sensor

Your new mirror comes with an integrated HomeLink Universal Transceiver, which allows you to program the mirror to activate your garage door(s), estate gate, home lighting, etc. The mirror actually learns the codes from your various existing transmitters.

Retain the original transmitter for future programming procedures (i.e., new vehicle purchase). It is also suggested that upon the sale of the vehicle, the programmed HomeLink buttons be erased for security purposes (follow step 1 in "Programming HomeLink" on page 4-64).

Programming HomeLink

Your vehicle may require the ENGINE START/STOP button to be turned to the ACC position for programming and/or operation of HomeLink. It is also recommended that a new battery be replaced in the hand-held transmitter of the device being programmed to HomeLink for quicker training and accurate transmission of the radiofrequency.

Follow these steps to train your HomeLink mirror:

1. When programming the buttons for the first time, press and hold the left and center buttons (🏠, 🏠) simultaneously until the indi-

cator light begins to flash after approximately 20 seconds. (This procedure erases the factory-set default codes. Do not perform this step when programming the additional HomeLink buttons.)



1) Flashing

* NOTICE

For non-rolling code garage door openers, follow steps 2-3.
 For rolling code garage door openers, follow steps 2-6.
 For Canadian Programming, please follow the Canadian Programming section. For help with determining whether your garage door opener is non-rolling code or rolling code, please refer to the garage door openers owner's manual or contact HomeLink customer service at 1-800-355-3515.

2. Press and hold the button on the HomeLink system you wish to train and the button on the transmitter while the transmitter is

approximately 2~8 cm (1~3 inches) away from the mirror. Do not release the buttons until step 3 has been completed.



- 1) Flashing
- 2) Transmitter
3. The HomeLink indicator light will flash, first slowly and then rapidly. When the indicator light flashes rapidly, both buttons may be released. (The rapid flashing light indicates successful programming of the new frequency signal.)

* NOTICE

Some gate and garage door openers may require you to replace step 3 with the "cycling" procedure noted in the "Canadian Programming" section of this document.

Programming rolling code

To train a garage door opener (or other rolling code equipped devices) with the rolling code feature, follow

these instructions after completing "Programming HomeLink" on page 4-64. (A second person assisting may make the following training procedures quicker & easier.)

4. Locate the "learn" or "smart" button on the device's motor head unit. Exact location and color of the button may vary by product brand. If there is difficulty locating the "learn" or "smart" button, reference the device's owner's manual or contact HomeLink at 1-800-355-3515 or on the internet at www.homelink.com.
5. Press and release the "learn" or "smart" button on the device's motor head unit. You have 30 seconds to complete step 6.
6. Return to the vehicle and firmly press and release the programmed HomeLink button up to three times. The rolling code equipped device should now recognize the HomeLink signal and activate when the HomeLink button is pressed. The remaining two buttons may now be programmed if they have not already been programmed. Refer to "Programming HomeLink" on page 4-64.

Operating HomeLink

To operate, simply press the programmed HomeLink button.

Activation will now occur for the trained product (garage door, secu-

rity system, entry door lock, estate gate, or home or office lighting). For convenience, the hand-held transmitter of the device may also be used at any time. The HomeLink Wireless Controls system (once programmed) or the original hand-held transmitter may be used to activate the device (e.g., garage door, entry door lock, etc.). In the event that there are still programming difficulties, contact HomeLink at 1-800-355-3515 or on the internet at www.homelink.com.

Erasing programmed HomeLink buttons



To erase the three programmed buttons (individual buttons cannot be erased):

- Press and hold the left and center buttons simultaneously, until the indicator light begins to flash (approximately 20 seconds). Release both buttons. Do not hold for longer than 30 seconds.

HomeLink is now in the train (or learning) mode and can be programmed at any time.

Reprogramming a single HomeLink button

To program a device to HomeLink using a HomeLink button that has already been trained, follow these steps:

1. Press and hold the desired HomeLink button. Do NOT release until step 4 has been completed.
2. When the indicator light begins to flash slowly (after 20 seconds), position the hand-held transmitter 2~8 cm (1~3 inches) away from the HomeLink surface.
3. Press and hold the hand-held transmitter button (or press and "cycle" - as described in "Canadian Programming").
4. The HomeLink indicator light will flash, first slowly and then rapidly. When the indicator light begins to flash rapidly, release both buttons.

The previous device has now been erased and the new device can be activated by pushing the HomeLink button that has just been programmed. This procedure will not affect any other programmed HomeLink buttons.

Canadian Programming Garage & gate openers

During programming, your hand-held transmitter may automatically stop transmitting. Continue to press and hold the HomeLink button (note steps 2 through 4 in "Programming HomeLink" on page 4-64) while you press and re-press ("cycle") your handheld transmitter every two seconds until the frequency signal has been learned. Upon successful training, the indicator light will flash slowly and then rapidly after several seconds.

Accessories

If you would like additional information on the HomeLink Wireless Control system, HomeLink compatible products, or to purchase other accessories such as the HomeLink® Lighting Package, please contact HomeLink at 1-800-355-3515 or on the internet at www.homelink.com.

FCC ID: NZLZTVHL3

IC: 4112A-ZTVHL3

This device complies with Industry Canada licence-exempt RSS standard(s).

1. This device may not cause interference, and
2. This device must accept any interference, including interfer-

ence that may cause undesired operation of the device.

Outside rearview mirror

Your vehicle is equipped with both left-hand and right-hand outside rearview mirrors.

Be sure to adjust the mirror angles before driving.

The mirrors can be adjusted remotely with the remote switch. The mirror heads can be folded back to prevent damage during an automatic car wash or when passing through a narrow street.

⚠ WARNING

Estimating distances accurately

Objects reflected in the mirror are closer than they appear in the mirror. Do not estimate the distance of vehicles behind you based on what you see in the mirror, as this could increase your risk of accident.

If the mirror is jammed with ice, do not adjust the mirror by force. Use an approved spray de-icer (not radiator antifreeze) to release the frozen mechanism or move the vehicle to a warm place and allow the ice to melt.

⚠ WARNING

Mirror adjustment

Do not adjust or fold the outside rearview mirrors while the vehicle is moving. This could result in loss of control.

Adjusting the outside rearview mirrors



OON048088NR

Adjusting the rearview mirrors:

1. Move the L (Front left side) or R (Front right side) switch (1) to select the rearview mirror you would like to adjust.
2. Use the mirror adjustment control (2) to position the selected mirror up, down, left or right.

⚠ CAUTION

- The mirrors stop moving when they reach the maximum adjusting angles, but the motor continues to operate while the switch is pressed. Do not press the switch

longer than necessary, the motor may be damaged.

- Do not attempt to adjust the outside rearview mirror by hand. Doing so may damage the parts.

Folding the outside rearview mirror

Manual type

- To fold the outside rearview mirror, grasp the housing of the mirror and then fold it toward the rear of the vehicle.



OON048089NR

Electric type

- The outside rearview mirror can be folded or unfolded by pressing the switch when the ENGINE START/STOP button is in the ON position as below.



1. To fold the outside rearview mirror depress the button (1).
 2. To unfold it, depress the button (1) again.
- The mirror will fold or unfold when the door is locked or unlocked by the key.
 - The mirror will fold or unfold when the door is locked or unlocked by the button on the outside door handle.

The mirror will fold or unfold automatically as follows:

- The mirror will fold or unfold when the door is locked or unlocked by the smart key.
- The mirror will fold or unfold when the door is locked or unlocked by the button on the outside door handle.
- The mirror will unfold when you approach the vehicle (all doors closed and locked) with a smart key in possession when the Welcome Mirror function is activated in User Settings. (if equipped)

⚠ CAUTION

Do not fold an electric type outside rearview mirror by hand as this could cause motor failure.

Reverse parking aid function (if equipped)



While the vehicle is moving rearward, the outside rearview mirror(s) will move downward to aid reverse parking. According to the position of the outside rearview mirror switch (1), the outside rearview mirror(s) will operate as follows:

L/R: When the remote control outside rearview mirror switch is selected to the L (left) or R (right) position, both outside rearview mirrors will move downward.

Neutral: When the remote control outside rearview mirror switch is placed in the middle, the outside rearview mirrors will not move

downward even though the vehicle is moving rearward.

The outside rearview mirrors will automatically revert to their original positions under the following conditions:

1. The ENGINE START/STOP button is in the OFF position.
2. Shift lever is moved to any position except R (Reverse).
3. Remote control outside rearview mirror switch is not equipped on the vehicles.

Instrument cluster

Type A



OON049100CR

Type B



OON049101CR

* The actual cluster and contents of the LCD display in the vehicle may differ from the illustration.

1. Tachometer
2. Speedometer
3. Engine coolant temperature gauge
4. Fuel gauge
5. Warning and indicator lights
6. LCD display

Instrument cluster control

The brightness of the instrument panel illumination is changed by pressing the illumination control button ("+" or "-") when the ENGINE START/STOP button is ON, or the taillights are turned on.

- If you hold the illumination control button ("+" or "-"), the brightness will continuously change.



- If the brightness reaches to the maximum or minimum level, an alarm will sound.

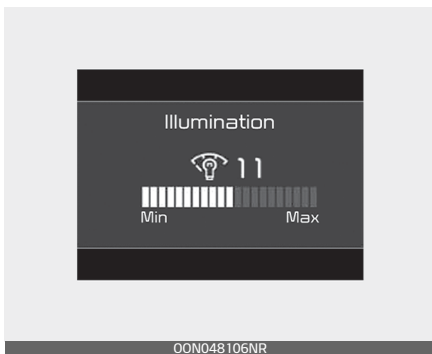

Gauges

The gauges display various information such as the speed of the vehicle, the amount of charge of the battery, and so on.

Speedometer



The speedometer indicates the speed of the vehicle and is calibrated in kilometers per hour (km/h) and/or miles per hour (mph).

Tachometer



The tachometer indicates the approximate number of engine revolutions per minute (rpm).

Use the tachometer to select the correct shift points and to prevent lugging and/or over-revving the engine.

⚠ CAUTION

Do not operate the engine within the tachometer's RED ZONE. This may cause severe engine damage.

Engine Coolant Temperature Gauge



This gauge indicates the temperature of the engine coolant when the ENGINE START/STOP button is ON.

⚠ CAUTION

If the gauge pointer moves beyond the normal range area (between the C-H) toward the "H" position, it indicates overheating that may damage the engine.

Do not continue driving with an overheated engine. If your vehicle overheats, refer to "If the engine overheats" on page 6-8.

⚠ WARNING

Never remove the radiator cap when the engine is hot. The engine coolant is under pressure and could severely burn. Wait until the engine is cool before adding coolant to the reservoir.

Fuel Gauge



OON049138CR

This gauge indicates the approximate amount of fuel remaining in the fuel tank.

* NOTICE

- The fuel tank capacity is given in "Recommended lubricants and capacities" on page 8-6.
- The fuel gauge is supplemented by a low fuel warning light, which will illuminate when the fuel tank is nearly empty.
- On inclines or curves, the fuel gauge pointer may fluctuate or the low fuel warning light may come on earlier than usual due to the movement of fuel in the tank.

▲ WARNING

Fuel Gauge

Running out of fuel can expose vehicle occupants to danger.

You must stop and obtain additional fuel as soon as possible after the

warning light comes on or when the gauge indicator comes close to the "E" level.

▲ CAUTION

Avoid driving with an extremely low fuel level. Running out of fuel could cause the engine to misfire, which could damage the catalytic converter.

* NOTICE

The fuel display may not be accurate if the vehicle is on an incline.

Odometer

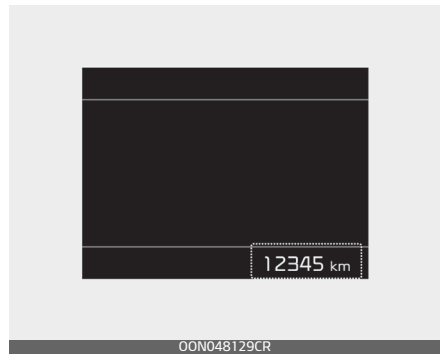

OON048129CR

The odometer Indicates the total distance that the vehicle has been driven and should be used to determine when periodic maintenance should be performed.

- Odometer range: 0~1,599,999 kilometers or 0~999,999 miles.

Outside Temperature Gauge

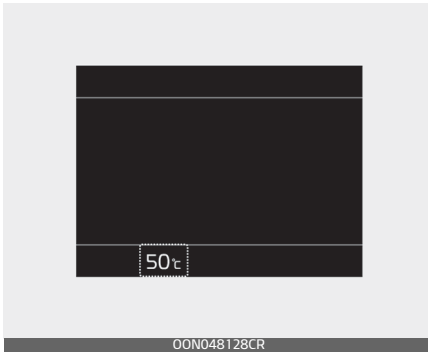

This gauge indicates the current outside air temperatures by 1 °C (1 °F).

- Temperature range: -40~60 °C (-40~140 °F)

The outside temperature on the display may not change immediately, like a normal thermometer would.

To change the temperature unit (from °C to °F or from °F to °C)

The temperature unit can be changed by using the "User Settings" mode of the LCD display.

* For more details, refer to "LCD display" on page 4-76.

Transmission shift indicator

Transmission shift indicator displays gear information depending on your vehicle's transmission type.

Automatic Transmission Shift Indicator

This indicator displays which automatic transmission shift lever is selected.

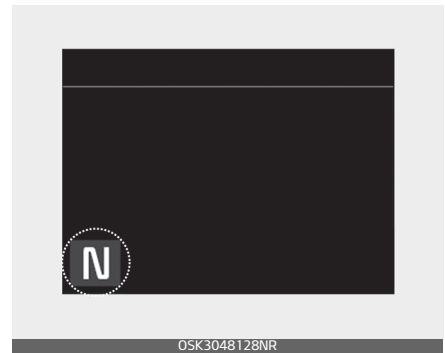

- Park: P
- Reverse: R
- Neutral: N
- Drive: D
- Sports Mode: 1, 2, 3, 4, 5, 6, 7, 8



LCD display

The LCD display shows trip computer and other information.

LCD Display Control







The LCD display modes can be changed by using the control buttons.



1. : MODE button for changing modes
2. : MOVE switch for changing items
3. : SELECT/RESET button for setting or resetting the selected item

LCD Display Modes

The LCD display provides 5 modes. You can switch modes by pressing the Mode button.

Mode					
	 Trip Computer	 Turn By Turn (TBT)	 Driving Assist	 User Settings	 Master warning
 Up/Down	Fuel Economy	Route Guidance	Lane Safety	Head-Up Display	The Master Warning mode displays warning messages related to the vehicle when one or more systems is not operating normally.
	Accumulated Info	Destination Info	Driver Attention Warning	Driver Assistance	
	Drive Info		AWD	Door	
	Speedometer			Lights	
	Drive Mode			Sound	
				Convenience	
		TPMS	Service Interval		
			Other features		
			Language		
			Reset		

4

The information provided may differ depending on which functions are applicable to your vehicle.

*** NOTICE**

Keep the engine running when configuring the display settings to prevent the battery from discharging.

Trip Computer mode

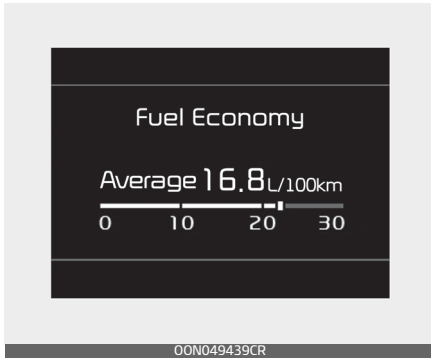

The trip computer mode displays information related to vehicle driving parameters including fuel economy, tripmeter information and vehicle speed.

* For more details, refer to "Trip information (trip computer)" on page 4-87.

Turn By Turn (TBT) mode



This mode displays the state of the navigation.

Driving Assist



This mode displays the state of:

- Lane Safety
- Driver Attention Warning
- AWD
- TPMS

* For more details, refer to each system information in "Driving your vehicle" on page 5-5.

TPMS status

* For more details, refer to "Tire Pressure Monitoring System (TPMS)" on page 6-9.

Master warning mode

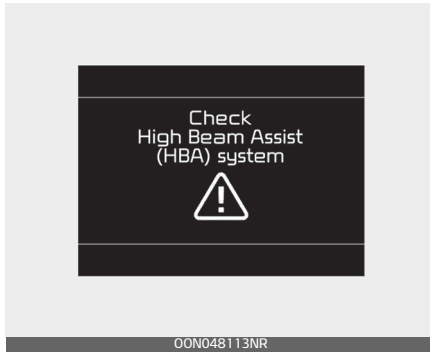

This warning light informs the driver the following situations.

- LED headlamp malfunction (if equipped)
- Lamp malfunction
- High Beam Assist malfunction (if equipped)

At this time, a Master Warning icon (⚠) will appear beside the User Settings icon (⚙), on the LCD display.

If the warning situation is resolved, the master warning light will be turned off and the Master Warning icon will disappear.

User Settings mode

In this mode, you can change the settings of the instrument cluster, doors, lamps, etc.

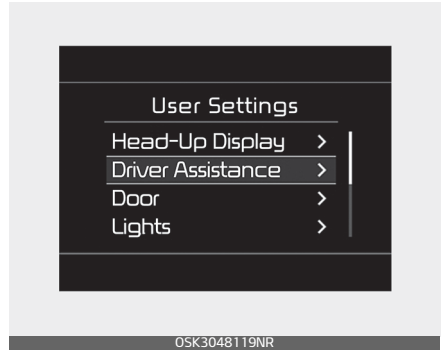

1. Head-Up Display
2. Driver Assistance
3. Door
4. Lights
5. Sound
6. Convenience
7. Service Interval
8. Other features
9. Language
10. Reset

The information provided may differ depending on which functions are applicable to your vehicle.

Shift to P to edit settings

This warning message appears if you try to adjust the User Settings while driving.



- For your safety, change the User Settings after parking the vehicle by shifting the lever to P (Park) and applying the parking brake.

1. Head-Up Display (if equipped)

	Explanation
Enable Head-Up Display	If this item is checked, the Head-Up Display will be activated.
Display Height	Adjust the height (1~20) of the HUD image on the HUD screen.
Rotation	Adjust the degree (-5~+5) of the HUD rotation.
Brightness	Adjust the intensity (1~20) of the HUD brightness.
Contents Selection	If below items are checked, the items will be activated. <ul style="list-style-type: none"> • Turn By Turn • Traffic Information • Driving Assist Information • Lane Safety Information • Blind-Spot Safety Information • AV Information
Speedometer size	• Small/Medium/Large
Speedometer color	• White/Orange/Green

2. Driver Assistance (if equipped)

	Explanation
SCC Reaction	• Fast/Normal/Slow To adjust the sensitivity of Smart Cruise Control. * For more details, refer to "Smart Cruise Control (SCC)" on page 5-91.
Driving Assist	• Leading vehicle departure alert/Lane Following Assist/ Highway Driving Assist/Highway Auto Curve Slowdown To select the functions.
Warning Timing	• Normal/Later To select the Warning time
Warning Volume	• High/Medium/Low/Off To select the Warning volume
Driver Attention Warning	• Low Activity Warning To select the function. * For more details, refer to "Driver Attention Warning (DAW)" on page 5-83.

	Explanation
Forward Safety	<ul style="list-style-type: none"> Active Assist/Warning Only/Off To select the functions.
Lane Safety	<ul style="list-style-type: none"> Lane Keeping Assist/Lane Departure Warning/Off To select the functions.
Blind-Spot Safety	<ul style="list-style-type: none"> Blind-Spot View Safe Exit Assist (SEA) Active Assist/Warning Only/Off To select the functions.
Parking Safety	<ul style="list-style-type: none"> Rear Cross-Traffic Safety: You can turn on/Off Rear Cross-Traffic Collision-Avoidance Assist. With Rear Cross-Traffic Collision-Avoidance Assist on, if there is a vehicle approaching from the rear side when reversing, it helps you avoid collision through warning and control. * For more details, refer to "Rear Cross-Traffic Collision-Avoidance Assist (RCCA)" on page 5–124.

* The information provided may differ depending on which functions are applicable to your vehicle.

3. Door

	Explanation
Automatically Lock	<ul style="list-style-type: none"> Enable on speed: All doors will be automatically locked when the vehicle speed exceeds 15 km/h (9.3 mph). Enable on Shift (if equipped with Automatic transmission) : All doors will be automatically locked if the gear is shifted from the P (Park) position to the R (Reverse), N (Neutral), or D (Drive) position. (With the Engine ON, it is activated.)
Automatically Unlock	<ul style="list-style-type: none"> Disable: The auto door unlock operation will be canceled. Vehicle Off: All doors will be automatically unlocked when the Engine Star/Stop button is set to the OFF position. On Shift to P (if equipped with Automatic transmission) : All doors will be automatically unlocked if the gear is shifted to the P (Park) position. (With the Engine ON, it is activated.)

	Explanation
Two Press Unlock (if equipped)	<ul style="list-style-type: none"> • Off: The two press unlock function will be deactivated. Therefore, all doors will unlock if the door is unlocked. • On: Press the door unlock button once to unlock the driver's door, and press the button once more within 4 seconds to unlock the rest of the doors.
Power Liftgate (if equipped)	<ul style="list-style-type: none"> • If this item is checked, the power liftgate function will be activated. * For more details, refer to "Power liftgate (if equipped)" on page 4-27.
Power Liftgate Speed (if equipped)	<ul style="list-style-type: none"> • Normal/ Fast You can select the operating speed of the power liftgate.
Smart Power Liftgate (if equipped)	<ul style="list-style-type: none"> • If this item is checked, the smart power liftgate function will be activated. If the power liftgate function is not activated, you cannot activate this function. * For more details, refer to "Smart Power Liftgate (if equipped)" on page 4-33.

* The information provided may differ depending on which functions are applicable to your vehicle.

4. Lights

	Explanation
One touch turn signal	<ul style="list-style-type: none"> • Off: The one touch turn signal function will be deactivated. • 3, 5, 7 Flashes: The turn signal indicator will blink 3, 5, or 7 times when the turn signal lever is moved slightly. * For more details, refer to "Lighting" on page 4-120.
Head Lamp Delay	If this item is checked, the head lamp delay function will be activated.

* The information provided may differ depending on which functions are applicable to your vehicle.

5. Sound

	Explanation
Welcome sound	If this item is checked, the welcome sound function will be activated.

* The information provided may differ depending on which functions are applicable to your vehicle.

6. Convenience (if equipped)

	Explanation
Seat (forward/backward) Easy Access (if equipped)	<ul style="list-style-type: none"> • Off: The seat easy access function will be deactivated. • Normal/Extended: When you turn off the engine, the driver's seat will automatically move rear 7.6 cm (3 in) (Enhanced) for you to enter or exit the vehicle more comfortably. <p>If you change the ENGINE START/STOP button from OFF position to the AC function, the driver's seat will return to the original position.</p> <p>* For more details, refer to "Driver position memory system for power seat (if equipped)" on page 3-12.</p>
Seat (upward/downward) Easy Access (if equipped)	<ul style="list-style-type: none"> • To activate or deactivate Seat (upward/downward) Easy Access
Rear Occupant Alert (if equipped)	<ul style="list-style-type: none"> • To activate or deactivate the Rear Occupant Alert. <p>* For more details, refer to "Rear Occupant Alert (ROA) system (if equipped)" on page 4-22.</p>
Welcome Mirror/Light	On door unlock/ On door approach. You can choose one of these two functions.
Wiper/Lights Display	If this item is checked, the Wiper/Lights Display will be activated.
Auto rear wiper (reverse)	If this item is checked, the Auto rear wiper will be activated.
Gear Position Pop-up	If this item is checked, the Gear position pop-up display will be activated.
Icy road warning	If this item is checked, the Icy road warning display will be activated.

* The information provided may differ depending on which functions are applicable to your vehicle.

7. Service Interval

	Explanation
Enable Service Interval	If this item is checked, the Service Interval function will be activated.
Adjust Interval	If the service interval menu is activated, you may adjust the time and distance.
Reset	To reset the service interval function.

If the service interval is activated and the time and distance are adjusted, messages are displayed each time the vehicle is turned on in the following situations.

- Service in: Displayed to inform the driver the remaining mileage and days to service.
- Service required: Displayed when the mileage and days to service has been reached or passed.

If any of the following conditions occur, the mileage and number of days to service may be incorrect.

- The battery cable is disconnected.
- The battery is discharged.

8. Other features (if equipped)

	Explanation
Fuel Economy Auto Reset	If this item is checked, the average fuel economy will reset automatically after refueling or after ignition.
Speed Unit	<ul style="list-style-type: none"> • km/h, mph To select Speed unit.
Fuel Economy Unit	<ul style="list-style-type: none"> • L/100 km, US gallon, UK gallon To select the Fuel economy unit. * For more details, refer to "Trip information (trip computer)" on page 4-87.
Temperature Unit	<ul style="list-style-type: none"> • °C/°F To select the Temperature unit.
Tire Pressure Unit	<ul style="list-style-type: none"> • kPa, psi, bar To select the Tire Pressure Unit

* The information provided may differ depending on which functions are applicable to your vehicle.

9. Language (if equipped)

	Explanation
Language	To select language.

10. Reset

	Explanation
Reset	You can reset the menus in the User Settings mode. All menus in the User Settings mode are reset to factory settings, except language and service interval.

LCD displays

LCD displays show the following information to drivers.

- Trip information
- LCD modes
- Warning messages

Trip information (trip computer)

The trip computer is a microcomputer-controlled driver information system that displays information related to driving.

* NOTICE

Some driving information stored in the trip computer resets if the battery is disconnected.

Trip modes

To change the trip mode, scroll the toggle the switch (∧ / ∨) on the steering wheel.

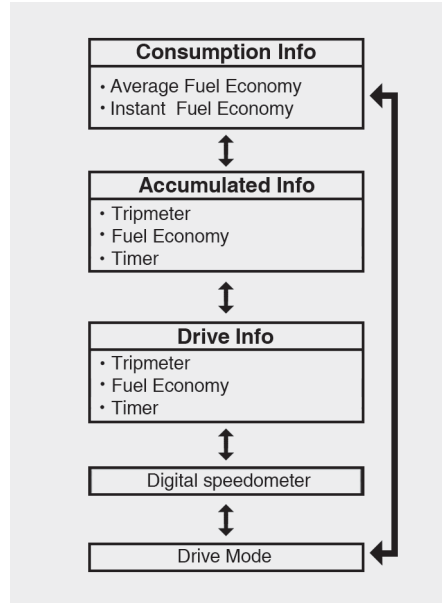

Fuel Economy

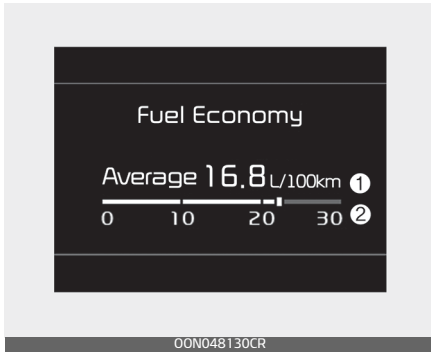

Average Fuel Economy (1)

- The average fuel economy is calculated by the total driving distance and fuel consumption since the last average fuel economy reset.
 - Fuel economy range: 0-99.9 L/100 km or mpg
- The average fuel economy can be reset both manually and automatically.

Manual reset

To clear the average fuel economy manually, press the OK button on the steering wheel for more than 1 second when the average fuel economy is displayed.

Automatic reset

To automatically reset the average fuel economy select menu from the 'Fuel economy auto reset' in the User Settings mode on the LCD display.

- OFF - You may set to default manually by using the trip switch reset button.

- After ignition - The vehicle will automatically set to default once 4 hours pass after the Ignition is in OFF.
- After refueling - After refueling more than 6 liters (1.6 gallons) and driving over 1 km/h (1 mph), the vehicle will reset to default automatically.

Instant Fuel Economy (2)

- This mode displays the instant fuel economy.

Accumulated Info display

This display shows the accumulated trip distance (1), the average fuel efficiency (2), and the total driving time (3).

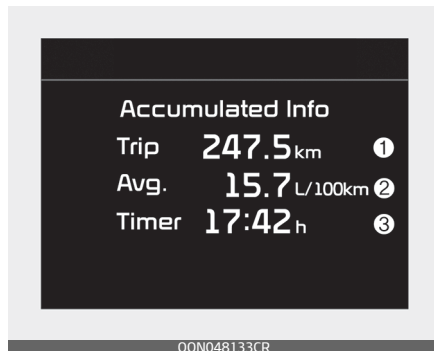

- Accumulated information is calculated after the vehicle has run for more than 300 meters (0.19 miles).
- If you press "OK" button for more than 1 second after the Cumulative Information is displayed, the information will be reset.

- If the engine is running, even when the vehicle is not in motion, the information will be accumulated.

*** NOTICE**

The vehicle must be driven for a minimum of 300 meters (0.19 miles) since the last ignition cycle before the average accumulated driving information is recalculated.

Drive Info display

This display shows the trip distance (1), the average fuel efficiency (2), and the total driving time (3) information once per one ignition cycle.

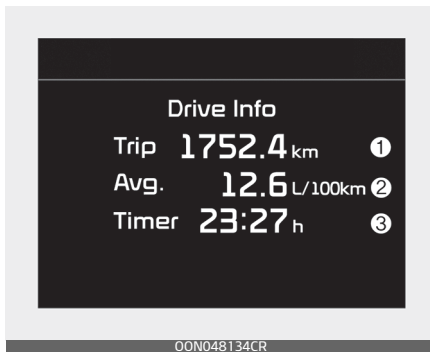

- Fuel efficiency is calculated after the vehicle has run for more than 300 meters (0.19 miles).

- If you press "OK" button for more than 1 second after the Driving Information is displayed, the information will be reset.
- If the engine is running, even when the vehicle is not in motion, the information will be accumulated.

*** NOTICE**

The vehicle must be driven for a minimum of 300 meters (0.19 miles) since the last ignition cycle before the average accumulated driving information is recalculated.

Digital speedometer

This digital speedometer display shows the speed of the vehicle.



Drive mode

This mode displays the currently selected drive mode.



Service Modeservice mode

This mode reminds you of scheduled maintenance information.

Service in

It calculates and displays when you need a scheduled maintenance service (mileage or days).

If the remaining mileage or time reaches 1,500 km (900 miles) or 30 days, "Service in" message is displayed for several seconds each time you set the ENGINE START/STOP button to the ON position.

Service required

If you do not have your vehicle serviced according to the already inputted service interval, "Service required" message is displayed for several seconds each time you set

the ENGINE START/STOP button to the ON position.

To reset the service interval to the mileage and days that were previously inputted:

- Press the OK button (Reset) for more than 1 second.

* NOTICE

If any of the following conditions occurs, the mileage and days may be incorrect.

- The battery cable is disconnected.
- The battery is discharged.

Driving info display

At the end of each driving cycle, the Driving Info message is displayed.

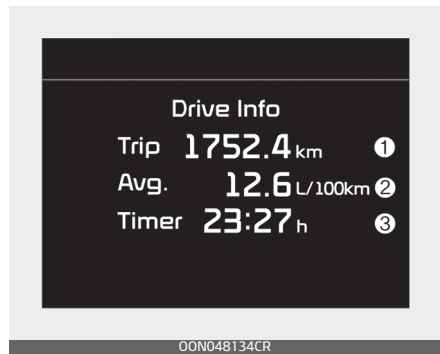

This display shows the trip distance (1), average energy consumption (2), driving time (3).

This information is displayed for a few seconds when you turn off the vehicle, and then goes off automati-

cally. The information is calculated for each time the vehicle is turned on.

* NOTICE

- If sunroof open warning is displayed in the cluster, the Driving Information message may not be displayed.

LCD display messages

Engine has overheated

This warning message illuminates when the engine coolant temperature is above 120 °C (248 °F). This mean that the engine is overheated and may be damaged.

- * If your vehicle is overheated, refer to "If the engine overheats" on page 6-8.

Low Key Battery for smart key system

This warning message illuminates if the battery of the smart key is discharged when the ENGINE START/STOP button changes to the OFF position.

Press START button while turning wheel for smart key system

This message is displayed when the smart key system is engage, to disengage press the ENGINE START/

STOP button while turning the steering wheel right and left.

Steering wheel unlocked for smart key system

This warning message illuminates as follows:

- If the steering is not locked when the ENGINE START/STOP button changes to the OFF position.

If the steering wheel lock system has a problem. In this case, have your vehicle inspected by an authorized Kia dealer.

Check Steering Wheel Lock system for smart key system

This warning message illuminates if there is malfunction in steering wheel lock system when the ENGINE START/STOP button changes to the OFF position.

Key not in vehicle for smart key system

This warning message illuminates if the smart key is not in the vehicle when the ENGINE START/STOP button is in the ON position.

It means that you should always have the smart key with you.

Key not detected for smart key system

This warning message illuminates if the smart key is not detected when you press the ENGINE START/STOP button.

Door, Hood, Liftgate open warning display

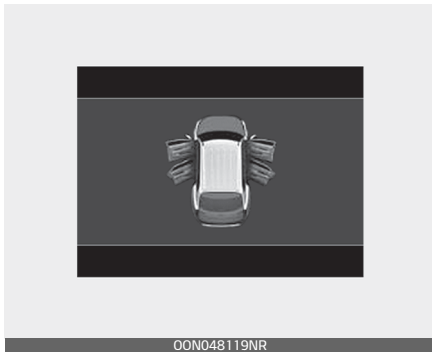

This warning is displayed if any door or the hood or the liftgate is left open. The warning will indicate which door is open in the display.

CAUTION

Before driving the vehicle, you should confirm that the door, hood, and liftgate are fully closed. Also, check there is no door/hood/liftgate open warning light or message displayed on the instrument cluster.

Sunroof open warning display (if equipped)



This warning is displayed if you turn off the vehicle when the sunroof is open.

Close the sunroof securely before leaving your vehicle.

Low Pressure warning display



This warning message is displayed if the tire pressure is low. The corresponding tire on the vehicle will be illuminated.

* For more details, refer to "Tire Pressure Monitoring System (TPMS)" on page 6-9.

Lights mode

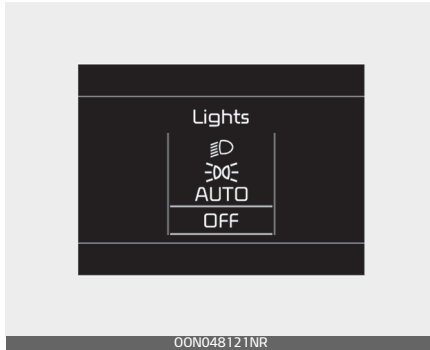

This indicator displays which exterior light is selected using the lighting control.

You can activate or deactivate Wiper/Lights Display function from the User Settings mode in the cluster LCD display.

Wiper mode

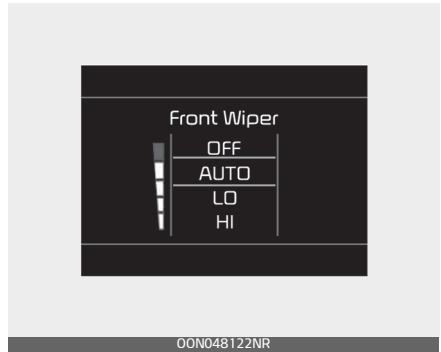

This indicator displays which wiper speed is selected using the wiper control.

You can activate or deactivate Wiper/Lights Display function from the User Settings mode in the cluster LCD display.

Shift to P or N to start engine for smart key system

This warning message illuminates if you try to start the engine with the shift lever not in the P (Park) or N (Neutral) position.

Press brake pedal to start engine for smart key system

This warning message illuminates if the ENGINE START/STOP button changes to the ACC position twice by pressing the button repeatedly without depressing the brake pedal.

It means that you should depress the brake pedal to start the engine.

Battery discharging due to external electrical devices

The vehicle can detect self-discharge of the battery due to over-current that is generated by unauthorized electrical devices such as dashboard camera (dash cam) mounting during parking.

Please note that functions such as Idle Stop and Go (ISG) are limited and battery discharge problems may occur.

If the warning continues even after external electrical devices are removed, have your vehicle inspected by an authorized Kia dealer.

Press START button again for smart key system

This warning message illuminates if you cannot operate the ENGINE START/STOP button when there is a problem with the ENGINE START/STOP button system.

It means that you could start the engine by pressing the ENGINE START/STOP button once more.

If the warning illuminates each time you press the ENGINE START/STOP button, have the vehicle inspected by an authorized Kia dealer.

Press START button with key for smart key system

This warning message illuminates if you press the ENGINE START/STOP button while the warning message "Key not detected" is illuminating.

At this time, the immobilizer indicator light blinks.

Check DAW (if equipped)

This warning message is displayed if there is a problem with Driver Attention Warning. In this case, have the vehicle inspected by an authorized Kia dealer.

* For more information, refer to "Driver Attention Warning (DAW)" on page 5-83.

Check BCA (if equipped)

This warning message is displayed if there is a problem with Blind-Spot Collision-Avoidance Assist. In this case, have the vehicle inspected by an authorized Kia dealer.

* For more information, refer to "Blind-Spot Collision-Avoidance Assist (BCA)" on page 5-72.

Ice Road Warning (if equipped)

This warning is to warn the driver the road may be icy.

When the following conditions occur, the warning light (including outside temperature gauge) blinks 5 times and then illuminates, and also warning chime sounds once.

- The temperature on the outside temperature gauge is below approximately 4 °C (40 °F).

*** NOTICE**

If the icy road warning appears while driving, you should drive more attentively and refrain from speeding, rapid acceleration, sudden braking or sharp turning.

Check headlight

This warning message illuminates if there is a malfunction (burned-out bulb except LED lamp or circuit malfunction) with the headlamp. In this

case, have your vehicle inspected by an authorized Kia dealer.

*** NOTICE**

Be sure to use the bulb that meets the specified capacity. Refer to "Bulb wattage" on page 8-4.

When you use a bulb that does not meet capacity, the above warning message appears.

Check ECS

This warning message illuminates when a malfunction occurs with the Electronic Control Suspension (ECS) system. In this case, have your vehicle inspected by an authorized Kia dealer.

Warning and indicator lights

The warning light and indicator light indicate a situation where the driver should be careful and whether the various functions are activated.

Warning lights

The warning light indicates situations that require the driver to pay attention.

* NOTICE

Warning lights

Make sure that all warning lights are OFF after starting the vehicle. If any light is still ON, this indicates a situation that needs attention.

Air bag warning light

This warning light illuminates:

- Once you set the ENGINE START/STOP button to the ON position.
 - It illuminates for approximately 6 seconds and then goes off.
- When there is a malfunction with the Supplemental Restraint System (SRS).

In this case, have the vehicle inspected by an authorized Kia dealer.

Seat belt warning light

This warning light informs the driver that the seat belt is not fastened.

* For more details, refer to "Seat belts" on page 3-27.

Parking brake & brake fluid warning light

This warning light illuminates:

- Once you set the ENGINE START/STOP button to the ON position.
 - It illuminates for approximately 3 seconds
 - It remains on if the parking brake is applied.
- When the parking brake is applied.
- When the brake fluid level in the reservoir is low.
 - If the warning light illuminates with the parking brake released, it indicates the brake fluid level in reservoir is low.

If the brake fluid level in the reservoir is low:

1. Drive carefully to the nearest safe location and stop your vehicle.
2. With the vehicle stopped, check the brake fluid level immediately and add fluid as required (For more details, refer to "Brake fluid" on page 7-22). Then check all brake components for fluid leaks. If any leak on the brake system is still found, the warning light

remains on, or the brakes do not operate properly, do not drive the vehicle.

In this case, have your vehicle towed to an authorized Kia dealer and inspected.

Dual-diagonal braking system

Your vehicle is equipped with dual-diagonal braking systems. This means that braking still works for two wheels even if one of the dual systems should fail.

With only one of the dual systems working, greater pedal pressure is required to stop the vehicle.

Also, the vehicle will require increased stopping distance with only a portion of the brake system working.

WARNING

Parking Brake & Brake Fluid Warning Light

Driving the vehicle with a warning light ON is dangerous. If the Parking Brake & Brake Fluid Warning Light illuminates with the parking brake released, it indicates that the brake fluid level is low.

In this case, have your vehicle inspected by an authorized Kia dealer.

Anti-lock Brake System (ABS) warning light

This warning light illuminates:

- Once you set the ENGINE START/ STOP button to the ON position.
 - It illuminates for approximately 3 seconds and then goes off.
- When there is a malfunction with the ABS (The normal braking system will still be operational without the assistance of the Anti-lock Brake System).

In this case, have your vehicle inspected by an authorized Kia dealer.

Electronic Brake force Distribution (EBD) system warning light



These two warning lights illuminate at the same time while driving:

- When the ABS and regular brake system are not working, have your vehicle inspected by an authorized Kia dealer.

WARNING

Electronic Brake force Distribution (EBD) system warning light

When both ABS and Parking Brake & Brake Fluid warning lights are on, the brake system will not work normally and you may experience an unexpected and dangerous situation during sudden braking.

In this case, avoid high speed driving and abrupt braking.

Have your vehicle inspected by an authorized Kia dealer as soon as possible.

Electric Power Steering (EPS) warning light 

This warning light illuminates:

- When the ENGINE START/STOP button is turned to ON, the warning light illuminates for about 3 seconds and turns off automatically if no problem.

If the warning light is turned on, it may indicate the failure of the EPS system, so have your vehicle inspected by an authorized Kia dealer.

Charging system warning light 

This warning light illuminates:

- Once you set the ENGINE START/STOP button to the ON position.
- When there is a malfunction with either the alternator or electrical charging system.

If there is a malfunction with either the alternator or electrical charging system:

1. Drive carefully to the nearest safe location and stop your vehicle.

2. Turn the engine off and check the alternator drive belt for looseness or breakage.

In this case, have the vehicle inspected by an authorized Kia dealer.

Malfunction Indicator Lamp (MIL)



This warning light illuminates:

- Once you set the ENGINE START/STOP button to the ON position.
 - It remains on until the engine is started.
- When there is a malfunction with the emission control system. In this case, have the vehicle inspected by an authorized Kia dealer.

CAUTION

Malfunction Indicator Lamp (MIL)

Driving with the Malfunction Indicator Lamp (MIL) on may cause damage to the emission control systems which could affect drivability and/or fuel economy.

CAUTION

If the Malfunction Indicator Lamp (MIL) illuminates, potential catalytic converter damage is possible which could result in loss of engine power.

In this case, have the vehicle inspected by an authorized Kia dealer.

Engine oil pressure warning light



This warning light illuminates:

- Once you set the ENGINE START/STOP button to the ON position.
 - It remains on until the engine is started.
- When the engine oil pressure is low.
- Drive carefully to the nearest safe location and stop your vehicle.
- Turn the engine off and check the engine oil level (For more details, refer to "Engine oil and filter" on page 7-18.) If the level is low, add oil as required.
- If the warning light remains on after adding oil or if oil is not available, have the vehicle inspected by an authorized Kia dealer. Continued driving with the warning light on may cause engine failure.

⚠ CAUTION

When engine oil pressure decreases due to insufficient engine oil, etc., the Engine Oil Pressure Warning Light will illuminate.

⚠ CAUTION

Engine Overheating

Do not continue driving with the engine overheated. Otherwise, the engine may be damaged.

⚠ CAUTION

Engine damage

If the engine is not stopped immediately after the engine oil pressure warning light is illuminated and stays on while the engine is running, serious engine damage may result.

Low fuel level warning light

This warning light illuminates:

When the fuel tank is nearly empty.

If the fuel tank is nearly empty:

Add fuel as soon as possible.

⚠ CAUTION

Low Fuel Level

Driving with the Low Fuel Level warning light on or with the fuel level below "E" can cause the engine to misfire and damage the catalytic converter.

Low tire pressure warning light (if equipped)

This warning light illuminates:

- Once you set the ENGINE START/ STOP button to the ON position.
 - It illuminates for approximately 3 seconds and then goes off.
 - When one or more of your tires are significantly under inflated. (The location of the underinflated tires are displayed on the LCD display).
- * For more details, refer to "Tire Pressure Monitoring System (TPMS)" on page 6-9.

This warning light remains on after blinking for approximately 70 seconds or repeats blinking on and off at the intervals of approximately 3 seconds:

- When there is a malfunction with the Tire Pressure Monitoring System (TPMS).
In this case, have your vehicle inspected by an authorized Kia dealer.
- * For more details, refer to "Tire Pressure Monitoring System (TPMS)" on page 6-9.

WARNING

Low tire pressure

- Significantly low tire pressure makes the vehicle unstable and can contribute to loss of vehicle

control and increased braking distances.

- Continued driving on low pressure tires will cause the tires to over-heat and fail.

WARNING

Safe Stopping

- The TPMS cannot alert you to severe and sudden tire damage caused by external factors.
- If you notice any vehicle instability, immediately take your foot off the accelerator pedal, apply the brakes gradually with light force, and slowly move to a safe position off the road.

Master warning light

This warning light informs the driver the following situations

- LED headlamp malfunction (if equipped)
- Lamp malfunction
- High Beam Assist (HBA) malfunction (if equipped)

To identify the details of the warning, look at the LCD display.

LED headlamp warning light (if equipped)

This warning light illuminates:

- Once you set the ENGINE START/STOP button to the ON position.
 - It illuminates for approximately 3 seconds and then goes off.
- When there is a malfunction with the LED headlamp.

In this case, have your vehicle inspected by an authorized Kia dealer.

⚠ CAUTION

This warning light blinks when there is a malfunction with a LED headlamp related part. In this case, have your vehicle inspected by an authorized Kia dealer.

Forward Safety warning light (if equipped)

This indicator light illuminates:

- Once you set the ENGINE START/STOP button to the ON position.
 - It illuminates for approximately 3 seconds and then goes off.
- When Forward Collision-Avoidance Assist is turned off.
- When the radar sensor or cover is blocked with dirt or snow. Check the sensor and cover and clean them by using a soft cloth.

- When there is a malfunction with Forward Collision-Avoidance Assist. If this occurs, have your vehicle inspected by an authorized Kia dealer.

* For more details, refer to "Forward Collision-Avoidance Assist (FCA) (Sensor fusion)" on page 5-52.

Electronic Parking Brake (EPB) warning light (if equipped)

This warning light illuminates:

- Once you set the ENGINE START/STOP button to the ON position.
 - It illuminates for approximately 3 seconds and then goes off.
- When there is a malfunction with the EPB.

In this case, have your vehicle inspected by an authorized Kia dealer.

*** NOTICE**

Electronic Parking Brake (EPB) Warning Light

The Electronic Parking Brake (EPB) Warning Light may illuminate when the Electronic Stability Control (ESC) Indicator Light comes on to indicate that the ESC is not working properly (This does not indicate malfunction of the EPB).

All Wheel Drive (AWD) warning light



(if equipped)

This warning light illuminates:

- Once you set the ENGINE START/ STOP button to the ON position.
 - It illuminates for approximately 3 seconds and then goes off.
- When there is a malfunction with the AWD.

In this case, have your vehicle inspected by an authorized Kia dealer.

Indicator lights

The indicator light indicates whether the various functions are activated.

Electronic Stability Control (ESC)

indicator light 

This indicator light illuminates:

- Once you set the ENGINE START/ STOP button to the ON position.
 - It illuminates for approximately 3 seconds and then goes off.
- When there is a malfunction with the ESC.

In this case, have your vehicle inspected by an authorized Kia dealer.

This indicator light blinks:

While the ESC is operating.

* For more details, refer to "Electronic Stability Control (ESC) system" on page 5-37.

Electronic Stability Control (ESC)

OFF indicator light 

This indicator light illuminates:

- Once you set the ENGINE START/ STOP button to the ON position.
 - It illuminates for approximately 3 seconds and then goes off.
- When you deactivate the ESC system by pressing the ESC OFF button.

* For more details, refer to "Electronic Stability Control (ESC) system" on page 5-37.

Immobilizer indicator light 

This indicator light illuminates for up to 30 seconds:

- When the vehicle detects the smart key in the vehicle properly while the ENGINE START/STOP button is ACC or ON.
 - At this time, you can start the engine.
 - The indicator light goes off after starting the engine.

This indicator light blinks for a few seconds:

- When the smart key is not in the vehicle.
 - At this time, you cannot start the engine.

This indicator light illuminates for 2 seconds and goes off:

- When the vehicle cannot detect the smart key which is in the vehicle while the ENGINE START/ STOP button is ON.

In this case, have your vehicle inspected by an authorized Kia dealer.

This indicator light blinks:

- When the battery of the smart key is weak.
- When there is a malfunction with the immobilizer system.

In this case, have your vehicle inspected by an authorized Kia dealer.

Auto stop indicator 

This indicator will illuminate when the engine enters the Idle Stop mode of the Idle Stop and Go (ISG) system.

When the automatic starting occurs, the auto stop indicator on the cluster will blink for 5 seconds.

- * For more details, refer to "Idle Stop and Go (ISG) system" on page 5-44.

*** NOTICE**

When the engine automatically starts by the ISG system, warning lights (ABS, ESC, ESC OFF, EPS or

Parking brake warning light) may turn on for a few seconds.

This happens because of the low battery voltage. It does not mean the system is malfunctioning.

Turn signal indicator light **This indicator light blinks:**

- When you turn the turn signal light on.

If any of the following occurs, there may be a malfunction with the turn signal system.

In this case, have your vehicle inspected by an authorized Kia dealer.

- The indicator light does not blink but illuminates.
- The indicator light blinks more rapidly.
- The indicator light does not illuminate at all.

Low beam indicator light  (if equipped)**This indicator light illuminates:**

- When the headlights are on.

High beam indicator light **This indicator light illuminates:**

- When the headlights are on and in the high beam position.

- When the turn signal lever is pulled into the Flash-to-Pass position.

High Beam Assist indicator  (if equipped)

This warning light illuminates:

- When High Beam Assist is on with the light switch in the AUTO light position.
 - If your vehicle detects oncoming or preceding vehicles, High Beam Assist will switch the high beam to low beam automatically.
- * For more details, refer to "High Beam Assist (HBA) (if equipped)" on page 4-124.

Light ON indicator light 

This indicator light illuminates:

- When the tail lights or headlights are on.

Front fog indicator light  (if equipped)

This indicator light illuminates:

- When the front fog lights are on.

Lane Safety indicator  (if equipped)

The Lane Safety indicator will illuminate when you turn Lane Keeping Assist on by pressing the Lane Safety button.

If there is a problem with the function, the yellow Lane Keeping Assist indicator will illuminate.

- * For more details, refer to "Lane Keeping Assist (LKA)" on page 5-66.

Cruise indicator light  (if equipped)

This indicator light illuminates:

- When Smart Cruise Control is enabled.
- * For more details, refer to "Smart Cruise Control (SCC)" on page 5-91.

SPORT mode indicator light

 (if equipped)

This indicator light illuminates:

- When you select "SPORT" mode as drive mode.
- * For more details, refer to "Drive mode integrated control system (AWD)" on page 5-47.

ECO mode indicator light  (if equipped)

This indicator light illuminates:

- When you select "ECO" mode as drive mode.
- * For more details, refer to "Drive mode integrated control system (AWD)" on page 5-47.

AUTO HOLD indicator light (AUTO HOLD) (if equipped)**This indicator light illuminates:**

- **White** When you activate the auto hold system by pressing the AUTO HOLD button.
- **Green** When you stop the vehicle completely by depressing the brake pedal with the auto hold system activated.
- **Yellow** When there is a malfunction with the auto hold system. In this case, have your vehicle inspected by an authorized Kia dealer.

* For more details, refer to "AUTO HOLD" on page 5-32.

All Wheel Drive (AWD) LOCK indicator light  (if equipped)**This indicator light illuminates:**

- Once you set the ENGINE START/STOP button to the ON position.
 - It illuminates for approximately 3 seconds and then goes off.
- When you select AWD lock mode by pressing the AWD LOCK button.
 - The AWD lock mode is to increase the drive power when driving on wet pavement, snow covered roads and/or off-road.

*** NOTICE****AWD Lock Mode**

Do not use AWD LOCK mode on dry paved roads or highway, it can cause noise, vibration or damage of AWD related parts.

SMART mode indicator  (if equipped)**This indicator light illuminates:**

- When you select "SMART" mode as drive mode.
- * For more details, refer to "Drive mode integrated control system (AWD)" on page 5-47.

Head-Up Display (HUD) (if equipped)

The Head-Up Display (HUD) is a transparent display that projects an image of certain information from the instrument cluster and navigation system on the windshield glass.



- The HUD image on the HUD screen may not be visible when:
 - Sitting posture prevents visibility.
 - Wearing a polarized sunglasses.
 - There is an object on the cover of the Head-Up Display.
 - Driving on a wet road.
 - Lighting is turned on inside the vehicle.
 - Light is entering the vehicle from the outside.
 - Wearing inadequate glasses for your eyesight.
- If the HUD image is not displayed well, adjust the height, rotation or illumination of the HUD in the cluster.

- When the HUD needs inspection or repair, have your vehicle inspected or repaired by an authorized Kia dealer.

HUD ON/OFF

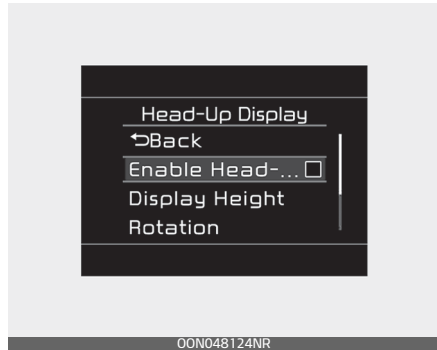

The HUD display can be activated or deactivated in user setting mode while engine is ON.

⚠ WARNING

Head-Up Display

The Head-Up Display is a supplemental system. Do not solely rely on the system, always drive safely, and pay attention to the driving conditions on the road.

HUD Information



1. Turn By Turn navigation information (if equipped)
2. Road signs (if equipped)
3. Speedometer
4. SCC setting speed (if equipped)
5. SCC Vehicle Distance information (if equipped)
6. Lane Safety information (if equipped)
7. Blind-Spot Safety information (if equipped)
8. Highway Driving Assist information (if equipped)
9. Lane Following Assist information (if equipped)
10. Highway Auto Speed Change information (if equipped)
11. Warning lights (low fuel)
12. AV mode information

* Road signs and Turn By Turn navigation information are available depending on the region.

HUD Setting

On the LCD display, you can change the HUD settings as follows.

1. Display height
2. Rotation
3. Brightness
4. Content selection
5. Speedometer size
6. Speedometer color

* For more details, refer to "LCD Display Modes" on page 4-77

Rear View Monitor (RVM) (if equipped)

Rear View Monitor is a supplemental function that shows the area behind the vehicle on the multimedia system screen to assist you when parking or backing up.

For detailed information, refer to a separately supplied manual.



- Rear View Monitor with parking guidance will activate when the engine is running and the shift lever is in the R (Reverse) position.
- To assist in parking, the rear view is shown (the parking guide line disappears) on the screen when

the shift lever is moved from R (Reverse) to D (Drive) with vehicle speed below 15 km/h (10 mph).

Rear View Monitor – Top view



When you touch the icon (1), the top view is displayed on the screen and shows the distance from the vehicle in the back of your vehicle. Touch the icon (1) again, to switch back to the previous screen.

⚠ WARNING

Backing & using camera

Never rely solely on the rear view camera. You must always use methods of viewing the area behind you including looking over both shoulders as well as continuously checking all three rear view mirrors. Due to the difficulty of ensuring that the area behind you remains clear, always back up slowly and stop immediately if you suspect

that a person, and especially a child, might be behind you.

* NOTICE

- Do not spray the camera or its surrounding area directly with a high pressure washer. Shock applied from high pressure water may cause the device to not operate normally.
- Do not use any cleanser containing acid or alkaline detergents when cleaning the lens. Use only a mild soap or neutral detergent, and rinse thoroughly with water.
- If the camera lens is covered with foreign material, Rear View Monitor may not operate normally. Always keep the camera lens clean.

However, do not use chemical solvents such as strong detergents containing high alkaline or volatile organic solvents (gasoline, acetone etc.). This may damage the camera lens.

- When your vehicle has not been operated for a long time or has been parked in indoor parking space in winter, the image may be temporarily blurred due to exhaust fumes.

360 ° camera monitoring system (if equipped)

360 ° camera monitoring system is the parking support function that shows your surroundings around the vehicle.

For detailed information, refer to a separately supplied manual.



OON048009NR



OON041010NR

- The function is activated when the following steps are performed.
 1. The Parking/View button (1, indicator ON) is pressed.
 2. The shift lever is in D (Drive), N (Neutral) or R (Reverse) and

vehicle speed is under 15 km/h (10 mph).

- The function is deactivated when one of the following is performed.
 - The Parking/View button (1, indicator OFF) is pressed again.
 - Vehicle speed is over 15 km/h (10 mph).
- When vehicle speed is over 15 km/h (10 mph), the function will turn off.

The function will not automatically turn on again, even though vehicle speed gets below 15 km/h (10 mph).

Press the Parking/View button (1, indicator ON) again, to turn on the function.

- When the vehicle is backing up, the function will turn ON regardless of vehicle speed or button status however, if vehicle speed is over 15 km/h (10 mph) when driving forward, 360 ° camera monitoring system will turn off.
- A indicator on the screen appears when:
 - The liftgate is opened.
 - The driver's door is opened.
 - The passenger's door is opened.
 - The outside rearview mirror is folded.
- If the function is not operating normally, the function should be checked by an authorized Kia dealer.

WARNING

The function is a supplementary driving assist function. Make sure to check the vehicle's surroundings yourself for safety. Do not solely rely on what is displayed on the screen. What you see on the screen may differ from the actual vehicle's location.

NOTICE

If the camera lens is covered with foreign material, 360° camera monitoring system may not operate normally. Always keep the camera lens clean. However, do not use chemical solvents such as strong detergents containing high alkaline or volatile organic solvents (gasoline, acetone etc.). This may damage the camera lens.

Reverse Parking Distance Warning (PDW) (if equipped)

Reverse Parking Distance Warning assists the driver when the vehicle is moving in reverse by chiming if any object is detected within a distance of 120 cm (48 inches) behind the vehicle.



This function is a supplemental function and it is not intended to nor does it replace the need for extreme care and attention of the driver. The sensing range and objects detectable by the back sensors (1) are limited. Whenever backing-up, pay as much attention to what is behind you as you would in a vehicle without Reverse Parking Distance Warning.

⚠ WARNING

Reverse Parking Distance Warning

Never rely solely on Reverse Parking Distance Warning. Always perform a visual inspection to make sure the vehicle is clear of all obstructions

before moving the vehicle in any direction. Stop immediately if you are aware of a child anywhere near your vehicle. Some objects may not be detected by the sensors, due to the object's size or material.

Reverse Parking Distance Warning operation

Operating condition

- This function will activate when the indicator on the Parking Safety button is not illuminated. If you desire to deactivate Reverse Parking Distance Warning, press the Parking Safety button again. (The indicator on the button will illuminate.) To turn the function on, press the button again. (The indicator on the button will go off.)
- This function will activate when backing up with the ENGINE START/STOP button ON. If the vehicle is moving at a speed over 5 km/h (3 mph), the function may not be activated correctly.
- The sensing distance while the back-up warning system is in operation is approximately 120 cm (48 inches) from the central area of the rear bumper and 60 cm (24 inches) from the side area of the rear bumper.
- When more than two objects are sensed at the same time, the

closest one will be recognized first.

Types of warning sound

- When an object is 120 cm to 60 cm (48 inches to 24 inches) from the rear bumper: Buzzer beeps intermittently.
- When an object is 60 cm to 30 cm (24 inches to 12 inches) from the rear bumper: Buzzer beeps more frequently.
- When an object is within 30 cm (12 inches) of the rear bumper: Buzzer sounds continuously.

Reverse Parking Distance Warning not operation

Reverse Parking Distance Warning may not operate properly when:

- Moisture is frozen to the sensor. (It will operate normally once the moisture clears.)
- The sensor is covered with foreign matter, such as snow or water, or the sensor cover is blocked. (It will operate normally when the material is removed or the sensor is no longer blocked.)
- Driving on uneven road surfaces (unpaved roads, gravel, bumps, gradient).
- Objects generating excessive noise (vehicle horns, loud motor-cycle engines, or truck air brakes) are within range of the sensor.

- There is rain or water spraying nearby.
- Wireless transmitters or mobile phones are within range of the sensor.
- The sensor is covered with snow.
- Trailer towing

The detecting range may decrease when:

- The sensor is covered with foreign matter such as snow or water. (The sensing range will return to normal when removed.)
- Outside air temperature is extremely hot or cold.

The following objects may not be recognized by the sensor:

- Sharp or slim objects such as ropes, chains or small poles.
- Objects which tend to absorb the frequency emitted by the sensor such as clothes, sound absorbent material or snow.
- There are undetectable objects smaller than 100 cm (40 inches) in height and narrower than 15 cm (6 inches) in diameter.

Reverse Parking Distance Warning precautions

- The sound of Reverse Parking Distance Warning may change depending on the speed and shape of the objects detected.
- Reverse Parking Distance Warning may malfunction if the vehicle

bumper height or sensor installation has been modified or damaged. Any non-factory installed equipment or accessories may also interfere with the sensor performance.

- The sensor may not recognize objects less than 30 cm (12 inches) from the sensor, or it may sense an incorrect distance. Use caution.
- When the sensor is frozen or covered with snow, dirt, or water, the sensor may be inoperative until the material is removed using a soft cloth.
- To prevent damage, do not push, scratch or strike the sensor.

* NOTICE

This function can only sense objects within the range and location of the sensors. It cannot detect objects in other areas where sensors are not installed. Also, small or slim objects, such as poles or objects located between sensors may not be detected by the sensors. Pay close attention when the vehicle is driven close to objects on the road, particularly pedestrians, and especially children. Always visually check behind the vehicle when backing up. Be sure to inform any drivers of the vehicle that may be unfamiliar with

the function regarding the function's capabilities and limitations.

Self-diagnosis

If you don't hear an audible warning sound or if the buzzer sounds intermittently when shifting the gear to the R (Reverse) position, this may indicate a malfunction in Reverse Parking Distance Warning. If this occurs, have your vehicle checked by an authorized Kia dealer as soon as possible.

* NOTICE

Your new vehicle warranty does not cover any accidents or damage to the vehicle or injuries to its occupants. Always drive safely and cautiously.

Forward/Reverse Parking Distance Warning (PDW) (if equipped)

Forward/Reverse Parking Distance Warning assists the driver during movement of the vehicle by chiming if any object is sensed within the distance of 100 cm (40 inches) in front and 120 cm (48 inches) behind the vehicle.

Front



Rear



The sensing range and objects detectable by the ultrasonic sensors (1) are limited. Whenever moving

while using Forward/Reverse Parking Distance Warning, pay as much attention to what is in front and behind you as you would in a vehicle without Forward/Reverse Parking Distance Warning.

⚠ WARNING

Forward/Reverse Parking Distance Warning is a supplemental function only.

The operation of Forward/Reverse Parking Distance Warning can be affected by several factors (including environmental conditions).

It is the responsibility of the driver to always check the front and rear views before and while parking.

Forward/Reverse Parking Distance Warning operation

Operating condition



- This function activates when the Parking Safety button is pressed







with the ENGINE START/STOP button ON.

- The indicator of the Parking Safety button turns on automatically and activates Forward/Reverse Parking Distance Warning when you shift the gear to the R (Reverse) position.
- The sensing distance while backing up is approximately 120 cm (48 inches) when you are driving less than 10 km/h (6 mph).
- The sensing distance while moving forward is approximately 100 cm (40 inches) when you are driving less than 10 km/h (6 mph).
- When more than two objects are sensed at the same time, the closest one will be recognized first.
- The side sensors are activated when you shift the gear to the R (Reverse) position.
- If the vehicle speed is above 20 km/h (12 mph), the function automatically turns off. To activate again, push the button.

*** NOTICE**

It may not operate if the vehicle's distance from the object is already less than approximately 25 cm (10 inches) when the function is activated.

Type of warning indicator and sound

Distance from object		Warning indicator		Warning sound
		When driving forward	When driving backward	
100-60 cm (40-24 inches)	Front		-	Buzzer beeps intermittently
120-60 cm (48-24 inches)	Rear	-		Buzzer beeps intermittently
60-30cm (24-12 inches)	Front			Buzzer beeps frequently
	Rear	-		Buzzer beeps frequently
Within 30 cm (12 inches)	Front			Buzzer beeps continuously
	Rear	-		Buzzer beeps continuously

*** NOTICE**

- The actual warning sound and indicator may differ from the illustration depending on the objects or sensor status.
- Do not wash the vehicle's sensor with high pressure water.

sensors may not be detected by the sensors.

Always visually check behind the vehicle when backing up.

- Be sure to inform any drivers of the vehicle that may be unfamiliar with the function regarding the function's capabilities and limitations.

*** NOTICE**

- This function can only sense objects within the range and location of the sensors; it cannot detect objects in other areas where sensors are not installed. Also, small or slim objects, such as poles or objects located between

Forward/Reverse Parking Distance Warning not operation

Forward/Reverse Parking Distance Warning may not operate normally when:

- Moisture is frozen to the sensor. (It will operate normally when moisture melts.)
- Sensor is covered with foreign matter, such as snow or water, or the sensor cover is blocked. (It will operate normally when the material is removed or the sensor is no longer blocked.)
- Sensor is stained with foreign matter such as snow or water. (Sensing range will return to normal when removed.)
- The Parking Safety button is OFF.

There is a possibility of Forward/Reverse Parking Distance Warning malfunction when:

- Driving on uneven road surfaces such as unpaved roads, gravel, bumps, or gradient.
- Objects generating excessive noise such as vehicle horns, loud motorcycle engines, or truck air brakes can interfere with the sensor.
- Heavy rain or water spray.
- Wireless transmitters or mobile phones present near the sensor.
- Sensor is covered with snow.

Detecting range may decrease when:

- Outside air temperature is extremely hot or cold.
- There are undetectable objects smaller than 100 cm (40 inches) and narrower than 15 cm (6 inches) in diameter.

The following objects may not be recognized by the sensor:

- Sharp or slim objects such as ropes, chains or small poles.
- Objects, which tend to absorb sensor frequency such as clothes, spongy material or snow.

* NOTICE

1. The warning may not sound consistently depending on the speed and shapes of the objects detected.
2. Forward/Reverse Parking Distance Warning may malfunction if the vehicle bumper height or sensor installation has been modified. Any non-factory installed equipment or accessories may also interfere with the sensor performance.
3. Sensor may not recognize objects less than 30 cm (12 inches) from the sensor, or it may sense an incorrect distance. Use with caution.
4. When the sensor is frozen or stained with snow or water, the sensor may be inoperative until

the stains are removed using a soft cloth.

- 5. Do not push, scratch or strike the sensor with any hard objects that could damage the surface of the sensor. Sensor damage could occur.

*** NOTICE**

This function can only sense objects within the range and location of the sensors; it cannot detect objects in other areas where sensors are not installed. Also, small or slim objects, or objects located between sensors may not be detected.

Always visually check in front and behind the vehicle when driving. Be sure to inform any drivers in the vehicle that may be unfamiliar with the function regarding the function's capabilities and limitations.

*** NOTICE**

Pay close attention when the vehicle is driven close to objects on the road, particularly pedestrians, and especially children. Be aware that some objects may not be detected by the sensors, due to the objects distance, size or material, all of which can limit the effectiveness of the sensor. Always perform a visual inspection to make sure the vehicle

is clear of all obstructions before moving the vehicle in any direction.

Self-diagnosis

When you shift the gear to the R (Reverse) position and if one or more of the below occurs you may have a malfunction in Forward/Reverse Parking Distance Warning.

- You don't hear an audible warning sound or if the buzzer sounds intermittently.
-  (blinks) is displayed.

If this occurs, have your vehicle checked by an authorized Kia dealer as soon as possible.

*** NOTICE**

Your new vehicle warranty does not cover any accidents or damage to the vehicle or injuries to its occupants. Always drive safely and cautiously.

Blind-Spot View Monitor (BVM) (if equipped)

Blind-Spot View Monitor displays the passenger-side rear areas in the cluster when the function is activated.



To turn on Blind-Spot View Monitor

When Blind-Spot View Monitor is enabled in the settings.

1. ENGINE START/STOP button is in the ON position.
2. The turn signal is activated.

To turn off Blind-Spot View Monitor

1. ENGINE START/STOP button is in the OFF position.
2. The turn signal is deactivated.
3. Other warning screen pops up and takes priority over Blind-Spot View Monitor.

⚠ WARNING

Like all assistance function, Blind-Spot View Monitor has limitations.

Sole-reliance on the function may result in a collision.

⚠ WARNING

- This function is a supplemental function only. It is the responsibility of the driver to always check the area around the vehicle before and while making turns or changing lanes.
- Always look around your vehicle to make sure there are no objects or obstacles before moving the vehicle in any direction to prevent a collision.
- Objects are closer than they appear. Failure to visually confirm that is safe to change the lane before doing so may result in crash and serious injury or death.
- If the camera lens is covered with foreign material, Blind-Spot View Monitor may not operate normally. Always keep the camera lens clean. However, do not use chemical solvents such as strong detergents containing high alkaline or volatile organic solvents (gasoline, acetone etc.). This may damage the camera lens.

Lighting

This vehicle is equipped with a variety of lights to illuminate the interior and exterior of the vehicle.

⚠ CAUTION

To prevent the battery from being discharged, do not leave the headlight and interior light on for a prolonged time while the engine is not running.

Battery saver function

The purpose of this feature is to prevent the battery from being discharged if the lights are left in the ON position.

The system automatically shuts off the parking lights after the engine is off and the driver's door is opened.

However, the position lamps stay ON even when the driver-side door is opened if the light switch is operated after the engine is turned off.

If necessary, to keep the lamps on turn the position lamps OFF and ON again using the headlamp switch on the steering column after the engine is turned off.

Daytime Running Light (DRL)

The Daytime Running Light (DRL) can make it easier for others to see the front of your vehicle during the day.

The DRL can be helpful in many different driving conditions, and it is especially helpful after dawn and before sunset.

The DRL will turn the dedicated lamp OFF when:

- The headlight switch is on.
- The vehicle is off.
- The front fog light is on.
- Engaging the Parking Brake.

Off position



The parking lamp and headlamp will be turned ON or OFF automatically depending on the amount of daylight as measured by the ambient light sensor on the center dash when the parking brake is not engaged and shift lever is not in P (Park).

The parking lamp and headlamp will be turned OFF when the vehicle speed is less than 5 km/h and parking brake is engaged or shift lever is in P (Park).

Lighting control

The light switch has a headlight and a position lamp position.



To operate the lights, turn the knob at the end of the control lever to one of the following positions:

1. OFF position / DRL off position.
2. Auto light position
3. Position & Tail lamp
4. Headlight position

Position & Tail lamp



When the light switch is in the position lamp position, the tail, license and instrument panel lights will turn ON.

Headlight position



When the light switch is in the headlight position, the head, tail, license lights will turn ON.

* NOTICE

The ENGINE START/STOP button must be in the ON position to turn on the headlights.

Auto light



When the light switch is in the AUTO light position, the taillights and headlights will turn ON or OFF automatically depending on the amount of light outside the vehicle.

⚠ CAUTION

- Never place anything over the sensor (1) located on the instrument panel as this will ensure better auto-light system control.
- Don't clean the sensor using a window cleaner, the cleaner may leave a light film which could interfere with sensor operation.
- If your vehicle has window tint or other types of metallic coating on the front windshield, the Auto light system may not work properly.

Operating high beam



To turn on the high beam headlamp:

- Push the lever away from you. The lever will return to its original position. The high beam indicator will light when the headlight high beams are switched on.

⚠ WARNING

High beams

Do not use high beam when there are other vehicles in front of or approaching your vehicle. Using high beam could obstruct the other driver's vision.

To flash the headlights:

- Pull the lever towards you.



It will return to the normal (low beam) position when released. The headlight switch does not need to be on to use this flashing feature.

Operating turn signals and lane change signals



The ENGINE START/STOP button must be on for the turn signals to function.

To turn on the turn signals:

- Move the lever up or down (A). The green arrow indicators on the instrument panel indicate which turn signal is operating.

They will self-cancel after a turn is completed. If the indicator continues to flash after a turn, manually return the lever to the OFF position.

To signal a lane change:

- Move the turn signal lever slightly and hold it in position (B). The lever will return to the OFF position when released.

If an indicator stays on and does not flash or if it flashes abnormally, one of the turn signal bulbs may be burned out and will require replacement.

* NOTICE

If an indicator flash is abnormally quick or slow, a bulb may be burned out or have a poor electrical connection in the circuit.

One-touch lane change function

To activate a one-touch lane change function, move the turn signal lever slightly and then release it. The lane change signals will blink 3, 5 or 7 times.

You can activate or deactivate the One Touch Turn Signal function or choose the number of blinking (3, 5, or 7) by selecting "User Settings → Lights → One Touch Turn Signal".

* NOTICE

If the turn signal indicator stays on and does not flash, or if it flashes abnormally, a bulb may be burned out or have a poor electrical connection in the circuit. The bulb may require replacement.

Operating front fog light (if equipped)

Fog lights are designed to provide improved visibility when visibility is poor due to fog, rain or snow, etc.



The fog lights will turn on when the fog light switch (1) is turned to the on position after the headlight is turned on.

To turn off the fog lights:

- Turn the fog light switch (1) to the OFF position.

High Beam Assist (HBA) (if equipped)

High Beam Assist is a function that automatically adjusts the headlamp range (switches between high beam and low beam) according to the brightness of other vehicles and road conditions.



Operating High Beam Assist

High Beam Assist can be operated using the light switch.

1. Place the light switch in the AUTO position.
2. Turn on the high beam by pushing the lever away from you.
3. The High Beam Assist (HBA) indicator will illuminate.
4. High Beam Assist will turn on when vehicle speed is above 40 km/h (25 mph).

The details of operation with the light switch while High Beam Assist is on are below.

- If the light switch is pushed away, High Beam Assist will turn off and the high beam will be on continuously.
- If the light switch is pulled towards you when the high beam is off, the high beam will be on without canceling the operation of High Beam Assist. (When you take your hands off the switch, the lever will move to the middle and the high beam will turn off.)
- If the light switch is pulled towards you when the high beam is turned on using High Beam Assist, the low beam will turn on and High Beam Assist turn off.
- If the light switch is turned to the headlamp position  from AUTO position, High Beam Assist will turn off and the low beam will be on continuously.

When High Beam Assist is operating, the high beam switches to low beam in the following conditions.

- When the headlamp is detected from the on-coming vehicle.
- When the tail lamp is detected from the front vehicle.
- When headlamp / tail lamp of bicycle/motorcycle is detected.
- When the surrounding is so bright that high beams are not needed.

- When streetlights or other lights are detected.
- When the light switch is not in the AUTO position.
- When High Beam Assist is off.
- When vehicle speed is below 24 km/h (15 mph).

High Beam Assist warning light and message

When High Beam Assist is not working properly, a warning message “Check High Beam Assist (HBA) system” will come on for a few seconds.

After the message disappears, the master warning light  will illuminate. Take your vehicle to an authorized Kia dealer and have the function checked.

⚠ CAUTION

High Beam Assist may not work properly in the following situations:

- When the light from on-coming or front vehicle is poor
 - When the light from on-coming or front vehicle is not detected because of lamp damage, or because it is hidden from sight, etc.
 - When the lamp of on-coming or front vehicle is covered with dust, snow or water.
 - When a front vehicle's headlamps are off but the fog lamps on and etc.

- When external conditions intervene
 - When there is a lamp that has a similar shape as a front vehicle's lamps.
 - When the headlamp is not repaired or replaced at an authorized Kia dealer.
 - When headlamp aiming is not properly adjusted.
 - When driving on a narrow curved road, rough road, downhill or uphill.
 - When only part of the vehicle in front is visible on a crossroad or curved road.
 - When there is a traffic light, reflecting sign, flashing sign or mirror ahead.
 - When there is a temporary reflector or flash ahead (construction area).
 - When the road conditions are poor such as being wet, iced or covered with snow.
 - When a vehicle suddenly appears from a curve.
 - When the vehicle is tilted from a flat tire or being towed.
 - When Lane Keeping Assist failure indicator (yellow) illuminates.
- When front visibility is poor
 - When the lamp of the on-coming or front vehicle is covered with dust, snow or water.
 - When the light from on-coming or front vehicle is not detected

because of exhaust fume, smoke, fog, snow, etc.

- When the front window is covered with foreign substance.
- When it is hard to see because of fog, heavy rain or snow and etc.

* NOTICE

- Do not disassemble a front view camera temporarily for tinted window or attaching any types of coatings and accessories. If you disassemble the camera and assemble it again, take your vehicle to an authorized Kia dealer and have the function checked.
- When you replace or reinstall the windshield glass take your vehicle to an authorized Kia dealer and have the function checked.
- Be careful that water doesn't get into the High Beam Assist unit and do not remove or damage parts of High Beam Assist.
- Do not place objects on the dashboard that reflect light such as mirrors, white paper, etc. The function may not be able to function if sunlight is reflected onto it.
- At times, High Beam Assist may not operate due to function limitations. The function is for your convenience only. It is the responsibility of the driver to drive safely and always check the road conditions.

- When the function does not operate normally, change the lamp position manually between the high beam and low beam.

Wipers and washers

The wipers and washers remove foreign substances from the windshield and rear window, helping to maintain visibility.

Front windshield wiper/washer



Rear windshield wiper/washer



A: Wiper speed control (front)

- MIST – Single wipe
- OFF – Off
- INT – Intermittent wipe
- AUTO* – Auto control wipe
- LO – Low wiper speed
- HI – High wiper speed

B: Intermittent control wipe time adjustment**C: Wash with brief wipes (front)****D: Rear wiper/washer control**

- HI – Continuous wipe
- LO – Intermittent wipe
- OFF – Off

E: Wash with brief wipes (rear)

*: if equipped

Windshield washers

Operates as follows when the ENGINE START/STOP button is turned ON.

MIST: For a single wiping cycle, move the lever to this (MIST) position and release it. The wipers will operate continuously if the lever is held in this position.

OFF: Wiper is not in operation

INT: Wiper operates intermittently at the same wiping intervals. Use this mode in light rain or mist. To vary the speed setting, turn the speed control switch.

LO: Normal wiper speed

HI: Fast wiper speed

*** NOTICE**

If there is heavy accumulation of snow or ice on the windshield, defrost the windshield for about 10 minutes, or until the snow and/or

ice is removed before using the windshield wipers to ensure proper operation. If you do not remove the snow and/or ice before using the wiper and washer, it may damage the wiper and washer system.

⚠ WARNING

Do not use the washer in freezing temperatures without first warming the windshield with the defrosters; the washer solution could freeze on the windshield and obscure your vision.

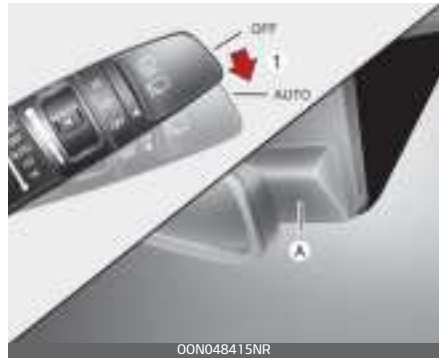
Auto control (if equipped)

The rain sensor (A) located on the upper end of the windshield glass senses the amount of rainfall and controls the wiping cycle for the proper interval. The more it rains, the faster the wiper operates. When the rain stops, the wiper stops.

To vary the speed setting, turn the speed control knob (1).

If the wiper switch is set in AUTO mode when the ENGINE START/STOP button is ON position, the wiper will operate once to perform a self-check of the system. Set the wiper to the OFF position when the wiper is not in use.

⚠ WARNING

When the ENGINE START/STOP button is in the ON position and the windshield wiper switch is placed in AUTO mode, use caution in the following situations to avoid any injury to the hands or other parts of the body:

- Do not touch the upper end of the windshield glass facing the rain sensor.
- Do not wipe the upper end of the windshield glass with a damp or wet cloth.
- Do not put pressure on the windshield glass.

⚠ CAUTION

- When washing the vehicle, set the wiper switch in the OFF position to stop the auto wiper operation. The wiper may operate and be damaged if the switch is set in AUTO mode while washing the vehicle.

- Do not remove the sensor cover located on the upper end of the passenger side windshield glass. Damage to system parts could occur and may not be covered by your vehicle warranty.
- When starting the vehicle in winter, set the wiper switch in the OFF position. Otherwise, wipers may operate and ice may damage the windshield wiper blades. Always remove all snow and ice and defrost the windshield properly prior to operating the windshield wipers.

Operating windshield washer

Use this function when the windshield is dirty.



1. Move the wiper speed control switch to the OFF position.
2. Pull the lever gently toward you to spray washer fluid on the windshield and to run the wipers 1–3 cycles.

The spray and wiper operation will continue until you release the lever.

If the washer does not work, check the washer fluid level. If the fluid level is not sufficient, you will need to add appropriate non-abrasive windshield washer fluid to the washer reservoir.

The reservoir filler neck is located in the front of the motor compartment on the passenger side.

CAUTION

Washer pump

To prevent possible damage to the washer pump, do not operate the washer when the fluid reservoir is empty.

CAUTION

Wipers & windshields

- To prevent possible damage to the wipers or windshield, do not operate the wipers when the windshield is dry.
- To prevent damage to the wiper blades, do not use gasoline, kerosene, paint thinner, or other solvents on or near them.
- To prevent damage to the wiper arms and other components, do not attempt to move the wipers manually.

Operating rear window wiper and washer switch

The rear window wiper and washer switch is located at the end of the wiper and washer switch lever.

- Turn the switch to the desired position to operate the rear wiper and washer.



- HI: Continuous wipe
- LO: Intermittent wipe
- OFF: OFF
- Push the lever away from you to spray rear washer fluid and to run the rear wipers 1~3 cycles.



The spray and wiper operation will continue until you release the lever

Interior lights

This vehicle is equipped with lights throughout the vehicle to illuminate the interior.

Automatic turn off function (if equipped)

The interior lights automatically turn off approximately 20 minutes after the ENGINE START/STOP button is turned off, if the lights are in the ON position.

If your vehicle is equipped with the theft alarm system, the interior lights automatically turn off approximately 5 seconds after the system is armed.

Map lamp



- Press the lens (1) to turn ON the map lamp.
To turn the map lamp OFF press the lens (1) again.
-  (2): DOOR mode

- The map lamp and room lamp come on when a door is opened. The lamps go out after approximately 30 seconds.
- The map lamp and room lamp come on for approximately 30 seconds when doors are unlocked with a smart key as long as the doors are not opened.
- The map lamp and room lamp will stay on for approximately 20 minutes if a door is opened with the ENGINE START/STOP button in the ACC or OFF position.
- The map lamp and room lamp will stay on continuously if the door is opened with the ENGINE START/STOP button in the ON position.
- The map lamp and room lamp will go out immediately if the ENGINE START/STOP button is changed to the ON position or all doors are locked.
- To turn off the DOOR mode, press the DOOR button (2) once again (not pressed).
-  (3): Press this switch to turn the front and rear room lamps on and off.

Room lamp

Type A



Type B



- (1): The light stays on at all times.

Liftgate room lamp



- DOOR: The light comes on when the liftgate is opened.
- OFF: The light stays off at all times.
- ON: The light stays on at all times.

Vanity mirror lamp



Opening the lid of the vanity mirror will automatically turn on the mirror light.

* The actual sun visor lamp in the vehicle may differ from the illustration.

⚠ CAUTION**Vanity mirror lamp**

Always close the lid of the vanity mirror in the off position when the vanity mirror lamp is not in use. If the sun visor is closed without the lamp off, it may discharge the battery or damage the sun visor.

Glove box lamp (if equipped)

The glove box lamp comes on when the glove box is opened.

**⚠ CAUTION**

To prevent unnecessary charging system drain, close the glove box securely after using the glove box.

Welcome system (if equipped)

The welcome system is a function that illuminates the surroundings or the interior when the driver approaches or exits the vehicle.

Headlight (headlamp) escort function

The headlights (and/or taillights) remain on for approximately 5 minutes after the vehicle is turned off. However, if the driver's door is opened and closed, the headlights are turned off after 15 seconds.

The headlights can be turned off by pressing the lock button on the smart key twice or turning off the light switch from the headlight or Auto light position.

Interior light

When the interior light switch is in the DOOR position and all doors (and liftgate) are locked and closed, the room lamp will come on for 30 seconds if any of the following occurs:

- With the smart key system
 - When the door unlock button is pressed on the smart key.
 - When the button of the outside door handle is pressed.

At this time, if you press the door lock button, the lamps will turn off immediately.

Pocket lamp (if equipped)

When all doors are locked and closed, the pocket lamp will come on for 15 seconds if any of the following occurs:

- With the smart key system
 - When the door unlock button is pressed on the smart key.
 - When the button of the outside door handle is pressed.

At this time, if you press the door lock button, the lamps will turn off immediately.

Defroster

The vehicle is equipped with a defroster for removing frost or fog from the rear window.

CAUTION

Conductors

To prevent damage to the conductors bonded to the inside surface of the rear window, never use sharp instruments or window cleaners containing abrasives to clean the window.

If you want to defrost and defog the front windshield, refer to "Windshield defrosting and defogging" on page 4-152.

Operating rear window defroster

The defroster heats the window to remove frost, fog and thin ice from the rear window, while the vehicle is on.

If there is heavy accumulation of snow on the rear window, brush it off before operating the rear defroster.

Type A

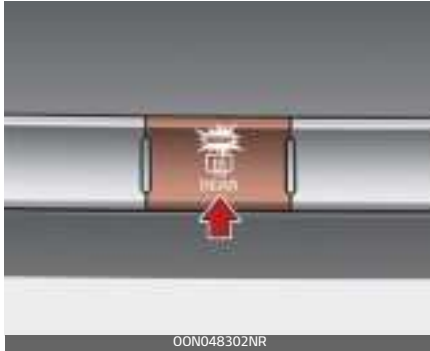

Type B

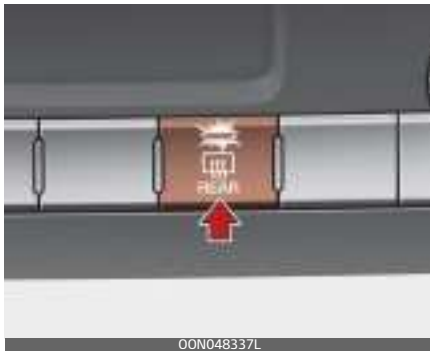

- Press the rear window defroster button again.

Operating outside mirror defroster

If your vehicle is equipped with the outside rearview mirror defrosters, they will operate simultaneously when you turn on the rear window defroster.

To activate the rear window defroster:

- Press the rear window defroster button located in the center fascia switch panel.
The indicator on the rear window defroster button illuminates when the defroster is ON.
The rear window defroster automatically turns off after approximately 20 minutes or when the ENGINE START/STOP button is turned off.

To turn off the defroster:

Climate control system



The climate control system uses cooling and heating to help maintain a pleasant environment inside the vehicle.

System operation

Ventilation

1. Set the mode to the  position.
2. Set the air intake control to the outside (fresh) air position.
3. Set the temperature control to the desired position.
4. Set the fan speed control to the desired speed.

Heating

1. Set the mode to the  position.
2. Set the air intake control to the outside (fresh) air position.
3. Set the temperature control to the desired position.
4. Set the fan speed control to the desired speed.
5. If dehumidified heating is desired, turn the air conditioning system on.
 - If the windshield fogs up, set the mode to the  or  position.

Operation tips

- To keep dust or unpleasant fumes from entering the vehicle through the ventilation system, tempo-

rarily set the air intake control to the recirculated air position. Be sure to return the control to the fresh air position when the irritation has passed to keep fresh air in the vehicle. This will help keep the driver alert and comfortable.

- Air for the heating/cooling system is drawn in through the grilles just at the base of the windshield. Care should be taken that these are not blocked by leaves, snow, ice or other obstructions.
- To prevent fog from forming on the inside of the windshield:
 - Set the air intake control to the fresh air position and the fan speed to the desired position.
 - Turn on the air conditioning system, and adjust the temperature control to desired temperature.

Air conditioning (A/C)

All Kia air conditioning systems are filled with R-1234yf refrigerant.

1. Start the vehicle. Press the A/C button.
2. Set the mode to the  position.
3. Set the air intake control to the outside-air or recirculated air position.
4. Adjust the fan speed control and temperature control to maintain maximum comfort.
 - When maximum cooling is desired, set the temperature

control to the extreme left position, set the mode control to the MAX A/C position, then set the fan speed control to the highest speed.

⚠ CAUTION

- The refrigerant system should only be serviced by trained and certified technicians to insure proper and safe operation.
- The refrigerant system should be serviced in a well-ventilated place.
- The air conditioning evaporator (cooling coil) shall never be repaired or replaced with one removed from a used or salvaged vehicle and new replacement MAC evaporators shall be certified (and labeled) as meeting SAE Standard J2842.

⚠ CAUTION

Excessive Air conditioning Use

When using the air conditioning system, monitor the temperature gauge closely while driving up hills or in heavy traffic when outside temperatures are high. Air conditioning system operation may cause vehicle overheating. Continue to use the blower fan but turn the air conditioning system off if the temperature gauge indicates vehicle overheating.

⚠ CAUTION

The air conditioning system should only be used with the windows and sunroof closed to prevent condensation inside the vehicle that may cause damage to electrical components.

Air conditioning system operation tips

- If the vehicle has been parked in direct sunlight during hot weather, open the windows for a short time to let the hot air inside the vehicle escape.
- To help reduce moisture inside of the windows on rainy or humid days, decrease the humidity inside the vehicle by operating the air conditioning system.
- During air conditioning system operation, you may occasionally notice a slight change in vehicle speed as the air conditioning compressor cycles. This is a normal characteristic of system operation.
- To ensure maximum system performance, the air conditioning system should be ran for a few minutes each month.
- When using the air conditioning system, you may notice clear water dripping (or even puddling) on the ground under the passenger side of the vehicle. This is a

normal characteristic of system operation.

- Operating the air conditioning system in the recirculated air position provides maximum cooling; however, continual operation in this mode may cause the air inside the vehicle to become stale.
- During cooling operation, you may occasionally notice a misty air flow because of rapid cooling and humid air intake. This is a normal characteristic of system operation.

Climate control air filter

The climate control air filter installed behind the glove box filters the dust or other pollutants that come into the vehicle from the outside through the heating and air conditioning system.

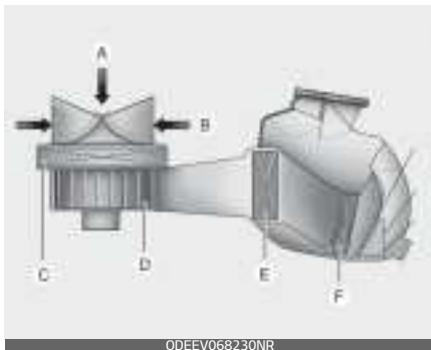

A: Outside air

B: Recirculated air

C: Climate control air filter

D: Blower

E: Evaporator core

F: Heater core

If dust or other pollutants accumulate in the filter over a period of time, the air flow from the air vents may decrease. This leads to moisture accumulating on the inside of the windshield even when the outside (fresh) air position is selected. If this happens, have the climate control air filter replaced by an authorized Kia dealer.

* NOTICE

- Replace the filter according to the Maintenance Schedule. If the vehicle is being driven in severe conditions such as dusty or rough roads, more frequent air conditioner filter inspections and changes are required.
- When the air flow rate suddenly decreases, the system should be checked at an authorized Kia dealer.

Checking the amount of air conditioner refrigerant and compressor lubricant

When the amount of refrigerant is low, the performance of the air conditioning is reduced. Overfilling also has a negative impact on the air conditioning system.

Therefore, if abnormal operation is found, have the system inspected by an authorized Kia dealer.

WARNING

The oil and refrigerant in your vehicle's air conditioning system is under very high pressure. If proper service procedures are not followed an explosion may result. To reduce the risk of serious injury or death, the air conditioning system in your vehicle should only be serviced by trained and certified Kia technicians.

CAUTION

It is important that the correct type and amount of oil and refrigerant is used, otherwise, damage to the vehicle may occur. To prevent damage, the air conditioning system in your vehicle should only be serviced by trained and certified Kia technicians.

WARNING

Vehicles equipped with R-1234yf



Because the refrigerant is mildly flammable and at very high pressure, the air conditioning system should only be serviced by trained and certified technicians.

It is important that the correct type and amount of oil and refrigerant is used.

Otherwise, it may cause damage to the vehicle and bodily injury.

Automatic climate control system

The automatic climate control system uses cooling and heating to help maintain a pleasant environment inside the vehicle.



OON048301NR

1. Driver's temperature control knob
2. AUTO (automatic control) button
3. OFF button
4. Front windshield defroster button
5. Fan speed control button
6. Rear control button
7. Mode selection button
8. Air conditioning (A/C) button
9. Rear window defroster button
10. Air intake control button
11. Passenger's temperature control knob
12. SYNC button
13. Air conditioning display

* NOTICE

Operating the blower when the ENGINE START/STOP button is in the ON position could cause the battery to discharge. Operate the blower when the vehicle is ON.

Heating and air conditioning automatically

1. Press the AUTO button.

The modes, fan speeds, air intake and air-conditioning will be controlled automatically by setting the temperature.



2. Turn the temperature control switch to the desired temperature.

Driver's side

Passenger's side



• To turn the automatic operation off, select any of the following buttons or switches:

- Mode selection button
- Air conditioning (A/C) button

- Front windshield defroster button (Press the button one more time to deselect the front windshield defroster function. The 'AUTO' sign will illuminate on the information display once again.)
- Fan speed control switch
The selected function will be controlled manually while other functions operate automatically.
- For your convenience and to improve the effectiveness of the climate control, use the AUTO button and set the temperature to 22 °C (72 °F).

* NOTICE

Do not place anything over the sensor located on the instrument panel to ensure better control of the heating and cooling system.

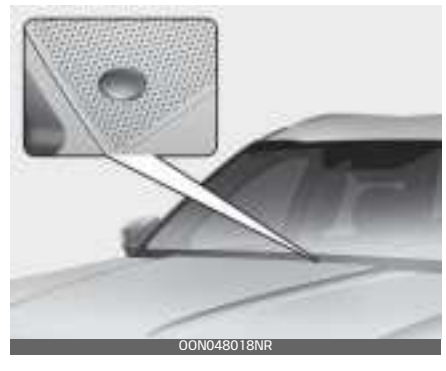

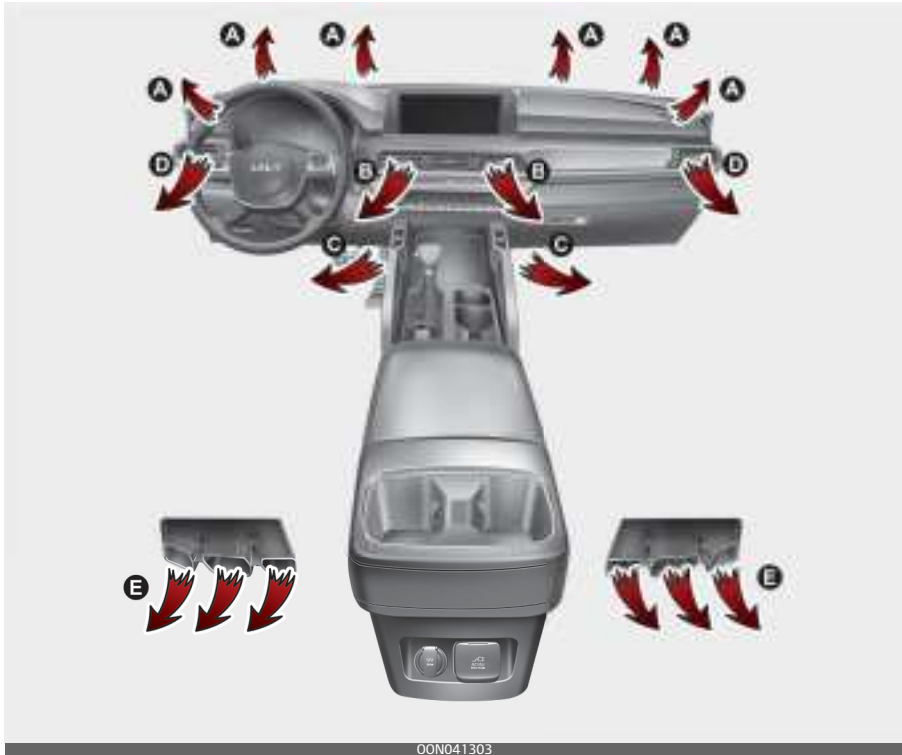

Heating and air conditioning manually

The heating and cooling system can be controlled manually by pressing buttons or turning knob(s) other than the AUTO button.



OON041303

In this case, the system works sequentially according to the order of buttons or knob(s) selected.

1. Start the vehicle.
2. Set the mode to the desired position.
 - For improving the effectiveness of heating and cooling;
 - Heating: 
 - Cooling: 
3. Set the temperature control to the desired position.
4. Set the air intake control to the outside (fresh) air position.
5. Set the fan speed control to the desired speed.
 - If air conditioning is desired, turn the air conditioning system on.

Press the AUTO button in order to convert to fully automatic control of the system.

Mode selection

The mode selection button controls the direction of the air flow through the ventilation system.

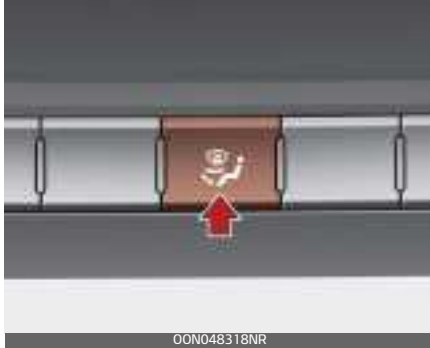

The air flow outlet ports are switched in the following sequence:



Face-Level (B, D)

Air flow is directed toward the upper body and face. Additionally, each outlet can be controlled to direct the air discharged from the outlet.

Bi-Level (B, C, D, E)

Air flow is directed towards the face and the floor.

Floor-Level (A, C, D, E)

Most of the air flow is directed to the floor, with a small amount of the air being directed to the windshield and side window defrosters.

Floor/Defrost-Level (A, C, D, E)

Most of the air flow is directed to the floor and the windshield with a small amount directed to the side window defrosters.

Defrost-Level (A, D)



Most of the air flow is directed to the windshield with a small amount of air directed to the side window defrosters.

Temperature control

Driver's side

Passenger's side



The temperature will increase to the maximum (HI) by turning the knob all the way to the right.

The temperature will decrease to the minimum (Lo) by turning the knob all the way to the left.

When turning the knob, the temperature will increase or decrease by 0.5 °C/1 °F. When set to the lowest temperature setting, the air conditioning will operate continuously.

* NOTICE

When starting the vehicle in cold weather using manual temperature control, operate the system in the following method to improve heating.

- Turn off or lower the blower, right after starting the engine.

- Allow the engine to warm up during this time since the air flow from the heater is still cold.
- After a few minutes of engine warm up, turn on or set the fan to a higher level and adjust the temperature setting to hot.

Adjusting the driver and passenger side temperature, fan speed and air flow direction equally



1. Press the "SYNC" button to adjust the driver and front/rear passenger side temperature, fan speed and air flow direction equally. The front and rear passenger side temperature, fan speed and air flow direction will be set to the same temperature, fan speed and air flow direction as the driver's side.
2. Turn the driver side temperature control knob. The driver and front/rear passenger side temperature will be adjusted equally. Press the fan speed control button. The driver and front/rear

passenger side fan speed will be adjusted equally.

Press the driver side mode selection button. The driver and front/rear passenger side air flow will be adjusted equally.

- When the rear climate control is turned ON, the fan speed and air flow direction will automatically follow the first row setting.

Adjusting the driver and passenger side temperature, fan speed and air flow direction individually

- Press the "SYNC" button again to adjust the driver and front/rear passenger side temperature, fan speed and air flow direction individually.

Changing temperature scale

- To change the temperature display from Fahrenheit to Celsius and vice versa, press the OFF button, while pressing the AUTO button for 3 seconds or more.

The display will change from Centigrade to Fahrenheit, or from Fahrenheit to Centigrade. If the battery has been discharged or disconnected, the temperature mode display will reset to Fahrenheit.

Controlling air intake

This is used to select the outside (fresh) air position or recirculated air position.



To change the air intake control position:

- Push the desired control button.

Outside (fresh) air position



With the outside (fresh) air position selected, air enters the vehicle from outside and is heated or cooled according to the function selected.

Recirculated air position



With the recirculated air position selected, air from the passenger compartment will be drawn through the heating system and heated or cooled according to the function selected.

Prolonged operation of the heater in the recirculated air position (without air conditioning selected) may cause fogging of the windshield and side

windows and make the air in the passenger compartment stale. In addition, prolonged use of the air conditioning with the recirculated air position selected will result in excessively dry air in the passenger compartment.

Controlling fan speed

The fan speed can be set to the desired speed by operating the fan speed control button.

To change the fan speed:

- Press button right for higher speed, or press button left for lower speed.

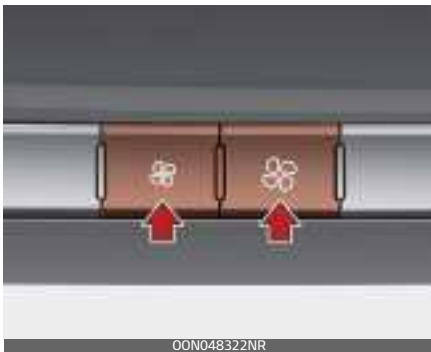

To turn the fan speed control off:

- Press the front blower OFF button.

Air conditioning (A/C)

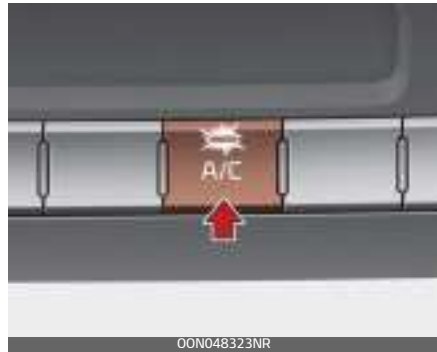

- Press the A/C button to turn the air conditioning system on (indicator light will illuminate).
- Press the button again to turn the air conditioning system off.

⚠ WARNING

Reduced Visibility

Continuous use of the climate control system in the recirculated air position may allow humidity to increase inside the vehicle which may fog the glass and obscure visibility.

⚠ WARNING

Recirculated Air

Continued use of the climate control system in the recirculated air position can cause drowsiness or sleepiness, and loss of vehicle control. Set the air intake control to the outside (fresh) air position as much as possible while driving.

⚠ WARNING

Sleeping with A/C on

Do not sleep in a vehicle with the air conditioning or heating on as this may cause serious harm or death due to a drop in the oxygen level and/or body temperature.

Turning off the front air climate control



- Press the OFF button to turn off the front and rear air climate control system.

However, you can still operate the mode and air intake buttons as long as the ENGINE START/STOP button is in the ON position.

Controlling rear climate

Rear



1. Rear temperature control button
 2. Rear AUTO button
 3. Rear mode selection button
 4. Rear air conditioning display
 5. Rear air conditioning OFF button
 6. Rear fan speed control button
- When the "SYNC" is ON, the rear temperature, rear fan speed and rear mode is controlled automatically by the front climate control system.
 - If you operate the rear temperature, rear fan speed or rear mode on the rear climate control panel, the corresponding rear temperature, rear fan speed or rear mode will operate independently regardless of the front climate control system operation.

Controlling rear fan speed

Front climate control panel

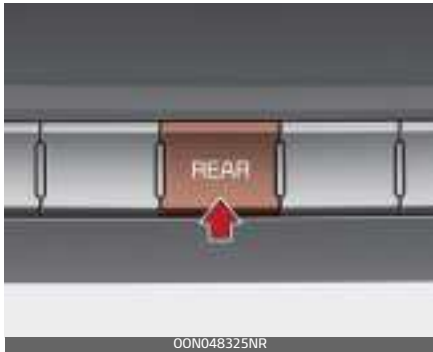

1. Press the REAR button located on the front climate control panel and press the rear fan speed control button on the audio or multimedia screen.
2. To change the fan speed, press (⌘) the button for higher speed, or press the (⌘) the button for lower speed.
The fan speed is displayed on the screen.

Rear climate control panel



1. Adjust the fan speed by pressing the rear fan speed control button.

2. To change the speed, press the button (⌘) for higher speed, or press the button (⌘) for lower speed.
The fan speed is displayed on the screen.

Controlling rear temperature

Front climate control panel

1. Press the REAR button located on the front climate control panel and adjust the temperature on the audio or multimedia screen.

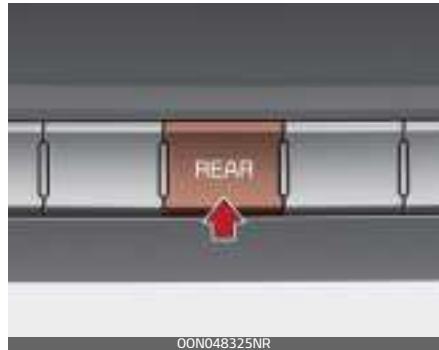

2. Press the button (+) for warmer air or press the button (-) for cooler air.

Rear climate control panel

1. Adjust the temperature by pressing the rear temperature control button.

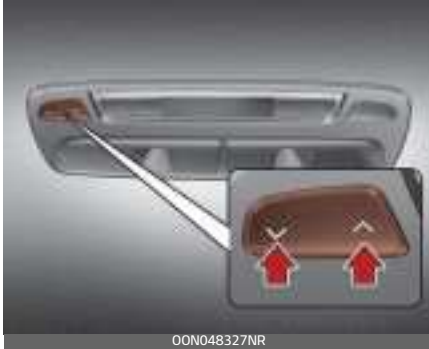

2. To change the temperature, press the button (∧) for warmer air or press the button (∨) for cooler air. The temperature is displayed on the screen.

OFF mode

Front climate control panel

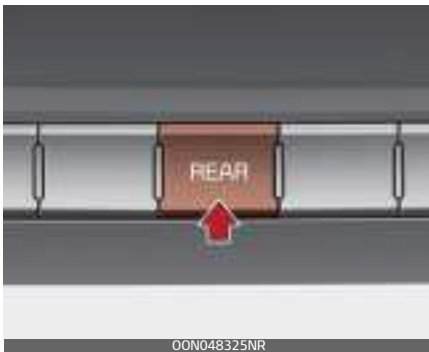

- To turn off the rear climate control system, press the REAR button located on the front climate

control panel and OFF button on the audio or multimedia screen.

Rear climate control panel





- To turn off the rear climate control system, press the rear blower OFF button

Selecting rear mode







The rear mode is selected by pressing the rear mode selection button on the rear control panel as follows:

- : Rear air blows from the upper vents.
- : Rear air blows from the upper vents on the rear ceiling and the lower vents.
- : Rear air blows from the right side lower vents.





: Air discharged from [A] spreads over a wider area.

: Air discharged from [B] has a centered and direct flow.

Opening/closing the vent and adjusting the direction

You can set the direction of air by adjusting the knob of air vents located above the 2nd-row and 3rd-row seats. Adjust the outer and central parts of the air vent to the desired positions.

Outer part of the vent (A)		Central part of the vent (B)	Description
Open		Close	The air spreads widely around the passenger. However, the air volume may decrease.
Open		Open	The air is spread widely towards and around the passenger.
Close		Open	The air blows only towards the passenger.

*** NOTICE**



If all the vents are closed, it may cause some noise. Always open 2 vents or more.

Windshield defrosting and defogging

When the windshield is covered with frost or moisture, the front view is blurred, you should remove the frost and moisture.

⚠ WARNING

Windshield heating

Do not use the  or  position during cooling operation in extremely humid weather. The difference between the temperature of the outside air and the windshield could cause the outer surface of the windshield to fog up, causing loss of visibility. In this case, set the mode selection to the  position and fan speed control to the lower speed.

- To speed up the defrosting process, turn the temperature control all the way to the right and set the fan speed to the highest.
- If you want warm air to flow towards the floor while defrosting or defogging, set the mode to the floor-defrost position.
- Before driving, clear all snow and ice from the windshield, rear window, outside rear view mirrors, and all side windows.
- Clear all snow and ice from the hood and air inlet in the cowl grill to improve heater and defroster

efficiency and to reduce the probability of fogging up the inside of the windshield.

⚠ CAUTION



Do not place anything on the instrument panel which may cover the air outlets. Otherwise, air flow may be obstructed, preventing the windshield defoggers from defogging.



Defogging inside windshield with manual climate control system



1. Select any fan speed except "0" position.

2. Select desired temperature.
3. Select the  or  position.
The outside (fresh) air and air conditioning will be selected automatically.

If the air conditioning and outside (fresh) air position are not selected automatically, press the corresponding button manually.

Defrosting outside windshield with manual climate control system



1. Set the fan speed to the highest (extreme right) position.
2. Set the temperature to the extreme hot position.
3. Select the  position.
The outside (fresh) air and air conditioning will be selected automatically.

Defogging inside windshield with the automatic climate control



1. Set the fan speed to the desired position.
2. Select desired temperature.
3. Press the defroster button ().

The outside (fresh) air position will be selected automatically and the air conditioning will turn on according to the detected ambient temperature.

If the air conditioning and outside (fresh) air position are not selected automatically, adjust the corresponding button manually. If the  position is selected, lower fan speed is adjusted to a higher fan speed.

Defrosting outside windshield with automatic climate control



1. Set the fan speed to the highest position.
 2. Set the temperature to the extreme hot (HI) position.
 3. Press the defroster button (windshield with wipers icon).
- The outside (fresh) air position will be selected automatically and the air conditioning will turn on according to the detected ambient temperature.

Defogging logic (if equipped)

To reduce the possibility of fogging up the inside of the windshield, the air intake or air conditioning is controlled automatically according to certain conditions such as windshield wiper or defroster position.

To cancel automatic defogging logic or return to the automatic defogging logic, do the following.

Canceling/returning automatic defogging logic on manual climate control system



1. Turn the ENGINE START/STOP button to the ON position.
2. Turn the mode selection knob to the defrost position (windshield with wipers icon).
3. Push the air intake control button at least 5 times within 3 seconds. The indicator light in the air intake control button will blink 3 times. It indicates that the defogging logic is canceled or returned to the programmed status.

If the battery has been discharged or disconnected, it resets to the defog logic status.

Canceling/returning automatic defogging logic on automatic climate control system



1. Turn the ENGINE START/STOP button to the ON position.
2. Press the defroster button ().
3. While pressing the air conditioning (A/C) button, press the air intake control button at least 5 times within 3 seconds. The recirculation indicator blinks 3 times in 0.5 second of intervals. It indicates that the defogging logic is canceled or returned to the programmed status.

If the battery has been discharged or disconnected, it resets to the defog logic status.

Auto Defogging System (ADS) (only for automatic climate control system) (if equipped)

The Auto Defogging System (ADS) reduces the probability of fogging up the inside of the windshield by automatically sensing the moisture inside the windshield.



The ADS operates when the heater or air conditioning is on.

The indicator illuminates when the ADS senses the moisture on the inside of the windshield and operates.

The ADS addresses excess moisture on the inside of the windshield in stages. For example if auto defogging does not defog inside the windshield at step 1, it tries to defog again at step 2.

1. Outside air position
2. Operating the air conditioning
3. Increasing air flow toward the windshield
4. Blowing air flow toward the windshield

Turning the ADS on or off

- Press the front windshield defroster button for 3 seconds when the ENGINE START/STOP button is in the ON position. When the ADS system is canceled, the defroster button indicator will blink 3 times per 0.5 sec.
- To reset the ADS system to ON, hold the front windshield defrost for 0.25 sec and the "ADS OFF" will be removed from the climate control screen.

⚠ CAUTION

Do not remove the sensor cover located on the upper end of the passenger side windshield glass. Damage to the system parts could occur and may not be covered by your vehicle warranty.

Additional features of climate control**Sunroof inside air recirculation (if equipped)**

The outside (fresh) air position is automatically selected, when the sunroof is opened.

When you select the recirculated air position, the system maintains the recirculated air position for 3 minutes and then automatically converts to the outside (fresh) air position.

When the sunroof is closed, the air intake position will return to the original position that was selected.

Automatic ventilation (if equipped)

The system automatically selects the outside (fresh) air position when the climate control system operates over a certain period of time (approximately 30 minutes) in low temperature with the recirculated air position selected.

To cancel or reset the Automatic Ventilation

When the air conditioning system is on, select Face Level  mode and while pressing the A/C button, press the recirculated air position button five times within three seconds.

When the automatic ventilation is canceled, the indicator blinks 3 times. When the automatic ventilation is activated, the indicator blinks 6 times.

Storage compartment

These compartments can be used to store small items required by the driver or passengers.

- To avoid possible theft, do not leave valuables in the storage compartment.
- Always keep the storage compartment covers closed while driving. Do not place too many items in the storage compartment to make sure that the compartment can be closed securely.

WARNING

Flammable materials

Do not store, propane cylinders or other flammable/explosive materials in the vehicle. These items may catch fire and/or explode if the vehicle is exposed to hot temperatures for extended periods.

Center console storage



To open the center console storage:

- Pull up the lever.

Glove box



The glove box can be locked and unlocked with the mechanical key (1).

To open:

- Pull the lever (2).

Close the glove box after use.

⚠ WARNING

Glove Box

To reduce the risk of injury in an accident or sudden stop, always keep the glove box door closed while driving.

* NOTICE

If the temperature control switch is in the warm or hot position, warm or hot air will flow into the glove box.

Sunglass holder



To open the sunglasses holder:

- Press the cover and the holder will slowly open.

Place your sunglasses with the lenses facing out. To close the sunglasses holder push it up.

⚠ WARNING**Sunglass holder**

- Do not keep objects except sunglasses inside the sunglass holder. Such objects can be thrown from the holder in the event of a sudden stop or an accident, possibly injuring the passengers in the vehicle.
- Do not open the sunglass holder while the vehicle is moving. The rear view mirror of the vehicle can be blocked by an opened sunglass holder.

Luggage box

You can place a first aid kit, a reflector triangle, tools, etc. in the box for easy access.

- Grasp the handle on the edge of the cover and lift it.

Interior features

There are various features inside the vehicle for the convenience of the occupants.

Cup holder

The front and rear seats of the vehicle have cup holders to accommodate cups.

⚠ WARNING**Hot liquids**

Do not place uncovered cups with hot liquid in the cup holder while the vehicle is in motion. If the hot liquid spills, you may burn yourself. Such a burn to the driver could lead to loss of control of the vehicle.

⚠ CAUTION

- Keep your drinks sealed while driving to prevent spilling your drink. If liquid spills, it may get into the vehicle's electrical/electronic system and damage electrical/electronic parts.
- When cleaning spilled liquids, do not use heat to dry the cup holders. This may damage the cup holder.
- Use shatter-proof and light containers. Otherwise, there is the increased danger of injury in an accident.

- Do not forcefully push unsuitable containers into the cup holders. This may result in damage.

Front



2nd row



2nd row – center



3rd row



Cups or small beverage cans may be placed in the cup holders.

2nd row center (if equipped)

Pull the armrest down to use the cup holders.

Seat warmer (if equipped)

The seat warmer is provided to warm the front seats during cold weather.

Front seat



Rear seat



With the ENGINE START/STOP button in the ON position:

- Push the toggle switch up to warm the front seat.
- Press the switch to heat the rear seat as indicated in the above image.

During mild weather or under conditions where the operation of the

seat warmer is not needed, keep the switches in the "OFF" position.

Manual temperature control

Each time you push the toggle switch up (front seat) or press the switch (rear seat), the temperature setting of the seat will change as follows:

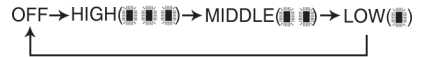

The seat warmer defaults to the OFF position whenever the ENGINE START/STOP button is turned on.

Automatic temperature control

The seat warmer starts to automatically control the seat temperature in order to prevent low-temperature burns after being manually turned on.

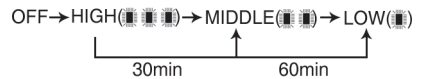

You may manually push the toggle switch up (front seat) or press the switch (rear seat) to increase the seat temperature. However, it soon returns to the automatic mode again. When pushing the toggle switch up (front seat) or pressing the switch (rear seat) for more than 1.5 seconds with the seat warmer operating, the seat warmer will turn OFF. The seat warmer defaults to the OFF position whenever the ENGINE START/STOP button is in the ON position.

* NOTICE

With the seat warmer switch in the ON position, the heating system in the seat turns off or on automatically depending on the seat temperature.

⚠ WARNING

Seat warmer burns

The seat warmer may cause burns, even at low temperature, if used over a long period of time. Never allow passengers who may not be able to take care of themselves to be exposed to the risk of seat heater burns. These include:

1. Infants, children, elderly or disabled persons, or hospital outpatients
2. Persons with sensitive skin or those that burn easily
3. Fatigued individuals
4. Intoxicated individuals
5. Individuals taking medication that can cause drowsiness or sleepiness (sleeping pills, cold tablets, etc.)

Air ventilation seat (if equipped)

Front seat



Rear seat



The temperature setting of the seat changes according to the switch position.

- To ventilate your seat cushion, push the toggle switch down (front seat) or press the switch (rear seat).

Each time you push the toggle switch down (front seat) or press the switch (rear seat), the airflow will change as follows:

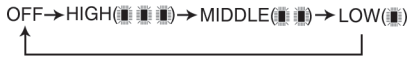

The seat warmer (with air ventilation) defaults to the OFF position whenever the ENGINE START/STOP button is turned on.

⚠ CAUTION

Seat damage

- When cleaning the seats, do not use an organic solvent such as paint thinner, benzene, alcohol and gasoline. Doing so may damage the air ventilation seat.
- Do not place heavy or sharp objects on the seat. Those things may damage the air ventilation seat.
- Be careful not to spill liquid such as water or beverages on the seat. If you spill some liquid, wipe the seat with a dry towel. Before using the air ventilation seat, dry the seat completely.

Sun visor

Use the sun visor to shield direct light through the front or side windows.



- * The actual sun visor lamp in the vehicle may differ from the illustration.
- To use the sun visor, pull it downward.
 - To use the sun visor for the side window, pull it downward, unsnap it from the bracket (1) and swing it to the side (2).
 - To use the vanity mirror, pull down the visor and slide the mirror cover (3).
 - Adjust the sun visor forward or backward (4) as needed. The ticket holder (5) is provided for holding a tollgate ticket.

⚠ CAUTION

Vanity mirror lamp

To prevent unnecessary charging system drain, close the vanity mir-

ror cover securely after using the mirror.

Power outlet

The power outlet is designed to provide power for mobile tele-phones or other devices designed to operate with vehicle electrical systems.

Front



OON048032NR

2nd row



OON048033NR

Rear



OON048034NR

The devices should draw less than 10 amps with the vehicle on.

- Use the power outlet only when the vehicle is on and remove the accessory plug after use. Using the accessory plug for prolonged periods of time with the vehicle off could cause the battery to discharge.
- Only use 12 V electric accessories which are less than 10 A in electric capacity.
- Adjust the air-conditioner or heater to the lowest operating level when using the power outlet.
- Close the cover when not in use.
- Some electronic devices can cause electronic interference when plugged into a vehicle's power outlet. These devices may cause excessive audio static and malfunctions in other electronic systems or devices used in your vehicle.
- Push the plug in as far as it will go. If the plug is not properly

inserted into the outlet, the plug may overheat and the fuse may open.

- For electronic devices equipped with batteries, only plug in the devices with reverse current protection. The current from the battery may flow into the vehicle's electrical/electronic system and cause system malfunction.

⚠ WARNING

Electric shock

Do not put a finger or a foreign object (pen, etc.) into a power outlet and do not touch with a wet hand. You may get an electric shock.

USB charger

The USB car charger allows drivers to charge their digital devices like smartphones, and PC tablets. Plug the cable into the USB port, and charging will begin.

Front



Center (if equipped)



2nd row



3rd row

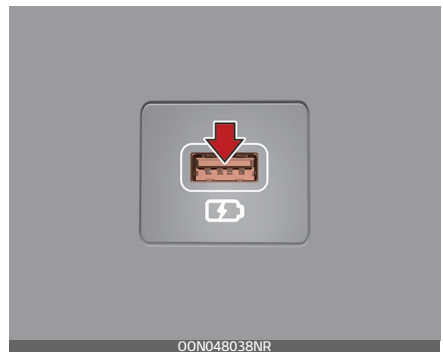

The USB car charger is available with either the ACC or the ignition on. We recommend you connect the

USB port and digital devices with the engine running. See the display screen of the device to check its charging process completion. Your smartphone or tablet PC could get heated up while charging. This is no reason to worry, as it doesn't impact life or functions of the device. There is no function to stop charging by monitoring the battery heat or damage of the device being charged by the USB charger itself. There is however, a function to block itself if the device is being charged when the device requires overcurrent or the USB charger is overheated.

⚠ CAUTION

- Use the USB car charger with the ignition on. Otherwise, vehicle battery can be discharged.
- Use the official USB cable of the manufacturer of the digital device to be charged.
- Make sure that no foreign objects, drinks, and water come into contact with the USB car charger. Water or foreign objects can damage the USB charger.
- Do not charge a device whose current consumption exceeds 2.1 A.
- Do not connect an electrical device that generates excessive electromagnetic noise to the USB car port. If you do so, noise can be heard or vehicle electronic devices

can be interrupted while audio or AV is on.

- If the charger is connected incorrectly, it can cause serious damage on the devices. Please note that damages due to incorrect usage are not covered by warranty service.

AC inverter (if equipped)



The AC inverter supplies 115 V / 150 W electric power to operate electric accessories or equipment.

If you wish to use the AC inverter, open up the AC inverter cover and connect a plug to it. The AC inverter supplies electric power when vehicle is on.

* NOTICE

- Rated voltage: AC 115 V
- Maximum electric power: 150 W

* NOTICE

- Be sure to read this manual before use to avoid any electrical system failure, electric shock, etc.
 - Be sure to close the cover except for when in use.
-
- To prevent the battery from being discharged, do not use the AC inverter while the vehicle is not on.
 - After using an electric accessory or equipment, pull the plug out. Leaving the accessory or equipment plugged in for a long time may cause battery discharge.
 - Do not use an electric accessory or equipment the power consumption of which is greater than 150 W (115 V).
 - The AC inverter is 'turned off' in the low battery voltage condition (11.3V or under), and can be used normally when the voltage is returning to the normal level.
 - While the power consumption of some electrical devices/appliances may be within the AC inverter's electric power range, it may malfunction in the following cases.
 - If the device/appliance requires high electric power for initial start up.
 - If the device/appliance processes precise/very accurate data.

- If the device/appliance requires very stable supply of electricity.

⚠ CAUTION

Electric accessory devices

- Do not use broken electric accessories which may damage the AC inverter and electrical systems of the vehicle.
- Do not use two or more electric accessories at the same time. It may cause damage to the electrical systems of the vehicle.

Wireless smart phone charging system (if equipped)

A wireless smart phone charging system is located in front of the center console.



Firmly close all doors, and turn the vehicle on. To start wireless charging, place the smart phone capable of wireless charging on the wireless charging pad.

For best wireless charging results, place the smart phone on the center of the charging pad.

The wireless charging system is designed for smart phones compatible with Qi technology. Please refer to the smart phone accessory cover or the smart phone manufacturer homepage to check whether your smart phone supports Qi function.

Charging smart phone wirelessly

1. Remove any object on the smart phone charging pad including the smart key. If there is any foreign object on the pad other than a smart phone, the wireless charging function may not operate properly.
2. Place the smart phone on the center of the wireless charging pad.

The indicator light will change to orange once the wireless charging begins. After the charging is complete, the orange light will change to green.

You can choose to turn the wireless charging function on or off by selecting the USM on the instrument cluster. (Please refer to "Instrument cluster" on page 4-71 for details).

If the wireless charging does not work, gently move your smart phone around the pad until the

charging indicator light turns orange.

Depending on the smart phone, the charging indicator light may not turn green even after the charging is complete.

If the wireless charging is not functioning properly, the orange light will blink and flash for ten seconds then turn off. In such cases, remove the smart phone from the pad and replace it on the pad again, or double check the charging status.

If you leave the smart phone on the charging pad when the vehicle is turned off, the vehicle will alert you through warning messages and sound (applicable for vehicles with the voice guidance function) after the 'Goodbye' function on the instrument cluster ends.

For some manufacturers' smart phones, the system may not warn you even though the smart phone is left on the wireless charging unit. This is due to the particular characteristic of the smart phone and not a malfunction of the wireless charging.

⚠ WARNING

Distracted driving

Driving while distracted can result in a loss of vehicle control that may lead to an accident, severe bodily

injury, or death. The driver's primary responsibility is in the safe and legal operation of a vehicle. Any use of handheld devices, other equipment, or vehicle systems that take the driver's eyes, attention, and focus away from the safe operation of a vehicle are not permissible by law. These should never be used during the operation of the vehicle.

⚠ CAUTION

Liquid in Wireless Smart Phone Charger

To prevent liquid from damaging the wireless smart phone charging system in your vehicle, be sure not to spill liquid over the charging system when charging your phone.

⚠ CAUTION

Metal in Wireless Charging system

If any metallic object such as a coin is located between the wireless charging system and the smart phone, the charging may be disrupted. Also, the metallic object may heat up and potentially damage the charging system. If there is any metallic object between the smart phone and the charging pad, immediately remove the smart phone.

Remove the metallic object after it has cooled down.

* NOTICE

- When the interior temperature of the wireless charging system rises above a set temperature, the wireless charging will cease to function. After the interior temperature drops below the threshold, the wireless charging function will resume.
- The wireless charging may not function properly when there is a bulky accessory cover on the smart phone.
- The wireless charging will stop when using the wireless smart key search function to prevent radio wave disruption.
- The wireless charging will stop when the smart key is moved out of the vehicle with the vehicle in ON.
- The wireless charging will stop when any of the doors are opened (applicable for vehicles equipped with smart keys).
- The wireless charging will stop when the vehicle is turned OFF.
- The wireless charging will stop when the smart phone is not in complete contact with the wireless charging pad.
- Items equipped with magnetic components such as credit card, telephone card, bankbook or any

transportation ticket may become damaged during wireless charging.

- Place the smart phone on the center of the charge pad for best results. The smart phone may not charge when placed near the rim of the charging pad. When the smart phone does get charged, it may heat up excessively.
- For smart phones without built-in wireless charging system, an appropriate accessory has to be equipped in order to use the vehicle's wireless charging system.
- Certain smart phones may display messages on a weak current. This is due to the particular characteristics of that smart phone, and does not imply a malfunction of the wireless charging function.
- The indicator light of some manufacturers' smart phones may still be orange after the smart phone is fully charged. This is due to the particular characteristic of the smart phone and not a malfunction of the wireless charging.
- When any smart phone without a wireless charging function or a metallic object is placed on the charging pad, a small noise may sound. This small sound is due to the vehicle discerning compatibility of the object placed on the charging pad. It does not affect your vehicle or the smart phone in any way.

- The wireless smart phone charging system may not support certain smart phones which are not verified for Qi specification .
- When placing your smart phone on the charging pad, position the phone in the middle of the pad for maximum efficiency. If your smart phone is off to the side, the charging speed may slow down, and in some cases, your phone may experience higher heat conduction.
- When charging some smart phones with a self-protection feature, the wireless charging speed may decrease, and the charging may stop.

This device complies with Industry Canada licence-exempt RSS standard(s).

Operation is subject to the following two conditions:

1. This device may not cause interference, and
2. This device must accept any interference, including interference that may cause undesired operation of the device.

Coat hook (if equipped)

A Coat hook is next to the rear grab handle.



* This actual feature may differ from the illustration.

⚠ CAUTION

Hanging clothing

Do not hang heavy clothes, since they may damage the hook.

⚠ WARNING

Do not hang other objects such as hangers or hard objects except clothes. Also, do not put heavy, sharp or breakable objects in the clothing's pockets. In an accident or when the curtain air bag is inflated, it may cause vehicle damage or bodily injury.



Side curtain (if equipped)



To use the side curtain:

1. Lift the curtain by the handle (1).
 2. Hang the curtain on both sides of the hook.
- If the curtain is hung on one side, the curtain may be wrinkled.

⚠ CAUTION

- Do not hang any other object except the side curtain on the hooks.
- If you pull the door curtain or apply force to return the curtain to its original position after use,

you may find the curtain wrinkled or out of shape. To lower the door curtain, be sure to put the handle downward and slowly return the curtain to its original position.

- Curtains may not work properly if foreign objects (coins, toys, cookies, etc.) are stuck in the door. Be careful that the foreign objects do not get into the door.

Floor mat anchor(s) (if equipped)

Type A / Type B

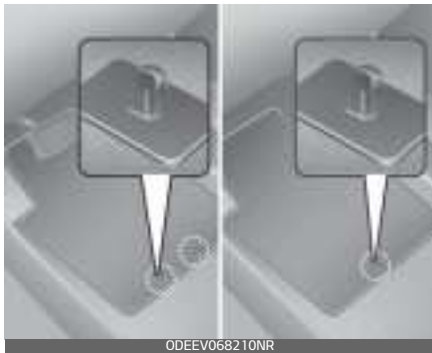

When using a floor mat on the front floor carpet, make sure it attaches to the floor mat anchor(s) in your vehicle. This keeps the floor mat from sliding forward.

⚠ WARNING

Aftermarket floor mat

Do not install aftermarket floor mats that are not capable of being securely attached to the vehicle's floor mat anchors.

Unsecured floor mats can interfere with pedal operation.

The following must be observed when installing ANY floor mat to the vehicle.

- Ensure that the floor mats are securely attached to the vehicle's floor mat anchor(s) before driving the vehicle.
- Do not use ANY floor mat that cannot be firmly attached to the vehicle's floor mat anchors.
- Do not stack floor mats on top of one another (e.g., all-weather rubber mat on top of a carpeted floor mat). Only a single floor mat should be installed in each position.

Luggage net holder

Type A



Type B



To keep items from shifting in the cargo area, you can use the 4 holders located in the cargo area to attach the luggage net.

If necessary, Kia recommends contacting an authorized Kia dealer.

⚠ CAUTION

To prevent damage to the goods or the vehicle, be careful when carrying fragile or bulky objects in the luggage compartment.

⚠ WARNING

DO NOT over-stretch the luggage net and ALWAYS keep your face and body out of the luggage net's recoil path. Failure to comply with these instructions may result in severe facial injuries. DO NOT use when the strap has visible signs of wear or damage.

Exterior features

If the vehicle has a roof rack, you can load cargo on top of your vehicle.

Roof rack (if equipped)



Crossbars and fixing components needed to install the roof rack on your vehicle may be obtained from an authorized Kia dealer.

*** NOTICE**

- The crossbars (if equipped) should be placed in the proper load carrying positions prior to placing items onto the roof rack.
- If the vehicle is equipped with a sunroof, be sure not to position cargo onto the roof rack in such a way that it could interfere with sunroof operation.
- When the roof rack is not being used to carry cargo, the crossbars may need to be repositioned if wind noise is detected.

⚠ CAUTION

Loading Roof Rack

- When carrying cargo on the roof rack, take the necessary precautions to make sure the cargo does not damage the roof of the vehicle.
- When carrying large objects on the roof rack, make sure they do not exceed the overall roof length or width.
- When you are carrying cargo on the roof rack, do not operate the sunroof (if equipped). This can damage the sunroof.

The following specification is the maximum weight that can be loaded onto the roof rack. Distribute the load as evenly as possible across the crossbars (if equipped) and roof rack and secure the load firmly.

ROOF RACK	100 kg (220 lbs.) EVENLY DISTRIBUTED
-----------	---

Loading cargo or luggage in excess of the specified weight limit on the roof rack may damage your vehicle.

⚠ WARNING

- The vehicle center of gravity will be higher when items are loaded onto the roof rack. Avoid sudden starts, braking, sharp turns, abrupt maneuvers or high speeds that may result in loss of vehicle

control or rollover resulting in an accident.

- Always drive slowly and turn corners carefully when carrying items on the roof rack. Severe wind updrafts, caused by passing vehicles or natural causes, can cause sudden upward pressure on items loaded on the roof rack. This is especially true when carrying large, flat items such as wood panels or mattresses. This could cause the items to fall off the roof rack and cause damage to your vehicle or others around you.

To prevent damage or loss of cargo while driving, check frequently before and while driving to make sure the items on the roof rack are securely fastened.

Audio system

* NOTICE

If you install an aftermarket HID head lamp, your vehicle's audio and electronic device may malfunction.

* If your vehicle is equipped with multimedia system, refer to a separately supplied manual for detailed information.

Antenna



The roof antenna transmits and receives wireless signals such as AM/FM, Sirius XM, GNSS, etc.

* The signals which antenna can transmit and receive vary by the vehicle option.

USB port

You can use a USB port to plug in an USB.



How vehicle radio works

FM reception

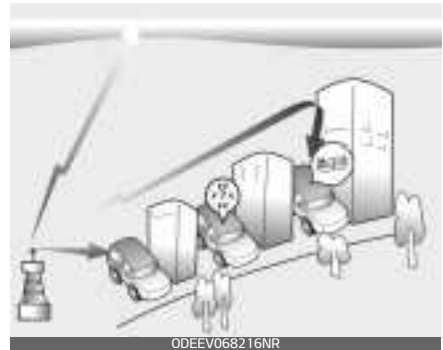

AM and FM radio signals are broadcast from transmitter towers located around your city. They are intercepted by the radio antenna on your vehicle. This signal is then processed by the radio and sent to your vehicle speakers.

In some cases the signal coming to your vehicle may not be strong and clear.

This can be due to factors, such as the distance from the radio station, closeness of other strong radio stations or the presence of buildings, bridges or other large obstructions in the area.

AM reception



AM broadcasts can be received at greater distances than FM broadcasts. This is because AM radio waves are transmitted at low frequencies. These long distance, low frequency radio waves can follow the curvature of the earth rather than traveling straight. In addition, they curve around obstructions resulting in better signal coverage.

FM radio station



FM broadcasts are transmitted at high frequencies and do not bend to follow the earth's surface. Because of this, FM broadcasts generally begin to fade within short distances from the station. Also, FM signals are easily affected by buildings, mountains, and obstructions. This can lead to undesirable or unpleasant listening conditions which might lead you to believe a problem exists with your radio.

The following conditions are normal and do not indicate radio trouble:

- **Fading** – As your vehicle moves away from the radio station, the signal will weaken and sound will begin to fade. When this occurs, we suggest that you select another station with a stronger signal.

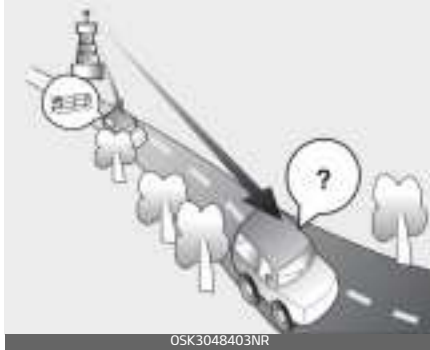

- Flutter/Static - Weak FM signals or large obstructions between the transmitter and your radio can disturb the signal causing static or fluttering noises to occur. Reducing the treble level may lessen this effect until the disturbance clears.
- Station Swapping - As an FM signal weakens, another more powerful signal near the same frequency may begin to play. This is because your radio is designed to lock onto the clearest signal. If this occurs, select another station with a stronger signal.

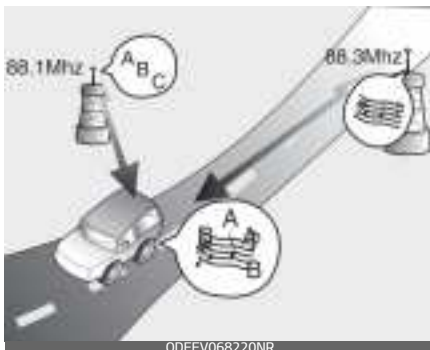

- Multi-Path Cancellation - Radio signals being received from several directions can cause distortion or fluttering. This can be caused by a direct and reflected signal from the same station, or by signals from two stations with close frequencies. If this occurs, select another station until the condition has passed.

Using a cellular phone or a two-way radio

When a cellular phone is used inside the vehicle, noise may be produced from the audio system. This does not mean that something is wrong with the audio equipment. In such a case, try to operate mobile devices as far from the audio equipment as possible.

When using a communication system such as a cellular phone or a radio set inside the vehicle, a separate external antenna must be fitted. When a cellular phone or a radio set is used with only the internal antenna, it may interfere with the vehicle's electrical system and adversely affect the safe operation of the vehicle.

⚠ WARNING**Cell phone use**

Do not use a cellular phone while driving. Stop at a safe location to use a cellular phone.

⚠ WARNING**Distracted driving**

Driving while distracted can result in a loss of vehicle control that may lead to an accident, severe bodily injury, or death. The driver's primary responsibility is in the safe and legal operation of a vehicle. Any use of handheld devices, other equipment, or vehicle systems that take the driver's eyes, attention, and focus away from the safe operation of a vehicle are not permissible by law. These should never be used during the operation of the vehicle

Declaration of Conformity**IC**

This device complies with Industry Canada's licence-exempt RSSs.

Operation is subject to the following two conditions:

1. This device may not cause interference; and
2. This device must accept any interference, including interference that may cause undesired operation of the device.

Le présent appareil est conforme aux CNR d'Industrie Canada applicables aux appareils radio exempts de licence.

L'exploitation est autorisée aux deux conditions suivantes:

1. l'appareil ne doit pas produire de brouillage, et
2. l'utilisateur de l'appareil doit accepter tout brouillage radioélectrique subi, même si le brouillage est susceptible d'en compromettre le fonctionnement.

Be sure the exhaust system does not leak.	5-5
Before driving	5-6
ENGINE START/STOP button	5-8
• Illuminated ENGINE START/STOP button	5-8
• ENGINE START/STOP button position.....	5-8
• Starting the engine	5-10
Automatic transmission	5-12
• Transmission ranges.....	5-13
• Shift lock system.....	5-15
• ENGINE START/STOP button interlock system.....	5-16
• Good driving practices	5-16
All Wheel Drive (AWD) system	5-18
• AWD (AWD/TERRAIN MODE).....	5-19
• For safe All Wheel Drive (AWD) operation.....	5-21
Brake system	5-26
• Power brakes	5-26
• Electronic Parking Brake (EPB)	5-28
• AUTO HOLD.....	5-32
• Anti-lock Brake System (ABS)	5-35
• Electronic Stability Control (ESC) system	5-37
• Vehicle Stability Management (VSM) system	5-40
• Trailer Stability Assist (TSA) system	5-41
• Hill-start Assist Control (HAC)	5-42
• Good braking practices.....	5-42
Idle Stop and Go (ISG) system	5-44
• Auto stop	5-44
• Auto start	5-45
• Operating conditions.....	5-46

5 Driving your vehicle

• Deactivating the ISG.....	5-46
• ISG malfunction.....	5-46
Drive mode integrated control system (AWD).....	5-47
Forward Collision-Avoidance Assist (FCA)	
(Sensor fusion)	5-52
• Detecting sensor	5-52
• Forward Collision-Avoidance Assist Settings	5-53
• Forward Collision-Avoidance Assist Operation	5-55
• Forward Collision-Avoidance Assist Malfunction and Limitations	5-58
Lane Keeping Assist (LKA).....	5-66
• Detecting sensor	5-66
• Lane Keeping Assist Settings	5-66
• Lane Keeping Assist Operation	5-68
• Lane Keeping Assist Malfunction and Limitations.....	5-70
Blind-Spot Collision-Avoidance Assist (BCA).....	5-72
• Detecting sensor	5-73
• Blind-Spot Collision-Avoidance Assist Settings.....	5-74
• Blind-Spot Collision-Avoidance Assist Operation	5-76
• Blind-Spot Collision-Avoidance Assist Malfunction and Limitations.....	5-79
• This device complies with Industry Canada licence-exempt RSS standard(s).	5-83
Driver Attention Warning (DAW)	5-83
• Driver Attention Warning Settings	5-84
• Driver Attention Warning Operation	5-85
• Driver Attention Warning Malfunction and Limitations.....	5-88
Smart Cruise Control (SCC).....	5-91
• Detecting sensor	5-91

- Smart Cruise Control Settings..... 5-91
- To adjust the sensitivity of Smart Cruise Control 5-95
- Warning Volume 5-96
- Smart Cruise Control Operation..... 5-96
- Smart Cruise Control Display and Control..... 5-97
- Smart Cruise Control Malfunction and Limitations5-101
- This device complies with Industry Canada licence-exempt RSS standard(s).5-107
- Navigation-based Smart Cruise Control (NSCC).....5-107**
- Navigation-based Smart Cruise Control Settings..... 5-108
- Navigation-based Smart Cruise Control Operation..... 5-108
- Lane Following Assist (LFA).....5-113**
- Detecting sensor 5-113
- Lane Following Assist Settings..... 5-114
- Lane Following Assist Operation..... 5-114
- Lane Following Assist Malfunction and Limitations5-117
- Highway Driving Assist (HDA).....5-117**
- Detecting sensor 5-118
- Highway Driving Assist Settings..... 5-118
- Operating conditions..... 5-119
- Highway Driving Assist Operation 5-119
- Highway Driving Assist malfunction 5-121
- This device complies with Industry Canada licence-exempt RSS standard(s). 5-123
- Rear Cross-Traffic Collision-Avoidance Assist (RCCA) ...5-124**
- Rear Cross-Traffic Collision-Avoidance Assist Settings 5-125
- Rear Cross-Traffic Collision-Avoidance Assist Operation 5-126

5 Driving your vehicle

- Rear Cross-Traffic Collision-Avoidance Assist Malfunction and Limitations 5-130
- This device complies with Industry Canada licence-exempt RSS standard(s). 5-134
- Declaration of conformity 5-135**
- The radio frequency components (Front radar) complies:..... 5-135
- The radio frequency components (Rear Corner radar) complies :..... 5-139
- Economical operation 5-144**
- Special driving conditions 5-146**
- Winter driving 5-150**
- Trailer towing 5-152**
- Hitches..... 5-153
- Safety chains..... 5-153
- Trailer brakes 5-154
- Driving with a trailer 5-154
- Maintenance when trailer towing..... 5-157
- If you do decide to pull a trailer 5-157
- Vehicle load limit 5-160**
- Tire and loading information label..... 5-160
- Steps for Determining Correct Load Limit - 5-161
- Certification label..... 5-163
- Vehicle weight 5-164**

Driving your vehicle

Be sure the exhaust system does not leak.

The exhaust system should be checked whenever the vehicle is raised to change the oil or for any other purpose.

If you hear a change in the sound of the exhaust or if you drive over something that strikes the underneath side of the vehicle, have the exhaust system checked as soon as possible by an authorized Kia dealer.

WARNING

Engine exhaust

Do not inhale exhaust fumes or leave your engine running in a enclosed area for a prolonged time. Exhaust fumes contain carbon monoxide, a colorless, odorless gas that can cause unconsciousness and death by asphyxiation.

WARNING

Open liftgate

Do not drive with the liftgate open. Poisonous exhaust gases can enter the passenger compartment. If you must drive with the liftgate open proceed as follows:

1. Close all windows.
2. Open side vents.

3. Set the air intake control at "Fresh", the air flow control at "Floor" or "Face" and the fan at the highest speed.
-

Before driving

Before getting into the vehicle, you should examine the car and its surroundings. After getting into the vehicle, you should check a number of things before driving.

Before entering vehicle

- Be sure that all windows, outside mirror(s), and outside lights are clean.
- Check the condition of the tires.
- Check under the vehicle for any sign of leaks.
- Be sure there are no obstacles behind you if you intend to back up.

Necessary inspections

Fluid levels, such as engine oil, engine coolant, brake fluid, and washer fluid should be checked on a regular basis, at the exact interval depending on the fluid. Further details are provided in chapter 7, "Maintenance".

WARNING

Distracted driving

Focus on the road while driving. The driver's primary responsibility is in the safe and legal operation of the vehicle. Any use of handled devices, other equipment or vehicle systems

that distract the driver should not be used during vehicle operation.

Before starting

- Close and lock all doors.
- Position the seat so that all controls are easily reached.
- Buckle your seat belt.
- Adjust the inside and outside rearview mirrors.
- Be sure that all lights work.
- Check all gauges.
- Check the operation of warning lights when the ENGINE START/STOP button is turned to the ON position.
- Release the parking brake and make sure the brake warning light is not on.

For safe operation, be sure you are familiar with your vehicle and its equipment.

WARNING

Fire risk

When you intend to park or stop the vehicle with the engine on, be careful not to depress the accelerator pedal for a long period of time. It may overheat the engine or exhaust system and cause fire.

⚠ WARNING**Check surroundings**

Always check the surrounding areas near your vehicle for people, especially children, before putting a vehicle into D (Drive) or R (Reverse).

etc.) may interfere with your ability to use the brake and accelerator pedals.

⚠ WARNING**Loose objects**

Securely store items in your vehicle. When you make a sudden stop or turn the steering wheel rapidly, loose objects may drop on the floor and it could interfere with the operation of the foot pedals, possibly causing an accident.

⚠ WARNING**Driving while intoxicated**

Do not drive while intoxicated. Drinking and driving is dangerous. Even a small amount of alcohol will affect your reflexes, perceptions and judgment.

Driving while under the influence of drugs is as dangerous as or more dangerous than driving drunk.

⚠ WARNING**Proper footwear**

Always wear appropriate shoes when operating your vehicle. Unsuitable shoes (high heels, ski boots, sandals,

ENGINE START/STOP button

Illuminated ENGINE START/STOP button



The light will go off after about 30 seconds when the door is closed. It will also go off immediately when the theft-alarm system is armed.

ENGINE START/STOP button position

Your vehicle is equipped with four different ignition positions.

OFF

To turn off the engine (START/RUN position) or vehicle power (ON position), press the ENGINE START/STOP button with the shift lever in the P (Park) position. When you press the ENGINE START/STOP button without the shift lever in the P (Park) position, the ENGINE START/STOP button will not change to the OFF position but to the ACC position.

* NOTICE

You are able to turn off the engine (START/RUN) or vehicle power (ON), only when the vehicle is not in motion.

⚠ CAUTION

In an emergency situation while the vehicle is in motion, you are able to turn the engine off and to the ACC position by pressing the ENGINE START/STOP button for more than 2 seconds or 3 times repeatedly within 3 seconds.

If the vehicle is still moving, to restart the vehicle:

- Press the ENGINE START/STOP button when vehicle speed is 5 km/h (3 mph) or over.

ACC (Accessory)

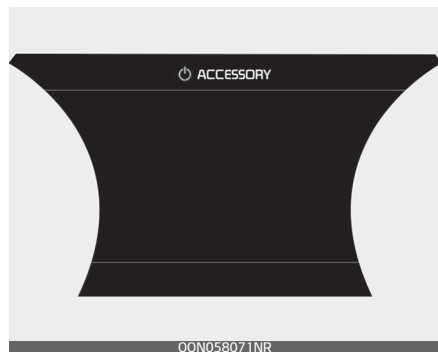

Press the ENGINE START/STOP button while it is in the OFF position without engaging the brake pedal.

Some electrical accessories are operational.

If the ENGINE START/STOP button is in the ACC position for more than 1 hour, the button is turned off automatically to prevent battery discharge.

ON

Press the ENGINE START/STOP button while it is in the ACC position without depressing the brake pedal.

The warning lights can be checked before the engine is started. Do not leave the ENGINE START/STOP button in the ON position for a long time. The battery may discharge, because the engine is not running.

START/RUN

To start the engine, press the brake pedal and push the ENGINE START/STOP button with the shift lever in the P (Park) or the N (Neutral) position. For your safety, start the engine with the shift lever in the P (Park) position.

*** NOTICE**

If you press the ENGINE START/STOP button without pressing the brake pedal, the engine will not start and the ENGINE START/STOP button changes as follow:

OFF → ACC → ON → OFF or ACC

⚠ WARNING

- Never press the ENGINE START/STOP button while the vehicle is in motion. This would result in loss of directional control and braking function, which could cause an accident.
 - Before leaving the driver's seat, always make sure the shift lever is engaged in P (Park), set the parking brake fully and shut the engine off. Unexpected and sudden vehicle movement may occur if these precautions are not taken.
 - Never reach for the ENGINE START/STOP button or any other controls through the steering wheel while the vehicle is in motion. The presence of your hand or arm in the area could cause loss of vehicle control, an accident and serious bodily injury or death.
 - Do not place any movable objects around the driver's seat as they may move while driving, interfere with the driver and lead to an accident.
-

Starting the engine

WARNING

- Do not start the vehicle with the accelerator pedal engaged. The vehicle can move and lead to an accident.
- Wait until the engine rpm is normal. The vehicle may suddenly move if the brake pedal is released when the rpm is high.

Starting the engine

1. Make sure the smart key is located inside the vehicle and close the driver seat. The vehicle may not start if it is not located near the driver seat.
2. Make sure the parking brake is applied.
3. Make sure the shift lever is in P (Park).
 - Press the brake pedal fully. You can also start the engine when the shift lever is in the N (Neutral) position.
4. Press the ENGINE START/STOP button. Make sure that the accelerator pedal is not pressed.
5. Do not wait for the engine to warm up while the vehicle remains stationary. Start driving at moderate engine speeds. (Steep accelerating and decelerating should be avoided.)

Starting the engine with smart key

At the time that the vehicle doors are opened or when the ENGINE START/STOP button is pressed the vehicle will check for the smart key.

If the smart key is not in the vehicle, the "" indicator and a message "Key is not in the vehicle" will appear on the instrument cluster and LCD window. And if all doors are closed, the chime will sound for 5 seconds. The indicator or warning will turn off while the vehicle is moving. Always have the smart key with you.

WARNING

The engine will start, only when the smart key is in the vehicle. Never allow children or any person who is unfamiliar with the vehicle touch the ENGINE START/STOP button or related parts. Pushing the ENGINE START/STOP button while the smart key is in the vehicle may result in unintended engine activation and/or unintended vehicle movement.

CAUTION

If the engine stalls while the vehicle is in motion, do not attempt to move the shift lever to the P (Park) position. If the traffic and road conditions permit, you may put the shift lever in the N (Neutral) position

while the vehicle is still moving and press the ENGINE START/STOP button in an attempt to restart the engine.



But for your safety always press the brake pedal before starting the engine.

⚠ CAUTION

Do not press the ENGINE START/STOP button for more than 10 seconds except when the stop lamp fuse is blown.

* NOTICE

- If the battery is weak or the smart key does not work correctly, you can start the engine by pressing the ENGINE START/STOP button with the smart key. When you press the ENGINE START/STOP button directly with the smart key, the smart key should contact the button at a right angle.
- When the stop lamp fuse is blown, you cannot start the engine normally. Replace the fuse with a new one. If it is not possible, you can start the engine by pressing the ENGINE START/STOP button for 10 seconds while it is in the ACC position. The engine can start without pressing the brake pedal.

Automatic transmission

The automatic transmission has 8 forward speeds and one reverse speed.

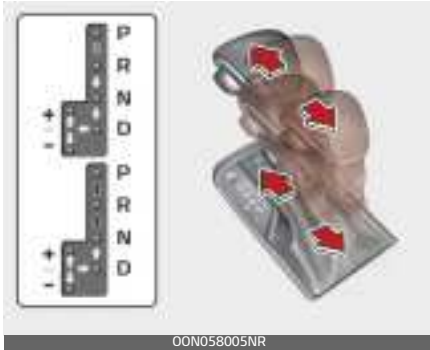

➡ Press the brake pedal and the lock release button when shifting.

➡ Press the lock release button when shifting.

⇨ The shift lever can be shifted freely.

The individual speeds are selected automatically, depending on the position of the shift lever.

* NOTICE

The first few shifts on a new vehicle, if the battery has been disconnected, may be somewhat abrupt. This is a normal condition, and the shifting sequence will adjust after shifts are cycled a few times by the TCM (Transmission Control Module) or PCM (Powertrain Control Module).

For smooth operation, press the brake pedal when shifting from N (Neutral) to a forward or reverse gear.

⚠ WARNING

Automatic transmission

- Always check the surrounding areas near your vehicle for people, especially children, before shifting a vehicle into D (Drive) or R (Reverse).
- Before leaving the driver's seat, always make sure the shift lever is in the P (Park) position; then set the parking brake fully and shut the engine off. Unexpected and sudden vehicle movement can occur if these precautions are not followed in the order identified.
- Do not use the engine brake (shifting from a high gear to lower gear) rapidly on slippery roads. The vehicle may slip causing an accident.

⚠ CAUTION

- To avoid damage to your transmission, do not accelerate the engine in R (Reverse) or any forward gear position with the brakes on.
- When stopped on an incline, do not hold the vehicle stationary with engine power. Use the service brake or the parking brake.

- Do not shift from N (Neutral) or P (Park) into D (Drive), or R (Reverse) when the engine is above idle speed.
-

Transmission ranges

The indicator in the instrument cluster displays the shift lever position when the ENGINE START/STOP button is in the ON position.

P (Park)

Always come to a complete stop before shifting into P (Park). This position locks the transmission and prevents the front wheels from rotating.

⚠ WARNING

- Shifting into P (Park) while the vehicle is in motion will cause the drive wheels to lock which will cause you to lose control of the vehicle and possibly damage the transmission.
 - Do not use the P (Park) position in place of the parking brake. Always make sure the shift lever is latched in the P (Park) position and set the parking brake fully.
 - Never leave a child unattended in a vehicle.
-

⚠ CAUTION

The transmission may be damaged if you shift into P (Park) while the vehicle is in motion.

R (Reverse)

Use this position to drive the vehicle backward.

⚠ CAUTION

Always come to a complete stop before shifting into or out of R (Reverse); you may damage the transmission if you shift into R while the vehicle is in motion, except as explained in "Rocking the vehicle" in this section.

N (Neutral)

When in Neutral, wheels and transmission are not engaged. The vehicle will roll freely even on the slightest incline unless the parking brake or service brakes are applied.

⚠ WARNING

Do not drive with the shift lever in N (Neutral). The engine brake will not work and could lead to an accident.

▲ CAUTION

Always park the vehicle in "P" (Park) for safety and engage the parking brake.

D (Drive)

This is the normal forward driving position. The transmission will automatically shift through a 8-gear sequence, providing the best fuel economy and power.

*** NOTICE**

Always come to a complete stop before shifting into D (Drive).

Manual mode

Whether the vehicle is stationary or in motion, Manual mode is selected by pushing the shift lever from the D (Drive) position into the manual gate. To return to D (Drive) range operation, push the shift lever back into the main gate.



OON058006NR

In Manual mode, moving the shift lever backwards or forwards will allow you to make gearshifts rapidly. In contrast to a manual transmission, the Manual mode allows gearshifts with the accelerator pedal depressed.

- Up (+): Push the lever forward once to shift up one gear.
- Down (-): Pull the lever backwards once to shift down one gear.

*** NOTICE**

- In Manual mode, the driver must execute upshifts in accordance with road conditions, being careful to keep the engine speed below the red zone.
- In Manual mode, only the 8 forward gears can be selected. To reverse or park the vehicle, move the shift lever to the R (Reverse) or P (Park) position as required.
- In Manual mode, downshifts are made automatically when the vehicle slows down. When the vehicle stops, 1st gear is automatically selected.
- In Manual mode, when the engine rpm approaches the red zone, shift points are varied to upshift automatically.
- To maintain the required levels of vehicle performance and safety, the system may not execute certain gearshifts when the shift lever is operated.

- When driving on a slippery road, push the shift lever forward into the + (up) position. This causes the transmission to shift into the 2nd gear which is better for smooth driving on a slippery road. Push the shift lever to the - (down) side to shift back to the 1st gear.
 - When Manual mode is activated:
 - The engine rpm will tend to remain raised over a certain length of time even after releasing the accelerator.
 - Upshifts are delayed when accelerating.
 - In Manual mode, the fuel efficiency may decrease.
-

Shift lock system

For your safety, the Automatic transmission has a shift lock system which prevents shifting the transmission from P (Park) into R (Reverse) unless the brake pedal is engaged.

Shifting the transmission from P (Park) into R (Reverse)

To shift the transmission from P (Park) into R (Reverse):

1. Press and hold the brake pedal.
2. Start the engine or place the ENGINE START/STOP button in the ON position.
3. Move the shift lever.

If the brake pedal is repeatedly engaged and released with the shift lever in the P (Park) position, a chattering noise near the shift lever may be heard. This is a normal condition.

WARNING

Always fully depress the brake pedal before and while shifting out of the P (Park) position into another position to avoid inadvertent motion of the vehicle which could injure persons in or around the vehicle.

Overriding the shift lock



If the shift lever cannot be moved from the P (Park) position into R (Reverse) position with the brake pedal engaged, continue engaging the brake, then do the following:

1. Place the ENGINE START/STOP button in the OFF position.
2. Apply the parking brake.
3. Carefully remove the cap covering the shift-lock release access hole.
4. Insert a tool (e.g., flathead screwdriver) into the access hole and press down on the tool.
5. Move the shift lever.
6. Remove the tool from the shift-lock override access hole then install the cap.

If the shift lever does not move even after performing this procedure, have your vehicle inspected by an authorized Kia dealer immediately.

ENGINE START/STOP button interlock system

The ENGINE START/STOP button will not change to the OFF position unless the shift lever is in the P (Park) position.

Good driving practices

- Never move the shift lever from P (Park) or N (Neutral) to any other position with the accelerator pedal engaged.
- Never move the shift lever into P (Park) when the vehicle is in motion.
- Be sure the vehicle is completely stopped before you attempt to shift into R (Reverse) or D (Drive).
- Never take the vehicle out of gear and coast down a hill. This may be extremely hazardous. Always leave the vehicle in gear when moving.
- Do not "ride" the brakes. This can cause them to overheat and malfunction. Instead, when you are driving down a long hill, slow down and shift to a lower gear. When you do this, engine braking will help slow down the vehicle.
- Slow down before shifting to a lower gear. Otherwise, the lower gear may not be engaged.
- Always use the parking brake. Do not depend on placing the transmission in P (Park) to keep the vehicle from moving.

⚠ WARNING

Exercise extreme caution when driving on a slippery surface. Be especially careful when braking, accelerating or shifting gears. On a slippery surface, an abrupt change in vehicle speed can cause the drive wheels to lose traction and the vehicle to go out of control.

- Optimum vehicle performance and economy is obtained by smoothly pressing and releasing the accelerator pedal.

⚠ WARNING

- Always buckle-up! In a collision, an unbelted occupant is significantly more likely to be seriously injured or killed than a properly belted occupant.
- Avoid high speeds when cornering or turning.
- Do not make quick steering wheel movements, such as sharp lane changes or fast, sharp turns.
- The risk of a rollover is greatly increased if you lose control of your vehicle at highway speeds.
- Losing control often occurs if two or more wheels drop off the roadway and the driver oversteers to reenter the roadway.
- In the event your vehicle leaves the roadway, do not steer sharply. Instead, slow down

before pulling back into the travel lanes.

- Never exceed posted speed limits.

⚠ WARNING

If your vehicle becomes stuck in snow, mud, sand, etc., then you may attempt to rock the vehicle free by moving it forward and backward. Do not attempt this procedure if people or objects are anywhere near the vehicle. During the rocking operation the vehicle may suddenly move forward or backward as it becomes unstuck, causing injury or damage to nearby people or objects.

Moving up a steep grade from a standing start

To move up a steep grade from a standing start:

1. Press the brake pedal, release the parking brake, and shift the shift lever to D (Drive).
2. Select the appropriate gear depending on load weight and steepness of the grade, and release the parking brake.
3. Press the accelerator gradually while releasing the service brakes.

When accelerating from a stop on a steep hill, the vehicle may have a tendency to roll backwards.

⚠ WARNING

When you start driving after the car was stopped on a hill, even though the shift lever is in D (Driving) position, if you do not step on the accelerator pedal or brake pedal, the car may roll backward, resulting in a fatal accident.

Always come to a complete stop before shifting into D (Drive).



All Wheel Drive (AWD) system (if equipped)

The All Wheel Drive (AWD) system delivers engine power to front and rear wheels for maximum traction.

AWD is useful when extra traction is required, such as when driving slippery, muddy, wet, or snow-covered roads.

If the system determines there is a need for four wheel drive, the engine's driving power will be distributed to all four wheels automatically.

⚠ WARNING

If the AWD warning light () stays on the instrument cluster, your vehicle may have a malfunction with the AWD system. When the AWD warning light () illuminates, have your vehicle checked by an authorized Kia dealer as soon as possible.

⚠ WARNING

To reduce the risk of **SERIOUS INJURY** or **DEATH**:

- Do not drive in conditions that exceed the vehicle's intended design such as challenging off-road conditions.
- Avoid high speeds when cornering or turning.

- Do not make quick steering wheel movements, such as sharp lane changes or fast, sharp turns.
- The risk of a rollover is greatly increased if you lose control of your vehicle at highway speeds.
- Loss of control often occurs if two or more wheels drop off the roadway and the driver over steers to reenter the roadway.
- In the event your vehicle leaves the roadway, do not steer sharply. Instead, slow down before pulling back into the travel lanes.

AWD (AWD/TERRAIN MODE)

AWD helps the vehicle to maintain its best driving performance by controlling 4 wheels, engine, transmission and braking according to road conditions such as snow, mud, sand, etc.

Advantages of AWD

- Enhance safety when driving straight.
- Improve performance when cornering.
- Ensure operability in tough driving conditions such as snow, rain, sand, etc..

Switching from/to TERRAIN MODE





You can switch from DRIVE MODE to TERRAIN mode by pressing DRIVE/TERRAIN mode button and then select SNOW, MUD, or SAND mode by turning TERRAIN MODE knob. If you press the DRIVE/TERRAIN mode button again, the vehicle will go back to DRIVE MODE.

*** NOTICE**

Even though you turned off the vehicle in TERRAIN mode, DRIVE mode will be set when you restart the vehicle.

AWD transfer mode selection

Transfer mode	Selection mode	Description
COMFORT	-	<ul style="list-style-type: none"> COMFORT is used when driving on roads in normal conditions, roads in urban areas, and on highways. All wheels are in operation when a vehicle travels at a constant speed. Required tractions applying on front and rear wheels vary depending on road driving conditions and driving conditions, which will be automatically controlled by the computing system. When the cluster's COMFORT display mode is selected, the cluster displays the status of how four wheels' traction forces are distributed.
SNOW	 SNOW	SNOW mode is used to appropriately distribute the vehicle's traction forces and prevent wheel slippage when driving on snowy or slippery road.
MUD	 MUD	MUD mode is used to ensure safe driving by appropriately distributing the vehicle's traction forces when driving on muddy, unpaved or rough roads.
SAND	 SAND	SAND mode is used to ensure safe driving by appropriately distributing the vehicle's traction forces when driving on sandy, graveled or unpaved off-roads.

* SNOW ↔ MUD ↔ SAND

CAUTION

Maintain COMFORT (AWD Auto) mode when driving on roads in normal conditions. Driving in TERRAIN mode on normal roads may damage the AWD system and cause mechanical vibration or noise.

When driving (especially when cornering) under normal road conditions in TERRAIN mode, a driver may find minor mechanical vibration or noise, which is extremely normal phenomenon, not a malfunction.

When TERRAIN mode is released, such noise or vibration will be immediately gone. When you turn off TERRAIN mode, it can lead to little shocks but this is a normal phenomenon that lasts until the traction forces on the front and rear wheels of the vehicle are released.

For safe All Wheel Drive (AWD) operation

⚠ WARNING

All Wheel Drive

The conditions of on-road or off-road that demand All Wheel Drive mean all functions of your vehicle are exposed to extreme stress than under normal road conditions. Slow down and be ready for changes in the composition and traction of the surface under your tires. If you have any doubt about the safety of the conditions you are facing, stop and consider the best way to proceed.

- Do not try to drive in deep standing water or mud since such conditions can stall your engine and clog your exhaust pipes. Do not drive down steep hills since it requires extreme skill to maintain control of the vehicle.

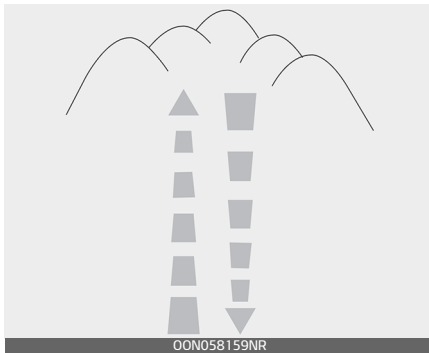

- When you are driving up or down hills drive as straight as possible. Use extreme caution in going up

or down steep hills, since you may flip your vehicle over depending on the grade, terrain and water/mud conditions.



⚠ WARNING

Hills

Driving across the contour of steep hills can be extremely dangerous. This danger can come from slight changes in the wheel angle which can destabilize the vehicle or, even if the vehicle is maintaining stability under power, it can lose that stability if the vehicle stops its forward motion. Your vehicle may roll over without warning and without time for you to correct a mistake that could cause serious injury or death.

- You must learn how to corner in a AWD vehicle. Do not rely on your experience in conventional FWD vehicles when cornering the vehicle in AWD mode. For starters, you must drive slower in AWD.

⚠ WARNING**All Wheel Drive (AWD)**

Reduce speed when you turn corners. The center of gravity of AWD vehicles is higher than that of conventional FWD vehicles, making them more likely to roll over when you turn corners too fast.



00N051009L

⚠ WARNING**Steering wheel**

Do not grab the inside of the steering wheel when you are driving on unpaved roads. You may hurt your arm by a sudden steering maneuver or from steering wheel rebound due to impact with objects on the ground. You could lose control of the steering wheel.

- Always hold the steering wheel firmly when you are driving on unpaved roads.
- Make sure all passengers are wearing seat belts.

⚠ WARNING**Wind danger**

If you are driving in heavy wind, the vehicle's higher center of gravity decreases your steering control capacity and requires you to drive more slowly.

⚠ WARNING**Driving through water**

Drive slowly. If you are driving too fast in water, the water can get into the engine compartment and wet the ignition system, causing your vehicle to suddenly stop. If this happens and your vehicle is in a tilted position, your vehicle may roll over.

*** NOTICE**

- Do not drive in water if the level is higher than the bottom of the vehicle.
- Check your brake condition once you are out of mud or water. Press the brake pedal several times as you move slowly until you feel normal braking forces return.
- Shorten your scheduled maintenance interval if you drive in offroad conditions such as sand, mud or water (refer to "Maintenance Under Severe Usage Conditions – Non Turbo Models" on

page 7–13). Always wash your vehicle thoroughly after off-road use, especially cleaning the bottom of the vehicle.

- Since the driving torque is always applied to the 4 wheels the performance of the AWD vehicle is greatly affected by the condition of the tires. Be sure to equip the vehicle with four tires of the same size and type.
- A full time All Wheel Drive vehicle cannot be towed by an ordinary tow truck. Make sure that the vehicle is placed on a flat bed truck for moving.

⚠ WARNING

All Wheel Drive (AWD) driving

- Avoid high cornering speed.
- Do not make quick steering wheel movements, such as sharp lane changes or fast, sharp turns.
- The risk of rollover is greatly increased if you lose control of your vehicle at high speed.
- In a collision, an unbelted person is significantly more likely to die compared to a person wearing a seat belt.
- Loss of control often occurs if two or more wheels drop off the roadway and the driver over-steers to re-enter the roadway. In the event your vehicle leaves the roadway, do not steer sharply.

Instead, slow down before pulling back into the travel lanes.

⚠ CAUTION

Mud or snow

If one of the front or rear wheels begins to spin in mud, snow, etc. the vehicle can sometimes be driven out by engaging the accelerator pedal further; however avoid running the engine continuously at high rpm because doing so could damage the AWD system.

Driving in sand or mud

- Maintain slow and constant speed. Operate the accelerator pedal slowly to ensure safe driving (wheel-slip prevention).
- Keep sufficient distance between your vehicle and the vehicle in front of you.
- Reduce vehicle speed and always check the road condition.
- Avoid speeding, rapid acceleration, sudden brake applications, and sharp turns to prevent getting stuck.
- When the vehicle is stuck in snow, sand or mud, the tires may not operate.
- This is to protect the transmission and not a malfunction.

*** NOTICE**

Moving the car forcibly to get out of mud or sand can cause damage/overheat of the engine or damage/breakdown of the transaxle, differential or 4WD system as well as damage to tires. If excessive wheel slip occurs after entering a sandy/muddy road, the vehicle may fall into the sand/mud. When it happens, put a stone or a tree branch under the tire, and then try to pull out the car, or try to get it unstuck by repeatedly moving forwards and backwards.

Transmission overheated

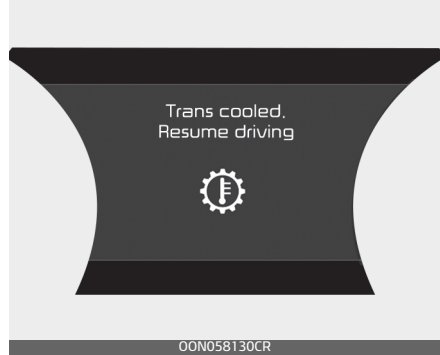

- When driving on muddy and sandy roads under the severe condition, the transmission could be overheated.
- When the transmission is overheated, the safe protection mode engages and the "Transmission Hot! Park with engine on" warning message will appear on the LCD display with a chime.
- If this occurs, pull over to a safe location, stop the vehicle with the engine running, apply the brakes and shift the vehicle to P (Park), and allow the transmission to cool.
- If you ignore this warning, the driving condition may become worse. You may experience abrupt shifts, frequent shifts, or jerkiness. To return to the normal driving condition, stop the vehicle and apply the foot brake or shift into P (Park). Then allow the transmission to cool for a few minutes with engine on, before driving off.

- When the message "Trans cooled. Resume driving" appears you can continue to drive your vehicle.

If the warning messages in the LCD display continue to blink, for your safety, have the system checked by an authorized Kia dealer.

⚠ WARNING

Your vehicle is equipped with tires designed to provide safe ride and handling capability. Do not use tires and wheels that are different in size and type from the originally installed ones. It can affect the safety and performance of your vehicle, which could lead to steering failure or rollover and serious injury. When replacing the tires, be sure to equip all four tires with the tire and wheel of the same size, type, tread, brand and load-carrying capacity.

⚠ WARNING

Jacked vehicle

While the full-time AWD vehicle is being raised on a jack, never start the engine or cause the tires to rotate.

There is the danger that rotating tires touching the ground could cause the vehicle to go off the jack and to jump forward.

- Full-time AWD vehicles must be tested on a special four wheel chassis dynamometer.

*** NOTICE**

Never engage the parking brake while performing these tests.

⚠ WARNING

Dynamometer testing

Keep away from the front of the vehicle while the vehicle is in gear on the dynamometer. This is very dangerous as the vehicle can jump forward and cause serious injury or death.

⚠ CAUTION

- When lifting up the vehicle, do not operate front and rear wheel separately. All four wheels should be operated.
- If you need to operate the front wheel and rear wheel when lifting up the vehicle, you should release the parking brake.

Brake system

Your vehicle has power-assisted brakes, parking brake, and various braking systems for safe driving.

Power brakes

Your vehicle has power-assisted brakes that adjust automatically through normal usage.

In the event that the power-assisted brakes lose power because of a stalled engine or some other reason, you can still stop your vehicle by applying greater force to the brake pedal than you normally would. The stopping distance, however, will be longer.

When the engine is not running, the reserve brake power is partially depleted each time the brake pedal is applied. Do not pump the brake pedal when the power assist has been interrupted.

Pump the brake pedal only when necessary to maintain steering control on slippery surfaces.

* NOTICE

- When stepping on the brake pedal under a certain driving or weather condition you may witness your car make a sound of squealing or some other noises. This is not a brake malfunction but a normal phenomenon.

- When driving on the road to which deicing chemicals are applied, the vehicle may witness noises from the brake or abnormal abrasion of tires because of such deicing chemicals. You should operate brake additionally so that you would be able to remove the deicing chemicals on the brake disk and pad under a safe traffic condition.

⚠ CAUTION

Brake Pedal

Do not drive with your foot resting on the brake pedal. This will create abnormally high brake temperatures which can cause excessive brake lining and pad wear.

⚠ WARNING

Steep hill braking

Avoid continuous application of the brakes when descending a long or steep hill by shifting to a lower gear. Continuous brake application will cause the brakes to overheat and could result in a temporary loss of braking performance.

Wet brakes may impair the vehicle's ability to safely slow down; the vehicle may also pull to one side when the brakes are applied. Applying the brakes lightly will indicate

whether they have been affected in this way. Always test your brakes in this fashion after driving through deep water. To dry the brakes, apply them lightly while maintaining a safe forward speed until brake performance returns to normal.

In the event of brake failure

If service brakes fail to operate while the vehicle is in motion, you can make an emergency stop with the parking brake. The stopping distance, however, will be much greater than normal.

⚠ WARNING

Parking brake

Avoid applying the parking brake to stop the vehicle while it is moving except in an emergency situation. Applying the parking brake while the vehicle is moving at normal speeds can cause a sudden loss of control of the vehicle. If you must use the parking brake to stop the vehicle, use great caution in applying the brake.

Brake Over Accelerator

In the event the accelerator pedal becomes stuck or entrapped, apply steady and firm pressure to the brake pedal to slow the vehicle and reduce engine power.

If you experience this condition, take the following steps:

1. Apply the brakes and bring your vehicle to a safe stop.
2. Move the transmission to P (Park), switch the engine off and apply the parking brake.
3. Inspect the accelerator pedal for any interference.

If none are found and the condition persists, have your vehicle towed to an authorized Kia dealer and inspected.

Disc brakes wear indicator

When your brake pads are worn and new pads are required, you will hear a high-pitched warning sound from your front brakes or rear brakes. You may hear this sound come and go or it may occur whenever you press the brake pedal.

⚠ CAUTION

Replace brake pads

Do not continue to drive with worn brake pads. Continuing to drive with worn brake pads can damage the braking system and result in costly brake repairs.

⚠ WARNING

Brake wear

Do not ignore high pitched wear sounds from your brakes. If you

ignore this audible warning, you will eventually lose braking performance, which could lead to a serious accident.

* NOTICE

Brake dust may accumulate on the wheels, even under normal driving conditions. Some dust is inevitable as the brakes wear and does contribute to brake noise.



Check the brake warning light by turning the ENGINE START/STOP button ON (do not start the engine). This light will be illuminated when the parking brake is applied with the ENGINE START/STOP button in the START or ON position.

Before driving, be sure the parking brake is fully released and the brake warning light is off.

If the brake warning light remains on after the parking brake is released while engine is running, there may be a malfunction in the brake system. Immediate attention is necessary.

If at all possible, cease driving the vehicle immediately. If that is not possible, use extreme caution while

operating the vehicle and only continue to drive the vehicle until you can reach a safe location or repair shop.

Electronic Parking Brake (EPB)

Applying the parking brake



To apply the EPB (electronic parking brake) manually:

1. Stop the vehicle.
2. Depress the brake pedal and pull up the EPB switch. Make sure the warning light comes on.

EPB may be automatically applied when:

- Requested by other systems.
- If the driver applies the EPB while the engine is ON then turn the engine off, the EPB may be applied again automatically.



- If the driver turns the engine off by mistake while Auto Hold is operating, EPB will be automatically applied. But if the driver turns the engine off and push the EPB switch in 1 second, the EPB does not apply.

Emergency Braking

- If there is a problem with the brake pedal while driving, emergency braking is possible by pulling up and holding the EPB switch. Braking is possible only while you are holding the EPB switch. If you hand off the EPB switch, the braking force is lost. If you hold the EPB switch and the vehicle stop, the EPB is applied.
- During emergency braking by the EPB, the parking brake warning light will illuminate and the warning sounds will occur to indicate that the system is operating.

- The braking distance may be longer than under normal braking conditions.

* EPB stands for Electronic Parking Brake.

⚠ WARNING

Do not operate the parking brake while the vehicle is moving except in an emergency situation. It could damage the vehicle system and endanger driving safety.

⚠ CAUTION

If you continuously notice a noise or burning smell when the EPB is used for emergency braking, have the system checked by an authorized Kia dealer.

Releasing the parking brake

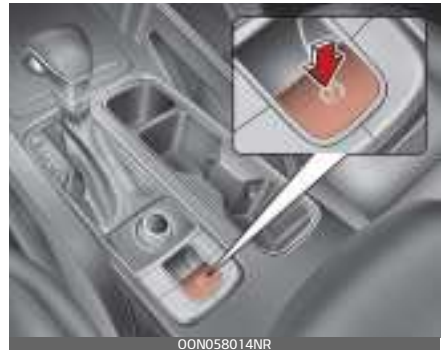

To release the EPB manually:

Press the EPB switch in the following condition.

- Have the ENGINE START/STOP button in the ON position.
- Depress the brake pedal.
- The shift lever must be in P (Park).
- Make sure the brake warning light goes off.

To release EPB automatically (automatic transmission):

1. Close the driver's door, engine hood and liftgate.
2. Fasten the driver's seat belt.
3. Start the engine.
4. If the shift lever is in P (Park), depress the brake pedal and shift out of P (Park) to R (Rear) or D (Drive), the EPB is released automatically. Make sure the brake warning light goes off.
5. If the shift lever is in N (Neutral), depress the brake pedal and shift out of N (Neutral) to R (Rear) or D (Drive), the EPB is released automatically. Make sure the brake warning light goes off.
 - If you try to drive off depressing the accelerator pedal with the EPB applied, but doesn't release automatically, a warning will sound once and a message will appear.



- If the driver's seat belt is not fastened, driver's door is opened, the engine hood is opened in D or the liftgate is opened in R, a warning will sound once and a message will appear.
- If there is a problem with the vehicle, a warning may sound once and a message may appear. If the above situation occurs, depress the brake pedal and release EPB by pressing the EPB switch.

⚠ WARNING

- Never allow anyone who is unfamiliar with the vehicle to touch the parking brake. If the parking brake is released unintentionally, serious injury may occur.
- Do not place any objects around the EPB switch. They could release the EPB switch.

⚠ CAUTION

- To prevent unintentional movement when stopped and leaving the vehicle, do not use the shift lever in place of the parking brake. Set the parking brake and make sure the shift lever is securely positioned in P (Park). Use wheel chocks if necessary.
- In winter or cold conditions, the EPB may freeze. Park the vehicle with the shift lever in P on the even and safe place without applying the EPB. And use wheel chocks.
- Do not drive your vehicle with the EPB applied. It may cause excessive wear of brake pad and brake rotor.
- A click sound may be heard while operating or releasing the EPB, but these conditions are normal and indicate that the EPB is functioning properly.
- When leaving your keys with a parking lot attendant or valet, make sure to inform him/her how to operate the EPB.
- When the battery is drained, the EPB does not apply or release. In this case, jump start your vehicle.

Malfunction of EPB



If the EPB malfunction indicator remains on, it indicates that the EPB may have malfunctioned. If this occurs, have the system checked by an authorized Kia dealer.

The EPB malfunction indicator may illuminate when the ESC indicator comes on to indicate that the ESC is not working properly, but it does not indicate a malfunction of the EPB.

⚠ CAUTION

- The EPB warning light may illuminate if the EPB switch operates abnormally. Shut the engine off and turn it on again after a few minutes. The warning light will go off and the EPB switch will operate normally. However, if the EPB warning light is still on, have the system checked by an authorized Kia dealer.
- If the parking brake warning light does not illuminate or blinks even

though the EPB switch was pulled up, the EPB is not applied. If the parking brake warning light blinks when the EPB warning light is on, press the switch, then pull it up. Once more press it back to its original position and pull it back up. If the EPB warning does not go off, have the system checked by an authorized Kia dealer.

AUTO HOLD

The Auto Hold is designed to maintain the vehicle in a standstill even though the brake pedal is not pressed after the driver brings the vehicle to a complete stop by pressing the brake pedal.

Applying Auto Hold function

1. Press the brake pedal and start the vehicle.
2. Press the Auto Hold button. The white AUTO HOLD indicator will come on indicating the system is in standby.



Before the Auto Hold will engage, the driver's door and engine hood must be closed and the liftgate must be closed.

When coming to a complete stop by pressing the brake pedal, the AUTO HOLD indicator changes from white to green indicating the AUTO HOLD is engaged. The vehicle will remain at a standstill even if you release the brake pedal.



If EPB is applied, Auto Hold will be released.

If you press the accelerator pedal with the shift lever in D (Drive) or Manual mode, the Auto Hold will be released automatically and the vehicle will start to move. The indicator changes from green to white indicating the Auto Hold is in standby and the EPB is released.

When driving off from Auto Hold by pressing the accelerator pedal, always check the surrounding area near your vehicle.

Slowly press the accelerator pedal for a smooth launch.

Canceling Auto Hold function



- To cancel the Auto Hold operation, press the Auto Hold button. The AUTO HOLD indicator will go out.
- To cancel the Auto Hold operation when the vehicle is at a standstill, press the Auto Hold button while pressing the brake pedal.

*** NOTICE**

- The following are conditions when the Auto Hold will not engage (Auto Hold light will not turn green and the Auto Hold system remains in stand by):
 - The driver's door is opened
 - The engine hood or liftgate is opened
 - The shift lever is in P (Park)
 - The EPB is applied
- For your safety, the Auto Hold automatically switches to EPB under any of the following conditions (Auto Hold light remains

white and the EPB automatically applies):

- The driver's door is opened.
- The engine hood or liftgate is opened.
- The vehicle is in a standstill for more than 10 minutes.
- The vehicle is standing on a steep slope.
- The vehicle moved for a few seconds.

In these cases, the brake warning light comes on, the AUTO HOLD indicator changes from green to white, and a warning sounds and a message will appear to inform you that EPB has been automatically engaged. Before driving off again, press foot brake pedal, check the surrounding area near your vehicle and release parking brake manually with the EPB switch.

- If the AUTO HOLD indicator lights up yellow, the Auto Hold is not working properly. Take your vehicle to an authorized Kia dealer and have the system checked.

⚠ WARNING

To reduce the risk of an accident, do not activate Auto Hold while driving downhill, backing up or parking your vehicle.

If there is a malfunction with the driver's door or engine hood or lift-gate open detection system, the Auto Hold may not work properly.

Take your vehicle to an authorized Kia dealer and have the system checked.

*** NOTICE**

A click or electric brake motor whine sound may be heard while operating or releasing the EPB, but these conditions are normal and indicate that the EPB is functioning properly.

Warning messages

The Auto Hold function will display a warning message with sound under certain conditions.

When the EPB is applied from Auto Hold, a warning will sound and a message will appear.



OON058076NR

When the conversion from Auto Hold to EPB is not working properly

a warning will sound and a message will appear.



OON058075NR

*** NOTICE**

When this message is displayed, the Auto Hold and EPB may not operate. For your safety, press the brake pedal.

If you do not apply the brake pedal when you release the Auto Hold by pressing the Auto Hold button, a warning will sound and a message will appear.



OON058127NR

When you press the Auto Hold button, if the driver's door and engine

hood are not closed or the liftgate is not closed, a warning will sound and a message will appear on the LCD display.



At this moment, press the Auto Hold button after closing the driver's door, engine hood and liftgate.

Anti-lock Brake System (ABS)

The Anti-lock Brake System (ABS) prevents the wheels from locking. So the vehicle remains steady and can still be steered.

ABS (or ESC) will not prevent accidents due to improper or dangerous driving maneuvers. Even though vehicle control is improved during emergency braking, always maintain a safe distance between you and objects ahead. Vehicle speeds should always be reduced during extreme road conditions. The vehicle should be driven at reduced speeds in the following circumstances:

- When driving on rough, gravel or snow-covered roads

- When driving on roads where the road surface is pitted or has different surface heights.

Driving in these conditions increases the stopping distance for your vehicle.

The ABS continuously senses the speed of the wheels. If the wheels are going to lock, the ABS repeatedly modulates the hydraulic brake pressure to the wheels.

When you apply your brakes under conditions which may lock the wheels, you may hear a "tik-tik" sound from the brakes, or feel a corresponding sensation in the brake pedal. This is normal and it means your ABS is active.

In order to obtain the maximum benefit from your ABS in an emergency situation, do not attempt to modulate your brake pressure and do not try to pump your brakes. Press your brake pedal as hard as possible to allow the ABS to control the force being delivered to the brakes.

* NOTICE

A click sound may be heard in the vehicle compartment when the vehicle begins to move after the vehicle is started. These conditions are normal and indicate that the

Anti-lock Brake System is functioning properly.

Even with the Anti-lock Brake System, your vehicle still requires sufficient stopping distance. Always maintain a safe distance from the vehicle in front of you.

Always slow down when cornering. The Anti-lock Brake System cannot prevent accidents resulting from excessive speeds.

On loose or uneven road surfaces, operation of the Anti-lock Brake System may result in a longer stopping distance than for vehicles equipped with a conventional brake system.

The ABS warning light will stay on for approximately 3 seconds after the ENGINE START/STOP button is ON.



During that time, the ABS will go through self diagnosis and the light will go off if everything is normal. If the light stays on, you may have a problem with your ABS. Contact an authorized Kia dealer as soon as possible.

When you drive on a road having poor traction, such as an icy road, and have operated your brakes con-

tinuously, the ABS will be active continuously and the ABS warning light may illuminate. Pull your vehicle over to a safe place and stop the vehicle.

Restart the vehicle. If the ABS warning light goes off, then your ABS is normal. Otherwise, you may have a problem with the ABS. Contact an authorized Kia dealer as soon as possible.

* NOTICE

When you jump start your vehicle because of a drained battery, the vehicle may not run as smoothly and the ABS warning light may turn on at the same time. This happens because of low battery voltage. It does not mean your ABS has malfunctioned.

- Do not pump your brakes!
 - Have the battery recharged before driving the vehicle.
-

Electronic Stability Control (ESC) system

The Electronic Stability Control (ESC) is designed to stabilize the vehicle during cornering maneuvers.



ESC applies the brakes on individual wheels and intervenes with the vehicle management system to stabilize the vehicle.

ESC will not prevent accidents. Excessive speed in turns, abrupt maneuvers and hydroplaning on wet surfaces can still result in serious accidents.

Only a safe and attentive driver can prevent accidents by avoiding maneuvers that cause the vehicle to lose traction. Even with ESC installed, always follow all the normal precautions for driving - including driving at safe speeds for the conditions.

⚠ WARNING

For maximum protection, always wear your seat belt. No system, no matter how advanced, can compensate for all driver error and/or driving conditions. Always drive responsibly.

The ESC system is an electronic system designed to help the driver maintain vehicle control under adverse conditions. It is not a substitute for safe driving practices. Factors including speed, road conditions and driver steering input can all affect whether ESC will be effective in preventing a loss of control. It is still your responsibility to drive and corner at reasonable speeds and to leave a sufficient margin of safety.

When you apply your brakes under conditions which may lock the wheels, you may hear a "tik-tik" sound from the brakes, or feel a corresponding sensation in the brake pedal. This is normal and it means your ESC is active.

* NOTICE

A click sound may be heard in the vehicle compartment when the vehicle begins to move after the vehicle is started. These conditions are normal and indicate that the

Electronic Stability Control system is functioning properly.

ESC operation

ESC ON condition

- When the ENGINE START/STOP button is turned ON, ESC and ESC OFF indicator lights illuminate for approximately 3 seconds, then ESC is turned on.
- Press the ESC OFF button for at least half a second after turning the vehicle ON to turn ESC off. (ESC OFF indicator will illuminate). To turn the ESC on, press the ESC OFF button (ESC OFF indicator light will go off).
- When starting the vehicle, you may hear a slight ticking sound. This is the ESC performing an automatic system self-check and does not indicate a problem.

When operating

 When the ESC is in operation, the ESC indicator light blinks. When the ESC is operating properly, you can feel a slight pulsation in the vehicle. This is only the effect of brake control and indicates nothing unusual. When moving out of the mud or driving on a slippery road, pressing the accelerator pedal may not cause the vehicle rpm (revolutions per minute) to increase.



ESC operation off

 This car has 2 kinds of ESC off states.

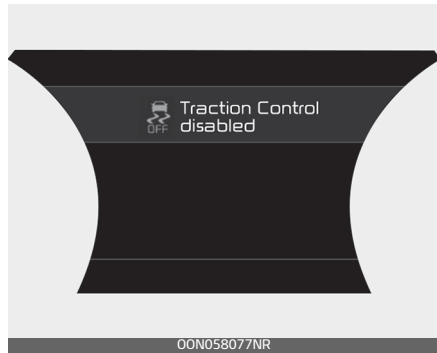
If the vehicle stops when ESC is off, ESC remains off. Upon restarting the vehicle, the ESC will automatically turn on again.





ESC off state 1 - Traction control disabled

To turn off the traction control function and only operate the brake control function of the ESC, press the ESC OFF button (ESC OFF ) for less than 3 seconds and the ESC OFF indicator light (ESC OFF ) will illuminate.



ESC off state 2 - Traction & stability control disabled

To turn off the traction control function and the brake control function of the ESC, press the ESC OFF button (ESC OFF ) for more than 3 seconds. ESC OFF indicator light (ESC OFF ) will illuminate and ESC OFF warning chime will sound. At this state, the car stability control function does not operate any more.

Indicator light

ESC indicator light



ESC OFF indicator light



When ENGINE START/STOP button is turned to ON, the indicator light illuminates, then goes off if the ESC system is operating normally.

The ESC indicator light blinks whenever ESC is operating or illuminates when ESC fails to operate.

The ESC OFF indicator light comes on when the ESC is turned off with the button.

WARNING

Electronic Stability Control

Drive carefully even though your vehicle has Electronic Stability Control. It can only assist you in maintaining control under certain circumstances.

ESC OFF usage

When driving

- ESC should be turned on for daily driving whenever possible.
- To turn ESC off while driving, press the ESC OFF button while driving on a flat road surface.

WARNING

Operating ESC

Never press the ESC OFF button while ESC is operating (ESC indicator light blinks).

If ESC is turned off while ESC is operating, the vehicle may slip out of control.

* NOTICE

- When operating the vehicle on a dynamometer, ensure that the ESC is turned off (ESC OFF light illuminated). If the ESC is left on, it may prevent the vehicle speed from increasing, and result in false diagnosis.
- Turning the ESC off does not affect ABS or brake system operation.

Vehicle Stability Management (VSM) system

The Vehicle Stability Management (VSM) provides further enhancements to vehicle stability and steering responses under the following condition:

- when driving on a slippery road or
- when a change in the coefficient of friction between left and right wheels is detected.

⚠ WARNING

Tire/Wheel size

When replacing tires and wheels, make sure they are the same size as the original tires and wheels installed. Driving with varying tire or wheel sizes may diminish any supplemental safety benefits of the VSM system.

VSM operation

When the VSM is in operation, ESC indicator light () blinks.

When the VSM is operating properly, you can feel a slight pulsation in the vehicle and/or abnormal steering responses (Electric Power Steering (EPS)). This is only the effect of brake and EPS control and indicates nothing unusual.

The VSM does not operate when:

- Driving on a sloping road such as a gradient or incline
- Driving in reverse
- ESC OFF indicator light () remains on the instrument cluster
- EPS indicator light remains on the instrument cluster

VSM operation off

If you press the ESC OFF button to turn off the ESC, the VSM will also cancel and the ESC OFF indicator

light () illuminates.

To turn on the VSM, press the button again. The ESC OFF indicator light goes out.

⚠ WARNING

Vehicle Stability Management

Drive carefully even though your vehicle has Vehicle Stability Management. It can only assist you in

maintaining control of the vehicle under certain circumstances.

Malfunction indicator

The VSM can be deactivated even if you don't cancel the VSM operation by pressing the ESC OFF button. It indicates that a malfunction has been detected somewhere in the Electric Power Steering system or VSM system. If the ESC indicator light () or EPS warning light remains on, take your vehicle to an authorized Kia dealer and have the system checked.

*** NOTICE**

- The VSM is designed to function above approximately 22 km/h (13 mph) on curves.
- The VSM is designed to function above approximately 10 km/h (6 mph) when a vehicle is braking on a split-mu surface. A split-mu surface is made of two surfaces which have different friction forces.

The VSM is not a substitute for safe driving practices but a supplementary function only. It is the responsibility of the driver to always check the speed and the distance to the vehicle ahead. Always hold the steering wheel firmly while driving.

Your vehicle is designed to activate according to the driver's intention, even with installed VSM. Always follow all the normal precautions for driving at safe speeds for the conditions – including driving in clement weather and on a slippery road.

⚠ WARNING

For maximum protection, always wear your seat belt. No system, no matter how advanced, can compensate for all driver error and/or driving conditions. Always drive responsibly.

Trailer Stability Assist (TSA) system

The Trailer Stability Assist (TSA) is operated as a vehicle stability control system. The TSA is designed to stabilize the vehicle and trailer when the trailer sways or oscillates. There are various factors that make the vehicle sway or oscillate.

Such incidents mostly happen at high speed, but, there is also a risk of swaying when the trailer is affected by crosswinds, buffeting or improper overloading.

Factors of swaying such as:

- High speed
- Strong crosswinds
- Improper overloading

- Sudden controlling of steering wheel
- Uneven road

The TSA continuously analyzes the vehicle and trailer instability. When the TSA detects some sway, the brakes are applied automatically to stabilize the vehicle on the front wheel. However, if it is not enough to stabilize, the brakes are applied on all wheels automatically and engine power is properly reduced. When the vehicle is s from swaying, the TSA does not operate.

Hill-start Assist Control (HAC)

A vehicle has the tendency to roll back on a steep hill when it starts to go after stopping. The Hill-start Assist Control (HAC) prevents the vehicle from rolling back by applying the brakes automatically for about 2 seconds.

The brakes are released when the accelerator pedal is engaged or after about 2 seconds.

The HAC is activated only for about 2 seconds, so when the vehicle is starting off on an incline, always engage the accelerator pedal.

WARNING

Maintaining Brake Pressure on Incline

HAC does not replace the need to apply brakes while stopped on an incline. While stopped, make sure you maintain brake pressure sufficient to prevent your vehicle from rolling backward and causing an accident. Don't release the brake pedal until you are ready to accelerate forward.

Good braking practices

Good braking practices help keep occupants safe and extend brake life.

- Check to be sure the parking brake is not engaged and the parking brake indicator light is out before driving away.
- Driving through water may get the brakes wet. They can also get wet when the vehicle is washed. Wet brakes can be dangerous! Your vehicle will not stop as quickly if the brakes are wet. Wet brakes may cause the vehicle to pull to one side. To dry the brakes, apply the brakes lightly until the braking action returns to normal, taking care to keep the vehicle under control at all times. If the braking action does not return to normal, stop as soon as it is safe to do so

and call an authorized Kia dealer for assistance.

- Don't coast down hills with the vehicle out of gear. This is extremely hazardous. Keep the vehicle in gear at all times, use the brakes to slow down, then shift to a lower gear so that vehicle braking will help you maintain a safe speed.
 - Don't "ride" the brake pedal. Resting your foot on the brake pedal while driving can be dangerous because the brakes might overheat and lose their effectiveness. It also increases the wear of the brake components.
 - If a tire goes flat while you are driving, apply the brakes gently and keep the vehicle pointed straight ahead while you slow down. When you are moving slowly enough for it to be safe to do so, pull off the road and stop in a safe place.
 - Be cautious when parking on a hill. Firmly engage the parking brake and place the shifter lever in P. If your vehicle is facing downhill, turn the front wheels into the curb to help keep the vehicle from rolling.
If your vehicle is facing uphill, turn the front wheels away from the curb to help keep the vehicle from rolling. If there is no curb or if it is required by other conditions to
- keep the vehicle from rolling, block the wheels.
 - Under some conditions your parking brake can freeze in the engaged position. This is most likely to happen when there is an accumulation of snow or ice around or near the rear brakes or if the brakes are wet. If there is a risk that the parking brake may freeze, apply it only temporarily while you put the shifter lever in P and block the rear wheels so the vehicle cannot roll. Then release the parking brake.
 - Do not hold the vehicle on an incline with the accelerator pedal. This can cause the reduction gear to overheat. Always use the brake pedal or parking brake.

Idle Stop and Go (ISG) system

The Idle Stop and Go (ISG) system reduces fuel consumption by automatically shutting down the engine when the vehicle is at a standstill. (For example: red light, stop sign and traffic jam)

The engine starts automatically as soon as the starting conditions are met.

The ISG is ON whenever the engine is running.

* NOTICE

When the engine automatically starts by the ISG system, some warning lights (ABS, ESC, ESC OFF, EPS or Parking brake warning light) may turn on for a few seconds. This happens because of low battery voltage. It does not mean the system has malfunctioned.

Auto stop

If you depress the brake pedal and the vehicle comes to a stop with the ISG ON, the engine will stop automatically.

Stop the vehicle completely by pressing the brake pedal when the shift lever is in the D (Drive) or N (Neutral) position.



The engine will stop and the green AUTO STOP (A) indicator on the instrument cluster will illuminate.



* NOTICE

If you open the engine hood in auto stop mode, the following will happen:

- The ISG system will deactivate (the light on the ISG OFF button will illuminate).
- A message will appear on the LCD display.



- If you move the transmission lever from N to D (Manual mode) or R without depressing the brake pedal after stopping engine automatically, the engine does not restart automatically and a warning chime alarms. When this happens, press the brake pedal for auto start.

Auto start

When the engine stops automatically by ISG, the engine will restart if one of the following driver actions.

- Release the brake pedal.
- Move the shift gear to the R (Reverse) position or the Manual mode while depressing the brake pedal.



The engine will start and the green AUTO STOP indicator (A) on the instrument cluster will go out.

The engine will also restart automatically without any driver actions if the following occurs:

- The brake vacuum pressure is low.
- The engine has stopped for about 5 minutes.
- The air conditioning is ON with the fan speed set to the highest position.
- The front defroster is ON.
- The battery is weak.
- The cooling and heating performance of the climate control system is unsatisfactory.
- The vehicle is shifted to P (Park) when Auto Hold is activated.
- The door is opened or the seat-belt is unfastened when Auto Hold is activated.
- The EPB switch is pressed when Auto Hold is activated.

Operating conditions

- The ISG will operate under the following condition:
- The driver’s seatbelt is fastened.
- The driver’s door and hood are closed.
- The brake vacuum pressure is adequate.
- The battery sensor is activated and the battery is sufficiently charged.
- Outside temperature is not too low or too high.
- The vehicle is driven over a constant speed and stops.
- The climate control system satisfies the conditions.
- The vehicle is sufficiently warmed up.
- The incline is gradual.
- The steering wheel is turned less than 180 degrees and then the vehicle stops.

* NOTICE

- If the ISG system does not meet the operation condition, the ISG system is deactivated. The light on the ISG OFF button and yellow AUTO STOP (A) indicator on the instrument cluster will illuminate.
- If the light comes on continuously, please check the operation condition.

Deactivating the ISG



- If you wish to deactivate the ISG, press the ISG OFF button. The light on the ISG OFF button will illuminate.
- If you press the ISG OFF button again, the ISG will be activated and the light on the ISG OFF button will turn off.

ISG malfunction

The ISG may not operate when:



The ISG may not operate when an ISG related sensor or system error occurs.

The following will happen:

- The yellow AUTO STOP (A) indicator on the instrument cluster will stay on after blinking for 5 seconds.
- The light on the ISG OFF button will illuminate.

When the engine is in Idle Stop mode, it's possible to restart the engine without the driver taking any action. Before leaving the car or doing anything in the engine compartment, stop the engine by the ENGINE START/STOP button to the OFF position.

*** NOTICE**

If the AGM battery is reconnected or replaced, ISG system will not operate immediately. If you want to use the ISG system, the battery sensor needs to be calibrated for approximately 4 hours with the ignition off. After calibration, turn the engine on and off 2 or 3 times.

Drive mode integrated control system (AWD)

The drive mode may be selected according to the driver's preference or road condition.



- * When the DRIVE mode is activated by pressing the DRIVE/TERRAIN button, turn the knob to display as shown below.

The mode changes whenever the DRIVE/TERRAIN knob is turned.





- COMFORT mode: COMFORT mode provides soft driving and comfortable riding.
- SPORT mode: SPORT mode provides sporty but firm riding.
- ECO mode: ECO mode improves fuel efficiency for eco-friendly driving.

The driving mode will be set to COMFORT or ECO mode when the engine is restarted. If it is in COMFORT/SPORT mode, COMFORT mode will be set, when the engine is restarted.

If it is in ECO mode, ECO mode will be set when the engine is restarted.

SMART mode



- SMART mode: SMART mode automatically adjusts the driving mode (ECO ↔ COMFORT ↔ SPORT) in accordance with the driver's driving habits.



SMART

SMART mode selects the proper driving mode among ECO, COMFORT and SPORT by judging the

driver's driving habits (i.e., mild or dynamic) from the brake pedal or the steering wheel operation.

- Turning the DRIVE/TERRAIN knob to activate SMART mode. When SMART mode is activated, the indicator illuminates on the instrument cluster.
- The vehicle starts in SMART mode, when the engine was turned OFF in SMART mode.
- SMART mode automatically controls the vehicle driving, such as

gear shifting patterns, engine torque, in accordance with the driver's driving habits.

*** NOTICE**

- When you mildly drive the vehicle in SMART mode, the driving mode changes to ECO mode to improve fuel efficiency. However, the actual fuel efficiency may differ in accordance with your driving situations (i.e., upward/downward slope, vehicle deceleration/acceleration).
- When you dynamically drive the vehicle in SMART mode by abruptly decelerating or sharply curving, the driving mode changes to SPORT mode. However, it may adversely affect fuel economy.

Various driving situations, which you may encounter in SMART mode

- The driving mode automatically changes to ECO mode after a certain period of time, when you gently press the accelerator pedal (Your driving is categorized to be mild.).
- The driving mode automatically changes from SMART ECO mode to SMART NORMAL mode after a certain period of time, when you sharply or repetitively press the accelerator pedal.
- The driving mode automatically changes to SMART COMFORT

mode with the same driving patterns, when the vehicle starts to drive on an upward slope of a certain angle. The driving mode automatically returns to SMART ECO mode, when the vehicle enters a leveled road.

- The driving mode automatically changes to SMART SPORT, when you abruptly accelerate the vehicle or repetitively operate the steering wheel (Your driving is categorized to be sporty.). In this mode, your vehicle drives in a lower gear for abrupt accelerating/decelerating and increases the engine brake performance.
- You may still sense the engine brake performance, even when you release the accelerator pedal in SMART SPORT mode. It is because your vehicle remains to be in a lower gear over a certain period of time for next acceleration. Thus, it is a normal driving situation, not indicating any malfunction.
- The driving mode automatically changes to SMART SPORT mode only in harsh driving situations. In most of the normal driving situations, the driving mode sets to be either in SMART ECO mode or in SMART COMFORT mode.

Limitation of SMART mode

The SMART mode may be limited in following situations. (The OFF indi-

cator illuminates in those situations.)

- The driver manually moves the shift lever: It deactivates SMART mode. The vehicle moves, as the driver manually moves the shift lever.
- Smart Cruise Control is activated: The Cruise function may deactivate the SMART mode. When a higher system is set by Smart Cruise Control, it starts to control vehicle speed and deactivates SMART mode. (SMART mode is not deactivated just by activating Smart Cruise Control.)
- The transmission oil temperature is either extremely low or extremely high: The SMART mode can be active in most of the normal driving situations. However, an extremely high/ low transmission oil temperature may temporarily deactivate the SMART mode, because the transmission condition is out of normal operation condition.

SPORT mode

SPORT SPORT mode manages the driving dynamics by automatically adjusting the steering effort, and the engine and transmission control logic for enhanced driver performance.

- When SPORT mode is selected by turning the DRIVE/TERRAIN knob, the SPORT indicator (orange color) will illuminate.
- Whenever the engine is restarted, the Drive Mode will revert back to COMFORT mode. If SPORT mode is desired, re-select SPORT mode from the DRIVE/TERRAIN knob.
- When SPORT mode is activated:
 - The engine rpm will tend to remain raised over a certain length of time even after releasing the accelerator.
 - Upshifts are delayed when accelerating.

* NOTICE

In SPORT mode, the fuel efficiency may decrease.

ECO mode

ECO

When the Drive Mode is set to ECO mode, the engine and transmission control logic are changed to maximize fuel efficiency.

- When ECO mode is selected by turning the knob, the ECO indicator (green color) will illuminate.
- If the vehicle is set to ECO mode, when the engine is turned OFF and restarted the Drive Mode setting will remain in ECO mode.

* NOTICE

Fuel efficiency depends on the driver's driving habit and road condition.

When ECO mode is activated:

- The acceleration response may be slightly reduced if the accelerator pedal is engaged moderately.
- The shift pattern of the automatic transmission may change.

The above situations are normal conditions when ECO mode is activated to improve fuel efficiency.

Limitation of ECO mode operation:

If the following conditions occur while ECO mode is operating, the system operation is limited even though there is no change in the ECO indicator.

- When driving the vehicle with the automatic transmission gear shift lever in Manual mode. The system will be limited according to the shift location.

Forward Collision-Avoidance Assist (FCA) (Sensor fusion)

Forward Collision-Avoidance Assist is designed to help detect and monitor the vehicle ahead or help detect a pedestrian or cyclist in the roadway and warn the driver that a collision is imminent with a warning message and an audible warning, and if necessary, apply emergency braking.



* NOTICE

FCA stands for Forward Collision-Avoidance Assist.

Detecting sensor



[1]: Front view camera, [2]: Front radar
Refer to the picture above for the detailed location of the detecting sensors.

⚠ CAUTION

Take the following precautions to maintain optimal performance of the detecting sensor:

- Never disassemble the detecting sensor or sensor assembly, or apply any impact on it.

- If the detecting sensors have been replaced or repaired, have your vehicle inspected by an authorized Kia dealer.
- Never install any accessories or stickers on the front windshield, or tint the front windscreen.
- Pay extreme caution to keep the front view camera dry.
- Never place any reflective objects (i.e. white paper, mirror) over the dashboard. Any light reflection may prevent the function from functioning properly.
- Do not apply license plate frame or objects, such as a bumper sticker, film or a bumper guard, near the front radar cover.
- Always keep the front radar and cover clean and free of dirt and debris. Use only a soft cloth to wash the vehicle. Do not spray pressurized water directly on the sensor or sensor cover.
- If unnecessary force has been applied to the radar or around the radar, Forward Collision-Avoidance Assist may not properly operate even though a warning message does not appear on the cluster. In this case, have your vehicle inspected by an authorized Kia dealer.
- Use only genuine parts to repair or replace a damaged front radar cover. Do not apply paint to the front radar cover.

Forward Collision-Avoidance Assist Settings

Setting features

Forward Safety



With the ENGINE START/STOP button in the ON position, press MODE button (⏏) several times on the steering wheel until 'User Settings' menu appears on the LCD display. Select 'Driver Assistance → Forward Safety' from the setting menu to set whether or not to use each function.

- If 'Active Assist' is selected, the function will warn the driver with a warning message, an audible warning and steering wheel vibration depending on the collision risk levels. Braking assist will be applied depending on the collision risk.

- If 'Warning Only' is selected, the function will warn the driver with a warning message, an audible warning depending on the collision risk levels. Braking will not be assisted. The driver must apply the brake pedal or steer the vehicle if necessary.
- If 'Off' is selected, the function will off. The  warning light will illuminate on the cluster.

The driver can monitor Forward Collision-Avoidance Assist ON/OFF status from the settings menu. If the  warning light remains ON when the function is ON, have the function checked by an authorized Kia dealer.

⚠ WARNING

- When the engine is restarted, Forward Collision-Avoidance Assist will always turn on.
- If 'Off' is selected from the settings menu, the Forward Collision Assist will not operate so the driver should always be aware of the surroundings and drive safely.

⚠ CAUTION

If 'Warning Only' is selected, braking is not assisted.

*** NOTICE**

Forward Collision-Avoidance Assist will turn off when ESC is turned off by pressing and holding the ESC OFF button and the  warning light will illuminate.

Warning Timing



With the ENGINE START/STOP button in the ON position, press MODE button () several times on the steering wheel until 'User Settings' menu appears on the LCD display. Select 'Driver Assistance → Warning Timing' to change the initial warning activation time for Forward Collision-Avoidance Assist.

When the vehicle is first delivered, Warning Timing is set to 'Normal'. If you change the Warning Timing, the warning time of other Driver Assistance system may change.

Warning Volume

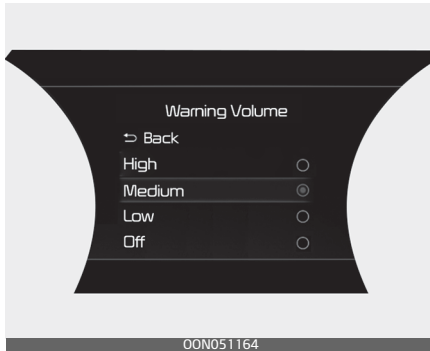

With the ENGINE START/STOP button in the ON position, press MODE button (📄) several times on the steering wheel until 'User Settings' menu appears on the LCD display. Select 'Driver Assistance → Warning Volume' to change the warning volume to 'High', 'Medium', 'Low' or 'Off' for Forward Collision-Avoidance Assist.

If you change the Warning volume, the Warning volume of other Driver Assistance functions may change.

⚠ CAUTION

- The setting of the Warning timing and Warning volume applies to all functions of Forward Collision-Avoidance Assist.
- Even though 'Normal' is selected for Warning timing, if the front vehicle suddenly stops, the initial warning activation time may not seem late.

- Select 'Late' for Warning Timing when traffic is light and when driving speed is slow.

* NOTICE

If the engine is restarted, Warning timing and Warning volume will maintain the last setting.

Forward Collision-Avoidance Assist Operation

Warning and control

The basic function for Forward Collision-Avoidance Assist is to warn and control the vehicle depending on the collision level: 'Collision Warning', 'Emergency Braking'.

Collision Warning



- To warn the driver of a collision, the 'Collision Warning' warning message will appear on the cluster, an audible warning will sound

and the steering wheel will vibrate.

- If a vehicle is detected in front, the function will operate when your vehicle speed is between approximately 10~150 km/h (6~93 mph).
- If a pedestrian or cyclist is detected in front, the function will operate when your vehicle speed is between approximately 10~85 km/h (6~53 mph).

Emergency Braking



- To warn the driver that emergency braking will be assisted, the 'Emergency Braking' warning message will appear on the cluster, an audible warning will sound and the steering wheel will vibrate.
- If a vehicle is detected in front, the function will operate when your vehicle speed is between approximately 10~75 km/h (6~45 mph).

- If a pedestrian or cyclist is detected in front, the function will operate when your vehicle speed is between approximately 10~65 km/h (6~40 mph).
- In emergency braking situation, braking is assisted with strong braking power by the function to help prevent collision with the vehicle, pedestrian or cyclist ahead.

⚠ WARNING

- For your safety, change the settings after parking the vehicle at a safe location.
- With 'Active Assist' or 'Warning Only' selected, when ESC is turned off by pressing and holding the ESC OFF button, Forward Collision-Avoidance Assist will turn off automatically. In this case, the function cannot be set from the settings menu and the warning light will illuminate on the cluster which is normal. If ESC is turned on by pressing the ESC OFF button, Forward Collision-Avoidance Assist will maintain the last setting.
- Forward Collision-Avoidance Assist does not operate in all situations or cannot avoid all collisions.
- The driver should hold the responsibility to control the vehicle. Do not solely depend on For-

ward Collision-Avoidance Assist. Rather, maintain a safe braking distance, and if necessary, depress the brake pedal to reduce driving speed or to stop the vehicle.

- Never deliberately operate Forward Collision-Avoidance Assist on people, animal, objects, etc. It may cause serious injury or death.
- Forward Collision-Avoidance Assist may not operate if the driver depresses the brake pedal to avoid collision.
- Depending on the road and driving conditions, Forward Collision-Avoidance Assist may warn the driver late or may not warn the driver.
- During Forward Collision-Avoidance Assist operation, the vehicle may stop suddenly injuring passengers and shifting loose objects. Always have the seat belt on and keep loose objects secured.
- If any other function's warning message is displayed or audible warning is generated, Forward Collision-Avoidance Assist warning message may not be displayed and audible warning may not be generated.
- You may not hear the warning sound of Forward Collision-Avoidance Assist if the surrounding is noisy.

- Forward Collision-Avoidance Assist may turn off or may not operate properly or may operate unnecessarily depending on the road conditions and the surroundings.

WARNING

- Even if there is a problem with Forward Collision-Avoidance Assist, the vehicle's basic braking performance will operate normally.
- During emergency braking, braking control by the function will automatically cancel when the driver excessively depresses the accelerator pedal or sharply steers the vehicle.

CAUTION

- Depending on the condition of the vehicle, pedestrian and cyclist in front and the surroundings, the speed range to operate Forward Collision-Avoidance Assist may reduce. The function may only warn the driver, or the function may not operate.
- It operates only under certain conditions by judging the danger according to a condition of the oncoming vehicle, driving direction, speed and the surrounding environment.



*** NOTICE**

In a situation collision is imminent, braking may be assisted by Forward Collision-Avoidance Assist when braking is insufficient by the driver.

Forward Collision-Avoidance Assist Malfunction and Limitations



Forward Collision-Avoidance Assist malfunction



When Forward Collision-Avoidance Assist is not working properly, the 'Check Forward Collision-Avoidance Assist system' warning message will appear (turns off after a certain time), and the  and  warning lights will illuminate on the cluster. In this case, have the vehicle inspected by an authorized Kia dealer.

Forward Collision-Avoidance Assist disabled



When the front windscreen where the front view camera is located, front radar cover or sensor is covered with foreign material such as snow or rain, it can reduce the detecting performance and temporarily limit or disable Forward Collision-Avoidance Assist. If this occurs the 'Forward Collision-Avoidance Assist (FCA) system disabled. Radar blocked' warning message will appear (turns off after a certain time), and the  and  warn-

ing lights will illuminate on the cluster.

The function will operate normally when snow, rain or foreign matter is removed. If the function does not operate normally after it is removed, have the vehicle inspected by an authorized Kia dealer.

⚠ WARNING

- Even though the warning message or warning light does not appear on the cluster, Forward Collision-Avoidance Assist may not properly operate.
- Forward Collision-Avoidance Assist may not properly operate in an area (e.g. open terrain), where any substance are not detected after turning ON the engine.

Limitations of Forward Collision-Avoidance Assist

Forward Collision-Avoidance Assist may not operate normally, or the function may operate unexpectedly under the following circumstances:

- The detecting sensor or the surroundings are contaminated or damaged
- The temperature around the front view camera is high or low due to the external environment
- The camera lens is contaminated due to tinted, filmed or coated

- windscreen, damaged glass, or stuck of foreign matters (sticker, bug, etc.) on the glass
- Moisture is not removed or frozen on the windscreen
- Washer fluid is continuously sprayed, or the wiper is on
- Driving in heavy rain or snow, or thick fog
- The field of view of the front view camera is obstructed by sun glare
- Street light or light from an oncoming vehicle is reflected on the wet road surface, such as a puddle on the road
- An object is placed on the dashboard
- Your vehicle is being towed
- The surrounding is very bright
- The surrounding is very dark, such as in a tunnel, etc.
- The brightness changes suddenly, for example when entering or exiting a tunnel
- The brightness outside is low, and the headlamps are not on or are not bright
- Driving through steam, smoke or shadow
- Only part of the vehicle, pedestrian or cyclist is detected
- The vehicle in front is a bus, heavy truck, truck with a unusually shaped luggage, trailer, etc.
- The vehicle in front has no tail lights, tail lights are located unusually, etc.

Driving your vehicle

- The brightness outside is low, and the tail lamps are not on or are not bright
- The rear of the front vehicle is small or the vehicle does not look normal, such as when the vehicle is tilted, overturned, or the side of the vehicle is visible, etc.
- The front vehicle's ground clearance is low or high
- A vehicle, pedestrian or cyclist suddenly cuts in front
- The bumper around the front radar is impacted, damaged or the front radar is out of position
- The temperature around the front radar is high or low
- Driving through a tunnel or iron bridge
- Driving in large areas where there are few vehicles or structures (i.e. desert, meadow, suburb, etc.)
- Driving near areas containing metal substances, such as a construction zone, railroad, etc.
- A material is near that reflects very well on the front radar, such as a guardrail, nearby vehicle, etc.
- The cyclist in front is on a bicycle made of material that does not reflect on the front radar
- The vehicle in front is detected late
- The vehicle in front is suddenly blocked by an obstacle
- The vehicle in front suddenly changes lane or suddenly reduces speed

Forward Collision-Avoidance Assist (FCA) (Sensor fusion)

- The vehicle in front is bent out of shape
- The front vehicle's speed is fast or slow
- The vehicle in front steers in the opposite direction of your vehicle to avoid a collision
- With a vehicle in front, your vehicle changes lane at low speed
- The vehicle in front is covered with snow
- You are departing or returning to the lane
- You are driving unstably
- You are on a roundabout and the vehicle in front is not detected
- You are continuously driving in a circle
- The vehicle in front has an unusual shape
- The vehicle in front is driving uphill or downhill
- The pedestrian or cyclist is not fully detected, for example, if the pedestrian is leaning over or is not fully walking upright
- The pedestrian or cyclist is wearing clothing or equipment that makes it difficult to detect as a pedestrian or cyclist

Following image shows the image the sensor recognizes as vehicle, pedestrian, and cyclist.



- The pedestrian or cyclist in front is moving very quickly
 - The pedestrian or cyclist in front is short or is posing a low posture
 - The pedestrian or cyclist in front has impaired mobility
 - The pedestrian or cyclist in front is moving intersected with the driving direction
 - There is a group of pedestrians, cyclists or a large crowd in front
 - The pedestrian or cyclist is wearing clothing that easily blends into the background, making it difficult to detect
 - The pedestrian or cyclist is difficult to distinguish from the similar shaped structure in the surroundings
 - You are driving by a pedestrian, cyclist traffic signs, structures, etc. near the intersection
 - Driving in a parking lot
- Driving through a tollgate, construction area, unpaved road, partial paved road, uneven road, speed bumps, etc.
 - Driving on an incline road, curved road, etc.
 - Driving through a roadside with trees or streetlights
 - The adverse road conditions cause excessive vehicle vibrations while driving
 - Your vehicle height is low or high due to heavy loads, abnormal tire pressure, etc.
 - Driving through a narrow road where trees or grass are overgrown
 - There is interference by electromagnetic waves, such as driving in an area with strong radio waves or electrical noise

⚠ WARNING

• **Driving on a curved road**



The front view camera or radar sensor recognition function may not detect the vehicle, pedestrian

or cyclist travelling in front on a curved road.

Always pay attention to road and driving conditions, and if necessary, depress the brake pedal to reduce your driving speed in order to maintain a safe distance.



Forward Collision-Avoidance Assist may detect a vehicle or pedestrian in the next lane or outside the lane when driving on a curved road. If this occurs, the unnecessarily alarm the driver and apply the brake. Always check the traffic conditions around the vehicle.

- **Driving on a sloped road**



Forward Collision-Avoidance Assist may not detect other vehicle, pedestrian or cyclist in front while driving uphill or downhill and this may result in no warning, braking assist when necessary.

When the function suddenly recognizes the vehicle, pedestrian or cyclist in front while passing over a slope, you may experience sharp deceleration.

Always keep your eyes forward while driving upward or downward on a slope, and, if necessary, depress the brake pedal to reduce your driving speed in order to maintain distance.

• Changing lanes

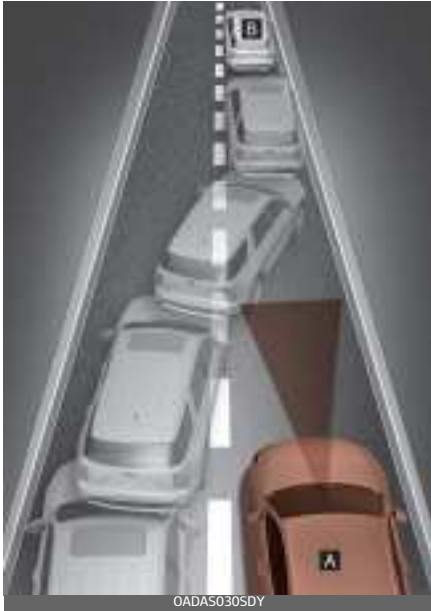

[A]: Your vehicle

[B]: Lane changing vehicle

When a vehicle changes lanes in front of you, Forward Collision-Avoidance Assist may not immediately detect the vehicle, especially if the vehicle changes lanes abruptly. In this case, you must maintain a safe braking distance, and if necessary, depress the brake pedal to reduce your driving speed in order to maintain a safe distance.



[A]: Your vehicle

[B]: Lane changing vehicle

[C]: Same lane vehicle

When driving in stop-and-go traffic, and a stopped vehicle in front of you merges out of the lane, Forward Collision-Avoidance Assist may not immediately detect the new vehicle that is now in front of you. In this case, you must maintain a safe braking distance, and if necessary, depress the brake pedal to reduce your driving speed in order to maintain a safe distance.

- **Recognizing the vehicle**



When the vehicle in front has heavy loading extended rearward, or when the vehicle in front has higher ground clearance, it may induce a hazardous situation. Always pay attention to road and driving conditions, while driving and, if necessary, depress the brake pedal to reduce your driving speed in order to maintain distance.

⚠ WARNING

- When you are towing a trailer or another vehicle, we recommend that Forward Collision-Avoidance Assist is turned off due to safety reasons.
- Forward Collision-Avoidance Assist may operate if objects that are similar in shape or characteristics to vehicles, pedestrians or cyclists are detected.
- Forward Collision-Avoidance Assist does not operate on bicy-

cles, motorcycles, or smaller wheeled objects, such as luggage bags, shopping carts, or strollers that are dragged by a pedestrian or a cyclist.

- Forward Collision-Avoidance Assist may not operate normally if interfered by strong electromagnetic waves.
- Forward Collision-Avoidance Assist may not operate for 15 seconds after the vehicle is started, or the front view camera is initialized.

This device complies with Industry Canada licence-exempt RSS standard(s).

Operation is subject to the following conditions:

1. This device may not cause interference, and
2. This device must accept any interference, including interference that may cause undesired operation of the device.
3. Changes or modifications not expressly approved by the party responsible for compliance could void the user's authority to operate the device.

Lane Keeping Assist (LKA)

Lane Keeping Assist is designed to help detect the lane markers while driving over a certain speed. The function will warn the driver if the vehicle leaves the lane without using the turn signal, or will automatically assist the driver's steering to help prevent the vehicle from departing the lane.

* NOTICE

LKA stands for Lane Keeping Assist.

Detecting sensor



[1]: Front view camera

The front view camera is used as a detecting sensor to detect lane markings.

Refer to the picture above for the detailed location of the detecting sensor.

⚠ CAUTION

For more details on the precautions of the front view camera, refer to "Forward Collision-Avoidance Assist (FCA) (Sensor fusion)" on page 5-52.

Lane Keeping Assist Settings

Setting features

Lane Safety



With the ENGINE START/STOP button in the ON position, press MODE button (⏏) several times on the steering wheel until 'User Settings' menu appears on the LCD display. Select 'Driver Assistance → Lane Safety' from the setting menu to set whether or not to use each function.

- If 'Lane Keeping Assist' is selected, the function will automatically assist the driver's steering when lane departure is

detected to help prevent the vehicle from moving out of its lane.

- If 'Lane Departure Warning' is selected, the function will warn the driver with an audible warning when lane departure is detected. The driver must steer the vehicle.
- If 'Off' is selected, the function will turn off. The indicator light () will turn off on the cluster.

WARNING

- If 'Lane Departure Warning' is selected, steering is not assisted.
- Lane Keeping Assist does not control the steering wheel when the vehicle is driven in the middle of the lane.
- The driver should always be aware of the surroundings and steer the vehicle if 'Off' is selected.

Turning Lane Keeping Assist On/Off



With the ENGINE START/STOP button in the ON position, press the Lane Safety button located on the instrument panel to turn on Lane Keeping Assist. The white indicator light () will illuminate on the cluster. Press the button again to turn off the function.

* NOTICE

- If the engine is restarted, Lane Keeping Assist will maintain the last setting.
- When Lane Keeping Assist is turned off with the Lane Safety button, Lane Safety system settings will turn off.

Warning Volume

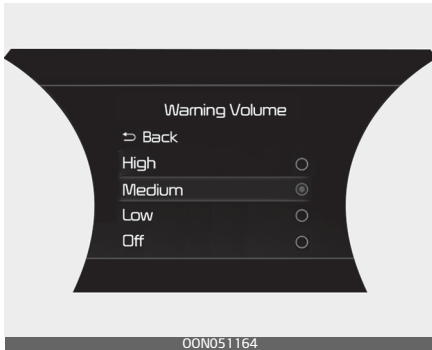

With the ENGINE START/STOP button in the ON position, press MODE button (⏸) several times on the steering wheel until 'User Settings' menu appears on the LCD display. Select 'Driver Assistance → Warning Volume' to change the warning volume to 'High', 'Medium', 'Low' or 'Off' for Lane Keeping Assist.

If you change the Warning Volume, the Warning Volume of other Driver Assistance system may be changed.

Lane Keeping Assist Operation

Warning and control

Lane Keeping Assist will warn and control the vehicle with Lane Departure Warning and Lane Keeping Assist.

Lane Departure Warning

Left



Right



- To warn the driver that the vehicle is departing from the projected lane in front, the green (🚗) indicator light will blink on the cluster, the lane line will blink on the cluster depending on which direction the vehicle is veering, and an audible warning will sound.
- The function will operate when your vehicle speed is between approximately 64~169 km/h (40~105 mph).

Lane Keeping Assist

- To warn the driver that the vehicle is departing from the projected lane in front, the green () indicator light will blink on the cluster, and the steering wheel will make adjustments to keep vehicle inside the lane.
- The function will operate when your vehicle speed is between approximately 64~169 km/h (40~105 mph).

Hands-off warning



If the driver takes their hands off the steering wheel for several seconds, the 'Keep hands on steering wheel' warning message will appear on the cluster, and an audible warning will sound in stages.

WARNING

- The steering wheel may not be assisted if the steering wheel is held very tight or the steering

wheel is steered over a certain degree.

- Lane Keeping Assist does not operate at all times. It is the responsibility of the driver to safely steer the vehicle and to maintain the vehicle in its lane.
- The hands-off warning message may appear late depending on road conditions. Always have your hands on the steering wheel while driving.
- If the steering wheel is held very lightly, the hands off warning message may appear because the function may not recognize that the driver has their hands on the steering wheel.
- If you attach objects to the steering wheel, the hands-off warning may not work properly.

* NOTICE

- For more details on setting the functions in the infotainment function, refer to "LCD Display Modes" on page 4-77.
- When lane markings are detected, the lane lines on the cluster will change from gray to white and the green () indicator light will illuminate if Lane Keeping Assist is operable.

Lane undetected



Lane detected



Lane Keeping Assist Malfunction and Limitations

Lane Keeping Assist malfunction



When Lane Keeping Assist is not working properly, the 'Check Lane Keeping Assist (LKA) system', warning message will appear and the yellow () indicator light will illuminate on the cluster. In this case, have the function checked by an authorized Kia dealer.

- Even though the steering is assisted by Lane Keeping Assist, the driver may control the steering wheel.
- The steering wheel may feel heavier or lighter when the steering wheel is assisted by Lane Keeping Assist than when it is not.

Limitations of Lane Keeping Assist

Lane Keeping Assist may not operate normally or may operate unexpectedly under the following circumstances:

- The lane is contaminated or difficult to distinguish because,
 - The lane markings is covered with rain, snow, dirt, oil, etc.
 - The color of the lane marking is not distinguishable from the road

- There are markings on the road near the lane or the markings on the road looks similar to the lane markings
- The lane marking is indistinct or damaged
- The shadow is on the lane marking by a median strip, trees, guardrail, noise barriers, etc.
- There are more than two lane markings on the road
- The lane number increases or decreases, or the lane markings are crossing
- The lane markings are complicated or a structure substitutes for the lines, such as a construction area
- There are road markings, such as zigzag lanes, crosswalk markings and road signs
- The lane suddenly disappears, such as at the intersection
- The lane is very wide or narrow
- There is a road edge without a lane
- There is a boundary structure in the roadway, such as a tollgate, sidewalk, curb, etc.
- The distance to the front vehicle is extremely short or the vehicle in front is covering the lane marking

⚠ CAUTION

For more details on the limitations of the front view camera, refer to "Forward Collision-Avoidance Assist (FCA) (Sensor fusion)" on page 5-52.

⚠ WARNING

Take the following precautions when using Lane Keeping Assist:

- The driver should hold the responsibility to safely drive and control the vehicle. Do not solely rely on the function and drive dangerously.
- The operation of Lane Keeping Assist can be cancelled or not work properly depending on road conditions and surroundings. Always be cautious while driving.
- Refer to "Limitations of Lane Keeping Assist" on page 5-70, if the lane is not detected properly.
- When you are towing a trailer or another vehicle, we recommend that Lane Keeping Assist is turned off due to safety reasons.
- If the vehicle is driven at high speed, the steering wheel will not be controlled. The driver must always follow the speed limit when using the function.
- If any other function's warning message is displayed or audible warning is generated, Lane Keeping Assist warning message may

not be displayed and audible warning may not be generated.

- You may not hear the warning sound of Lane Keeping Assist if the surrounding is noisy.
- If you attach objects to the steering wheel, steering may not be assisted properly.
- Lane Keeping Assist may not operate for 15 seconds after the vehicle is started, or the front view camera is initialized.
- Lane Keeping Assist will not operate when:
 - The turn signal or hazard warning flasher is turned on
 - The vehicle is not driven in the center of the lane when the function is turned on or right after changing a lane
 - ESC (Electronic Stability Control) or VSM (Vehicle Stability Management) is activated
 - The vehicle is driven on a sharp curve
 - Vehicle speed is below 35 mph (55 km/h) or above 130 mph (210 km/h)
 - The vehicle makes sharp lane changes
 - The vehicle is suddenly stopped

Blind-Spot Collision-Avoidance Assist (BCA)

Blind-Spot Collision-Avoidance Assist is designed to help detect and monitor approaching vehicles in the driver's blind spot area and warn the driver of a possible collision with a warning message and audible warning.

In addition, if there is a risk of collision when changing lanes or driving forward out of a parking space, Blind-Spot Collision-Avoidance Assist will help avoid collision by applying the brake.

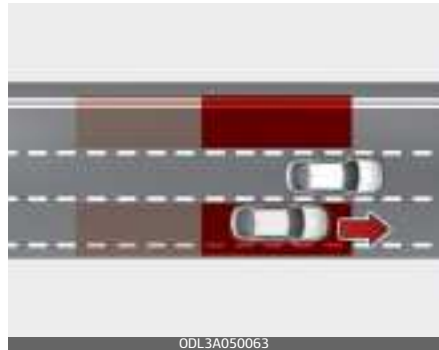

Blind-Spot Collision-Avoidance Assist help detects and informs the driver that a vehicle is in the blind spot.

⚠ CAUTION

The detecting range may vary depending on the speed of your vehicle. However, even if there is a vehicle in the blind spot, Blind-Spot

Collision-Avoidance Assist may not warn you when you pass by at high speeds.



Blind-Spot Collision-Avoidance Assist helps detect and inform the driver that a vehicle is approaching at high speed from the blind spot area.

⚠ CAUTION

Warning timing may vary depending on the speed of the vehicle approaching at high speed.

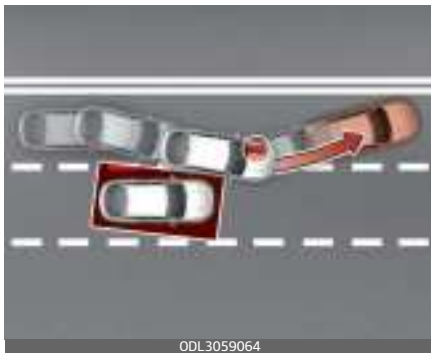

When changing lanes by detecting the lane ahead, if Blind-Spot Collision-Avoidance Assist judges that there is a collision risk with an approaching vehicle in the blind spot, it will help avoid collision by applying the differential brake.

* NOTICE

BCA stands for Blind-Spot Collision-Avoidance Assist.

Detecting sensor



[1] : Front view camera, [2] : Rear corner radar

Refer to the picture above for the detailed location of the detecting sensors.

⚠ CAUTION

Take the following precautions to maintain optimal performance of the detecting sensor:

- Never disassemble the rear corner radar or radar assembly, or apply any impact on it.
- If there is impact on the rear corner radar or near the radar, even though the warning message does not appear on the cluster, Blind-Spot Collision-Avoidance Assist may not operate properly. In this case, have your vehicle inspected by an authorized Kia dealer.
- If the rear corner radars have been replaced or repaired, have your vehicle inspected by an authorized Kia dealer.
- Use only genuine parts to repair the rear bumper where the rear corner radar is located.
- Do not apply license plate frame or objects, such as a bumper sticker, film or a bumper guard near the rear corner radar.
- The function may not work properly if the bumper has been replaced, or the surroundings of the rear corner radar has been damaged or paint has been applied.

- If a trailer, carrier, etc. is installed, it may adversely affect the performance of the rear corner radar or the function may not operate.

For more details on the precautions of the front view camera, refer to "Forward Collision-Avoidance Assist (FCA) (Sensor fusion)" on page 5-52.

Blind-Spot Collision-Avoidance Assist Settings

Setting features

Blind-Spot Safety



With the ENGINE START/STOP button in the ON position, press MODE button (⏏) several times on the steering wheel until 'User Settings' menu appears on the LCD display. Select 'Driver Assistance → Blind-Spot Safety' from the setting menu to set whether or not to use each function.

- If 'Active Assist' is selected, Blind-Spot Collision-Avoidance Assist will warn the driver with a warning message, an audible warning and braking assist will be applied depending on the collision risk levels.
- If 'Warning Only' is selected, Blind-Spot Collision-Avoidance Assist will warn the driver with a warning message, an audible warning depending on the collision risk levels. Braking will not be assisted.
- If 'Off' is selected, Blind-Spot Collision-Avoidance Assist will turn off.

If you change the setting from 'Off' to 'Active Assist' or 'Warning Only', the warning light on the side view mirror (outside mirror) will blink for approximately 3 seconds.

In addition, if the engine is turned on, when the function is set to 'Active Assist' or 'Warning Only', the warning light on the side view mirror (outside mirror) will blink for approximately 3 seconds.

⚠ WARNING

- If 'Warning Only' is selected, braking is not assisted.
- If 'Off' is selected, the driver should always be aware of the surroundings and drive safely.

*** NOTICE**

If the engine is restarted, Blind-Spot Collision-Avoidance Assist will maintain the last setting.

Warning Timing



With the ENGINE START/STOP button in the ON position, press MODE button (⏸) several times on the steering wheel until 'User Settings' menu appears on the LCD display. Select 'Driver Assistance → Warning Timing' to change the initial warning activation time for Blind-Spot Collision-Avoidance Assist.

When the vehicle is first delivered, Warning Timing is set to 'Normal'. If you change the Warning Timing, the warning time of other Driver Assistance system may change.

Warning Volume

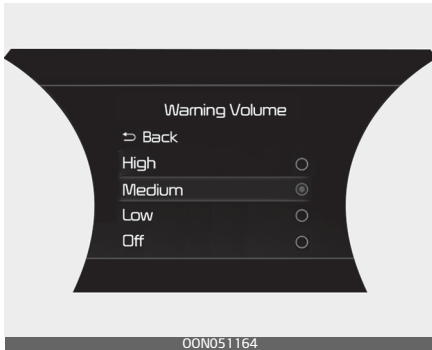

With the ENGINE START/STOP button in the ON position, press MODE button (⏏) several times on the steering wheel until 'User Settings' menu appears on the LCD display. Select 'Driver Assistance → Warning Volume' to change the warning volume to 'High', 'Medium', 'Low' or 'Off' for Blind-Spot Collision-Avoidance Assist.

If you change the Warning Volume, the warning volume of other Driver Assistance system may change.

⚠ CAUTION

- The setting of the Warning Timing and Warning Volume applies to all functions of Blind-Spot Collision-Avoidance Assist.
- Even though 'Normal' is selected for Warning Timing, if the vehicles approaches at high speed, the initial warning activation time may seem late.

- Select 'Late' for Warning Timing when traffic is light and when driving speed is slow.

Blind-Spot Collision-Avoidance Assist Operation

Warning and control

Vehicle detection



- To warn the driver a vehicle is detected, the warning light on the side view mirror (outside mirror) and Head-up display (if equipped) will illuminate.
- Blind-Spot Collision-Avoidance Assist will operate when your vehicle speed is above 30 km/h (20 mph) and the speed of the vehicle in the blind spot area is above 10 km/h (7 mph).

Collision Warning

- Collision Warning will operate when the turn signal is turned on

in the direction of the detected vehicle.

- If 'Warning Only' is selected from the setting menu, the collision warning will operate when your vehicle approaches the lane the blind spot vehicle is detected.
- To warn the driver of a collision, the warning light on the side view mirror (outside mirror) and Head-up display (if equipped) will blink.
- When the turn signal is turned off or you move away from the lane, the collision warning will be canceled and Blind-Spot Collision-Avoidance Assist will return to vehicle detection state.

⚠ WARNING

- The detecting range of the rear corner radar is determined by a standard road width, therefore, on a narrow road, Blind-Spot Collision-Avoidance Assist may detect other vehicles in the second lane from your vehicle and warn you.
- In contrast, on a wide road, Blind-Spot Collision-Avoidance Assist may not be able to detect a vehicle driving in the next lane and may not warn you.
- When the hazard warning light is on, the collision warning by the turn signal will not operate.

Collision-Avoidance Assist



- To warn the driver of a collision, the warning light on the side view mirror (outside mirror) will blink and a warning message will appear on the cluster. At the same time, an audible warning will sound, warning light on the head-up display (if equipped) will blink.
- Blind-Spot Collision-Avoidance Assist will operate when your vehicle speed is between 60~180 km/h (40~110 mph) and both lane markings of the driving lane are detected.
- Emergency Braking will be assisted to help prevent collision with the vehicle in the blind spot area.

⚠ WARNING

- Collision-Avoidance Assist will be canceled under the following circumstances:
 - Your vehicle enters the next lane by a certain distance

- Your vehicle is away from the collision risk
- The steering wheel is sharply steered
- The brake pedal is depressed
- Forward Collision-Avoidance Assist is operating
- After function operation or changing lane, you must drive to the center of the lane. The function will not operate if the vehicle is not driven in the center of the lane.

⚠ WARNING

- For your safety, change the Settings after parking the vehicle at a safe location.
- If any other function's warning message is displayed or audible warning is generated, Blind-Spot Collision-Avoidance Assist's warning message may not be displayed and audible warning may not be generated.
- You may not hear the warning sound of Blind-Spot Collision-Avoidance Assist if the surrounding is noisy.
- Blind-Spot Collision-Avoidance Assist may not operate if the driver applies the brake pedal to avoid collision.
- When Blind-Spot Collision-Avoidance Assist is operating, braking control by the function will automatically cancel when the driver excessively depresses the accelerator pedal or sharply steers the vehicle.
- During Blind-Spot Collision-Avoidance Assist operation, the vehicle may stop suddenly injuring passengers and shifting loose objects. Always have the seat belt on and keep loose objects secured.
- Even if there is a problem with Blind-Spot Collision-Avoidance Assist, the vehicle's basic braking performance will operate normally.
- Blind-Spot Collision-Avoidance Assist does not operate in all situations or cannot avoid all collisions.
- Blind-Spot Collision-Avoidance Assist may warn the driver late or may not warn the driver depending on the road and driving conditions.
- Driver should maintain control of the vehicle at all times. Do not depend on Blind-Spot Collision-Avoidance Assist. Maintain a safe braking distance, and if necessary, depress the brake pedal to reduce driving speed or to stop the vehicle.
- Never operate Blind-Spot Collision-Avoidance Assist on people, animal, objects, etc. It may cause serious injury or death.

⚠ WARNING

The brake control may not operate properly depending on the status of ESC (Electronic Stability Control).

There will only be a warning when:

- The ESC (Electronic Stability Control) warning light is on.
- ESC (Electronic Stability Control) is engaged in a different function.

Blind-Spot Collision-Avoidance Assist Malfunction and Limitations

Blind-Spot Collision-Avoidance Assist malfunction



When Blind-Spot Collision-Avoidance Assist is not working properly, the 'Check Blind-Spot Collision Avoidance Assist (BCA)' warning message will appear (turns off after a certain time), and (⚠) warning light will illuminate on the cluster. In this case, have your vehicle inspected by an authorized Kia dealer.

Blind-Spot Collision-Avoidance Assist disabled



When the rear bumper around the rear corner radar or sensor is covered with foreign material, such as snow or rain, or installing a trailer or carrier, it can reduce the detecting performance and temporarily limit or disable Blind-Spot Collision-Avoidance Assist.

If this occurs, the 'Blind-Spot Collision Warning (BCW) system disabled. Radar blocked' warning message will appear on the cluster.

Blind-Spot Collision-Avoidance Assist will operate normally when such foreign material or trailer, etc. is removed, and then the engine is restarted.

If Blind-Spot Collision-Avoidance Assist does not operate normally after it is removed, have your vehicle inspected by an authorized Kia dealer.

⚠ WARNING

- Even though the warning message does not appear on the cluster, Blind-Spot Collision-Avoidance Assist may not properly operate.
- Blind-Spot Collision-Avoidance Assist may not properly operate in an area (e.g. open terrain), where any substance are not detected right after the engine is turned on, or when the detecting sensor is blocked with foreign material right after the engine is turned on.

⚠ CAUTION

Turn off Blind-Spot Collision-Avoidance Assist to install a trailer, carrier, etc., or remove the trailer, carrier, etc. to use Blind-Spot Collision-Avoidance Assist.

Limitations of Blind-Spot Collision-Avoidance Assist

Blind-Spot Collision-Avoidance Assist may not operate normally, or the function may operate unexpectedly under the following circumstances:

- There is inclement weather, such as heavy snow, heavy rain, etc.
- The rear corner radar is covered with snow, rain, dirt, etc.
- The temperature around the rear corner radar is high or low
- Driving on a highway (or motorway) ramp
- The road pavement (or the peripheral ground) abnormally contains metallic components (i.e. possibly due to subway construction).
- There is a fixed object near the vehicle, such as sound barriers, guardrails, central dividers, entry barriers, street lamps, signs, tunnels, walls, etc. (including double structures)
- Driving in large areas where there are few vehicles or structures (i.e. desert, meadow, suburb, etc.)
- Driving through a narrow road where trees or grass are overgrown
- Driving on a wet road surface, such as a puddle on the road
- The other vehicle drives very close behind your vehicle, or the other vehicle passes by your vehicle in close proximity
- The speed of the other vehicle is very fast that it passes by your vehicle in a short time
- Your vehicle passes by the other vehicle
- Your vehicle changes lanes
- Your vehicle has started at the same time as the vehicle next to you and has accelerated
- The vehicle in the next lane moves two lanes away from you, or when the vehicle two lanes away moves to the next lane from you

- A trailer or carrier is installed around the rear corner radar
- The bumper around the rear corner radar is covered with objects, such as a bumper sticker, bumper guard, bike rack, etc.
- The bumper around the rear corner radar is impacted, damaged or the radar is out of position
- Your vehicle height is low or high due to heavy loads, abnormal tire pressure, etc.

Blind-Spot Collision-Avoidance Assist may not operate normally, or the function may operate unexpectedly when the following objects are detected:

- A motorcycle or bicycle is detected
- A vehicle such as a flat trailer is detected
- A big vehicle such as a bus or truck is detected
- A moving obstacle such as a pedestrian, animal, shopping cart or a baby stroller is detected
- A vehicle with low height such as a sports car is detected

Braking control may not work, driver's attention is required in the following circumstances:

- The vehicle severely vibrates when driving on a bumpy, uneven or concrete road
- Driving on a slippery surface due to snow, water puddle, ice, etc.

- The tire pressure is low or a tire is damaged
- The brake is reworked
- The vehicle makes abrupt lane changes

⚠ CAUTION

For more details on the limitations of the front view camera, refer to "Forward Collision-Avoidance Assist (FCA) (Sensor fusion)" on page 5-52.

⚠ WARNING

Driving on a curved load



Blind-Spot Collision-Avoidance Assist may not operate properly when driving on a curved road. The function may not detect the vehicle in the next lane.

Always pay attention to road and driving conditions while driving.



Blind-Spot Collision-Avoidance Assist may not operate properly when driving on the curved road. The function may recognize the vehicle in the same lane.

Always pay attention to road and driving conditions while driving.

Driving where the road is merging/dividing



Blind-Spot Collision-Avoidance Assist may not operate properly when driving where the road merges or divides. The function may not detect the vehicle in the next lane.

Always pay attention to road and driving conditions while driving.

Driving on a sloped road

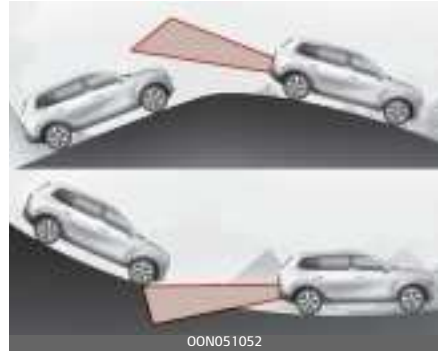

Blind-Spot Collision-Avoidance Assist may not operate properly when driving on a sloped road. The function may not detect the vehicle in the next lane or may incorrectly detect the ground or structure.

Always pay attention to road and driving conditions while driving.

Driving where the heights of the lanes are different

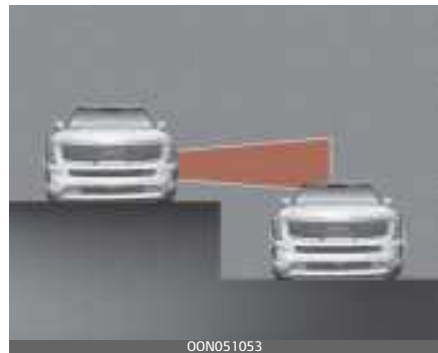

Blind-Spot Collision-Avoidance Assist may not operate properly when driving where the heights of

the lanes are different. The function may not detect the vehicle on a road with different lane heights (under-pass joining section, grade separated intersections, etc.).

Always pay attention to road and driving conditions while driving.

WARNING

- When you are towing a trailer or another vehicle, make sure that you turn off Blind-Spot Collision-Avoidance Assist.
- Blind-Spot Collision-Avoidance Assist may not operate normally if interfered by strong electromagnetic waves.
- Blind-Spot Collision-Avoidance Assist may not operate for 15 seconds after the vehicle is started, or the rear corner radars are initialized.

This device complies with Industry Canada licence-exempt RSS standard(s).

Operation is subject to the following two conditions:

1. This device may not cause interference, and
2. This device must accept any interference, including interference that may cause undesired operation of the device.

Driver Attention Warning (DAW)

Basic function

Driver Attention Warning will determine the driver's attention level by analyzing driving pattern, driving time, etc. while driving. Driver Attention Warning will recommend a break when the driver's attention level falls below a certain level to help drive safely.

Leading vehicle departure alert

Leading vehicle departure alert will inform the driver when the front vehicle departs from a stop.

NOTICE

DAW stands for Driver Attention Warning.

Detecting sensor



[1]: Front view camera

The front view camera is used as a detecting sensor to detect driving patterns and front vehicle departure while vehicle is being driven.

Refer to the picture above for the detailed location of the detecting sensor.

⚠ CAUTION

Always keep the front view camera in good condition to maintain optimal performance of Driver Attention Warning.

For more details on the precautions of the front view camera, refer to "Forward Collision-Avoidance Assist (FCA) (Sensor fusion)" on page 5-52.

Driver Attention Warning Settings

Setting features

Driver Attention Warning



- With the ENGINE START/STOP button in the ON position, press MODE button (⏸) several times on the steering wheel until 'User Settings' menu appears on the LCD display. Select 'Driver Assistance → Driver Attention Warning' from the setting menu to set whether or not to use each function.
- If 'Low Activity Warning' is selected, the function will inform the driver the driver's attention level and will recommend taking a break when the level falls below a certain level.

Leading vehicle departure alert



If 'Leading vehicle departure alert' is selected from 'Driver Assistance → Driving Assist', the function will inform the driver when the front vehicle departs from a stop.

Warning Timing

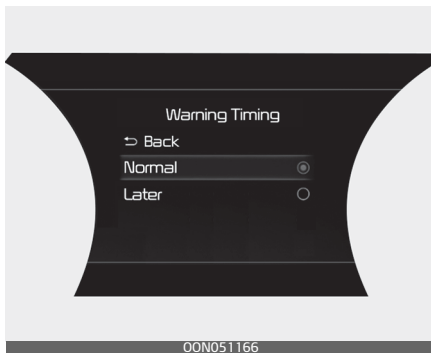

With the ENGINE START/STOP button in the ON position, press MODE button (⏏) several times on the steering wheel until 'User Settings' menu appears on the LCD display. Select 'Driver Assistance → Warning Timing' to change the initial warning

activation time for Driver Attention Warning.

When the vehicle is first delivered, warning timing is set to 'Normal'. If you change the warning timing, the warning time of other Driver Assistance system may change.

* NOTICE

If the engine is restarted, Driver Attention Warning will maintain the last setting.

Driver Attention Warning Operation

Basic function

Display and warning

The basic function of Driver Attention Warning is to inform the driver the 'Attention Level' and to warn the driver 'Consider taking a break'.

Attention level

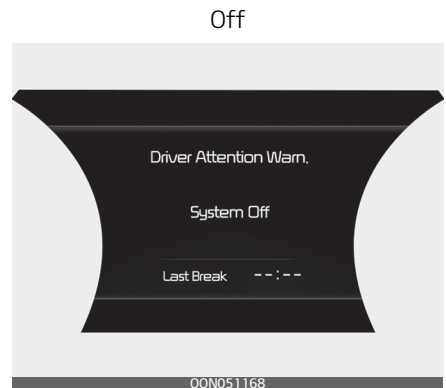

Standby

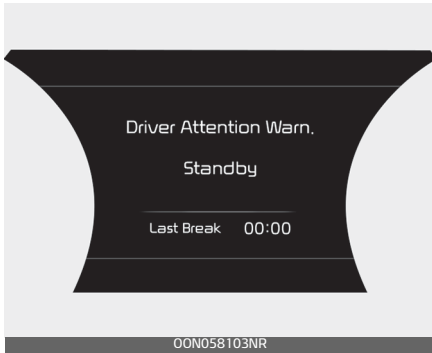

Attentive driving

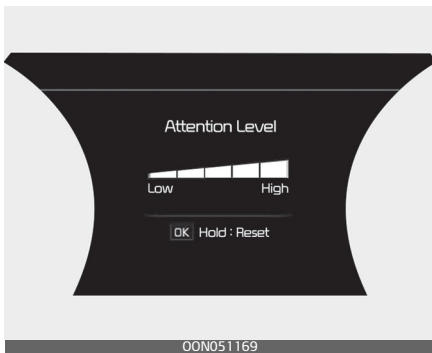

Inattentive driving

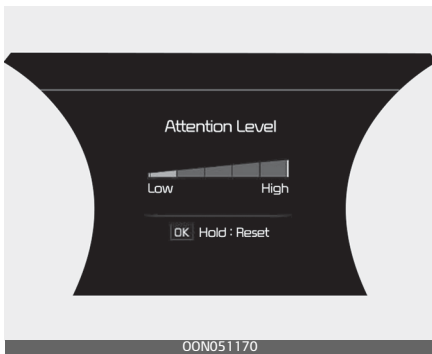

- The driver can monitor his/her driving conditions on the cluster.

- When the 'Inattentive Driving Warning' is deselected from the setting menu, 'Off' is displayed.
- Driver Attention Warning will operate when vehicle speed is between 0~180 km/h (0~110 mph).
- When vehicle speed is not within the operating speed, the message 'Standby' will be displayed.
- The driver's attention level is displayed on the scale of 1 to 5. The lower the level is, the more inattentive the driver is.
- The level decreases when the driver does not take a break for a certain period of time.

Taking a break



- The 'Consider taking a break' message will appear on the cluster and an audible warning will sound to suggest that the driver take a break, when the driver's attention level is below 1.

- Driver Attention Warning will not suggest a break when the total driving time is shorter than 10 minutes or 10 minutes has not passed after the last break was suggested.

⚠ WARNING

For your safety, change the Settings after parking the vehicle at a safe location.

⚠ CAUTION

- Driver Attention Warning may suggest a break depending on the driver's driving pattern or habits, even if the driver doesn't feel fatigue.
- Driver Attention Warning is a supplemental function and may not be able to determine whether the driver is inattentive.
- The driver who feels fatigued should take a break at a safe location, even though there is no break suggestion by Driver Attention Warning.

*** NOTICE**

- For more details on setting the functions in the infotainment system, refer to "Instrument cluster" on page 4-71.

- Driver Attention Warning will reset the last break time to 00:00 in the following situations:
 - The engine is turned off
 - The driver unfastens the seat belt and opens the driver's door.
 - The vehicle is stopped for more than 10 minutes.
- When the driver resets Driver Attention Warning, the last break time is set to 00:00 and the driver's attention level is set to High.

Leading vehicle departure alert



While Smart Cruise Control is in operation if your vehicle stops behind the vehicle in front, the vehicle in front depart from a stop, Leading vehicle departure alert will inform the driver by displaying the 'Leading vehicle is driving away' message on the cluster and an audible warning will sound.

⚠ WARNING

- If any other function's warning message is displayed or audible warning is generated, Leading vehicle departure alert Warning message may not be displayed and audible warning may not be generated.
- The driver should hold the responsibility to safely drive and control the vehicle.

⚠ CAUTION

- Leading vehicle departure alert is a supplemental function and may not warn the driver whenever the front vehicle departs from a stop.
- Always check the front of the vehicle and road conditions before departure.

Driver Attention Warning Malfunction and Limitations***Driver Attention Warning malfunction***

When Driver Attention Warning is not working properly, the 'Check Driver Attention Warning (DAW) system' warning message will appear on the cluster (turns off after a certain time) and (⚠) warning light will illuminate. In this case, have your vehicle inspected by an authorized Kia dealer.

Limitations of Driver Attention Warning

Driver Attention Warning may not work properly in the following situations:

- The vehicle is driven aggressively
- The vehicle intentionally crosses over lanes frequently
- The vehicle is controlled by Driver Assistance system, such as Lane Keeping Assist.

Leading vehicle departure alert

- When the vehicle cuts in

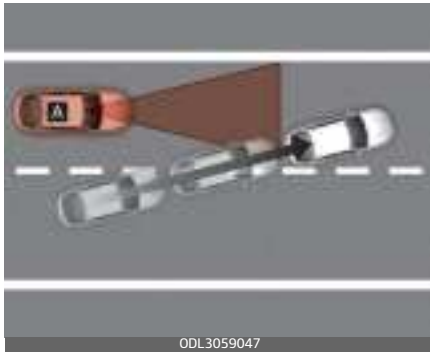

[A]: Your vehicle, [B]: Front vehicle

If a vehicle cuts in front of your vehicle, Leading vehicle departure alert may not operate properly.

- When the vehicle ahead sharply steers



[A] : Your vehicle, [B] : Front vehicle

If the vehicle in front makes a sharp turn, such as to turn left or right or make a U- turn, etc., Leading vehicle departure alert may not operate properly.

- When the vehicle ahead abruptly departs

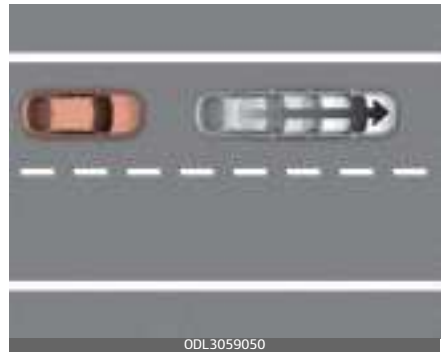

If the vehicle in front abruptly departs, Leading vehicle departure alert may not operate properly.

- When a pedestrian or cyclist is between you and the vehicle ahead



If there is a pedestrian or cyclist in between you and the vehicle in front, Leading vehicle departure alert may not operate properly.

- When in a parking lot

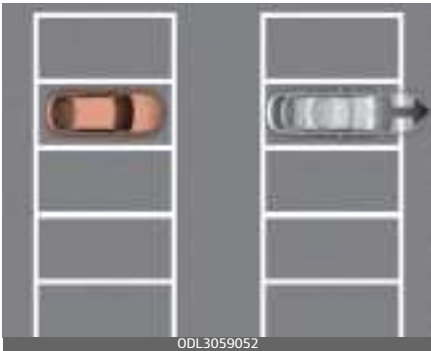

If a vehicle parked in front drives away from you, Leading vehicle departure alert may warn you that the parked vehicle is driving away.

- When driving at a tollgate or intersection, etc.

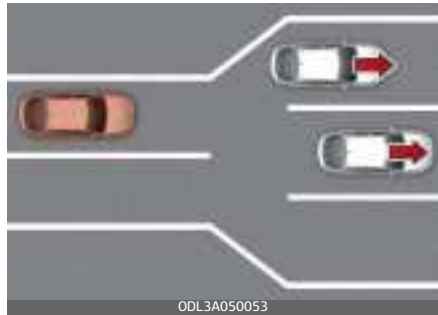

If you pass a tollgate or intersection with lots of vehicles or you drive where lanes are merged or divided frequently, Leading vehicle departure alert may not operate properly.

⚠ CAUTION

For more details on the precautions of the front view camera, refer to "Forward Collision-Avoidance Assist (FCA) (Sensor fusion)" on page 5-52.

Smart Cruise Control (SCC)

Smart Cruise Control allows you to program the vehicle to maintain constant speed and distance detecting the vehicle ahead without depressing the accelerator or brake pedal.

Detecting sensor



OON051182



OON051181

[1]: Front view camera, [2]: Front radar

The front view camera and front radar are used as a detecting sensor to detect front vehicles.

Refer to the picture above for the detailed location of the detecting sensor.

⚠ CAUTION

Always keep the front view camera and front radar in good condition to maintain optimal performance of Smart Cruise Control.

For more details on the precautions of the front view camera and front radar, refer to "Forward Collision-Avoidance Assist (FCA) (Sensor fusion)" on page 5-52.

Smart Cruise Control Settings

Setting features

To turn on Smart Cruise Control



OON051029

1. Press the Driving Assist button, to turn the function on. The CRUISE indicator in the instrument cluster will illuminate.
2. Accelerate to the desired speed. The set speed can be set as follows:
 - 10 km/h (5 mph) ~ 170 km/h (110 mph): when there is no vehicle in front

- 0 km/h (0 mph) ~ 160 km/h (100 mph): when there is a vehicle in front

3. Push the SET- switch down, and release it at the desired speed. The set speed and vehicle to vehicle distance on the LCD screen will illuminate.



4. Release the accelerator pedal. The desired speed will automatically be maintained. If there is a vehicle in front of you, the speed may decrease to maintain the distance to the vehicle ahead. On a steep grade, the vehicle may slow down or speed up slightly while going uphill or downhill.

*** NOTICE**

Vehicle speed may decrease on an upward slope and increase on a downward slope.

To set vehicle distance



Each time the vehicle distance button is pressed, the vehicle distance changes as follows:

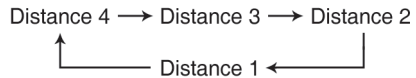

*** NOTICE**

- If you drive at 90 km/h (56 mph), the distance is maintained as follows:
 - Distance 4 - approximately 52.5 m (172 ft.)
 - Distance 3 - approximately 40 m (130 ft.)
 - Distance 2 - approximately 32.5 m (106 ft.)
 - Distance 1 - approximately 25 m (82 ft.)
- The distance is set to the last set distance when the engine is restarted, or when Smart Cruise Control was temporarily canceled.

To increase speed

- Push the RES+ switch up, and release it immediately. The cruising speed will increase by 1 km/h (1 mph) each time the switch is operated in this manner.
- Push the RES+ switch up, and hold it while monitoring the set speed on the cluster. The cruising speed will increase by 10 km/h or 5 mph each time the switch is operated in this manner. Release the switch when the desired speed is shown, and the vehicle will accelerate to that speed. You can set the speed to 170 km/h (110 mph).

To decrease speed

- Push the SET- switch down, and release it immediately. The cruising speed will decrease by 1 km/h (1 mph) each time the switch is operated in this manner.
- Push the SET- switch down, and hold it while monitoring the set speed on the cluster. The cruising speed will decrease by 10 km/h or 5 mph each time the switch is operated in this manner.
- Release the switch at the speed you want to maintain. You can set the speed to 30 km/h (20 mph).

⚠ WARNING

Check the driving condition before using the RES+ switch. Driving speed may sharply increase when you push up and hold the RES+ switch.

To temporarily cancel Smart Cruise Control

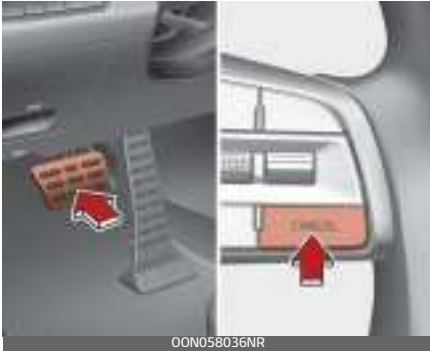

Press the CANCEL button or depress the brake pedal to temporarily cancel Smart Cruise Control.

To resume Smart Cruise Control



- If any method other than the RES+ or SET- switch was used to cancel cruising speed and Smart Cruise Control is still activated, the set speed will automatically resume when you push the RES+ or SET- switch up or down.
- If you push the RES+ switch up, the speed will resume to the recently set speed. However, if

vehicle speed drops below 10 km/h (5 mph), it will resume when there is a vehicle in front of your vehicle.

*** NOTICE**

Always check the road conditions when you push the switch up (to RES+) to resume speed.

To turn off Smart Cruise Control



Press the Driving Assist button to turn Smart Cruise Control off.

To adjust the sensitivity of Smart Cruise Control

SCC Reaction

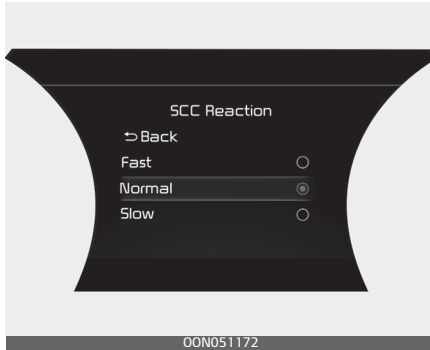

The sensitivity of vehicle speed when following the front vehicle to maintain the set distance can be adjusted. Go to the "User Settings → Driver Assistance → SCC Reaction → Fast/Normal/Slow". You may select one of the three stages you prefer.

Converting to Cruise Control mode

The driver may choose to only use the cruise control mode (speed control function) by doing as follows:

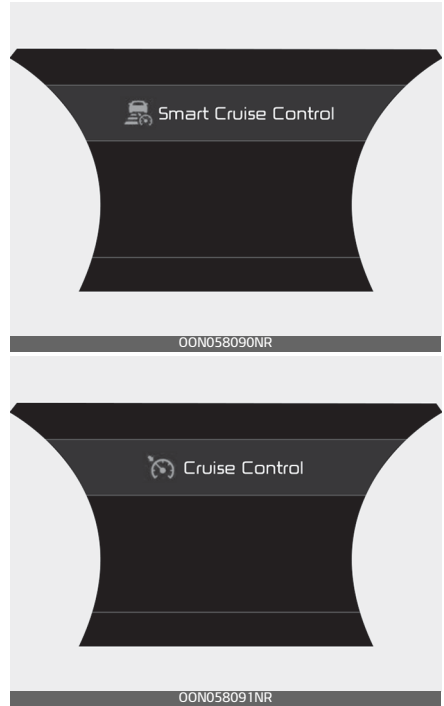

1. Turn Smart Cruise Control on (the cruise indicator light will be on but the function will not be activated).
2. Push and hold the vehicle distance button for more than 2 seconds.
3. Choose between "Smart Cruise Control" and "Cruise Control".
When the function is canceled using the Driving Assist button or the Driving Assist button is used after the vehicle is turned on, the Smart Cruise Control will turn on.

Warning Volume

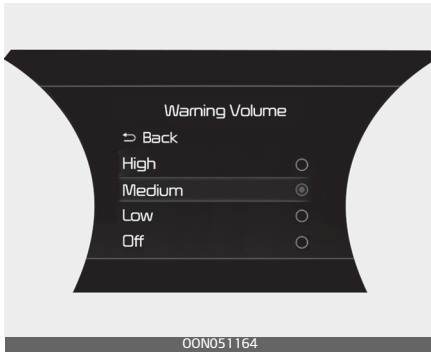

With the ENGINE START/STOP button in the ON position, press MODE button () several times on the steering wheel until 'User Settings' menu appears on the LCD display. Select 'Driver Assistance → Warning Volume' to change the warning volume to 'High', 'Medium', 'Low' or 'Off' for Smart Cruise Control.

If you change the Warning Volume, the Warning Volume of other Driver Assistance system may change.

* NOTICE

If the engine is restarted, Warning Volume will maintain the last setting.

Smart Cruise Control Operation

Operating conditions

Smart Cruise Control will operate when the following conditions are satisfied.

Basic function

- The gear is in D (Drive)
- The driver's door is closed
- EPB (Electronic Parking Brake) is not applied
- Your vehicle speed is within the operating speed range
 - 10~170 km/h (5~110 mph): when there is no vehicle in front
 - 0~160 km/h (0~100 mph): when there is a vehicle in front
- ESC (Electronic Stability Control), TCS (Traction Control System) or ABS is on
- ESC (Electronic Stability Control), TCS (Traction Control System) or ABS is not controlling the vehicle
- Engine rpm is not in the red zone
- Forward Collision-Avoidance Assist brake control is not operating
- ISG system is not operating

* NOTICE

At a stop, if there is vehicle in front of your vehicle, the function will turn on when the brake pedal is depressed.

Smart Cruise Control Display and Control

Basic function

Operating

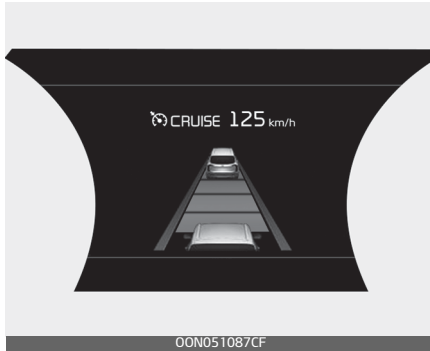

Temporarily canceled

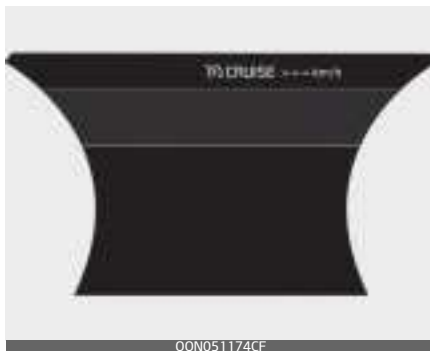

You can see the status of the Smart Cruise Control operation in the Driving Assist view on the cluster. Refer to "Instrument cluster" on page 4-71.

To temporarily accelerate



If you want to speed up temporarily when Smart Cruise Control is on, depress the accelerator pedal for a certain amount. While depressing the accelerator pedal for a certain amount, the set speed will blink on the cluster. However, if the accelerator pedal is insufficiently depressed, the vehicle may slow down.

⚠ WARNING

Be careful when accelerating temporarily, because the speed is not controlled automatically even if there is a vehicle in front of you.

Smart Cruise Control temporarily canceled



Smart Cruise Control will be temporarily canceled automatically when:

- The vehicle speed is above 170 km/h (110 mph)
- The vehicle is stopped for a certain period of time
- The accelerator pedal is continuously depressed for a certain period of time
- The conditions for Smart Cruise Control to operate is not satisfied

If Smart Cruise Control is temporarily canceled, the 'Smart Cruise Control canceled' warning message will appear on the cluster, and an audible warning will sound to warn the driver.

⚠ WARNING

When Smart Cruise Control is temporarily canceled, distance with the front vehicle will not be maintained. Always have your eyes on the road while driving, and if necessary,

depress the brake pedal to reduce your driving speed in order to maintain a safe distance.

Smart Cruise Control conditions not satisfied



If the Driving Assist button, RES+, SET- switch is pushed when Smart Cruise Control operating conditions are not satisfied, the 'Smart Cruise Control conditions not met' will appear on the cluster, and an audible warning will sound.

In traffic situation



In traffic, your vehicle will stop if the vehicle ahead of you stops. Also, if the vehicle ahead of you starts moving, your vehicle will start as well. In addition, after the vehicle has stopped and a certain time has passed, the 'Use switch or pedal to accelerate' message will appear on the cluster. Depress the accelerator pedal or push the RES+ switch up or push the SET- switch down to start driving.

Warning road conditions ahead



In the following situation, the 'Watch for surrounding vehicles' warning message will appear on the cluster, and an audible warning will sound to warn the driver of road conditions ahead.

The vehicle in front disappears when Smart Cruise Control is maintaining the distance with the vehicle ahead while driving in low speed.

⚠ WARNING

Always pay attention to vehicles or objects that may suddenly appear in front of you, and if necessary, depress the brake pedal to reduce your driving speed in order to maintain a safe distance.

Collision Warning



While Smart Cruise Control is operating, when the collision risk with the vehicle ahead is high, the 'Collision Warning' warning message will appear on the cluster, and an audible warning will sound to warn the driver. Always have your eyes on the road while driving, and if necessary, depress the brake pedal to reduce your driving speed in order to maintain a safe distance.

⚠ WARNING

- In the following situations, Smart Cruise Control may not warn the driver of a collision.

- The distance from the front vehicle is near, or the vehicle speed of the other vehicle is faster or similar with your vehicle
 - The speed of the front vehicle is very slow or is at a standstill
 - The accelerator pedal is depressed right after Smart Cruise Control is turned on
- Keep a safe distance according to road conditions and vehicle speed. If the vehicle distance is too close during high-speed driving, a serious collision may result.
 - When maintaining distance with the vehicle ahead, if the front vehicle disappears, Smart Cruise Control may suddenly accelerate to the set speed. Always be aware of unexpected and sudden situations from occurring.
 - Vehicle speed may decrease on an upward slope and increase on a downward slope.
 - Always be aware of situations such as when a vehicle cuts in suddenly.
 - When you are towing a trailer or another vehicle, we recommend that Smart Cruise Control is turned off due to safety reasons.
 - Turn off Smart Cruise Control when your vehicle is being towed.
 - Smart Cruise Control may not operate normally if interfered by strong electromagnetic waves.
 - Smart Cruise Control may not detect an obstacle in front and lead to a collision. Always look ahead cautiously to prevent unexpected and sudden situations from occurring.
 - Vehicles moving in front of you with a frequent lane change may cause a delay in the function's reaction or may cause the function to react to a vehicle actually

WARNING

Take the following precautions when using Smart Cruise Control :

- Smart Cruise Control does not substitute for proper and safe driving. It is the responsibility of the driver to always check the speed and distance to the vehicle ahead.
- Smart Cruise Control may not recognize unexpected and sudden situations or complex driving situations, so always pay attention to driving conditions and control your vehicle speed.
- Keep Smart Cruise Control off when the function is not in use to avoid inadvertently setting a speed.
- Do not open the door or leave the vehicle when Smart Cruise Control is operating, even if the vehicle is stopped.
- Always be aware of the selected speed and vehicle distance.

in an adjacent lane. Always drive cautiously to prevent unexpected and sudden situations from occurring.

- Always be aware of the surroundings and drive safely, even though a warning message does not appear or an audible warning does not sound.
- If any other function's warning message is displayed or warning sound is generated, Smart Cruise Control warning message may not be displayed and warning sound may not be generated.
- You may not hear the warning sound of Forward Collision-Avoidance Assist if the surrounding is noisy.
- The vehicle manufacturer is not responsible for any traffic violation or accidents caused by the driver.
- Always set the vehicle speed under the speed limit in your state.

* NOTICE

- Smart Cruise Control may not operate in few seconds after the vehicle is started or the front view camera or front radar is initialized.
- You may hear a sound when the brake is controlled by Smart Cruise Control.

Smart Cruise Control Malfunction and Limitations

Smart Cruise Control malfunction



The message will appear when Smart Cruise Control is not functioning normally. In this case, take your vehicle to an authorized Kia dealer and have the function checked.

Smart Cruise Control disabled



When the front radar cover or sensor is covered with snow, rain, or foreign matters, it can reduce the detecting performance and tempo-

rarily limit or disable Smart Cruise Control.

If this occurs the 'Smart Cruise Control disabled. Radar blocked.' warning message, and warning lights will illuminate on the cluster.

Smart Cruise Control will operate normally when such snow, rain or foreign matter is removed.

⚠ WARNING

Even though the warning message does not appear on the cluster, Smart Cruise Control may not properly operate.

⚠ CAUTION

Smart Cruise Control may not properly operate in an area (e.g. open terrain), where any substance are not detected after turning ON the engine.

Limitations of Smart Cruise Control

Smart Cruise Control may not operate normally, or the function may operate unexpectedly under the following circumstances:

- The detecting sensor or the surroundings are contaminated or damaged
- Washer fluid is continuously sprayed, or the wiper is on
- The camera lens is contaminated due to tinted, filmed or coated windshield, damaged glass, or stuck of foreign matters (sticker, bug, etc.) on the glass
- Moisture is not removed or frozen on the windshield
- The field of view of the front view camera is obstructed by sun glare
- Street light or light from an oncoming vehicle is reflected on the wet road surface, such as a puddle on the road
- The temperature around the front view camera is high or low
- An object is placed on the dashboard
- The surrounding is very bright
- The surrounding is very dark, such as in a tunnel, etc.
- The brightness changes suddenly, for example when entering or exiting a tunnel
- The brightness outside is low, and the headlamps are not on or are not bright
- Driving in heavy rain or snow, or thick fog
- Driving through steam, smoke or shadow
- Only part of the vehicle is detected
- The vehicle in front has no tail lights, tail lights are located unusually, etc.
- The brightness outside is low, and the tail lamps are not on or are not bright

- The rear of the front vehicle is small or does not look normal (i.e. tilted, overturned, etc.)
- The front vehicle's ground clearance is low or high
- Your vehicle is being towed
- A vehicle suddenly cuts in front
- Driving through a tunnel or railroad bridge
- A material is near that reflects very well on the front radar, such as a guardrail, nearby vehicle, etc.
- The bumper around the front radar is impacted, damaged or the front radar is out of position
- The temperature around the front radar is high or low
- Driving in large areas where there are few vehicles or structures (i.e. desert, meadow, suburb, etc.)
- The vehicle in front is made of material that does not reflect on the front radar
- Driving near a highway (or motorway) interchange or tollgate
- Driving on a slippery surface due to snow, water puddle, ice, etc.
- Driving on a curved road
- The vehicle in front is detected late
- The vehicle in front is suddenly blocked by an obstacle
- The vehicle in front suddenly changes lane or suddenly reduces speed
- The vehicle in front is bent out of shape
- The front vehicle's speed is fast or slow
- With a vehicle in front, your vehicle changes lane at low speed
- The vehicle in front is covered with snow
- You are driving unstably
- You are on a roundabout and the vehicle in front is not detected
- You are continuously driving in a circle
- Driving in a parking lot
- Driving through a construction area, unpaved road, partial paved road, uneven road, speed bumps, etc.
- Driving on an incline road, curved road, etc.
- Driving through a roadside with trees or streetlights
- The adverse road conditions cause excessive vehicle vibrations while driving
- Your vehicle height is low or high due to heavy loads, abnormal tire pressure, etc.
- Driving through a narrow road where trees or grass are overgrown
- There is interference by electromagnetic waves, such as driving in an area with strong radio waves or electrical noise



- **Driving on a curved road**

On curves, Smart Cruise Control may not detect a vehicle in the same lane, and may accelerate to the set speed. Also, vehicle speed may rapidly decrease when the vehicle ahead is detected suddenly.

Select the appropriate set speed on curves and apply the brake pedal or accelerator pedal according to the road and driving conditions ahead.



Your vehicle speed can be reduced due to a vehicle in the adjacent lane.

Apply the accelerator pedal and select the appropriate set speed.

Check to be sure that the road conditions permit safe operation of Smart Cruise Control.



- **Driving on a sloped road**

During uphill or downhill driving, Smart Cruise Control may not detect a moving vehicle in your lane, and cause your vehicle to accelerate to the set speed. Also, vehicle speed will rapidly decrease when the vehicle ahead is detected suddenly.

Select the appropriate set speed on inclines and apply the brake pedal or accelerator pedal according to the road and driving conditions ahead.

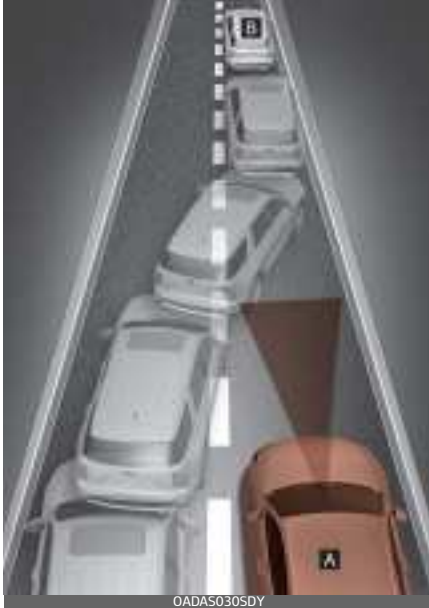

• Changing lanes

[A]: Your vehicle, [B]: Lane changing vehicle

When a vehicle moves into your lane from an adjacent lane, it cannot be detected by the sensor until it is in the sensor's detection range.

Smart Cruise Control may not immediately detect the vehicle when the vehicle changes lanes abruptly. In this case, you must maintain a safe braking distance, and if necessary, depress the brake pedal to reduce your driving speed in order to maintain a safe distance.

• Detecting vehicle



In the following cases, some vehicles in your lane cannot be detected by the sensor:

- Vehicles offset to one side
- Slow-moving vehicles or sudden-decelerating vehicles
- Oncoming vehicles
- Stopped vehicles
- Vehicles with small rear profile, such as trailers
- Narrow vehicles, such as motorcycles or bicycles
- Special vehicles
- Animals and pedestrians



In the following cases, the vehicle in front cannot be detected by the sensor:

- Vehicles with higher clearance or vehicles carrying loads that stick out of the back of the vehicle
- Vehicles that has the front lifted due to heavy loads
- You are steering your vehicle
- Driving on narrow or sharply curved roads

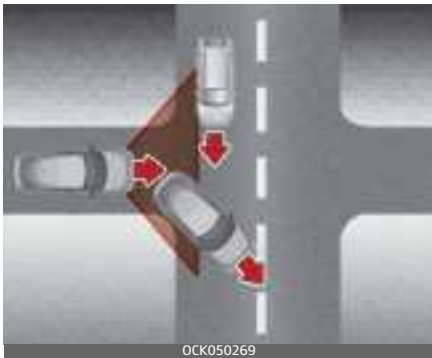

When a vehicle ahead disappears at an intersection, your vehicle may accelerate. Always pay attention to road and driving conditions while driving.



When a vehicle in front of you merges out of the lane, Smart Cruise Control may not immediately detect the new vehicle that is now in front of you. Always pay attention to road and driving conditions while driving.



Always look out for pedestrian when your vehicle is maintaining a distance with the vehicle ahead.

This device complies with Industry Canada licence-exempt RSS standard(s).

Operation is subject to the following conditions:

1. This device may not cause interference, and
2. This device must accept any interference, including interference that may cause undesired operation of the device.
3. Changes or modifications not expressly approved by the party responsible for compliance could void the user's authority to operate the device.

Navigation-based Smart Cruise Control (NSCC) (if equipped)

Navigation-based Smart Cruise Control will help automatically adjust vehicle speed when driving on highways (or motorways) with speed limits by using road information from the navigation system while Smart Cruise Control is operating.

*** NOTICE**

- Navigation-based Smart Cruise Control is available only on controlled access road of certain highways.
 - * Controlled access road indicates roads with limited entrances and exits that allow uninterrupted high speed traffic flow. Only passenger cars and motorcycles are allowed on controlled access roads.
- Additional highways may be expanded by future navigation updates.

*** NOTICE**

Navigation-based Smart Cruise Control operates on main roads of highways (or motorways), and does not operate on interchanges or junctions.

Highway Auto Curve Slowdown

If vehicle speed is high, Highway Auto Curve Slowdown function will temporarily decelerate your vehicle to help you drive safely on a curve, based on the curve information from the navigation.

Navigation-based Smart Cruise Control Settings

Setting features



Highway Auto Curve Slowdown

- With the ENGINE START/STOP button in the ON position, press MODE button (⏏) several times on the steering wheel until 'User Settings' menu appears on the LCD display. Select 'Driver Assistance → Driving Assist → Highway Auto Curve Slowdown' from the setting menu to set whether or not to use each function.

* NOTICE

When there is a problem with Navigation-based Smart Cruise Control, the function cannot be set from the settings menu.

Navigation-based Smart Cruise Control Operation

Operating conditions

Navigation-based Smart Cruise Control is ready to operate if all of the following conditions are satisfied:

- Smart Cruise Control is operating
- Driving on main roads of highways (or motorways)

* NOTICE

For more details on how to operate Smart Cruise Control, refer to "Smart Cruise Control (SCC)" on page 5-91.

Display and control

When Navigation-based Smart Cruise Control operates, it will be displayed on the cluster as follows:

Navigation-based Smart Cruise Control standby



If the operating conditions are satisfied, the white (AUTO) indicator will illuminate.

Navigation-based Smart Cruise Control operating



If temporary deceleration is required in the standby state and Navigation-based Smart Cruise Control is operating, the green (AUTO) symbol will illuminate on the cluster.

⚠ WARNING

'Drive carefully' warning message will appear in the following circumstances:

- Navigation-based Smart Cruise Control is not able to slow down your vehicle to a safe speed.

*** NOTICE**

Highway Auto Curve Slowdown uses the same (AUTO) symbol.

Highway Auto Curve Slowdown

- Depending on the curve ahead on the highway (or motorway), the vehicle will decelerate, and after passing the curve, the vehicle will accelerate to Smart Cruise Control set speed.
- Vehicle deceleration time may differ depending on the vehicle speed and the degree of the curve on the road. The higher the driving speed, the faster the vehicle will decelerate.

Limitations of Navigation-based Smart Cruise Control

Navigation-based Smart Cruise Control may not operate normally under the following circumstances:

- The navigation is not working properly.

- The navigation is not updated to include the latest information about road curvature and changes.
- Speed limit and road information in the navigation is not updated
- The map information and the actual road is different because of real-time GPS data or map information error
- The navigation searches for a route while driving
- GPS signals are blocked in areas such as a tunnel
- A road that divides into two or more roads and joins again
- The driver goes off course the route set in the navigation
- The route to the destination is changed or canceled by resetting the navigation (including TPEG change)
- The navigation cannot detect the current vehicle position (ex: elevated roads including overpass adjacent to general roads or nearby roads exist in a parallel way)
- The vehicle enters a service station or rest area
- The speed limit of some sections changes depending on the road situations
- Android Auto or Car Play is operating
- The navigation is being updated while driving

- The navigation is being restarted while driving



[1]: Driving route, [2]: Set route, [3]: Main road, [4]: Branch line

- When there is a difference between the navigation set route (branch line) and the driving route (main road), Highway Auto Curve Slowdown function may not operate until the driving route is recognized as the main road.
- When the vehicle's driving route is recognized as the main road by maintaining the main road instead of the navigation set route, Highway Auto Curve Slowdown function will operate. Depending on the distance to the curve and the current vehicle speed, vehicle deceleration may not be sufficient or may decelerate rapidly.



[1]: Driving route, [2]: Main road, [3]: Set route, [4]: Branch line

- When there is a difference between the navigation route (main road) and the driving route (branch line), Highway Auto Curve Slowdown function may temporarily operate due to the navigation information of the highway curve section.
- When it is judged that you are driving out of the route by entering the highway interchange and junction, Highway Auto Curve Slowdown function will not operate.



[1]: Driving route, [2]: Main road, [3]: Branch line

- If there is no destination set on the navigation, Highway Auto Curve Slowdown function will operate based on the curve information on the main road.
- Even if you depart from the main road, Highway Auto Curve Slowdown function may temporarily operate due to navigation information of the highway curve section.

⚠ WARNING

- Navigation-based Smart Cruise Control is not a substitute for safe driving practices, but a convenience function. Always have your eyes on the road, and it is the responsibility of the driver to avoid violating traffic laws.
- The navigation's speed limit information may differ from the actual speed limit information on the road. It is the driver's respon-

sibility to check the speed limit on the actual driving road or lane.

- Highway Auto Curve Slowdown will automatically cancel when you leave the main road of the highway. Always pay attention to road and driving conditions while driving.
- Navigation-based Smart Cruise Control may not operate due to the existence of leading vehicles and the driving conditions of the vehicle. Always pay attention to road and driving conditions while driving.
- When you are towing a trailer or another vehicle, we recommend that Navigation-based Smart Cruise Control is turned off due to safety reasons.
- After you pass through a tollgate on a highway, Navigation-based Smart Cruise Control operates based on the first lane. If you enter one of the other lanes, the function might not properly decelerate.
- The vehicle will accelerate if the driver depresses the accelerate pedal while Navigation-based Smart Cruise Control is operating, and function will not decelerate the vehicle. However, if the accelerator pedal is insufficiently depressed, the vehicle may slow down.
- If the driver accelerates and releases the accelerator pedal

while Navigation-based Smart Cruise Control is operating, the vehicle may not decelerate sufficiently or may rapidly decelerate to a safe speed.

- If the curve is too large or too small, Navigation-based Smart Cruise Control may not operate.

*** NOTICE**

- When the function is activated, the vehicle decelerates automatically before reaching the curved road according to its curvature, and the driving speed returns to the speed set by Smart Cruise Control after passing the curved section.
- The speed information on the cluster and navigation may differ.
- The time gap could occur between the navigation's guidance and when Navigation-based Smart Cruise Control operation starts and ends.
- Even if you are driving at a speed lower than Smart Cruise Control set speed, acceleration may be limited by curve sections ahead.
- If Navigation-based Smart Cruise Control is operating while leaving the main road to enter an interchange, junction, rest area, etc., the function may operate for a certain period of time.
- Deceleration by Navigation-based Smart Cruise Control may not be

sufficient due to road conditions such as uneven road surfaces, narrow lanes, etc.

Lane Following Assist (LFA)

Lane Following Assist is designed to detect lane markings or vehicles on the road, and assists the driver's steering to help keep the vehicle between lanes.

* NOTICE

LFA stands for Lane Following Assist.

Detecting sensor



[1]: Front view camera

The front view camera is used as a detecting sensor to detect lane markings and front vehicles.

Refer to the picture above for the detailed location of the detecting sensor.

⚠ CAUTION

For more details on the precautions of the front view camera, refer to "Forward Collision-Avoid-

ance Assist (FCA) (Sensor fusion)" on page 5-52.

Lane Following Assist Settings

Setting features

Turning Lane Following Assist ON/OFF

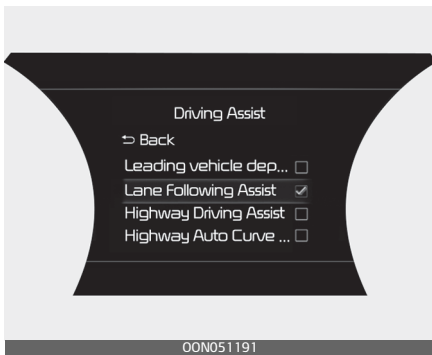

With the ENGINE START/STOP button in the ON position, press MODE button (⏏) several times on the steering wheel until 'User Settings' menu appears on the LCD display. Select 'Driver Assistance → Driving Assist → Lane Following Assist' from the setting menu to set whether or not to use each function.

Warning Volume

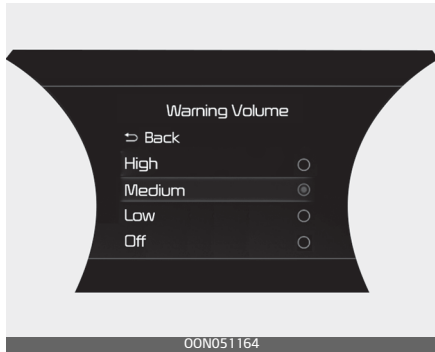

With the ENGINE START/STOP button in the ON position, press MODE button (⏏) several times on the steering wheel until 'User Settings' menu appears on the LCD display. Select 'Driver Assistance → Warning Volume' to change the warning volume to 'High', 'Medium', 'Low' or 'Off' for Lane Following Assist.

If you change the Warning Volume, the Warning Volume of other Driver Assistance system may change.

Lane Following Assist Operation

Warning and control

Lane Following Assist

If the vehicle ahead or both lane markings are detected and your vehicle speed is below 153 km/h (95 mph), the green (Ⓢ) indicator light

will illuminate on the cluster, and the function will help the vehicle stay in lane by controlling the steering wheel.

⚠ CAUTION

When the steering wheel is not controlled, the green (🚗) indicator light will blink and change to white.

Hands-off warning



If the driver takes their hands off the steering wheel for several seconds, the 'Keep hands on steering wheel' warning message will appear and an audible warning will sound in stages.



If the driver still does not have their hands on the steering wheel after the hands-off warning, the 'Driving Convenience systems canceled' warning message will appear and Lane Following Assist will be automatically canceled.

⚠ WARNING

- The steering wheel may not be assisted if the steering wheel is held very tight or the steering wheel is steered over a certain degree.
- Lane Following Assist does not operate at all times. It is the responsibility of the driver to safely steer the vehicle and to maintain the vehicle in its lane.
- The hands-off warning message may appear late depending on road conditions. Always have your hands on the steering wheel while driving.
- If the steering wheel is held very lightly the hands-off warning

message may appear because the function may not recognize that the driver has their hands on the steering wheel.

- If you attach objects to the steering wheel, the hands-off warning may not work properly.

*** NOTICE**

- For more details on setting the functions in the infotainment system, refer to "LCD Display Modes" on page 4-77.
- For more details on how to operate Smart Cruise Control, refer to "Smart Cruise Control (SCC)" on page 5-91.
- When both lane markings are detected, the lane lines on the cluster will change from gray to white.

Lane undetected



Lane detected



- If lane markings are not detected, steering wheel control by Lane Following Assist can be limited depending on whether a vehicle is in front or the driving conditions of the vehicle.
- Even though the steering is assisted by Lane Following Assist, the driver may control the steering wheel.
- The steering wheel may feel heavier or lighter when the steering wheel is assisted by the function than when it is not.

Lane Following Assist Malfunction and Limitations

Lane Following Assist malfunction

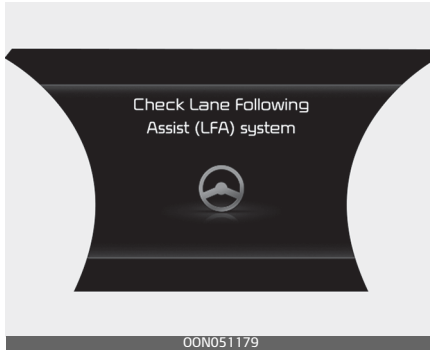

When Lane Following Assist is not working properly, the 'Check Lane Following Assist (LFA) system' warning message will appear on the cluster (turns off after a certain time) and (⚠) warning light will illuminate.

In this case, have the function checked by an authorized Kia dealer.

Highway Driving Assist (HDA) (if equipped)

Highway Driving Assist is designed to control the vehicle distance and speed when driving on the highway. The function assists drivers by receiving information about speed limit of the highway that the vehicle is on and automatically changing the set speed of Smart Cruise Control when it is needed.

⚠ WARNING

- Highway Driving Assist is not a substitute for safe driving practices, but a convenience function. It is the responsibility of the driver to always be aware of the surroundings and drive safely.
- Highway Driving Assist relies entirely on the road information provided by the Infotainment System. It is the responsibility of the driver to follow traffic laws and avoid accidents.
- For your safety, please read the owner's manual before using the function.

Detecting sensor



[1] : Front view camera, [2]: Front radar

Refer to the picture above for the detailed location of the detecting sensors.

⚠ CAUTION

For more details on the precautions of the detecting sensors, refer to "Forward Collision-Avoidance Assist (FCA) (Sensor fusion)" on page 5-52.

* NOTICE

- Highway Driving Assist is available only on controlled access road of certain highways.
 - * Controlled access road indicates roads with limited entrances and exits that allow uninterrupted high speed traffic flow. Only passenger cars, truck and motorcycles are allowed on controlled access roads.

Available highway (Controlled access road)

Canada	Select Provincial and Territorial Highways
--------	--

- Additional highways may be expanded by future navigation updates.

Highway Driving Assist Settings

Setting features





With the ENGINE START/STOP button in the ON position, press MODE

button  several times on the steering wheel until 'User Settings' menu appears on the LCD display. Select 'Driver Assistance → Driving Assist → Highway Driving Assist' from the setting menu to set whether or not to use each function.

The set-up of Highway Driving Assist will be maintained, as selected, when the engine is re-started.

Operating conditions

If you activate Highway Driving Assist in the instrument cluster and the following conditions are met, Highway Driving Assist will be ready to operate, and the indicator light  **HDA** will come on green in the cluster.

- When driving on the highway main line.
- When Smart Cruise Control is in operation (Vehicle deceleration and acceleration control)
 - Refer to "Smart Cruise Control (SCC)" on page 5-91.
 - If Smart Cruise Control is in standby mode (Smart Cruise Control is on but speed is not set), Highway Driving Assist will be in the same mode. The white indicator  **HDA** light will be turned on.
- When the vehicle speed is below 153 km/h (95 mph)

Highway Driving Assist Operation

The speed is automatically set in accordance with the steering control and the highway speed limit when all the operating conditions are met.

Steering control

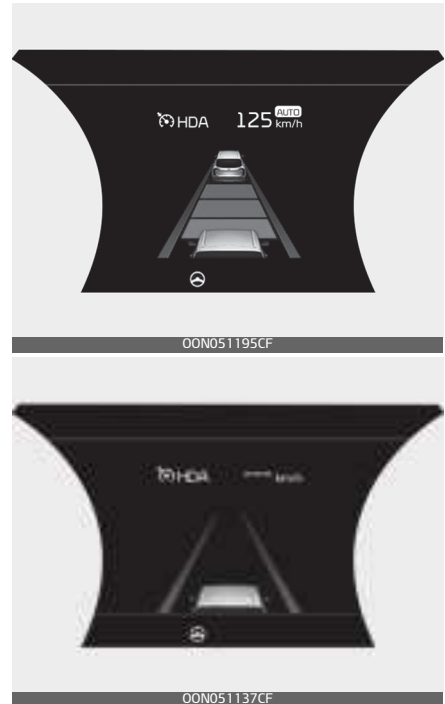

If both lanes are recognized properly (lane color: white), the steering wheel indicator  lights up in green and then the steering control is initiated. When the function cannot provide temporary steering inputs, the indicator flashes green and then changes to white. Even

when Highway Driving Assist cannot provide temporary steering inputs, it still controls the distance from other vehicles. (For information on non-operating conditions of steering wheel control, please refer to "Lane Following Assist Malfunction and Limitations" on page 5-117.)

- If you hold the steering wheel lightly, it may be perceived that the steering wheel is not held at all and trigger the hands-off warning.

Warning related to steering wheel



The hands-off warning appears when the function detects that the driver's hands are not on the steering wheel while Highway Driving Assist is in operation. (First warning: warning message, Second warning: warning message with warning sound)

When the hands-off warning lasts for a certain period of time



If you keep your hands off the steering wheel even with the hands-off warning on, the steering assist and Smart Cruise Control will be temporarily released automatically.

If you activate Smart Cruise Control with Highway Driving Assist released, the steering assist will restart.

CAUTION

- The hands-off warning may be delayed depending on road conditions. Always keep your hands on the steering wheel while driving.

Automatic speed setting

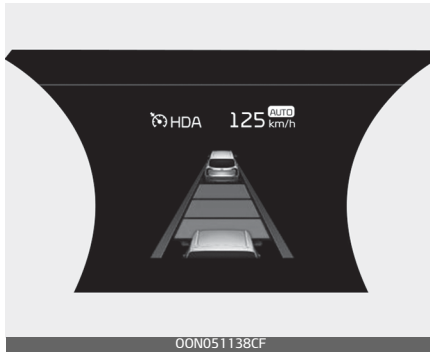

In the automatic speed setting mode, the set speed is automatically adjusted to the changing speed limits of highway sections.

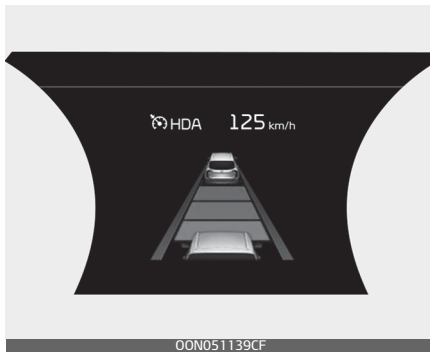

If the driver directly changes the speed, it enters the manual speed setting mode and the set speed is displayed in white and the "AUTO" symbol will disappear.

Highway Driving Assist malfunction



This message shows that there is a problem with Highway Driving Assist, so have your vehicle inspected by an authorized Kia dealer.

⚠ CAUTION

- In all situations, the driver's behavior/judgment has the priority.
- Highway Driving Assist operates only when the driver has set it through the user settings in the instrument cluster.
- Highway Driving Assist is limited in other countries.
- Highway Driving Assist only operates based on the speed limits of the highway but it does not work with the speed cameras.
- The time gap could occur between the navigation speed warning and function operation.
- If the speed limits of speed cameras exceed the highway speed

limits during the automatic speed setting mode, the navigation displays its own warning.

- The function is not designed to work on expressways, national highways and public roads. The function automatically cancels when you leave the highway.
- Highway Driving Assist is deactivated on the user settings in the instrument cluster when it is not in operable condition.
- When the vehicle is at resting area or interchanges or junctions away from the main line of the highway, Highway Driving Assist is automatically turned off so it requires caution to the driver.
- When you are 500 m (0.3 mile) before/after an open-type toll gate while driving on the highway, Highway Driving Assist is automatically turned off so it requires caution to the driver. It automatically switches to Smart Cruise Control and a pop-up window will appear to inform you of the change.
- When the automatic speed setting is in operation, the set speed may automatically change on the highway in accordance with changes in speed limit, leading to automatic acceleration/deceleration of the vehicle.

WARNING

- Regardless of whether Highway Driving Assist is on or off, you must keep eyes on the road while driving and must obey all traffic laws.
- Highway Driving Assist depends entirely on road information provided by the Infotainment System, and the car manufacturer is not responsible for the driver's violation of road traffic laws or accidents.

WARNING

Highway Driving Assist may not function properly in the following situations:

- The navigation is not working properly.
- The navigation is not updated.
- The real-time GPS or map information provided has errors.
- The navigation is overloaded by performing functions, such as route search, video play-back, voice recognition, etc, that are performing simultaneously.
- GPS signals are blocked in areas such as a tunnel.
- The driver goes off course or the route to the destination is changed or canceled by resetting the navigation.
- The vehicle enters a service station or resting area.

- Android Auto or Car Play is operating.
- The navigation cannot detect the current vehicle position (ex: elevated roads including overpass adjacent to general roads or nearby roads exist in a parallel way).
- The navigation is being updated while driving.
- The navigation is being reset while driving.
- The road is slippery due to bad weather such as rain or snow.

responsible for compliance could void the user's authority to operate the device.

* Refer to "Smart Cruise Control (SCC)" on page 5-91 for cautions and warnings about Vehicle Distance control and front radar.

* Refer to "Lane Keeping Assist (LKA)" on page 5-66 for cautions and warnings about steering control and front view camera.

This device complies with Industry Canada licence-exempt RSS standard(s).

Operation is subject to the following conditions:

1. This device may not cause interference, and
2. This device must accept any interference, including interference that may cause undesired operation of the device.
3. Changes or modifications not expressly approved by the party

Rear Cross-Traffic Collision-Avoidance Assist (RCCA)

Rear Cross-Traffic Collision-Avoidance Assist is designed to detect vehicles approaching from the left and right side while your vehicle is reversing, and warning the driver that a collision is imminent with a warning message and an audible warning. Also, to help prevent collision braking assist is applied.

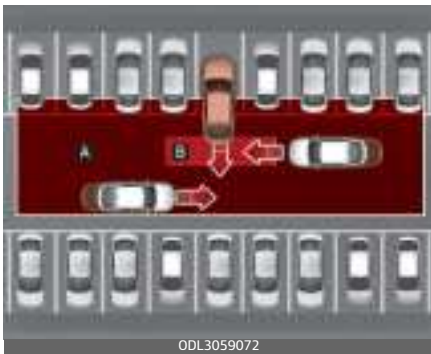

[A]: Rear Cross-Traffic Collision Warning operating range

[B]: Rear Cross-Traffic Collision-Avoidance Assist operating range

CAUTION

The time of warning may vary depending on vehicle speed of the approaching vehicle.

Detecting sensor



[1]: Rear corner radar

Refer to the picture above for the detailed location of the detecting sensor.

CAUTION

For more details on the precautions of the rear corner radar, refer to "Blind-Spot Collision-Avoidance Assist (BCA)" on page 5-72.

Rear Cross-Traffic Collision-Avoidance Assist Settings

Setting features

Rear Cross-Traffic Safety



With the ENGINE START/STOP button in the ON position, press MODE button (⏮) several times on the steering wheel until 'User Settings' menu appears on the LCD display. Select 'Driver Assistance → Parking Safety → Rear Cross-Traffic Safety' from the setting menu to set whether or not to use each function.

⚠ WARNING

When the engine is restarted, Rear Cross-Traffic Collision-Avoidance Assist will always turn on. However, if 'Off' is selected after the engine is restarted, the driver should always be aware of the surroundings and drive safely.

* NOTICE

Settings for Rear Cross-Traffic Safety system include Rear Cross-Traffic Collision Warning and Rear Cross-Traffic Collision-Avoidance Assist.

* NOTICE

If the engine is restarted, Warning Timing and Warning Volume will maintain the last setting.

Warning Timing



With the ENGINE START/STOP button in the ON position, press MODE button (⏮) several times on the steering wheel until 'User Settings' menu appears on the LCD display. Select 'Driver Assistance → Warning Timing' to change the initial warning activation time for Rear Cross-Traffic Collision-Avoidance Assist.

When the vehicle is first delivered, warning timing is set to Normal. If you change the warning timing, the warning time of other Driver Assistance system may change.

Always be aware before changing the warning timing.

Warning Volume

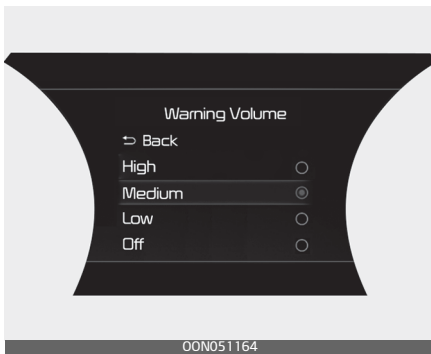

With the ENGINE START/STOP button in the ON position, press MODE button (ⓘ) several times on the steering wheel until 'User Settings' menu appears on the LCD display. Select 'Driver Assistance → Warning Volume' to change the warning volume to 'High', 'Medium', 'Low' or 'Off' for Rear Cross-Traffic Collision-Avoidance Assist.

If you change the Warning Volume, the Warning Volume of other Driver Assistance system may change.

CAUTION

- The setting of the Warning Timing and Warning Volume applies to all functions of Rear Cross-Traffic Collision-Avoidance Assist.
- Even though 'Normal' is selected for Warning Timing, if the vehicles from the left and right side approaches at high speed, the initial warning activation time may seem late.
- Select 'Late' for Warning Timing when traffic is light and when driving speed is slow.

Rear Cross-Traffic Collision-Avoidance Assist Operation

Warning and control

Rear Cross-Traffic Collision-Avoidance Assist will warning and control the vehicle depending on collision level: 'Collision Warning', 'Emergency Braking'.

Collision Warning

Left



Right



- To warn the driver of an approaching vehicle from the rear left/right side of your vehicle, the warning light on the side view mirror (outside mirror) will blink and a warning will appear on the cluster. At the same time, an audible warning will sound.
- The function will operate when the following conditions are satisfied:
 - Your vehicle gear is shifted to R (Reverse)
 - Your vehicle speed is below 10 km/h (7 mph)
 - The approaching vehicle is within approximately 25 m (82 ft.) from the left and right side of your vehicle
 - The speed of the vehicle approaching from the left and right is above 5 km/h (3 mph)

*** NOTICE**

If the operating conditions are satisfied, there will be a warning whenever the vehicle approaches from

the left or right side even though your vehicle speed is 0 km/h (0 mph).

Emergency Braking

Left

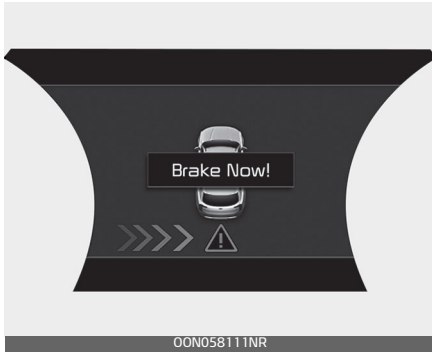

Right



- Your vehicle, the warning light on the side view mirror (outside mirror) will blink and a warning message will appear on the cluster. At the same time, an audible warning will sound.
- The function will operate when the following conditions are satisfied:
 - Your vehicle gear is shifted to R (Reverse)
 - Your vehicle speed is below 10 km/h (7 mph)
 - The approaching vehicle is within approximately 1.5 m (5

ft.) from the left and right side of your vehicle

- The speed of the vehicle approaching from the left and right is above 5 km/h (3 mph)
- Emergency Braking will be assisted to help prevent collision with approaching vehicles from the left and right.

⚠ WARNING

- Brake control will end when:
 - The approaching vehicle is out of the detecting range
 - The approaching vehicle passes behind your vehicle
 - The approaching vehicle does not drive toward your vehicle
 - The approaching vehicle speed slows down
 - The driver depresses the brake pedal with sufficient power

Stopping vehicle and ending brake control

- For your safety, the driver should depress the brake pedal immediately and check the surroundings.
- Brake control will end after the vehicle is stopped by emergency braking for approximately 2 seconds.
- During emergency braking, braking control by Rear Cross-Traffic Collision-Avoidance Assist will automatically cancel when the

driver excessively depresses the brake pedal.

⚠ WARNING

- For your safety, change the settings after parking the vehicle at a safe location.
- If any other function's warning message is displayed or audible warning is generated, Rear Cross-Traffic Collision-Avoidance Assist warning message may not be displayed and audible warning may not be generated.
- You may not hear the warning sound of Rear Cross-Traffic Collision-Avoidance Assist if the surrounding is noisy.
- Rear Cross-Traffic Collision-Avoidance Assist may not operate if the driver applies the brake pedal to avoid collision.
- During Rear Cross-Traffic Collision-Avoidance Assist operation, the vehicle may stop suddenly injuring passengers and shifting loose objects. Always have the seat belt on and keep loose objects secured.
- Even if there is a problem with Rear Cross-Traffic Collision-Avoidance Assist, the vehicle's basic braking performance will operate normally.

⚠ WARNING

- During emergency braking, braking control by the function will automatically cancel when the driver excessively depresses the accelerator pedal.
- Rear Cross-Traffic Collision-Avoidance Assist does not operate in all situations or cannot avoid all collisions.
- Rear Cross-Traffic Collision-Avoidance Assist may warn the driver late or may not warn the driver depending on the road and driving conditions.
- The driver should hold the responsibility to control the vehicle. Do not solely depend on Rear Cross-Traffic Collision-Avoidance Assist. Rather, maintain a safe braking distance, and if necessary, depress the brake pedal to reduce driving speed or to stop the vehicle.
- Never deliberately operate Rear Cross-Traffic Collision-Avoidance Assist on people, animal, objects, etc. It may cause serious injury or death.

⚠ CAUTION

The brake control may not operate properly depending on the status of ESC (Electronic Stability Control). There will only be a warning when:

- The ESC (Electronic Stability Control) warning light is on
- ESC (Electronic Stability Control) is engaged in a different function

*** NOTICE**

The driver must immediately depress the brake pedal and check vehicle surroundings.

- Brake control will end when the driver depresses the brake pedal with sufficient power.
- After shifting the gear to R (Reverse), braking control will operate once for left and right vehicle approach.

Rear Cross-Traffic Collision-Avoidance Assist Malfunction and Limitations

Rear Cross-Traffic Collision-Avoidance Assist malfunction



When Rear Cross-Traffic Collision-Avoidance Assist is not working

properly, the 'Check Blind-Spot Collision Warning (BCW) system' warning message will appear on the cluster, and the function will turn off automatically or the function will be limited. In this case, have your vehicle inspected by an authorized Kia dealer.

Rear Cross-Traffic Collision-Avoidance Assist disabled



When the rear bumper around the rear corner radar or sensor is covered with foreign matters, such as snow or rain, or installing a trailer or carrier, it can reduce the detecting performance and temporarily limit or disable Rear Cross-Traffic Collision-Avoidance Assist.

If this occurs, the 'Blind-Spot Collision Warning (BCW) system disabled. Radar blocked' warning message will appear on the cluster. It is not a malfunction.

The function will operate normally when such foreign matters or trailer, etc. is removed.

Always keep the rear view camera and rear ultrasonic sensors clean.

If Rear Cross-Traffic Collision-Avoidance Assist does not operate normally after it is removed, have the vehicle inspected by an authorized Kia dealer.

⚠ WARNING

- Even though the warning message does not appear on the cluster, Rear Cross-Traffic Collision-Avoidance Assist may not properly operate.
- Rear Cross-Traffic Collision-Avoidance Assist may not properly operate in an area (e.g. open terrain), where any substance are not detected after turning ON the engine.

⚠ CAUTION

Turn off Rear Cross-Traffic Collision-Avoidance Assist to install a trailer, carrier, etc., and remove the trailer, carrier, etc. to use Rear Cross-Traffic Collision-Avoidance Assist.

Limitations of Rear Cross-Traffic Collision-Avoidance Assist

Rear Cross-Traffic Collision-Avoidance Assist may not operate normally, or the function may operate unexpectedly under the following circumstances:

- Departing from where trees or grass is overgrown
- Departing from where roads are wet
- Speed of the approaching vehicle is fast or slow

Braking control may not work, driver's attention is required in the following circumstances:

- The vehicle severely vibrates while driving over a bumpy road, uneven road or concrete patch
- Driving on a slippery surface due to snow, water puddle, ice, etc.
- The tire pressure is low or a tire is damaged
- The brake is modified

CAUTION

For more details on the limitations of the rear corner radar, refer to "Blind-Spot Collision-Avoidance Assist (BCA)" on page 5-72.



[A]: Structure

- Driving near a vehicle or structure
Rear Cross-Traffic Collision-Avoidance Assist may be limited when driving near a vehicle or structure, and may not detect the vehicle approaching from the left or right. If this occurs, the function may not warn the driver or control the brakes when necessary. Always check your surroundings while backing up.



- When the vehicle is in a complex parking environment

Rear Cross-Traffic Collision-Avoidance Assist may detect vehicles which are parking or pulling out near your vehicle (e.g. a vehicle leaving beside your vehicle, a vehicle parking or pulling out in the rear area, a vehicle approaching your vehicle making a turn, etc.). If this occurs, the function may unnecessarily warn the driver and control the brake.

Always check your surroundings while backing up.



[A]: Vehicle

- When the vehicle is parked diagonally

Rear Cross-Traffic Collision-Avoidance Assist may be limited when backing up diagonally, and may not detect the vehicle approaching from the left or right. If this occurs, the function may not warn the driver or control the brakes when necessary.

Always check your surroundings while backing up.

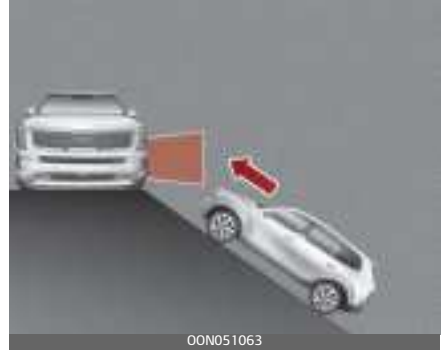

- When the vehicle is on or near a slope

Rear Cross-Traffic Collision-Avoidance Assist may be limited when the vehicle is on an uphill or downhill slope, or near it, and may not detect the vehicle approaching from the left or right. If this occurs, the function may not warn the driver or control the brakes when necessary.

Always check your surroundings while backing up.

⚠ WARNING



[A]: Structure, [B]: Wall

- Pulling into the parking space where there is a structure Rear Cross-Traffic Collision-Avoidance Assist may detect vehicles passing by in front of you when parking backwards into a parking space with a wall or structure in the rear or side area. If this occurs, the function may unnecessarily warn the driver and control the brake. Always check your surroundings while backing up.

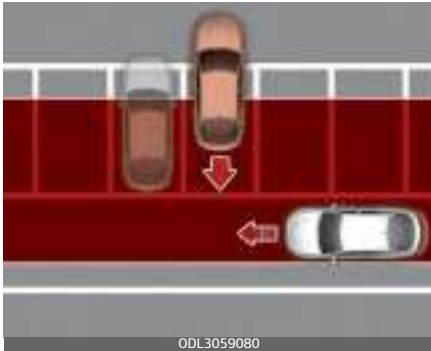

- When the vehicle is parked rearward Rear Cross-Traffic Collision-Avoidance Assist may detect vehicles passing by behind you when parking backwards into a parking space. If this occurs, the function may unnecessarily warn the driver and control the brake. Always check your surroundings while backing up.

⚠ WARNING

- When you are towing a trailer or another vehicle, we recommend that Rear Cross-Traffic Collision-Avoidance Assist is turned off due to safety reasons.
- Rear Cross-Traffic Collision-Avoidance Assist may not operate normally if interfered by strong electromagnetic waves.
- Rear Cross-Traffic Collision-Avoidance Assist may not operate for 3 seconds after the vehicle is started, or the rear corner radars are initialized.

This device complies with Industry Canada licence-exempt RSS standard(s).

Operation is subject to the following two conditions:

1. This device may not cause interference, and
2. This device must accept any interference, including interference that may cause undesired operation of the device.

Declaration of conformity (if equipped)

The radio frequency components (Front radar) complies:

For Korea



For United States and American territories, Micronesia, Dominican Republic, Honduras



Europe and countries subject to CE certification

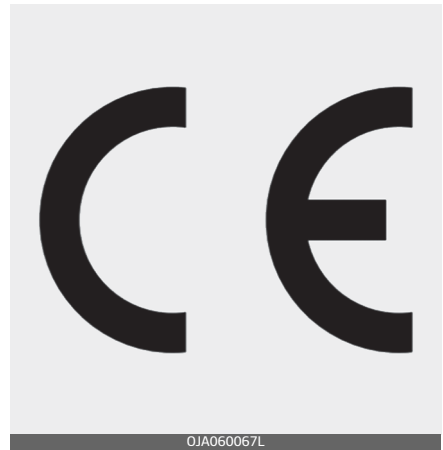

Model : MRR-20

Hevity MRR-20 has been so constructed that it can be operated in at least one Member State without infringing applicable requirements of use of radio spectrum. (RED article 10.2)

Hevity, Mando Corp declares that the radio equipment type MRR-20 is in compliance with Directive 2014/53/EU.

The full text of the EU declaration of conformity is available at the following internet address:
<https://www.mando.com/fin/roster.jsp>

OSP2061033L

For Canada

Model MRR-20
 IC: 11080A-MRR20

This device complies with industry Canada licence-exempt RSS standards. Operation is subject to the following two conditions:
 (1) this device may not cause interference, and
 (2) this device must accept any interference, including interference that may cause undesired operation of the device.

Le présent appareil est conforme aux CNR d'Industrie Canada applicables aux appareils radio exempts de licence. L'exploitation est autorisée aux deux conditions suivantes:
 (1) l'appareil ne doit pas produire de brouillage, et
 (2) l'utilisateur de l'appareil doit accepter tout brouillage radioélectrique subi, même si le brouillage est susceptible d'en compromettre le fonctionnement.

OSP2061034L

For Taiwan



OCK060060L

For Oman

CCA126, P0R0016

(1) Without permission granted by NCC, any company, enterprise, or user is not allowed to change frequency, enhance transmitting power or alter original characteristics as well as performance to a approved low power radio-frequency device.

(2) The low power radio-frequency devices shall not influence aircraft security and interfere legal communications; if found, the user shall cease operating immediately until no interference is achieved.

The civil legal communications means radio communications is operated in compliance with the Telecommunications Act.

The low power radio-frequency devices must be susceptible with the interference from legal communications or (SM) radio wave radiated 600K05.

OMAN - TRA
TRA/TA-R/5429/18
D080320

OSP2061037L

For Moldova



OCK060065L

For Ukraine



ODL3059228L

For Australia



OCK060062L

For Serbia



OSP2061036L

For Singapore



OCK060066L



OSP2061040L

For United Arab Emirates



OSP2061038L



ODL3059224L

For Brazil



OSP2061039L

For Malaysia



OSP2061041L

For Jordan

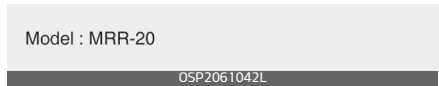

OSP2061042L

For Mexico



For Israel

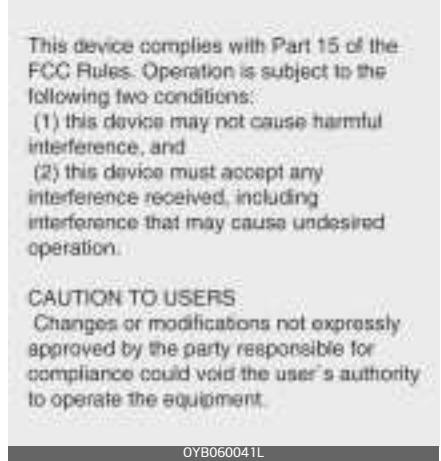
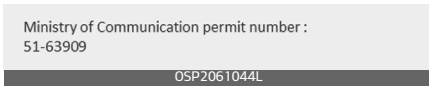

The radio frequency components (Rear Corner radar) complies :

For United States and American territories, Micronesia, Dominican Republic, Honduras



For Canada

Model: RS4
IC: 2694A - RS4

This device contains licence-exempt transmitter(s)/receiver(s) that comply with Innovation, Science and Economic Development Canada's licence-exempt RSS(s). Operation is subject to the following two conditions:

- (1) This device may not cause interference.
- (2) This device must accept any interference, including interference that may cause undesired operation of the device.

Le présent appareil est conforme aux CNR d'Industrie Canada applicables aux appareils radio exempts de licence. L'exploitation est autorisée aux deux conditions suivantes:

- (1) l'appareil ne doit pas produire de brouillage, et
- (2) l'utilisateur de l'appareil doit accepter tout brouillage radioélectrique subi, même si le brouillage est susceptible d'en compromettre le fonctionnement.

This equipment complies with ISED radiation exposure limits set forth for an uncontrolled environment. This equipment should be installed and operated with minimum distance of 20 cm between the radiator and your body. This transmitter must not be co-located or operating in conjunction with any other antenna or transmitter. Cet équipement est conforme aux limites d'exposition aux rayonnements ISED établies pour un environnement non contrôlé. Cet équipement doit être installé et utilisé avec un minimum de 20 cm de distance entre la source de rayonnement et votre corps. Ce transmetteur ne doit pas être placé au même endroit ou utilisé simultanément avec un autre transmetteur ou antenne.

OYB060042L

For Taiwan

電檢法第 48 條, 低功率電波輻射性電機管理辦法

第十二條

經型式認證合格之低功率射頻電機, 非經許可, 公司、商號或使用者均不得擅自變更頻率, 加大功率或變更原設計之特性及功能。

第十四條

低功率射頻電機之使用不得影響飛航安全及干擾合法通信; 經發現有干擾現象時, 應立即停用, 並改善至無干擾時方得繼續使用。

前項合法通信, 指依電信法規定作業之無線電通信。低功率射頻電機須忍受合法通信或工業、科學及醫療用電波輻射性電機設備之干擾。

Article 12

Without permission, any company, firm or user shall not alter the frequency, increase the power, or change the characteristics and functions of the original design of the certified low power frequency electric machinery.

Article 14

The application of low power frequency electric machinery shall not affect the navigation safety nor interfere a legal communication, if an interference is found, the service will be suspended until improvement is made and the interference no longer exist.

OYB060043L

For Indonesia

54473/SDPPI/2018
6051

OYB060044L

For Malaysia



OYB060045L

For Singapore

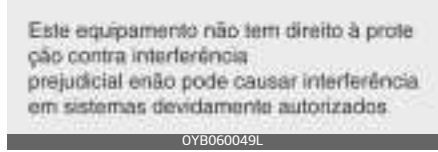

For Mexico

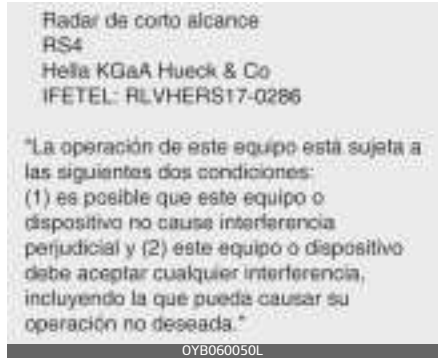

For Vietnam



For Brazil



5

For Ukraine



OYB060052L

For United Arab Emirates



OYB060056L

Ця HELLA GmbH & Co. KGaA заявляє, що радіотехнічне обладнання типу RS4 в ідповідас Технічному регламенту радіотехнічного обладнання та Директиві 2014/53/ЄС.
Повний текст декларації про відповідність доступний за адресою: www.hella.com/hyundai
Частотний діапазон: 24,05 – 24,25 ГГц
Потужність передачі: 20 дБм (макс.) EIRP

OYB060053L

For Botswana



OYB060057L

For Jordan

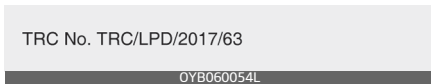

OYB060054L

For Ghana

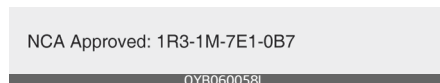

OYB060058L

For Oman



OYB060055L

For Zambia



For Mozambique

Approval No: N 1/R/SRA/2017
HELLA RS4

OYB060062L

Europe and countries subject to CE certification

(in the user manual)

Hereby, Hella KGaA Hueck & Co. Declares that the radio equipment type RS4 is in compliance with Directive 2014/53/EU. The full text of the EU declaration of conformity is available at the following internet address: www.hella.com/hyundai

Technical information:
Frequency range: 24.00 ... 24.25 GHz
Transmission power: 20 dBm (maximum EIRP)

Manufacturer and Address:
Hella KGaA Hueck & Co.
Reibacher Straße 75, 38552 Lippstadt, Germany

OYB060063L

For Jamaica

This product contains a Type Approved Module by Jamaica: SMA – “RS4”

OYB060060L

For Paraguay



For Uzbekistan



Economical operation

Your vehicle's fuel economy depends mainly on your style of driving, where you drive and when you drive.

Each of these factors affects how many kilometers (miles) you can get from a liter (gallon) of fuel. To operate your vehicle as economically as possible, use the following driving suggestions to help save money in both fuel and repairs:

- Drive smoothly. Accelerate at a moderate rate. Don't make "jack-rabbit" starts or full-throttle shifts and maintain a steady cruising speed. Don't race between stoplights. Try to adjust your speed to the traffic so you don't have to change speeds unnecessarily. Avoid heavy traffic whenever possible. Always maintain a safe distance from other vehicles so you can avoid unnecessary braking. This also reduces brake wear.
- Drive at a moderate speed. The faster you drive, the more fuel your vehicle uses. Driving at a moderate speed, especially on the highway, is one of the most effective ways to reduce fuel consumption.
- Don't "ride" the brake pedal. This can increase fuel consumption and also increase wear on these components. In addition, driving with your foot resting on the brake pedal may cause the brakes to overheat, which reduces their effectiveness and may lead to more serious consequences.
- Take care of your tires. Keep them inflated to the recommended pressure. Incorrect inflation, either too much or too little, results in unnecessary tire wear. Check the tire pressures at least once a month.
- Be sure that the wheels are aligned correctly. Improper alignment can result from hitting curbs or driving too fast over irregular surfaces. Poor alignment causes faster tire wear and may also result in other problems as well as greater fuel consumption.
- Keep your vehicle in good condition. For better fuel economy and reduced maintenance costs, maintain your vehicle in accordance with "Scheduled maintenance service" on page 7-8. If you drive your vehicle in severe conditions, more frequent maintenance is required (Refer to "Maintenance Under Severe Usage Conditions - Non Turbo Models" on page 7-13 for details).
- Keep your vehicle clean. For maximum service, your vehicle should be kept clean and free of corrosive materials. It is especially important that mud, dirt, ice, etc. not be allowed to accumulate on the underside of the vehicle. This

extra weight can result in increased fuel consumption and also contribute to corrosion.

- Travel lightly. Don't carry unnecessary weight in your vehicle. Weight reduces fuel economy.
- Don't let the engine idle longer than necessary. If you are waiting (and not in traffic), turn off your engine and restart only when you're ready to go.
- Remember, your vehicle does not require extended warm-up. After the engine has started, allow the engine to run for 10 to 20 seconds prior to placing the vehicle in gear. In very cold weather, however, give your engine a slightly longer warm-up period.
- Don't "lug" or "over-rev" the engine. Lugging is driving too slowly in a very high gear resulting in engine bucking. If this happens, shift to a lower gear. Over-revving is racing the engine beyond its safe limit. This can be avoided by shifting at the recommended speed.
- Use your air conditioning sparingly. The air conditioning system is operated by engine power so your fuel economy is reduced when you use it.
- Open windows at high speeds can reduce fuel economy.
- Fuel economy is less in crosswinds and headwinds. To help off-

set some of this loss, slow down when driving in these conditions.

Keeping a vehicle in good operating condition is important both for economy and safety. Therefore, have an authorized Kia dealer perform scheduled inspections and maintenance.

WARNING

Engine off during motion

Never turn the engine off to coast down hills or anytime the vehicle is in motion. The power steering and power brakes will not function properly without the engine running. In addition, turning off the ignition while driving could engage the steering wheel lock resulting in loss of vehicle steering. Keep the engine on and downshift to an appropriate gear for engine braking effect.

Special driving conditions

If driving conditions deteriorate due to poor weather or road conditions, you should pay even more attention than usual to your driving.

Hazardous driving conditions

When hazardous driving conditions are encountered such as water, snow, ice, mud, sand, or similar hazards, follow these suggestions:

- Drive cautiously and allow extra distance for braking.
- Avoid sudden braking or steering.
- When braking with non-ABS brakes pump the brake pedal with a light up-and-down motion until the vehicle is stopped.
- Do not pump the brake pedal on a vehicle equipped with ABS.
- If stalled in snow, mud, or sand, use the second gear. Accelerate slowly to avoid spinning the drive wheels.
- Use sand, rock salt, or other non-slip material under the drive wheels to provide traction when stalled in ice, snow, or mud.

Reducing the risk of a rollover

This multi-purpose passenger vehicle is defined as a Sports Utility Vehicle (SUV). Utility vehicles have a significantly higher rollover rate than other types of vehicles. SUV's have higher ground clearance and a

narrower track to make them capable of performing in a wide variety of offroad applications.

Specific design characteristics give them a higher center of gravity than ordinary vehicles. An advantage of the higher ground clearance is a better view of the road, which allows you to anticipate problems.

They are not designed for cornering at the same speeds as conventional passenger vehicles, any more than low-slung sports vehicles are designed to perform satisfactorily in off-road conditions. Due to this risk, driver and passengers are strongly recommended to buckle their seat belts.

In a rollover crash, an unbelted person is significantly more likely to die than a person wearing a seat belt. There are steps that a driver can make to reduce the risk of a rollover.

If at all possible, avoid sharp turns or abrupt maneuvers, do not load your roof rack with heavy cargo, and never modify your vehicle in any way.

WARNING

Rollover

As with other Sports Utility Vehicle (SUV), failure to operate this vehicle correctly may result in loss of control, an accident or vehicle rollover.

- Utility vehicles have a significantly higher rollover rate than other types of vehicles.
- Specific design characteristics (higher ground clearance, narrower track, etc.) give this vehicle a higher center of gravity than ordinary vehicles.
- A SUV is not designed for cornering at the same speeds as conventional vehicles.
- Avoid sharp turns or abrupt maneuvers.
- In a rollover crash, an unbelted person is significantly more likely to die than a person wearing a seat belt. Make sure everyone in the vehicle is properly buckled up.

WARNING

Your vehicle is equipped with tires designed to provide safe ride and handling capability. Do not use tires and wheels that are different in size and type from the originally installed ones. It can affect the safety and performance of your vehicle, which could lead to steering failure or rollover and serious injury. When replacing the tires, be sure to equip all four tires with the tire and wheel of the same size, type, tread, brand and load-carrying capacity.

Rocking the vehicle

If it is necessary to rock the vehicle to free it from snow, sand, or mud, first turn the steering wheel right and left to clear the area around your front wheels. Then, shift back and forth between R (Reverse) and any forward gear.

Do not race the vehicle, and spin the wheels as little as possible. If you are still stuck after a few tries, have the vehicle pulled out by a tow vehicle to avoid vehicle overheating and possible damage to the reduction gear.

WARNING

Sudden Vehicle Movement

Do not attempt to rock the vehicle if people or objects are nearby. The vehicle may suddenly move forward or backwards as it becomes unstuck.

CAUTION

Vehicle rocking

Prolonged rocking may cause vehicle overheating, reduction gear damage or failure, and tire damage.

CAUTION

Spinning tires

Do not spin the wheels, especially at speeds more than 56 km/h (35

mph). Spinning the wheels at high speeds when the vehicle is stationary could overheat and damage tires, and the rotating wheels may fly away and injure bystanders.

The Electronic Stability Control (ESC) should be turned OFF prior to rocking the vehicle.

Smooth cornering

Avoid braking or gear changing in corners, especially when roads are wet. Ideally, corners should always be taken under gentle acceleration. If you follow these suggestions, tire wear will be held to a minimum.

Driving at night

Because night driving presents more hazards than driving in the daylight, here are some important tips to remember:

- Slow down and keep more distance between you and other vehicles, as it may be more difficult to see at night, especially in areas where there may not be any street lights.
- Adjust your mirrors to reduce the glare from other driver's headlights.
- Keep your headlights clean and properly aimed. (On vehicles not equipped with the automatic headlight aiming feature.) Dirty or improperly aimed headlights will

make it much more difficult to see at night.

- Avoid staring directly at the headlights of oncoming vehicles. You could be temporarily blinded, and it will take several seconds for your eyes to readjust to the darkness.

Driving in the rain

Rain and wet roads can make driving dangerous, especially if you're not prepared for the slick pavement.

Here are a few things to consider when driving in the rain:

- A heavy rainfall will make it harder to see and will increase the distance needed to stop your vehicle, so slow down.
- Keep your windshield wiping equipment in good shape. Replace your windshield wiper blades when they show signs of streaking or missing areas on the windshield.
- If your tires are not in good condition, making a quick stop on wet pavement can cause a skid and possibly lead to an accident. Be sure your tires are in good shape.
- Turn on your headlights to make it easier for others to see you.
- Driving too fast through large puddles can affect your brakes. If you must go through puddles, try to drive through them slowly.

- If you believe you may have gotten your brakes wet, apply them lightly while driving until normal braking operation returns.

Driving in flooded areas

Avoid driving through flooded areas unless you are sure the water is no higher than the bottom of the wheel hub. Drive through any water slowly. Allow adequate stopping distance because brake performance may be affected.

After driving through water, dry the brakes by gently applying them several times while the vehicle is moving slowly.

Driving on unpaved roads

Drive carefully on unpaved roads because your vehicle may be damaged by rocks or roots of trees. Become familiar with the on unpaved roads conditions where you are going to drive before you begin driving.

Highway driving

Tires

Adjust the tire inflation pressures to specification. Low tire inflation pressures will result in overheating and possible failure of the tires. Avoid using worn or damaged tires which may result in reduced traction or tire failure.

Never exceed the maximum tire inflation pressure shown on the tires.

WARNING

Under/over inflated tires

Always check the tires for proper inflation before driving. Underinflated or overinflated tires can cause poor handling, loss of vehicle control, and sudden tire failure leading to accidents, injuries, and even death. For proper tire pressures, refer to "Tires and wheels" on page 8-5.

WARNING

Tire tread

Always check the tire tread before driving your vehicle. Worn-out tires can result in loss of vehicle control. Worn-out tires should be replaced as soon as possible. For further information and tread limits, refer to "Tires and wheels" on page 7-34.

Fuel, engine coolant and engine oil

High speed travel consumes more fuel than urban motoring. Do not forget to check both the engine coolant and engine oil.

Drive belt

A loose or damaged drive belt may result in overheating of the engine.

Winter driving

Severe weather conditions in the winter result in greater wear and other problems.

To minimize the problems of winter driving, you should follow these suggestions:

Snowy or icy conditions

To drive your vehicle in deep snow, it may be necessary to use snow tires on your tires.

If snow tires are needed, it is necessary to select tires equivalent in size and type of the original equipment tires. Failure to do so may adversely affect the safety and handling of your vehicle. Furthermore, speeding, rapid acceleration, sudden brake applications, and sharp turns are potentially very hazardous practices.

During deceleration, use vehicle braking to the fullest extent. Sudden brake applications on snowy or icy roads may cause skids to occur. You need to keep sufficient distance between the vehicle in operation in front of your vehicle. Also, apply the brake gently.

Snow tires

If you mount snow tires on your vehicle, make sure they are radial tires of the same size and load

range as the original tires. Mount snow tires on all four wheels to balance your vehicle's handling in all weather conditions. Keep in mind that the traction provided by snow tires on dry roads may not be as high as your vehicle's original equipment tires. You should drive cautiously even when the roads are clear. Check with the tire dealer for maximum speed recommendations.

Do not install studded tires without first checking local, state and municipal regulations for possible restrictions against their use.

WARNING

Snow tire size

Snow tires should be equivalent in size and type to the vehicle's standard tires. Otherwise, the safety and handling of your vehicle may be adversely affected.

Use high quality ethylene glycol coolant

Your vehicle is delivered with high quality ethylene glycol coolant in the cooling system. It is the only type of coolant that should be used because it helps prevent corrosion in the cooling system, lubricates the water pump and prevents freezing. Be sure to replace or replenish your coolant refer to "Normal mainte-

nance schedule – Non Turbo Models" on page 7-10. Before winter, have your coolant tested to assure that its freezing point is sufficient for the temperatures anticipated during the winter.

Check battery and cables

Winter puts additional burdens on the battery system. Visually inspect the battery and cables (refer to "For best battery service" on page 7-31). The level of charge in your battery can be checked by an authorized Kia dealer or a service station.

Change to "winter weight" oil if necessary

In some climates it is recommended that a lower viscosity "winter weight" oil be used during cold weather. Refer to "Recommended lubricants and capacities" on page 8-6 for recommendations. If you aren't sure what weight oil you should use, consult an authorized Kia dealer.

Check spark plugs and ignition system

Inspect your spark plugs as described in "Scheduled maintenance service" on page 7-8 and replace them if necessary. Also check all ignition wiring and components to be sure they are not

cracked, worn or damaged in any way.

To keep locks from freezing

To keep the locks from freezing, squirt an approved de-icer fluid or glycerine into the key opening. If a lock is covered with ice, squirt it with an approved de-icing fluid to remove the ice. If the lock is frozen internally, you may be able to thaw it out by using a heated key. Handle the heated key with care to avoid injury.

Use approved window washer anti-freeze in system

To keep the water in the window washer system from freezing, add an approved window washer anti-freeze solution in accordance with instructions on the container. Window washer anti-freeze is available from an authorized Kia dealer and most auto parts outlets. Do not use vehicle coolant or other types of anti-freeze as these may damage the paint finish.

Don't let your parking brake freeze

Under some conditions your parking brake can freeze in the engaged position. This is most likely to happen when there is an accumulation of snow or ice around or near the rear brakes or if the brakes are wet. If there is a risk the parking brake

may freeze, apply it only temporarily while you put the gear shift dial in P (Park) and block the rear wheels so the vehicle cannot roll. Then release the parking brake.

Don't let ice and snow accumulate underneath

Under some conditions, snow and ice can build up under the fenders and interfere with the steering. In severe winter conditions you should periodically check underneath the vehicle to be sure the movement of the front wheels and the steering components are not obstructed.

Carry emergency equipment

Depending on the severity of the weather, you should carry appropriate emergency equipment. Some of the items you may want to carry include tow straps or chains, flashlight, emergency flares, sand, shovel, jumper cables, window scraper, gloves, ground cloth, covers, blanket, etc.

Trailer towing

If you are considering towing with your vehicle, you should first check with your country's Department of Motor Vehicles to determine their legal requirements.

Since laws vary the requirements for towing trailers, cars, or other types of vehicles or apparatus may differ. Ask an authorized Kia dealer for further details before towing.

⚠ WARNING

Towing a trailer

Always check your towing equipment to confirm correct equipment size and installation before use. Using incompatible or incorrectly installed trailer equipment can effect the vehicle operation and endanger you and your passengers.

You may require an additional wiring harness connector to install a trailer hitch. Please contact an authorized Kia dealer for more details.

⚠ WARNING

Weight limits

Before towing, make sure the total trailer weight, GCW (Gross Combination Weight), GVW (Gross Vehicle Weight), GAW (Gross Axle Weight) and trailer tongue load are all within the limits.

⚠ CAUTION

Trailer installation

Follow instructions in this section when pulling a trailer. Pulling a trailer improperly can damage your vehicle and result in costly repairs not covered by your warranty.

Your vehicle can tow a trailer. To identify what the vehicle trailering capacity is for your vehicle, you should read the information in "Weight of the trailer" on page 5-159.

Remember that trailering is different than just driving your vehicle by itself. Trailering means changes in handling, durability, and fuel economy. Successful, safe trailering requires correct equipment, and it has to be used properly.

This section contains many time-tested, important trailering tips and safety rules. Many of these are important for your safety and that of your passengers. Please read this section carefully before you pull a trailer.

Load-pulling components such as the engine, transmission, wheel assemblies, and tires are forced to work harder against the load of the added weight. The engine is required to operate at relatively higher speeds and under greater

loads. This additional burden generates extra heat. The trailer also adds considerably to wind resistance, increasing the pulling requirements.

Hitches

It's important to have the correct hitch equipment. Crosswinds, large trucks going by, and rough roads are a few reasons why you'll need the right hitch. Here are some rules to follow:

- Will you have to make any holes in the body of your vehicle when you install a trailer hitch? If you do, then be sure to seal the holes later when you remove the hitch. If you don't seal them, deadly carbon monoxide (CO) from your exhaust can get into your vehicle, as well as dirt and water.
- The bumpers on your vehicle are not intended for hitches. Do not attach rental hitches or other bumper-type hitches to them. Use only a frame-mounted hitch that does not attach to the bumper.
- Kia trailer hitch accessory is available at an authorized Kia dealer.

Safety chains

You should always attach chains between your vehicle and your trailer. Cross the safety chains under the tongue of the trailer so

that the tongue will not drop to the road if it becomes separated from the hitch.

Instructions about safety chains may be provided by the hitch manufacturer or by the trailer manufacturer. Follow the manufacturer's recommendation for attaching safety chains. Always leave just enough slack so you can turn with your trailer. And, never allow safety chains to drag on the ground.

Trailer brakes

If your trailer is equipped with a braking system, make sure it conforms to your state's regulations and that it is properly installed and operating correctly.

If your trailer weight exceeds the maximum allowed weight without trailer brakes, then the trailer will also require its own brakes as well. Be sure to read and follow the instructions for the trailer brakes so you'll be able to install, adjust and maintain them properly.

- Don't tap into or modify your vehicle's brake system.

WARNING

Trailer brakes

Do not use a trailer with its own brakes unless you are absolutely certain that you have properly set

up the brake system. This is not a task for amateurs. Use an experienced, competent trailer shop for this work.

Driving with a trailer

Towing a trailer requires a certain amount of experience. Before setting out for the open road, you must get to know your trailer. Acquaint yourself with the feel of handling and braking with the added weight of the trailer. And always keep in mind that the vehicle you are driving is now a good deal longer and not nearly so responsive as your vehicle is by itself.

Before you start, check the trailer hitch and platform, safety chains, electrical connector(s), lights, tires and mirror adjustment. If the trailer has electric brakes, start your vehicle and trailer moving and then apply the trailer brake controller by hand to be sure the brakes are working. This lets you check your electrical connection at the same time.

During your trip, check occasionally to be sure that the load is secure, and that the lights and any trailer brakes are still working.

Following distance

Stay at least twice as far behind the vehicle ahead as you would when driving your vehicle without a trailer. This can help you avoid situations that require heavy braking and sudden turns.

Passing

You'll need more passing distance up ahead when you're towing a trailer. And, because of the increased vehicle length, you'll need to go much farther beyond the passed vehicle before you can return to your lane. Due to the added load to the engine when going uphill the vehicle may also take longer to pass than it would on flat ground.

Backing up

Hold the bottom of the steering wheel with one hand. Then, to move the trailer to the left, just move your hand to the left. To move the trailer to the right, move your hand to the right. Always back up slowly and, if possible, have someone guide you.

Making turns

When you're turning with a trailer, make wider turns than normal. Do this so your trailer won't strike soft shoulders, curbs, road signs, trees, or other objects near the edge of

the road. Avoid jerky or sudden maneuvers. Signal well in advance before turning or lane changes.

Turn signals when towing a trailer

When you tow a trailer, your vehicle has to have a different turn signal flasher and extra wiring. The green arrows on your instrument panel will flash whenever you signal a turn or lane change. Properly connected, the trailer lights will also flash to alert other drivers you're about to turn, change lanes, or stop.

When towing a trailer, the green arrows on your instrument panel will flash for turns even if the bulbs on the trailer are burned out. Thus, you may think drivers behind you are seeing your signals when, in fact, they are not. It's important to check occasionally to be sure the trailer bulbs are still working. You must also check the lights every time you disconnect and then reconnect the wires.

Do not connect a trailer lighting system directly to your vehicle's lighting system. Use only an approved trailer wiring harness.

An authorized Kia dealer can assist you in installing the wiring harness.

▲ CAUTION

Always use an approved trailer wiring harness. Failure to use an approved trailer wiring harness could result in damage to the vehicle electrical system.

Driving on grades

Reduce speed and shift to a lower gear before you start down a long or steep downgrade. If you don't shift down, you might have to use your brakes so much that they would get hot and no longer operate efficiently. On a long uphill grade, shift down and reduce your speed to around 70 km/h (45 mph) to reduce the possibility of engine and transmission overheating.

If your trailer weighs more than the maximum trailer weight without trailer brakes and you have an automatic transmission, you should drive in D (Drive) when towing a trailer.

Operating your vehicle in D (Drive) when towing a trailer will minimize heat build up and extend the life of your transmission.

Towing uphill

When towing a trailer on steep grades (in excess of 6%) pay close attention to the engine coolant

temperature gauge to ensure the engine does not overheat.

If the needle of the coolant temperature gauge moves across the dial towards "H" (HOT), pull over and stop as soon as it is safe to do so, and allow the engine to idle until it cools down. You may proceed once the engine has cooled sufficiently.

You must decide driving speed depending on trailer weight and uphill grade to reduce the possibility of engine and transmission overheating.

Parking on hills

Generally, if you have a trailer attached to your vehicle, you should not park your vehicle on a hill. People can be seriously or fatally injured, and both your vehicle and the trailer can be damaged if they unexpectedly roll downhill.

However, if you ever have to park your trailer on a hill, here's how to do it:

1. Pull the vehicle into the parking space. Turn the steering wheel in the direction of the curb (right if headed downhill, left if headed up hill).
2. If the vehicle has an automatic transmission, place the vehicle in P (Park).
3. Set the parking brake and shut off the engine.

4. Place chocks under the trailer wheels on the down hill side of the wheels.
5. Start the vehicle, hold the brakes, shift to neutral, release the parking brake and slowly release the brakes until the trailer chocks absorb the load.
6. Reapply the brakes, reapply the parking brake and shift the vehicle to P (Park) for automatic transmission.
7. Shut off the vehicle and release the vehicle brakes but leave the parking brake set.

When you are ready to leave after parking on a hill

1. With the automatic transmission in P (Park), apply your brakes and hold the brake pedal down while you:
 - Start your engine;
 - Shift into gear; and
 - Release the parking brake.
2. Slowly remove your foot from the brake pedal.
3. Drive slowly until the trailer is clear of the chocks.
4. Stop and have someone pick up and store the chocks.

Maintenance when trailer towing

Your vehicle will need service more often when you regularly pull a trailer. Important items to pay particular attention to include engine oil, automatic transmission fluid, axle lubricant and cooling system

fluid. Brake condition is another important item to frequently check. Each item is covered in this manual, and the Index will help you find them quickly. If you're trailering, it's a good idea to review these sections before you start your trip.

Don't forget to also maintain your trailer and hitch. Follow the maintenance schedule that accompanied your trailer and check it periodically. Preferably, conduct the check at the start of each day's driving. Most importantly, all hitch nuts and bolts should be tight.

CAUTION

Air conditioning (A/C)

Do not use the air conditioning while using your vehicle to tow uphill. Due to higher load during trailer usage, overheating might occur on hot days or during uphill driving.

- When towing check transmission fluid more frequently.

If you do decide to pull a trailer

Here are some important points if you decide to pull a trailer:

- Consider using a sway control. You can ask a hitch dealer about sway control.
- Do not do any towing with your vehicle during its first 2,000 km (1,200 miles) in order to allow the

engine to properly break in. Failure to heed this caution may result in serious engine or transmission damage.

- When towing a trailer, be sure to consult an authorized Kia dealer for further information on additional requirements such as a towing kit, etc.
- Always drive your vehicle at a moderate speed (less than 100 km/h (60 mph)).
- On a long uphill grade, do not exceed 70 km/h (45 mph) or the posted towing speed limit, whichever is lower.
- The chart contains important considerations that have to do with weight:

Item		kg (lbs.)
		(Gasoline) 3.8 GDi
Maximum trailer weight	Without brake system	750 (1,650)
	With brake system	2,267 (5,000)
Maximum tongue weight		227 (500)

To identify what the vehicle trailering capacity is for your vehicle, you should read the information in "Weight of the trailer" on page 5-159.

Weight of the trailer

Tongue Load

Total Trailer Weight

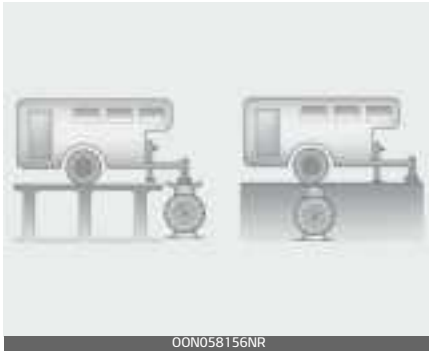

What is the maximum safe weight of a trailer? It should never weigh more than the maximum trailer weight with trailer brakes. But even that can be too heavy.

It depends on how you plan to use your trailer. For example, speed, altitude, road grades, outside temperature and how often your vehicle is used to pull a trailer are all important. The ideal trailer weight can also depend on any special equipment that you have on your vehicle.

Gross Axle Weight

Gross Vehicle Weight

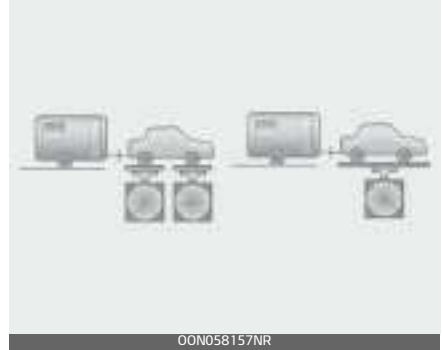

The tongue load of any trailer is an important weight to measure because it affects the total Gross Vehicle Weight (GVW) of your vehicle. This weight includes the curb weight of the vehicle, any cargo you may carry in it, and the people who will be riding in the vehicle. And if you will tow a trailer, you must add the tongue load to the GVW because your vehicle will also be carrying that weight.

After you've loaded your trailer, weigh the trailer and then the tongue, separately, to see if the weights are proper. If they aren't, you may be able to correct them simply by moving some items around in the trailer.

⚠ WARNING

Trailer

Always follow the loading instructions provided with your trailer.

Improper loading can effect vehicle operation and result in an accident.

Vehicle load limit

The vehicle load limit is displayed on the tire and loading information label on the driver's door.

Tire and loading information label



OON069032NR

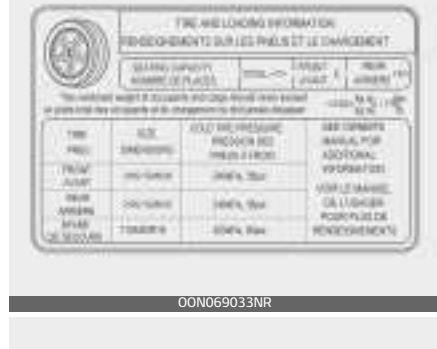

OON069033NR



OON069034NR



The label located on the driver's door sill gives the original tire size, cold tire pressures recommended for your vehicle, the number of people that can be in your vehicle and vehicle capacity weight.

Vehicle capacity weight:

- 7 persons: 532 kg (1,173 lbs.)
- 8 persons: 600 kg (1,323 lbs.)

Vehicle capacity weight is the maximum combined weight of occupants and cargo. If your vehicle is equipped with a trailer, the combined weight includes the tongue load.

Seating capacity:

Total

- 7 persons (Front seat: 2 persons, Rear seat: 5 persons)
- 8 persons (Front seat: 2 persons, Rear seat: 6 persons)

Seating capacity is the maximum number of occupants including a driver, your vehicle may carry. How-

ever, the seating capacity may be reduced based upon the weight of all of the occupants, and the weight of the cargo being carried or towed. Do not overload the vehicle as there is a limit to the total weight, or load limit including occupants and cargo, the vehicle can carry.

Towing capacity:

- (Gasoline) 3.8 GDI Without trailer brakes: 750 kg (1,650 lbs.)
- With trailer brakes: 2,267 kg (5,000 lbs.)

Towing capacity is the maximum trailer weight including its cargo weight, your vehicle can tow

Cargo capacity:

The cargo capacity of your vehicle will increase or decrease depending on the weight and the number of occupants.

Steps for Determining Correct Load Limit -

- (1) Locate the statement "The combined weight of occupants and cargo should never exceed XXX kg or XXX lbs." on your vehicle's placard.
- (2) Determine the combined weight of the driver and passengers that will be riding in your vehicle.

(3) Subtract the combined weight of the driver and passengers from XXX kg or XXX lbs..

(4) The resulting figure equals the available amount of cargo and luggage load capacity. For example, if the "XXX" amount equals 635 kg (1400 lbs.) and there will be five 68 kg (150 lbs.) passengers in your vehicle, the amount of available cargo and luggage load capacity is 295 kg (650 lbs.). $(635 - 340 (5 \times 68) = 295 \text{ kg or } 1400 - 750 (5 \times 150) = 650 \text{ lbs.})$

(5) Determine the combined weight of luggage and cargo being loaded on the vehicle. That weight may not safely exceed the available cargo and luggage load capacity calculated in Step 4.

(6) If your vehicle will be towing a trailer, load from your trailer will be transferred to your vehicle. Consult this manual to determine how this reduces the available cargo and luggage load capacity of your vehicle.

⚠ WARNING

Loose cargo

Do not travel with unsecured blunt objects in the passenger compartment of your vehicle (e.g. suit cases or unsecured child seats). These items may strike an occupant during a sudden stop or crash.

Example 1



Item	Description	Total
A	Vehicle Capacity Weight	385 kg (849 lbs.)
B	Subtract Occupant Weight 68 kg (150 lbs.) × 2	136 kg (300 lbs.)
C	Available Cargo and Luggage weight	249 kg (549 lbs.)

Example 2

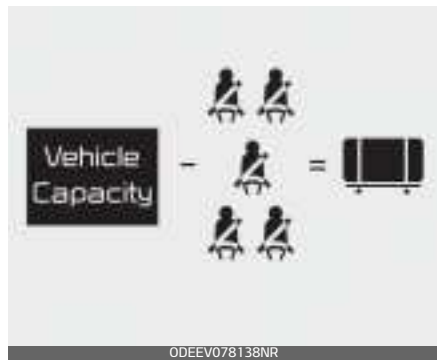

Item	Description	Total
A	Vehicle Capacity Weight	385 kg (849 lbs.)
B	Subtract Occupant Weight 68 kg (150 lbs.) × 5	340 kg (750 lbs.)

Item	Description	Total
C	Available Cargo and Luggage weight	45 kg (99 lbs.)

Example 3

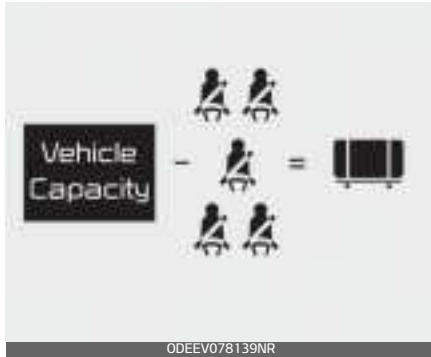

Item	Description	Total
A	Vehicle Capacity Weight	385 kg (849 lbs.)
B	Subtract Occupant Weight $73 \text{ kg (161 lbs.)} \times 5$	365 kg (805 lbs.)
C	Available Cargo and Luggage weight	20 kg (44 lbs.)

Refer to your vehicle's tire and load information label for specific information about your vehicle's capacity weight and seating positions. The combined weight of the driver, passengers and cargo should never exceed your vehicle's capacity weight.

Certification label

The certification label is located on the driver's door sill at the center pillar.

This label shows the maximum allowable weight of the fully loaded vehicle. This is called the GVWR (Gross Vehicle Weight Rating). The GVWR includes the weight of the vehicle, all occupants and cargo.

This label also tells you the maximum weight that can be supported by the front and rear axles, called Gross Axle Weight Rating (GAWR).

To find out the actual loads on your front and rear axles, you need to go to a weigh station and weigh your vehicle. Your dealer can help you with this. Be sure to spread out your load equally on both sides of the centerline.

⚠ WARNING

Over loading

Never exceed the GVWR for your vehicle, the GAWR for either the front or rear axle and vehicle capacity weight. Exceeding these ratings can affect your vehicle's handling and braking ability.

The label will help you decide how much cargo and installed equipment your vehicle can carry.

If you carry items inside your vehicle - like suitcases, tools, packages, or anything else - they are moving as fast as the vehicle. If you have to stop or turn quickly, or if there is a

crash, the items will keep going and can cause an injury if they strike the driver or a passenger.

WARNING

Over loading

Do not overload your vehicle. Overloading your vehicle can cause heat buildup in your vehicle's tires and possible tire failure, increased stopping distances and poor vehicle handling—all of which may result in a crash.

NOTICE

Overloading your vehicle may cause damage. Repairs would not be covered by your warranty. Do not overload your vehicle.

Vehicle weight

This chapter will guide you in the proper loading of your vehicle or trailer, to keep your loaded vehicle weight within its design rating capability, with or without a trailer.

Properly loading your vehicle will provide maximum return of the vehicle design performance. Before loading your vehicle, familiarize yourself with the following terms for determining your vehicle's weight ratings, with or without a trailer, from the vehicle's specifications and the compliance label:

Base curb weight This is the weight of the vehicle including a full tank of fuel and all standard equipment. It does not include passengers, cargo, or optional equipment.

Vehicle curb weight This is the weight of your new vehicle when you picked it up from your dealer plus any aftermarket equipment.

Cargo weight This figure includes all weight added to the Base Curb Weight, including cargo and optional equipment.

GAW (Gross Axle Weight) This is the total weight placed on each axle (front and rear) - including vehicle curb weight and all payload.

GAWR (Gross Axle Weight Rating) This is the maximum allowable

weight that can be carried by a single axle (front or rear). These numbers are shown on the compliance label. The total load on each axle must never exceed its GAWR.

GVW (Gross Vehicle Weight) This is the Base Curb Weight plus actual Cargo Weight plus passengers.

GVWR (Gross Vehicle Weight Rating)

This is the maximum allowable weight of the fully loaded vehicle (including all options, equipment, passengers and cargo). The GVWR is shown on the certification label located on the driver's door sill.

 **CAUTION**

Do not use replacement tires with lower load carrying capacities than the original tires because they may lower your vehicle's GVWR and GAWR limitations. Replacement tires with a higher limit than the original tires do not increase the GVWR and GAWR limitations.

Road warning	6-3
• Hazard warning flasher	6-3
In case of an emergency while driving	6-4
• If the vehicle stalls while driving.....	6-4
• If the engine stalls at a crossroad or crossing	6-4
• If you have a flat tire while driving.....	6-4
If the engine will not start	6-5
• If engine doesn't turn over or turns over slowly	6-5
• If engine turns over normally but does not start.....	6-5
Emergency starting	6-6
• Jump-starting	6-6
• Push-starting.....	6-7
If the engine overheats	6-8
Tire Pressure Monitoring System (TPMS)	6-9
• Effective use of the TPMS.....	6-10
• Low tire pressure telltale	6-11
• TPMS malfunction indicator	6-12
• Tire replacement with TPMS.....	6-13
• This device complies with Industry Canada licence-exempt RSS standard(s).....	6-14
If you have a flat tire (with spare tire)	6-15
• Jack and tools.....	6-16
• Storing the spare tire	6-18
• Changing tires	6-18
• Important - use of compact spare tire	6-23
• Jack label	6-25
Towing	6-26

6 What to do in an emergency

- Towing without wheel dollies when using a towing service.....6-27

What to do in an emergency

Road warning

When in an emergency situation occurs while driving or when you park by the edge of the roadway, you must alert approaching or passing vehicles to be careful as they pass. For this, you should use the hazard warning flasher.

Hazard warning flasher

The hazard warning flasher serves as a warning to other drivers to exercise extreme caution when approaching, overtaking, or passing your vehicle.



It should be used whenever emergency repairs are being made or when the vehicle is stopped near the edge of a roadway.

Depress the flasher switch with the ENGINE START/STOP button in any position. The flasher switch is located in the center fascia panel. All

turn signal lights will flash simultaneously.

- The hazard warning flasher operates whether your vehicle is running or not.
- The turn signals do not work when the hazard flasher is on.
- Care must be taken when using the hazard warning flasher while the vehicle is being towed.

In case of an emergency while driving

If an emergency situation occurs while driving, stay calm and take the following steps.

If the vehicle stalls while driving

1. Reduce your speed gradually, keeping a straight line.
2. Move cautiously off the road to a safe place.
3. Turn on your hazard warning flasher.
4. Try to start the vehicle again. If your vehicle will not start, contact an authorized Kia dealer or seek other qualified assistance.

If the engine stalls at a crossroad or crossing

- If the engine stalls at a crossroad or crossing, set the shift lever in the N (Neutral) position and then push the vehicle to a safe place.
- If your vehicle has a manual transmission not equipped with a ignition lock switch, the vehicle can move forward by shifting to the 2 (second) or 3 (third) gear and then turning the starter without depressing the clutch pedal.

If you have a flat tire while driving

1. Take your foot off the accelerator pedal and let the vehicle slow down while driving straight ahead. Do not apply the brakes immediately or attempt to pull off the road as this may cause a loss of control.
2. When the vehicle has slowed to such a speed that it is safe to do so, brake carefully and pull off the road.
3. Drive off the road as far as possible and park on firm level ground. If you are on a divided highway, do not park in the median area between the two traffic lanes.
4. When the vehicle is stopped, turn on your emergency hazard flashers, set the parking brake and put the transmission in P.
5. Have all passengers get out of the vehicle. Be sure they all get out on the side of the vehicle that is away from traffic.
6. When changing a flat tire, follow the instruction provided later in this section.

If the engine will not start

When the engine doesn't start, first check to see how much fuel there is and whether the battery is discharged.

If engine doesn't turn over or turns over slowly

1. Be sure the shift lever is in N (Neutral) or P (Park) and the emergency brake is set.
2. Check the battery connections to be sure they are clean and tight.
3. Turn on the interior light. If the light dims or goes out when you operate the starter, the battery is discharged.
4. Check the starter connections to be sure they are securely tightened.

Do not push or pull the vehicle to start it. This could cause damage to your vehicle. Refer to "Jump-starting" on page 6-6.

WARNING

Push/pull start

Do not push or pull the vehicle to start it. Push or pull starting may cause the catalytic converter to overload and create a fire hazard.

If engine turns over normally but does not start

1. Check the fuel level.
2. With the ENGINE START/STOP button in the OFF position, check all connectors at the ignition coils and spark plugs. Reconnect any that may be disconnected or loose.
3. Check the fuel line in the engine compartment.
4. If the engine still does not start, call an authorized Kia dealer or seek other qualified assistance.

Emergency starting

When the vehicle will not start because of low battery power, you may need to jump start the vehicle.

Jump-starting

Connect cables in numerical order and disconnect in reverse order.



Jump-starting can be dangerous if done incorrectly. Therefore, to avoid harm to yourself or damage to your vehicle or battery, follow these jump-starting procedures. If in doubt, we strongly recommend that you have a competent technician or towing service jump-start your vehicle.

⚠ WARNING

Battery

Never attempt to check the electrolyte level of the battery as this may cause the battery to rupture or explode.

⚠ WARNING

Frozen batteries

Do not attempt to jump start the vehicle if the discharged battery is frozen as the battery may rupture or explode.

⚠ WARNING

Battery

Keep all flames or sparks away from the battery. The battery produces hydrogen gas which will explode if exposed to flame or sparks.

⚠ WARNING

Battery cables

Do not connect the jumper cable from the negative terminal of the booster battery to the negative terminal of the discharged battery, directly. This can cause the discharged battery to overheat and crack, degradation.

Make sure to connect one end of the jumper cable to the negative terminal of the booster battery, and the other end to a metallic point, far away from the battery.

⚠ WARNING

Sulfuric acid risk

Automobile batteries contain sulfuric acid. When jump starting your

vehicle, be careful not to get sulfuric acid on yourself, your clothing, or on the vehicle. This acid is poisonous and highly corrosive.

Jump-starting

1. Make sure the booster battery is 12-volt and that its negative terminal is grounded.
If the booster battery is in another vehicle, do not allow the vehicles to come in contact.
2. Turn off all unnecessary electrical loads.
3. Connect the jumper cables in the exact sequence shown in the illustration.
 - 1) Connect one end of a jumper cable to the positive terminal of the discharged battery (1).
 - 2) Connect the other end to the positive terminal of the booster battery (2).
 - 3) Proceed to connect one end of the other jumper cable to the negative terminal of the booster battery (3), then the other end to a solid, stationary, metallic point away from the battery (4).
Do not allow the jumper cables to contact anything except the correct battery terminals or the correct ground. Do not lean over the battery when making connections.
4. Start vehicle with the booster battery and let it run at 2,000

rpm, then start the vehicle with the discharged battery.

If the cause of your battery discharging is not apparent, you should have your vehicle checked by an authorized Kia dealer.

*** NOTICE**

Make sure to connect one end of the jumper cable to the negative terminal of the booster battery, and the other end to a metallic point, far away from the battery.

Push-starting

Vehicles equipped with automatic transmission cannot be push-started, and only jump starting can be applied. Follow the directions in this page for jump-starting.

⚠ WARNING

Tow starting vehicle

Never tow a vehicle to start it. When the engine starts, the vehicle can suddenly surge forward and could cause a collision with the tow vehicle.

If the engine overheats

If your temperature gauge indicates overheating, you experience a loss of power, or hear loud pinging or knocking, the engine will probably be too hot.

If this happens, you should:

1. Pull off the road and stop as soon as it is safe to do so.
2. Place the shift lever in P and set the parking brake.
3. If the air conditioning is on, turn it off.
4. If engine coolant is running out under the vehicle or steam is coming out from underneath the hood, stop the engine. Do not open the hood until the coolant has stopped running or the steaming has stopped.
5. If there is no visible loss of engine coolant and no steam, leave the engine running and check to be sure the engine cooling fan is operating.
 - 1) If the fan is not running, turn the engine off.
6. Check to see if the water pump drive belt is missing.
 - 1) If it is not missing, check to see that it is tight.
 - 2) If the drive belt seems to be satisfactory, check for coolant leaking from the radiator, hoses or under the vehicle. (If the air conditioning had been in use, it is normal for cold water to be draining from it when you stop).

WARNING

Under the hood



While the engine is running, keep hair, hands and clothing away from moving parts such as the fan and drive belts to prevent injury.

7. If the water pump drive belt is broken or engine coolant is leaking out, stop the engine immediately and call the nearest authorized Kia dealer for assistance.
8. If you cannot find the cause of the overheating, wait until the engine temperature has returned to normal. If coolant has been lost, carefully add coolant to the reservoir to bring the fluid level in the reservoir up to the halfway mark.
9. Proceed with caution, keeping alert for further signs of overheating. If overheating happens again, call an authorized Kia dealer for assistance.

WARNING

Radiator cap



Do not remove the radiator cap when the engine is hot. This may result in coolant being blown out of the opening and cause serious burns.

Serious loss of coolant indicates there is a leak in the cooling system

and this should be checked as soon as possible by an authorized Kia dealer.

Tire Pressure Monitoring System (TPMS)

The Tire Pressure Monitoring System (TPMS) detects the pressure of vehicle's tires and displays it on the LCD display.



1. Low tire pressure telltale / TPMS malfunction indicator
2. Low tire pressure position telltale (Shown on the LCD display)

Tire Pressure Indicator

- You can check the tire pressure in the assist mode on the cluster.
 - Refer to "User Settings mode" on page 4-79.

- Tire pressure is displayed 1~2 minutes later after driving.
- If tire pressure is not displayed when the vehicle is stopped, "Drive to display" message displays. After driving, check the tire pressure.
- You can change the tire pressure unit in the user settings mode on the cluster.
 - kPa, psi, bar (Refer to "User Settings mode" on page 4-79).

*** NOTICE**

- The tire pressure may change due to factors such as parking condition, driving style, and altitude above sea level.
- The tire pressure shown on the dashboard may differ from the tire pressure measured by tire pressure gauge.

Effective use of the TPMS

⚠ WARNING

Over-inflation or under-inflation can reduce tire life, adversely affect vehicle handling, and lead to sudden tire failure that may cause loss of vehicle control resulting in an accident

Each tire, including the spare (if provided), should be checked monthly when cold and inflated to the infla-

tion pressure recommended by the vehicle manufacturer on the vehicle placard or tire inflation pressure label.

(If your vehicle has tires of a different size than the size indicated on the vehicle placard or tire inflation pressure label, you should determine the proper tire inflation pressure for those tires.)

As an added safety feature, your vehicle has been equipped with a TPMS that illuminates a low tire pressure telltale when one or more of your tires is significantly under-inflated. Accordingly, when the low tire pressure telltale illuminates, you should stop and check your tires as soon as possible, and inflate them to the proper pressure. Driving on a significantly under-inflated tire causes the tire to overheat and can lead to tire failure. Under-inflation also reduces fuel efficiency and tire tread life, and may affect the vehicle's handling and stopping ability.

Please note that the TPMS is not a substitute for proper tire maintenance, and it is the driver's responsibility to maintain correct tire pressure, even if under-inflation has not reached the level to trigger illumination of the TPMS low tire pressure telltale.

Your vehicle has also been equipped with a TPMS malfunction indicator

to indicate when the system is not operating properly. The TPMS malfunction indicator is combined with the low tire pressure telltale. When the system detects a malfunction, the telltale will flash for approximately one minute and then remain continuously illuminated. This sequence will continue upon subsequent vehicle start-ups as long as the malfunction exists. When the malfunction indicator is illuminated, the system may not be able to detect or signal low tire pressure as intended. TPMS malfunctions may occur for a variety of reasons, including the installation of replacement or alternate tires or wheels on the vehicle that prevent the TPMS from functioning properly.

Always check the TPMS malfunction telltale after replacing one or more tires or wheels on your vehicle to ensure that the replacement or alternate tires and wheels allow the TPMS to continue to function properly.

*** NOTICE**

If any of the below happens, have the system checked by an authorized Kia dealer.

1. The low tire pressure telltale / TPMS malfunction indicator does not illuminate for 3 seconds when the ENGINE START/STOP button

- is turned to the ON position or engine is running.
2. The TPMS malfunction indicator remains illuminated after blinking for approximately 1 minute.
3. The Low tire pressure position telltale remains illuminated.

Low tire pressure telltale (!)

Low tire pressure position telltale

When the TPMS warning indicators are illuminated, one or more of your tires is significantly under-inflated.

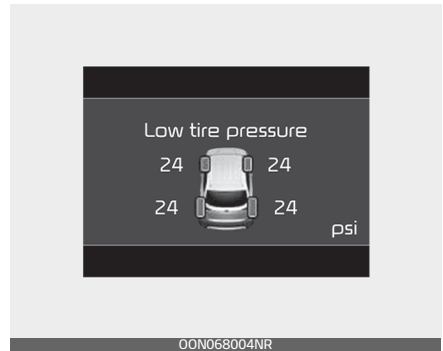

If the telltale illuminates, immediately reduce your speed, avoid hard cornering and anticipate increased stopping distances. You should stop and check your tires as soon as possible.

Inflate the tires to the proper pressure as indicated on the vehicle's placard or tire inflation pressure label located on the driver's side center pillar outer panel. If you can-

not reach a service station or if the tire cannot hold the newly added air, replace the low pressure tire with the spare tire.

Then the TPMS malfunction indicator and the Low Tire Pressure telltale may turn on and illuminate after restarting and about 20 minutes of continuous driving before you have the low pressure tire repaired and replaced on the vehicle.

In winter or cold weather, the low tire pressure telltale may be illuminated if the tire pressure was adjusted to the recommended tire inflation pressure in warm weather. It does not mean your TPMS is malfunctioning because the decreased temperature leads to a proportional lowering of tire pressure.

You should check the tire inflation pressure and adjust the tires to the recommended tire inflation pressure when driving your vehicle in the following conditions.

- from a warm area to a cold area
- from a cold area to a warm area
- the outside temperature is extremely high or low

When filling tires with more air, conditions to turn off the low tire pressure telltale may not be met. This is because a tire inflator has a margin of error in performance. The low tire pressure telltale will be turned off if the tire pressure is above the

recommended tire inflation pressure.

⚠ WARNING

Low pressure damage

Do not drive on low pressure tires. Significantly low tire pressure can cause the tires to overheat and fail making the vehicle unsafe resulting in increased braking distances and a loss of vehicle control.

TPMS malfunction indicator 

The low tire pressure telltale will illuminate after it blinks for approximately one minute when there is a problem with the TPMS.

If the system is able to correctly detect an underinflation warning at the same time as system failure, it will illuminate both the TPMS malfunction and the low tire pressure position telltales. For example, if the Front Left sensor fails, the TPMS malfunction indicator illuminates, but if the Front Right, Rear Left, or Rear Right tire is underinflated, the low tire pressure position telltales may illuminate together with the TPMS malfunction indicator.

Have the system checked by an authorized Kia dealer as soon as possible to determine the cause of the problem.

- The TPMS malfunction indicator may be illuminated if the vehicle is moving around electric power supply cables or radios transmitters such as at police stations, government and public offices, broadcasting stations, military installations, airports, or transmitting towers, etc. This can interfere with normal operation of the TPMS.
- The TPMS malfunction indicator may illuminate if the vehicle is equipped with snow chains or some personal electronic devices (such as a laptop computer, mobile charger, remote starter or navigation) are being used in the vehicle. This can interfere with normal operation of the TPMS.

Tire replacement with TPMS

If you have a flat tire, the Low Tire Pressure telltale will come on. Have the flat tire repaired by an authorized Kia dealer as soon as possible or replace the flat tire with the spare tire.

CAUTION

Repair Agents

Never use a puncture-repairing agent not approved by Kia to repair and/or inflate a low pressure tire. The sealant not approved by Kia

may damage the tire pressure sensor.

Each wheel is equipped with a tire pressure sensor mounted inside the tire behind the valve stem. You must use TPMS specific wheels. It is recommended that you always have your tires serviced by an authorized Kia dealer.

Even if you replace the low pressure tire with the spare tire, the Low Tire Pressure telltale will remain on until the low pressure tire is repaired and placed on the vehicle.

After you replace the low pressure tire with the spare tire, the TPMS malfunction indicator may illuminate after a few minutes. This is because the TPMS sensor mounted on the spare wheel is not yet activated.

Once the low pressure tire is inflated again to the recommended pressure and installed on the vehicle or the TPMS sensor mounted on the replaced spare wheel is initiated by an authorized Kia dealer, the TPMS malfunction indicator and the low tire pressure telltale will turn off within a few minutes of driving.

If the indicator has not disappeared after a few minutes of driving, please visit an authorized Kia dealer.

If an original mounted tire is replaced with the spare tire, the TPMS sensor on the replaced spare wheel should be initiated and the TPMS sensor on the original mounted wheel should be deactivated. If the TPMS sensor on the original mounted wheel located in the spare tire carrier still activates, the Tire Pressure Monitoring System may not operate properly. Have the tire with TPMS serviced or replaced by an authorized Kia dealer.

You may not be able to identify a low tire by simply looking at it. Always use a good quality tire pressure gauge to measure the tire's inflation pressure. Please note that a tire that is hot (from being driven) will have a higher pressure measurement than a tire that is cold (from sitting stationary for at least 3 hours and driven less than 1.6 km (1 mile) during that 3 hour period).

Allow the tire to cool before measuring the inflation pressure. Always be sure the tire is cold before inflating to the recommended pressure.

A cold tire means the vehicle has been sitting for 3 hours and driven for less than 1.6 km (1 mile) in that 3 hour period.

Never use tire sealant if your vehicle is equipped with a TPMS. The liquid sealant can damage the tire pressure sensors.

- The TPMS cannot alert you to severe and sudden tire damage caused by external factors such as nails or road debris.
- If you feel any vehicle instability, immediately take your foot off the accelerator, apply the brakes gradually and with light force, and slowly move to a safe position off the road.

*** NOTICE**

Protecting TPMS

Tampering with, modifying, or disabling the Tire Pressure Monitoring System (TPMS) components may interfere with the system's ability to warn the driver of low tire pressure conditions and/or TPMS malfunctions. Tampering with, modifying, or disabling the Tire Pressure Monitoring System (TPMS) components may void the warranty for that portion of the vehicle.

This device complies with Industry Canada licence-exempt RSS standard(s).

Operation is subject to the following conditions:

1. This device may not cause interference, and
2. This device must accept any interference, including interference that may cause undesired operation of the device.

3. Changes or modifications not expressly approved by the party responsible for compliance could void the user's authority to operate the device.

If you have a flat tire (with spare tire)

If you have a flat tire, you can change the flat tire to a spare tire using tools.

WARNING

Driving on a flat tire will cause permanent damage to the tire. Re-inflating a tire after it has been driven on while severely underinflated or flat may cause a blowout and a serious crash. Never attempt to re-inflate a tire that has been driven on while severely underinflated or flat. In this case, repair or replace the flat tire as soon as possible.

WARNING

Changing a tire can be dangerous. Follow the instructions in this section when changing a tire to reduce the risk of serious injury or death.

CAUTION

Be careful as you use the jack handle to stay clear of the flat end. The flat end has sharp edges that could cause cuts.

Jack and tools



1. Jack handle
2. Wheel nut wrench
3. Driver
4. Socket
5. Jack

The jack and tools are stored in the luggage side trim.

Remove the tray cover indicated in the illustration.

Jacking instructions

The jack is provided for emergency tire changing only.

- To prevent the jack from "rattling" while the vehicle is in motion, store it properly.
- Follow jacking instructions to reduce the possibility of personal injury.

⚠ WARNING

Changing tires

- Never attempt vehicle repairs in the traffic lanes of a public road or highway.
- Always move the vehicle completely off the road and onto the shoulder before trying to change a tire. The jack should be used on firm level ground. If you cannot find a firm level place off the road, call a towing service company for assistance.
- Be sure to use the correct front and rear jacking positions on the vehicle; never use the bumpers or any other part of the vehicle for jacking support.
- The vehicle can roll off the jack causing serious injury or death.
- Do not get under a vehicle that is supported by a jack.
- Do not start or run the engine while the vehicle is on the jack.
- Do not allow anyone to remain in the vehicle while it is on the jack.
- Make sure any children present are in a secure place away from the road and from the vehicle to be raised with the jack.

⚠ WARNING

Tire jack

Do not place any portion of your body under a vehicle that is only supported by a jack since the vehicle

can easily roll off the jack. Use vehicle support stands.

⚠ WARNING

Changing tires

Never attempt vehicle repairs in the traffic lanes of a public road or highway.

- Always move the vehicle completely off the road and onto the shoulder before trying to change a tire. The jack should be used on a firm level ground. If you cannot find a firm, level place off the road, call a towing service company for assistance.
- Be sure to use the correct front and rear jacking positions on the vehicle; never use the bumpers or any other part of the vehicle for jack support.
- Do not allow anyone to remain in the vehicle while it is on the jack.
- Make sure any children present are in a secure place away from the road and from the vehicle to be raised with the jack.

⚠ WARNING

Running vehicle on jack

Do not start or run the engine of the vehicle while the vehicle is on the jack as this may cause the vehicle to fall off the jack.

To prevent the jack from "rattling" while the vehicle is in motion, store it properly.

*** NOTICE**

Retreaded tires

Possibly substantial variations in the design and age of the tire casing structures can limit service life and have a negative impact on road safety.

Removing the spare tire

Your spare tire is stored underneath the back of your vehicle, directly below the right sliding door.

To remove the spare tire:

1. Open the luggage floor cover and find the plastic hex bolt cover on the floor.



2. Remove the cover.
3. Use the tool to loosen the bolt enough to lower the spare tire.

Turn the tool counterclockwise until the spare tire reaches the ground.



4. After the spare tire reaches the ground, continue to turn the tool counterclockwise, and draw the spare tire outside. Never rotate the tool excessively, otherwise the spare tire carrier may be damaged.



5. Remove the retainer from the center of the spare tire.

Storing the spare tire



1. Place the wheel under the vehicle and install the retainer through the wheel center.
2. Turn the tool clockwise until it clicks.

Ensure the spare tire retainer is properly aligned with the center of the spare tire to prevent the spare tire from "rattling".

Otherwise, it may cause the spare tire to fall off the carrier and lead to an accident.

Changing tires

⚠ WARNING

A vehicle can slip or roll off of a jack causing serious injury or death to you or those nearby. Take the following safety precautions:

- Never place any portion of your body under a vehicle that is supported by a jack.
- NEVER attempt to change a tire in the lane of traffic. ALWAYS move

the vehicle completely off the road on level, firm ground away from traffic before trying to change a tire. If you cannot find a level, firm place off the road, call a towing service for assistance.

- Be sure to use the jack provided with the vehicle.
- ALWAYS place the jack on the designated jacking positions on the vehicle and NEVER on the bumpers or any other part of the vehicle for jacking support.
- Do not start or run the engine while the vehicle is on the jack.
- Do not allow anyone to remain in the vehicle while it is on the jack.
- Keep children away from the road and the vehicle.

1. Park on a level surface and apply the parking brake firmly.
2. Place the transmission shift lever in P (Park).
3. Activate the hazard warning flashers.



4. Remove the wheel lug nut wrench, jack and spare tire from the vehicle.



5. Block both the front and rear of the wheel that is diagonally opposite from the jack position.

⚠ WARNING

Jack location

To reduce the possibility of injury, be sure to use only the jack provided with the vehicle in the correct jack position; never use any other part of the vehicle for jack support.

⚠ WARNING

Changing a tire

- To prevent vehicle movement while changing a tire, always set the parking brake fully, and always block the wheel diagonally opposite the wheel being changed.
- We recommend that the wheels of the vehicle be blocked, and that

no person remain in a vehicle that is being jacked.

- 6. Loosen the wheel lug nuts counterclockwise one turn each, but do not remove any nut until the tire has been raised off the ground.



- 7. Place the jack at the front (1) or rear (2) jacking position closest to the tire you are changing. Place the jack at the designated locations under the frame. The jacking positions are plates welded to the frame with two tabs and a raised dot to line up with the jack.



- 8. Insert the wheel lug nut wrench into the jack and turn it clockwise, raising the vehicle until the tire just clears the ground. This measurement is approximately 30 mm (1 in).



Before removing the wheel lug nuts, make sure the vehicle is s and that there is no chance for movement or slippage.

- 9. Loosen the wheel nuts and remove them with your fingers.
- 10. Slide the wheel off the studs and lay it flat so it cannot roll away.
- 11. To put the wheel on the hub, pick up the spare tire, line up the holes with the studs and slide the wheel onto them. If this is difficult, tip

the wheel slightly and get the top hole in the wheel lined up with the top stud.

12. Jiggle the wheel back and forth until the wheel can slide over the other studs.

Wheels may have sharp edges. Handle them carefully to avoid possible severe injury. Before putting the wheel into place, be sure that there is nothing on the hub or wheel (such as mud, tar, gravel, etc.) that prevents the wheel from fitting solidly against the hub.

WARNING

Installing a wheel

- When you install a wheel, always remove any corrosion, dirt or foreign materials present on the mounting surfaces of the wheel or the surface of the wheel hub, brake drum or brake disc that contacts the wheel. Make sure to secure any fasteners that attach the rotor to the hub so they do not interfere with the mounting surfaces of the wheel. Installing wheels without correct metal-to-metal contact at the wheel mounting surfaces can cause the wheel nuts to loosen and the wheel to come off while your vehicle is in motion, resulting in loss of vehicle control, personal injury or death.
- Make sure the wheel makes good contact with the hub when installed. If the contact of the mounting surface between the wheel and hub is not good, the wheel nuts could come loose and cause the loss of a wheel. Loss of a wheel may result in loss of control of the vehicle.

WARNING

Wheel covers will not fit on the vehicle's compact spare. If you try to put a wheel cover on the compact spare, the cover or the spare could be damaged.

13. To install the wheel, hold it on the studs, put the wheel nuts on the studs and tighten them finger tight.
14. Jiggle the tire to be sure it is completely seated, then tighten the nuts as much as possible with your fingers again.
15. Insert the wrench into the jack and lower the vehicle to the ground by turning the wheel nut wrench counterclockwise.
16. Position the wrench as shown in the drawing and tighten the wheel nuts. Be sure the socket is seated completely over the nut. Do not stand on the wrench handle or use an extension pipe over the wrench handle.
17. Go around the wheel, tightening every nut following the numerical

sequence shown in the image until they are all tight. Double-check each nut for tightness.



- 18. After changing wheels, have an authorized Kia dealer tighten the wheel nuts to their proper torque as soon as possible.
- 19. To prevent the jack, wheel lug nut wrench and spare tire from rattling while the vehicle is in motion, store them properly.
- 20. Check the inflation pressures as soon as possible after installing the spare tire. Adjust it to the specified pressure, if necessary. Refer to "Tires and wheels" on page 8-5.

Wheel nut tightening torque:

11~13 kgf·m (79~94 lbf·ft)

If you have a tire gauge, remove the valve cap and check the air pressure. If the pressure is lower than recommended, drive slowly to the nearest service station and inflate to the correct pressure. If it is too high, adjust it until it is correct. Always reinstall the valve cap after checking

or adjusting the tire pressure. If the cap is not replaced, dust and dirt may get into the tire valve and air may leak from the tire. If you lose a valve cap, buy another and install it as soon as possible.

After you have changed the wheels, always secure the flat tire in its place and return the jack and tools to their proper storage locations.

⚠ CAUTION

Reusing lug nuts

Make certain during wheel removal that the same nuts that were removed are reinstalled – or, if replaced, that nuts with metric threads and the same chamfer configuration are used. Your vehicle has metric threads on the wheel studs and nuts. Installation of a non-metric thread nut on a metric stud will not secure the wheel to the hub properly and will damage the stud so that it must be replaced.

Note that most lug nuts do not have metric threads. Be sure to use extreme care in checking for thread style before installing aftermarket lug nuts or wheels. If in doubt, consult an authorized Kia dealer.

⚠ WARNING**Wheel studs**

If the studs are damaged, they may lose their ability to retain the wheel. This could lead to the loss of the wheel and a collision resulting in serious injuries.

⚠ WARNING

Never use oil or grease on bolts or nuts because the nuts might come loose. The vehicle's wheel could fall off, causing a crash.

Important - use of compact spare tire

Your vehicle is equipped with a compact spare tire. This compact spare tire takes up less space than a regular-size tire. This tire is smaller than a conventional tire and is designed for temporary use only.

- You should drive carefully when the compact spare is in use. The compact spare should be replaced by the proper conventional tire and rim at the first opportunity.
- The operation of this vehicle is not recommended with more than one compact spare tire in use at the same time.

⚠ WARNING**Spare tire**

The compact spare tire is for emergency use only. Do not operate your vehicle on this compact spare at speeds over 80 km/h (50 mph). The original tire should be repaired or replaced as soon as possible to avoid failure of the spare possibly leading to bodily injury or death.

The compact spare should be inflated to 420 kPa (60 psi).

*** NOTICE**

Check the inflation pressure after installing the spare tire. Adjust it to the specified pressure, as necessary.

When using a compact spare tire, observe the following precautions:

- Under no circumstances should you exceed 80 km/h (50 mph); a higher speed could damage the tire.
- Ensure that you drive slowly enough for the road conditions to avoid all hazards. Any road hazard, such as a pothole or debris, could seriously damage the compact spare.
- Any continuous road use of this tire could result in tire failure, loss of vehicle control, and possible personal injury.

- Do not exceed the vehicle's maximum load rating or the load-carrying capacity shown on the sidewall of the compact spare tire.
 - Avoid driving over obstacles. The compact spare tire diameter is smaller than the diameter of a conventional tire and reduces the ground clearance approximately 25 mm (1 inch), which could result in damage to the vehicle.
 - Do not take this vehicle through an automatic vehicle wash while the compact spare tire is installed.
 - Do not use the compact spare tire on any other vehicle because this tire has been designed especially for your vehicle.
 - The compact spare tire's tread life is shorter than a regular tire. Inspect your compact spare tire regularly and replace worn compact spare tires with the same size and design, mounted on the same wheel.
 - The compact spare tire should not be used on any other wheels, nor should standard tires, snow tires, wheel covers or trim rings be used with the compact spare wheel. If such use is attempted, damage to these items or other vehicle components may occur.
 - Do not use more than one compact spare tire at a time.
 - Do not tow a trailer while the compact spare tire is installed.
- Do not suddenly accelerate or decelerate (0 ↔ 40 km/h) in any driving mode. It may cause leakage of transfer oil.

Jack label

Type A

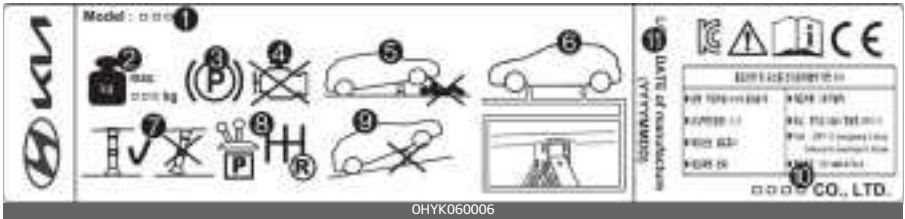

OHYK060006

Type B

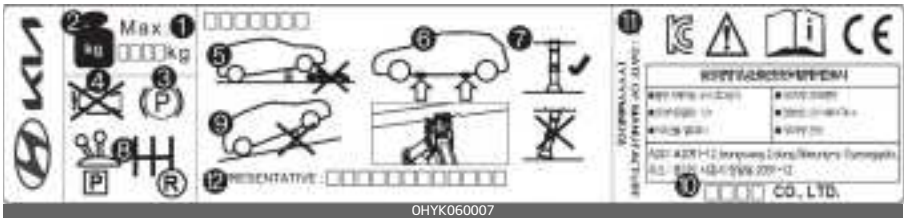

OHYK060007

Type C



OSK3068045NR

* The actual jack label in the vehicle may differ from the illustration. For more detailed specifications, refer to the label attached to the jack.

1. Model Name
2. Maximum allowable load
3. When using the jack, set your parking brake.
4. When using the jack, stop the engine.
5. Do not get under a vehicle that is supported by a jack.
6. The designated locations under the frame
7. When supporting the vehicle, the base plate of jack must be vertical under the lifting point.
8. Move the shift lever to the P position on vehicles with intelligent variable transmission.
9. The jack should be used on firm level ground.
10. Jack manufacturer
11. Production date
12. Representative company and address

Towing

If emergency towing is necessary, we recommend having it done by an authorized Kia dealer or a commercial tow-truck service.

Towing service

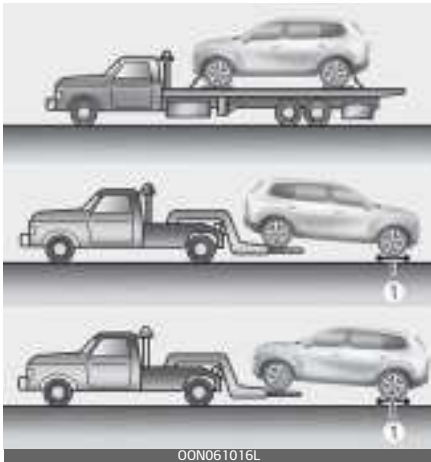

Proper lifting and towing procedures are necessary to prevent damage to the vehicle. The use of wheel dollies (1) or flatbed is recommended.

On All Wheel Drive (AWD) vehicles, your vehicle must be towed with a wheel lift and dollies or flatbed equipment with all the wheels off the ground.

⚠ WARNING

Side and curtain Air bag

If your vehicle is equipped with side and curtain air bag, set the ENGINE

START/STOP button to ACC position when the vehicle is being towed.

The side and curtain air bag may deploy when the ENGINE START/STOP button to ON position and the rollover sensor detects the situation as a rollover.

* NOTICE

If the EPB does not release normally, take your vehicle to an authorized Kia dealer by loading the vehicle on a flatbed tow truck and have the system checked.

⚠ CAUTION

Towing



- Do not tow the vehicle backwards with the front wheels on the ground as this may cause damage to the transmission.

- Do not tow with sling-type equipment. Use wheel lift or flatbed equipment.
-

WARNING

- If you tow the vehicle while the front wheels are touching the ground, the vehicle motor may generate electricity and the motor components may be damaged or a fire may occur.
 - When a vehicle fire occurs due to the battery, there is a risk of a second fire. Contact the fire department when towing the vehicle.
-

Towing without wheel dollies when using a towing service

When towing your vehicle in an emergency without wheel dollies:

1. Set the ENGINE START/STOP button to ACC position.
2. Place the transmission shift lever in N (Neutral).
3. Release the parking brake.

CAUTION

Towing gear position

Failure to shift to N (Neutral) may cause internal damage to the vehicle.

Engine compartment	7-4
Maintenance services	7-5
Owner maintenance	7-6
Scheduled maintenance service	7-8
• Normal maintenance schedule - Non Turbo Models	7-10
• Maintenance Under Severe Usage Conditions - Non Turbo Models	7-13
Explanation of scheduled maintenance items	7-14
Engine oil and filter	7-18
• Checking the engine oil level.....	7-18
• Changing the engine oil and filter	7-19
Engine coolant	7-20
• Checking the coolant level.....	7-21
• Changing the coolant	7-22
Brake fluid	7-22
• Checking the brake fluid level.....	7-22
Washer fluid	7-24
• Checking the washer fluid level.....	7-24
Air cleaner filter	7-25
• Replacing air cleaner filter	7-25
Climate control air filter	7-26
• Inspecting and replacing climate control air filter	7-26
Wiper blades	7-28
• Front windshield wiper blade	7-28
• Replacing rear window wiper blade.....	7-30
Battery	7-31
• For best battery service.....	7-31

7 Maintenance

• Battery recharging	7-32
• Reset items	7-33
Tires and wheels	7-34
• Checking tire inflation pressure	7-35
• Tire rotation	7-36
• Wheel alignment and tire balance	7-36
• Tire replacement	7-37
• Wheel replacement	7-37
• Tire traction.....	7-38
• Tire maintenance.....	7-38
• Tire sidewall labeling.....	7-38
• Tire terminology and definitions	7-41
• All season tires	7-44
• Summer tires	7-44
• Snow tires	7-44
• Radial-ply tires.....	7-45
• Low aspect ratio tire.....	7-45
Fuses	7-46
• Replacing inner panel fuse	7-48
• Replacing engine compartment fuse	7-49
• Fuse/relay panel description	7-51
Light bulbs.....	7-60
• Headlamp bulb	7-63
• Replacing Headlamp (Low/High) / Position lamp / Daytime running lamp / Turn signal lamp (LED Type) bulb (Headlamp Type B)	7-64
• Replacing Headlamp (Low/High) / Front turn signal lamp bulb (Headlamp Type A)	7-64
• Replacing Position lamp + DRL (LED type) bulb (Headlamp Type A)	7-65

• Replacing front fog lamp bulb.....	7-65
• Replacing side repeater lamp (LED Type) bulb.....	7-65
• Replacing turn signal lamp (bulb Type) bulb.....	7-66
• Replacing Stop and tail lamp bulb (Rear combination lamp Type A)	7-66
• Replacing Tail lamp/Stop lamp/Rear turn signal lamp bulb (Rear combination lamp Type B)	7-67
• Replacing Back Up lamp bulb (Rear combination lamp Type A/B)	7-67
• Replacing High Mounted Stop Lamp (LED type) bulb.....	7-67
• Replacing license plate lamp bulb	7-68
• Replacing map lamp (bulb type) bulb.....	7-68
• Replacing map lamp (LED type) bulb	7-68
• Replacing vanity mirror lamp bulb	7-69
• Replacing room lamp (bulb type) bulb	7-69
• Replacing room lamp (LED type) bulb.....	7-70
• Replacing personal lamp (LED Type) bulb	7-70
• Replacing glove box lamp	7-71
• Replacing luggage lamp bulb	7-71
• Replacing luggage lamp (LED Type) bulb	7-71
Appearance care	7-72
• Exterior care.....	7-72
• Interior care.....	7-78
Emission control system	7-80

Maintenance

Engine compartment

Open the hood to see the engine compartment.

(Gasoline) 3.8 GDi



* The actual engine cover in the vehicle may differ from the illustration.

1. Engine coolant reservoir
2. Engine oil filler
3. Brake fluid reservoir
4. Air cleaner
5. Fuse box
6. Negative battery terminal
7. Positive battery terminal
8. Engine oil dipstick
9. Radiator cap
10. Windshield washer fluid reservoir

Maintenance services

You should exercise the utmost care to prevent damage to your vehicle and injury to yourself whenever performing any maintenance or inspection procedures.

Should you have any doubts concerning the inspection or servicing of your vehicle, we strongly recommend that you have an authorized Kia dealer perform this work.

An authorized Kia dealer has factory-trained technicians and genuine Kia parts to service your vehicle properly. For expert advice and quality service, see an authorized Kia dealer.

Inadequate, incomplete or insufficient servicing may result in operational problems with your vehicle that could lead to vehicle damage, an accident, or personal injury.

Owner's responsibility

* NOTICE

Maintenance Service and Record Retention are the owner's responsibility.

You should retain documents that show proper maintenance has been performed on your vehicle in accordance with the scheduled maintenance service charts shown on the following pages. You need this

information to establish your compliance with the servicing and maintenance requirements of your vehicle warranties.

Detailed warranty information is provided in your Warranty & Consumer Information manual.

Repairs and adjustments required as a result of improper maintenance or a lack of required maintenance are not covered.

We recommend you have your vehicle maintained and repaired by an authorized Kia dealer. Authorized Kia dealers meet Kia's high service quality standards and receive technical support from Kia in order to provide you with a high level of service satisfaction.

Owner maintenance precautions

Improper or incomplete service may result in problems. This section gives instructions only for the maintenance items that are easy to perform.

As explained earlier in this section, several procedures can be done only by an authorized Kia dealer with special tools.

* NOTICE

Improper owner maintenance during the warranty period may affect

warranty coverage. For details, read the separate Warranty & Consumer Information manual provided with the vehicle. If you're unsure about any servicing or maintenance procedure, have it done by an authorized Kia dealer.

⚠ WARNING

Maintenance work

Do not wear jewelry or loose clothing while working under the hood of your vehicle with the engine running. These items can become entangled in moving parts, if you must run the engine while working under the hood, make certain that you remove all jewelry (especially rings, bracelets, watches, and necklaces) and all neckties, scarves, and similar loose clothing before getting near cooling fans.

⚠ WARNING

Touching metal parts

Do not touch metal parts (including strut bars) while the vehicle is operating or hot. Doing so could result in serious bodily injury. Turn the vehicle off and wait until the metal parts cool down to perform maintenance work on the vehicle.

Owner maintenance

The following lists detail the vehicle checks and inspections that should be performed by the owner or an authorized Kia dealer. They should be performed at the indicated frequencies to help ensure the safe and dependable operation of your vehicle.

Any adverse conditions should be brought to the attention of your dealer as soon as possible.

These owner maintenance checks are generally not covered by warranties and you may be charged for labor, parts and lubricants used.

When you stop for fuel:

- Check the coolant level in coolant reservoir.
- Check the windshield washer fluid level.
- Look for low or under-inflated tires. Check if the front of the radiator and condenser are clean and not blocked with leaves, dirt or insects etc. If any of the above parts are extremely dirty or you are not sure of their condition, take your vehicle to an authorized Kia dealer.

⚠ WARNING

Hot coolant

Be careful when checking your engine coolant level when the engine is hot. Scalding hot coolant and steam may blow out under pressure.

While operating your vehicle:

- Check for vibrations in the steering wheel. Notice any increased steering effort or looseness in the steering wheel, or change in its straight-ahead position.
- Notice if your vehicle constantly turns slightly or "pulls" to one side when traveling on smooth, level road.
- When stopping, listen and check for unusual sounds, pulling to one side, increased brake pedal travel or "hard-to-push" brake pedal.
- If any slipping or changes in the operation of your transmission occurs, take your vehicle to an authorized Kia dealer.
- Check the automatic transmission P (Park) function.
- Check the parking brake.
- Check for fluid leaks under your vehicle (water dripping from the air conditioning system during or after use is normal).

At least monthly:

- Check the coolant level in the coolant reservoir.
- Check the operation of all exterior lights, including the stoplights, turn signals and hazard warning flashers.
- Check the inflation pressures of all tires including the spare for tires that are worn, show uneven wear, or are damaged.
- Check for loose wheel lug nuts.

At least twice a year (i.e., every Spring and Fall):

- Check the radiator, heater and air conditioning hoses for leaks or damage.
- Check the windshield washer spray and wiper operation. Clean the wiper blades with clean cloth dampened with washer fluid.
- Check the headlight alignment.
- Check the lap/shoulder belts for wear and function.

At least once a year:

- Clean the body and door drain holes.
- Lubricate the door hinges and check the hood hinges.
- Lubricate the door and hood locks and latches.
- Lubricate the door rubber weatherstrips.
- Check the air conditioning system.

- Inspect and lubricate automatic transmission linkage and controls.
- Clean the battery and terminals.
- Check the brake fluid level.
- Visually inspect steering, suspension, and chassis components for damaged, loose, or missing parts or signs of wear.

Scheduled maintenance service

Follow the Normal Maintenance Schedule if the vehicle is usually operated where none of the following conditions apply.

Follow the Maintenance Under Severe Usage Conditions if any of the following conditions apply.

- Repeated driving short distance of less than 8 km (5 miles) in normal temperature or less than 16 km (10 miles) in freezing temperature.
- Extensive engine idling or low speed driving for long distances.
- Driving on rough, dusty, muddy, unpaved, graveled or salt-spread roads.
- Driving in areas using salt or other corrosive materials or in very cold weather.
- Driving in heavy dust condition.
- Driving in heavy traffic area.
- Driving on uphill, downhill, or mountain road repeatedly.
- Using for towing or camping and driving with loading on the roof
- Vehicle towing, driving for patrol car, taxi, or other commercial use.
- Frequently driving under high speed or rapid acceleration/deceleration.
- Frequently driving in stop-and-go condition.

If your vehicle is operated in any of the prior listed conditions, you

should inspect, replace or refill more frequently, using the severe usage maintenance schedule instead of the normal usage maintenance schedule.

Normal maintenance schedule – Non Turbo Models

The following maintenance services must be performed to ensure good emission control and performance. Keep receipts for all vehicle services to protect your warranty. Where both mileage and date are shown, the frequency of service is determined by whichever occurs first.

I: Inspect and if necessary, adjust, correct, clean or replace.

R: Replace or change

Number of months or driving distance, whichever comes first															
Months	12	24	36	48	60	72	84	96	108	120	132	144	156	168	180
Miles×1,000	7.5	15	22.5	30	37.5	45	52.5	60	67.5	75	82.5	90	97.5	105	112.5
Km×1,000	12	24	36	48	60	72	84	96	108	120	132	144	156	168	180
Tire rotation	Rotate every 12,000 km (7,500 miles)														
Fuel additives *1	Add every 12,000 km (7,500 miles) or 12 months														
Engine oil and engine oil filter *2	R	R	R	R	R	R	R	R	R	R	R	R	R	R	R
Climate control air filter	-	R	-	R	-	R	-	R	-	R	-	R	-	R	-
Spark plugs	Replace every 156,000 km (97,500 miles)														
Coolant (Engine)	At first, replace at 192,000 km (120,000 miles) or 10 years, after that, replace every 48,000 km (30,000 miles) or 24 months														
Cooling system hoses and connections	Inspect every 12,000 km (7,500 miles) or 6 months														
Brake pedal free play															
Air cleaner filter	I	I	I	R	I	I	I	R	I	I	I	R	I	I	I
Brake fluid															

Number of months or driving distance, whichever comes first																
Months	12	24	36	48	60	72	84	96	108	120	132	144	156	168	180	
Miles×1,000	7.5	15	22.5	30	37.5	45	52.5	60	67.5	75	82.5	90	97.5	105	112.5	
Km×1,000	12	24	36	48	60	72	84	96	108	120	132	144	156	168	180	
Vacuum hose																
Air conditioner compressor/ refrigerant																
Exhaust system																
Bolt and nuts on chassis and body																
Brake lines, hoses and connections (including booster)																
Parking brake																
Brake discs and pads																
Suspension ball joints and mounting bolts																
Steering gear rack, linkage and boots																
Tire (pressure & tread wear)																
All latch, hinges and locks	Inspect every 24,000 km (15,000 miles) or 12 months															
Drive shaft and boots																
Propeller shaft																
Fuel tank and fuel cap	-		-		-		-		-		-		-		-	
Fuel lines, hoses and connections																
Fuel tank air filter *3																
Cooling system	-	-	-		-		-		-		-		-		-	
Rear axle oil (AWD) *4	Inspect every 60,000 km (37,500 miles) or 48 months															
Transfer case oil (AWD) *4	Inspect every 60,000 km (37,500 miles) or 48 months															
Drive belts *5	At first, inspect at 96,000 km (60,000 miles) or 72 months, after that, inspect every 24,000 km (15,000 miles) or 24 months															
Valve clearance *6	Inspect every 96,000 km (60,000 miles) or 72 months															
Automatic Transmission fluid	No service required															

* 1. If TOP TIER Detergent Gasoline is not available, one bottle of additive is recommended. Additives are available from your authorized Kia dealer along with information on how to use them. Do not mix other additives.

* 2. As it is normal for engine oil to be consumed during driving, the engine oil level should be checked on regular basis. The engine oil change interval for normal oper-

ating conditions is based on the use of the recommended engine specification. If the recommended engine oil specification is not used, then replace the engine oil according to the maintenance schedule under severe operating conditions.

- * 3. Fuel tank air filter is considered to be maintenance free but periodic inspection is recommended as the level of maintenance will be dependent upon the quality fuel used in the vehicle.
- * 4. If the vehicle has been submerged in water or in a flooded area, the fluids should be changed as a precaution.
- * 5. The drive belt should be replaced when cracks occur or tension is reduced.
- * 6. Inspect for excessive valve noise and/or engine vibration and adjust if necessary. Have an authorized Kia dealer perform the operation.
- Fuel filter (gasoline engine): The fuel filter is considered to be maintenance free but periodic inspection is recommended for this maintenance schedule depends on fuel quality.
 - If there are some important safety matters like fuel flow restriction, surging, loss of power, hard starting problem etc., replace the fuel filter immediately regardless of maintenance schedule and consult an authorized Kia dealer for details.

Maintenance Under Severe Usage Conditions – Non Turbo Models

The following items must be serviced more frequently on cars mainly used under severe driving conditions. Refer to the chart below for the appropriate maintenance intervals.

R: Replace

I: Inspect and if necessary, adjust, correct, clean or replace

Maintenance item	Maintenance operation	Maintenance intervals	Driving condition
Engine oil and engine oil filter	R	Every 6,000 km (3,750 miles) or 6 months	A, B, C, D, E, F, G, H, I, J, K
Automatic transmission fluid	R	Every 96,000 km (60,000 miles)	A, C, F, G, H, I, J, K
Transfer case oil (AWD)	R	Every 120,000 km (75,000 miles)	C, E, G, H, I, J
Rear axle oil (AWD)	R	Every 120,000 km (75,000 miles)	C, E, G, H, I, J
Air cleaner filter	R	More frequently	C, E
Spark plugs	R	More frequently	A, B, F, G, H, I, K
Climate control air filter	I	More frequently	C, E, G
Parking brake	I	More frequently	C, D, G, H
Brake discs, pads and calipers	I	More frequently	C, D, E, G, H, I, J, K
Suspension ball joints and mounting bolts	I	More frequently	C, D, E, F, G
Steering gear rack, linkage and boots	I	More frequently	C, D, E, F, G
Drive shafts and boots	I	More frequently	C, D, E, F, G, H, I, J
Propeller shaft	I	More frequently	C, D, E, F, G, H, I, J

Severe Driving Conditions

A: Repeatedly driving short distance of less than 8 km (5 miles) in normal temperature or less than 16 km (10 miles) in freezing temperature.

B: Extensive low speed driving for long distances.

C: Driving on rough, dusty, muddy, unpaved, graveled or salt-spread roads.

D: Driving in areas using salt or other corrosive materials or in very cold weather.

E: Driving in heavy dust condition.

F: Driving in heavy traffic area.

G: Driving on uphill, downhill, or mountain roads.

H: Using for towing or camping and driving with loading on the roof

I: Vehicle towing, driving for patrol car, taxi, or other commercial use.

J: Frequently driving under high speed or rapid acceleration/deceleration

K: Frequently driving in stop-and-go conditions

Explanation of scheduled maintenance items

The following parts require scheduled maintenance.

Engine oil and filter

The engine oil and filter should be changed at the intervals specified in the maintenance schedule. If the vehicle is being driven in severe conditions, more frequent oil and filter changes are required.

Drive belts

Inspect all drive belts for evidence of cuts, cracks, excessive wear or oil saturation and replace if necessary. Drive belts should be checked periodically for proper tension and adjusted as necessary.

Fuel filter

Kia gasoline vehicles are equipped with a lifetime fuel filter that is integrated with the fuel tank. Regular maintenance or replacement is generally not needed. This may vary depending on fuel quality. If you experience any of the following: fuel flow restriction, surging, loss of power, or a hard starting issue, inspection and, if necessary, replacement may be needed. Have the fuel filter inspected or replaced by an authorized Kia dealer.

Fuel lines, fuel hoses and connections

Check the fuel lines, fuel hoses and connections for leakage and damage. Have an authorized Kia dealer replace any damaged or leaking parts immediately.

Fuel tank and fuel cap

The fuel tank and fuel cap should be inspected at those intervals specified in the maintenance schedule. Make sure that a new fuel tank or fuel cap is correctly replaced.

Vacuum crankcase ventilation hoses

Inspect the surface of hoses for evidence of heat and/or mechanical damage. Hard and brittle rubber, cracking, tears, cuts, abrasions, and excessive swelling indicate deterioration. Particular attention should be paid to examine those hose surfaces nearest to high heat sources, such as the exhaust manifold.

Inspect the hose routing to assure that the hoses do not come in contact with any heat source, sharp edges or moving components which might cause heat damage or mechanical wear. Inspect all hose connections, such as clamps and couplings, to make sure they are secure, and that no leaks are present. Hoses should be replaced

immediately if there is any evidence of deterioration or damage.

Air cleaner filter

A Genuine Kia air cleaner filter is recommended when the filter is replaced.

Spark plugs

Make sure to install new spark plugs of the correct heat range.

When assembling parts, be sure to wipe the inside and outside of the boot bottom of the ignition coil and the insulator of the spark plug with a soft cloth to prevent contamination of the spark plug insulator.

Valve clearance (if equipped)

Inspect for excessive valve noise and/or engine vibration and adjust if necessary. An authorized Kia dealer should perform the operation.

Cooling system

Check the cooling system components, such as the radiator, coolant reservoir, hoses and connections for leakage and damage. Replace any damaged parts.

Coolant

The coolant should be changed at the intervals specified in the maintenance schedule.

Automatic transmission fluid

Automatic transmission fluid should not be checked under normal usage conditions. But in severe conditions, the fluid should be changed at an authorized Kia dealer in accordance to the scheduled maintenance at the beginning of this section.

* NOTICE

Automatic transmission fluid color is usually red. As the vehicle is driven, the automatic transmission fluid will begin to look darker.

It is the normal condition and you should not judge the need to replace the fluid based upon the changed color.

⚠ CAUTION

Transmission fluids

The use of a non-specified fluid could result in transmission malfunction and failure. Use only specified automatic transmission fluid. (Refer to "Recommended lubricants and capacities" on page 8-6.)

Brake hoses and lines

Visually check for proper installation, chafing, cracks, deterioration and any leakage. Replace any deteriorated or damaged parts immediately.

Brake fluid

Check the brake fluid level in the brake fluid reservoir. The level should be between "MIN" and "MAX" marks on the side of the reservoir. Use only hydraulic brake fluid conforming to DOT 4 specification.

Parking brake

Inspect the parking brake system including the parking brake lever (or pedal) and cables.

Exhaust pipe and muffler

Visually inspect the exhaust pipes, muffler and hangers for cracks, deterioration, or damage. Start the engine and listen carefully for any exhaust gas leakage. Tighten connections or replace parts as necessary.

Brake discs, pads and calipers

Check the pads for excessive wear, discs for run out and wear, and calipers for fluid leakage.

Suspension mounting bolts

Check the suspension connections for looseness or damage. Retighten to the specified torque.

**Steering gear box, linkage & boots/
lower arm ball joint**

With the vehicle stopped and off, check for excessive free-play in the steering wheel.

Check the linkage for bends or damage. Check the dust boots and ball joints for deterioration, cracks, or damage. Replace any damaged parts.

Drive shafts and boots

Check the drive shafts, boots and clamps for cracks, deterioration, or damage. Replace any damaged parts and, if necessary, repack the grease.

Propeller shaft

Check the propeller shaft, boots, clamps, rubber coupling and center bearing rubber for cracks, deterioration, or damage. Replace any damaged parts and if necessary, repack the grease.

Air conditioning refrigerant

Check the air conditioning lines and connections for leakage and damage.

Checking fluid levels

When checking engine oil, engine coolant, brake fluid, and washer fluid, always be sure to clean the

area around any filler plug, drain plug, or dipstick before checking or draining any lubricant or fluid. This is especially important in dusty or sandy areas and when the vehicle is used on unpaved roads. Cleaning the plug and dipstick areas will prevent dirt and grit from entering the engine and other mechanisms that could be damaged.

Engine oil and filter

Checking the engine oil level

Engine oil is used for lubricating, cooling, and operating various hydraulic components in the engine. Engine oil consumption while driving is normal, and it is necessary to check and refill the engine oil regularly. Also, check and refill the oil level within the recommended maintenance schedule to prevent deterioration of oil performance.

Check the engine oil following the below procedure.

(Gasoline) 3.8 GDi

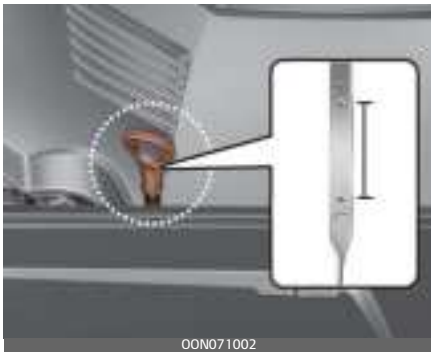

1. Be sure the vehicle is on level ground.
2. Start the engine and allow it to reach normal operating temperature.
3. Turn the engine off, remove the oil filler cap and pull the dipstick out. Wait for 15 minutes for the oil to return to the oil pan.
4. Wipe the dipstick clean and re-insert it fully.

5. Pull the dipstick out again and check the level. Check if the oil level is between the F-L line, and if it is below the L line, add enough oil to bring the level to F line.

⚠ WARNING

Radiator hose

Be very careful not to touch the radiator hose when checking or adding the engine oil as it may be hot enough to burn you.

⚠ CAUTION

When you wipe the oil level gauge, you should wipe it with a clean cloth. When mixed with debris, it can cause engine damage.

(Gasoline) 3.8 GDi



Use a funnel to help prevent oil from being spilled on engine components. Use only the specified engine oil.

(Refer to "Recommended lubricants and capacities" on page 8-6.)

- Do not spill engine oil when adding or changing engine oil. Wipe off spilled oil immediately.
- The engine oil consumption may increase while you break in a new vehicle and it will be stabilized after driving 6,000 km (4,000 miles).
- The engine oil consumption can be affected by driving habits, climate conditions, traffic conditions, oil quality, etc. Therefore, it is recommended that you inspect the engine oil level regularly and refill it if necessary.

Changing the engine oil and filter

Have engine oil and filter changed by an authorized Kia dealer according to the Maintenance Schedule at the beginning of this chapter.

- If the maintenance schedule to replace engine oil is exceeded, the engine oil performance may deteriorate, and the engine condition may be affected. Therefore, replace the engine oil according to the maintenance schedule.
- To keep the engine in optimal condition, use the recommended engine oil and filter. If the recommended engine oil and filter are not used replace it according to the maintenance schedule under severe usage conditions.
- The purpose of the maintenance schedule for engine oil replace-

ment is to prevent oil deterioration and it is irrelevant to oil consumption. Check and refill engine oil regularly.

WARNING

Used engine oil may cause irritation or cancer of the skin if left in contact with the skin for prolonged periods of time. Always protect your skin by washing your hands thoroughly with soap and warm water as soon as possible after handling used oil.

Do not leave used engine oil within the reach of children.

CAUTION

The engine oil is very hot immediately after the vehicle has been driven and can cause burns during replacement. Replace the engine oil after the engine oil has cooled down.

Engine coolant

The high-pressure cooling system has a reservoir filled with year round antifreeze coolant. The reservoir is filled at the factory.

Check the antifreeze protection and coolant level at least once a year, at the beginning of the winter season, and before traveling to a colder climate.

⚠ WARNING

Radiator/Inverter cap

Never attempt to remove the radiator or inverter cap while the engine is operating or hot. Doing so might lead to cooling system and engine damage and could result in serious bodily injury from escaping hot coolant or steam.

Recommended coolant

When adding coolant, use only deionized water or soft water for your vehicle and never mix hard water in the coolant filled at the factory. An improper coolant mixture can result in serious malfunction or damage.

- Do not use alcohol or methanol coolant or mix them with the specified coolant.
- Do not use a solution that contains more than 60% antifreeze or less than 35% antifreeze,

which would reduce the effectiveness of the solution.

- The cooling circuit of a vehicle equipped with a heat pump system may freeze in extremely low temperature when the concentration of the antifreezing liquid is below 45%.

For mixture percentage, refer to the following .

Ambient Temperature	Mixture Percentage (volume)	
	Antifreeze	Water
-15 °C (5 °F)	35	65
-25 °C (-13 °F)	40	60
-35 °C (-31 °F)	50	50
-45 °C (-49 °F)	60	40

⚠ WARNING

Radiator cap



Do not remove the radiator cap when the engine and radiator are hot. Scalding hot coolant and steam

may blow out under pressure which may result in serious injury.

Engine room rear view



Checking the coolant level

⚠ WARNING



Removing radiator cap

Never attempt to remove the radiator cap while the engine is operating or hot. Doing so might lead to cooling system damage and could result in serious personal injury from escaping hot coolant or steam.

1. Turn the vehicle off and wait until it cools down.
2. Use extreme care when removing the radiator cap. Wrap a thick towel around it, and turn it counterclockwise slowly to the first stop.
3. Step back while the pressure is released from the cooling system.

4. When you are sure all the pressure has been released, press down on the cap, using a thick towel, and continue turning counterclockwise to remove it.

⚠ WARNING



Cooling fan

Use caution when working near the blade of the cooling fan. The electric motor (cooling fan) is controlled by coolant temperature, refrigerant pressure and vehicle speed. It may sometimes operate even when the vehicle is not running.

5. Check the condition and connections of all cooling system hoses and heater hoses.
6. Replace any swollen or deteriorated hoses.
7. Check the coolant level. The coolant level should be filled between F and L marks on the side of the coolant reservoir when the engine room is cool.
8. If the coolant level is low, add enough specified coolant to provide protection against freezing and corrosion. Bring the level to F, but do not overfill.

If frequent additions are required, see an authorized Kia dealer for a cooling system inspection.

Changing the coolant

Have the coolant changed by an authorized Kia dealer according to the Maintenance Schedule at the beginning of this chapter.

⚠ CAUTION

Put a thick cloth or fabric around the radiator cap before refilling the coolant in order to prevent the coolant from overflowing into engine parts such as the alternator.

Brake fluid

The brake fluid acts to transmit force to the brake when the driver depresses the brake pedal. Brake fluid must be maintained periodically to ensure that the brakes operate smoothly.

Checking the brake fluid level

Check the fluid level in the reservoir periodically. The fluid level should be between MAX and MIN marks on the side of the reservoir.



1. Before removing the reservoir cap and adding brake fluid, clean the area around the reservoir cap thoroughly to prevent brake fluid contamination.

⚠ CAUTION

Proper fluid

Only use brake fluid in the brake system. Small amounts of improper fluids can cause damage to the brake system.

2. Periodically check that the fluid level in the brake fluid reservoir is between MIN and MAX. The level will fall with accumulated mileage. This is a normal condition associated with the wear of the brake linings. If the fluid level is excessively low, have the brake system checked by an authorized Kia dealer.

Use only the specified brake fluid. (Refer to "Recommended lubricants and capacities" on page 8-6.)

Never mix different types of fluid.

In the event the brake system requires frequent additions of fluid, the vehicle should be inspected by an authorized Kia dealer.

When changing and adding brake fluid, handle it carefully. Do not let it come in contact with your eyes. If brake fluid should come in contact with your eyes, immediately flush them with a large quantity of fresh tap water. Have your eyes examined by a doctor as soon as possible.

CAUTION

Brake fluid

Do not allow brake fluid to contact the vehicle's body paint, as paint damage will result.

Brake fluid, which has been exposed to open air for an extended time should never be used as its quality

cannot be guaranteed. It should be disposed of properly.

CAUTION

To maintain your vehicle's best brake and ABS/ESC performance, use Kia genuine brake fluid as in the specification. (Classification : SAE J1704 DOT4 LV, ISO4925 CLASS-6, FMVSS116 DOT-4)

Washer fluid

Washer fluid is used when wiping the windshield of the vehicle with a windshield wiper. You should check and refill washer fluid periodically to make sure that it doesn't run out.

Checking the washer fluid level



The reservoir is translucent so that you can check the level with a quick visual inspection.

- Check the fluid level in the washer fluid reservoir and add fluid if necessary. Plain water may be used if washer fluid is not available. However, use washer solvent with antifreeze characteristics in cold climates to prevent freezing.

WARNING

Flammable Fluid

Do not allow the washer fluid to come in contact with open flames or sparks. The windshield washer fluid reservoir is flammable under certain

circumstances. This can result in a fire.

WARNING

Coolant

- Do not use radiator coolant or antifreeze in the washer fluid reservoir.
- Radiator coolant can severely obscure visibility when sprayed on the windshield and may cause loss of vehicle control.

WARNING

Windshield fluid

Do not drink the windshield washer fluid. The windshield washer fluid is poisonous to humans and animals.

Air cleaner filter

A Genuine Kia air cleaner filter is recommended when the filter is replaced.

Replacing air cleaner filter

Air cleaner filter must be replaced when necessary, and should not be washed.



You can clean the filter when inspecting the air cleaner compartment. Clean the filter by using compressed air.

1. Pull out the air cleaner cover.



2. Unlock by turning the locking lever downward.



3. Pull the air cleaner filter to replace.



4. Lock the cover with the reverse order.

Replace the filter according to the Maintenance Schedule.

If the vehicle is operated in extremely dusty or sandy areas, replace the element more often than the usual recommended intervals. (Refer to "Maintenance Under Severe Usage Conditions – Non Turbo Models" on page 7–13.)

⚠ CAUTION

Air filter maintenance

- Do not drive with the air cleaner removed; this will result in excessive engine wear.
- When removing the air cleaner filter, be careful that dust or dirt does not enter the air intake, or damage may result.
- Use a Kia genuine part. Use of a non-genuine part could damage the air flow sensor.

Climate control air filter

The climate control air filter should be replaced according to the maintenance schedule. If the vehicle is operated in severely air-polluted cities or on dusty rough roads for a long period, it should be inspected more frequently and replaced earlier.

Inspecting and replacing climate control air filter

When you replace the climate control air filter, replace it performing the following procedure. Be careful to avoid damaging other components.

1. Open the glove box and remove the stoppers on both sides.



2. With the glove box open, pull the pin and the support strap (1).



3. Remove the climate control air filter cover while pressing the lock on the upper side of the cover.



4. Replace the climate control air filter.



5. Reassemble in the reverse order of disassembly.

When replacing the climate control air filter install it properly. Otherwise, the system may produce noise and the effectiveness of the filter may be reduced.

Wiper blades

When the wipers no longer clean adequately, the blades may be worn or cracked, and require replacement.

To prevent damage to the wiper arms or other components, do not attempt to move the wipers manually.

The use of a non-specified wiper blade could result in wiper malfunction and failure.

Blade inspection



Commercial hot waxes applied by automatic vehicle washes have been known to make the windshield difficult to clean.

Contamination of either the windshield or the wiper blades with foreign matter can reduce the effectiveness of the windshield wipers. Common sources of contamination are insects, tree sap, and hot wax treatments used by some commercial vehicle washes. If the blades

are not wiping properly, clean both the window and the blades with a good cleaner or mild detergent, and rinse thoroughly with clean water.

Front windshield wiper blade



To inspect or replace the windshield wiper blades and to prevent damaging the hood, move the windshield wiper blades to the service position as follows;

- After turning off the engine, move the wiper switch to the single wiping (MIST) position within 20 seconds and hold the switch more than 2 seconds until the wiper blade is in the fully up position

Replacing front windshield wiper blade

Type A

1. Raise the wiper arm and turn the wiper blade assembly to expose the plastic locking clip.



CAUTION

Wiper arms

- Do not allow the wiper arm to fall against the windshield, since it may chip or crack the windshield.
- Do not pull wiper arm forward, since arm could chip hood paint.

2. Compress the clip and slide the blade assembly downward.

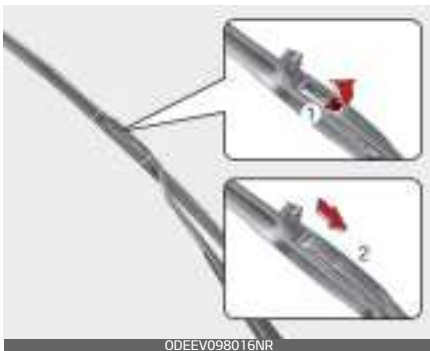

3. Lift it off the arm.



4. Install the blade assembly in the reverse order of removal.

Type B

1. Raise the wiper arm.
2. Lift up the wiper blade clip. Then pull down the blade assembly and remove it.

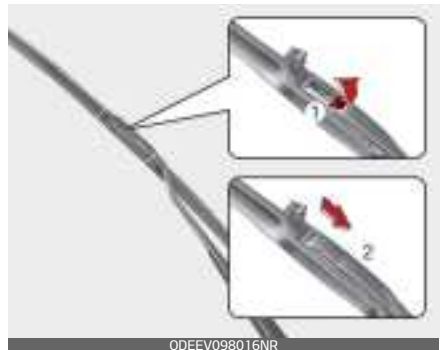

3. Install the new blade assembly.



- 4. Return the wiper arm on the windshield.
- 5. Turn ignition to the ON position and wiper arms will return to the normal operating position.

Replacing rear window wiper blade

1. Raise the wiper arm and pull out the wiper blade assembly.



2. Install the new blade assembly by inserting the center part into the slot in the wiper arm until it clicks into place.



3. Make sure the blade assembly is installed firmly by trying to pull it slightly.

To prevent damage to the wiper arms or other components, have an authorized Kia dealer replace the wiper blade.

Battery

The battery powers the engine in order to move the vehicle as well as supplying power to the various devices installed in the vehicle.

For best battery service



- Keep the battery securely mounted.
- Keep the battery top clean and dry.
- Keep the terminals and connections clean, tight, and coated with petroleum jelly or terminal grease.
- Rinse any spilled electrolyte from the battery immediately with a solution of water and baking soda.
- If the vehicle is not going to be used for an extended time, disconnect the battery cables.

⚠ WARNING

Risk of explosion



Keep lit cigarettes and all other flames or sparks away from the battery.



The battery contains hydrogen -- a highly combustible gas which will explode if it comes in contact with a flame or spark.



Keep batteries out of the reach of children because batteries contain highly corrosive SULFURIC ACID and electrolytes. Do not allow battery acid to contact your skin, eyes, clothing or paint finish.



Wear eye protection when charging or working near a battery. Always provide ventilation when working in an enclosed space.



Always read the following instructions carefully when handling a battery.



If any electrolyte gets into your eyes, flush your eyes with clean water for at least 15 minutes and get immediate medical attention. If electrolyte gets on your skin, thoroughly wash the contacted area. If you feel pain or burning sensation, get medical attention immediately.



An inappropriately disposed battery can be harmful to the environment and human health.

Dispose the battery according to your local law(s) or regulation.



The battery contains lead. Do not dispose of it after use. Please return the battery to an authorized Kia dealer to be recycled.

Never attempt to recharge the battery when the battery cables are connected.

Never attempt to recharge the battery when the battery cables are connected.

⚠ WARNING

Risk of electrocution

Never touch the electrical ignition system while the vehicle is running. This system works with high voltage which can "zap" you.

*** NOTICE**

If you connect unauthorized electronic devices to the battery, the battery may be discharged. Never use unauthorized devices.

⚠ WARNING

Recharging battery

Never attempt to recharge the battery when the battery cables are connected.

⚠ WARNING

Battery lead compound

Battery posts, terminals, and related accessories contain lead and lead compounds. Wash hands after handling.

Battery recharging

Your vehicle has a maintenance-free, calcium-based battery

- If the battery becomes discharged in a short time (because, for example, the headlights or interior lights were left on while the vehicle was not in use), recharge it by slow charging (trickle) for 10 hours.
- If the battery gradually discharges because of high electric load while the vehicle is being used, recharge it at 20~30 A for two hours.

When recharging the battery, observe the following precautions:

- The battery must be removed from the vehicle and placed in an area with good ventilation.
- Do not allow cigarettes, sparks, or flame near the battery.
- Watch the battery during charging, and stop or reduce the charging rate in following cases:
 1. the battery cells begin gassing (boiling) violently

2. the electrolyte temperature of any cell exceeds 49 °C (120 °F).
- Wear eye protection when checking the battery during charging.
 - Disconnect the battery charger in the following order.
 1. Turn off the battery charger main switch.
 2. Unhook the negative clamp from the negative battery terminal.
 3. Unhook the positive clamp from the positive battery terminal.
 - Before performing maintenance or recharging the battery, turn off all accessories and stop the vehicle.
 - The negative battery cable must be removed first and installed last when the battery is disconnected.

CAUTION

AGM battery

- Absorbent Glass Mat (AGM) batteries are maintenance free and have the AGM battery serviced by a professional workshop. Kia recommends to visit an authorized Kia dealer.
For charging your AGM battery, use only fully automatic battery chargers that are specially developed for AGM batteries.
- When replacing the AGM battery, use parts for replacement from a professional workshop. Kia recom-

mends to visit an authorized Kia dealer.

- Do not open or remove the cap on top of the battery. This may cause leaks of internal electrolyte that could result in severe injury.

Reset items

The following items should be reset after the battery has been discharged or the battery has been disconnected.

- Auto up/down window (Refer to "Window opening and closing" on page 4-39)
- Trip computer (Refer to "Trip information (trip computer)" on page 4-87)
- Climate control system (Refer to "Automatic climate control system" on page 4-140)

Tires and wheels

For proper maintenance, safety, and maximum fuel economy, you must always maintain the recommended tire inflation pressures and stay within the load limits and weight distribution recommended for your vehicle.

Recommended cold tire inflation pressures

All tire pressures should be checked when the tires are cold. "Cold Tires" means the vehicle has not been driven for at least three hours or driven less than 1.6 km (1 mile).

Recommended pressures must be maintained for the best ride, vehicle handling, and minimum tire wear.

For recommended inflation pressure, refer to "Tires and wheels" on page 8-5.

All specifications (sizes and pressures) can be found on a label attached to the driver's side center pillar.



⚠ WARNING

Tire underinflation

Inflate your tires consistent with the instructions provided in this manual. Regularly check the tire inflation pressure, and correct it as needed: at least twice a month and before any long trips on the road. If you fail to observe this precaution, you may be driving on underinflated tires, which may not only compromise your vehicle's driving stability, but also lead to tire damage and the risk of an accident. This risk is much higher on hot days and when driving for long periods at high speeds.

Failure to maintain specified pressure may result in excessive wear, poor handling, reduced fuel economy, deformation of tire and/or wheel, harsh ride conditions, possibility for additional damage from road hazards, or result in tire failure.

Tire pressure

Always observe the following:

- Check tire pressure when the tires are cold. (After vehicle has been parked for at least three hours or hasn't been driven more than 1.6 km (1 mile) since startup.)
- Check the pressure of your spare tire each time you check the pressure of other tires.
- Never overload your vehicle. Be careful not to overload a vehicle luggage rack if your vehicle is equipped with one.
- Warm tires normally exceed recommended cold tire pressures by 28-41 kPa (4-6 psi). Do not release air from warm tires to adjust the pressure or the tires will be underinflated.

WARNING

Tire Inflation

Overinflation or underinflation can reduce tire life, adversely affect vehicle handling, and lead to sudden tire failure. This could result in loss of vehicle control and potential injury.

Checking tire inflation pressure

Check your tires once a month or more.

Use a good quality gauge to check tire pressure. You cannot tell if your

tires are properly inflated simply by looking at them. Radial tires may look properly inflated even when they're underinflated.

Check the tire's inflation pressure when the tires are cold. "Cold" means your vehicle has been sitting or at least three hours or driven no more than 1.6 km (1 mile).

1. Remove the valve cap from the tire valve stem.
2. Press the tire gauge firmly onto the valve to get a pressure measurement. If the cold tire inflation pressure matches the recommended pressure on the tire and loading information label, no further adjustment is necessary.
3. If the pressure is low, add air until you reach the recommended amount.
4. If you overfill the tire, release air by pushing on the metal stem in the center of the tire valve.
5. Recheck the tire pressure with the tire gauge.
6. Be sure to put the valve caps back on the valve stems. They help prevent leaks by keeping out dirt and moisture.

Inspect your tires frequently for proper inflation as well as wear and damage. Always use a tire pressure gauge.

Tires with too much or too little pressure wear unevenly. This could result in poor handling, loss of vehicle control, and sudden tire failure

leading to accidents, injuries, and even death. The recommended cold tire pressure for your vehicle can be found in this manual and on the tire label located on the driver's side center pillar.

Tire rotation

To equalize tread wear, it is recommended that the tires be rotated every 12,000 km (7,500 miles) or sooner if irregular wear develops.

During rotation, check the tires for correct balance.

When rotating tires, check for uneven wear and damage. Abnormal wear is usually caused by incorrect tire pressure, improper wheel alignment, out-of-balance wheels, severe braking or severe cornering. Look for bumps or bulges in the tread or side of tire. Replace the tire if you find either of these conditions. Replace the tire if fabric or cord is visible. After rotation, be sure to bring the front and rear tire pressures to specification and check lug nut tightness. (proper torque is 11~13 kgf·m [79~94 lbf·ft])

Refer to "Tires and wheels" on page 8-5.

Disc brake pads should be inspected for wear whenever tires are rotated.

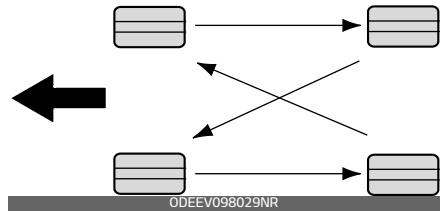

Rotate radial tires that have an asymmetric tread pattern only from front to rear and not from right to left.

⚠ WARNING

Mixing tires

Do not mix bias ply and radial ply tires under any circumstances. This may cause unusual handling characteristics.

Wheel alignment and tire balance

The wheels on your vehicle were aligned and balanced carefully at the factory to give you the longest tire life and best overall performance.

In most cases, you will not need to have your wheels aligned again. However, if you notice unusual tire wear or your vehicle pulling one way or the other, the alignment may need to be reset.

If you notice your vehicle vibrating when driving on a smooth road, your wheels may need to be rebalanced.

⚠ CAUTION

Wheel weight

Improper wheel weights can damage your vehicle's aluminum wheels. Use only approved wheel weights.

Tire replacement

If the tire is worn evenly, a tread wear indicator will appear as a solid band across the tread.



This shows there is less than 1.6 mm (1/16 inch) of tread left on the tire. Replace the tire when this happens.

Do not wait for the band to appear across the entire tread before replacing the tire.

The Anti-lock Brake System (ABS) works by comparing the speed of the wheels. The tire size affects wheel speed. When replacing tires, all 4 tires must use the same size originally supplied with the vehicle. Using tires of a different size can

cause the ABS and Electronic Stability Control (ESC) to work irregularly.

It is best to replace all four tires at the same time. If that is not possible, or necessary, then replace the two front or two rear tires as a pair. Replacing just one tire can seriously affect your vehicle's handling.

* NOTICE

We recommend that when replacing tires, use the same originally supplied with the vehicles. If not, that affects driving performance.

Wheel replacement

When replacing the metal wheels for any reason, make sure the new wheels are equivalent to the original factory units in diameter, rim width and offset.

A wheel with an incorrect size may adversely affect many things: wheel and bearing life, braking and stopping abilities, handling characteristics, ground clearance, body-to-tire clearance, snow chain clearance, speedometer and odometer calibration, headlight aiming and bumper height.

⚠ CAUTION

Wheels

Wheels that do not meet Kia specifications may fit poorly and result in damage to the vehicle or unusual handling and poor vehicle control.

Tire traction

Tire traction can be reduced if you drive on worn tires, tires that are improperly inflated or on slippery road surfaces.

Tires should be replaced when tread wear indicators appear. Slow down whenever there is rain, snow or ice on the road to reduce the possibility of losing control of the vehicle.

Tire maintenance

In addition to proper inflation, correct wheel alignment helps to decrease tire wear.

If you find a tire is worn unevenly, have your dealer check the wheel alignment.

When you have new tires installed, make sure they are balanced. This will increase vehicle ride comfort and tire life. Additionally, a tire should always be rebalanced if it is removed from the wheel.

Tire sidewall labeling

This information identifies and describes the fundamental characteristics of the tire and also provides the Tire Identification Number (TIN) for safety standard certification.

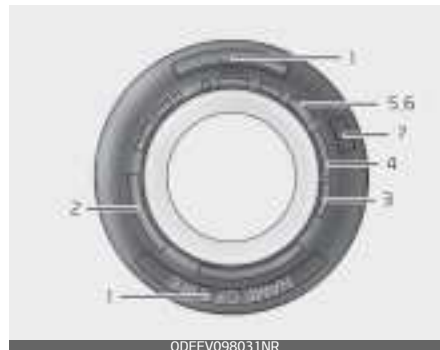

The TIN can be used to identify the tire in case of a recall.

1. *Manufacturer or brand name*

Manufacturer or Brand name is shown.

2. *Tire size designation*

A tire's sidewall is marked with a tire size designation. You will need this information when selecting replacement tires for your vehicle. The following explains what the letters and numbers in the tire size designation mean.

Example tire size designation:

(These numbers are provided as an example only; your tire size designation will vary.)

nator could vary depending on your vehicle.)

P235/65R17 108T

- P: Applicable vehicle type (tires marked with the prefix "P" are intended for use on passenger vehicles or light trucks; however, not all tires have this marking).
- 235: Tire width in millimeters.
- 65: Aspect ratio. The tire's section height as a percentage of its width.
- R: Tire construction code (Radial).
- 17: Rim diameter in inches.
- 108: Load Index, a numerical code associated with the maximum load the tire can carry.
- T: Speed Rating Symbol. See the speed rating chart in this section for additional information.

Wheel size designation

Wheels are also marked with important information that you need if you ever have to replace one. The following explains what the letters and numbers in the wheel size designation mean.

Example wheel size designation:

7.0JX17

- 7.0: Rim width in inches.
- J: Rim contour designation.
- 17: Rim diameter in inches.

Tire speed ratings

The chart below lists many of the different speed ratings currently being used for passenger vehicle

tires. The speed rating is part of the tire size designation on the sidewall of the tire. This symbol corresponds to that tire's designed maximum safe operating speed.

Speed Rating Symbol	Maximum Speed
S	180 km/h (112 mph)
T	190 km/h (118 mph)
H	210 km/h (130 mph)
V	240 km/h (149 mph)
W	270 km/h (168 mph)
Y	300 km/h (186 mph)

3. Checking tire life

Any tires that are over 6 years old, based on the manufacturing date, should be replaced by new ones. You can find the manufacturing date on the tire sidewall (possibly on the inside of the wheel), displaying the DOT code. The DOT code is a series of numbers on a tire consisting of numbers and English letters. The manufacturing date is designated by the last four digits (characters) of the DOT code.

DOT: XXXX XXXX 0000

The front part of the DOT means a plant code number, tire size and tread pattern and the last four numbers indicate week and year manufactured.

For example:

DOT XXXX XXXX 1621 represents that the tire was produced in the 16th week of 2021.

⚠ WARNING

Tire age

Replace tires within the recommended time frame. Failure to replace tires as recommended can result in sudden tire failure, which could lead to a loss of control and an accident.

4. Tire ply composition and material

The number of layers or plies of rubber-coated fabric in the tire. Tire manufacturers also must indicate the materials in the tire, which include steel, nylon, polyester, and others. The letter "R" means radial ply construction; the letter "D" means diagonal or bias ply construction; and the letter "B" means belted-bias ply construction.

5. Maximum permissible inflation pressure

This number is the greatest amount of air pressure that should be put in the tire. Do not exceed the maximum permissible inflation pressure. Refer to "Tire and loading information label" on page 5-160 for recommended inflation pressure.

6. Maximum load rating

This number indicates the maximum load in kilograms and pounds that can be carried by the tire. When replacing the tires on the vehicle, always use a tire that has the same load rating as the factory installed tire.

7. Uniform tire quality grading

Quality grades can be found where applicable on the tire sidewall between tread shoulder and maximum section width.

For example:

- TREADWEAR 200
- TRACTION AA
- TEMPERATURE A

Tires degrade over time, even when they are not being used. Regardless of the remaining tread, we recommend that tires be replaced after approximately six (6) years of normal service. Heat caused by hot climate or frequent high loading conditions can accelerate the aging process.

Tread wear

The tread wear grade is a comparative rating based on the wear rate of the tire when tested under controlled conditions on a specified government test course. For example, a tire graded 150 would wear one-and-a-half times (1½) as well

on the government course as a tire graded 100.

The relative performance of tires depends upon the actual conditions of their use. Performance may depart significantly from the norm due to variations in driving habits, service practices and differences in road characteristics and climate.

These grades are molded on the side-walls of passenger vehicle tires. The tires available as standard or optional equipment on your vehicle may vary with respect to grade.

Traction – AA, A, B & C

The traction grades, from highest to lowest, are AA, A, B and C. Those grades represent the tire's ability to stop on wet pavement as measured under controlled conditions on specified government test surfaces of asphalt and concrete. A tire marked C may have poor traction performance.

The traction grade assigned to this tire is based on straight-ahead braking traction tests, and does not include acceleration, cornering, hydroplaning, or peak traction characteristics.

Temperature –A, B & C

The temperature grades are A (the highest), B and C representing the tire's resistance to the generation of heat and its ability to dissipate heat when tested under controlled conditions on a specified indoor laboratory test wheel.

Sustained high temperature can cause the material of the tire to degrade and reduce tire life, and excessive temperature can lead to sudden tire failure. Grades B and A represent higher levels of performance on the laboratory test wheel than the minimum required by law.

Tire terminology and definitions

Refer to the following for detailed definitions of the terms that are found in the tire description.

Air Pressure The amount of air inside the tire pressing outward on the tire. Air pressure is expressed in pounds per square inch (psi) or kilopascal (kPa).

Accessory Weight The combined weight of optional accessories. Some examples of optional accessories are automatic transmission, power seats, and air conditioning.

Aspect Ratio The relationship of a tire's height to its width.

Belt A rubber coated layer of cords that is located between the plies and the tread. Cords may be made from steel or other reinforcing materials.

Bead The tire bead contains steel wires wrapped by steel cords that hold the tire onto the rim.

Bias Ply Tire A pneumatic tire in which the plies are laid at alternate

angles less than 90 degrees to the centerline of the tread.

Cold Tire Pressure The amount of air pressure in a tire, measured in pounds per square inch (psi) or kilopascals (kPa) before a tire has built up heat from driving.

Curb Weight The weight of a motor vehicle with standard and optional equipment (including the maximum capacity of fuel, oil and coolant), but without passengers and cargo.

DOT Markings The DOT code includes the Tire Identification Number (TIN), an alphanumeric designator which can also identify the tire manufacturer, production plant, brand and date of production.

GVWR Gross Vehicle Weight Rating

GAWR FRT Gross Axle Weight Rating for the Front axle.

GAWR RR Gross Axle Weight Rating for the Rear axle.

Intended Outboard Sidewall The side of an asymmetrical tire that must always face outward when mounted on a vehicle.

Kilopascal (kPa) The metric unit for air pressure.

Light truck (LT) tire A tire designated by its manufacturer as primarily intended for use on lightweight trucks or multipurpose passenger vehicles.

Load ratings The maximum load that a tire is rated to carry for a given inflation pressure.

Load Index An assigned number ranging from 1 to 279 that corresponds to the load carrying capacity of a tire.

Maximum Inflation Pressure The maximum air pressure to which a cold tire may be inflated. The maximum air pressure is molded onto the sidewall.

Maximum Load Rating The load rating for a tire at the maximum permissible inflation pressure for that tire.

Maximum Loaded Vehicle Weight The sum of curb weight; accessory weight; vehicle capacity weight; and production options weight.

Normal Occupant Weight The number of occupants a vehicle is designed to seat multiplied by 68 kg (150 lbs.).

Occupant Distribution Designated seating positions.

Outward Facing Sidewall The side of a asymmetrical tire that has a particular side that faces outward when mounted on a vehicle. The outward facing sidewall bears white lettering or bears manufacturer, brand, and/or model name molding that is higher or deeper than the

same moldings on the inner facing sidewall.

Passenger (P-Metric) Tire A tire used on passenger cars and some light duty trucks and multipurpose vehicles.

Ply A layer of rubber-coated parallel cords.

Pneumatic tire A mechanical device made of rubber, chemicals, fabric and steel or other materials, that, when mounted on an automotive wheel, provides the traction and contains the gas or fluid that sustains the load.

Production options weight The combined weight of installed regular production options weighing over 2.3 kg (5 lb.) in excess of the standard items which they replace, not previously considered in curb weight or accessory weight. Examples include heavy duty brakes, ride levelers, roof rack, heavy duty battery, and special trim.

Recommended Inflation Pressure Vehicle manufacturer's recommended tire inflation pressure and shown on the tire placard.

Radial Ply Tire A pneumatic tire in which the ply cords that extend to the beads are laid at 90 degrees to the centerline of the tread.

Rim A metal support for a tire and upon which the tire beads are seated.

Sidewall The portion of a tire between the tread and the bead.

Speed Rating An alphanumeric code assigned to a tire indicating the maximum speed at which a tire can operate.

Traction The friction between the tire and the road surface. The amount of grip provided.

Tread The portion of a tire that comes into contact with the road.

Treadwear Indicators Narrow bands, sometimes called "wear bars," that show across the tread of a tire when only 1.6 mm (1/16 inch) of tread remains.

UTQGS Uniform Tire Quality Grading Standards, a tire information system that provides consumers with ratings for a tire's traction, temperature and treadwear. Ratings are determined by tire manufacturers using government testing procedures. The ratings are molded into the sidewall of the tire.

Vehicle Capacity Weight The weight of designated seating positions multiplied by 68 kg (150 lbs.) plus the rated cargo and luggage load.

Vehicle Maximum Load on the Tire Load on an individual tire due to curb

and accessory weight plus maximum occupant and cargo weight.

Vehicle Normal Load on the Tire

Load on an individual tire that is determined by distributing to each axle its share of the curb weight, accessory weight, and normal occupant weight.

Vehicle Placard A label permanently attached to a vehicle showing the original equipment tire size and recommended inflation pressure.

All season tires

Kia specifies all season tires on some models to provide good performance for use all year round, including snowy and icy road conditions.

All season tires are identified by ALL SEASON and/or M+S (Mud and Snow) on the tire sidewall. Snow tires have better snow traction than all season tires and may be more appropriate in some areas.

Summer tires

Kia specifies summer tires on some models to provide superior performance on dry roads.

Summer tire performance is substantially reduced in snow and ice. Summer tires do not have the tire traction rating M+S (Mud and Snow) on the tire side wall. If you plan to

operate your vehicle in snowy or icy conditions, Kia recommends the use of snow tires or all season tires on all four wheels.

Snow tires

If you equip your vehicle with snow tires, they should be the same size and have the same load capacity as the original tires.

Snow tires should be installed on all four wheels; otherwise, poor handling may result.

Snow tires should carry 28 kPa (4 psi) more air pressure than the pressure recommended for the standard tires on the tire label on the driver's side of the center pillar, or up to the maximum pressure shown on the tire sidewall, whichever is less.

Do not drive faster than 120 km/h (75 mph) when your vehicle is equipped with snow tires.

WARNING

Do not use summer tires at temperatures below 7 °C (45 °F) or when driving on snow or ice. At temperatures below 7 °C (45 °F), summer tires can lose elasticity, and therefore traction and braking power as well. Change the tires on your vehicle to winter or all-weather tires of the same size as

the standard tires of the vehicle. Both types of tires are identified by the M+S (Mud and Snow) marking. Using summer tires at very cold temperatures could cause cracks to form, thereby damaging the tires permanently.

Radial-ply tires

Radial-ply tires provide improved tread life, road hazard resistance and smoother high speed ride.

The radial-ply tires used on this vehicle are of belted construction, and are selected to complement the ride and handling characteristics of your vehicle. Radial-ply tires have the same load carrying capacity, as bias-ply or bias belted tires of the same size, and use the same recommended inflation pressure.

Mixing of radial-ply tires with bias-ply or bias belted tires is not recommended. Any combinations of radial-ply and bias-ply or bias belted tires when used on the same vehicle will seriously deteriorate vehicle handling. The best rule to follow is: Identical radial-ply tires should always be used as a set of four.

Longer wearing tires can be more susceptible to irregular tread wear. It is very important to follow the tire rotation interval shown in this sec-

tion to achieve the tread life potential of these tires. Cuts and punctures in radial-ply tires are repairable only in the tread area, because of sidewall flexing. Consult your tire dealer for radial-ply tire repairs.

Low aspect ratio tire (if equipped)

Low aspect ratio tires, whose aspect ratio is lower than 50, are provided for sporty looks.

Because the low aspect ratio tires are optimized for handling and braking, it may be more uncomfortable to ride in and there is more noise compare with normal tires.

CAUTION

Because the sidewall of the low aspect ratio tire is shorter than the normal, the wheel and tire of the low aspect ratio tire is easier to be damaged. So, follow the instructions below.

- When driving on a rough road or off road, drive cautiously because tires and wheels may be damaged. And after driving, inspect tires and wheels.
- When passing over a pothole, speed bump, manhole, or curb stone, drive slowly so that the tires and wheels are not damaged.

- If the tire is impacted, we recommend that you inspect the tire condition or contact an authorized Kia dealer.
 - To prevent damage to the tire, inspect the tire condition and pressure every 3,000 km (1,900 miles).
-
- It is not easy to recognize the tire damage with your own eyes. But if there is the slightest hint of tire damage, even though you cannot see the tire damage with your own eyes, have the tire checked or replaced because the tire damage may cause air leakage from the tire.
 - If the tire is damaged by driving on a rough road, off road, pothole, manhole, or curb stone, it will not be covered by the warranty.
 - You can find out the tire information on the tire sidewall.

Fuses

A vehicle's electrical system is protected from electrical overload damage by fuses.

Blade type



Cartridge type



Multi fuse

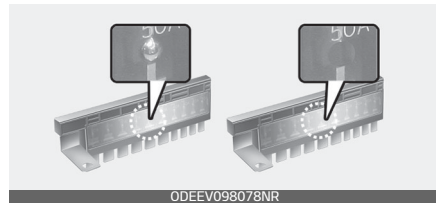

BFT



* Left side: Normal, Right side: Blown

This vehicle has 2 (or 3) fuse panels, one located in the driver's side panel bolster, the other in the engine compartment near the battery.

If any of your vehicle's lights, accessories, or controls do not work, check the appropriate circuit fuse. If a fuse has blown, the element inside the fuse will melt.

If the electrical system does not work, first check the driver's side fuse panel.

If the replacement fuse blows, this indicates an electrical problem. Avoid using the system involved and immediately consult an authorized Kia dealer.

Three kinds of fuses are used: blade type for lower amperage rating, cartridge type, and multi fuse for higher amperage ratings.

WARNING

Fuse replacement

- Never replace a fuse with anything but another fuse of the same rating.
- A higher capacity fuse could cause damage and possibly a fire.
- Never install a wire or aluminum foil instead of the proper fuse - even as a temporary repair. It may cause extensive wiring damage and a possible fire.

- Do not arbitrarily modify or add-on electric wiring to the vehicle.

NOTICE

- When replacing a fuse, Turn ENGINE START/STOP button to the OFF position and turn off switches of all electrical devices then remove battery (-) terminal.
- The actual fuse/relay panel label may differ from equipped items.

WARNING

Electrical Fire

Always ensure replacements fuses and relays are securely fastened when installed. Failure to do so can result in a vehicle fire.

Do not remove fuses, relays and terminals fastened with bolts or nuts. The fuses, relays and terminals may be fastened incompletely, and it may cause a possible fire. If fuses, relays and terminals fastened with bolts or nuts are blown, we recommend that you consult with an authorized Kia dealer.

CAUTION

When replacing a blown fuse or relay, make sure the new fuse or relay fits tightly into the clips. Failure to tightly install the fuse or

relay may cause damage to the wiring and electric systems.

⚠ CAUTION

- Do not input any other objects except fuses or relays into fuse/relay terminals such as a screwdriver or wiring. It may cause contact failure and system malfunction.
- Do not plug in screwdrivers or aftermarket wiring into the terminal originally designed for fuse and relays only. The electrical system and wiring of the vehicle interior may be damaged or burned due to contact failure.
- If you directly connect the wire on the taillight or replace the bulb which is over the regulated capacity to install trailers etc., the inner junction block can get burned.

⚠ WARNING

Electrical wiring repairs

All electrical repairs should be performed by authorized Kia dealerships using approved Kia parts. Using other wiring components, especially when retrofitting multimedia or theft alarm system, car phone or radio may cause vehicle damage and increase the risk of a vehicle fire.

* NOTICE

Remodeling Prohibited

Do not rewire your vehicle in any way as doing so may affect the performance of several safety features in your vehicle. Rewiring your vehicle may also void your warranty and cause you to be responsible for any subsequent vehicle damage which may result.

Replacing inner panel fuse

1. Turn the ENGINE START/STOP button to the OFF position and all other switches off.
2. Open the fuse panel cover.



3. Pull the suspected fuse straight out. Use the removal tool provided on the engine fuse panel cover.



4. Check the removed fuse; replace it if it is blown.

Spare fuses are provided in the engine compartment fuse panel.

5. Push in a new fuse of the same rating, and make sure it fits tightly in the clips.

If it fits loosely, consult an authorized Kia dealer.

If you do not have a spare, use a fuse of the same rating from a circuit you may not need for operating the vehicle, such as the power outlet fuse.

If the head lamp, turn signal lamp, stop signal lamp, fog lamp, DRL, tail lamp or High Mounted Stop Lamp (HMSL) do not work and the fuses are OK, check the fuse panel in the engine compartment. If a fuse is blown, it must be replaced.

* NOTICE

If the headlamp, fog lamp, turn signal lamp, or tail lamp malfunction even without any problem to the

lamps, have the vehicle checked by an authorized Kia dealer for assistance.

Replacing engine compartment fuse

1. Turn the ENGINE START/STOP button to the OFF position and all other switches off.
2. Remove the fuse panel cover by pressing the tab and pulling the cover up.



3. Check the removed fuse; replace it if it is blown. To remove or insert the fuse, use the fuse puller in the engine compartment fuse panel.
4. Push in a new fuse of the same rating, and make sure it fits tightly in the clips. If it fits loosely, consult an authorized Kia dealer.

⚠ CAUTION

Always securely install the fuse panel cover in the engine compartment to protect against electrical failure which may occur from water contact. Listen for the audible click-

ing sound to ensure fuse panel cover is securely fastened.

Multi fuse



If the multi fuse is blown, it must be removed as follows:

1. Turn the ENGINE START/STOP button to the OFF position and all other switches off.
2. Disconnect the negative battery cable.
3. Remove the nuts shown in the picture above.
4. Replace the fuse with a new one of the same rating.
5. Reverse these steps to reinstall the multi fuse.

* NOTICE

Do not disassemble or assemble the multi fuse when it is secured with nuts and bolts. Incorrect or partial assembly torque may cause a fire. Have the vehicle checked by an authorized Kia dealer.

Main fuse



If the main fuse is blown, it must be removed as follows:

1. Turn the ENGINE START/STOP button to the OFF position and all other switches off.
2. Disconnect the negative battery cable.
3. Remove the nuts shown in the picture above.
4. Replace the fuse with a new one of the same rating.
5. Reverse these steps to reinstall the multi fuse.

* NOTICE

The electronic system may not function correctly even when the engine compartment and internal fuse box's individual fuses are not disconnected. In such case the cause of the problem may be disconnection of the main fuse (BFT type), which is located inside the positive battery terminal (+) cap.

Since the main fuse is designed more intricately than other parts,

have the vehicle checked by an authorized Kia dealer.

* NOTICE

Do not disassemble or assemble the multi fuse when it is secured with nuts and bolts. Incorrect or partial assembly torque may cause a fire. Have the vehicle checked by an authorized Kia dealer.

Battery fuse

If the battery fuse is blown, it must be removed as follows:

1. Disconnect the negative battery cable.
2. Remove the nuts shown in the picture below.



3. Replace the fuse with a new one of the same rating.
4. Reinstall in the reverse order of removal.

* NOTICE

If the battery fuse is blown, have the vehicle checked by an authorized Kia dealer.

⚠ CAUTION

Visually inspect the battery cap to ensure it is securely closed. If the battery cap is not securely closed, moisture may enter the system and damage the electrical components.

Fuse/relay panel description

Inside the fuse/relay panel covers, you can find the fuse/relay label describing fuse/relay name and capacity.

Driver's side fuse panel



*** NOTICE**

Not all fuse panel descriptions in this manual may be applicable to your vehicle. It is accurate at the time of printing. When you inspect the fuse panel in your vehicle, refer to the fuse panel label on the inside of the fuse cover. This diagram will provide you with the specific information for your vehicles.

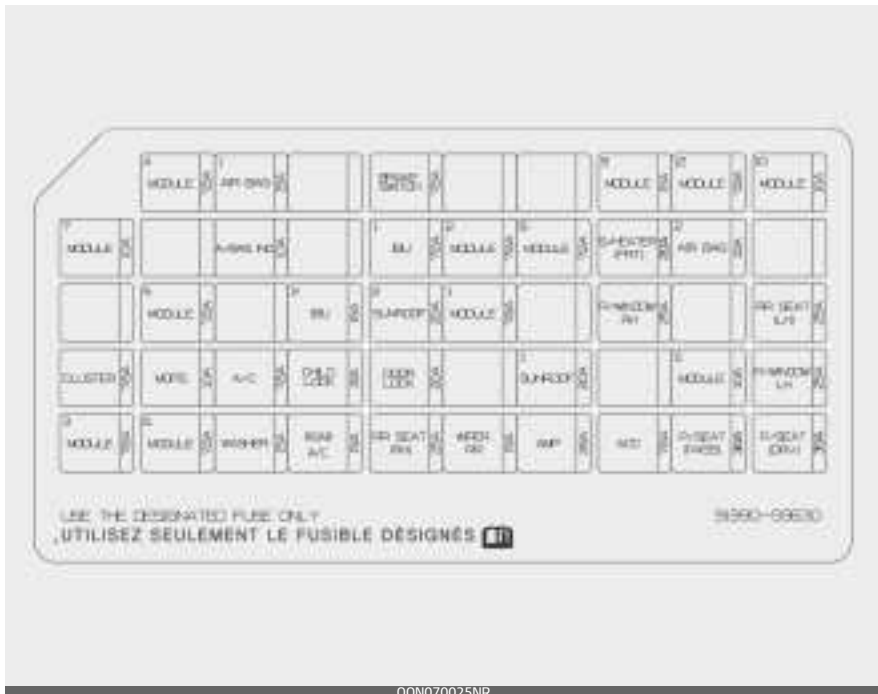

Refer to the following for a description of the fuse.

Description	Fuse rating	Protected component
MODULE 4	7.5 A	ATM (Auto Transmission) Shift Lever Switch, Stop Lamp Switch, Driver Door Module

Description	Fuse rating	Protected component
AIR BAG 1	15 A	SRS (Supplemental Restraint System) Control Module, Passenger Occupant Detection Sensor
BRAKE SWITCH	7.5 A	IBU (Integrated Body Control Unit), Stop Lamp Switch
MODULE 9	15 A	Front A/C Control Module, Low DC-DC Converter (Audio), Power Tail Gate Module, Driver IMS Control Module, Driver Door Module, Driver/Passenger Power Outside Mirror, Rear A/C Control Module
MODULE 12	7.5 A	Head-Up Display
MODULE 10	10 A	Rear Corner Radar LH/RH, Electro Chromic Mirror, Console Switch
AIR BAG IND	10 A	Front A/C Control Module, Instrument Cluster
IBU 1	7.5 A	IBU (Integrated Body Control Unit)
MODULE 2	7.5 A	360° camera monitoring system, AC Inverter Outlet, AC Inverter Unit, Front Air Ventilation Seat Control Module, Front Seat Warmer Control Module, 2ND Air Ventilation Seat Control Module LH/RH, 2ND Seat Warmer Control Module LH/RH
MODULE 8	7.5 A	Hazard Switch, Rain Sensor, Driver/Passenger Smart Key Outside Handle, Mood Lamp Control Unit, Driver/Passenger Mood Lamp, Driver/Passenger Door Mood Lamp, Rear Door Mood Lamp LH/RH
S/HEATER (FRT)	20 A	Front Air Ventilation Control Module, Front Seat Warmer Control Module, Data Link Connector
AIR BAG 2	15 A	SRS (Supplemental Restraint System) Control Module
MODULE 5	7.5 A	Front View Camera, Crash Pad Switch, IBU (Integrated Body Control Unit), Front Radar, ATM (Auto Transmission) Shift Lever Indicator, 4WD ECM (Engine Control Module), Console Switch, Electronic Parking Brake Switch
IBU 2	15 A	IBU (Integrated Body Control Unit)
SUNROOF 2	20 A	Rear Sunroof Controller
MODULE 1	7.5 A	IBU (Integrated Body Control Unit)
P/WINDOW RH	25 A	Passenger Safety Power Window Module, Rear Safety Power Window Module RH
RR SEAT (LH)	25 A	2ND Air Ventilation Seat Control Module LH, 2ND Seat Warmer Control, Module LH, 2ND Seat LH Reclining Folding Actuator
CLUSTER	7.5 A	Instrument Cluster, Head-Up Display
MDPS	10 A	MDPS (Motor Driven Power Steering) Unit
A/C	7.5 A	E/R Junction Block (Blower FRT Relay, Blower RR Relay, PTC Heater 1/2 Relay), Front A/C Control Module, Rear A/C Control Module

Description	Fuse rating	Protected component
CHILD LOCK	15 A	ICM (Integrated Circuit Module) Relay Box (Child Lock/Unlock Relay)
DOOR LOCK	20 A	Door Lock Relay, Door Unlock Relay, Tail Gate Relay, T/Turn Unlock Relay
SUNROOF 1	20 A	Front Sunroof Controller
MODULE 11	10 A	Rear Occupant Detection Sensor
P/WINDOW LH	25 A	Driver Safety Power Window Module, Rear Safety Power Window Module LH
MODULE 3	7.5 A	IBU (Integrated Body Control Unit)
MODULE 6	7.5 A	Audio, A/V & Navigation Head Unit, Low DC-DC Converter (Audio/AMP), Front A/C Control Module, Electro Chromic Mirror, Center fascia Keyboard, Driver/Passenger Seat Warmer Switch, Driver/Passenger Seat Warmer LIN Switch, Driver IMS Control Module, Front Air Ventilation Control Module, Front Seat Warmer Control Module, 2ND Air Ventilation Seat Control Module LH/RH, 2ND Seat Warmer Control Module LH/RH
WASHER	15 A	Multifunction Switch, Front Washer Motor, Rear Washer Motor, Washer Level Sensor
RR SEAT (RH)	25 A	2ND Air Ventilation Seat Control Module RH, 2ND Seat Warmer Control, Module RH, 2ND Seat RH Reclining Folding Actuator
WIPER RR	15 A	Rear Wiper Relay, Rear Wiper Motor
AMP	25 A	Low DC-DC Converter (AMP)
ACC	7.5 A	IBU (Integrated Body Control Unit), Low DC-DC Converter (Audio/AMP)
P/SEAT (PASS)	30 A	Passenger Seat Manual Switch
P/SEAT (DRV)	30 A	Driver IMS Control Module, Driver Seat Manual Switch

Engine compartment fuse panel

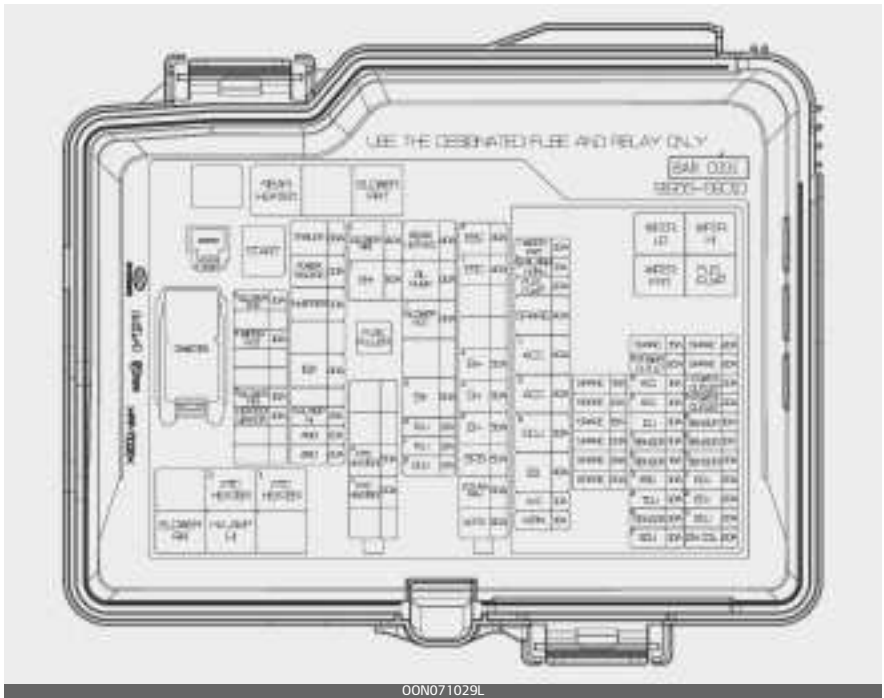

Refer to the following for a description of the fuse.

Fuse Name	Fuse rating	Circuit Protected
MDPS	80 A	MDPS (Motor Driven Power Steering) Unit
COOLING FAN	80 A	Cooling Fan Controller
EPB	60 A	ESC (Electronic Stability Control) Module

Fuse Name	Fuse rating	Circuit Protected
B+2	50 A	ICU Junction Block (IPS 8/IPS 10/IPS 11/IPS 12/IPS 13/IPS 14/IPS 15)
B+3	50 A	ICU Junction Block (Fuse - P/WINDOW LH, RR SEAT (LH), P/ SEAT (DRV), P/SEAT (PASS), MODULE 11)
B+4	50 A	ICU Junction Block (Fuse - MODULE 8, S/HEATER (FRT), P/ WINDOW RH, AMP, SUNROOF 1)
ESC 1	40 A	ESC (Electronic Stability Control) Module
ESC 2	40 A	ESC (Electronic Stability Control) Module
PTC HEATER 1	50 A	PTC Heater 1 Relay
PTC HEATER 2	50 A	PTC Heater 2 Relay
ECU 6	15 A	ECM (Engine Control Module)
TCU 1	15 A	TCM (Transmission Control Module)
TCU 3	15 A	TCM (Transmission Control Module)
B+5	50 A	ICU Junction Block (Fuse - DOOR LOCK, IBU (Integrated Body Control Unit) 1, IBU (Integrated Body Control Unit) 2, BRAKE SWITCH, CHILD LOCK, RR SEAT (RH), SUNROOF 2)
TRAILER 3	30 A	Trailer Connector
BLOWER FRT 1	40 A	Blower FRT Relay
OIL PUMP	40 A	Electric Oil Pump Inverter
REAR HEATED	40 A	Rear Heated Relay
B+1	50 A	ICU Junction Block (IPS 1/IPS 2/IPS 3/IPS 5/IPS 6/IPS 7, Long/ Short Term Load Latch Relay)
BLOWER RR 1	40 A	Blower RR Relay
4WD	20 A	4WD ECM (Engine Control Module)
AMS	10 A	Battery Sensor
H/LAMP HI	15 A	H/Lamp HI Relay
IG2	40 A	Start Relay, PCB Block (IG2 Relay)
TRAILER 2	30 A	Trailer Connector
INVERTER	30 A	AC Inverter Unit
POWER TAIL GATE	30 A	Power Tail Gate Module
TRAILER 1	30 A	Trailer Connector
HEATED MIRROR	10 A	Driver/Passenger Power Outside Mirror, Front A/C Control Module
BLOWER RR 2	10 A	Rear A/C Control Module
WIPER FRT 2	10 A	IBU (Integrated Body Control Unit)
BLOWER FRT 2	10 A	Front A/C Control Module
WIPER FRT 1	30 A	Wiper FRT Relay
B/ALARM HORN	15 A	B/Alarm Horn Relay

Fuse Name	Fuse rating	Circuit Protected
FUEL PUMP	20 A	Fuel Pump Relay
ACC 1	40 A	ACC 1 Relay
ACC 2	40 A	ACC 2 Relay
ECU 5	30 A	Engine Control Relay
IG1	40 A	IG1 Relay
A/C	10 A	A/C Relay
HORN	15 A	Horn Relay
POWER OUTLET 2	20 A	Front Power Outlet
ACC 3	15 A	Rear USB Charger, Luggage USB Charger, Driver/Passenger Seat Cushion USB Charger
ACC 4	10 A	Front USB Charger, Rear USB Charger RH
ICU	10 A	ICU Junction Block (Fuse – ACC)
SENSOR 1	10 A	Fuel Pump Relay
SENSOR 4	15 A	Canister Close Valve, Oxygen Sensor #1/#2/#3/#4
ESC 3	10 A	Data Link Connector, ESC (Electronic Stability Control) Module
TCU 2	10 A	TCM (Transmission Control Module), Transaxle Range Switch
SENSOR 6	10 A	Electric Oil Pump Inverter
ECU 4	10 A	ECM (Engine Control Module)
POWER OUTLET 1	20 A	Luggage Power Outlet
POWER OUTLET 3	20 A	Rear Power Outlet
SENSOR 5	10 A	Oil Pump Solenoid
SENSOR 2	10 A	A/C Relay, Purge Control Solenoid Valve, Oil Control Valve #1/#2/#3/#4 (Intake/Exhaust), Variable Intake Solenoid Valve #1/#2, Electronic Thermostat
SENSOR 3	20 A	Cooling Fan Controller
ECU 1	20 A	ECM (Engine Control Module)
ECU 2	20 A	ECM (Engine Control Module)
ECU 3	20 A	ECM (Engine Control Module)
IGN COIL	20 A	Ignition Coil #1/#2/#3/#4/#5/#6

Refer to the following for the relay type.

Relay Name	Type
Blower FRT Relay	MINI
Rear Heated Relay	MINI
Start Relay	MICRO
PTC Heater 1 Relay	MICRO
PTC Heater 2 Relay	MICRO
H/LAMP HI Relay	MICRO
Blower RR Relay	MICRO
Wiper Lo Relay	MICRO
Wiper Hi Relay	MICRO
Wiper FRT Relay	MICRO
FUEL PUMP Relay	MICRO

Battery terminal cover

00N078031NR

*** NOTICE**

Not all fuse panel descriptions in this manual may be applicable to your vehicle. It is accurate at the time of printing. When you inspect the fuse panel in your vehicle, refer to the fuse panel label.

Light bulbs

Light bulbs are installed in various parts of the vehicle to provide lighting inside and outside the vehicle as well as to alert other vehicles.

Bulb replacement precaution

Please keep extra bulbs on hand with appropriate wattage ratings in case of emergencies.

Refer to "Bulb wattage" on page 8-4.

When changing lamps, first turn off the vehicle at a safe place, firmly apply the parking brake and detach the battery's negative (-) terminal.

WARNING

Working on the lights

Prior to working on the light, firmly apply the parking brake, ensure that the vehicle start/stop button is in OFF position and turn off the lights to avoid sudden movement of the vehicle and burning your fingers or receiving an electric shock.

Use only bulbs of the specified wattage.

CAUTION

Light replacement

Be sure to replace the burned-out bulb with one of the same wattage

rating. Otherwise, it may cause damage to the fuse or electric wiring system.

Fully install light bulbs and any parts used to secure them. Failure to do so may result in heat damage, fire, or water entering the headlight unit. This may damage the headlights or cause condensation to build up on the lens. To prevent damage or fire, make sure bulbs are fully seated and locked.

CAUTION

Headlamp Lens

To prevent damage, do not clean the headlamp lens with chemical solvents or strong detergents.

NOTICE

- If the light bulb or lamp connector is removed while the lamp is still on, the fuse box's electronic system may log it as a malfunction. Therefore, a lamp malfunction incident may be recorded as a Diagnostic Trouble Code (DTC) in the fuse box.
- It is normal for an operating lamp to flicker momentarily. This is due to a stabilization function of the vehicle's electronic control device. If the lamp lights up normally after momentarily blinking, then it is functioning as normal.

However, if the lamp continues to flicker several times or turns off completely, there may be an error in the vehicle's electronic control device. Please have the vehicle checked by an authorized Kia dealer immediately.

*** NOTICE**

We recommend that the headlight aiming be adjusted by an authorized Kia dealer after an accident or after the headlight assembly is reinstalled.

*** NOTICE**

You can find moisture inside the lens of lamps after a car wash or driving in the rain. It is a natural event caused by the temperature difference between the inside and the outside of the lamp and does not mean a problem with its functions. The moisture inside the lamp would disappear if you drive the vehicle with the headlamp turned on, however, the level at which the moisture is removed may differ depending on the size/location/condition of the lamp.

If the moisture continues to stay inside the lamp, have the vehicle checked by an authorized Kia dealer.

If you don't have the necessary tools, the correct bulbs and the expertise, consult an authorized Kia dealer. In many cases, it is difficult to replace vehicle light bulbs because other parts of the vehicle must be removed before you can get to the bulb. This is especially true if you have to remove the headlamp assembly to get to the bulb(s).

Removing/installing the headlamp assembly can result in damage to the vehicle. If non-genuine parts or substandard bulbs are used, it may lead to blowing a fuse or other wiring damages.

Do not install extra lamps or LEDs to the vehicle. If additional lights are installed, it may lead to lamp malfunctions and flickering. Additionally, the fuse box and other wiring may be damaged.

Light bulb position (Front)

Headlamp Type A



OON078033NR

Headlamp Type B



OON078035NR

Fog lamp



OON078037NR

1. Headlamp (Bulb Type) (Low/High)

- 2. Position lamp / Daytime running lamp (LED Type)
- 3. Front turn signal lamp (Bulb Type)
- 4. Side marker (Bulb Type)
- 5. Headlamp (LED Type) (Low)
- 6. Headlamp (LED Type) (Sub Low)
- 7. Headlamp (LED Type) (High)
- 8. Position lamp / Daytime running lamp / Turn signal lamp (LED Type)
- 9. Side marker (LED Type)
- 10. Front fog lamp (LED Type)

Light bulb position (Rear)

Rear combination lamp - Type A



OON078040NR

Rear combination lamp - Type B



OON078042NR

Rear turn signal lamp



High Mounted Stop Lamp (HMSL)



License plate lamp

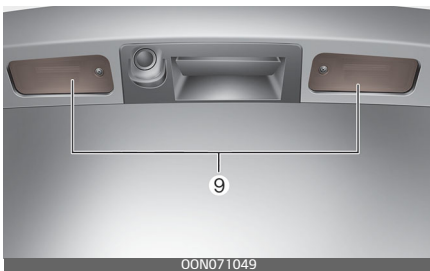

1. Tail lamp (Bulb Type)
2. Stop lamp (Bulb Type)
3. Back up lamp (Bulb Type)
4. Side marker (Bulb Type)
5. Rear turn signal lamp (Bulb Type)

6. Tail lamp/Stop lamp/Rear turn signal lamp (LED Type)
7. Side marker (LED Type)
8. High Mounted Stop Lamp (LED Type)
9. License plate lamp (Bulb Type)

Light bulb position (Side)



1. Side repeater lamp (LED type)

Headlamp bulb



⚠ WARNING

Halogen bulbs

Handle halogen bulbs with care.

7

- Halogen bulbs contain pressurized gas that will produce flying pieces of glass if broken.
- Always handle them carefully, and avoid scratches and abrasions. If the bulbs are lit, avoid contact with liquids. Never touch the glass with bare hands. Residual oil may cause the bulb to overheat and burst when lit. A bulb should be operated only when installed in a headlamp.
- If a bulb becomes damaged or cracked, replace it immediately and carefully dispose of it.
- Wear eye protection when changing a bulb. Allow the bulb to cool down before handling it.

Replacing Headlamp (Low/High) / Position lamp / Daytime running lamp / Turn signal lamp (LED Type) bulb (Headlamp Type B)

If the Headlamp (Low/High)/ Position lamp/Daytime running lamp/ Turn signal lamp (1) does not operate, have the vehicle checked by an authorized Kia dealer.



Replacing Headlamp (Low/High) / Front turn signal lamp bulb (Headlamp Type A)



1. Open the hood.
2. Remove the bulb socket-connector by turning it counterclockwise.
3. Remove the bulb from the lamp assembly.
4. Install a new bulb.
5. Connect the bulb socket-connector.

Replacing Position lamp + DRL (LED type) bulb (Headlamp Type A)

If the position lamp + DRL (LED) (1) does not operate, have the vehicle checked by an authorized Kia dealer.



OON078065NR

The LED lamps cannot be replaced as a single component because it is an integrated unit. The LED lamps have to be replaced with the unit. A skilled technician should check or repair the position lamp + DRL (LED), for it may damage related parts of the vehicle.

Replacing front fog lamp bulb (if equipped)

If the front fog lamp (1) does not operate, have the vehicle checked by an authorized Kia dealer.



OON078038NR

Replacing side repeater lamp (LED Type) bulb

If the side repeater lamp (LED), does not operate, have the vehicle checked by an authorized Kia dealer.



OON078050NR

The LED lamps cannot be replaced as a single component because it is an integrated unit. The LED lamps have to be replaced with the unit.

A skilled technician should check or repair the side repeater lamp (LED), for it may damage related parts of the vehicle.

Replacing turn signal lamp (bulb Type) bulb (if equipped)



If the rear turn signal lamp (Bulb Type) does not operate, have the vehicle checked by an authorized Kia dealer.

Replacing Stop and tail lamp bulb (Rear combination lamp Type A)

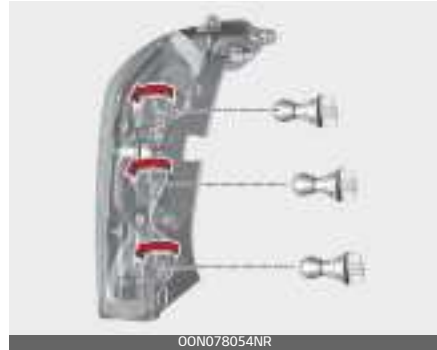

1. Open the liftgate.
2. Loosen the lamp assembly retaining screws with a screwdriver.
3. Remove the rear combination lamp assembly from the body of the vehicle.
4. Remove the socket from the assembly by turning the socket counterclockwise until the tabs on the socket align with the slots on the assembly.
5. Remove the bulb from the socket by pressing it in and rotating it counterclockwise until the tabs on the bulb align with the slots in the socket.
6. Insert a new bulb by inserting it into the socket and rotating it until it locks into place.
7. Install the socket in the assembly by aligning the tabs on the socket with the slots in the assembly and turning the socket clockwise.
8. Reinstall the lamp assembly to the body of the vehicle.

Replacing Tail lamp/Stop lamp/Rear turn signal lamp bulb (Rear combination lamp Type B)



If the Tail lamp/Stop lamp/Rear turn signal lamp (LED Type) does not operate, have your vehicle checked by an authorized Kia dealer.

Replacing Back Up lamp bulb (Rear combination lamp Type A/B)



If the Back Up lamp bulb (Bulb Type) (1) does not operate, have your vehicle checked by an authorized Kia dealer.

Replacing High Mounted Stop Lamp (LED type) bulb

If the High Mounted Stop Lamp (LED) (1) does not operate, have the vehicle checked by an authorized Kia dealer.

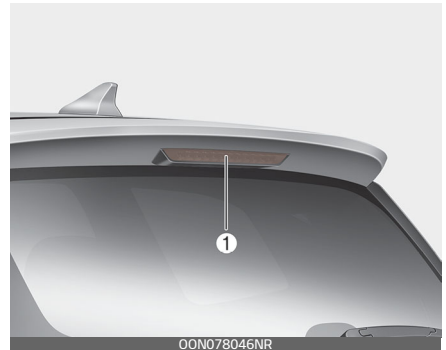

The LED lamps cannot be replaced as a single component because it is an integrated unit. The LED lamps have to be replaced with the unit.

A skilled technician should check or repair the High Mounted Stop Lamp (LED), for it may damage related parts of the vehicle.

Replacing license plate lamp bulb



1. Using a flat-blade screwdriver, gently pry the lamp assembly from interior.
2. Remove the bulb by pulling it straight out.
3. Install a new bulb in the socket.
4. Install the lamp assembly to interior.

Replacing map lamp (bulb type) bulb



1. Using a flat-blade screwdriver, gently pry the lens cover from lamp housing.
2. Remove the bulb by pulling it straight out.
3. Install a new bulb in the socket.

4. Align the lens cover tabs with the lamp housing notches and snap the lens into place.

* NOTICE

Be careful not to damage the lens, lens tab, and plastic housings or get them dirty.

Replacing map lamp (LED type) bulb

If the map lamp (LED) does not operate, have the vehicle checked by an authorized Kia dealer.



The LED lamps cannot be replaced as a single component because they are part of an integrated unit. The LED lamps have to be replaced with the unit.

A skilled technician should check or repair the map lamp (LED), for it may damage related parts of the vehicle.

Replacing vanity mirror lamp bulb



⚠ WARNING

Interior lamps

Prior to working on the Interior lamps, ensure that the "OFF" button is depressed to avoid burning your fingers or receiving an electric shock.

If the map lamp (LED type) does not operate, have your vehicle checked by an authorized Kia dealer.

The LED lamps cannot be replaced as a single unit because it is an integrated unit. The LED lamps have to be replaced with the unit.

A skilled technician should check or repair the map lamp (LED), for it may damage related parts of the vehicle.

*** NOTICE**

Be careful not to damage the lens, lens tab, and plastic housings or get them dirty.

Replacing room lamp (bulb type) bulb



1. Using a flat-blade screwdriver, gently pry the lens cover from lamp housing.
2. Remove the bulb by pulling it straight out.
3. Install a new bulb in the socket.
4. Align the lens cover tabs with the lamp housing notches and snap the lens into place.

*** NOTICE**

Be careful not to damage the lens, lens tab, and plastic housings or get them dirty.

Replacing room lamp (LED type) bulb

If the Room lamp (LED) does not operate, have the vehicle checked by an authorized Kia dealer.



The LED lamps cannot be replaced as a single component because they are part of an integrated unit. The LED lamps have to be replaced with the unit.

A skilled technician should check or repair the Room lamp (LED), for it may damage related parts of the vehicle.

Replacing personal lamp (LED Type) bulb



If the personal lamp (LED) does not operate, have the vehicle checked by an authorized Kia dealer.

The LED lamps cannot be replaced as a single unit because it is an integrated unit. The LED lamps have to be replaced with the unit.

A skilled technician should check or repair the personal lamp (LED), for it may damage related parts of the vehicle.

Replacing glove box lamp



1. Using a flat-blade screwdriver, gently pry the lamp assembly from interior.
2. Remove the bulb by pulling it straight out.
3. Install a new bulb in the socket.
4. Install the lamp assembly to interior.

⚠ CAUTION

Be careful not to damage the lens, lens tab, and plastic housings or get them dirty.

Replacing luggage lamp bulb

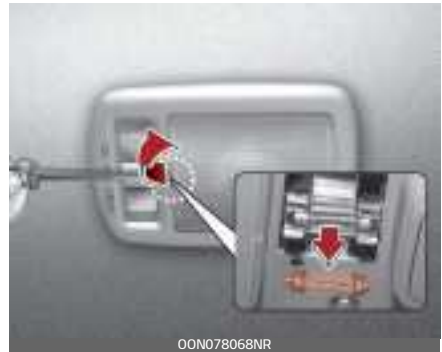

1. Using a flat-blade screwdriver, gently pry the lens cover from lamp housing.
2. Remove the bulb by pulling it straight out.
3. Install a new bulb in the socket.
4. Align the lens cover tabs with the lamp housing notches and snap the lens into place.

Replacing luggage lamp (LED Type) bulb



If the luggage lamp (LED) (1) does not operate, have the vehicle checked by an authorized Kia dealer.

The LED lamps cannot be replaced as a single component because they are part of an integrated unit. The LED lamps have to be replaced with the unit.

A skilled technician should check or repair the Liftgate room lamp (LED), for it may damage related parts of the vehicle.

* NOTICE

Be careful not to damage the lens, lens tab, and plastic housings or get them dirty.

Appearance care

Use the information in the following sections to keep the exterior and interior of your vehicle clean.

Exterior care

Use the information in the following sections to maintain the exterior of your vehicle. Keeping the exterior clean is not only aesthetically pleasing, but it also helps to prolong the life of the vehicle.

* NOTICE

If you park the vehicle around a stainless signboard or windshield building etc., the plastic exterior trim (bumper, spoiler, garnish, lamp, outside mirror etc.) may be damaged by reflected sunlight from the external structure. To avoid damaging the plastic exterior trim, park the vehicle away from the areas where the reflected light may occur or use a vehicle cover. (Depending on the vehicle, the type of exterior trim applied such as spoiler may differ.)

Exterior general caution

It is very important to follow the label directions when using any chemical cleaner or polish. Read all warning and caution statements that appear on the label.

Finish maintenance

Washing

To help protect your vehicle's finish from rust and deterioration, wash it thoroughly and frequently at least once a month with lukewarm or cold water.

If you use your vehicle for off-road driving, you should wash it after each off-road trip. Pay special attention to the removal of any accumulation of salt, dirt, mud, and other foreign materials. Make sure the drain holes in the lower edges of the doors and rocker panels are kept clear and clean.

Insects, tar, tree sap, bird droppings, industrial pollution and similar deposits can damage your vehicle's finish if not removed immediately. Even prompt washing with plain water may not completely remove all these deposits. A mild soap, safe for use on painted surfaces, may be used.

After washing, rinse the vehicle thoroughly with lukewarm or cold water. Do not allow soap to dry on the finish.

After washing the vehicle, test the brakes while driving slowly to see if they have been affected by water. If braking performance is impaired, dry the brakes by applying them lightly while maintaining a slow forward speed.

⚠ CAUTION

- Do not use strong soap, chemical detergents or hot water, and do not wash the vehicle in direct sunlight or when the body of the vehicle is warm.
- Be careful when washing the side windows of your vehicle, especially with high-pressure water. Water may leak through the windows and wet the interior.
- To prevent damage to the plastic parts and lamps, do not clean with chemical solvents or strong detergents.

High-pressure washing

When using high-pressure washers, make sure to maintain sufficient distance from the vehicle.

Insufficient clearance or excessive pressure can lead to component damage or water penetration.

Do not spray the camera, sensors or its surrounding area directly with a high pressure washer. Shock applied from high pressure water may cause the device to not operate normally.

Do not bring the nozzle tip close to boots (rubber or plastic covers) or connectors as they may be damaged if they come into contact with high pressure water.

⚠ WARNING

After washing the vehicle, test the brakes while driving slowly to see if they have been affected by water. If braking performance is impaired, dry the brakes by applying them lightly while maintaining a slow forward speed.

⚠ CAUTION**Wetting engine compartment**

00N071063

- Water washing in the engine compartment including high pressure water washing may cause the failure of electrical circuits located in the engine compartment.
- Never allow water or other liquids to come in contact with electrical/electronic components inside the vehicle as this may damage them.
- After the vehicle has been washed, brake carefully while paying attention to the traffic

conditions until the braking effect has been fully restored.

Waxing

Wax the vehicle when water will no longer bead on the paint. Always wash and dry the vehicle before waxing. Use a good quality liquid or paste wax, and follow the manufacturer's instructions. Wax all metal trim to protect it and to maintain its luster.

Removing oil, tar, and similar materials with a spot remover will usually strip the wax from the finish. Be sure to re-wax these areas even if the rest of the vehicle does not yet need waxing.

Be careful not to touch the lens when waxing the lamps.

⚠ CAUTION**Drying vehicle**

- Wiping dust or dirt off the body with a dry cloth will scratch the finish.
- Do not use steel wool, abrasive cleaners, acid detergents or strong detergents containing high alkaline or caustic agents on chrome-plated or anodized aluminum parts. This may result in damage to the protective coating and cause discoloration or paint deterioration.

Finish damage repair

Deep scratches or stone chips in the painted surface must be repaired promptly. Exposed metal will quickly rust and may develop into a major repair expense.

*** NOTICE**

If your vehicle is damaged and requires any metal repair or replacement, be sure the body shop applies anti-corrosion materials to the parts repaired or replaced.

Bright-metal maintenance

To remove road tar and insects, use a tar remover, not a scraper or other sharp object.

To protect the surfaces of bright metal parts from corrosion, apply a coating of wax or chrome preservative and rub to a high luster.

During winter weather or in coastal areas, cover the bright metal parts with a heavier coating of wax or preservative. If necessary, coat the parts with non-corrosive petroleum jelly or other protective compound.

Underbody maintenance

Road salt and other corrosive chemicals are used in cold weather states to melt snow and prevent ice accumulation. If these chemicals are not

regularly removed, they will corrode the vehicle underbody and, over time, damage many parts: the fuel lines, the fuel tank retention system, the vehicle's suspension, the exhaust system, and even the body frame.

- Wash the undercarriage of your vehicle regularly during the winter and whenever your vehicle has been exposed to such salts or chemicals.
- Do a thorough washing of the undercarriage at the end of the winter.
- Use professional service technicians or governmental inspection stations to annually inspect for corrosion.
- Immediately seek an inspection of your vehicle if you become visually aware of corrosion flaking or scaling or if you become aware of a change in vehicle performance, such as soft or spongy brakes, fluids leaking, impairment of directional control, suspension noises or rattling metal straps.

Aluminum wheel maintenance

The aluminum wheels are coated with a clear protective finish.

- Do not use any abrasive cleaner, polishing compound, solvent, or wire brushes on aluminum wheels. They may scratch or damage the finish.

- Clean the wheel when it has cooled.
- Use only a mild soap or neutral detergent, and rinse thoroughly with water. Also, be sure to clean the wheels after driving on salted roads. This helps prevent corrosion.
- Avoid washing the wheels with high speed vehicle wash brushes.
- Do not use any alkaline or acid detergents. They may damage and corrode the aluminum wheels coated with a clear protective finish.

Corrosion protection

Protecting your vehicle from corrosion

By using the most advanced design and construction practices to combat corrosion, we produce vehicles of the highest quality. However, this is only part of the job. To achieve the long-term corrosion resistance your vehicle can deliver, the owner's cooperation and assistance is also required.

Common causes of corrosion

The most common causes of corrosion on your vehicle are:

- Road salt, dirt and moisture that is allowed to accumulate underneath the vehicle.
- Removal of paint or protective coatings by stones, gravel, abrasion or minor scrapes and dents

which leave unprotected metal exposed to corrosion.

Exposure to corrosive environments

If you live in an area where your vehicle is regularly exposed to corrosive materials, corrosion protection is particularly important. Some of the common causes of accelerated corrosion are road salts, dust control chemicals, ocean air and industrial pollution.

Moisture breeds corrosion

Moisture creates the conditions in which corrosion is most likely to occur. For example, corrosion is accelerated by high humidity, particularly when temperatures are just above freezing. In such conditions, the corrosive material is kept in contact with the vehicle's surface by moisture that evaporates slowly. Mud is particularly corrosive because it dries slowly and holds moisture in contact with the vehicle. Although the mud appears to be dry, it can still retain the moisture and promote corrosion.

High temperatures can also accelerate corrosion of parts that are not properly ventilated so the moisture can be dispersed. For all these reasons, it is particularly important to keep your vehicle clean and free of mud or accumulations of other materials. This applies not only to the visible surfaces but particularly to the underside of the vehicle.

To help prevent corrosion

You can help prevent corrosion from beginning by observing the following:

Keep your vehicle clean

The best way to prevent corrosion is to keep your vehicle clean and free of corrosive materials. Attention to the underside of the vehicle is particularly important.

If you live in a corrosion-prone area where road salts are used, near the ocean, areas with industrial pollution, acid rain, etc.—, you should take extra care to prevent corrosion. In winter, hose off the underside of your vehicle at least once a month and be sure to clean the underside thoroughly when winter is over.

When cleaning underneath the vehicle, give particular attention to the components under the fenders and other areas that are hidden from view. Do a thorough job; just dampening the accumulated mud rather than washing it away will accelerate corrosion rather than prevent it. Water under high pressure and steam are particularly effective in removing accumulated mud and corrosive materials.

When cleaning lower door panels, rocker panels and frame members, be sure that drain holes are kept open so that moisture can escape

and not be trapped inside to accelerate corrosion.

Keep your garage dry

Don't park your vehicle in a damp, poorly ventilated garage. This creates a favorable environment for corrosion. This is particularly true if you wash your vehicle in the garage or drive it into the garage when it is still wet or covered with snow, ice or mud. Even a heated garage can contribute to corrosion unless it is well ventilated so moisture is dispersed.

Keep paint and trim in good condition

Scratches or chips in the finish should be covered with "touch-up" paint as soon as possible to reduce the possibility of corrosion. If bare metal is showing through, the attention of a qualified body and paint shop is recommended.

Bird droppings: Bird droppings are highly corrosive and may damage painted surfaces in just a few hours. Always remove bird droppings as soon as possible.

Don't neglect the interior

Moisture can collect under the floor mats and carpeting and cause corrosion. Check under the mats periodically to be sure the carpeting is dry. Use particular care if you carry

fertilizers, cleaning materials or chemicals in the vehicle.

These should be carried only in proper containers and any spills or leaks should be cleaned up, flushed with clean water and thoroughly dried.

Interior care

Use the information in the following sections to maintain the interior of your vehicle.

Interior general precautions

Prevent chemicals such as perfume, cosmetic oil, sun cream, hand cleaner, and air freshener from contacting the interior parts because they may cause damage or discoloration. If they do contact the interior parts, wipe them off immediately. If necessary, use a vinyl cleaner, see product instructions for correct usage.

⚠ CAUTION

Electrical components

Never allow water or other liquids to come in contact with electrical/electronic components inside the vehicle as this may damage them.

⚠ CAUTION

Leather

When cleaning leather products (steering wheel, seats etc.), use neutral detergents or low alcohol content solutions. If you use high alcohol content solutions or acid/alkaline detergents, the color of the leather may fade or the surface may get stripped off.

Taking care of leather seats

- Vacuum the seat periodically to remove dust and sand on the seat. It will prevent abrasion or damage of the leather and maintain its quality.
- Wipe the natural leather seat cover often with dry or soft cloth.
- Sufficient use of a leather protective may prevent abrasion of the cover and helps maintain the color. Be sure to read the instructions and consult a specialist when using leather coating or protective agents.
- Leather with bright colors (beige, cream beige) is easily contaminated. Clean the seats frequently.
- Avoid wiping with wet cloth. It may cause the surface to crack.

Cleaning the leather seats

Remove all contaminations instantly. Refer to instructions

below for removal of each contaminant.

- Cosmetic products (sunscreen, foundation, etc.)
 - Apply cleansing cream on a cloth and wipe the contaminated point. Wipe off the cream with a wet cloth and remove water with a dry cloth.
- Beverages (coffee, soft drink, etc.)
 - Apply a small amount of neutral detergent and wipe until contaminations do not smear.
- Oil
 - Remove oil instantly with absorbable cloth and wipe with stain remover for natural leather only.
- Chewing gum
 - Harden the gum with ice and remove gradually.

Fabric seat cover (if equipped)

Please clean the fabric seats regularly with a vacuum cleaner in consideration of fabric material characteristics. If they are heavily soiled with beverage stains, etc., use a sui interior cleaner. To prevent damage to seat covers, wipe off the seat covers down to the seams with a large wiping motion and moderate pressure using a soft sponge or microfiber cloth.

Velcro closures on clothing or sharp objects may cause snagging or

scratches on the surface of the seats.

Make sure not to rub such objects against the surface.

Cleaning the upholstery and interior trim

Vinyl

Remove dust and loose dirt from vinyl with a whisk broom or vacuum cleaner. Clean vinyl surfaces with a vinyl cleaner.

Fabric

Remove dust and loose dirt from fabric with a whisk broom or vacuum cleaner. Clean with a mild soap solution recommended for upholstery or carpets. Remove fresh spots immediately with a fabric spot cleaner. If fresh spots do not receive immediate attention, the fabric can be stained and its color can be affected. Also, its fire-resistant properties can be reduced if the material is not properly maintained. Using anything but recommended cleaners and procedures may affect the fabric's appearance and fire-resistant properties.

Cleaning the lap/shoulder belt webbing

Clean the belt webbing with any mild soap solution recommended for cleaning upholstery or carpet. Follow the instructions provided with the soap. Do not bleach or re-dye

the webbing because this may weaken it.

Cleaning the interior window glass

If the interior glass surfaces of the vehicle become fogged (that is, covered with an oily, greasy or waxy film), they should be cleaned with a glass cleaner. Follow the directions on the glass cleaner container.

⚠ CAUTION

Rear window

Do not scrape or scratch the inside of the rear window. This may result in damage of the rear window defroster grid.

Emission control system

The emission control system of your vehicle is covered by a written limited warranty. Please see the warranty information contained in the Warranty & Consumer Information manual in your vehicle.

Your vehicle is equipped with an emission control system to meet all applicable emission regulations.

There are three emission control systems, as follows.

1. Crankcase emission control system
2. Evaporative emission control system
3. Exhaust emission control system

In order to assure the proper function of the emission control systems, it is recommended that you have your vehicle inspected and maintained by an authorized Kia dealer in accordance with the maintenance schedule in this manual.

Caution for the Inspection and Maintenance Test (With Electronic Stability Control (ESC) system)

- **To prevent the vehicle from misfiring during dynamometer testing, turn the ESC off by pressing the ESC switch.**
- **After dynamometer testing is completed, turn the ESC back on by pressing the ESC switch again.**

1. Crankcase emission control system

The Positive Crankcase Ventilation system is employed to prevent air pollution caused by blow-by gases being emitted from the crankcase. This system supplies fresh filtered air to the crankcase through the air intake hose. Inside the crankcase, the fresh air mixes with blow-by gases, which then pass through the Positive Crankcase Ventilation (PCV) valve into the induction system.

2. Evaporative emission control (including Onboard Refueling Vapor Recovery (ORVR)) system

The evaporative emission control system is designed to prevent fuel vapors from escaping into the atmosphere. (The ORVR system is designed to allow the vapors from the fuel tank to be loaded into a canister while refueling at the gas station, preventing the escape of fuel vapors into the atmosphere.)

Canister

Fuel vapors generated inside the fuel tank are absorbed and stored in the onboard canister. When the engine is running, the fuel vapors absorbed in the canister are drawn into the surge tank through the Purge Control Solenoid Valve.

Purge Control Solenoid Valve (PCSV)

The Purge Control Solenoid Valve (PCSV) is controlled by the Engine Control Module (ECM); when the engine coolant temperature is low during idling, the PCSV closes so that evaporated fuel is not taken into the engine. After the engine warms up during ordinary driving, the PCSV opens to introduce evaporated fuel to the engine.

3. Exhaust emission control system

The exhaust emission control system is a highly effective system which controls exhaust emissions while maintaining good vehicle performance.

Engine exhaust gas precautions (carbon monoxide)

- Carbon monoxide can be present with other exhaust fumes. Therefore, if you smell exhaust fumes of any kind inside your vehicle, have it inspected and repaired immediately. If you ever suspect exhaust fumes are coming into your vehicle, drive it only with all the windows fully open. Have your vehicle checked and repaired immediately.

WARNING

Exhaust

Engine exhaust gases contain carbon monoxide (CO). It is a colorless, odorless and dangerous gas which is

dangerous and could be lethal if inhaled. Follow the instructions on this page to avoid CO poisoning.

- Do not operate the engine in confined or closed areas (such as garages) any more than what is necessary to move the vehicle in or out of the area.
- When the vehicle is stopped in an open area for more than a short time with the engine running, adjust the ventilation system (as needed) to draw outside air into the vehicle.
- Never sit in a parked or stopped vehicle for any extended time with the engine running.
- When the engine stalls or fails to start, excessive attempts to restart the engine may cause damage to the emission control system.

Operating precautions for catalytic converters

⚠ WARNING

Catalytic converter

Keep away from the catalytic converter and exhaust system while the vehicle is running or immediately thereafter. The exhaust and catalytic systems are very hot and may burn you.

⚠ WARNING

Fire

- Do not park, idle or drive the vehicle over or near flammable objects, such as grass, vegetation, paper, leaves, etc. A hot exhaust system can ignite flammable items under your vehicle.
- Also, do not remove the heat sink around the exhaust system, do not seal the bottom of the vehicle or do not coat the vehicle for corrosion control. It may present a fire risk under certain conditions.

Your vehicle is equipped with a catalytic converter emission control device.

Therefore, the following precautions must be observed:

- Use only UNLEADED FUEL for gasoline engines.
- Do not operate the vehicle when there are signs of engine malfunction, such as misfire or a noticeable loss of performance.
- Do not misuse or abuse the engine. Examples of misuse are coasting with the ignition off and descending steep grades in gear with the ignition off.
- Do not operate the engine at high idle speed for extended periods (5 minutes or more).
- Do not modify or tamper with any part of the engine or emission control system. All inspections

and adjustments must be made by an authorized Kia dealer.

- Avoid driving with an extremely low fuel level. Running out of fuel could cause the engine to misfire, damaging the catalytic converter.

Failure to observe these precautions could result in damage to the catalytic converter and to your vehicle. Additionally, such actions could void your warranties.

Specifications & Consumer information

Dimensions	8-2
Engine	8-2
Gross Vehicle Weight	8-2
Luggage volume	8-3
Air conditioning system	8-3
Bulb wattage	8-4
Tires and wheels	8-5
Recommended lubricants and capacities	8-6
• Recommended SAE viscosity number	8-7
Vehicle Identification Number (VIN)	8-8
Vehicle certification	8-9
Tire specification and pressure label	8-9
Engine Number	8-10
REPORTING SAFETY DEFECTS	8-11

Specifications & Consumer information

Dimensions

Item		7 Seater	8 Seater
Overall length		5,000 mm (196.8 in)	←
Overall width		1,990 mm (78.3 in)	←
Overall height	Without Roof rack	1,750 mm (68.9 in)	←
	With Roof rack	1,800 mm (70.9 in)	←
Tread	Front	245/60 R18	1,708 mm (67.2 in)
		245/50 R20	1,708 mm (67.2 in)
	Rear	245/60 R18	1,716 mm (67.6 in)
		245/50 R20	1,716 mm (67.6 in)
Wheelbase		2,900 mm (114.1 in)	←

Engine

Item	(Gasoline) 3.8 GDI
Displacement: cc (cu in)	3,778 (230.55)
Bore x Stroke: mm (in)	96 X 87 (3.78 X 3.43)
Firing order	1-2-3-4-5-6
No. of cylinders	6, V-type

Gross Vehicle Weight

kg (lbs.)

ITEM	AWD	
	7 Seater	8 Seater
(Gasoline) 3.8 GDI	2,684 (5,917)	2,684 (5,917)

Luggage volume

l (cu ft)

ITEM		7 Seater	8 Seater
SAE	MIN.	601 (21.2)	601 (21.2)
	MAX.	2,457 (86.8)	2,457 (86.8)

- Min: Behind 3rd row.
- Max: Behind front seat to roof.

Air conditioning system

g (oz)

ITEM	Weight of volume	Classification
Refrigerant	950±25 (33.5±0.9)	R-1234yf
Compressor lubricant	210±10 (7.4±0.35)	FD46XG (IDEMITUS)

Contact an authorized Kia dealer for more details.

Bulb wattage

Light Bulb		Bulb Type	Wattage (W)		
Front	Headlamp	Low	LED	LED	
		High	LED	LED	
	Turn signal lamp	Bulb type	27/8W 1157NA	27	
		LED type	LED	LED	
	Day time running lamp/Position lamp		LED	LED	
	Side marker	Bulb type	W5W	5	
		LED type	LED	LED	
	Fog lamp*		LED	LED	
Side repeater lamp (outside mirror)		LED	LED		
Rear	Rear combination lamp	Bulb type	Stop lamp	P21/5W	21/5
			Tail lamp	P21/5W	21/5
			Side marker	W5W	5
		LED type	Stop lamp	LED	LED
			Tail lamp	LED	LED
			Side marker	LED	LED
	Turn signal lamp		LED	LED	
	Back up lamp		W16W	16	
	Turn signal lamp (Bulb type only)		28/8W LL	28	
	High Mounted Stop Lamp		LED	LED	
License plate lamp		W5W	5		
Interior	Map lamp	Bulb type	FESTOON	10	
		LED type	LED	LED	
	Room lamp	Bulb type	FESTOON	10	
		LED type	LED	LED	
	Vanity mirror lamp	Bulb type	FESTOON	5	
		LED type	LED	LED	
	Personal lamp*		LED	LED	
	Glove box lamp*		FESTOON	5	
Cargo lamp	Bulb type	FESTOON	10		
	LED type	LED	LED		

*: if equipped

Tires and wheels

Item	Tire size	Wheel size	Supplier	Load Capacity		Speed capacity		Inflation pressure [kPa (psi)]				Wheel lug nut torque kgf·m (lbf·ft, N·m)
				LJ ^{*2}	kg	SS ^{*3}	km/h	Normal load ^{*1}		Maximum load		
								Front	Rear	Front	Rear	
Full size tire	245/60 R18	7.5JX18	Michelin	105	925	H	210	240	240	240	240	11~13 (79 ~ 94, 107 ~ 127)
			Pirelli					(35)	(35)	(35)	(35)	
	245/50 R20	7.5JX20	Michelin	102	850	V	240	240	240	240	240	
			Pirelli					(35)	(35)	(35)	(35)	
Compact Spare tire	T155/90 R18	4.00 BX18	Kumho	113	1,150	M	130	420	420	420	420	
								(60)	(60)	(60)	(60)	

*1. Normal load - Up to 3 persons

*2. Load Index

*3. Speed Symbol

* NOTICE

- We recommend that when replacing tires, use the same tires as the originally supplied ones. If not, that affects driving performance.
- When driving in high altitude grades, it is natural for the atmospheric pressure to decrease. Therefore, please check the tire pressure and add more air when necessary. Additionally required tire air pressure per km above sea level: 10.5 kPa(1.5 psi)/km

⚠ CAUTION



When replacing tires, use the same size originally supplied with the vehicle. Using tires of a different size can damage the related parts or make it work irregularly.

Recommended lubricants and capacities

To help achieve proper engine and powertrain performance and durability, use only lubricants of the proper quality.

Using the right lubricants help reduce engine friction and improve fuel efficiency.

These lubricants and fluids are recommended for use in your vehicle.

Lubricant		Volume	Classification
Engine oil ^{*1*2} (drain and refill)  	(Gasoline) 3.8 GDi	6.5 l (6.87 US qt.)	Full synthetic SAE 5W-30, ACEA A5/B5 ^{*3}
Automatic transmission fluid	(Gasoline) 3.8 GDi	7.0 l (7.4 US qt.)	SP-IV(M1) (Recommended: SK ATF SP4M-1, MICHANG ATF SP4M-1, S-OIL ATF SP4M-1) ^{*4}
Coolant	(Gasoline) 3.8 GDi	Approx. 12.2 l (12.9 US. qt.)	Mixture of antifreeze and distilled water (Ethylene glycol base coolant for aluminum radiator)
Brake fluid ^{*5}		0.44-0.48 l (0.47-0.51 US. qt.)	SAE J1704 DOT-4 LV, ISO4925 CLASS-6, FMVSS 116 DOT-4
Rear differential oil (AWD)		0.7 l (0.74 US qt.)	HYPOID GEAR OIL API GL-5, SAE 75W/85 (SK HCT-5 GEAR OIL 75W/85 or equivalent)
Transfer case oil (AWD)	(Gasoline) 3.8 GDi	0.7 l (0.74 US qt.)	HYPOID GEAR OIL API GL-5, SAE 75W/85 (Recommended: SK HCT-5GEAR OIL 75W85 or equivalent)
Fuel		71 l (18.75 US gal.)	Refer to "Fuel requirements" on page 1-2

*1. Refer to "Recommended SAE viscosity number" on page 8-7.

*2. Engine oils labeled Energy Conserving Oil are now available. Along with other additional benefits, they contribute to fuel economy by reducing the amount of fuel necessary to overcome engine friction. Often, these improvements are difficult to measure in everyday driving, but in a year's time, they can offer significant cost and energy savings.

*3. Requires <API Latest(or ILSAC Latest) or ACEA A5/B5 Full synthetic> grade engine oil.

- *4. Use only specified genuine Automatic transmission fluid. The use of non-specified fluid (even marked as compatible with genuine) could result in shift quality deterioration and vibrations, eventually, the transmission failure. (Refer to "Explanation of scheduled maintenance items" on page 7-14.)
- *5. To maintain your vehicle's best brake and ABS/ESC performance, use Kia genuine brake fluid as in the specification.

Recommended SAE viscosity number

CAUTION

Always be sure to clean the area around any filler plug, drain plug, or dipstick before checking or draining any lubricant. This is especially important in dusty or sandy areas and when the vehicle is used on unpaved roads. Cleaning the plug and dipstick areas will prevent dirt and grit from entering the engine and other mechanisms that could be damaged.

Engine oil viscosity (thickness) has an effect on fuel economy and cold weather operating (engine start and engine oil flowability). Lower viscosity engine oils can provide better fuel economy and cold weather performance, however, higher viscosity engine oils are required for satisfactory lubrication in hot weather. Using oils of any viscosity other than those recommended could result in engine damage. When choosing an oil, consider the range of temperature your vehicle will be operated in before the next oil change. Proceed to select the recommended oil viscosity from the chart.

Temperature Range for SAE Viscosity Numbers										
Temperature	°C	-30	-20	-10	0	10	20	30	40	50
	(°F)	-10	0	20	40	60	80	100	120	
(Gasoline) 3.8 GDi		5W-30								



An engine oil displaying this American Petroleum Institute (API) Certification Mark conforms to the international Lubricant Specification Advisory Committee (ILSAC). It is recommended to only use engine oils that uphold this API Certification Mark.

Vehicle Identification Number (VIN)

The Vehicle Identification Number (VIN) is the number used in registering your vehicle and in all legal matters pertaining to its ownership, etc.

Frame number



The number is punched on the floor under the passenger seat. To check the number, open the cover.

VIN label (if equipped)



The VIN is also on a plate attached to the top of the dashboard. The number on the plate can easily be seen through the windshield from outside.

Vehicle certification

The vehicle certification label attached on the driver's (or front passenger's) side center pillar gives the Vehicle Identification Number (VIN).



Tire specification and pressure label

The tires supplied on your new vehicle are chosen to provide the best performance for normal driving.



The tire label located on the driver's side center pillar gives the tire pressures recommended for your vehicle.

Engine Number

The engine number is stamped on the engine block as shown in the drawing.

(Gasoline) 3.8 GDi



REPORTING SAFETY DEFECTS

If you believe that your vehicle has a defect which could cause a crash or could cause injury or death, you should immediately inform Transport Canada (TC) in addition to notifying **Kia Canada Inc.**

Mailing Address:

Transport Canada – ASFAD

330 Sparks Street

Ottawa, ON

K1A 0N5

Telephone: 819-994-3328 (Ottawa-Gatineau area or internationally)

Toll free: 1-800-333-0510 (in Canada)

Online:

<http://www.tc.gc.ca/recalls>

If TC receives similar complaints, it may open an investigation, and if it finds that a safety defect exists in a group of vehicles, it may order a recall and remedy campaign. However, TC cannot become involved in individual problems between you, your dealer, or **Kia Canada Inc.**

Abbreviation..... A-2

Abbreviation**Abbreviation****A/C**

Air conditioning

ABS

Anti-lock Brake System

ADS

Auto Defogging System

AGM

Absorbent Glass Mat

AWD

All Wheel Drive

BCA

Blind-Spot Collision-Avoidance Assist

BCW

Blind-Spot Collision Warning

BVM

Bind-spot View Monitor

CMVSS

Canada Motor Vehicle Safety Standards

CRS

Child Restraint System

DAW

Driver Attention Warning

DRL

Daytime Running Light

EBD

Electronic Brake force Distribution

ECM

Electric Chromic Mirror

EDR

Event Data Recorder

EPB

Electronic Parking Brake

EPS

Electric Power Steering

ESC

Electronic Stability Control

FCA

Forward Collision-Avoidance Assist

GAW

Gross Axle Weight

GAWR

Gross Axle Weight Rating

GVW

Gross Vehicle Weight

GVWR

Gross Vehicle Weight Rating

HAC

Hill-start Assist Control

HBA

High Beam Assist

HDA

Highway Driving Assist

HUD

Head-Up Display

ISG

Idle Stop and Go

LATCH

Lower Anchors and Tether for
Children

LDW

Lane Departure Warning

LFA

Lane Following Assist

LKA

Lane Keeping Assist

MIL

Malfunction Indicator Lamp

ODS

Occupant Detection System

ORVR

Onboard Refueling Vapor Recov-
ery

PCSV

Purge Control Solenoid Valve

RCCA

Rear Cross-Traffic Collision-
Avoidance Assist

RCCW

Rear Cross-Traffic Collision Warn-
ing

ROA

Rear Occupant Alert

SCC

Smart Cruise Control

SEA

Safe Exit Assist

SRS

Supplemental Restraint System

SRSCM

SRS Control Module

SUV

Sports Utility Vehicle

TIN

Tire Identification Number

TPMS

Tire Pressure Monitoring System

VIN

Vehicle Identification Number

VSM

Vehicle Stability Management

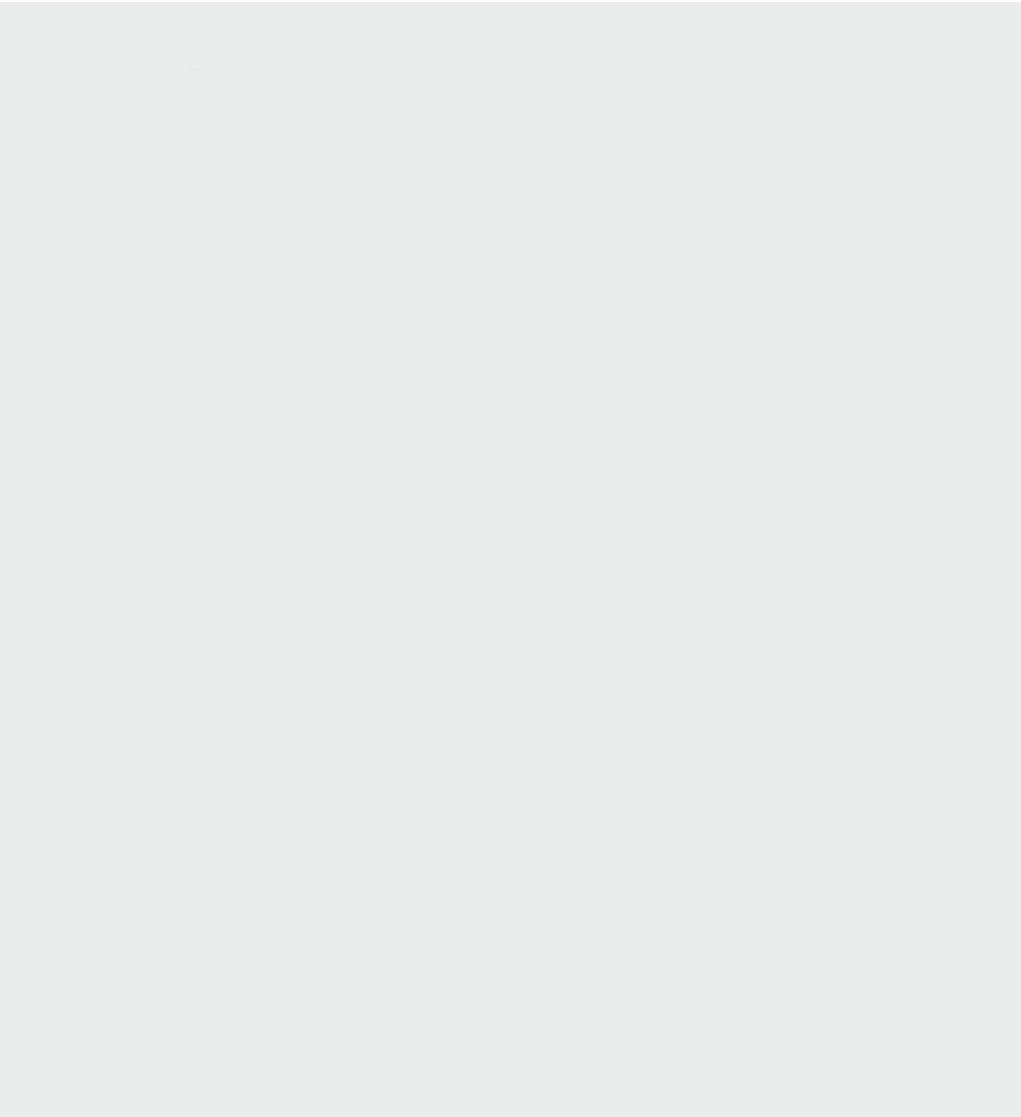

Index

Numerics

360 ° camera monitoring system 4-109

A

ac inverter 4-166
adjusting steering wheel angle and height 4-60
air bags 3-53
air bag collision sensors 3-71
air bag warning label 3-76
curtain air bag 3-69
inflation conditions 3-72
non-inflation conditions 3-74
occupant detection system (ODS) 3-59
side air bag 3-68
supplemental restraint system (SRS) 3-75
air cleaner filter 7-25
air ventilation seat 4-162
all wheel drive (AWD) system 5-18
anti-lock brake system (ABS) 5-35
appearance care 7-72
exterior care 7-72
interior care 7-78
armed stage 4-14
assist mode 4-78
audio system 4-175
antenna 4-175
radio 4-175
USB port 4-175
auto defogging system (ADS) 4-155
auto hold 5-32
warning messages 5-34
auto light 4-122

automatic climate control system 4-140
air conditioning 4-146
controlling air intake 4-145
controlling fan speed 4-146
controlling rear climate 4-147
heating and air conditioning automatically 4-141
heating and air conditioning manually 4-142
mode selection 4-143
temperature control 4-144
turning off the front air climate control 4-147
automatic transmission 5-12
good driving practices 5-16
ignition key interlock system 5-16
moving up a steep grade from a standing start 5-17
overriding the shift lock 5-16
shift lock system 5-15
transmission ranges 5-13
automatic ventilation 4-156
AWD
AWD mode 5-19
safe operation 5-21

B

battery 7-31
for best battery service 7-31
recharging the battery 7-32
reset items 7-33
battery saver function 4-120
before driving 5-6
blind-spot collision-avoidance assist (BCA) 5-72
function malfunction and limitations 5-79
function operation 5-76
function settings 5-74
limitations of the function 5-80

blind-spot view monitor (BVM)	4-119	instrument cluster control dashboard, see instrument cluster	4-71
bonnet, see the hood	4-42	daytime running light	4-120
brake fluid	7-22	declaration of conformity	4-178, 5-135
brake system	5-26	IC	4-178
anti-lock brake system (ABS)	5-35	the radio frequency components (front radar) complies	5-135
applying auto hold	5-32	the radio frequency components (rear corner radar) complies	5-139
applying the parking brake	5-28	defogging (windshield)	4-152
auto hold	5-32	defroster	4-134
canceling auto hold	5-33	defrosting (windshield)	4-152
electronic parking brake (EPB)	5-28	disarmed stage	4-15
electronic stability control (ESC)	5-37	displays, see instrument cluster	4-71
good braking practices	5-42	door locks	4-16
hill-start assist control (HAC)	5-42	central door lock switch	4-19
malfunction of EPB	5-31	from inside the vehicle	4-18
power brakes	5-26	from outside the vehicle	4-16
releasing the parking brake	5-29	sensing door	4-19
trailer stability assist (TSA)	5-41	drinks holders, see cup holders	4-159
vehicle stability management (VSM)	5-40	drive mode	4-90
bulb replacement precaution	7-60	drive mode integrated control system (AWD)	5-47

C

center console storage	4-158	driver attention warning (DAW)	5-83
central door lock switch	4-19	function malfunction and limitations	5-88
check exhaust system	5-5	function operation	5-85
child restraint system (CRS)	3-42	function settings	5-84
climate control air filter	7-26	limitations of the function	5-88
climate control system	4-136	driving at night	5-148
checking the amount of air conditioner refrigerant and compressor lubricant	4-139	driving in flooded areas	5-149
climate control air filter	4-138	driving in the rain	5-148
system operation	4-136	driving info display	4-90
coat hook	4-171	driving on unpaved roads	5-149
combined instrument, see instrument cluster	4-71		
cup holder	4-159		

D

dashboard illumination, see

E

electric chromic mirror (ECM)	4-62
electric chromic mirror (ECM) with HomeLink	4-63
electric power steering (EPS)	4-58
electronic child safety lock system	4-20
electronic stability control (ESC)	5-37
emergency	6-3
engine will not start	6-5
hazard warning flasher	6-3
road warning	6-3
emergency starting	6-6
jump-starting	6-6
push-starting	6-7
emergency while driving	6-4
engine stalls at a crossroad or crossing	6-4
flat tire while driving	6-4
vehicle stalls while driving	6-4
emission control system	7-80
engine compartment	7-4
engine coolant	7-20
recommended coolant	7-20
engine coolant temperature gauge	4-73
engine oil and filter	7-18
engine overheats	6-8
engine start/stop button	5-8
illuminated engine start/stop button	5-8
position	5-8
starting the engine	5-10
starting the engine with smart key	5-10
engine will not start	6-5
exterior features	4-173
roof rack	4-173

F

flat tire	6-15
changing tires	6-18
jack and tools	6-16
jack label	6-25
storing spare tire	6-18
use of compact spare tire	6-23
floor mat anchor(s)	4-172
fog light (front)	4-124
forward collision-avoidance assist (FCA) (sensor fusion)	5-52
detecting sensor	5-52
function malfunction and limitations	5-58
function operation	5-55
function settings	5-53
limitations of the function	5-59
fuel filler door	4-44
fuel gauge	4-74
fuel requirements	1-2
fuses	7-46
fuse/relay panel description	7-51
replacing engine compartment fuse	7-49
replacing inner panel fuse	7-48

G

gauges	4-72
glove box	4-158
glove box lamp	4-133
good braking practices	5-42

H

hazardous driving conditions	5-146
headlight position	4-121
head-up display (HUD)	4-106
heated steering wheel	4-61
heating and air conditioning automatically	4-141

heating and air conditioning		luggage net holder	4-172
manually	4-142	power outlet	4-164
high beam assist (HBA)	4-124	seat warmer	4-161
highway driving	5-149	side curtain	4-171
highway driving assist		sun visor	4-163
(HDA)	5-117	USB charger	4-165
highway driving assist		wireless smart phone charging	
malfunction	5-121	system	4-167
highway driving assist		interior light	4-131
operation	5-119	automatic turn off function	4-131
highway driving assist setting and		glove box lamp	4-133
activation	5-118	liftgate room lamp	4-132
hill-start assist control (HAC)	5-42	map lamp	4-131
HomeLink	4-63	room lamp	4-132
canadian programming garage & gate		vanity mirror lamp	4-132
openers	4-67		
operating	4-65		
programming	4-64		
programming rolling code	4-65		
hood	4-42		
closing the hood	4-43		
hood open warning	4-42		
opening the hood	4-42		
horn	4-61		
<hr/>			
I			
idle stop and go (ISG)	5-44		
deactivating	5-46		
illuminated engine start/stop			
button	5-8		
immobilizer system	4-13		
indicator lights	4-102		
inside rearview mirror	4-62		
instrument cluster	4-71		
gauges	4-72		
instrument cluster control	4-72		
interior features	4-159		
ac inverter	4-166		
air ventilation seat	4-162		
coat hook	4-171		
cup holder	4-159		
floor mat anchor(s)	4-172		
		jump-starting	6-6
		<hr/>	
		L	
		lane following assist (LFA)	5-113
		function malfunction and	
		limitations	5-117
		function operation	5-114
		function settings	5-114
		lane keeping assist (LKA)	5-66
		function malfunction and	
		limitations	5-70
		function operation	5-68
		function settings	5-66
		limitations of the function	5-70
		LCD display	4-76
		assist mode	4-78
		LCD display control	4-76
		LCD display modes	4-77
		master warning mode	4-79
		trip computer mode	4-78
		turn by turn (TBT) mode	4-78
		user settings mode	4-79
		LCD display messages	4-91
		LCD display modes	4-77
		LCD displays	4-87

drive mode	4-90
driving info display	4-90
LCD display messages	4-91
service mode	4-90
trip information (trip computer)	4-87
liftgate	
closing the manual liftgate	4-25
closing the power liftgate	4-29
opening the manual liftgate	4-24
opening the manual liftgate in emergency	4-26
opening the power liftgate	4-28
power liftgate non-opening conditions	4-30
resetting the power liftgate	4-32
setting the speed of opening/closing	4-32
liftgate room lamp	4-132
light bulbs	
bulb replacement precaution	7-60
lighting	4-120
auto light	4-122
battery saver function	4-120
daytime running light	4-120
headlight position	4-121
high beam assist (HBA)	4-124
one-touch lane change	4-123
operating front fog light	4-124
operating high beam	4-122
operating turn signals	4-123
position and tail lamp	4-121
lights bulbs	7-60
headlamp bulb	7-63
replacing bulbs	7-63
loss of the smart key	4-10
luggage box	4-159
luggage net holder	4-172

M

maintenance services	7-5
owner maintenance precautions	7-5
owner's responsibility	7-5
manual liftgate	4-24

map lamp	4-131
master warning mode	4-79
mirrors	4-62
adjusting the outside rearview mirrors	4-68
electric chromic mirror (ECM)	4-62
electric chromic mirror (ECM) with HomeLink	4-63
folding the outside rearview mirror	4-68
inside rearview mirror	4-62
outside rearview mirror	4-67

N

navigation-based smart cruise control (NSCC)	5-107
function operation	5-108
function settings	5-108
limitations of the function	5-109

O

occupant detection system (ODS)	3-59
odometer	4-74
operating high beam	4-122
outside rearview mirror	4-67
outside temperature gauge	4-75
owner maintenance	7-6

P

parking distance warning	4-114
non-operational conditions	4-117
operation	4-114
self-diagnosis	4-118
parking distance warning-reverse	
non-operational conditions	4-112
operation	4-111
precautions	4-112
self-diagnosis	4-113
position and tail lamp	4-121

power brakes	5-26	brake fluid	7-16
power liftgate	4-27	brake hoses and lines	7-16
power outlet	4-164	checking fluid levels	7-17
power window lock switch	4-40	coolant	7-15
push-starting	6-7	cooling system	7-15
		drive belts	7-14
		drive shafts and boots	7-17
		engine oil and filter	7-14
		exhaust pipe and muffler	7-16
		fuel filter	7-14

R

rear cross-traffic collision-avoidance assist (RCCA)	5-124	fuel lines, fuel hoses and connections	7-15
function malfunction and limitations	5-130	fuel tank and fuel cap	7-15
function operation	5-126	parking brake	7-16
function settings	5-125	spark plugs	7-15
limitations of the function	5-132	steering gear box, linkage and boots/	
rear cross-traffic safety	5-125	lower arm ball joint	7-17
rear occupant alert (ROA)		suspension mounting bolts	7-16
system	4-22	vacuum crankcase ventilation	
rear view monitor	4-108	hoses	7-15
reducing the risk of a rollover	5-146	valve clearance	7-15
replacing smart key battery	4-12	scheduled maintenance	
REPORTING SAFETY DEFECTS	8-11	service	7-8
reverse parking distance warning (PDW)	4-111	maintenance under severe usage	
risk of burns when parking or stopping vehicle	1-6	conditions	7-13
rocking the vehicle	5-147	normal maintenance schedule	7-10
roof rack	4-173	seat	3-5
room lamp	4-132	adjustment	3-9
		armrest	3-21
		driver position memory	3-12
		folding the rear seat	3-21
		headrest	3-15
		seat leather	3-9
		seatback hook	3-18
		seatback pocket	3-18
		seat belts	3-27
		3-point system	3-30
		care of seat belts	3-41
		child restraint system (CRS)	3-42
		installing a CRS	3-45
		precautions	3-39
		pre-tensioner seat belt	3-37
		seat belt warning	3-28
		seat warmer	4-161

S

safe exit assist (SEA) system	4-21		
safety precautions	3-3		
scheduled maintenance items	7-14		
air cleaner filter	7-15		
air conditioning refrigerant	7-17		
automatic transmission fluid	7-16		
brake discs, pads and calipers	7-16		

recommended cold tire inflation pressures	7-34
tire maintenance	7-38
tire pressure	7-35
tire replacement	7-37
tire sidewall labeling	7-38
tire terminology and definitions	7-41
wheel alignment and tire balance	7-36
wheel replacement	7-37
towing	6-26
towing service	6-26
without wheel dollies	6-27
trailer stability assist (TSA)	5-41
trailer towing	5-152
driving with a trailer	5-154
hitches	5-153
maintenance when trailer towing	5-157
pull a trailer	5-157
safety chains	5-153
trailer brakes	5-154
transmission shift indicator	4-75
automatic transmission shift indicator	4-75
trip computer mode	4-78
trip information (trip computer)	4-87
turn by turn (TBT) mode	4-78
turn signals	4-123

U

USB charger	4-165
user settings mode	4-79

V

vanity mirror lamp	4-132
vehicle break-in process	1-5
vehicle capacity weight	
determining correct load limit	5-161
vehicle data collection and event	

data recorders	1-7
vehicle handling instructions	1-6
vehicle identification number (VIN)	8-8
vehicle load limit	5-160
certification label	5-163
tire and loading information label	5-160
vehicle stability management (VSM)	5-40
vehicle weight	5-164

W

warning and indicator lights	4-96
indicator lights	4-102
warning lights	4-96
warning lights	4-96
washer fluid	7-24
welcome system	4-133
window opening and closing	4-39
windows	4-37
power window lock switch	4-40
window opening and closing	4-39
windshield defrosting and defogging	4-152
auto defogging system (ADS)	4-155
defogging logic	4-154
windshield washers	4-128
winter driving	5-150
snow tires	5-150
snowy or icy conditions	5-150
wiper blades	7-28
blade inspection	7-28
replacing wiper blade	7-28
wipers and washers	4-127
auto control	4-128
operating windshield washer	4-129
rear window wiper and washer	4-130
windshield washers	4-128
wireless smart phone charging system	4-167

