



2023

**LS500**

OWNER'S MANUAL QUICK GUIDE

# Contents

The Quick Guide is not intended as a substitute for your *OWNER'S MANUAL*. We strongly encourage you to review the *OWNER'S MANUAL* and supplementary manuals so you will have a better understanding of your vehicle's capabilities and limitations.

<b>Pictorial Index</b> .....	<b>3</b>
<b>Floor Mat Installation</b>	
Floor Mat Installation.....	11
<b>Entering and Exiting</b>	
Keys.....	12
Smart Access System with Push-button Start.....	14
<b>When Driving</b>	
Front Seats.....	16
Power Rear Seat.....	19
Driving Position Memory.....	20
Digital Rearview Mirror.....	22
Engine (Ignition) Switch.....	23
Automatic Transmission.....	26
Turn Signal Lever.....	30
Parking Brake.....	31
Brake Hold.....	33
Multi-information Display.....	34
Head-up Display.....	36
Headlight Switch.....	38
AHB (Automatic High Beam).....	40
Windshield Wipers and Washer.....	42
Driving Mode Select Switch.....	44

**Driving Comfort**

Fuel Consumption Information .....47  
Basic Operation of Multimedia System ..... 49  
Navigation \* ..... 50  
Connecting a Smartphone or Communication Device \* ..... 54  
Basic Operation of Audio System \* ..... 59  
Connecting the USB Port ..... 64  
Lexus Climate Concierge ..... 65  
Front Automatic Air Conditioning System \* ..... 66  
Rear Automatic Air Conditioning System ..... 69  
Starting Voice Control\* ..... 70  
Garage Door Opener .....74

**Connected Services**

Safety Connect .....79  
Remote Connect.....81  
Service Connect.....82

**Opening and Closing**

Door Locks ..... 83  
Power Windows ..... 85  
Moon Roof ..... 86  
Panoramic Moon Roof ..... 87  
Fuel Tank Cap ..... 89  
Trunk ..... 90

**What to do if...**

List of Warning/Indicator Lights ..... 92  
If the electronic key does not operate properly ..... 96  
If the engine will not start..... 98

\*: This feature may be operated by Voice Control (See P.70)

# Pictorial Index

## Instrument panel

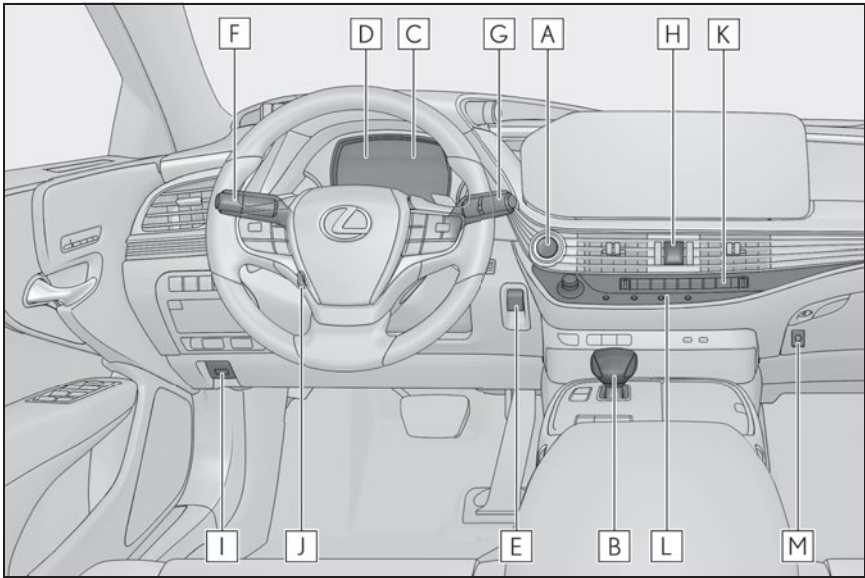

<b>A</b>	<b>Engine switch</b> .....	<b>P.23</b>
	Starting the engine/changing the modes.....	P.23
	Emergency stop of the engine.....	P.25
	When the engine will not start.....	P.98
	Warning messages*	
<b>B</b>	<b>Shift lever</b> .....	<b>P.26</b>
	Changing the shift position.....	P.26
	Precautions for towing*	
<b>C</b>	<b>Meters*</b>	
	Reading the meters/adjusting the instrument panel light*	
	Warning lights/indicator lights.....	P.92
	When a warning light turns on*	
<b>D</b>	<b>Multi-information display</b> .....	<b>P.34</b>
	Display.....	P.34
	When a warning messages is displayed*	

<b>E</b>	<b>Parking brake switch</b> .....	P.31
	Applying/releasing the parking brake.....	P.31
	Precautions for winter season*	
	Warning buzzer/messages*	
<b>F</b>	<b>Turn signal lever</b> .....	P.30
	<b>Headlight switch</b> .....	P.38
	Headlights/parking lights/tail lights/license plate lights/ daytime running lights.....	P.38
	AHB (Automatic High Beam).....	P.40
<b>G</b>	<b>Windshield wiper and washer switch</b> .....	P.42
	Usage.....	P.42
	Adding washer fluid*	
	Warning messages*	
<b>H</b>	<b>Emergency flasher switch</b> *	
<b>I</b>	<b>Hood lock release lever</b> *	
<b>J</b>	<b>Tilt and telescopic steering control switch</b> *	
	Adjustment*	
	Driving position memory.....	P.20
<b>K</b>	<b>Air conditioning system</b> .....	P.66
	Usage.....	P.66
	Rear window defogger.....	P.66
<b>L</b>	<b>Audio system</b> .....	P.59
<b>M</b>	<b>Trunk opener main switch</b> *	

\*: Refer to the "OWNER'S MANUAL".

## ■ Switches

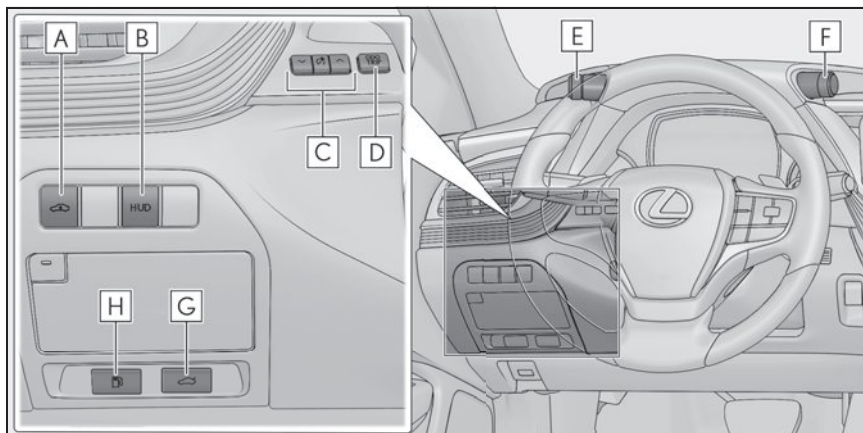

- A** Vehicle height adjustment switch \*1,2
- B** HUD (Head-up display) switch \*1 ..... P.36
- C** Instrument panel light control switches \*2
- D** “ODO TRIP” switch \*2
- E** VSC OFF switch \*2  
Snow mode switch..... P.27
- F** Driving mode select switch ..... P.44
- G** Trunk opener switch ..... P.90
- H** Fuel filler door opener switch ..... P.89

\*1: If equipped

\*2: Refer to the “OWNER’S MANUAL”.

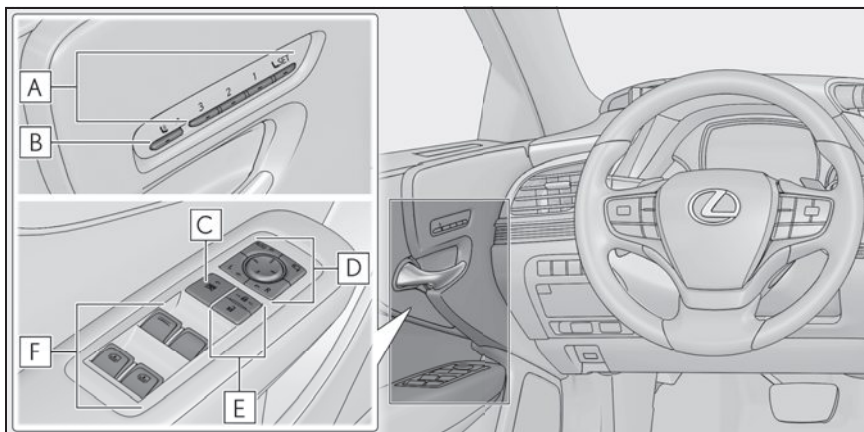

<b>A</b>	Position memory buttons .....	P.20
<b>B</b>	Mode change button .....	P.17
<b>C</b>	Window lock switch .....	P.85
<b>D</b>	Outside rear view mirror switches <sup>*1</sup>	
<b>E</b>	Door lock switches .....	P.83
<b>F</b>	Power window switches .....	P.85
	Rear door sunshade switches <sup>*1,2</sup>	

\*1: Refer to the "OWNER'S MANUAL".

\*2: If equipped

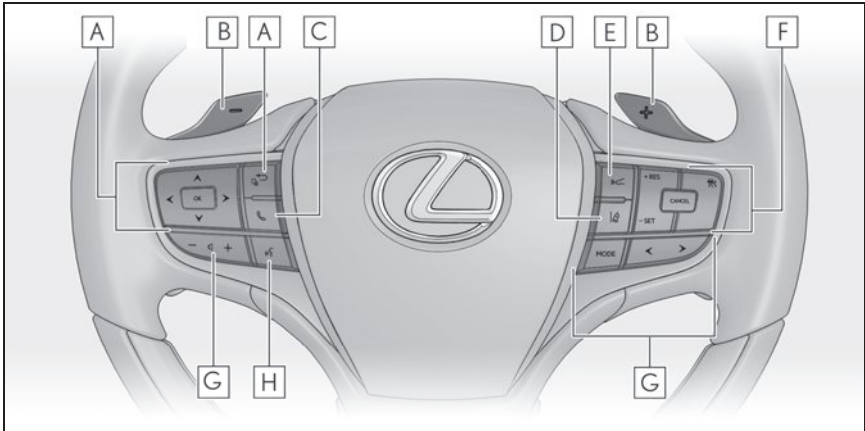

- A** Meter control switches ..... P.35
- B** Paddle shift switches ..... P.28, 29
- C** Phone switch ..... P.56
- D** LTA (Lane Tracing Assist) switch \*
- E** Vehicle-to-vehicle distance switch \*
- F** Cruise control switches \*
- G** Audio remote control switches ..... P.59
- H** Talk switch ..... P.56

\*: Refer to the "OWNER'S MANUAL".



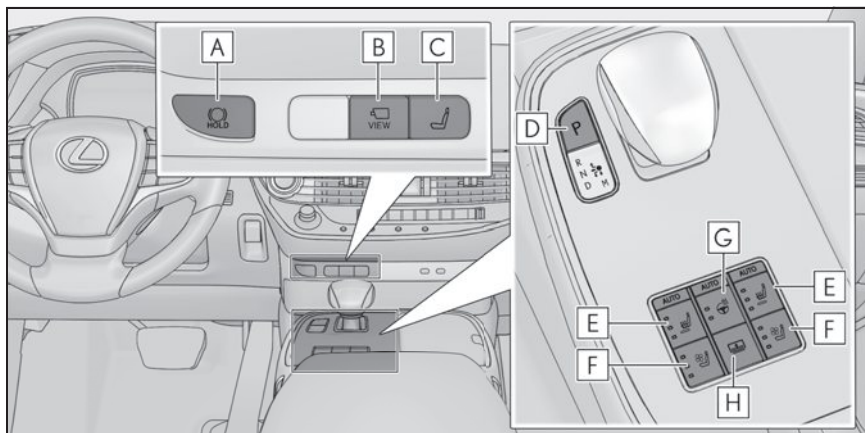

- A** Brake hold switch ..... P.33
- B** Camera switch<sup>\*1,2</sup>
- C** Seat switch..... P.16
- D** P position switch..... P.26
- E** Seat heater switches<sup>\*2,3</sup>
- F** Seat ventilator switches<sup>\*2,3</sup>
- G** Heated steering wheel switch<sup>\*2,3</sup>
- H** Rear sunshade switch<sup>\*3</sup>

\*1: Refer to "MULTIMEDIA OWNER'S MANUAL".

\*2: If equipped

\*3: Refer to the "OWNER'S MANUAL".

## ■ Interior

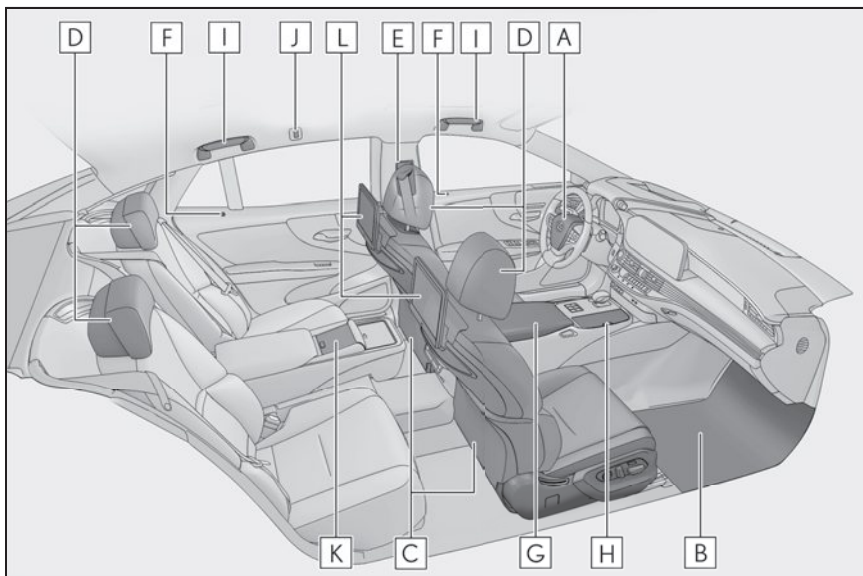

- A** SRS airbags \*1
- B** Floor mats ..... P.11
- C** Front seats ..... P.16
- D** Head restraints \*1
- E** Seat belts \*1
- F** Inside lock buttons ..... P.83
- G** Console box \*1
- H** Cup holders \*1
- I** Assist grips \*1
- J** Coat hooks \*1
- K** Rear Multi Operation Panel \*1,2
- L** Rear seat entertainment system \*2,3

\*1. Refer to the "OWNER'S MANUAL".

\*2. If equipped

\*3. Refer to "MULTIMEDIA OWNER'S MANUAL".

## ■ Ceiling

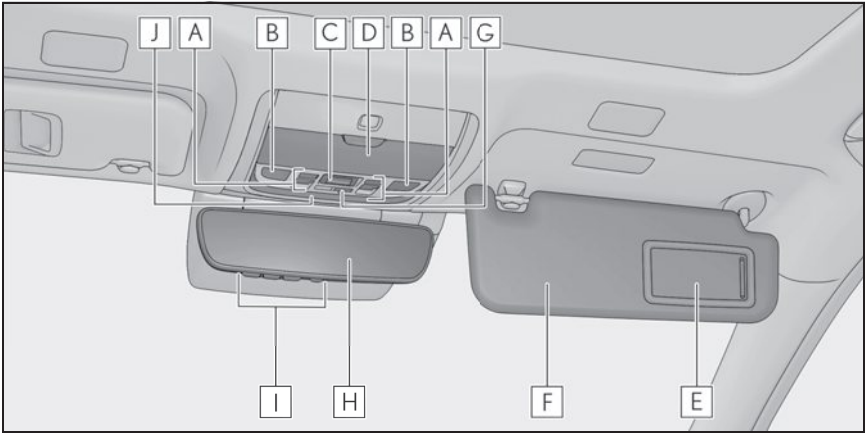

- A** Moon roof switches <sup>\*1</sup> ..... P.86  
     Panoramic moon roof switches <sup>\*1</sup> ..... P.88
- B** Personal lights <sup>\*2</sup>
- C** "SOS" button <sup>\*1</sup> ..... P.79
- D** Auxiliary box <sup>\*2</sup>
- E** Vanity mirrors <sup>\*2</sup>
- F** Sun visors <sup>\*2</sup>
- G** Door-linked interior light switch <sup>\*2</sup>
- H** Inside rear view mirror <sup>\*1,2</sup>  
     Digital Rearview Mirror <sup>\*1</sup> ..... P.22
- I** Garage door opener buttons..... P.74
- J** Interior light <sup>\*2</sup>

<sup>\*1</sup>: If equipped

<sup>\*2</sup>: Refer to the "OWNER'S MANUAL".

## Floor Mat Installation

Use only floor mats designed specifically for vehicles of the same model and model year as your vehicle. Fix them securely in place onto the carpet.

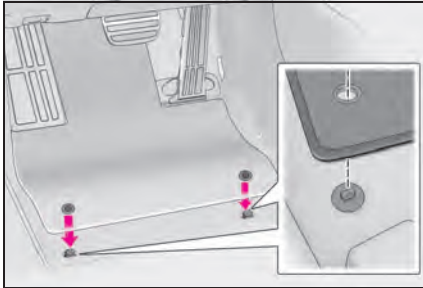

- 1 Insert the retaining hooks (clips) into the floor mat eyelets.

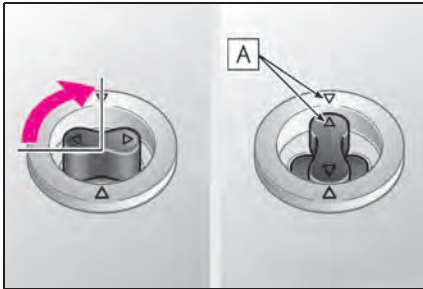

- 2 Turn the upper knob of each retaining hook (clip) to secure the floor mats in place.

Always align the  $\triangle$  marks **A**.

The shape of the retaining hooks (clips) may differ from that shown in the illustration.

# Keys

## The keys

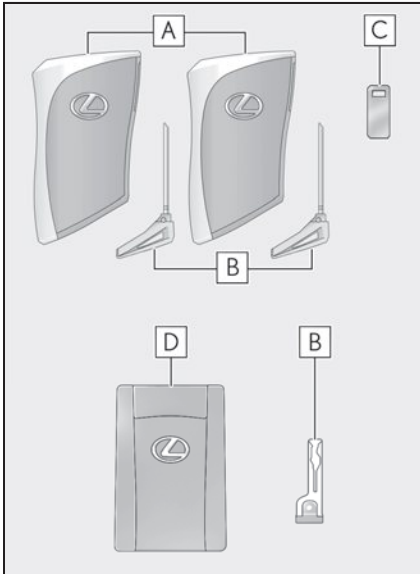

**A** Electronic keys

- Operating the smart access system with push-button start (→P.14)
- Operating the wireless remote control function

**B** Mechanical keys

**C** Key number plate

**D** Card key (electronic key) (if equipped)

Operating the smart access system with push-button start (→P.14)

## Wireless remote control

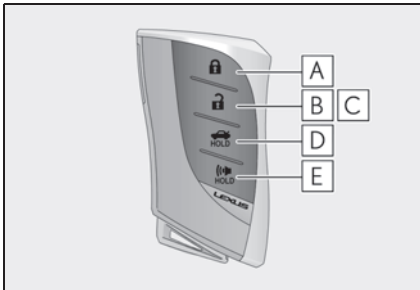

**A** Locks the doors

**B** Unlocks the doors

**C** Opens the windows\*<sup>1</sup> and moon roof\*<sup>1, 2</sup> or panoramic moon roof (press and hold)\*<sup>1, 2</sup>

**D** Opens the trunk

**E** Sounds the alarm

\*<sup>1</sup>: This setting must be customized at your Lexus dealer.

\*<sup>2</sup>: If equipped

## Mechanical key

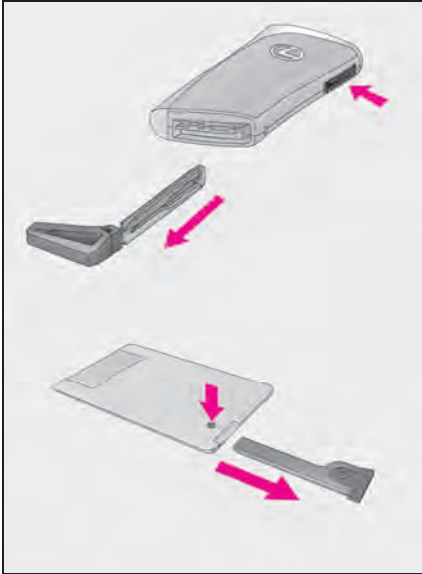

To take out the mechanical key, push the release button and take the key out.

The mechanical key can only be inserted in one direction, as the key only has grooves on one side. If the key cannot be inserted in a lock cylinder, turn it over and re-attempt to insert it.

After using the mechanical key, store it in the electronic key. Carry the mechanical key together with the electronic key. If the electronic key battery is depleted or the entry function does not operate properly, you will need the mechanical key.

## Smart Access System with Push-button Start

The following operations can be performed simply by carrying the electronic key (including the card key) on your person, for example in your pocket. The driver should always carry the electronic key.

For details on starting the engine, see page 23.

### Unlocking and locking the doors from the outside

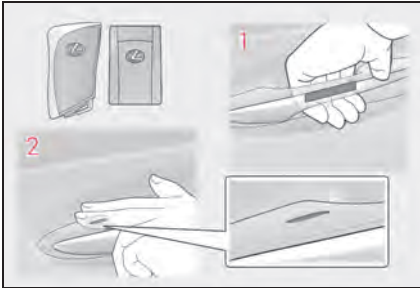

- 1** Grip the driver's door handle to unlock the door. Holding the driver's door handle for approximately 2 seconds unlocks all the doors. Grip any passenger door handle to unlock all the doors.\*

Make sure to touch the sensor on the back of the handle.

The doors cannot be unlocked for 3 seconds after the doors are locked.

\*: The door unlock settings can be changed.

- 2** Touch the lock sensor (indentation on the upper part of the door handle) to lock all the doors.

Check that the door is securely locked.

## Opening the trunk

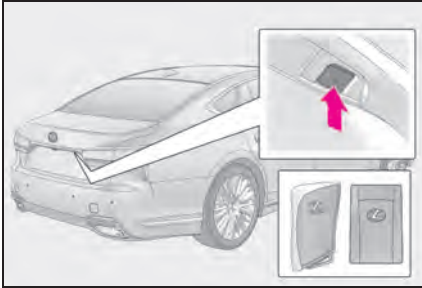

Press the button.

If the vehicle is equipped with a power trunk opener and closer, the trunk lid will fully open.

If the button is pressed while the trunk lid is opening, the trunk lid will stop moving.

When all the doors are unlocked using one of the following methods, the trunk can be opened without the electronic key:

- Entry function
- Wireless remote control
- Door lock switches
- Automatic door unlocking system
- Mechanical key

For details on what to do when the electronic key does not operate properly, see page 96.



# Front Seats

## Adjustment procedure

### ■ Seat adjustment switches

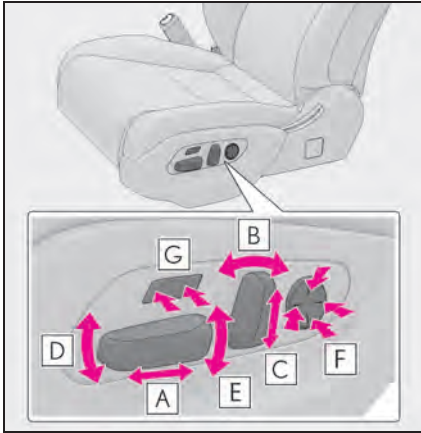

- A** Seat position adjustment
- B** Seatback angle adjustment
- C** Head restraint height adjustment (if equipped)
- D** Seat cushion (front) angle adjustment
- E** Vertical height adjustment
- F** Lumbar support adjustment
- G** Seat cushion length adjustment (if equipped)

### ■ Center Display

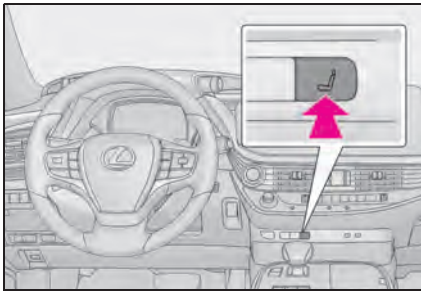

- 1** Press the seat switch.

- 2** Select "Adjustments".
- 3** Select the driver's seat or front passenger's seat.
- 4** Select the button for the desired adjustment.
  - Head restraint (if equipped)
  - Shoulder bolster (if equipped)
  - Lumbar support
  - Pelvic support
  - Hip support (if equipped)
  - Seatback side bolster and seat cushion side bolster (if equipped)
- 5** Perform adjustment using the displayed buttons.

The seat will move while a button is selected.

## Operating the front passenger's seat from the driver's seat

### ■ Using the driver's seat adjustment switches to adjust the front passenger's seat (front passenger mode)

The mode of the driver's seat adjustment switches can be changed to adjust the front passenger's seat.

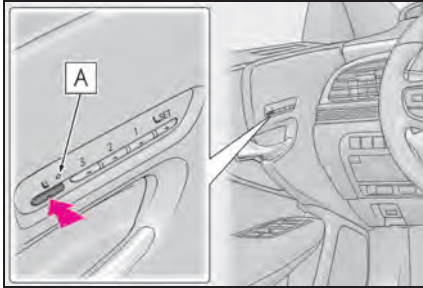

- 1 Press the mode change button on the driver's side door.

The indicator **A** will illuminate when front passenger mode is selected.

- 2 Using the seat adjustment switches on the driver's seat, adjust the front passenger's seat.

To cancel front passenger mode, press the mode change button again.

Front passenger mode will be canceled automatically if the driver's seat adjustment switches are not operated for approximately 30 seconds.

## ■ Using the Center Display (vehicles with a foldable head restraint)

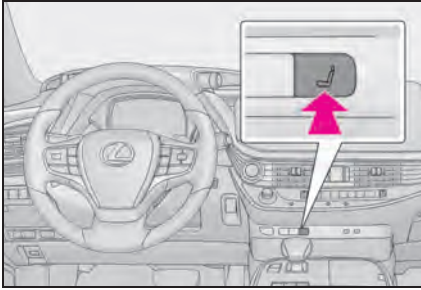

**1** Press the seat switch.

**2** Select "Arrangement".

**3** Select the front passenger's seat.

**4** Select the button for the desired operation.

"Seat fold": Move the front passenger's seat forward and folds the seatback and head restraint.

"Seat return": Move the front passenger's seat rearward and the seatback and head restraint to the upright position.

To stop the front passenger's seat while it is moving, select the "Seat fold" or "Seat return" or press the seat switch.

## Power Rear Seat (if equipped)

### Returning the rear seat from the front seats

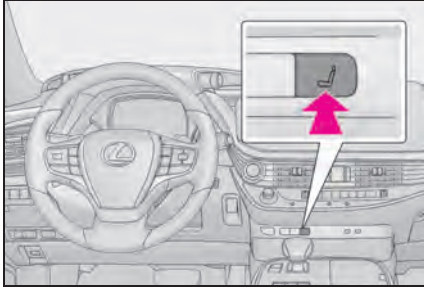

**1** Press the seat switch.

- 2** Select "Arrangement".
- 3** Select the rear seat.
- 4** Select "Return".

## Driving Position Memory

This feature automatically adjusts the positions of the front seats, steering wheel, outside rear view mirrors and head-up display (if equipped) to make entering and exiting the vehicle easier or to suit your preferences.

Up to 3 different driving positions can be recorded.

### Recording a driving position into memory

- 1 Turn the engine switch to IGNITION ON mode.
- 2 Check that the shift position is in P.
- 3 Adjust the driver's seat, steering wheel, outside rear view mirrors and head-up display (if equipped) to the desired positions.

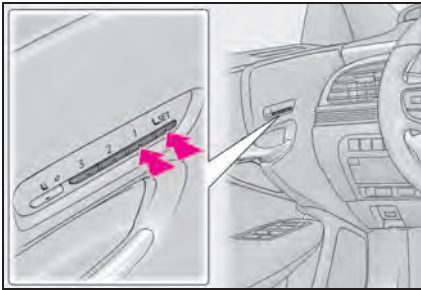

- 4 While pressing the "SET" button, or within 3 seconds after the "SET" button is pressed, press button "1", "2" or "3" until the buzzer sounds.

If the selected button has already been preset, the previously recorded position will be overwritten.

When the driver's seat adjustment switches are in front passenger mode (→P.17), the position of the driver's seat cannot be registered.

To record the position of the front passenger's seat, adjust the front passenger's seat to the desired position and perform step 4 using the buttons on the front passenger's side.

### Recalling a driving position

- 1 Turn the engine switch to IGNITION ON mode.
- 2 Check that the shift position is in P.

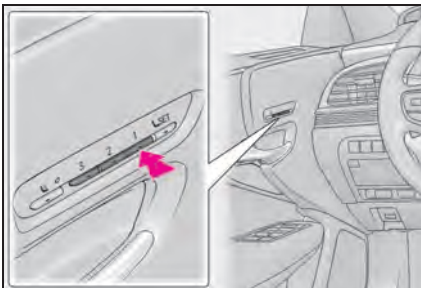

- 3 Press one of the buttons for the driving position you want to recall until the buzzer sounds.

When the driver's seat adjustment switches are in front passenger mode (→P.17), a driving position cannot be recalled.

## Memory recall function (driver's side only)

Each electronic key (including a card key) can be registered to recall your preferred driving position.

### ■ Registering procedure

Record your driving position to button "1", "2" or "3" before performing the following:

Carry only the key you want to register, and then close the driver's door.

If 2 or more keys are in the vehicle, the driving position cannot be recorded properly.

- 1 Turn the engine switch to IGNITION ON mode.
- 2 Check that the shift position is in P.
- 3 Recall the driving position that you want to record.

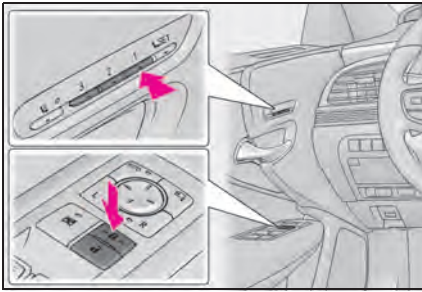

- 4 While pressing the recalled button, press and hold the door lock switch (either lock or unlock) until the buzzer sounds.

If the button could not be registered, the buzzer sounds continuously for approximately 3 seconds.

## Digital Rearview Mirror (if equipped)

The Digital Rearview Mirror is a system that uses the camera on the rear of the vehicle and displays its image on the display of the Digital Rearview Mirror.

The Digital Rearview Mirror allows the driver to see the rear view despite obstructions, such as the head restraints, luggage or rear sunshade ensuring rear visibility. Also, the rear seats are not displayed and privacy of the passengers is enhanced.

### System components

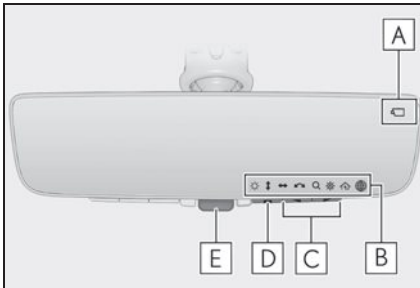

- A** Camera indicator  
Indicates that the camera is operating normally.
- B** Icon display area  
Displays icons, adjusting gauge, etc.
- C** Select button  
Press to change the setting of the item you want to adjust.

- D** Menu button

Press to display the icon display area and select the item you want to adjust.

- E** Lever

Operate to change between digital mirror mode and optical mirror mode.

### Changing modes

Operate the lever to change between digital mirror mode and optical mirror mode.

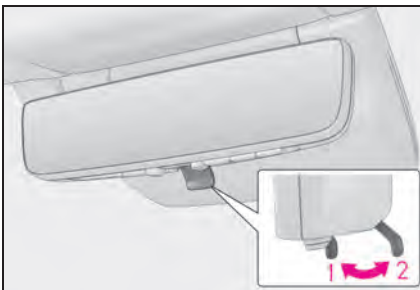

- 1** Digital mirror mode  
Displays an image of the area behind the vehicle.  
 will illuminate in this mode.
- 2** Optical mirror mode  
Turns off the display of the Digital Rearview Mirror allows it to be used as an optical mirror.

## Engine (Ignition) Switch

Performing the following operations when carrying the electronic key on your person starts the engine or changes engine switch modes.

### Starting the engine

- 1 Press the parking brake switch to check that the parking brake is set.

The parking brake indicator will come on.

- 2 Firmly depress the brake pedal.



and a message will be displayed on the multi-information display.

If it is not displayed, the engine cannot be started.

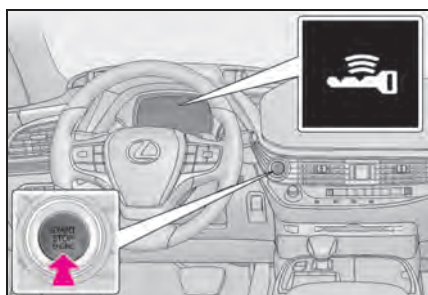

- 3 Press the engine switch shortly and firmly.

When operating the engine switch, one short, firm press is enough. It is not necessary to press and hold the switch.

The engine will crank until it starts or for up to 30 seconds, whichever is less.

Continue depressing the brake pedal until the engine is completely started.

The engine can be started from any engine switch mode.



## Stopping the engine

- 1 Stop the vehicle completely.
- 2 If the parking brake is in manual mode, set the parking brake.
- 3 Press the P position switch. (→P.26)  
Check that the shift position indicator shows P and the parking brake indicator is illuminated.
- 4 Press the engine switch.
- 5 Release the brake pedal and check that “ACCESSORY” or “IGNITION ON” is not shown on the meter.

## Changing engine switch modes

Modes can be changed by pressing the engine switch with the brake pedal released. (The mode changes each time the switch is pressed.)

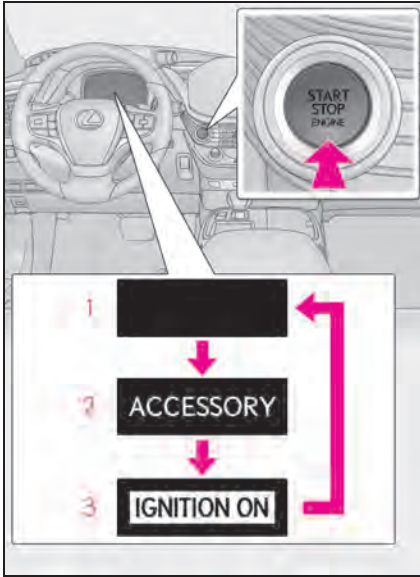

- 1 Off  
The emergency flashers can be used.
- 2 ACCESSORY mode  
Some electrical components such as the audio system can be used.  
“ACCESSORY” will be displayed on the meter.
- 3 IGNITION ON mode  
All electrical components can be used.  
“IGNITION ON” will be displayed on the meter.

## If your vehicle has to be stopped in an emergency

Only in an emergency, such as if it becomes impossible to stop the vehicle in the normal way, stop the vehicle using the following procedure:

- 1** Steadily step on the brake pedal with both feet and firmly depress it.  
Do not pump the brake pedal repeatedly as this will increase the effort required to slow the vehicle.
- 2** Shift the shift position to N.
- ▶ **If the shift position is shifted to N**
- 3** After slowing down, stop the vehicle in a safe place by the road.
- 4** Stop the engine.
- ▶ **If the shift position cannot be shifted to N**
- 3** Keep depressing the brake pedal with both feet to reduce vehicle speed as much as possible.

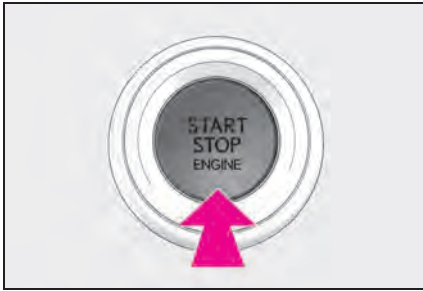

- 4** To stop the engine, press and hold the engine switch for 2 consecutive seconds or more, or press it briefly 3 times or more in succession.

- 5** Stop the vehicle in a safe place by the road.

# Automatic Transmission

## Shift position display and how to change the shift position

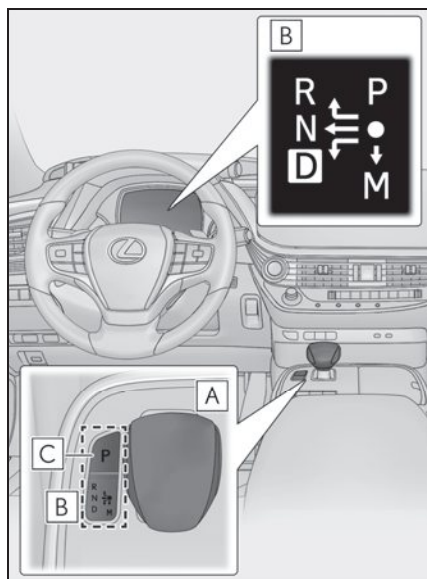

### A Shift lever

Operate the shift lever gently and securely in the direction of the arrow on the shift position indicator.

To shift to N, slide the shift lever in the direction of the arrow and hold it.

Release the shift lever after each shifting operation to allow it to return to its regular position ( ● ).

Shifting to M is only possible when the shift position is in D.

When shifting from P to N, D or R, from N, D, M or R to P, from D or M to R, or from R to D, ensure that the brake pedal is being depressed and the vehicle is stationary.

### B Shift position indicator

Meter display:

The current shift position is highlighted.

When any shift position other than D or M is selected, the arrow toward M and the M position indicator are displayed in gray.

Shift lever display:

The current shift position is illuminated.

When selecting the shift position, make sure that the shift position has been changed to the desired position by checking the shift position indicator provided on the instrument cluster.

### C P position switch

Fully stop the vehicle and set the parking brake, and then press the P position switch.

When the shift position is changed to P, the switch illuminates.

Check that the shift position indicator shows P.

## Shift position purpose and functions

Shift position	Objective or function
P	Parking the vehicle/starting the engine
R	Reversing
N	Neutral (Condition in which the power is not transmitted)
D	Normal driving <sup>*1</sup>
M	M mode driving <sup>*2</sup>

<sup>\*1</sup>: To improve fuel efficiency and reduce noise, set the shift position in D for normal driving. You can choose gear range suitable for your driving situation by operating the paddle shift switches.

<sup>\*2</sup>: Any gear range can be fixed when driving in M mode.

## Selecting the driving mode

### ■ Driving mode

→P.44

### ■ Snow mode

Snow mode can be selected to suit the conditions when driving on slippery road surfaces, such as on snow.

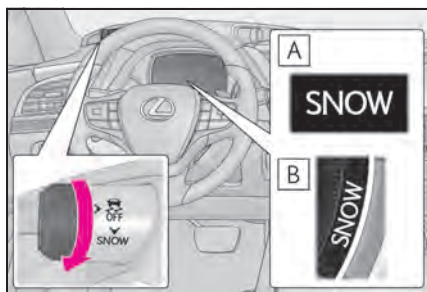

**A** Except F SPORT models

**B** F SPORT models

Turn the snow mode switch backward.

The snow mode indicator illuminates.

Turn the snow mode switch backward again to return to normal mode.

## Selecting shift ranges in the D position

When the “-” paddle shift switch is operated, the shift range switches to a range that enables engine braking force that is suitable to driving conditions. When the “+” paddle shift switch is operated, the shift range switches to a range that is one range higher than the current range.

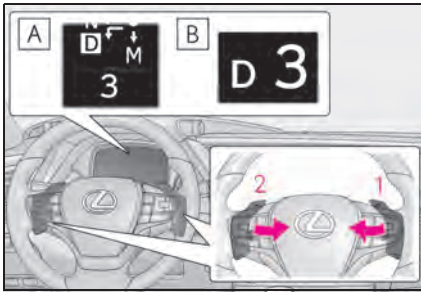

**1** Upshifting

**2** Downshifting

The selected shift range, from D1 to D10, will be displayed on the meter.

**A** Except F SPORT models

**B** F SPORT models

Meter display	Function
D2 - D10	A gear in the range between D1 and the selected shift range is automatically chosen depending on vehicle speed and driving conditions
D1	Setting the shift range at D1

A lower shift range will provide greater engine braking forces than a higher shift range.

## Selecting gears in the M position

To enter M mode, shift the shift position to M. Gears can be selected by operating the paddle shift switches, allowing you to drive in the gear of your choosing.

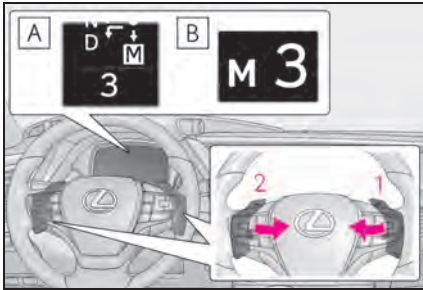

**A** Except F SPORT models

**B** F SPORT models.

**1** Upshifting

**2** Downshifting

The gear changes once every time the paddle shift switch is operated.

The selected gear, from M1 to M10, will be fixed and displayed on the meter

When in the M position, the gear will not change unless the paddle shift switches are operated.

However, even when in the M position, the gears will be automatically changed in the following situations:

- When vehicle speed drops (downshift only).
- When it is necessary to protect the engine or automatic transmission when the engine coolant temperature is low, the automatic transmission fluid temperature is high or low, or other reasons.

Also, the gear will not shift when the vehicle speed is low, even if an upshift operation is performed.

## Turn Signal Lever

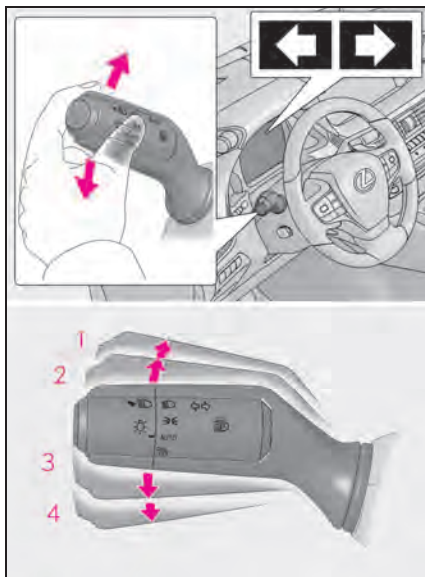

- 1** Right turn
- 2** Lane change to the right (move the lever partway and release it)  
The right hand signals will flash 3 times.
- 3** Lane change to the left (move the lever partway and release it)  
The left hand signals will flash 3 times.
- 4** Left turn

# Parking Brake

The parking brake can be set or released automatically or manually.

## Using the manual mode

The parking brake can be set and released manually.

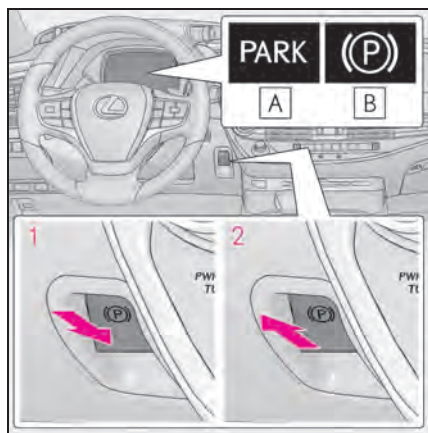

- 1 Push the switch to set the parking brake

The parking brake indicator light will turn on.

Press and hold the parking brake switch if an emergency occurs and it is necessary to operate the parking brake while driving.

- 2 Pull the switch to release the parking brake

- Operate the parking brake switch while depressing the brake pedal.
- Using the parking brake automatic release function, the parking brake can be released by depressing the accelerator pedal. When using this function, slowly depress the accelerator pedal.

Make sure that the parking brake indicator light turn off.

- A** U.S.A.
- B** Canada



## Turns automatic mode on

In automatic mode, the parking brake can be set or released automatically according to the shift lever operation. Also, even in automatic mode, the parking brake can be set or released manually.

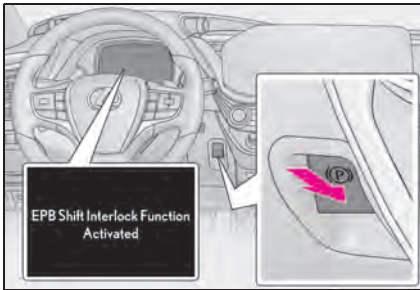

While the vehicle is stopped, press and hold the parking brake switch until a message is shown on the multi-information display.

When the automatic mode is turned on, the parking brake operates as follows.

- When the shift position is shifted from P, the parking brake will be released, and the parking brake indicator light will turn off.
- When the shift position is shifted to P, the parking brake will be set, and the parking brake indicator light will turn on.

Operate the shift lever and P position switch with the vehicle stopped and the brake pedal depressed.

## Turns automatic mode off

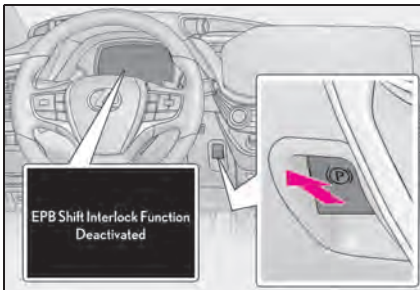

While the vehicle is stopped, pull and hold the parking brake switch until a message is shown on the multi-information display.

## Brake Hold

The brake hold system keeps the brake applied when the shift position is in D, M or N with the system on and the brake pedal has been depressed to stop the vehicle. The system releases the brake when the accelerator pedal is depressed with the shift position in D or M to allow smooth start off.

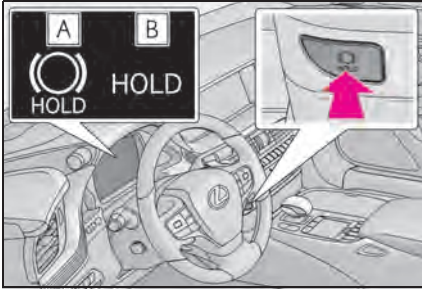

Turns the brake hold system on

The brake hold standby indicator (green)

**A** comes on. While the system is holding the brakes, the brake hold operated indicator (yellow) **B** comes on.

# Multi-information Display

## Display and menu icons

### ■ Display (except F SPORT models)



By selecting menu icons on the multi-information display, a variety of driving-related information can be displayed. The multi-information display can also be used to change display settings and other vehicle settings.

Warning or suggestion/advice pop-up displays are also displayed in certain situations.

### ■ Display (F SPORT models)

#### ▶ Main meter in center position

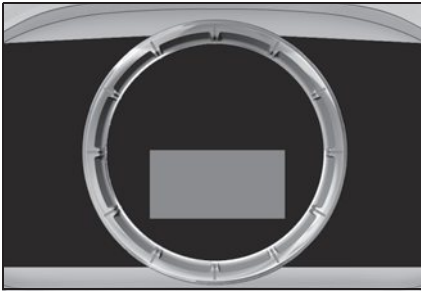

The multi-information display presents the driver with a variety of driving-related information.

Warning or suggestion/advice pop-up displays are also displayed in certain situations.

#### ▶ Main meter moved to the right



By selecting menu icons on the multi-information display, a variety of driving-related information can be displayed. The multi-information display can also be used to change display settings and other vehicle settings.

Warning or suggestion/advice pop-up displays are also displayed in certain situations.

## ■ Menu icons



Driving information display



Navigation system-linked display (if equipped)



Audio system-linked display



Driving support system information display



Warning message display





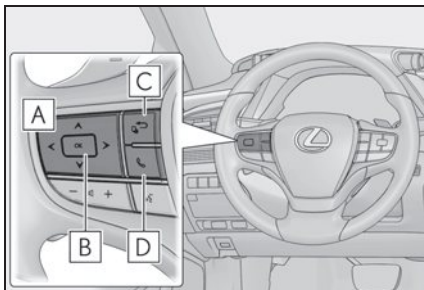

Settings display

If a problem is detected in any of the vehicle's systems, a warning message is shown on the multi-information display.

## Changing the meter display



- A**   : Select menu icons
-   : Change displayed content, scroll up/down the screen and move the cursor up/down
- B** Press: Enter/Set  
Press and hold: Reset
- C** Move the main meter<sup>\*</sup> and return to the previous screen
- D** Call sending/receiving and history display

\*: F SPORT models

## Head-up Display (if equipped)

The head-up display projects a variety of driving-related information and the operating state of the driving support systems on the windshield.

### System components

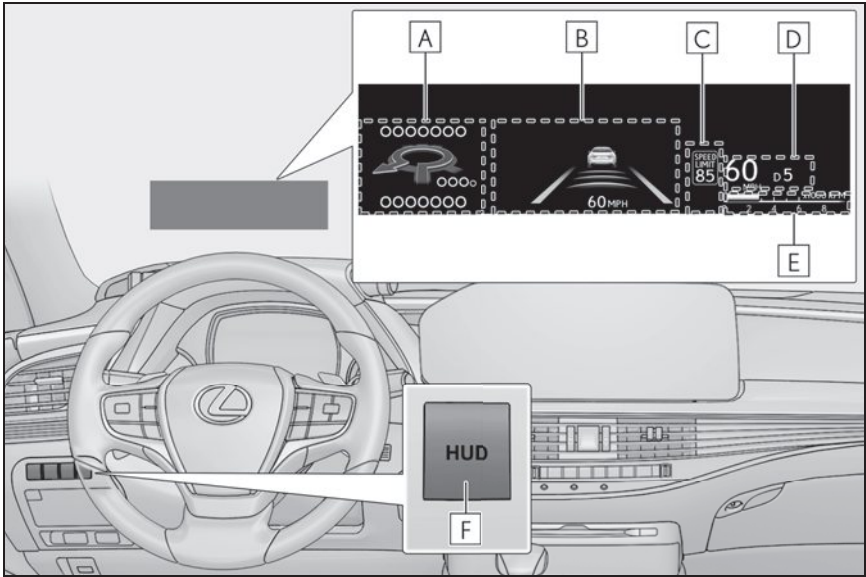

- A** Navigation system-linked display area (if equipped)
- B** Driving support system display area
- C** Speed limit/RSA (Road Sign Assist) display area (if equipped)
- D** Driving information display area
- E** Tachometer/Eco Driving Indicator display area
- F** HUD (Head-up display) switch

## Using the head-up display

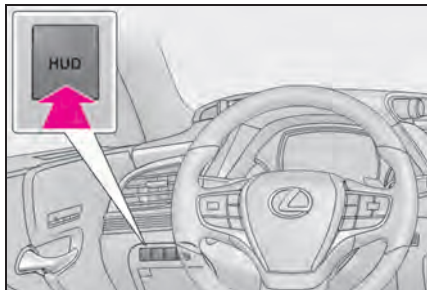





Pressing the switch turns the head-up display on/off.

The head-up display may seem dark or hard to see when viewed through sunglasses, especially polarized sunglasses.  
Adjust the brightness of the head-up display or remove your sunglasses.

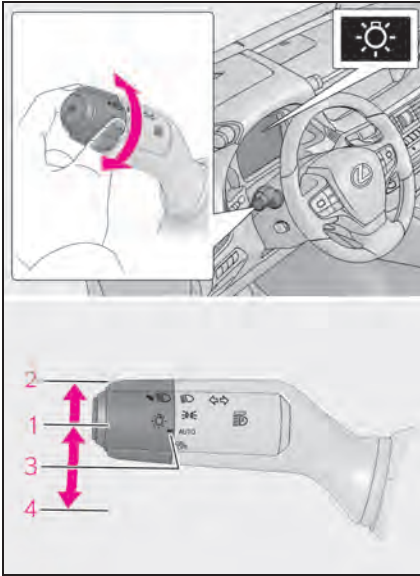
# Headlight Switch



## ► For the U.S.A.

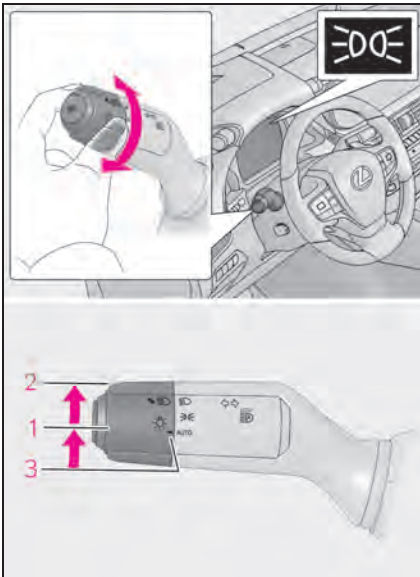

- 1  The side marker, parking, tail, license plate, instrument panel lights, and daytime running lights turn on.
- 2  The headlights and all lights listed above (except daytime running lights) turn on.
- 3 AUTO The headlights, daytime running lights and all the lights listed above turn on and off automatically.
- 4  DRL OFF Off

## ► For Canada



- 1  The side marker, parking, tail, license plate, instrument panel lights, and daytime running lights turn on.
- 2  The headlights and all lights listed above (except daytime running lights) turn on.
- 3 AUTO The headlights, daytime running lights and all the lights listed above turn on and off automatically.

## Turning on the high beam headlights

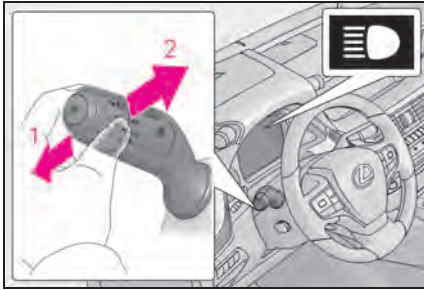

- 1** With the headlights on, push the lever away from you to turn on the high beams.  
Pull the lever toward you to the center position to turn the high beams off.
- 2** Pull the lever toward you and release it to flash the high beams once.  
You can flash the high beams with the headlights on or off.



## AHB (Automatic High Beam)

The Automatic High Beam uses a camera sensor located behind the upper portion of the windshield to assess the brightness of the lights of vehicles ahead, streetlights, etc., and automatically turns the high beams on or off as necessary.

### Activating the Automatic High Beam

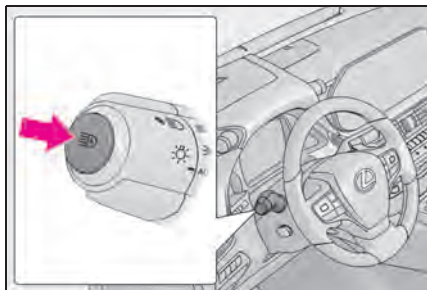

- 1 Press the Automatic High Beam switch.

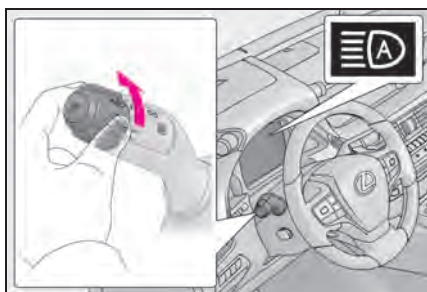

- 2 Turn the headlight switch to the  or AUTO position.

When the headlight switch lever is in the low beam position, the AHB system will be enabled and the AHB indicator will illuminate.

## Turning the high beams on/off manually

### ■ Switching to the high beams

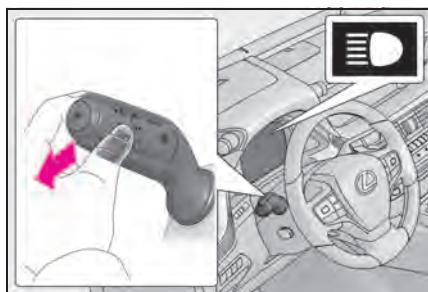

Push the lever away from you.

The AHB indicator will turn off and the high beam indicator will turn on.

Pull the lever to its original position to activate the Automatic High Beam system.

### ■ Switching to the low beams

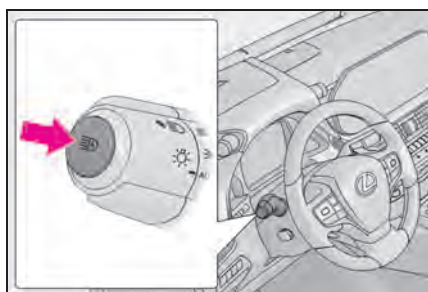

Press the Automatic High Beam switch.

The AHB indicator will turn off.

Press the switch to activate the Automatic High Beam system again.

### ■ Temporarily switching to the low beams

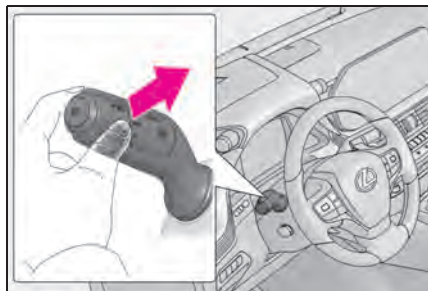

Pull the lever toward you and then return it to its original position.

The high beams are on while the lever is pulled toward you. However, after the lever is returned to its original position, the low beams remain on for a certain period of time. Afterwards, the Automatic High Beam will be activated again.

# Windshield Wipers and Washer

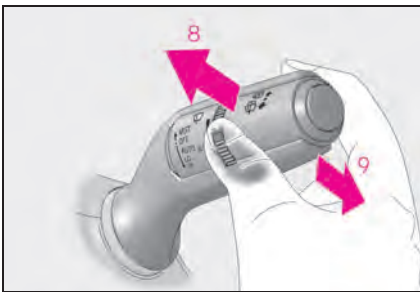
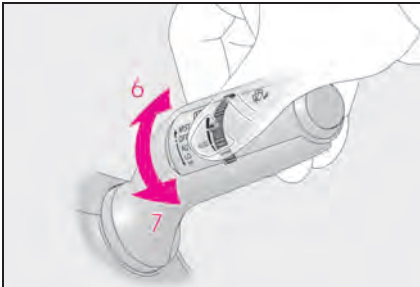
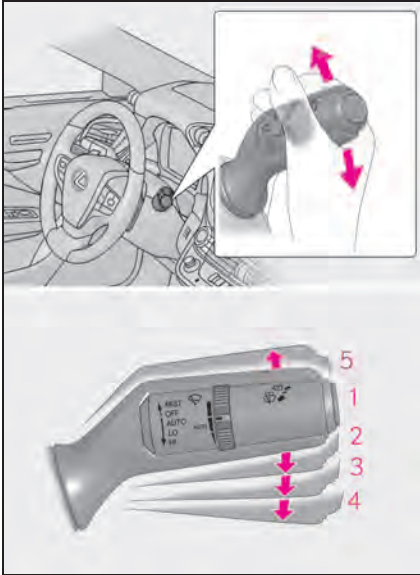

**1** OFF (U.S.A.) or ○ (Canada)  
Off

**2** AUTO Rain-sensing wiper operation

The wipers will operate automatically when the sensor detects falling rain. The system automatically adjusts wiper timing in accordance with rain volume and vehicle speed.

**3** LO (U.S.A.) or ▼ (Canada)  
Low speed wiper operation

**4** HI (U.S.A.) or ▼ (Canada)  
High speed wiper operation

**5** MIST (U.S.A.) or △ (Canada)  
Temporary operation

When AUTO is selected, the sensor sensitivity can be adjusted by turning the switch ring.

**6** Increases the sensitivity

**7** Decreases the sensitivity

**8**  Windshield washer/wiper dual operation

Pulling the lever operates the windshield wipers and washer.

(After operating several times, the wipers operate once more time after a short delay to prevent dripping. However, the dripping prevention does not operate while the vehicle is moving.)

Vehicles with headlight cleaners:

When the engine switch is in IGNITION ON mode and the headlights are on, if the lever is pulled, the headlight cleaners will operate once. After this, the headlight cleaners will operate every 5th time the lever is pulled.

9  \* Rear camera washer operation

Pushing the lever operates the rear camera washer and cleans the rear camera and the camera for the Digital Rearview Mirror.

\*: Vehicles with Digital Rearview Mirror

# Driving Mode Select Switch

The driving modes can be selected to suit driving condition.

## ► Vehicles without Adaptive Variable Suspension System

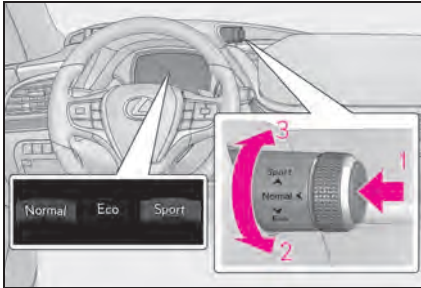

### 1 Normal mode

Provides an optimal balance of fuel economy, quietness, and dynamic performance. Suitable for city driving.

Press the switch to change the driving mode to normal mode when not in normal mode.

### 2 Eco drive mode

Helps the driver accelerate in an eco-friendly manner and improve fuel economy through moderate throttle characteristics and by controlling the operation of the air conditioning system (heating/cooling).

When not in Eco drive mode, if the driving mode select switch is turned backward, the Eco drive mode indicator will come on.

### 3 Sport mode

Controls the transmission and engine to provide quick, powerful acceleration. This mode also changes the steering feel, making it suitable for when agile driving response is desired, such as when driving on roads with many curves.

When not in sport mode, if the driving mode select switch is turned forward, the sport mode indicator will come on.

## ► Vehicles with Adaptive Variable Suspension System

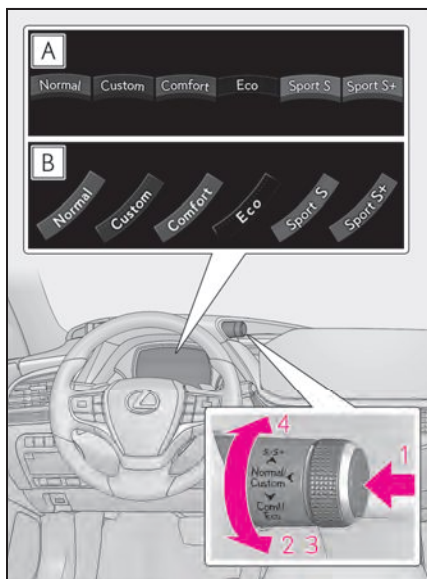

### 1 Normal mode/Custom mode

Normal mode and custom mode are selected by pressing the driving mode select switch. Each time the switch is pressed, the driving mode changes between normal mode and custom mode.

When normal mode is selected, the normal mode indicator comes on.

When custom mode is selected, the custom mode indicator comes on.

Press the switch to change the driving mode to normal mode when not in normal mode.

#### • Normal mode

Provides an optimal balance of fuel economy, quietness, and dynamic performance. Suitable for city driving.

When the shift position is in D, an appropriate gear for sporty driving may automatically be selected according to driver performance and driving conditions.

#### • Custom mode

Allows you to drive with the powertrain, chassis and air conditioning system functions set to your preferred settings. Custom mode settings can only be changed on the drive mode customization display of the Center Display.

### 2 Comfort mode

By controlling the suspension, riding comfort is further enhanced. Suitable for city driving.

When not in comfort mode and the driving mode select switch is turned backward, the comfort mode indicator comes on.

### 3 Eco drive mode

Helps the driver accelerate in an eco-friendly manner and improve fuel economy through moderate throttle characteristics and by controlling the operation of the air conditioning system (heating/cooling).

When in comfort mode, if the driving mode select switch is turned backward, the Eco drive mode indicator comes on.

### 4 Sport mode

- Sport S mode

Controls the transmission and engine to provide quick, powerful acceleration. This mode is suitable for when agile driving response is desired, such as when driving on roads with many curves.

When not in Sport S mode, if the driving mode select switch is turned forward, the Sport S mode indicator comes on.

- Sport S+ mode

Helps to ensure steering performance and driving stability by simultaneously controlling the steering and suspension in addition to the transmission and engine. Suitable for sportier driving.

When in Sport S mode, if the driving mode select switch is turned forward, the Sport S+ mode indicator comes on.

**A** Except F SPORT models

**B** F SPORT models

# Fuel Consumption Information

Fuel consumption information can be displayed on the Center Display.

## Current screen

### ■ Display procedure

- 1 Select  on the main menu.
- 2 Select "Trip information".
- 3 Select "Current".

### ■ Display

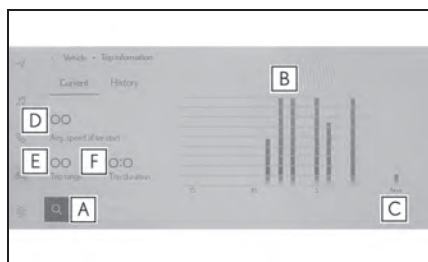

- A** Resetting the consumption data
- B** Fuel consumption in the past 15 minutes
- C** Current fuel consumption
- D** Average vehicle speed since the engine was started.
- E** Trip range
- F** Elapsed time since the engine was started.



## History screen

### ■ Display procedure

- 1 Select  on the main menu.
- 2 Select "Trip information".
- 3 Select "History".

### ■ Display

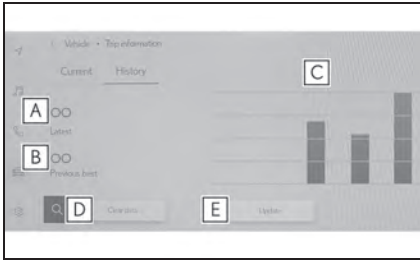

- A** Latest fuel consumption
- B** Best recorded fuel consumption
- C** Previous fuel consumption record
- D** Resetting the history data
- E** Updating the latest fuel consumption data

# Basic Operation of Multimedia System

## Map scrolling operation

The map can be moved and a touched point can be set as the center of the map screen.

### ■ Flick/drag operation



The map screen can be moved by touching, dragging or flicking it.

Touch "Recenter" to return to the center of the map to the current position.

### ■ Touch and hold operation

If a desired point on the map screen is touched and held, the full route map screen to the selected point will be displayed.



1 Touch and hold the desired point.

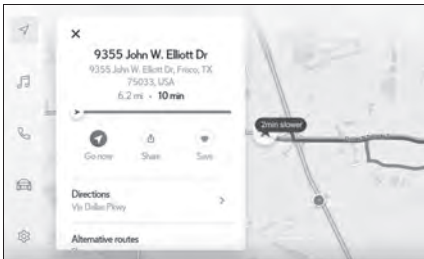

2 Full route map screen will be displayed for the selected point.

# Navigation

The navigation system indicates your present position and assists in locating a desired destination.

## Destination search screen

### ■ Searching for a destination using the keyboard

A destination can be searched for by entering keywords.

**1** Touch  or  on the map screen.

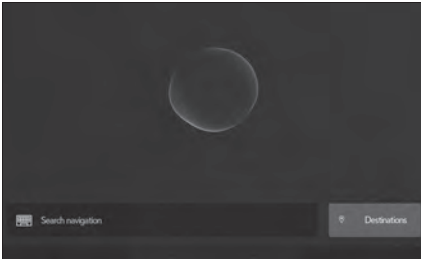

**2** Touch "Search navigation".



**3** Enter characters using the keyboard.

**4** Touch "Go".

**5** Touch the desired item from the list.

## ■ Searching for a destination by category

A destination can be searched for from a list of categories.

1 Touch  or  on the map screen.

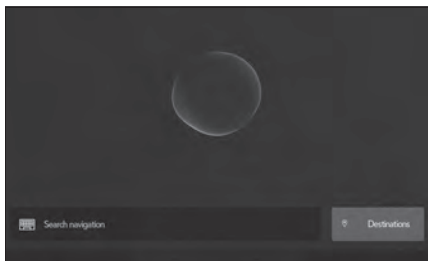

2 Touch “Destinations”.

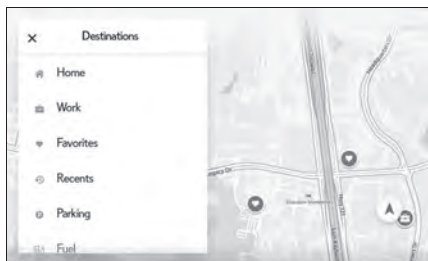

3 Touch the desired search method.

“Home”: Touch to set the registered home as the destination. A point must be registered as home before using this function.\*

“Work”: Touch to set the registered workplace as the destination. A point must be registered as a workplace before using this function.\*

“Favorites”: Touch to set a registered favorite as the destination. A point must be registered as a favorite before using this function.

“Recents”: Touch to set a destination from the destination history as the destination.

“Sent to car”: Send to car enables customer to send a destination or POI to the vehicle from Lexus app.

“Parking”: Touch to search for a nearby parking lot to set as a destination.

“Fuel/Charging”: Touch to search for a fuel station/charging facility to set as a destination.

“Food”: Touch to search for a restaurant to set as a destination.

“Hospitals”: Touch to search for a hospital to set as a destination.



When setting a business as a destination, if your estimated time of arrival is outside of business hours or near closing time, a notification asking to confirm the destination will be displayed.

\*: Home and Work must be added via Lexus app.

4 Touch the desired destination from the list.

### ► Editing the favorites list

The favorites list can be edited.

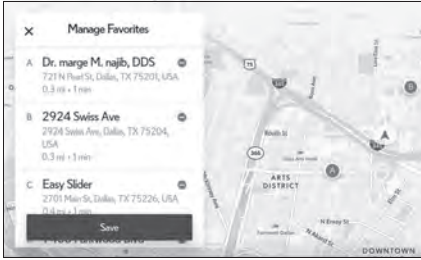

- 1 Touch  or  on the map screen.
- 2 Touch “Destinations”.
- 3 Touch “Favorites”.



5 Touch “Save”.

### ► Editing the destination history

The destination history can be edited.

- 1 Touch  or  on the map screen.
- 2 Touch “Destinations”.
- 3 Touch “Recents”.

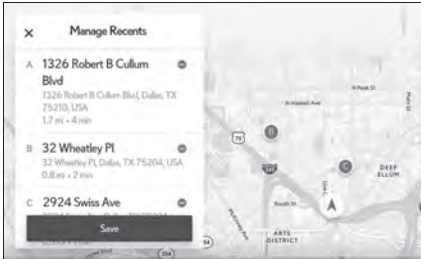

5 Touch “Save”.

4 Touch .

Touch  to delete a favorite.

The favorites list editing screen will be displayed.

4 Touch .

The destination history editing screen will be displayed.

Touch  to delete a destination history item.

## ■ Searching for a destination using voice controls

**1** Touch  or  on the map screen.

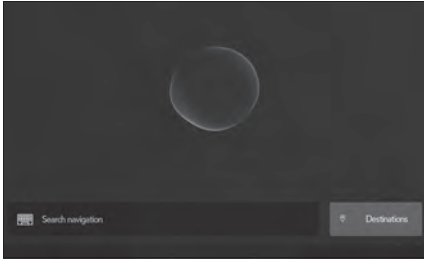

**2** Say the keyword you wish to use for the search.

**3** Touch the desired item from the list.

# Connecting a Smartphone or Communication Device

## Registering a Bluetooth® device from the multimedia system

A cellular phone or portable device must be registered in order to use hands-free calling or Bluetooth® audio. Once registration is complete, Bluetooth® will automatically be connected each time the multimedia system is started.

When Apple CarPlay/Android Auto is connected via USB, the device will be registered automatically.

When no Bluetooth® devices are connected, the registration screen can be displayed by pressing and holding the  switch on the steering.

**1** Touch  from the main menu.

**2** Touch “Bluetooth & Devices” on the submenu.

If no device is registered, proceed to Procedure 4.

**3** Touch “Add another device”.

While a device is connected to the multimedia system, the confirmation screen for disconnecting the device may be displayed. Disconnect the device to perform registration.

**4** Touch “Search for devices”.

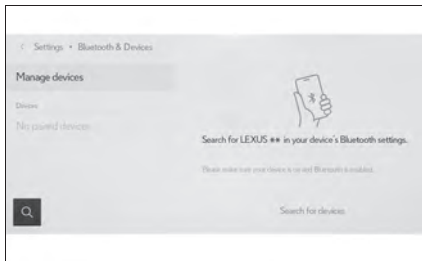

**5** Touch the device to register from the main area.

- The Bluetooth® address may be displayed instead of the device name.
- Certain models of Bluetooth® devices may not be displayed in the device list, unless a certain screen is displayed on the Bluetooth® device. Refer to the Bluetooth® device's instruction manual for details.

- 6 Check that the displayed PIN code matches the PIN code displayed on the Bluetooth® device, and then touch “OK”.
  - Some Bluetooth® devices may need to be operated to complete registration.
  - You may be prompted to install the Lexus Application on your phone. Please follow the displayed instruction.
  - Primary device settings may be displayed. Perform the operation according to the screen guidance.
  - The Apple CarPlay or Android Auto settings may be displayed. The Apple CarPlay or Android Auto screen will be displayed if the use of either is enabled.
  - A message indicating that connection is complete is displayed, and the name of the registered Bluetooth® device is displayed in the submenu.
  - If an operation failed screen is displayed, follow the operation instructions on the screen.

### ■ Registering from a Bluetooth® device

If the Bluetooth® device cannot be found by searching with the multimedia system, register by searching for the multimedia system from the Bluetooth® device.

- 1 Touch  from the main menu.
- 2 Touch “Bluetooth & Devices” on the submenu.  
If no device is registered, proceed to Procedure 4.
- 3 Touch “Add another device”.

While a device is connected to the multimedia system, the confirmation screen for disconnecting the device may be displayed. Disconnect the device to perform registration.

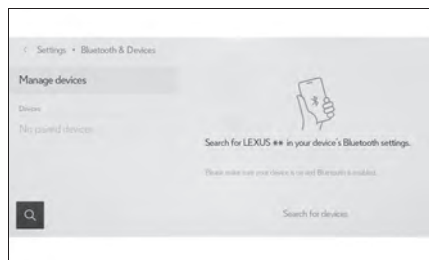

- 4 Register the multimedia system from the Bluetooth® device to be used.
  - Perform the operation according to the operating procedure of the Bluetooth® device.
  - Be sure to display this Bluetooth® connection screen before performing registration on the Bluetooth® device.



**5** Check that the displayed PIN code matches the PIN code displayed on the Bluetooth® device, and then touch “OK”.

- Some Bluetooth® devices may need to be operated to complete registration.
- Registration guidance for the user profile may be displayed. Perform the operation according to the screen guidance.
- Primary device settings may be displayed. Perform the operation according to the screen guidance.
- The Apple CarPlay or Android Auto settings may be displayed. The Apple CarPlay or Android Auto screen will be displayed if the use of either is enabled.
- A message indicating that connection is complete is displayed, and the name of the registered Bluetooth® device is displayed in the submenu.
- If an operation failed screen is displayed, follow the operation instructions on the screen.

### ■ Operating with the steering switches

Some hands-free call functions can be operated from the steering switches, such as receiving or making calls. The steering switch functions change depending on the status of the multimedia system.

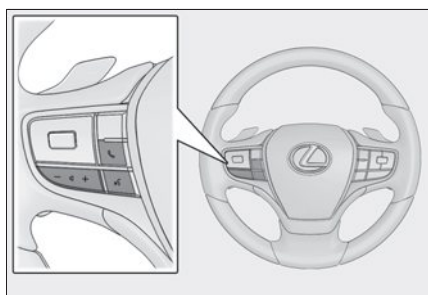

- Operate the switches as necessary.  
“+” switch

Increases the ringtone volume or receiver volume.

Press and hold to adjust continuously.

- “-” switch

Decreases the ringtone volume or receiver volume.

Press and hold to adjust continuously.





switch

Calls can be made using voice command.

To end voice command, press and hold the talk switch.



switch

- When the multimedia system shows a screen other than the phone screen, displays the history screen.
- When the multimedia system shows the phone screen with  displayed, makes a call.
- When the multimedia system shows the phone screen with  not displayed, displays the history screen.
- While making a call or during a call, ends the call.
- While receiving a call or during call waiting, answers the call.

## Making calls from call history

Calls can be made to phone numbers that have been recorded in the call history as outgoing or incoming calls.

- 1 Touch  from the main menu.
- 2 Touch “Recents” on the submenu.

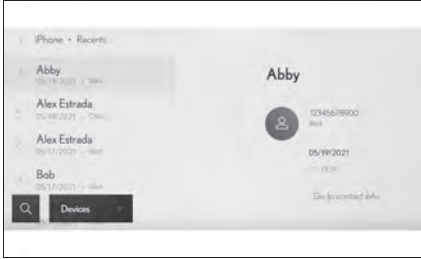

- 3 Select the contact.  
For phone numbers that are not registered in the contact, the phone number will be displayed as it is.
- 4 Touch the desired phone number.

## Making calls from the favorites list

Make a call from your favorites list.

- 1 Touch  from the main menu.
- 2 Touch “Favorites” on the submenu.

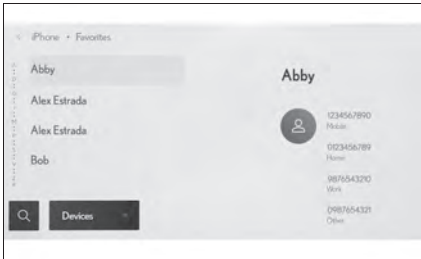

- 3 Select the person you want to call from your favorites list.
- 4 Touch the desired phone number.

## Making calls from contacts

Make a call from the contacts registered on the multimedia system.

- 1 Touch  from the main menu.
- 2 Touch “Contacts” on the submenu.
- 3 Select a contact.

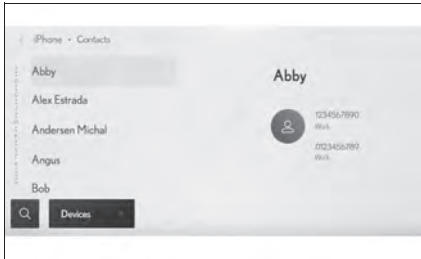



- 4 Touch the desired phone number.

## Answering calls

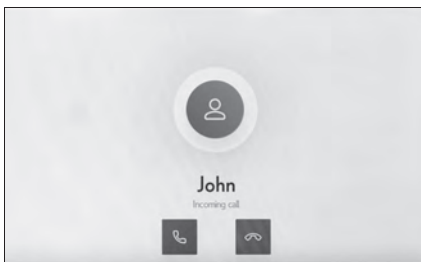
When there is an incoming call, the incoming call sounds and the incoming call screen or incoming call notification is displayed.



- Answer the call by doing one of the following.
  - Touch .
  - Press the  switch on the steering.

## Making calls from the message function

Hands-free calls can be made using the message function.

- Touch the blue number to make a call.  
Consecutive numbers may be recognized as phone numbers. In addition, some phone numbers, such as phone numbers from other countries, may not be recognized.

# Basic Operation of Audio System

## Changing the audio source

Source can be changed to radio, USB, etc.

- 1 Touch  from the main menu.
- 2 Touch "Sources".



- 3 Touch the source you wish to select.

## Listening to the radio

Switch to your preferred frequency or service and listen to the radio.

- 1 Touch  from the main menu.
- 2 Touch "Sources".
- 3 Touch "Radio".
- 4 Select the station selection method or service as necessary.

"Favorites": Select a broadcasting station from those registered as favorites.

"Tune": Select the broadcasting station by entering a frequency with the numeric keypad.

"FM Radio": Switches to FM mode. The FM station list, the 3 most recently listened stations, and the receivable FM broadcasting stations are displayed.

"AM Radio": Switches to AM mode. The AM station list, the 3 most recently listened stations, and the receivable AM broadcasting stations are displayed.

"SiriusXM": Switches to SiriusXM Radio mode. Displays "For You" and contents/Super Categories/"All channels"/"Listening History". (This function is not available in some countries or areas)



- 5 Select the broadcasting station from the station list or genre.

- 6 Operate the radio that is being received as necessary.
- Operating AM/FM from the screen



“Ch”: Touch **-** or **+** to search for the receivable broadcasting stations. Touch and hold to jump to the next frequency with available radio signal. When released, the broadcasting station closest to that position with the best reception sensitivity is selected automatically.

“Scan”: SEEK UP and output the audio of the detected station for 10 sec. This is repeated.

  : Displayed when Multicast CH is supported in FM mode. Touch to display the SPS channel list. The mode can be changed to the displayed SPS channel list.

 : Registers the currently received broadcasting station in favorites. When registered, touch to cancel.

Preset switches of submenu: Receive the registered broadcasting stations.

- Operating SiriusXM Radio from the screen  
(This function is not made available in some countries or areas)

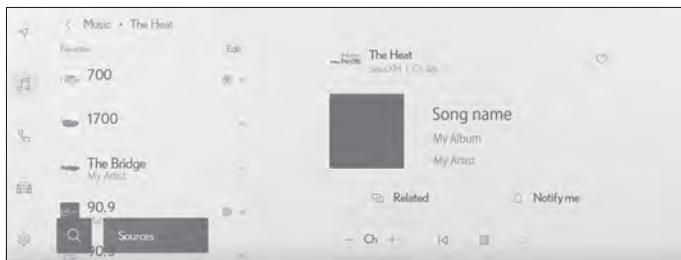

“Ch”: Touch **-** or **+** to search for the receivable channels. Touch and hold to switch channels. When released, the current channel is received.

**⏮ / ⏭** : Fast rewind or fast forward the radio cache. Touch and hold to jump to the start or end of the buffer.

**⏸** : Pause the radio cache.

**▶** : Play the radio cache.

“Related”: Displays related channels on the Related Channels drawer menu.

“Notify me”: Select an artist or song, or both an artist and song, to receive a notification when the corresponding broadcast starts. (When receiving a regular channel) Select a sports team to receive a notification when the corresponding broadcast starts. (When receiving a sport channel)

**♥** : Registers the currently received channel in favorites. When registered, touch to cancel.

Preset buttons of sub menu: Receive the registered channels.

- Operating with the steering switches

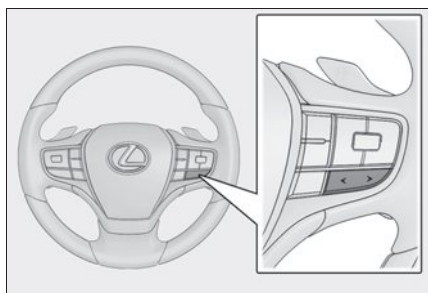

“</>” switches

- AM/FM

Switches the frequencies or broadcasting stations registered in the preset switches in order.

Push and hold to switch frequencies. When released, the broadcasting station closest to that position with the best reception sensitivity is selected automatically.

- SiriusXM Radio

Switches the channels registered in the preset switches in order.

Push and hold to switch channels. When released, the channel closest to that position with the best reception sensitivity is selected automatically.

## Playing iPod/iPhone

Play back music files on an iPod/iPhone connected to the USB port. When an iPod/iPhone is connected, a button with the device's name is displayed on the source selection screen. This may not be displayed for some devices.

Connect an iPod or iPhone.

- 1 Touch  from the main menu.
  - 2 Touch "Sources".
  - 3 Touch the device name or "USB".
  - 4 Operate the iPod or iPhone that is playing as necessary.
- Perform operations from the screen

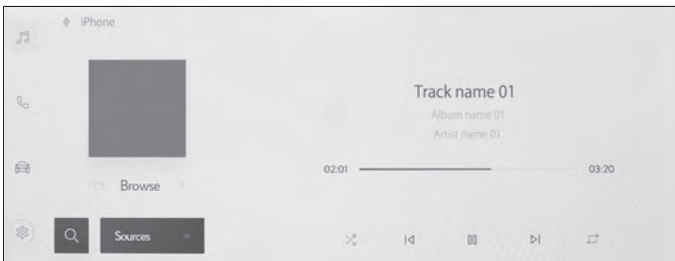



 : Performs shuffle playback. Each touch switches the shuffle setting.\*

 : Plays the currently playing track from the beginning. When at the start of the track, the previous track will play from the beginning.

Touch and hold to fast rewind. Release to start playback from that position.

 : Pauses playback.

 : Plays.

 : Switches the tracks. Touch and hold to fast forward. Release to start playback from that position.

: Performs repeat playback. Each touch during repeat playback switches the repeat setting.\*

“Browse”: Displays the playback mode in the submenu. Tracks can be selected from a list sorted by artist, album, song, playlist, genre, Podcast, composer, audiobook, or radio. “Shuffle play” is displayed when playing a track selected from the list. Touch this to return to the playback screen and perform shuffle playback.

\*: The order in which shuffle or repeat settings switch depends on the connected device.

● Operating with the steering switches

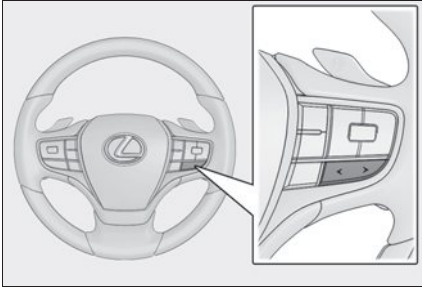

“</>” switches

Switches the tracks.

Hold to fast rewind or fast forward. Release to start playback from that position.



## Connecting the USB Port

Connect a device such as smartphone or portable player.

- Connect the USB cable to the port.

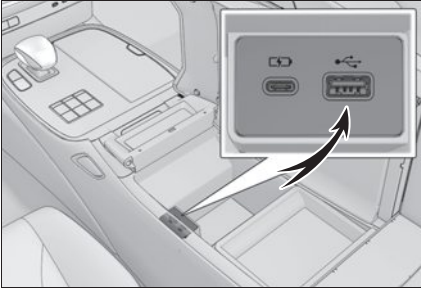

When connecting a USB flash drive, connect it directly to the USB port.

## Lexus Climate Concierge

The seat heaters, seat ventilators and heated steering wheel are each automatically controlled according to the set temperature of the air conditioning system, the outside and cabin temperature, etc. Lexus Climate Concierge allows a comfortable condition to be maintained without adjusting each system.

### Turning on Lexus Climate Concierge

- 1 Select  in the main menu on the Center Display.
- 2 Select "Climate".
- 3 Select "Options".
- 4 Select "Climate concierge".
- 5 Turn the automatic mode switch on.

## Front Automatic Air Conditioning System

Air outlets and fan speed are automatically adjusted according to the temperature setting.

### Control panel

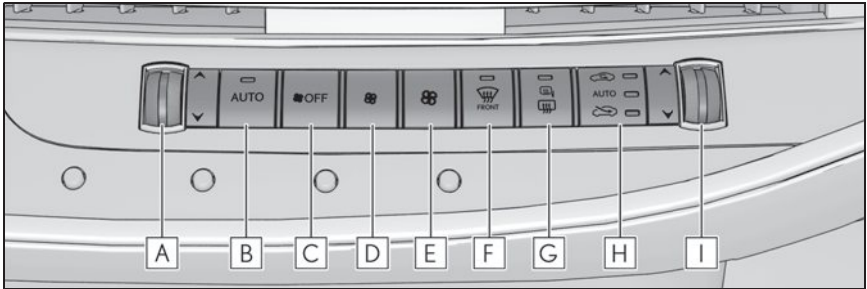

- A** Left-hand side temperature control switch  
Operate the temperature control switch upwards to increase the temperature and downwards to decrease the temperature.
- B** Automatic mode switch
- C** Off switch
- D** Fan speed decreases switch
- E** Fan speed increases switch
- F** Windshield defogger switch
- G** Rear window defogger and outside rear view mirror defoggers switch
- H** Outside/recirculated air mode switch
- I** Right-hand side temperature control switch  
Operate the temperature control switch upwards to increase the temperature and downwards to decrease the temperature.

## Air conditioning control screen

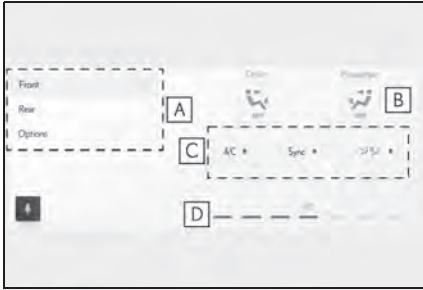

### Main control screen

- 1 Select  in the main menu on the Center Display.
- 2 Select "Climate".
- 3 Select "Front".



- A** Sub menu
- B** Select the air flow mode
- C** Turn the function on/off
- D** Fan speed level display

### Option control screen

The functions can be switched  (on) and  (off), or the function settings can be selected from multiple options.

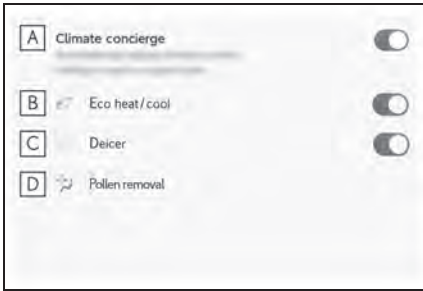

- A** Set Lexus Climate Concierge
- B** Set eco air conditioning mode
- C** Prevent ice from building up on the windshield and wiper blades (Windshield wiper de-icer) (if equipped)
- D** Removing pollen from the air (Micro dust and pollen filter)

## Using automatic mode

- 1 Press the automatic mode switch.
- 2 Press the outside/recirculated air mode switch to switch to automatic air intake mode.
- 3 Adjust the temperature setting.
- 4 To stop the operation, press the off switch.

## Rear Automatic Air Conditioning System (if equipped)

The air outlets and fan speed are automatically adjusted according to the temperature setting.

The rear air conditioning system can be operated using the Center Display or Rear Multi Operation Panel.

### Rear air conditioning control screen

#### ■ Center Display

- 1 Select  in the main menu on the Center Display.
- 2 Select "Climate".
- 3 Select "Rear".

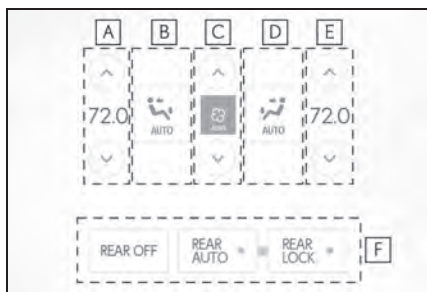

- A** Adjust the left side rear seat temperature setting
- B** Select the left side rear seat air flow mode
- C** Adjust the rear seats fan speed setting
- D** Select the right side rear seat air flow mode
- E** Adjust the right side rear seat temperature setting
- F** Functions on/off

### Using automatic mode

#### ► Center Display

- 1 Select "REAR AUTO" on the rear air conditioning control screen.
- 2 To stop the operation, select "REAR OFF" on the rear air conditioning control screen.

## Starting Voice Control

Voice control can be started by any of the following operations:

### ■ Press the talk switch

Press the  switch (talk switch) on the steering.

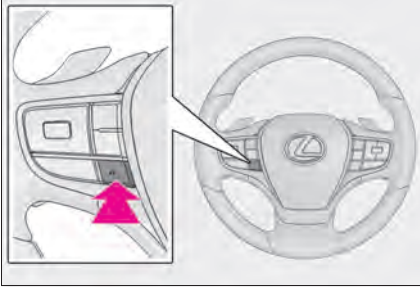

### ■ Say the wake word

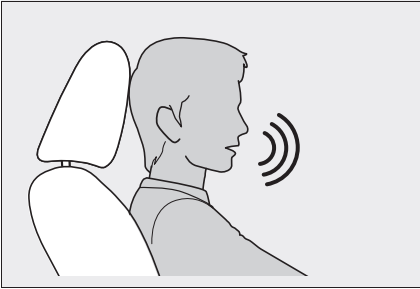

Say “Hey Lexus”

- The wake word can be turned on or off.
- The wake word can be used and then immediately issue a voice command.

Example: “Hey Lexus, take me to an Italian restaurant.”

### ■ Touch the microphone button



Touch  or  on the screen.

## Function list

The following tables list frequently used commands for each function category.

- The functions available may vary according to the system installed.
- Items with “Subscription” will require Intelligent Assistant functionality.

### ■ Common

Action	Example voice command	Subscription
Shows list of general commands	“Help”	No
Stops the current conversation and re-starts at the beginning	“Start over”	No
Cancels the Intelligent Assistant system	“Cancel”	No

### ■ Navigation

Intelligent Assistant system enables navigation voice search. This allows you with variety of features such as searching a point of interest (POI), navigate to an address as well as discovering new POIs.

Function	Example voice command	Subscription
Destination search	“Take me to <location category/business name>” “Take me to an Italian restaurant” “Take me to <address>” “Take me to 6565 Headquarters drive Plano TX” “Take me home” “Take me to work”	Yes
Map control	“Map zoom in” “Map zoom out”	Yes
Route information	“Cancel trip”	Yes
Telematics	“Call destination assist”	No



## ■ Multimedia control

Allows you to engage in a dialog with the Intelligent Assistant to complete various multimedia tasks via voice input.

Function	Example voice command	Subscription
Radio	"Tune to 99.5 FM" "Tune to Rock on FM" "Tune to channel 2 on SiriusXM"	No
Media	"Mute audio" "Next" "Previous"	No
Media Streaming	"Play <artist/album/song/genre/playlist>" "Play Frank Sinatra"	Yes

## ■ Hands-free phone operation

Allows you to engage in a dialog with the Intelligent Assistant to complete various tasks via voice input, such as making a phone call to a contact, or calling destination assist.

Function	Example voice command	Subscription
Phone call	"Call John Smith" "Dial 0123456789" "Call back" "Redial"	No
Message	"Send message to John Smith" "Read message"	No

## ■ Screen display switching

Allows you to easily change to various function screen by voice.

Function	Example voice command	Subscription
Navigation	"Show map"	Yes
Phone	"Show recent calls"	No
Multimedia	"Show the FM station list"	No
Settings	"Show display settings"	No

## ■ Vehicle device control

Allows you to easily change a vehicle setting or activate a function by voice.

Function	Example voice command	Subscription
Climate	"Turn on the air conditioner" "Set the temperature to 70 degrees" "Turn the fan speed up"	No

## ■ Notifications

Offers notifications based on user preferences, vehicle geolocation and learned behavior. Each service can be set to On/Off from the Lexus app.

Function	Detail	Subscription
POI suggestion (Navigation)	Parking suggestions near destination	Yes
Low fuel reminder (Navigation)	Automatically notifies user of low fuel level. If applicable, provides POI list nearby (ahead) or along route and allows user to select and navigate by touch.	Yes

# Garage Door Opener

The garage door opener can be programmed using the HomeLink<sup>®</sup> to operate garage doors, gates, entry doors, door locks, home lighting systems, security systems, and other devices.

## System components

The HomeLink<sup>®</sup> wireless control system in your vehicle has 3 buttons which can be programmed to operate 3 different devices. Refer to the programming methods on the following pages to determine the method which is appropriate for the device.

### ► Vehicles with auto anti-glare inside rear view mirror

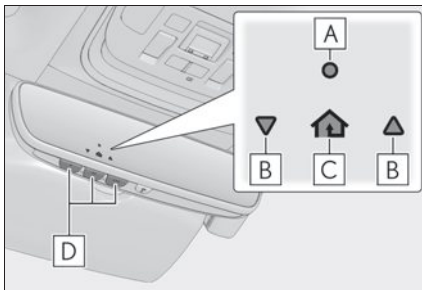

- A** HomeLink<sup>®</sup> indicator light
- B** Garage door operation indicators
- C** HomeLink<sup>®</sup> icon

Illuminates while HomeLink<sup>®</sup> is operating.

- D** Buttons

### ► Vehicles with Digital Rearview Mirror

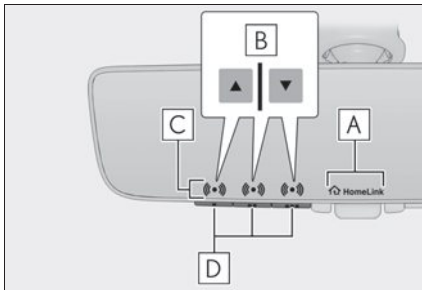

- A** HomeLink<sup>®</sup> logo

Appears while HomeLink<sup>®</sup> is operating. When the menu button (→P.22) is pressed, the logo disappears even while the HomeLink<sup>®</sup> is operating.

- B** Garage door operation indicators
- C** HomeLink<sup>®</sup> indicator light

Illuminates above each button selected.

- D** Buttons

## ■ Before programming HomeLink<sup>®</sup>

- During programming, it is possible that garage doors, gates, or other devices may operate. For this reason, make sure that people and objects are clear of the garage door or other devices to prevent injury or other potential harm.
- It is recommended that a new battery be placed in the remote control transmitter for more accurate programming.
- Garage door opener motors manufactured after 1995 may be equipped with rolling code protection. If this is the case, you may need a stepladder or other sturdy, safe device to reach the “Learn” or “Smart” button on the garage door opener motor.

## ■ HomeLink® programming procedure

The programming procedures can also be found at the following URL.

Website: [www.homelink.com/lexus](http://www.homelink.com/lexus)



For support, contact customer support at the following.

Help Line: 1-800-355-3515

### ■ Programming HomeLink®

Steps **1** through **3** must be performed within 60 seconds, otherwise the HomeLink® indicator light will stop flashing and programming will not be successfully completed.

- 1** Press and release the HomeLink® button you want to program and check that the HomeLink® indicator light flashes (orange).
- 2** Point the remote control transmitter for the device at the rear view mirror, 1 to 3 in. (25 to 75 mm) from the HomeLink® buttons.

Keep the HomeLink® indicator light in view while programming.

#### ▶ Vehicles with auto anti-glare inside rear view mirror

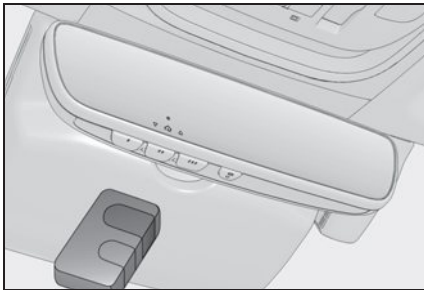

#### ▶ Vehicles with Digital Rearview Mirror

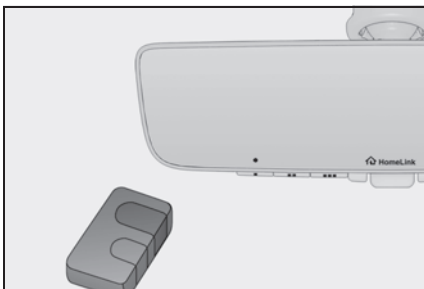

### 3 Program a device.

#### ► Vehicles with auto anti-glare inside rear view mirror

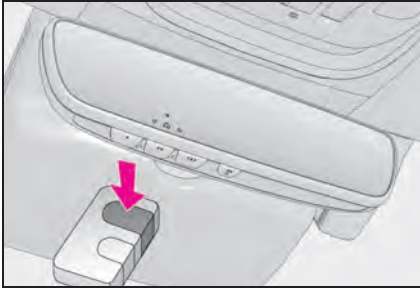

#### ► Vehicles with Digital Rearview Mirror

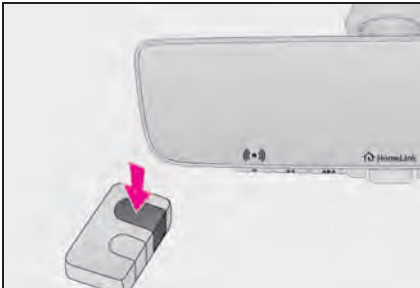

#### ► Programming a device other than an entry gate (for U.S.A. owners)

Press and hold the remote control transmitter button until the HomeLink<sup>®</sup> indicator light changes from slowly flashing orange to rapidly flashing green (rolling code) or continuously lit green (fixed code), then release the button.

#### ► Programming an entry gate (for U.S.A. owners)/Programming a device in the Canadian market

Press and release the remote control transmitter button at 2 second intervals, repeatedly, until the HomeLink<sup>®</sup> indicator light changes from slowly flashing (orange) to rapidly flashing (green) (rolling code) or continuously lit (green) (fixed code).

### 4 Test the HomeLink<sup>®</sup> operation by pressing the newly programmed button and observing the indicator light:

- HomeLink<sup>®</sup> indicator light illuminates: Programming of a fixed code device has completed. The garage door or other device should operate when a HomeLink<sup>®</sup> button is pressed and released.
- HomeLink<sup>®</sup> indicator light flashes rapidly: The garage door opener motor or other device is equipped with a rolling code. To complete programming, firmly press and hold the HomeLink<sup>®</sup> button for 2 seconds then release it.
- If the garage door or other device does not operate, proceed to "Programming a rolling code system".

### 5 Repeat the steps above to program another device for any of the remaining HomeLink<sup>®</sup> buttons.

## ■ Programming a rolling code system

Two or more people may be necessary to complete rolling code programming.

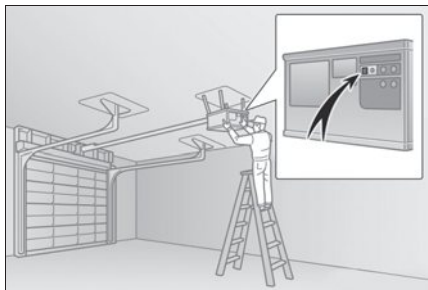

- 1 Locate the “Learn” or “Smart” button on the garage door opener motor in the garage.

This button can usually be found where the hanging antenna wire is attached to the unit. The name and color of the button may vary by manufacturer. Refer to the owner’s manual supplied with the garage door opener motor for details.

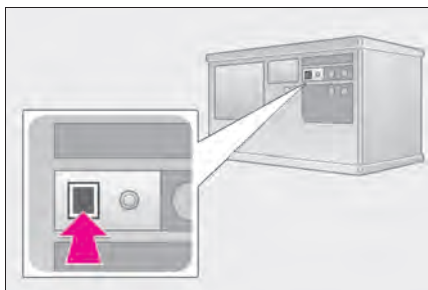

- 2 Press and release the “Learn” or “Smart” button.

Perform **3** within 30 seconds after performing **2**.

- 3 Press and hold the desired HomeLink<sup>®</sup> button (inside the vehicle) for 2 seconds and release it. Repeat this sequence (press/hold/release) up to 3 times to complete programming.

If the garage door opener motor operates when the HomeLink<sup>®</sup> button is pressed, the garage door opener motor recognizes the HomeLink<sup>®</sup> signal.

### ► Vehicles with auto anti-glare inside rear view mirror



## ► Vehicles with Digital Rearview Mirror



### ■ Enabling 2-way communication with a garage door (only available for compatible devices)

When enabled, 2-way communication allows you to check the status of the opening and closing of a garage door through indicators in your vehicle.

2-way communication is only available if the garage door opener motor used is a compatible device. (To check device compatibility, refer to [www.homelink.com](http://www.homelink.com).)

- 1 Within 5 seconds after programming the garage door opener has been completed, if the garage door opener motor is trained to HomeLink<sup>®</sup>, both garage door operation indicators will flash rapidly (green) and the light on the garage door opener motor will blink twice, indicating that 2-way communication is enabled.

If the indicators do not flash, perform **2** and **3** within the first 10 presses of the HomeLink<sup>®</sup> button after programming has been completed.

- 2 Press a programmed HomeLink<sup>®</sup> button to operate a garage door.
- 3 Within 1 minute of pressing the HomeLink<sup>®</sup> button, after the garage door operation has stopped, press the “Learn” or “Smart” button on the garage door opener motor. Within 5 seconds of the establishment of 2-way communication with the garage door opener, both garage door operation indicators in the vehicle will flash rapidly (green) and the light on the garage door opener motor will blink twice, indicating that 2-way communication is enabled.

### ■ Reprogramming a single HomeLink<sup>®</sup> button

When the following procedure is performed, buttons which already have devices registered to them can be overwritten:

- 1 Press and hold the desired HomeLink<sup>®</sup> button.
- 2 When the HomeLink<sup>®</sup> indicator starts flashing orange, release the HomeLink<sup>®</sup> button and perform “Programming HomeLink<sup>®</sup>” **1** (it takes 20 seconds for the HomeLink<sup>®</sup> indicator to start flashing).

## Operating HomeLink<sup>®</sup>

Press the appropriate HomeLink<sup>®</sup> button. The HomeLink<sup>®</sup> indicator light should turn on.

## Safety Connect (if equipped)

Safety Connect is a subscription-based telematics service that uses Global Positioning System (GPS) data and embedded cellular technology to provide safety and security features to subscribers. Safety Connect is supported by Lexus' designated response center, which operates 24 hours per day, 7 days per week.

Safety Connect service is available by subscription on select, telematics hardware-equipped vehicles.

### System components

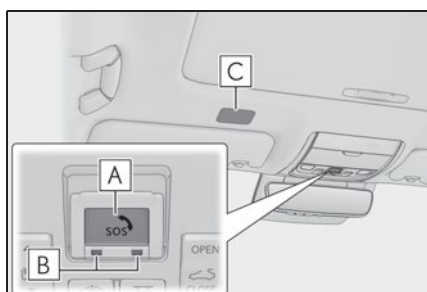

- A** "SOS" button
- B** LED light indicators
- C** Microphone

### Services

Subscribers have the following Safety Connect services available:

- Automatic Collision Notification

In case of either airbag deployment or severe rear-end collision, the system is designed to automatically call the response center. The responding agent receives the vehicle's location and attempts to speak with the vehicle occupants to assess the level of emergency. If the occupants are unable to communicate, the agent automatically treats the call as an emergency, contacts the nearest emergency services provider to describe the situation, and requests that assistance be sent to the location.



- **Stolen Vehicle Location**

If your vehicle is stolen, Safety Connect can work with local authorities to assist them in locating and recovering the vehicle. After filing a police report, call the Safety Connect response center at 1-800-25-LEXUS (1-800-255-3987) in the United States, 1-877-539-8777 in Puerto Rico or 1-800-265-3987 in Canada, and follow the prompts for Safety Connect to initiate this service.

In addition to assisting law enforcement with recovery of a stolen vehicle, Safety-Connect-equipped vehicle location data may, under certain circumstances, be shared with third parties to locate your vehicle. Further information is available at [Lexus.com](http://Lexus.com).

- **Emergency Assistance Button (“SOS”)**

In the event of an emergency on the road, push the “SOS” button to reach the Safety Connect response center. The answering agent will determine your vehicle’s location, assess the emergency, and dispatch the necessary assistance required.

If you accidentally press the “SOS” button, tell the response-center agent that you are not experiencing an emergency.

- **Enhanced Roadside Assistance**

Enhanced Roadside Assistance adds GPS data to the already included warranty-based Lexus roadside service.

Subscribers can press the “SOS” button to reach a Safety Connect response-center agent, who can help with a wide range of needs, such as: towing, flat tire, fuel delivery, etc. For a description of the Roadside Assistance services and their limitations, please see the Safety Connect Terms and Conditions, which are available at [Lexus.com](http://Lexus.com).

## Subscription

After you have signed the Telematics Subscription Service Agreement and are enrolled, you can begin receiving services.

A variety of subscription terms is available for purchase. Contact your Lexus dealer, call the following or push the “SOS” button in your vehicle for further subscription details.

- **The United States**

1-800-25-LEXUS (1-800-255-3987)

- **Canada**

1-800-26-LEXUS (1-800-265-3987)

- **Puerto Rico**

1-877-539-8777

## Remote Connect (if equipped)

Remote Connect is a smartphone application that lets you view and remotely control certain aspects of your vehicle. For details about the functions and services of this application, refer to <http://www.lexus.com/enform/>. Function of the Remote Connect is achieved by using an embedded cellular device in the vehicle (DCM: Data Communication Module).

## Subscription

After you sign the Telematics Subscription Service Agreement, download the Lexus App from your smartphone's app store, and register within the app (or enroll and complete registration at the dealer), you can begin using these services.

A variety of subscription terms are available. Contact your Lexus dealer, or call 1-800-25-LEXUS (1-800-255-3987) for further subscription details.

## Service Connect (if equipped)

Service Connect uses embedded telematics hardware to collect and transmit vehicle data that allows Lexus to provide:

- Vehicle Health Report (VHR) (Safety Recalls, Service Campaigns, Current Vehicle Alerts, Required Maintenance, and Vehicle Condition Status)
- Maintenance Notifications
- Vehicle Alert Notifications

For details about this service and how to register, refer to <http://www.lexus.com/enform/>. The Service Connect is achieved by using a Data Communication Module (DCM) built in the vehicle.

## Door Locks

The vehicle can be locked and unlocked using the entry function, wireless remote control or door lock switches.

For details about the entry function or wireless remote control, refer to P.12, 14.

### Unlocking and locking the doors from the inside

#### ■ Door lock switches (to lock/unlock)

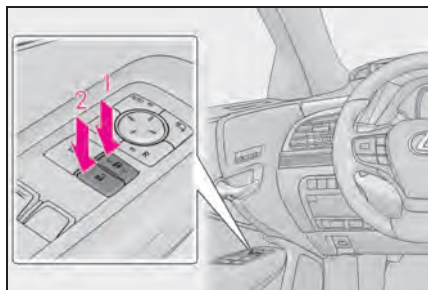

- 1 Locks all the doors
- 2 Unlocks all the doors

#### ■ Inside lock buttons (to lock)

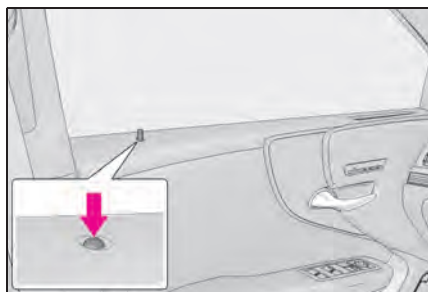

Push down the inside lock button to lock the door.

#### ■ Inside door handles (to unlock)

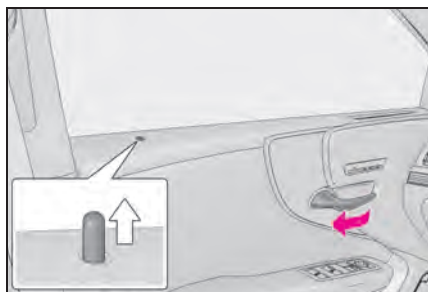

##### ► For the front doors

Pull the handle to unlock and open the door.

When the door is unlocked, the inside lock button will pop up.

##### ► For the rear doors

Pull the handle to unlock the door. Pull the handle a second time to open the door.

When the door is unlocked, the inside lock button will pop up.

## Rear door child-protector lock

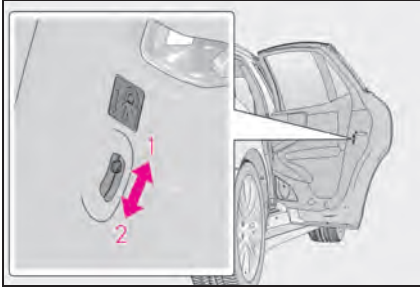

The door cannot be opened from inside the vehicle when the lock is set.

- 1** Unlock
- 2** Lock

These locks can be set to prevent children from opening the rear doors. Push down on each rear door switch to lock both rear doors.

## Power Windows

### Opening and closing the power windows

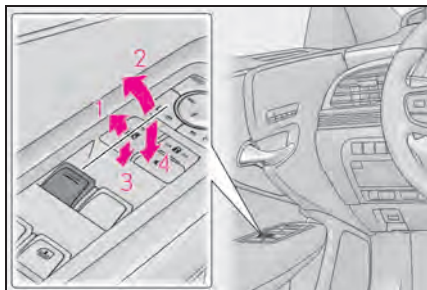

- 1 Closing
- 2 One-touch closing\*
- 3 Opening
- 4 One-touch opening\*

\*: To stop the window partway, operate the switch in the opposite direction.

### Preventing accidental operation (window lock switch)

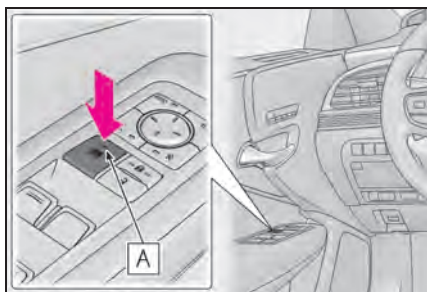

Press the switch.

The indicator **A** will come on and the passenger windows will be locked.

The passenger windows can still be opened and closed using the driver's switch even if the lock switch is on.

This function can be used to prevent children from accidentally opening or closing a passenger window.

# Moon Roof (if equipped)

## Operating the moon roof

### ■ Opening and closing



**1** Opens the moon roof\*  
The moon roof tilts up and then fully opens.

**2** Closes the moon roof\*

\*: Lightly press either side of the moon roof switch to stop the moon roof partway.

### ■ Tilting up and down



**1** Tilts the moon roof up\*

**2** Tilts the moon roof down\*

\*: Lightly press either side of the moon roof switch to stop the moon roof partway.

## Panoramic Moon Roof (if equipped)

### Operating the panoramic moon roof

#### Opening and closing the electronic front roof sunshade

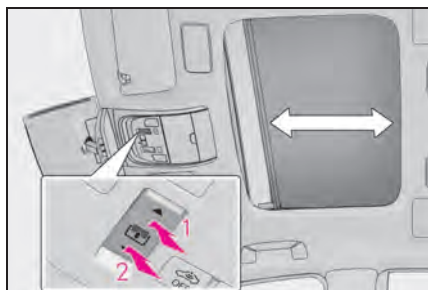

**1** Opens the electronic front roof sunshade\*

**2** Closes the electronic front roof sunshade\*

\*: Lightly press either side of the front roof sunshade switch to stop the electronic front roof sunshade partway.



### ■ Opening and closing the electronic rear roof sunshade

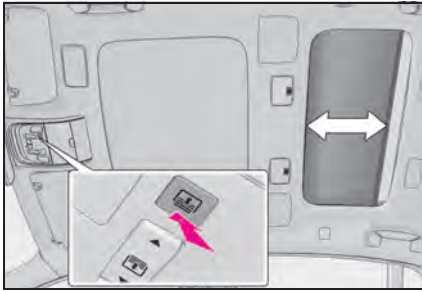

Press the rear roof sunshade switch.

Lightly press the switch while the electronic rear roof sunshade is opening/closing will stop the operation.

Press the switch again will operate the electronic rear roof sunshade in the opposite direction.

### ■ Tilting the panoramic moon roof up and down



Press the tilt switch.

Lightly press the switch while the panoramic moon roof is operating will stop the operation.

### ■ Opening and closing the panoramic moon roof



**1** Opens the panoramic moon roof\*

**2** Closes the panoramic moon roof\*

\*: Lightly press either side of the panoramic moon roof switch to stop the panoramic moon roof partway.

# Fuel Tank Cap

## Before refueling the vehicle

- Close all the doors and windows, and turn the engine switch off.
- Confirm the type of fuel.

## Opening the fuel tank cap

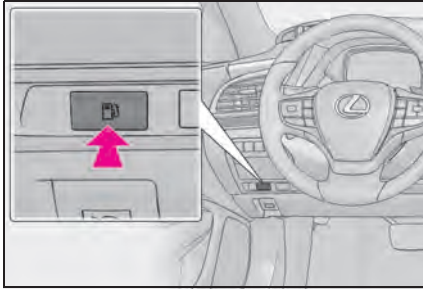

**1** Press the opener switch.

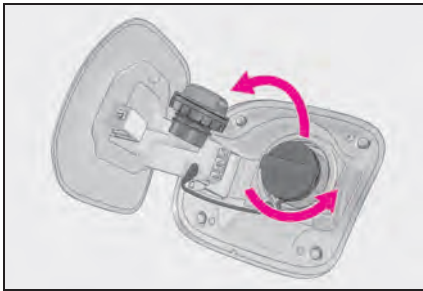

**2** Turn the fuel tank cap slowly and remove it, then put it into the holder on the fuel filler door.

# Trunk

## Opening/closing the trunk

### ■ Trunk opener switch

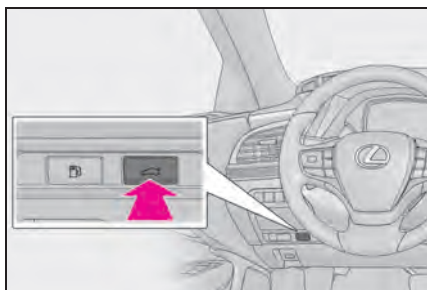

Press the trunk opener switch.

If the vehicle is equipped with a power trunk opener and closer, the trunk lid will fully open.

### ■ Smart access system with push-button start

→P.14

### ■ Wireless remote control

→P.12

### ■ Hands Free Power Trunk Lid (if equipped)

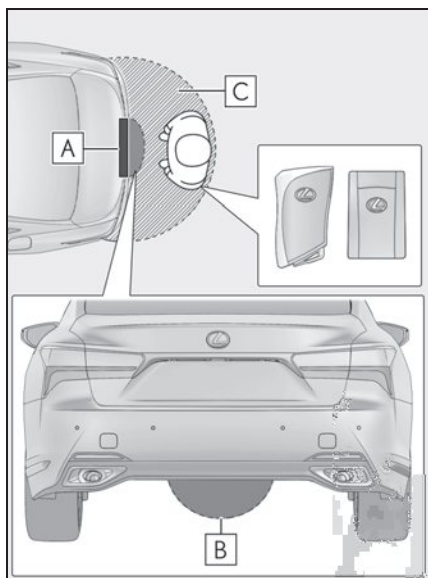

**1** While carrying an electronic key, stand within the smart access system with push-button start operation area, approximately 11.8 to 19.7 in. (30 to 50 cm) from the rear bumper.

- A** Kick sensor
- B** Hands Free Power Trunk Lid operation detection area
- C** Smart access system with push-button start operation detection area

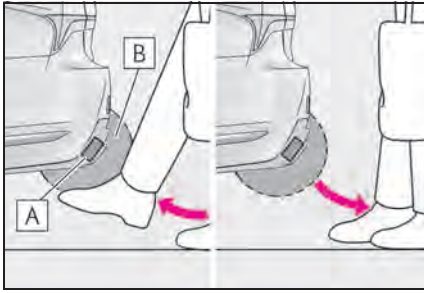

**2** Perform a kick operation by moving your foot to within approximately 3.9 in. (10 cm) of the rear bumper and then pulling it back.

- Perform the entire kick operation within 1 second.
- The trunk lid will not start operating while a foot is detected under the rear bumper.
- Operate the Hands Free Power Trunk Lid without contacting the rear bumper with your foot.
- If another electronic key is in the cabin or trunk, it may take slightly longer than normal for the operation to begin.

**A** Kick sensor

**B** Hands Free Power Trunk Lid operation detection area

**3** When the kick sensor detects that your foot is pulled back, a buzzer will sound and the trunk will automatically fully open/close.

If a foot is moved under the rear bumper while the trunk lid is opening, the trunk lid will stop moving.

If a foot is moved under the rear bumper while the trunk lid is closing, the trunk lid will open.

### ■ Trunk closer switch (vehicles with power trunk opener and closer)

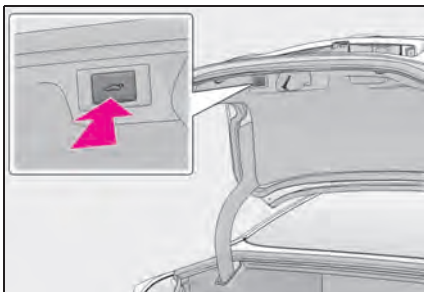

Press the trunk closer switch.

A buzzer will sound and the trunk lid will fully close.

Pressing the switch while the trunk lid is closing opens the trunk lid again.

## What to do if...

### List of Warning/Indicator Lights

Immediately stop the vehicle in a safe place and contact your Lexus dealer. Continuing to drive the vehicle may be dangerous.

**BRAKE**

(U.S.A.)

Brake system warning light



(Canada)

(Red)

Immediately stop the vehicle in a safe place and contact your Lexus dealer.



Charging system warning light



(U.S.A.)

Malfunction indicator lamp



Low engine oil pressure warning light



(Canada)

Have the vehicle inspected by your Lexus dealer immediately.



(yellow)

Brake system warning light



(Blinking and then continuously on)

Tire pressure warning light



SRS warning light



Slip indicator



Pop Up Hood warning light



(Flashes)

(U.S.A.)

Parking brake indicator

**ABS**

(U.S.A.)

ABS warning light



(Flashes)

(Canada)



(Canada)



(Flashes)

Brake hold operated indicator



(Red or yellow)

Electric power steering system warning light

For further information, refer to the "OWNER'S MANUAL".

## What to do if...

### Follow the correction procedures.



Inappropriate pedal operation warning light



Low fuel level warning light



Driver's and front passenger's seat belt reminder light



(except F SPORT models)

Rear passengers' seat belt reminder lights



(F SPORT models)



Tire pressure warning light\*<sup>1</sup>

(Illuminates without blinking)



(orange)

LTA indicator



Intuitive parking assist OFF indicator (if equipped)



(flashes or illuminates)

RCD OFF indicator (if equipped)



(flashes or illuminates)

PKSB OFF indicator (if equipped)



(flashes or illuminates)

PCS warning light

### Stop and check.



High coolant temperature warning light

For further information, refer to the "OWNER'S MANUAL".

## What to do if...

### See the "OWNER'S MANUAL"



Turn signal indicator



Headlight indicator (U.S.A.)



Tail light indicator (Canada)



Headlight high beam indicator



AHB indicator



PCS warning light



Cruise control indicator



Dynamic radar cruise control indicator



Cruise control "SET" indicator



LTA indicator



BSM outside rear view mirror indicators (if equipped)



BSM OFF indicator (if equipped)



Intuitive parking assist OFF indicator (if equipped)



RCTA OFF indicator (if equipped)



RCD OFF indicator (if equipped)



PKSB OFF indicator (if equipped)



Slip indicator



VSC OFF indicator



High mode indicator (if equipped)



Smart access system with push-button start indicator



(U.S.A.) Parking brake indicator



(Canada)



Brake hold standby indicator



Brake hold operated indicator



Eco Driving Indicator Light



Low outside temperature indicator

For further information, refer to the "OWNER'S MANUAL".

## What to do if...

### See the "OWNER'S MANUAL"



Security indicator



"AIR BAG ON/OFF"  
indicator

#### ● Drive mode indicators

##### ▶ Except F SPORT models



Snow mode indicator



Eco drive mode indicator



Normal mode indicator



Sport mode indicator (if equipped)



Custom mode indicator (if equipped)



Sport S mode indicator (if equipped)



Comfort mode indicator (if equipped)



Sport S+ mode indicator (if equipped)

##### ▶ F SPORT models



Snow mode indicator



Eco drive mode indicator



Normal mode indicator



Sport S mode indicator



Custom mode indicator



Sport S+ mode indicator



Comfort mode indicator

For further information, refer to the "OWNER'S MANUAL".

\*1: It also comes on due to natural causes such as natural air leaks and tire inflation pressure changes caused by temperature. Adjust the tire inflation pressure to the specified level. The light will turn off after a few minutes. In case the light does not turn off even if the tire inflation pressure is adjusted, have the system checked by your Lexus dealer.

\*2: Depending on the operating condition, the color and illuminating/flashing state of the light change.



## What to do if...

### If the electronic key does not operate properly

#### Locking and unlocking the doors, unlocking the trunk

##### ■ Unlocking the door

Use the mechanical key in order to perform the following operations:

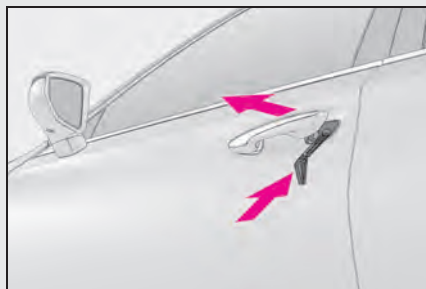

- 1 Pull the driver's door handle and insert the mechanical key

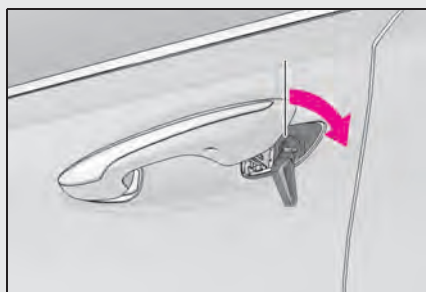

- 2 Unlock the door.

- 3 Remove the key, return the handle, and then pull the handle again.

#### Locking the door



- 1 With the door open, push down the inside lock button.

- 2 Close the door.

## What to do if...

### ■ Trunk

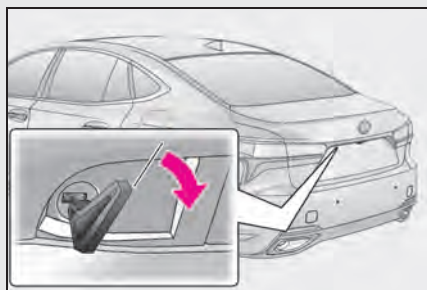

Turn the mechanical key clockwise to open.

## Starting the engine

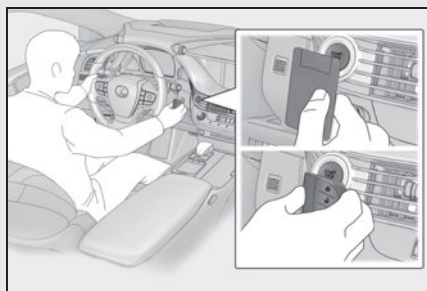

- 1 Depress the brake pedal.
- 2 Touch the Lexus emblem side of the electronic key to the engine switch.

When the electronic key is detected, a buzzer sounds and the engine switch will turn to IGNITION ON mode.

When the smart access system with push-button start is deactivated in customization setting, the engine switch will turn to ACCESSORY mode.

- 3 Firmly depress the brake pedal and check that  is shown on the multi-information display.
- 4 Press the engine switch.

In the event that the engine still cannot be started, contact your Lexus dealer.

If the electronic key battery becomes depleted, a warning message will be shown on the multi-information display. Replace the battery with a new one. For instructions on replacing the battery, refer to the "OWNER'S MANUAL".

If you need further assistance, contact your Lexus dealer.

## What to do if...

### If the engine will not start

Make sure that the correct operating procedures have been followed.

**Brake pedal**

Make sure that the brake pedal is firmly depressed when attempting to start the engine. (→P.23)

If the engine still does not start, see the "OWNER'S MANUAL" for more information or contact your Lexus dealer.

**Memo**

A large white rectangular area with horizontal lines, serving as a memo template. The lines are evenly spaced and extend across the width of the page, providing a guide for writing.



**Memo**

A large white rectangular area with horizontal lines, serving as a memo template. The lines are evenly spaced and extend across the width of the page, providing a guide for writing.



### **Your Lexus dealer**

Your Lexus dealer will provide quality maintenance and any other assistance you may require.

If there is not a Lexus dealer near you, please call the following number:

#### **■ U.S. OWNERS**

- In the U.S. mainland or Canada:

Lexus Roadside Assistance

**1-800-25-LEXUS or 1-800-255-3987 (Toll-Free)**

- In Hawaii:

Servco Automotive Roadside Assistance/Customer Services

**1-800-25-LEXUS or 1-800-255-3987 (Toll-Free)**

#### **■ CANADIAN OWNERS**

- In Canada or the U.S. mainland:

Lexus Roadside Assistance/Customer Service

**1-800-26-LEXUS or 1-800-265-3987 (Toll-Free)**

Please access our **websites** for further information.

- The U.S. mainland: **[www.lexus.com](http://www.lexus.com)**

- Hawaii: **[www.servcolexus.com](http://www.servcolexus.com)**

- Canada: **[www.lexus.ca](http://www.lexus.ca)**

©2022 TOYOTA MOTOR CORPORATION

All rights reserved. This material may not be reproduced or copied, in whole or in part, without the written permission of Toyota Motor Corporation.



Owner's Manual Quick Guide:

Publication No. OM50L89U

Part No. 01999-50L89

Printed in Japan 01-2210-00□

LS500 Owner's Manual Quick Guide (北米U)