

Content

A-Z



OWNER'S MANUAL.
BMW i4 GRAN COUPE.





WELCOME TO BMW.

Owner's Manual.

Thank you for choosing a BMW.

The more familiar you are with the vehicle, the better control you will have on the road. We therefore strongly suggest the following:

Read this Owner's Manual before starting off in your new BMW. Also use the Integrated Owner's Manual in the vehicle. It contains important notes on vehicle operation that will help you make full use of the technical features available in your BMW. The manual also contains information designed to enhance operating reliability and traffic safety, and to contribute to maintaining the value of your BMW.

At the time of production at the plant, the printed Owner's Manual is the most current resource. After a vehicle software update – such as a Remote Software Upgrade – the Integrated Owner's Manual for the vehicle will contain the latest information.

You can find supplementary information in the additional brochures in the onboard literature.

We wish you a safe and enjoyable ride.

TABLE OF CONTENTS

After a vehicle software update – such as a Remote Software Upgrade – the Integrated Owner's Manual for the vehicle will contain the latest information.

! NOTES

Information	6
BMW eDRIVE	16
Safety of the high-voltage system	19

🔑 QUICK REFERENCE

Getting in	22
Set-up and use	25
On the road	29

👉 CONTROLS

Dashboard	36
Sensors of the vehicle	41
Operating state of the vehicle	46
BMW iDrive	50
BMW Remote Software Upgrade	66
Personal settings	70
Opening and closing	76
Seats, mirrors and steering wheel	103
Transporting children safely	117
Driving	123
Displays	136
Light and view	157
Safety	169
Driving stability control systems	199
Driver assistance systems	203
Parking	227
Driving comfort	247
Climate control	248

Interior equipment	260
Storage compartments	267
Cargo area	271

DRIVING TIPS

Things to remember when driving	276
Increasing range	281

MOBILITY

Charging the vehicle	286
Wheels and tires	301
Under the hood	330
Operating fluids	333
Maintenance	335
Replacing components	337
Breakdown Assistance	341
Vehicle care	349

REFERENCE

Technical data	356
Appendix	359
Everything from A to Z	360

© 2024 Bayerische Motoren Werke

Aktiengesellschaft

Munich, Germany

Reprinting, including excerpts, only with the written consent of BMW AG, Munich.

US English ID8 VI/24, -

Printed on environmentally friendly paper, bleached without chlorine, suitable for recycling.

Information

Using this Owner's Manual

Orientation

The fastest way to find information on a particular topic is by using the index.

For an overview of the vehicle, we recommend reading the Quick Reference Guide in the Owner's Manual.

Validity of the Owner's Manual

Production of the vehicle

At the time of production at the plant, the printed Owner's Manual is the most current resource. Due to updates after the editorial deadline, differences may exist between the printed Owner's Manual and the Integrated Owner's Manual in the vehicle.

Notes on updates can be found in the appendix of the printed Owner's Manual for the vehicle.

After a software update in the vehicle

After a vehicle software update such as via Remote Software Upgrade the Integrated Owner's Manual for the vehicle will contain the latest information.

Owner's Manual for Navigation, Entertainment, Communication

The Owner's Manual for Navigation, Entertainment, and Communication is available as a printed book from an authorized service center.

The topics are also discussed in the Integrated Owner's Manual in the vehicle.

Media at a glance

General information

The contents of the Owner's Manual are available in various media formats. The following Owner's Manual media formats are available:

- ▶ Printed Owner's Manual.
- ▶ Integrated Owner's Manual in the vehicle.

Printed Owner's Manual

The printed Owner's Manual shows all standard, country-specific, and optional equipment that is currently available, or may become available in the future, for specific models.

Integrated Owner's Manual in the vehicle

Principle

The Integrated Owner's Manual shows all standard, country-specific, and optional equipment that is currently available, or may become available in the future, for specific models. The Integrated Owner's Manual can be displayed on the control display.

Selecting the Owner's Manual

1. ■■ Apps menu
2. "All apps"
3. "Owner's Manual"
4. Select the desired method of accessing the contents.

Scrolling through the Owner's Manual

Swipe up or down until the next or previous contents are displayed.

Context help

General information

The Integrated Owner's Manual can be accessed from any menu. Depending on the selected function, either the associated description or the main menu of the Integrated Owner's Manual will be displayed.

Selecting context help from a menu

1. Press and hold the desired menu item.
2. "General help"

Selecting context help from a Check Control message

Directly from the Check Control message on the control display:
"Owner's Manual"

Supplementary documentation

Additional documents, e.g., Supplementary Owner's Manuals, brochures, or inserts, supplement the media included with the Owner's Manual. Supplementary Owner's Manuals or brochures contain, for example, information on special models or information that must be communicated in printed form due to legal requirements. Inserts may include different information than that given in the media included with the Owner's Manual. Follow all additional documents that may be enclosed with the on-board literature.

Additional sources of information

Authorized service center

An authorized service center, e.g., a BMW dealer or service center, will be happy to answer any questions you may have.

Internet

Vehicle information and general information on BMW such as on technology are available on the Internet: www.bmwusa.com.

BMW Driver's Guide app



The BMW Driver's Guide app shows all standard, country-specific, and optional equipment that is currently available, or may become available in the future, for specific models. The app can be displayed on smartphones and tablets.

BMW Driver's Guide Web

The BMW Driver's Guide website shows all standard, country-specific, and optional equipment that is currently available, or may become available in the future, for specific models. The BMW Driver's Guide Web can be displayed in any current browser.

Icons and displays

Icons in the Owner's Manual

Icon	Meaning
	Precautions that must be followed in order to avoid the possibility of injury to yourself and to others as well as serious damage to the vehicle.
	Measures that can be taken to help protect the environment.
"..."	Texts in vehicle used to select individual functions.
>...<	Verbal instructions to use with the voice activation system.
>>...<<	Responses generated by the voice activation system.

Action steps

Action steps to be carried out are presented as a numbered list. These steps must be carried out in the order shown.

1. First action step.
2. Second action step.

Bulletpoint lists

Items or actions without strict order or alternative options are shown as a bulletpoint list.

- ▷ First possibility.
- ▷ Second possibility.

Icons on vehicle parts

 This symbol on a vehicle component indicates that further information on the component is available in the Owner's Manual.

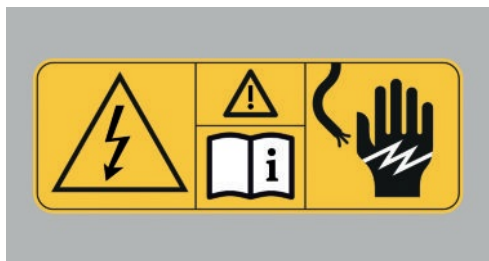

These icons found on parts of the vehicle indicate that incorrect use of high-voltage technology or of orange-colored high-voltage components poses a risk of life-threatening injury by electric shock.

Vehicle features and options

This Owner's Manual shows all standard, country-specific, and optional equipment that is currently available, or may become available in the future, for specific models, i.e., model series. Therefore, this Owner's Manual also describes and illustrates equipment, systems

and functions that are not available in a vehicle, for example due to the following situations:

- ▷ Selected optional equipment.
- ▷ National-market version or national-market equipment.
- ▷ Options for later release and software update.

This also applies to safety functions and systems.

Before starting a journey, verify whether the described equipment or function is available in the vehicle. For information on whether a function is currently available in the vehicle or when the function can be installed in the vehicle, contact an authorized service center or another qualified service center or repair shop.

A claim for the availability of equipment, a system or a function in the vehicle cannot be derived based on the description in the Owner's Manual.

When using these functions and systems, the applicable laws and regulations must be observed.

For any equipment and models not described in this Owner's Manual, refer to any supplementary documentation included, e.g., Supplementary Owner's Manuals, inserts.

An authorized service center is happy to answer any questions that you may have about the features and options applicable to the vehicle.

Status of the Owner's Manual

Basic information

The manufacturer of the vehicle pursues a policy of constant development to ensure that our vehicles continue to embody the highest quality and safety standards. In rare cases, therefore, the features described in this Owner's Manual may deviate from those in the vehicle.

Validity of the Owner's Manual

Production of the vehicle

At the time of production at the plant, the printed Owner's Manual is the most current resource. Due to updates after the editorial deadline, differences may exist between the printed Owner's Manual and the Integrated Owner's Manual in the vehicle.

Notes on updates can be found in the appendix of the printed Owner's Manual for the vehicle.

After a software update in the vehicle

After a vehicle software update such as via Remote Software Upgrade the Integrated Owner's Manual for the vehicle will contain the latest information.

For Your Own Safety

Intended use

Heed the following when using the vehicle:

- ▶ Owner's Manual.
- ▶ Information on the vehicle. Do not remove stickers.
- ▶ Technical vehicle data.
- ▶ The traffic, speed, and safety laws where the vehicle is driven.
- ▶ Vehicle documents and statutory documents.

Warranty

The vehicle is technically configured for the operating conditions and registration requirements applicable in the country of first delivery, also known as homologation. If the vehicle is to be operated in a different country it might be necessary to adapt the vehicle to potentially differing operating conditions and registration requirements. Noncompliance with homologation requirements in a certain country may

affect warranty coverage. Please consult the New Vehicle Limited Warranty Booklet for further information on warranty matters.

Maintenance and repairs

Advanced technology, for instance the use of modern materials and high-performance electronics, requires suitable maintenance and repair work.

The vehicle manufacturer therefore recommends having necessary work performed by an authorized service center, e.g., a BMW dealer or service center. If a different repair shop is selected, BMW recommends selecting a workshop that performs the appropriate work such as maintenance and repair according to BMW specifications with properly trained personnel. In the Owner's Manual, such workshops are referred to as "another qualified service center or repair shop".

If work is not carried out properly, for instance maintenance and repair, there is a risk of subsequent damages and related safety risks.

Improperly performed work on the vehicle paintwork can lead to a failure or fault of components, e.g., the radar sensors, and thereby result in a safety hazard.

Parts and accessories

BMW recommends the use of parts and accessory products approved by BMW.

Approved parts and accessories, and advice on their use and installation are available from an authorized service center.

BMW parts and accessories have been tested by BMW for their safety and suitability in BMW vehicles.

BMW warrants genuine BMW parts and accessories.

BMW does not evaluate whether each individual product from another manufacturer can be used with BMW vehicles without presenting a safety hazard, even if a country-specific official approval was issued. BMW does not evaluate

whether these products are suitable for BMW vehicles under all usage conditions.

California Proposition 65 Warning

For vehicles sold in California, the law requires vehicle manufacturers to provide the following warning:

Warning

Engine exhaust and a wide variety of Automobile components and parts, including components found in the interior furnishings in a vehicle, contain or emit chemicals known to the State of California to cause cancer and birth defects and reproductive harm. In addition, certain fluids contained in vehicles and certain products of component wear contain or emit chemicals known to the State of California to cause cancer and birth defects or other reproductive harm. Battery posts, terminals and related accessories contain lead and lead compounds. Batteries also contain other chemicals known to the State of California to cause cancer. Wash your hands after handling. Used engine oil contains chemicals that have caused cancer in laboratory animals. Always protect your skin by washing thoroughly with soap and water. For more information go to www.P65Warnings.ca.gov/passenger-vehicle.

Warning

Operating, servicing and maintaining a passenger vehicle or off-highway motor vehicle can expose you to chemicals including engine exhaust, carbon monoxide, phthalates, and lead, which are known to the State of California to cause cancer and birth defects or other reproductive harm. To minimize exposure, avoid breathing exhaust, do not idle the engine except as necessary, service the vehicle in a well-ventilated area and wear gloves or wash your hands frequently when

servicing the vehicle. For more information go to www.P65Warnings.ca.gov/passenger-vehicle.

Service and warranty

We recommend that you read this publication thoroughly. The vehicle is covered by the following warranties:

- ▶ New Vehicle Limited Warranty.
- ▶ Rust Perforation Limited Warranty.
- ▶ Federal Emissions System Defect Warranty.
- ▶ Federal Emissions Performance Warranty.
- ▶ California Emission Control System Limited Warranty.

Detailed information about these warranties is listed in the New Vehicle Limited Warranty Booklet.

The vehicle has been specifically adapted and designed to meet the particular operating conditions and homologation requirements in your country and continental region in order to deliver the full driving pleasure while the vehicle is operated under those conditions. If you wish to operate the vehicle in another country or region, you may be required to adapt the vehicle to meet different prevailing operating conditions and homologation requirements. You should also be aware of any applicable warranty limitations or exclusions for such country or region. In such case, please contact Customer Relations for further information.

Maintenance

Maintain the vehicle regularly to sustain the road safety, operational reliability and the New Vehicle Limited Warranty.

Specifications for maintenance measures:

- ▶ BMW maintenance system.

Maintenance, refer to page 335.

- ▷ Maintenance Booklet, available online and accessible via a QR code in the New Vehicle Limited Warranty Booklet.
- ▷ Warranty and Service Guide Booklet for Canadian models.

If the vehicle is not maintained or is improperly maintained, this could result in serious damage to the vehicle.

A failure to maintain the vehicle or improper maintenance may affect your warranty coverage. Please consult the New Vehicle Limited Warranty Booklet for further information on warranty matters.

Refer to section on engine oil change regarding recommended service intervals for oil changes.

Data memory

General information

Electronic control devices are installed in the vehicle. Electronic control units process data they receive from vehicle sensors, self-generate or exchange with each other. Some control units are necessary for the vehicle to function safely or provide assistance while driving, for instance driver assistance systems. Furthermore, control units facilitate comfort or infotainment functions.

Information about stored or exchanged data can be requested from the manufacturer of the vehicle, in a separate booklet, for example.

Personal reference

Each vehicle is marked with a unique vehicle identification number. Depending on the country, the vehicle owner can be identified with the vehicle identification number, license plate and corresponding authorities. In addition, there are other ways to associate data collected from the vehicle with the driver or ve-

hicle owner, e.g., the ConnectedDrive account used.

Operating data in the vehicle

Control units process data to operate the vehicle.

For example, this includes:

- ▷ Status messages for the vehicle and its individual components, e.g., wheel RPM, wheel speed, deceleration, lateral acceleration, engaged seat belt indicator.
- ▷ Ambient conditions, e.g., temperature, rain sensor signals.

The processed data is only processed in the vehicle itself while the vehicle is being operated. Data is not stored beyond the operating time.

Electronic components, e.g. control units and vehicle keys, contain components for storing technical information. Information about the vehicle condition, component usage, maintenance recommendations, events or faults can be stored temporarily or permanently.

This information generally documents the state of a component, a module, a system, or the surrounding area, for instance:

- ▷ Operating states of system components such as fill levels, tire pressure, battery status.
- ▷ Malfunctions and faults in important system components, for instance lights and brakes.
- ▷ Responses by the vehicle to special driving situations such as airbag deployment or engagement of the driving stability control systems.
- ▷ Information on vehicle-damaging events.

The data is required to perform the control unit functions. Furthermore, it also serves to detect and correct malfunctions, and helps the vehicle manufacturer to optimize vehicle functions.

The majority of this data is stored temporarily and is only processed within the vehicle itself.

In some circumstances the vehicle may store some data for an additional but limited period of time.

When servicing, for instance during repairs, service processes, warranty cases, and quality assurance measures, this technical information can be read out from the vehicle together with the vehicle identification number.

An authorized service center or another qualified service center or repair shop can read out the information. The diagnostic socket required by law in the vehicle is used to read out data.

The data is collected, processed, and used by the relevant organizations in the service network. The data documents technical conditions of the vehicle, which can be used to determine vehicle maintenance status, and facilitate quality improvement.

Vehicle fault and event memories can be reset by an authorized service center or another qualified service center or repair shop when performing repair or servicing work.

Data entry and data transfer into the vehicle

General information

Depending on the vehicle equipment, comfort and individual settings can be stored in the vehicle and modified or reset at any time.

For example, this includes:

- ▶ Settings for the seat and steering wheel positions.
- ▶ Chassis and air conditioning settings.

If necessary, data can be transferred to the entertainment and communication system of the vehicle, for instance via smartphone.

This includes the following depending on the respective equipment:

- ▶ Multimedia data such as music, films or photos for playback in an integrated multimedia system.
- ▶ Address book data for use in conjunction with an integrated hands-free system or an integrated navigation system.
- ▶ Entered navigation destinations.
- ▶ Data on the use of Internet services.

This data can be stored locally in the vehicle or is found on a device that has been connected to the vehicle, e.g., a smartphone, USB stick or MP3 player. If this data is stored in the vehicle, it can be deleted at any time.

This data is only transmitted to third parties upon personal request as part of the use of online services. The transmission depends on the selected settings for the use of the services.

Incorporation of mobile devices

Depending on the vehicle equipment, mobile devices connected to the vehicle, for instance smartphones, can be controlled via the vehicle operating elements.

The sound and picture from the mobile devices can be played back and displayed through the multimedia system. Certain information is transferred to the mobile devices at the same time. Depending on the type of incorporation, this includes, for instance, position data and other general vehicle information. This optimizes the way in which selected apps, for instance navigation or music playback, work.

There is no further interaction between the mobile device and the vehicle such as active access to vehicle data.

How the data will be processed further is determined by the provider of the particular app being used. The extent of the possible settings depends on the respective app and the operating system of the mobile device.

Services

General information

If the vehicle has a wireless network connection, it will enable data to be exchanged between the vehicle and other systems. The wireless network connection is realized via an in-vehicle transmitter and receiver unit or via personal mobile devices brought into the vehicle, for instance smartphones. This wireless network connection enables 'online functions' to be used. These include online services and apps supplied by the vehicle manufacturer or by other providers.

Services from the vehicle manufacturer

Where online services from the vehicle manufacturer are concerned, the corresponding functions are described in the appropriate place, for instance the Owner's Manual or manufacturer's web page. The relevant legal information pertaining to data protection may also be found on the manufacturer's website. Personal data may be used to perform online services. Data is exchanged over a secure connection, for instance with the IT systems of the vehicle manufacturer intended for this purpose. Any collection, processing, and use of personal data above and beyond that needed to provide the services must always be based on a legal permission, contractual arrangement or consent. It is also possible to activate or deactivate the data connection as a whole. This excludes functions and services required by law such as Assist systems.

Services from other providers

When using online services from other providers, these services are the responsibility of the relevant provider and subject to their data privacy conditions and terms of use. The vehicle manufacturer has no influence on the content exchanged during this process. Information on the way in which personal data is collected and used in relation to services from third parties,

the scope of such data, and its purpose, can be obtained from the relevant service provider.

Event Data Recorder (EDR)

This vehicle is equipped with an event data recorder (EDR). The main purpose of an EDR is to record, in certain crash or near crash-like situations such as an air bag deployment or hitting a road obstacle, data that will assist in understanding how a vehicle's systems performed. The EDR is designed to record data related to the driving dynamics and safety systems for a short time: max. 30 seconds, typically less.

The EDR in this vehicle is designed to record the following data, for example:

- ▷ How various systems in the vehicle were operating.
- ▷ Whether or not the driver and passenger seat belts were fastened.
- ▷ How far, if at all, the driver was depressing the accelerator and/or brake pedal.
- ▷ How fast the vehicle was traveling.

This data can help provide a better understanding of the circumstances in which crashes and injuries occur.

EDR data is recorded by the vehicle only if a nontrivial crash situation occurs; no data is recorded by the EDR under normal driving conditions and no personal data, for instance name, gender, age, and crash location, are recorded.

However, other parties such as law enforcement could combine the EDR data with the type of personally identifying data routinely acquired during a crash investigation.

To read data recorded by an EDR, special equipment is required, and access to the vehicle or the EDR is needed. In addition to the vehicle manufacturer, other parties such as law enforcement that have the special equipment can read the information if they have access to the vehicle or the EDR.

Vehicle identification number

General information

Depending on the national-market equipment, the vehicle identification number is located in different positions in the vehicle. This chapter describes all possible positions for the series.

Under the hood



The engraved vehicle identification number can be found under the hood on the right-hand side of the vehicle.

Right nameplate



The vehicle identification number can be found on the nameplate, on the right-hand side of the vehicle.

Left nameplate



The vehicle identification number can be found on the nameplate, on the left-hand side of the vehicle.

Windshield



The vehicle identification number can also be found behind the windshield.

iDrive

It is also possible to display the vehicle identification number via iDrive.

1.  Apps menu
2. "All apps"
3. "Mobile devices"
4. "Settings"
5. "Vehicle ID (VIN):"

Reporting safety defects

For US customers

The following only applies to vehicles owned and operated in the US.

If you believe that the vehicle has a defect which could cause a crash or could cause injury or death, you should immediately inform the National Highway Traffic Safety Administration (NHTSA), in addition to notifying BMW of North America, LLC, P.O. Box 1227, Westwood, New Jersey 07675-1227, Telephone 1-800-831-1117.

If NHTSA receives similar complaints, it may open an investigation, and if it finds that a safety defect exists in a group of vehicles, it may order a recall and remedy campaign.

However, NHTSA cannot become involved in individual problems between you, your dealer, or BMW of North America, LLC.

To contact NHTSA, you may call the Vehicle Safety Hotline toll-free at 1-888-327-4236 (TTY: 1-800-424-9153); go to <http://www.safercar.gov>; or write to: Administrator, NHTSA, 1200 New Jersey Avenue, SE., Washington, DC 20590. You can also obtain other information about motor vehicle safety from <http://www.safercar.gov>.

For Canadian customers

Canadian customers who wish to report a safety-related defect to Transport Canada, Defect Investigations and Recalls, may call the toll-free hotline 1-800-333-0510. You can also obtain other information about motor vehicle safety from <http://www.tc.gc.ca/roadsafety>.

BMW eDRIVE

Vehicle features and options

This chapter describes model-specific equipment, systems, and functions that are currently available, or may become available in the future, even if they are not present in the vehicle.

Additional information:

Vehicle equipment, refer to page 8.

BMW eDRIVE

Principle

BMW eDRIVE is the designation for the electric drive technology. The vehicle features a high-voltage system that consists of an electric motor on the rear axle and a high-voltage battery, among other things. With xDrive, a second electric motor is located on the front axle.

General information

The system exhibits the following special features:

- ▶ Vehicle operation is emissions-free using the electrical drivetrain.
- ▶ The special high-voltage battery supplies the electric motors and the comfort features with energy.
- ▶ The high-voltage battery is charged via a charging cable, for instance when parked or while driving utilizing energy recovery.
- ▶ The vehicle can be charged very rapidly at special charging stations. Charging is also possible at domestic socket outlets.
- ▶ On the go, the energy recovery ensures that only little energy is lost when braking.
- ▶ When the vehicle decelerates, the electric motors act as alternators and convert the kinetic energy released into electric energy.

The electrical energy partially recharges the high-voltage battery to increase the range.

- ▶ The rear electric motor drives the rear wheels.

With xDrive, the vehicle features electrical all-wheel drive. As such, the front wheels are driven by a second electric motor.

Overview

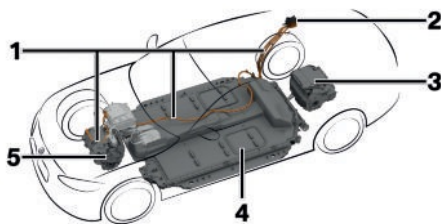

- 1 High-voltage cables, orange
- 2 Charging socket
- 3 Drive unit, rear
- 4 High-voltage battery
- 5 With xDrive: drive unit, front

Functions

Electric driving: eDRIVE

The vehicle is driven electrically.

The accelerator pedal can be used for acceleration and deceleration.

During deceleration, the electric motors act as alternators and charge the high-voltage battery. With an anticipatory driving style, this function can be used for especially efficient energy recovery and comfortable driving, using just the accelerator pedal.

Energy recovery

The high-voltage battery is charged while driving through energy recovery.

The electric motors act as alternators and convert the vehicle's kinetic energy into electrical energy.

The high-voltage battery can be charged while driving in different situations:

- ▶ The accelerator pedal is depressed less or only slightly.
- ▶ The accelerator pedal is not depressed.

Displays in the instrument cluster

The displays on the instrument cluster provide information about the current state of the drive and visualize the system's use.

Additional information:

Displays, refer to page [136](#).

Energy-saving driving and maximizing the range

General information

Energy-saving driving is the basic prerequisite for as large a range as possible. eDRIVE provides various functions that assist with an energy-saving driving style. The eDRIVE functions assist in checking the range and increase it, if necessary.

Before driving

eDRIVE allows pre-conditioning of the vehicle before starting the trip. The stationary climate control provides more range than using full air conditioning while driving.

Depending on vehicle equipment: preheating/precooling during the charging process can provide maximum range when driving off.

Additional information:

Stationary climate control, refer to page [258](#).

Trip planning and special functions of the navigation system

Several special functions of the navigation system support trip planning taking into account the electric range:

- ▶ The current range can be displayed in the navigation system map view.
- ▶ When entering a destination, charging stations can be selected as points of interest.
- ▶ The navigation system helps you to find and add a charging station along the desired route.

Additional information:

Owner's Manual for Navigation, Entertainment, and Communication, refer to page [6](#).

While driving

- ▶ "ECO PRO": activate driving mode to increase the range.
ECO PRO, refer to page [131](#).
- ▶ Note the information on the current driving condition.
Displays in the Live Vehicle menu, driving condition, refer to page [155](#).
- ▶ Note the information on the range.
Increasing the range, refer to page [281](#).
- ▶ Note the information on the driving style.
Using the eDRIVE system efficiently, refer to page [282](#).
- ▶ Activate adaptive energy recovery.
Adaptive recuperation, recuperative braking, refer to page [283](#).
- ▶ Use the battery heat management system to prepare the high-voltage battery for an upcoming charging process.
Preparing the high-voltage battery, refer to page [293](#)

After the trip

- ▶ Charge the vehicle and plan the next trip.

Charge vehicle, refer to page [286](#).

- ▶ Observe preparations extended stationary periods.

Service life of the high-voltage battery, long stationary periods, and taking the vehicle out of service, refer to page [299](#).

BMW app

The My BMW app provides mobility-based services and applications.

Safety of the high-voltage system

Follow the information on the safety of the high-voltage system.

Additional information:

Safety of the high-voltage system, refer to page [19](#).

Operating noises

Operating noises may occur due to the electrical system. For instance, these operating noises may occur in the following situations:

- ▶ When cooling the high-voltage battery during the charging process.
- ▶ When cooling the high-voltage battery with the drive-ready state switched on.
- ▶ When climatizing the car's interior.

High-voltage battery, long stationary periods

Observe the information on taking the vehicle out of service and on longer idle periods.

Additional information:

Service life of the high-voltage battery, long stationary periods, refer to page [299](#).

Safety of the high-voltage system

Vehicle features and options

This chapter describes model-specific equipment, systems, and functions that are currently available, or may become available in the future, even if they are not present in the vehicle.

Additional information:

Vehicle equipment, refer to page 8.

- ▶ Water in the footwell, for instance after a rainstorm when the window was kept open.
- ▶ The vehicle is in water up to the allowed height.
General driving instructions, driving through water, refer to page 276.
- ▶ Fluid escapes in the cargo area.

Working on the vehicle

General information

The manufacturer of the vehicle recommends that no changes be made to the vehicle, for instance installation of retrofitting accessories, that will have an effect on the vehicle's high-voltage system.

Safety information

Warning

Improperly performed work, in particular maintenance and repair on the high-voltage system, can lead to electric shock. There is a risk of injury, fire and danger to life.

It is recommended that the work on the vehicle, in particular maintenance and repair, is performed by an authorized service center or another qualified service center or repair shop.

Contact with ground

Note the ground clearance to prevent damage to the high-voltage system. If the vehicle floor has come into contact with the ground, have the vehicle checked by an authorized service center or another qualified service center or repair shop.

Additional information:

General driving instructions, ground clearance, refer to page 276.

Monitoring of the high-voltage battery

Principle

The temperature in the high-voltage battery is monitored.

Any unusually high temperature in the high-voltage battery is indicated.

Safety information

Warning

An unusually high temperature of the high-voltage battery can cause a formation of gas and smoke. There is a risk of injury or danger to life. In case of noticeable unusual odor

Contact with water

The high-voltage system is typically safe even in the following example situations:

or smoke formation, refer to the notes for actions in the event of a message.

High temperature message

While driving

If the temperature of the high-voltage battery is too high while driving, a Check Control message is displayed on the control display.

During charging or when parked

Depending on the national-market version: the vehicle sounds the horn and, if applicable, the vehicle lighting is flashing.

Actions in the event of a message

While driving

1. Stop immediately.
2. Park the vehicle in a safe place.
3. Exit the vehicle.
4. Establish and keep a sufficient distance to the vehicle.
5. Alert emergency personnel.

During and shortly after charging

1. If necessary, exit the vehicle.
2. Establish and keep a sufficient distance to the vehicle.
3. Alert emergency personnel.

Automatic deactivation

If an accident occurs, the high-voltage system is switched off automatically to prevent risk of danger to occupants and other road users.

Additional information:

What to do after an accident, refer to page 345.





Getting in

Opening and closing

Vehicle key



Buttons on the vehicle key.

Icon	Meaning
	Unlock.
	Lock. Pre-conditioning. Display the charging screen.
	Open the cargo area.
	Panic mode. Pathway lighting.

Access to vehicle interior

Unlocking with the vehicle key

 Press the button on the vehicle key.

If only the driver's door and charging socket flap have been unlocked due to the settings, press the button on the vehicle key again to unlock the other vehicle access points.

Locking with the vehicle key

1. Close the driver's door.
2.  Press the button on the vehicle key. All vehicle access points are locked.

Buttons for the central locking system

Overview

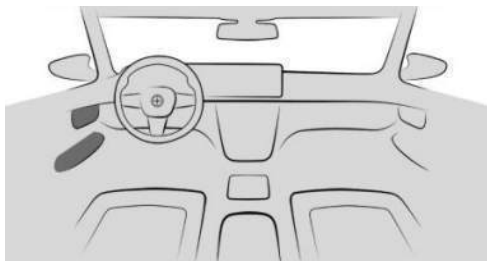

The central locking buttons are located on the front door.

-  Lock.
-  Unlock.

Locking the vehicle



 Press the button with the front doors closed.

Unlocking the vehicle

 Press the button.

Panic mode

You can trigger the alarm system if you find yourself in a dangerous situation.

- ▷  Press the button on the vehicle key and hold for at least 3 seconds.
- ▷  Briefly press the button on the vehicle key three times in succession.

To switch off the alarm: press any button.

Access to the cargo area

Opening the cargo area

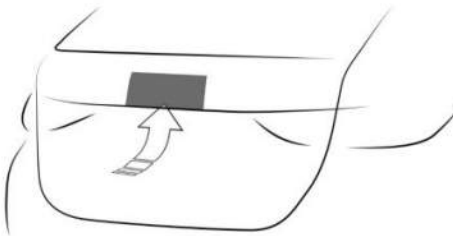

- ▷ Unlock the vehicle and then press the button on the cargo area.
- ▷  Press and hold the button on the vehicle key for approx. 1 second.
Depending on the setting, the doors may be unlocked.

Closing the cargo area

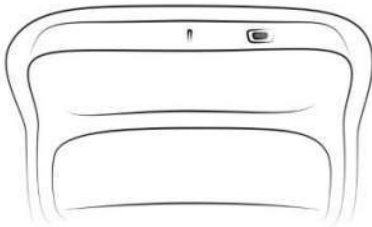

Press the button on the inside of the cargo area.

Displays, operating elements

In the vicinity of the steering wheel



- 1 Light switch
- 2 Turn signal, high-beam headlights
- 3 Instrument cluster
- 4 Wipers

Indicator/warning lights

The indicator/warning lights can illuminate in a variety of combinations and colors.

Several of the lights are checked for proper functioning and illuminate temporarily when drive-ready state is turned on.

Driver's door

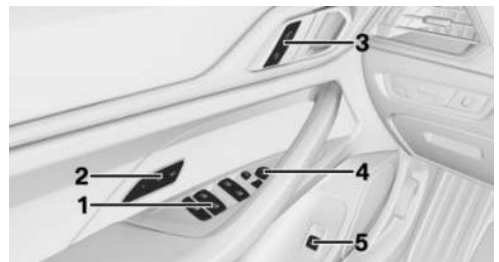

- 1 Power windows
- 2 Seats, comfort features
- 3 Central locking system

- 4 Exterior mirrors
- 5 Cargo area

Switch console

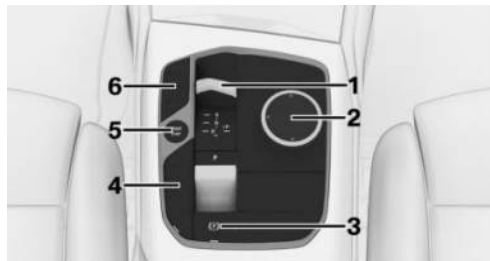

- 1 Selector lever
- 2 Controller
- 3 Parking brake, Automatic Hold
- 4 Driving Experience Control
- 5 Start/Stop button
- 6 Assistance systems

BMW iDrive

Principle

BMW iDrive is the vehicle's display and operating concept and includes a wide range of functions.

Buttons on the Controller

Button	Function
HOME	Call up the main menu.
MEDIA	Call up the Media/Radio menu.
TEL	Go to Phone menu.

Button Function

MAP	Call up the navigation map.
NAV	Call up the destination input menu for navigation.
BACK	Go to previous menu.
OPTION	Call up the Options menu.

BMW Intelligent Personal Assistant

Principle

The BMW Intelligent Personal Assistant is a personal assistant that enables natural voice operation of various vehicle functions.

Activating the voice control system

-  Press the button on the steering wheel briefly.
- Say the command.

Canceling voice control

- ▶  Press the button on the steering wheel again.
- ▶ >Cancel<
- ▶ Slide the Controller to the right or left.
- ▶ Press the Controller.

Set-up and use

Seats, mirrors and steering wheel

Manually adjustable seats

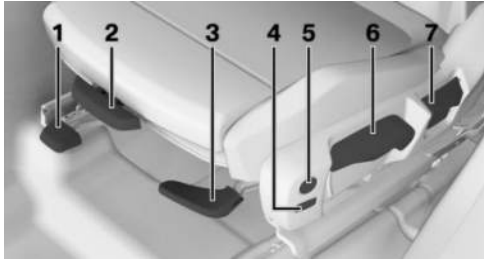

- 1 Longitudinal direction
- 2 Thigh support
- 3 Seat tilt
- 4 Backrest width
- 5 Lumbar support
- 6 Height
- 7 Backrest tilt

Semi-electrically adjustable seats



- 1 Longitudinal direction
- 2 Thigh support
- 3 Backrest tilt
- 4 Height/seat tilt
- 5 Lumbar support

Electrically adjustable seats

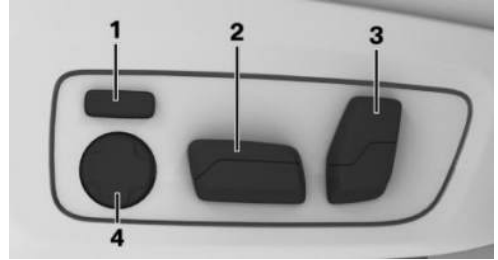

- 1 Backrest width
- 2 Height/longitudinal direction/seat tilt
- 3 Head restraint/backrest tilt
- 4 Lumbar support

Adjusting the head restraint

Adjusting the height: manual head restraints

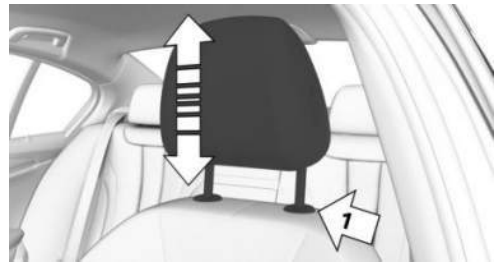

- ▶ To lower: press the button, arrow 1, and push the head restraint down.
- ▶ To raise: push the head restraint up.

Adjusting the height: M sport seat

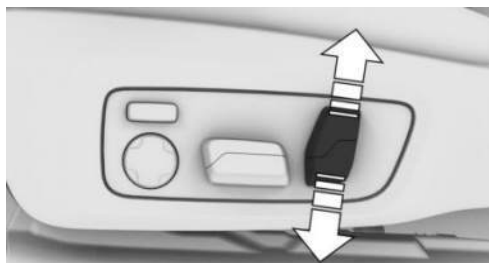

Press switch up or down.

Adjusting the distance



- ▶ Back: press the button and push the head restraint toward the rear.
- ▶ Forward: pull the head restraint toward the front.

Adjusting distance: M sport seat

The distance to the back of the head is adjusted via the backrest inclination.

Adjusting the exterior mirrors



Icon	Meaning
	Fold the exterior mirror in and out.
	Adjust the exterior mirrors.
	Select exterior mirror, Automatic Curb Monitor.

Adjusting the steering wheel position

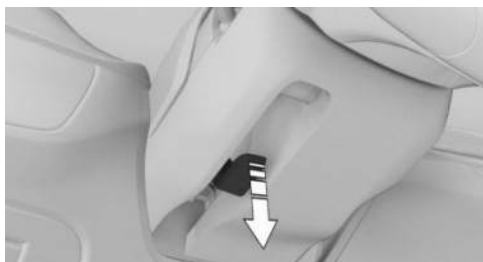

1. Fold the lever down completely.
2. Grip the steering wheel with both hands and move the steering wheel to the preferred height and angle to suit your seat position.
3. Fold the lever back up.

Memory function

Principle

The following settings can be stored and, if necessary, retrieved using the memory function:

- ▶ Seat position.
- ▶ Exterior mirror adjustment.
- ▶ Height of the Head-up display.

Overview



The memory buttons are located on the front doors.

Storing settings

1. Set the desired position.

2.  Press the button. The LED illuminates.
3. Press the desired memory button as long as the LED is illuminated. A signal sounds.

Calling up settings

Press the desired memory button 1 or 2.

Infotainment





Navigation destination input

1.  Navigation menu
2. "Destination input"
A search box and entered information such as the search history are displayed.
3. Select the desired entry or the search box.
4. When selecting the search box, enter characters or choose one of the POI categories displayed.
If necessary, select **OK** to display more information, e.g. to preview a map.
If necessary, accept the suggested search keywords.

5. Select the desired entry.
6. "Start guidance"

Entertainment

Depending on model variant, the center console or instrument panel provide the following operating elements:

Operating element	Function
	Turn the volume button to adjust the volume. Press the volume button to turn off sound output. Pressing the button again restores the previous volume setting.
	Change the entertainment source.
	Press once: changes the station/track.
	Press and hold: fast forward/rewind the track.

Using the mobile phone

General information

After the mobile phone is connected once to the vehicle, the mobile phone can be operated using iDrive and the steering wheel buttons. Activate Bluetooth® on the mobile phone.

Connecting via Bluetooth®

1.  Apps menu
2. "All apps"
3. "Mobile devices"
4. "Connect new device"

Mobile phones in range are displayed on the control display.

5. Select the desired mobile phone.
6. Compare the control number displayed on the control display with the control number in the display of the mobile phone, and confirm that they match.
7. If necessary, select the connection mode:
"Use Bluetooth®"

The device is connected and displayed in the device list.

Accepting a call

Depending on the equipment, incoming calls can be answered in several ways.

- ▷ Via iDrive:



 "Accept"



- ▷ Press the button on the steering wheel.

- ▷ Use the knurled wheel on the steering wheel to select from the list in the instrument cluster: "Accept"

Dialing a number

1.  Communication menu
2. "More"
3. "Dial number"
4. Enter the numbers.
5.  Select the icon. The connection is established via the mobile phone to which this function has been assigned.

On the road

Driving

Drive-ready state

General information

Activated drive-ready state is the equivalent of a running engine in conventional vehicles.

Turning on the drive-ready state

1. Close the driver's door.
2. Depress the brake pedal.
3. Press the Start/Stop button.

A signal tone sounds. Drive-ready state is switched on.

Display in the instrument cluster



The READY display indicates that the vehicle is ready for driving.

Turning off drive-ready state

After stopping the vehicle:

1. While the vehicle is stationary, depress the brake and engage selector lever position P.
2. Set the parking brake.
3. Press the Start/Stop button.

The READY indicator goes out and a signal tone sounds.

The drive-ready state is switched off automatically if the driver's seat belt is not buckled when the driver's door is opened.

Drive-ready state in detail

Functional requirements

Driving is possible when the following prerequisites are met:

- ▶ The state of high-voltage battery charge is sufficient.
- ▶ The driver's door is closed.
- ▶ Charging cable is detached.
- ▶ The charging socket cover is closed.

Driving

1. Turn on drive-ready state.
2. Apply the brake and engage selector lever position D, B, or R.
3. Release the parking brake.
4. Depress the accelerator pedal to drive.

Engaging selector lever position R, N, D, B



- ▶ R reverse gear.
- ▶ Neutral N.
- ▶ Gear position D.
- ▶ B gear position with the highest energy recovery.

To prevent the vehicle from creeping after you select a gear position or reverse gear, maintain pressure on the brake pedal until you are ready to drive off.

Engage selector lever position R only when the vehicle is stationary.

In selector lever position B, the vehicle will decelerate more than in selector lever position D when rolling to a stop.

Engaging selector lever position P



Engage selector lever position P only when the vehicle is stationary.





Press button P.

Parking brake

Setting the parking brake

-  Pull the switch.
-  The LED on the switch and the indicator light in the instrument cluster are illuminated.

Releasing the parking brake

-  With drive-ready state switched on:
-  Press the switch while stepping on the brake pedal or selector lever position P is set.

The LED and the indicator light go out.

The parking brake is released.

Parking

Make sure the parking brake is engaged.

Light and view

Turn signal, high-beam headlights, headlight flasher

Turn signal

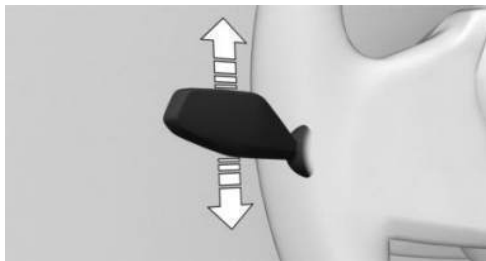

- ▶ Flashing: press the lever past the resistance point.
- ▶ One-touch signaling: lightly tap the lever up or down.
- ▶ Brief flashing: press the lever to the resistance point and hold it there for as long as you want the turn signal to flashing.

High-beam headlights, headlight flasher









Press the lever forward or pull it backward.

- ▶ High-beam headlights on, arrow 1.
The high-beam headlights illuminate when the low-beam headlights are switched on.
- ▶ High-beam headlights off/headlight flasher, arrow 2.

Lights and lighting

Buttons in the vehicle

Icon	Function
	Exterior lighting off. Daytime driving lights.
	Parking lights.
	Automatic headlight control. Adaptive lighting functions.
	Low-beam headlights.
	Instrument lighting.
	Right roadside parking light.
	Left roadside parking light.

Window wiper system

Turning on window wiper system

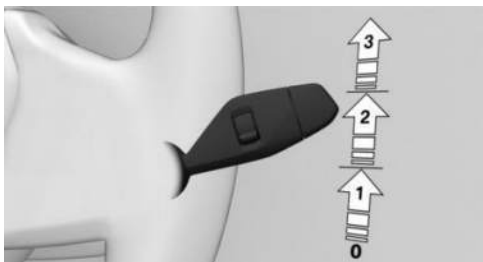

Press the lever up until the desired position is reached.

- ▷ Rest position of the wipers, position 0.
- ▷ Rain sensor mode, position 1.

- ▷ Normal wiper speed, position 2.
- ▷ Fast wiper speed, position 3.

Turning off the window wiper system and flick wipe

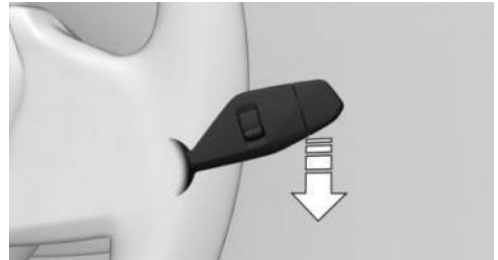

Press the lever down.

- ▷ Turning off: press the lever down until it reaches the 0 position.
- ▷ Flick wipe: press the lever down from the 0 position.

The lever automatically returns to its 0 position when released.

Activating/deactivating rain sensor

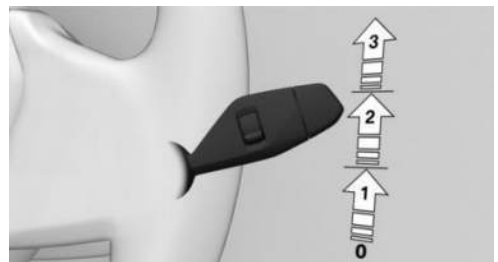

Enable: press lever up once from the 0 position, arrow 1.

Disable: press lever back into the 0 position.

Adjusting the rain sensor sensitivity

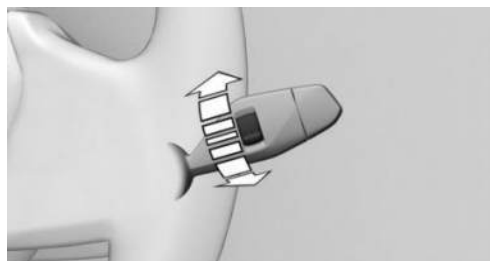

Turn the knurled wheel on the wiper lever.

Cleaning the windshield

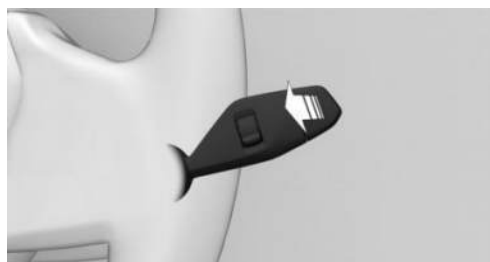

Pull the lever.

Climate control

Climate control functions



Functions in the Climate menu

Icon	Function
	Turn the climate control system on/off.
	Automatic program.
	Temperature.

Icon	Function
	Air conditioning.
	Maximum cooling.
	Air recirculation mode.
	Automatic recirculated-air control.
	Fresh air.
	Air flow.
	Air distribution.
	SYNC program.
	Seat heating.
	Active seat ventilation.

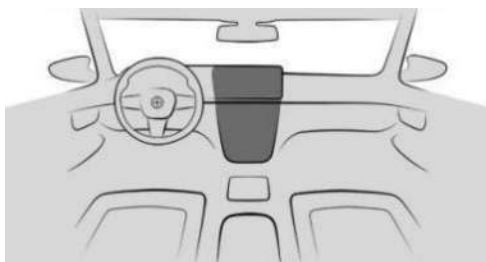



Buttons, automatic climate control

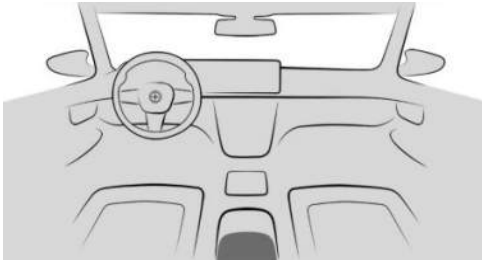

Icon	Function
	Defrost function.
	Rear window defroster.

Buttons, rear automatic climate control



Icon	Function
	Automatic program.
	Temperature.
	Air distribution.
	Seat heating.
	Switching off.

Intermediate stop

Charging the vehicle

Depending on national-market version, use a mode 2 charging cable, fast charging cable (mode 3), or the permanently installed cable of a charging station to charge the vehicle.

The charging cable can be stowed in the cargo area, for instance under the cargo floor panel or in a bag.

Before disconnecting and connecting a charging cable, clean the area between the charging socket flap and charging socket and the charging cable plug as necessary, for instance remove snow.

If necessary, unlock the charging cable before removing.

The charging status is indicated on the indicator light on the charging socket.

Keep the charging socket flap and, if necessary, the charging socket lid closed when the charging socket is not used.

Wheels and tires

Tire pressure specifications

The tire inflation pressure specifications can be found in the tire inflation pressure table in the printed Owner's Manual.

After correcting the tire pressure

If equipped with a Tire Pressure Monitor, the corrected tire pressures are applied automatically. Make sure that the correct tire settings have been made. With tires that cannot be found in the tire pressure values on the control display, reset the Tire Pressure Monitor (TPM). If equipped with a flat tire monitor, reinitialize the flat tire monitor.

Checking the tire pressure

Regularly check the tire inflation pressure and correct it as needed:

- ▷ At least twice a month.
- ▷ Before embarking on an extended trip.

Providing assistance

Hazard warning system

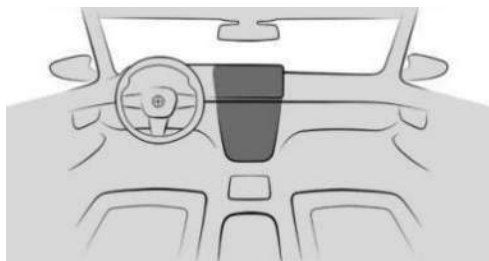

Hazard warning system button

ConnectedDrive

BMW Assistance

Contact BMW Assistance for information and support for all aspects of the vehicle.

1.  Apps menu
2. "All apps"
3. "BMW Assist"
4. If necessary, select the desired service.

A voice connection to the selected service is established.

BMW Teleservices

Teleservices are services that help to maintain vehicle mobility.

Teleservices can comprise the following services:

- ▷ BMW Roadside Assistance.
- ▷ BMW Accident Assistance.
- ▷ Teleservice Call.
- ▷ An authorized service center.

Dashboard

Vehicle features and options

This chapter describes model-specific equipment, systems, and functions that are currently

available, or may become available in the future, even if they are not present in the vehicle.

Additional information:

Vehicle equipment, refer to page 8.

In the vicinity of the steering wheel

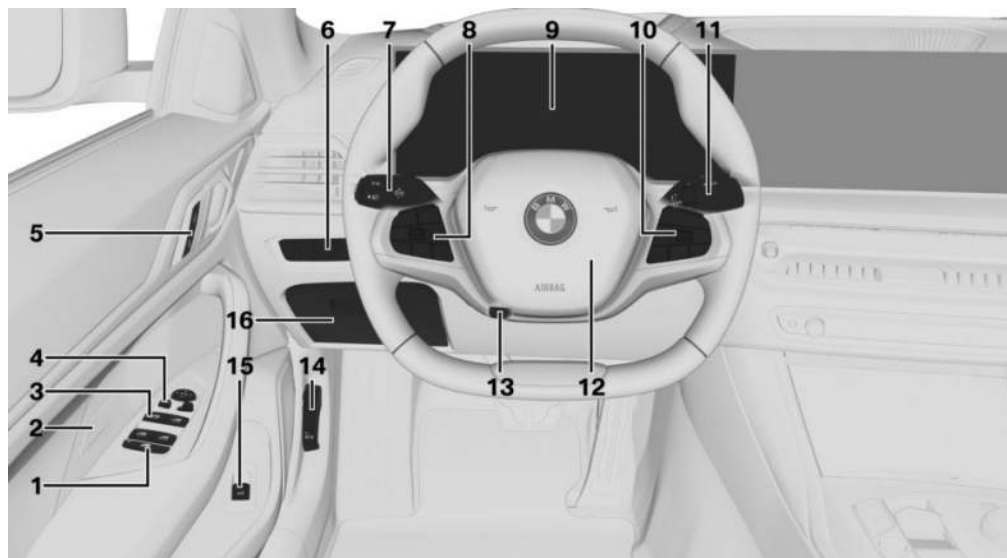

1  Safety switch 98

2 Seating comfort features

 Memory function 115

3  Power windows, individual 96

4 Exterior mirror adjustment button 112

5 Central locking system 91

 Unlocking

 Locking

6 Lights

 Light switch 159

 Exterior lighting off
Daytime driving lights 162



Parking lights [160](#)



Automatic headlight control [160](#)

Adaptive lighting functions [162](#)

Automatic High Beam Assistant
[158](#)



Low-beam headlights [160](#)



Instrument lighting [163](#)



Right roadside parking light [160](#)



Left roadside parking light [160](#)

7 Turn signal lever



Turn signal [157](#)



High-beam headlights, headlight flasher [157](#)



Automatic High Beam Assistant
[158](#)



Trip data [151](#)
G-Meter [154](#)

8 Steering wheel buttons, left



Manual Speed Limiter [205](#)



Depending on the equipment:
Cruise Control on/off [207](#)



Depending on the equipment:
Active Cruise Control on/off [210](#)



With Steering Assistant [220](#):
Cruise Control, Distance Control
and lane keeping on/off



Cruise Control: store the speed
Speed Limit Assistant: accept
suggested speed [217](#)



Interrupt or continue cruise control



Active Cruise Control: increase
distance



Active Cruise Control: reduce dis-
tance



Cruise Control rocker switch

9 Instrument cluster [136](#)

10 Steering wheel buttons, right



Displaying menu bar in instru-
ment cluster [136](#)



Volume, see Owner's Manual for
Navigation, Entertainment and
Communication [6](#)



Voice activation system [59](#)



Selecting menu contents in instru-
ment cluster [136](#)

Changing the station/track, see
Owner's Manual for Navigation,
Entertainment, Communication [6](#)



Telephone, see Owner's Manual for Navigation, Entertainment and Communication [6](#)



Knurled wheel for selecting configuration menus for instrument cluster and Head-up display [136](#)
Using infotainment selection lists in the instrument cluster [147](#)

11 Wiper lever



Wipers [165](#)



Rain sensor [166](#)



Cleaning the windshield [167](#)



12 Horn, entire surface

13 Adjusting the steering wheel [114](#)

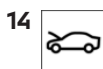

14 Unlocking the hood [331](#)

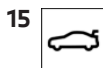

15 Opening and closing cargo area [84](#)





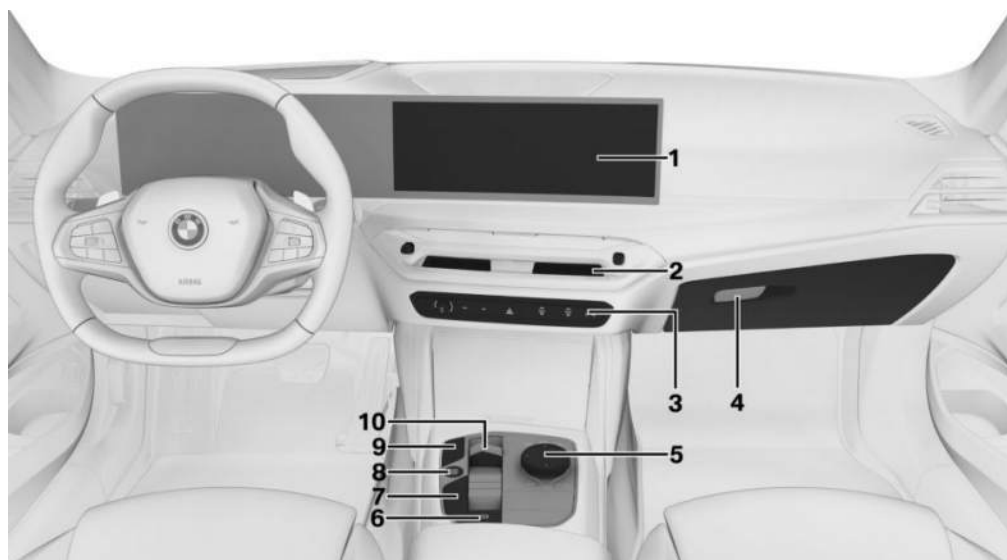









16 Fold-out compartment [268](#)

In the vicinity of the center console







1 Control display [54](#)

2 Ventilation [257](#)

- 3**  Hazard warning system [341](#)
- Climate control [248](#)
-  Defrost function [255](#)
-  Rear window defroster [255](#)
- Radio/multimedia, see Owner's Manual for Navigation, Entertainment, and Communication [6](#)
-  Adjusting the volume
-  Station/title forward
-  Station/title back
- 4** Button for glove compartment [267](#)
- 5** Controller with buttons [55](#)
- 6**  Automatic Hold [133](#)
-  Parking brake [132](#)
- 7**  Driving Experience Control [130](#)
SPORT drive mode
-  COMFORT drive mode
-  ECO PRO drive mode
- 8**  Turning drive-ready state on/off [123](#)
- 9**  Parking assistance systems [227](#)
-  Panorama view [234](#)
-  Dynamic Stability Control [199](#)
- 10** Selector lever [124](#)

In the vicinity of the headliner



- | | |
|--|--|
| <p>1  Emergency Call, SOS 343</p> | <p>4  Reading lights 164</p> |
| <p>2  Operating the electric glass sun-roof 99</p> | <p>5  Interior lights 164</p> |
| <p>3  Indicator light, front passenger airbag 171</p> | |

Sensors of the vehicle

Vehicle features and options

This chapter describes model-specific equipment, systems, and functions that are currently available, or may become available in the future, even if they are not present in the vehicle.

Additional information:

Vehicle equipment, refer to page 8.

Overview

Depending on the equipment, the following cameras and sensors are installed in the vehicle:

- ▶ Front camera.
- ▶ Camera behind the windshield.
- ▶ Top view cameras.
- ▶ Rearview camera.
- ▶ Front radar sensor.
- ▶ Radar sensors, side, front.
- ▶ Radar sensors, side, rear.
- ▶ Ultrasonic sensors in the front/rear bumpers.
- ▶ Ultrasonic sensors, side.

Cameras

Front camera

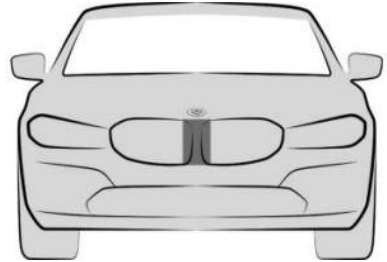

The front camera is located in the radiator grille.

Camera behind the windshield

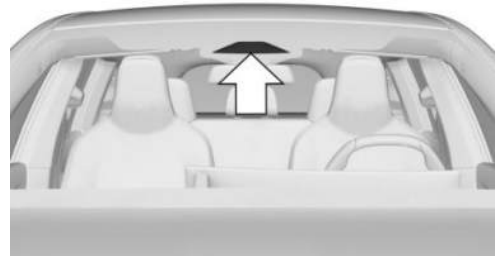

The camera behind the windshield is located near the interior mirror.



Top view cameras

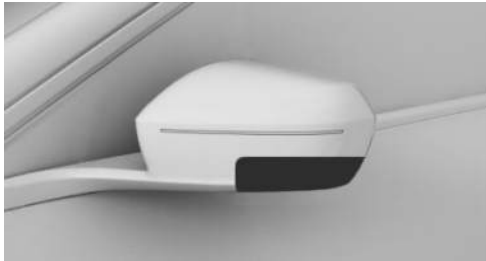

One exterior mirror camera is located at the bottom of each exterior mirror housing.

Rearview camera

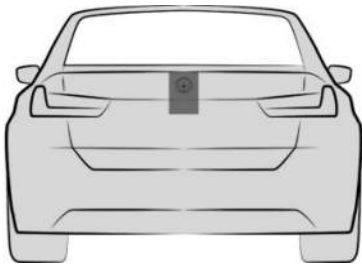

The rearview camera is located in the badge on the rear of the vehicle.

Functional requirement of the cameras

The areas of the cameras are clean and clear.

Additional information:

- ▶ Washing the vehicle, refer to page 349.
- ▶ Vehicle care, refer to page 351.

System limits of the cameras

The cameras may not work properly, e.g., show something that is incorrect, in the following situations:

- ▶ In heavy fog, wet conditions, or snowfall.
- ▶ On steep hills, in steep depressions or in tight curves.

- ▶ When the camera field of view is covered, for instance by a fogged up windshield or labels.
- ▶ If the camera lens is dirty or damaged.
- ▶ With exterior mirrors folded in.
- ▶ With open doors or open cargo area.
- ▶ When driving toward bright lights or strong reflections, e.g., setting sun.
- ▶ When it is dark outside.
- ▶ The camera has overheated due to excessive temperatures and temporarily turned off.
- ▶ During calibration of the camera immediately after vehicle delivery.

If applicable, a Check Control message will be displayed when the system limits are reached.

Radar sensors

Safety information

Warning

The vehicle radar sensors and thus also the driver assistance systems can be impaired by external influences, e.g., interference. There is a risk of accident, injury, or property damage. Watch the surrounding traffic situation closely, be ready to take over steering and braking at any time, and actively intervene where appropriate.

Front radar sensor



The front radar sensor is located in the front bumper.

Radar sensors, side, front



The radar sensors are located on the side of the front bumper.

Radar sensors, side, rear

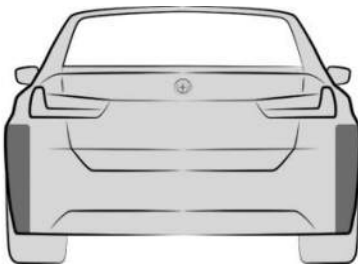

The radar sensors are located on the side of the rear bumper.

Functional requirement of the radar sensors

The areas of the radar sensors are clean and clear.

Additional information:

- ▶ Washing the vehicle, refer to page 349.
- ▶ Vehicle care, refer to page 351.

System limits of the radar sensors

The function of the radar sensors may be restricted or not available, for instance in the following situations:

- ▶ In case of dirty sensors.
- ▶ In case of iced-up sensors.
- ▶ If sensors are covered such as by labels, films or a license-plate carrier.
- ▶ If the sensor is not aligned correctly, for instance due to parking damage.
- ▶ If the radiation range of the sensors is covered, e.g., by protruding cargo.
- ▶ When the field of view of the sensors is covered, e.g., by garage walls, hedges, snow hills, vehicles or trailers.
- ▶ After improper paint work on the vehicle in the area of the sensors.
- ▶ On steep hilltops or in sharp dips in the road.

If applicable, a Check Control message will be displayed when the system limits are reached.

Ultrasonic sensors

Ultrasonic sensors, front

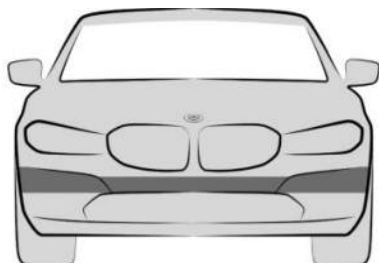

The ultrasonic sensors of the parking assistance systems are located in the front bumper.

Ultrasonic sensors, rear

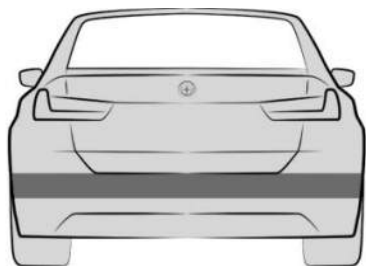

The ultrasonic sensors of the parking assistance systems are located in the rear bumper.

Ultrasonic sensors, side

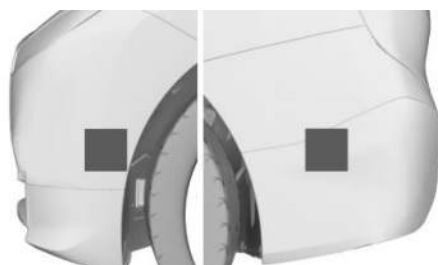

The ultrasonic sensors for the parking assistance systems are located on the sides of the front and rear bumpers.

Functional requirement of the ultrasonic sensors

The areas of the ultrasonic sensors are clean and clear.

Additional information:

- ▷ Washing the vehicle, refer to page 349.
- ▷ Vehicle care, refer to page 351.

System limits of the ultrasonic sensors

The detection of objects with ultrasonic measurements can run into physical limits, e.g., in the following situations:

- ▷ If the sensors are dirty or covered, e.g., by stickers.
- ▷ If the sensor is not aligned correctly, for instance due to parking damage.
- ▷ After improper paint work on the vehicle in the area of the sensors.
- ▷ For small children and animals.
- ▷ For persons with certain clothing, for instance jacket.
- ▷ With obstacles and persons at the edge of the lane.
- ▷ In case of external interference with the ultrasonics, for instance from passing vehicles, loud machines or other ultrasonic sources.
- ▷ Under certain weather conditions, e.g., high moisture, wet conditions, snowfall, cold, extreme heat, or strong wind.
- ▷ With tow bars and trailer hitches of other vehicles.
- ▷ With thin or wedge-shaped objects.
- ▷ With moving objects.
- ▷ With elevated, protruding objects such as ledges.
- ▷ With objects with corners, edges, and smooth surfaces.

- ▷ In the case of objects with fine surfaces or structures, e.g., wire mesh fences.
- ▷ For objects with porous surfaces.
- ▷ With small and low objects, for instance boxes.
- ▷ Low objects already displayed, for instance curbs, can be outside of the detection ranges of the sensors.
- ▷ With soft obstacles or obstacles covered in foam material.
- ▷ With plants and bushes.
- ▷ In automatic car washes.
- ▷ In the event of uneven floors, e.g. speed bumps.
- ▷ If there are large amounts of exhaust gas.
- ▷ Cargo that extends beyond the perimeter of the vehicle is not taken into account by the ultrasonic sensors.

If applicable, a Check Control message will be displayed when the system limits are reached.

Operating state of the vehicle

Vehicle features and options

This chapter describes model-specific equipment, systems, and functions that are currently available, or may become available in the future, even if they are not present in the vehicle.

Additional information:

Vehicle equipment, refer to page 8.

General information

Depending on the situation, the vehicle is in one of the three states:

- ▷ Idle state.
- ▷ Standby state.
- ▷ Drive-ready state.

Idle state

Principle

When the vehicle is in idle state, it is switched off.

General information

The vehicle is in idle state prior to opening from the outside and after exiting and locking.

Safety information

Warning

An unsecured vehicle can begin to move and possibly roll away. There is a risk of accident, injury, and property damage. Before leaving the vehicle, secure the vehicle against rolling away.

In order to ensure that the vehicle is secured against rolling away, follow the following:

- ▷ Set the parking brake.
- ▷ Automatic transmission: Make sure that selector lever position P is engaged.
- ▷ On uphill grades or on downhill slopes, turn the front wheels in the direction of the curb.
- ▷ On uphill grades or on downhill slopes, also secure the vehicle, for instance with a wheel chock.

Warning

Unattended children or animals in the vehicle can cause the vehicle to move and endanger themselves and traffic, for example, due to the following actions:

- ▷ Establishing standby.
- ▷ Releasing the parking brake.
- ▷ Opening and closing the doors or windows.
- ▷ Engaging selector lever position N.
- ▷ Using vehicle equipment.

There is a risk of accident, injury, and property damage. Do not leave children or animals unattended in the vehicle. Take the vehicle key with you when exiting and lock the vehicle.

Establishing the sleep mode automatically

The sleep mode is established automatically such as in the following situations:

- ▶ After several minutes, if no operation takes place on the vehicle.
- ▶ If the charge state of the vehicle battery is low.
- ▶ Depending on the configuration via iDrive: one or both front doors will be opened after driving when exiting the vehicle.

In some situations, the idle state is not set automatically, for instance during a phone call or when the low-beam headlights are switched on.

Establishing idle state when opening the front doors

After a trip, the sleep mode can be established by opening the front doors. For this purpose, all passengers must exit the vehicle.

1.  Apps menu
2. "Vehicle"
3. "Doors and windows"
4. "Lock/unlock"
5. "Turn off after opening door"

Establishing the sleep mode manually

To establish idle state in the vehicle after completion of trip:



Press and hold the volume button on the radio until all displays go out.

Standby state

Principle

When standby state is switched on, most functions can be used while the vehicle is stationary. Desired settings can be adjusted.

General information

The vehicle is in standby state after the front doors are opened from the outside.

To preserve the vehicle battery, use standby and the activated power consumers only as long as absolutely necessary.

Manually setting to standby

General information

Standby can be switched back on after the vehicle is automatically set to idle state.

Via the volume button



Press the volume button on the radio. The control display and the instrument cluster illuminate.

Using the Start/Stop button



Press the Start/Stop button.

The control display and the instrument cluster illuminate.

Display in the instrument cluster



OFF is displayed in the instrument cluster. Drive-ready state is turned off and standby state turned on.

Drive-ready state

General information



Drive-ready state is turned on/off using the Start/Stop button.



Activated drive-ready state is the equivalent of a running engine in conventional vehicles.

Deactivated drive-ready state is equivalent to switching the engine off.

If the drive-ready state is turned on, the vehicle ready to drive and READY is displayed in the instrument cluster.

All vehicle systems are ready for operation.

To preserve the vehicle battery, switch off drive-ready state and any unnecessary power consumers when parked.

Safety information

Warning

When driving in electric mode, pedestrians and other road users might pay less attention to the vehicle due to the lack of engine noise. There is a risk of accident, injury, and property damage. Adjust driving style to traffic conditions. Watch surrounding traffic closely and actively intervene where appropriate

Warning

An unsecured vehicle can begin to move and possibly roll away. There is a risk of accident, injury, and property damage. Before leaving the vehicle, secure the vehicle against rolling away.

In order to ensure that the vehicle is secured against rolling away, follow the following:

- ▷ Set the parking brake.
- ▷ Automatic transmission: Make sure that selector lever position P is engaged.
- ▷ On uphill grades or on downhill slopes, turn the front wheels in the direction of the curb.
- ▷ On uphill grades or on downhill slopes, also secure the vehicle, for instance with a wheel chock.

Warning

Unattended children or animals in the vehicle can cause the vehicle to move and endanger themselves and traffic, for example, due to the following actions:

- ▷ Establishing standby.
- ▷ Releasing the parking brake.
- ▷ Opening and closing the doors or windows.
- ▷ Engaging selector lever position N.
- ▷ Using vehicle equipment.

There is a risk of accident, injury, and property damage. Do not leave children or animals unattended in the vehicle. Take the vehicle key with you when exiting and lock the vehicle.

NOTICE

Selector lever position P is automatically engaged when standby state is switched off. The wheels are blocked. There is a risk of property damage. Do not switch off standby if the vehicle is meant to coast, e.g., in a car wash.

Turning on the drive-ready state

1. Close the driver's door.
2. Depress the brake pedal.
3. Press the Start/Stop button.

Most of the indicator lights and warning lights on the instrument cluster illuminate for different lengths of time.

READY is displayed in the instrument cluster and a signal tone sounds.

Drive-ready state is switched on.

Display in the instrument cluster



When the drive-ready state is switched on, READY is displayed in the instrument cluster.

Turning off drive-ready state

After stopping the vehicle:

1. While the vehicle is stationary, depress the brake and engage selector lever position P.
2. Set the parking brake.
3. Press the Start/Stop button.

The READY indicator goes out and a signal tone sounds.

The drive-ready state is switched off automatically if the driver's seat belt is not buckled when the driver's door is opened.

BMW iDrive

Vehicle features and options

This chapter describes model-specific equipment, systems, and functions that are currently available, or may become available in the future, even if they are not present in the vehicle.

Additional information:

Vehicle equipment, refer to page 8.

Display and operating concept

Principle

BMW iDrive is the vehicle's display and operating concept and includes a wide range of functions.

General information

Depending on vehicle equipment, the functions can be operated as follows:

- ▶ Via the control display.
- ▶ Via the Controller.
- ▶ Via the touchpad.
- ▶ Via the BMW Intelligent Personal Assistant.
- ▶ Via the operating elements on the steering wheel.

Additional information:

Instrument cluster, refer to page 136.

Safety information

Warning

Operating the integrated information systems and communication devices while driving can distract from surrounding traffic. It is possible to lose control of the vehicle. There is a risk of

accident, injury, and property damage. Only use the systems or devices when the traffic situation allows. As warranted, stop and use the systems and devices while the vehicle is stationary.

Main menu

General information

The main menu is divided into different areas.

Overview

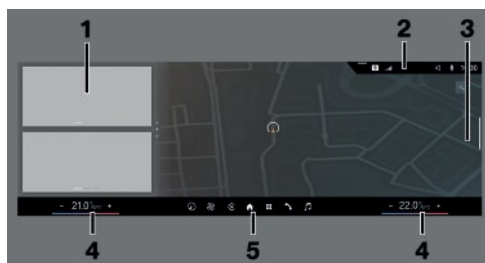

- 1 Widgets
- 2 Status information
- 3 Configuration bar for main display
- 4 Temperature setting
- 5 Menu bar

Menu bar

Apps menu

 Access to apps and vehicle functions. A filter can be selected. If necessary, change the filter to see the apps you want.

- ▶ "All apps": All apps and functions are displayed.
- ▶ "Infotainment": Only infotainment apps are displayed.

- ▷ "Vehicle": Only vehicle adjustment functions are displayed.
- ▷ "Recently used": The most recently used apps are displayed.

Media menu

 Access to functions of the entertainment system, e.g., radio stations or connection with external devices.

Communication menu

 Access to the telephone and message function as well as the connection and management of mobile devices such as smartphones.

Navigation menu

 Access to the navigation system, destination input and traffic bulletins. Configurable map views and other functions such as points of interest.

Climate menu

 The Climate menu provides access to all climate control functions.

Apple CarPlay® menu

 Depending on the national-market version with a connected function: access to Apple CarPlay. Apple CarPlay enables the secure use of certain functions of a compatible Apple iPhone via iDrive.

Android Auto™ menu

 Depending on the national-market version with a connected function: access to Android Auto. Android Auto enables the secure use of certain functions of a compatible Android smartphone via iDrive.

Widgets

Widgets show real-time information and dynamic content such as current media or paired

smartphones. The widgets also serve as buttons and allow jumping to the relevant menu.

Main display



The main display shows real-time information and dynamic content such as the navigation map. This display also contains buttons and lets you jump to the desired menu.

Status information









General information

The status field can be found in the upper area of the control display. Status information is displayed in the form of icons. Depending on the equipment and national-market version, different icons are available.

Telephone status information

Icon	Meaning
	Active call.
	Signal strength.
	SIM card missing.

Entertainment status information

Icon	Meaning
	USB audio.
	Bluetooth audio.
	Smartphone audio.
	Connected Music with Spotify.
	Time shift.
	Wi-Fi.
	Apple CarPlay.
	Android Auto.
	Satellite radio is switched on.

Status information messages

Icon	Meaning
	Number of notifications.
	Check Control message.
	Suppress private information.
	Do not disturb.
	Message.

Additional information:

Owner's Manual for Navigation, Entertainment, and Communication, refer to page 6.

Other status information

Icon	Meaning
	Sound output active.
	Sound output deactivated.
	Activation word active.
	BMW ID or driver profile.
	Destination guidance active.
	Go to quick access.
	Wireless charging active.
	Park Distance Control: sound active.
	Park Distance Control: sound deactivated.

Input and display

Letters and numbers

Letters and numbers can be entered using the controller, touchpad, control display, or voice control, depending on vehicle equipment.

Icon	Function
	Change between capital and lower-case letters.
	Enter a blank space.
	Switching between languages.
	Use voice control.
	Confirm entry.
	Shift the input area to the left or right.

Entry comparison

When entering data from a database such as contacts, the selection is gradually narrowed down for each character entered, with characters being added as necessary.

Activating/deactivating the functions

Some menu items are preceded by an icon. Selecting the menu item enables or disables the function.

Icon	Meaning
	Function is activated.
	Function is deactivated.

Enabling/disabling audible feedback

For some functions, audio confirmation is given, e.g., sounds are emitted when operating the control display.

- Apps menu
- "Vehicle"
- "System settings"
- "Sound"
- Select the desired setting.

Quick access

The quick link provides access to shortcuts, certain settings, and app recommendations.

Input	Operation
Show quick link.	<p>Swipe from top to bottom on the control display.</p> <p>Slide the controller up.</p> <p>— Tap the icon on the status bar.</p>
Hide quick link.	<p>Swipe from the bottom up on the control display.</p> <p>Slide the controller down.</p>

Activating/deactivating pop-ups

For some functions, pop-ups are displayed automatically on the control display. Some of these pop-ups can be activated or deactivated.

1.  Apps menu
2. "Vehicle"
3. "System settings"
4. "Pop-ups"
5. Select the desired setting.

Shortcuts

General information

The iDrive functions can be stored on the shortcuts and called up directly, for instance radio stations, navigation destinations, phone numbers and menu entries.

Storing a function

1. Select the desired function.
2. Press and hold the desired function.
3. "Add to shortcuts"

Shortcuts can only be created with an active BMW ID or a driver profile.

Executing a function

1. Swipe from top to bottom on the control display.
2. Tap the desired shortcut.

The function will work immediately. This means for instance that the connection is established when a phone number is selected.

Deleting shortcuts

1. Swipe from top to bottom on the control display.
2. Press and hold the desired shortcut.
3. "Delete shortcut"

BMW Curved Display

Principle

The BMW Curved Display is a single-screen display in the instrument panel that is curved towards the driver. The BMW Curved Display comprises the instrument cluster on the driver's side and the control display.

General information

Follow instructions for cleaning the BMW Curved Display in the Care chapter.

Additional information:

Caring for special components, refer to page [352](#).

Overview



- 1 Instrument cluster [136](#)
- 2 Control display [54](#)

Control display

Principle

The iDrive functions are displayed on the control display.

Safety information

Warning

When driving, loose items or devices connected to the vehicle with a cable, i.e., mobile phones, may be thrown around the vehicle, e.g., in the event of an accident or when braking or performing evasive maneuvers. There is a risk of injury and risk of property damage. Secure loose objects or devices that are connected to the vehicle via a cable.

Warning

Objects in the area in front of a display can slip and damage the display. There is a risk of injury and risk of property damage. Do not place objects in the area in front of a display.

Overview

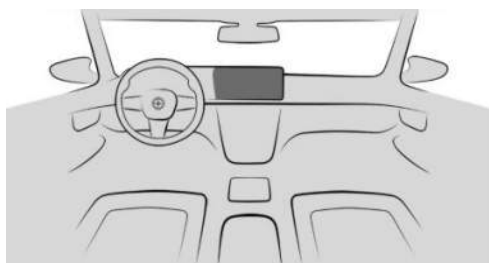

Control display.

Switching the control display on/off automatically

The control display is turned on automatically when the vehicle is unlocked or as soon as the control display is needed for operation.

In certain situations, the control display is switched off automatically, for instance if no operation is performed on the vehicle for several minutes.

Switching the control display on/off manually

1. Swipe from top to bottom on the control display.
2. "Screen off"

Tap the control display to turn it on again.

Setting the brightness

1.  Apps menu
2. "Vehicle"
3. "Displays"
4. "Control display"
5. "Brightness at night"
6. Make the desired setting.

Depending on the light conditions, the brightness control may not be clearly visible.

System limits

In the case of very high temperatures on the control display, for instance due to intense solar radiation, the brightness may be reduced down to complete deactivation. Once the temperature is reduced, for instance through shade or air conditioning system, the normal functions are restored.

Controller

Principle

The Controller can be used to select menu items and enter the settings. The buttons can be used to open the menus directly.

Overview

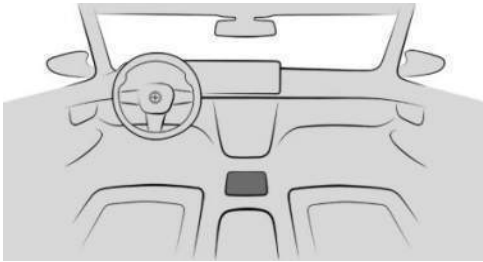

Controller

Buttons on the Controller

Button	Function
HOME	Call up the main menu.
MEDIA	Call up the Media/Radio menu.
TEL	Go to Phone menu.
MAP	Call up the navigation map.
NAV	Call up the destination input menu for navigation.
BACK	Go to previous menu.
OPTION	Call up the Options menu.

Operation

- ▶ Rotate the Controller to switch between menu options, for example.

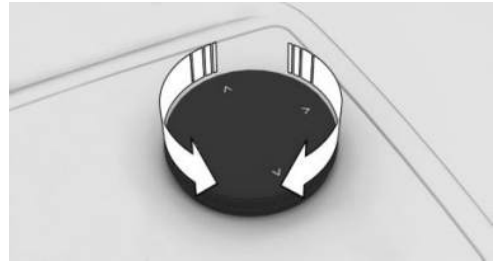

- ▶ Press the Controller to select a menu option, for example.

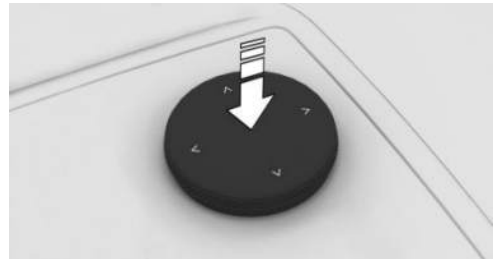

- ▶ Slide the Controller in four directions to switch between menus, for example.

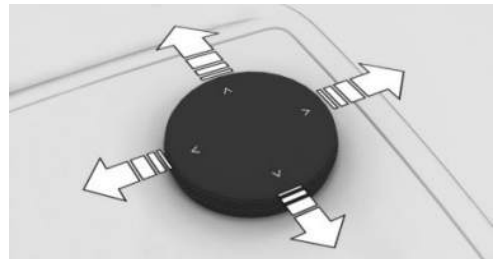

Operating via the Controller

Opening the main menu

- HOME Press the button.

HOME

The main menu is displayed.



Selecting menu items

1. Turn the Controller until the desired menu item is highlighted.
2. Press the Controller.

Adjusting the main display

The main display can be adjusted in the main menu.



1. Press the button.
2. If necessary, tilt the Controller to select the main display.
3. Tilt the Controller to the right.
4. Select the desired main display.

Selecting a widget

1. Use the Controller to select widgets.
2. If necessary, turn the Controller until the desired widget is selected.
3. Press the Controller.

Adjusting widgets

The widgets can be adjusted in the main menu. The adjustments can only be performed when the vehicle is stationary.



1. Press the button, if needed .
2. Using the Controller, select the widget, then press and hold the Controller.
3. The following adjustments can be made:
 - ▷ "Add widget below"
A new widget can be added below the selected widget.
 - ▷ "Delete widget page"
The widget is deleted.
 - ▷ "Sort widgets"
The widget can be moved to the desired position.

A new widget can be added at the end of the list.

- + Tap the icon at the end of the list.

Switching between menus

A new display opens after a menu item is selected.

- ▷ Slide the Controller to the left.
The current menu closes and the previous menu is displayed.



- ▷ Press the button.
The current menu closes and the previous menu is displayed.

Calling up the context menu

Depending on the menu item, a context menu with additional options can be displayed.

1. Select the desired menu item using the Controller.
2. Press and hold the Controller.

The menu consists of various areas, for instance:

- ▷ "General help": Go to the Integrated Owner's Manual.
- ▷ "Add to shortcuts": define menu item as shortcut.

Entering letters and numbers

Letters and numbers can only be entered when stationary.



Input

1. Turn the Controller: select letters or numbers.
2. **OK** : confirm entry.

Additional information:

Setting the system language, refer to page [62](#).

Deleting an entry

Icon	Function
	Press Controller: delete a letter or number.
	Hold the Controller down: delete all letters or numbers.

Using alphabetical lists

For alphabetical lists with more than 30 entries, the letters for which an entry exists can be displayed in a text box.

1. Turn the Controller to the left or right quickly.
2. Select the first letter of the desired entry.
The first entry of the selected letter is displayed in the list.

Operation via touchpad

General information

Depending on vehicle equipment, some iDrive functions can be operated with the controller touchpad.

The touchpad is located on the Controller. Touch the touchpad with your fingers. Do not use any objects.

Selecting functions

1.  Apps menu
2. "Vehicle"
3. "System settings"
4. "Touchpad"
5. Select the desired setting.

Entering letters and numbers

- ▶ Enter characters as they are displayed on the control display.
- ▶ Always enter associated characters such as accents or periods so that the letter can be clearly recognized.
- ▶ The set language determines what input is possible. Where necessary, enter special characters via the Controller.

Additional information:

Setting the system language, refer to page 62.

Entering special characters

Function	Operation
Delete a character.	Swipe to the left on the touchpad.
Enter a blank space.	Swipe to the right in the center of the touchpad.
Enter a hyphen.	Swipe to the right in the upper area of the touchpad.
Enter an underscore.	Swipe to the right in the lower area of the touchpad.

Using the map

The map in the navigation system can be moved via the touchpad.

Tap the map on the control display and then continue operation using the touchpad.

Function	Operation
Move map.	Swipe in the appropriate direction.
Display menu.	Tap once.

Using alphabetical lists

Alphabetical lists with more than 30 entries permit a direct jump to letters for which an entry exists.

Enter the first letter on the touchpad.

The first entry of the entered letter is displayed in the list.

Operation via control display

General information

Depending on the equipment version, the control display is equipped with a touchscreen.

You can tap on menu items and widgets. Touch the control display with your fingers. Do not use any objects.

Opening the main menu

 Tap on the icon.

The main menu is displayed.

Adjusting the main display

The main display can be adjusted in the main menu.

1.  Tap on the icon.
2. Swipe the configuration bar on the right side of the screen to the left.
3. Select the desired main display.

Switching between widgets

Widgets in the main menu display dynamic information and can be used as buttons.

To switch between widgets, scroll up or down through the widgets.

To display additional functions of the widgets, scroll left or right within the widgets.

Adjusting widgets

The widgets can be adjusted in the main menu. The adjustments can only be performed when the vehicle is stationary.

1. If necessary,  tap the icon.
2. Press and hold the widget.
3. The following adjustments can be made:
 - ▷ "Add widget below"
A new widget can be added below the selected widget.
 - ▷ "Delete widget page"
The widget is deleted.
 - ▷ "Sort widgets"
The widget can be moved to the desired position.

A new widget can be added at the end of the list.

 Tap the icon at the end of the list.

Sorting apps

To resort the app icons, press and hold the desired icon and move it to the desired location.

Switching between menus

A new display opens after a menu item is selected.

 Select the arrow symbol.

The current menu closes and the previous menu is displayed.

Calling up the context menu

Depending on the menu item, a context menu with additional options can be displayed.

Press and hold the desired menu item.

The menu consists of various areas, for instance:



- ▷ "General help": Go to the Integrated Owner's Manual.
- ▷ "Add to shortcuts": define menu item as shortcut.

Entering letters and numbers

Input

1. If necessary, tap the  icon or control display.
2. Enter desired letters and numbers.

Deleting an entry

Icon	Function
	Tap icon: delete a letter or a number.
	Press and hold the icon: delete all letters or numbers.

Using the map

The navigation map can be moved on the control display.

Function	Operation
Move map.	Swipe in the appropriate direction.
Enlarge/shrink map.	Drag in or out with the fingers.
Display menu.	Tap once.

Using alphabetical lists

For alphabetical lists with more than 30 entries, the letters for which an entry exists can be displayed in a text box.

1. Tap the letter in front of the list.
A letter box is displayed.
2. Tap the first letter of the desired entry.
The first entry of the selected letter is displayed in the list.

BMW Intelligent Personal Assistant

Principle

The BMW Intelligent Personal Assistant is a personal assistant that enables natural voice operation of various vehicle functions. The Personal Assistant makes it easier to operate the vehicle by providing proactive suggestions and automating habits.

General information

- ▶ BMW Intelligent Personal Assistant is available depending on national-market version.
- ▶ The system includes special microphones on the driver side and the front passenger side.
- ▶ Say the commands and numbers fluently as well as with normal volume, emphasis, and speed.
- ▶ >...< identifies commands that can be spoken.

Functional requirements

- ▶ A language that is supported by the Personal Assistant must be set via iDrive.
Setting the system language, refer to page 62.
- ▶ Always say commands in the configured system language.

For the full range of functions, you must activate, configure, or purchase the following functions:

- ▶ Online speech processing, refer to page 62.
- ▶ For all settings under Data protection, refer to page 70.
- ▶ Activation word, refer to page 60.
- ▶ BMW ID or a driver profile.

- ▶ Relevant ConnectedDrive services from the ConnectedDrive Store.
- ▶ Suggestions, refer to page 62.

Activating the voice control system

General information

There are various methods for activating the voice control feature:



- ▶ Press the button on the steering wheel briefly.
The microphone on the driver's side is active.
- ▶ Speaking the activation word.
The microphones on the driver's or front passenger's side are active with the following voice control, depending on where the activation word was spoken.

Then say the command. The activation word and the command can be spoken without pause in one sentence.

Microphone button on steering wheel



1. Press button briefly.
2. Say the command.

Activation word

General information

Saying the activation word will start the Personal Assistant. The Personal Assistant listens.

Preset activation word

>Hello BMW<: The default activation word can be activated and deactivated.

1.  Apps menu
2. "Vehicle"
3. "System settings"

4. "Voice control"
5. "Personal Assistant (BMW)"
6. "Wake word"
7. ""Hello BMW""

Personal activation word

In addition to the preset activation word, a personal activation word can be set up with an active BMW ID or a driver profile. The personal activation word can also be changed or deleted.

The activation word should consist of multiple syllables to ensure good recognition.

>Hello<: The additional phrase is not necessary for the activation word and does not need to be spoken.

1.  Apps menu
2. "Vehicle"
3. "System settings"
4. "Voice control"
5. "Personal Assistant (BMW)"
6. "Wake word"
7. "Personal wake word"
8. "Set"
9. "Start recording"

Activation word from third-party providers

Depending on national-market version, some third-party providers offer digital voice assistants, e.g., Amazon Alexa.

To use Siri, the smartphone must be connected via Apple CarPlay.

Supported voice assistants can be used with a connected smartphone in the vehicle.

The activation word from connected third-party providers can be used in addition to your preset or personal activation word from BMW.

1.  Apps menu
2. "Vehicle"
3. "System settings"

4. "Voice control"
5. "Additional speech assistants"
6. Select the desired setting.

Canceling voice control



- ▷ Press the button on the steering wheel again.
- ▷ >Cancel<
- ▷ Slide the Controller to the right or left.
- ▷ Press the Controller.

Possible commands

General information

Commands can be used to give instructions or ask questions, with the Personal Assistant providing assistance.

For example, you can call contacts, navigate to an address, apply settings, or ask questions about a vehicle function. Most vehicle functions can be operated via voice commands, e.g., the Automatic Parking Assistant.

Most content on the control display can be spoken as commands, e.g., menu items or list entries.

Help for voice control

- ▷ >Voice commands<: have possible example commands suggested.
- ▷ >General information on voice control<: have information on the operating principle of the voice control announced.
- ▷ >Help<: have tips and example commands for voice control announced.
- ▷ Additional example commands for the current context are displayed in the widget of the BMW Intelligent Personal Assistant.

Sample commands

- ▷ >Call John Smith<
- ▷ >Drive me to JFK airport<
- ▷ >Play a classical music station<
- ▷ >Is my tire pressure still OK?<
- ▷ >Activate the climate control<
- ▷ >Increase the ACC distance<
- ▷ >Sport mode<

Additional example commands can be displayed on the control display.

1.  Apps menu
2. "All apps"
3. "Personal Assistant"
4. "Help"
5. "Example commands"

Sample commands for the current context are displayed in the BMW Intelligent Personal Assistant widget.

Additional information:

Adjust widgets, refer to page [58](#).

Menu items

The Personal Assistant can bring up menu items directly. Say the menu items as they are displayed on the control display. You do not have to follow the order of the menu items when speaking them out loud.

1. Activate the voice control system.
2. >Media<
3. >Presets<

The stored stations are displayed on the control display.

Owner's Manual via voice operation

You can ask simple questions about vehicle functions and the operation of the vehicle.

The voice activation system and the feedback it provides do not replace the printed or Integrated Owner's Manual. The function

is available depending on the national-market version. The speech recognition and quality of the feedback may vary.

Example command: ›How can the passenger airbag be deactivated?‹

The Personal Assistant returns feedback. When stationary, the section of the integrated Owner's Manual is displayed on the control display.

Settings

Setting the system language

1.  Apps menu
2. "Vehicle"
3. "System settings"
4. "Language"
5. Select the desired setting.

Setting the response length

You can set the Personal Assistant to use standard dialog or a short version. In case of the short version, the announcements by the Personal Assistant are played back in an abbreviated version.

1.  Apps menu
2. "Vehicle"
3. "System settings"
4. "Voice control"
5. "Personal Assistant (BMW)"
6. "Response length"
7. Select the desired setting.

Speaking during voice output

It is possible to answer during inquiries of the Personal Assistant. The function can be disabled if requests are often canceled unintentionally, for instance due to background noise or conversations in the vehicle.

tionally, for instance due to background noise or conversations in the vehicle.

1.  Apps menu
2. "Vehicle"
3. "System settings"
4. "Voice control"
5. "Personal Assistant (BMW)"
6. "Speaking during voice output"

Suggestions

General information

The Personal Assistant provides helpful, individual suggestions.

Activating/deactivating suggestions

1.  Apps menu
2. "Vehicle"
3. "System settings"
4. "Voice control"
5. "Personal Assistant (BMW)"
6. "Receive suggestions"

Adapting suggestions

Suggestions can be adapted, for example, by category or to output a signal tone.

1.  Apps menu
2. "Vehicle"
3. "System settings"
4. "Voice control"
5. "Personal Assistant (BMW)"
6. Select the desired setting.

Online speech processing

Online speech processing improves the quality of the speech recognition and search results for points of interest. To use the functions, data is transmitted to a service provider via an encrypted connection and stored locally there. An active ConnectedDrive contract is required

for online voice processing. ConnectedDrive is available depending on the national-market version. Online speech processing is not available in all languages.

1.  Apps menu
2. "Vehicle"
3. "System settings"
4. "Voice control"
5. "Personal Assistant (BMW)"
6. "Online speech processing"

Configuring the visualization

How the Personal Assistant is visualized can be set.

1.  Apps menu
2. "Vehicle"
3. "System settings"
4. "Voice control"
5. "Personal Assistant (BMW)"
6. "Visualization"

Voice control from third-party providers

Depending on vehicle equipment, third-party voice control can be enabled by pressing and holding the microphone button on the steering wheel.

1.  Apps menu
2. "Vehicle"
3. "System settings"
4. "Voice control"
5. "Long press"
6. Select the desired setting.

Adjusting the volume

Turn the volume button during the voice guidance until the desired volume is set.

The volume remains constant even if the volume of other audio sources is changed.

Using the voice activation of the smartphone

Depending on the device, a smartphone connected to the vehicle can be used via voice control.

The device must be connected via Apple CarPlay or Android Auto.



1. Press and hold the  button on the steering wheel for approx. 3 seconds.

The voice activation of the smartphone is activated.

If activation is successful, a confirmation appears on the control display.



2. Press and hold the  button on the steering wheel to cancel voice control of the smartphone.

Automating routines

General information

The Personal Assistant can automate routines, for instance the automatic opening of windows in the same place. Rules are created for this purpose, which can be activated and deactivated at any time.

Activating/deactivating routines

1.  Apps menu
2. "All apps"
3. "Automate habits"
4. Select the desired setting.

System limits

- ▶ The Personal Assistant provides information about vehicle functions that may not be installed in the vehicle.

This also applies to safety functions and systems.

- ▷ Certain noises can be detected and may lead to problems. Keep the doors and windows closed.
- ▷ Noises from the front passenger or occupants can impair the system. Avoid making other noise in the vehicle while speaking.
- ▷ Major language dialects can cause problems with the speech recognition feature.
- ▷ A poor data connection affects the response time of the Personal Assistant and search function.



Connecting mobile devices to the vehicle

Principle

Various connection modes are available for using mobile devices in the vehicle. The connection mode to select depends on the mobile device and desired function.

General information

Detailed information on the functions and connection modes is provided in the following media from the Owner's Manual under the specified keyword:

Function	Connection mode	Icon on the control display
Making calls via the hands-free system. Using phone functions via iDrive. Keyword: calling via Bluetooth.	Bluetooth. Keyword: Bluetooth connection.	
Playing music from a mobile device. Keyword: audio.	Bluetooth audio. Keyword: Bluetooth connection.	 

- ▷ Integrated Owner's Manual in the vehicle.
- ▷ Printed Owner's Manual for navigation, communication and entertainment.

The following information sources can also be used:

- ▷ Driver's Guide app.
- ▷ Driver's Guide Web.







Safety information

Warning

Operating the integrated information systems and communication devices while driving can distract from surrounding traffic. It is possible to lose control of the vehicle. There is a risk of accident, injury, and property damage. Only use the systems or devices when the traffic situation allows. As warranted, stop and use the systems and devices while the vehicle is stationary.

Overview

The following overview shows possible functions and suitable connection modes for them. The range of functions depends on the vehicle equipment and the mobile device.

Function	Connection mode	Icon on the control display
Calling without a mobile phone. Keyword: calling with the Personal eSIM.	Personal eSIM. Keyword: Personal eSIM.	 
Data exchange between mobile device and vehicle.	Wi-Fi. Keyword: vehicle WLAN.	
Use Internet access via the personal hotspot.	Wi-Fi via personal hotspot. Keyword: personal hotspot.	
Using Apple CarPlay via iDrive and via voice control. Keyword: Apple CarPlay preparation.	Bluetooth and Wi-Fi. Keyword: Bluetooth connection and vehicle Wi-Fi.	
Using Android Auto via iDrive and via voice control. Keyword: Android Auto preparation.	Bluetooth and Wi-Fi. Keyword: Bluetooth connection and vehicle Wi-Fi.	
Playing music from a USB device. Keyword: audio.	USB. Keyword: USB connection. Additional information: USB port, refer to page 263 .	



BMW Remote Software Upgrade

Vehicle features and options

This chapter describes model-specific equipment, systems, and functions that are currently available, or may become available in the future, even if they are not present in the vehicle.

Additional information:

Vehicle equipment, refer to page 8.

BMW Remote Software Upgrade

Principle

Remote Software Upgrade can be used to update the entire software of the vehicle. This makes new functions, functional enhancements or quality improvements available.

General information

BMW recommends performing the Remote Software Upgrade as soon as it becomes available.

Safety information

Warning

Unattended children or animals in the vehicle can cause the vehicle to move and endanger themselves and traffic, for example, due to the following actions:

- ▷ Establishing standby.
- ▷ Releasing the parking brake.
- ▷ Opening and closing the doors or windows.
- ▷ Engaging selector lever position N.
- ▷ Using vehicle equipment.

There is a risk of accident, injury, and property damage. Do not leave children or animals unattended in the vehicle. Take the vehicle key with you when exiting and lock the vehicle.

Functional requirements

- ▷ Active ConnectedDrive contract.
- ▷ The integrated SIM card in the vehicle has been activated.
- ▷ Cellular network reception.
- ▷ Consent to transmit the corresponding data was given in the Data Protection menu.

Additional information:

Data protection, refer to page 70.

Search for an upgrade

Functional requirement

Standby must be turned on to search for a Remote Software Upgrade.

Automatic search

The vehicle regularly searches for updates in the background.

Manual search

1.  Apps menu
2. "All apps"
3. "System settings"
4. "Remote Software Upgrade"
5. "Search for upgrades"
6. Follow the instructions on the control display.

Download of an upgrade

Automatic download

If available, the data for a Remote Software Upgrade is automatically downloaded to the vehicle. No download consent is required.

Via My BMW App

If an upgrade is available, information on the new software version is displayed in the My BMW App.

The data for the upgrade can then be downloaded to a mobile device, for instance via an existing WLAN connection.

Data can then be sent from the mobile device to the vehicle.

This transmission method accelerates the download of the data, for instance in areas with limited mobile network availability.

You do not need to be present in the vehicle to download the data to a mobile device.

1. Download the upgrade using the My BMW App on your smartphone.
2. Follow the instructions in the My BMW App.
3. Connect your smartphone to the vehicle via Bluetooth audio and Wi-Fi.

Data for the upgrade is sent from the mobile device to the vehicle both while driving and when stopped. Depending on the size of the upgrade, it may be necessary to drive your vehicle to complete the data transfer.

4. Follow the instructions on the control display.

Additional information:

Connecting mobile devices to the vehicle, see Owner's Manual for Navigation, Entertainment, Communication.

Information about the version



General information

The information about the version contains a description of the updates included in the Remote Software Upgrade. During the download and after the installation has been successfully completed, the information about the version can be displayed on the control display.

This information is also available in the ConnectedDrive customer portal.

Displaying information



Display in the vehicle:

1.  Apps menu
2. "All apps"
3. "System settings"
4. "Remote Software Upgrade"
5.  Display currently installed version: "Installed version:"
 -  Display new available version: "Info on version"
6. Follow the instructions on the control display.

Display in the ConnectedDrive customer portal: www.bmw-connecteddrive.com.

Installing the upgrade

General information

-  Installation of the Remote Software Upgrade may result in the deletion of software changes, e.g., performance increases not made by the manufacturer of the vehicle.
-  Modifications to the electrical system of the vehicle, for instance to control units, that have not been made by the vehicle manufacturer can lead to an interruption of the installation.
-  The installation does not occur until the consent was given.



- ▷ The installation may take around 20 minutes.
- ▷ The installation cannot be terminated.
- ▷ The vehicle cannot be used during the installation.
- ▷ The vehicle can be exited during the installation.
- ▷ Charging the vehicle is interrupted due to the installation.
- ▷ Following the successful installation, charging the vehicle may not continue automatically.

Prerequisites for the installation

- ▷ Sufficiently charged battery.
- ▷ The outside temperature is above 14 °F/-10 °C.
- ▷ The vehicle is parked in a horizontal position.
- ▷ The hazard warning system is turned off.
- ▷ The selector lever position P is engaged.
- ▷ Drive-ready state is switched off.

If applicable, follow the notes for further prerequisites on the control display.

Your vehicle can establish some prerequisites automatically. Follow the instructions on the control display.

If the prerequisites are not met such as a sufficiently charged battery, the upgrade will not be offered for installation.

Pay attention to an offer for installation, e.g., after charging the battery for a longer period of time.

Preparing the vehicle

- ▷ Park the vehicle safely away from the public road.
- ▷ Cellular network reception must be ensured so that a fault message can be sent to the vehicle manufacturer, for instance if the installation is terminated.

- ▷ Close the windows.
- ▷ Close the glass sunroof.
- ▷ Close the cargo area.
- ▷ Remove energy consuming devices such as a mobile phone.
- ▷ The vehicle key must be located in the vehicle for the consent for installation.
- ▷ Switch off the exterior lighting.
- ▷ Remove the devices connected to the diagnostic socket.

Installing immediately

The upgrade can be installed immediately if all prerequisites have been met.

1. ■■ Apps menu
2. "All apps"
3. "System settings"
4. "Remote Software Upgrade"
5. "Start upgrade now"
6. Follow the instructions on the control display.

Installing with timer

When the trip is completed, a timer can be used to install the upgrade automatically at a configured time such as during the night. It may be helpful to install the upgrade at a later time so that all functional requirements can be met, e.g., to allow the vehicle battery to charge sufficiently.

1. ■■ Apps menu
2. "All apps"
3. "System settings"
4. "Remote Software Upgrade"
5. Select the desired settings.

The installation starts automatically when:

- ▷ All prerequisites for the installation have been established correctly.
- ▷ All prerequisites continue to be met at the time of installation.

The timer is turned off when the drive-ready state is turned on.

Installing via the My BMW App

Once all preparations are complete and all requirements are met, the upgrade installation can also be started using the My BMW App when the vehicle is parked. The upgrade installation can be started remotely.

Follow instructions in the My BMW App.

Functional limitations

During the upgrade, the majority of functions is temporarily unavailable, for instance:

- ▷ Hazard warning system.
- ▷ Central locking system and, if necessary, Comfort Access.
- ▷ Parking lights.
- ▷ Horn.
- ▷ Alarm system.
- ▷ Emergency call.
- ▷ Power windows.
- ▷ Glass sunroof.
- ▷ Operate the tailgate or trunk lid.
- ▷ Lock the charging socket flap.

The driver's door can be locked and unlocked from the outside using the integrated key.

After successful upgrade

The vehicle can be used again immediately.

Booked services such as Advanced Real Time Traffic Information or Remote Services are automatically reactivated during the next trip.

After a longer stationary period, recharge the vehicle battery with the charging cable as necessary.

Malfunction

In the event of a malfunction, follow the instructions on the control display or in the My BMW App.

If the malfunction cannot be corrected, contact an authorized service center or another qualified service center or repair shop.

Validity of the Owner's Manual

Production of the vehicle

At the time of production at the plant, the printed Owner's Manual is the most current resource.

After a software update in the vehicle

After a vehicle software update such as via Remote Software Upgrade the Integrated Owner's Manual for the vehicle will contain the latest information.

Personal settings

Vehicle features and options

This chapter describes model-specific equipment, systems, and functions that are currently available, or may become available in the future, even if they are not present in the vehicle.

Additional information:

Vehicle equipment, refer to page [8](#).

Data protection

Data transfer

Principle

The vehicle offers different services, whose use requires a data transfer to BMW or a service provider.

General information

The data transfer can be deactivated for some services. When the data transfer is deactivated, the respective service cannot be used.

Settings

The data transfer can be configured in different stages or individually for separate services.

1.  Apps menu
2. "Vehicle"
3. "System settings"
4. "Data privacy"
5. Select the desired setting.

Deleting personal data in the vehicle

Principle

Depending on the usage, the vehicle stores personal data such as stored radio stations.

This personal data can be permanently deleted using iDrive.

General information

Depending on the equipment, the following data is deleted:

- ▶ BMW IDs or driver profiles.
- ▶ Stored radio stations.
- ▶ Stored shortcuts.
- ▶ Navigation, for instance stored destinations.
- ▶ Phone book.
- ▶ Online data, e.g., favorites, cookies.
- ▶ Office data, for instance voice memos.
- ▶ Login accounts.
- ▶ Digital key.

Altogether, the deletion of the data can take up to 15 minutes. In addition, the vehicle is removed from the My BMW App and Connected-Drive customer portal so that remote functions can no longer be used.

Functional requirements

- ▶ Data can only be deleted while stationary.
- ▶ The vehicle key must be in the vehicle.

Deleting data

The personal data in the vehicle will be deleted when the vehicle is reset to the factory settings.

Additional information:

Resetting vehicle data, refer to page [70](#).

Reset vehicle data

All individual settings can be reset to the factory settings when the drive-ready state is

switched off. Data can only be deleted while the vehicle is stationary. The vehicle key must be in the vehicle.

1.  Apps menu
2. "Vehicle"
3. "System settings"
4. "Reset vehicle data"
5. "Reset vehicle data"

If the synchronization of settings has been enabled for a BMW ID in the vehicle, the personal settings are kept in the BMW Cloud.

BMW ID/driver profiles

Principle

In ConnectedDrive countries, the BMW ID is the personal login for all relevant offers for the BMW brand. The BMW ID can be used in the vehicle to store and activate personal vehicle settings.

In non-ConnectedDrive countries, the personal vehicle settings can be stored in driver profiles.

If a vehicle is used by several people, each person can use their own BMW ID in the vehicle. If a BMW ID is activated, the settings stored for it are applied to the vehicle.

General information

The BMW ID must be registered once. A BMW ID can be registered via the My BMW App, in the ConnectedDrive Portal, or through an authorized service center.

A driver profile is created in the vehicle.

Many of the settings that are stored for a BMW ID in the vehicle can be synchronized with the BMW Cloud. This makes these settings available in any vehicle where the same BMW ID is used to log in.

The vehicle can store three BMW IDs or three driver profiles.

With driver recognition, a BMW ID or driver profile can be activated as soon as you unlock your vehicle. For this, a vehicle key or digital key must be linked with the BMW ID or driver profile. After unlocking, you can change the BMW ID or driver profile.

If no BMW ID or driver profile is activated when the vehicle is unlocked, the vehicle loads the guest profile.

Functional requirements

The vehicle must be stationary to create, change, delete, or edit a BMW ID.

Logging in the vehicle with a BMW ID and synchronization with the BMW Cloud are only possible when the vehicle has cellular network reception.

Welcome window

After unlocking the vehicle, a Welcome window is shown on the control display. The type of the welcome depends on the following prerequisites:

- ▶ The vehicle does not have a stored BMW ID or driver profile:
 - The welcome is neutral. An option to add a BMW ID or create a driver profile is offered.
- ▶ The vehicle key or the digital key has not been assigned to a BMW ID or a driver profile:
 - The welcome is neutral. The stored BMW IDs or the stored driver profiles are offered for selection. Additionally, it is possible to add a new BMW ID or create a new driver profile.
- ▶ A BMW ID or driver profile has been assigned to the vehicle key or digital key:
 - The welcome is personalized, the stored settings are activated. The BMW ID or the driver profile can be changed.

As soon as the drive-ready state is turned on or the control display is tapped outside of the Welcome window, the welcome will be hidden.

Adding the BMW ID

1.  Tap the BMW ID icon or the personal image on the status bar.
2. "Add BMW ID"
3. Scan the displayed QR code with your smartphone.
4. Observe the instructions on your smartphone.
 - ▶ If you have installed the My BMW App on your smartphone and saved your BMW ID, the BMW ID is automatically transferred to the vehicle.
 - ▶ If you do not have a BMW ID yet, you a new BMW ID can be registered.
5. Select the other settings you want to change, e.g., to configure driver recognition as desired.

To configure driver recognition, the corresponding vehicle key or digital key must be detected in the vehicle.

Driver recognition can be set or changed in the settings at a later time.

6. Change any additional settings as necessary.

Alternatively, the BMW ID can be registered by an authorized service center and added to the vehicle. The BMW ID must then be confirmed on the control display in the corresponding vehicle.

The vehicle is added to the user's My BMW App.

Confirming a BMW ID

If the BMW ID was created by an authorized service center and added to the vehicle, you must then confirm the BMW ID in the vehicle:

1. Select the BMW ID.
2. Scan the QR code shown.
3. Follow the instructions on your smartphone.

It may be necessary to log in again with the BMW ID.

 This icon is displayed on the status bar and indicates when it is necessary to login again.

1. Select the BMW ID.
2. Scan the QR code shown.

Another login will be attempted. Once successfully logged in, all functions can be used again.

My BMW app

If a BMW ID has been added to a vehicle, the vehicle is automatically added to the My BMW app. The My BMW App provides numerous beneficial functions and settings, e.g., user management.

Alternatively, an authorized service center can add a vehicle to the My BMW App. In this case, the BMW ID must then be confirmed on the control display in the corresponding vehicle.

In rare cases, the use of My BMW App functions for this vehicle may be restricted. More information is shown on the control display.

Creating a driver profile

In countries where BMW ConnectedDrive is not available, driver profiles can be created.

1.  Tap the icon or personal picture in the status bar.
2. "Add driver profile"
3. Enter the name for the driver profile.
4. Select the desired setting:
 - "Transfer settings"

If the vehicle is in the guest profile, the settings of the guest profile will be applied.

Primary user

The primary user is the person who first adds their BMW ID to the vehicle and first adds the vehicle to their My BMW App. Alternatively, the

primary user can be defined by an authorized service center.

The primary user has access to the following settings, for example:

- ▶ Removing BMW IDs saved to the vehicle.
- ▶ Transferring the primary user role to another BMW ID.
- ▶ Change vehicle-wide data protection settings.
- ▶ Create the main digital key.

Additional information:

BMW Digital Key, refer to page 89.

Automatic driver recognition

If driver recognition has been established, automatic activation of the BMW ID or driver profile is triggered by the following actions:

- ▶ By unlocking the vehicle using the button on the assigned vehicle key.
- ▶ By unlocking the vehicle with a door handle. The assigned vehicle key or the assigned digital key must be carried with you.
- ▶ By automatic unlocking when approaching the vehicle. The assigned vehicle key or the assigned digital key must be carried with you. Depending on the country, it may not be possible to recognize the digital key.

If there are several vehicle keys or digital keys in the vicinity of the vehicle, activation of the BMW ID or driver profile is done according to the following priority:

- ▶ The key that unlocks the vehicle triggers the activation of the assigned BMW ID or the assigned driver profile.
The guest profile is activated when the vehicle is unlocked using a key that is not assigned to a BMW ID or driver profile.
- ▶ If a vehicle key and a digital key are detected at the same time, the digital key trig-

gers the activation of the assigned BMW ID or the assigned driver profile.

- ▶ If another key is detected on the driver's door after activating the BMW ID or the driver profile, the BMW ID or the driver profile of the last key detected is activated.

If no BMW ID and no driver profile are assigned to this key, the guest profile is activated.

Setting synchronization

If synchronization is switched on, settings from the following areas, for example, are continuously synchronized:

- ▶ BMW ID, e.g., profile picture.
- ▶ Navigation, e.g., recent destinations, home address, or map settings.
- ▶ Media, e.g., favorites or saved radio stations.
- ▶ iDrive, e.g., main menu configuration, language, or units.
- ▶ Personal Assistant, e.g., suggestions or activation word.
- ▶ Exterior lighting, e.g., one-touch signaling and home lights.



Settings from the following areas are only synchronized when you log in for the first time:

- ▶ Seating and climate comfort, e.g., driver's seat position or temperature setting.
- ▶ Data protection menu.

Selecting the BMW ID/driver profile

If the BMW ID or driver profile could not be recognized when unlocking the vehicle, select the BMW ID or driver profile on the welcome window.

The BMW ID or driver profile can be changed at any time via iDrive:



1.  Tap the icon or personal picture in the status bar.
2.  "Change BMW ID"
 -  "Change driver profile"
3. Select the BMW ID or driver profile.
4. If necessary, enter the PIN.

The BMW ID or the driver profile are activated, the stored settings are loaded.





Guest profile

The guest profile can be activated and changed by anyone.



In the following cases the guest profile is automatically active:

-  A BMW ID has not yet been added or a driver profile has not yet been created.
-  No BMW ID or driver profile has been assigned to the vehicle key or the digital key that was used to unlock the vehicle.





The following limitations apply to the guest profile:

-  Certain functions are not available, e.g., navigation functions or saving favorites.
-  The guest profile cannot be renamed.
-  It is not possible to assign a PIN to the guest profile.
-  It is not possible to assign driver detection to the guest profile.
-  In ConnectedDrive countries, the synchronization with the BMW Cloud is not possible.

The guest profile is selected on the Welcome screen or via iDrive:

1.  Tap the icon or personal picture in the status bar.
2.  "Change BMW ID"
 -  "Change driver profile"
3. "Continue as guest"

Deleting the BMW ID/driver profile

1.  Tap the icon or personal picture in the status bar.
2.  "Manage BMW IDs"
 -  "Change driver profile"
3.  Tap the icon of the desired BMW ID or the desired driver profile.

Removing a BMW ID from the vehicle causes the vehicle to be removed from the My BMW App. If the BMW ID has been synchronized with the BMW Cloud, the data stored in the BMW Cloud is retained after the BMW ID is deleted. If the currently active BMW ID is removed, the guest profile is activated.

Removing a vehicle from the My BMW App removes the corresponding BMW ID from the vehicle. If the BMW ID was synchronized with the BMW Cloud, the BMW ID data stored in the BMW Cloud will be retained.

If the vehicle is removed from the primary user's My BMW App, it will also be removed from the My BMW App of the other users. The corresponding BMW IDs are removed from the vehicle.

If the vehicle is reset to factory settings, it is removed from each user's My BMW App, and all BMW IDs are removed from the vehicle.

Transfer of the vehicle key

A vehicle key that is assigned to a BMW ID or a driver profile can be used to view or change the stored personal settings.

Before a vehicle key is transferred to other persons, any assigned driver detection should be canceled. Changes to the driver detection can be made in the settings of the BMW ID or the driver profile.

The BMW Digital Key provides the option to transfer a digital key to permit other persons the use of your own vehicle.

Additional information:

BMW Digital Key, refer to page [89](#).

Settings

General information

Settings added when adding a BMW ID or creating a driver profile can be changed.

1.  Tap the icon or personal picture in the status bar.
2. "Settings"

The following settings are available for the BMW ID:

- ▷ The type of driver detection.
- ▷ The profile picture.
- ▷ The synchronization with the BMW Cloud.
- ▷ The personal salutation.

The following settings are available for the driver profile:

- ▷ The type of driver detection.
- ▷ The profile picture.
- ▷ The profile name.

Selecting a profile picture

The profile picture can be selected from the predefined profile pictures:

1.  Tap the icon or personal picture in the status bar.
2. "Settings"
3. "Manage profile picture"
4. "Select profile picture"

The personal profile picture for a BMW ID can be adopted from the profile in the My BMW App. This requires that the synchronization with the BMW Cloud is activated in the settings. After transferring the profile picture from the My BMW App, you can only select one of the predefined images if the profile picture in the My BMW App is deleted or synchronization is deactivated.

System limits

A clear driver detection via the vehicle key or the digital key may not always be possible in the following cases, for example:

- ▷ The driver changes, but the vehicle is not locked and unlocked.
- ▷ When multiple vehicle keys or multiple digital keys with an assigned BMW ID or driver profile are located in the outer area on the driver's side of the vehicle.
- ▷ When the vehicle was unlocked via the My BMW App.

The use of personal settings that are stored for a BMW ID in other vehicles is subject to technical limitations. For example, settings may be stored for a system that is not available, or available in a non-compatible version, in other vehicles.

Opening and closing

Vehicle features and options

This chapter describes model-specific equipment, systems, and functions that are currently available, or may become available in the future, even if they are not present in the vehicle.

Additional information:

Vehicle equipment, refer to page 8.

Vehicle key

General information

Two vehicle keys are included in the scope of delivery, each containing an integrated key.

Each vehicle key contains a replaceable battery.

Depending on the equipment and national-market version, various settings are possible for the button functions.

A BMW ID or a driver profile with personal settings can be assigned to a vehicle key.

To provide information on maintenance recommendations, the service data is stored in the vehicle key.

To prevent possible locking in of the vehicle key, take the vehicle key with you when exiting the vehicle.

Safety information

Warning

The vehicle key has a button cell battery. Batteries or button cell batteries can be swallowed and lead to serious or fatal injuries within two hours, for example due to internal burns or chemical burns. There is a risk of injury or danger to life. Keep the vehicle key and batteries out of reach of children. Imme-

diately seek medical help if there is any suspicion that a battery or button cell battery has been swallowed or is located in any part of the body.

Overview



Buttons on the vehicle key.

Icon	Meaning
	Unlock.
	Lock.
	Pre-conditioning, refer to page 258. Displaying the charging screen, refer to page 150.
	Open the cargo area.
	Panic mode. Pathway lighting, refer to page 162.

Additional vehicle keys

Additional vehicle keys are available from an authorized service center or another qualified service center or repair shop.

Loss of vehicle keys

A lost vehicle key can be disabled and replaced by an authorized service center or another qualified service center or repair shop.

If the lost vehicle key has an assigned BMW ID or driver profile, the connection to this vehicle key must be deleted. A new vehicle key can then be assigned to the BMW ID or driver profile.

Replacing the battery

NOTICE

Improper batteries in a battery-operated device can damage the device. There is a risk of property damage. Always replace the discharged battery with a battery with the same voltage, the same size and the same specification.

1. Remove the integrated key from the vehicle key.
2. Place the integrated key underneath the battery compartment cover, arrow 1, and lift the lid with a lever movement of the integrated key, arrow 2.



3. Push battery in arrow direction using a pointed object and lift it out.



4. Insert a CR2032 3V battery with the positive side facing up.
5. Press the lid closed.
6. Push the integrated key into the vehicle key until the integrated key engages.



Have old batteries disposed of by an authorized service center or another qualified service center or repair shop, or take them to a collection point.



Batteries contain harmful chemicals. It is prohibited by law to dispose of batteries together with household waste.

Integrated key

General information

The vehicle can be locked and unlocked manually using the integrated key.

Depending on the national-market version, the integrated key will fit in the glove compartment.

Safety information

Warning

For some national-market versions, unlocking from the inside is only possible with particular knowledge.



If persons or animals spend a lengthy time in the vehicle and are thereby exposed to extreme temperatures, there is a risk of injury or danger to life. Do not lock the vehicle from the outside when there are people or animals in it. Do not leave babies, toddlers or animals alone in the vehicle.

Removing the integrated key

1. Press the button, arrow 1, and pull out the integrated key, arrow 2.

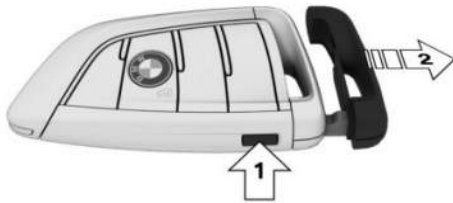

2. Pull off frame from integrated key.



Unlocking the vehicle manually

1. Pull and hold the driver's door handle outward with one hand.

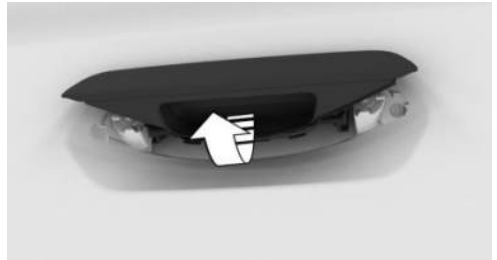

2. Unlock the door lock with the integrated key by turning it counterclockwise.



3. Pull out the vehicle key and release the door handle.
4. Open the driver's door.
5. Press the central locking button to unlock the other doors.
With the vehicle de-energized: pull the door opener of the other doors from the inside.

Locking the vehicle manually

General information

To avoid locking the vehicle key in the vehicle, do not place the vehicle key in the vehicle.

Overview

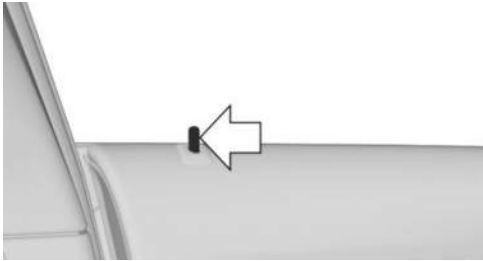

Lock button for manual locking of the doors.

Locking the vehicle

1. Close all doors.
2. Enter the vehicle on the front passenger's side and close the front passenger door.
3. Press the central locking button to unlock all doors.
If vehicle is de-energized: Press down the lock buttons on all doors except the front passenger door.
4. Exit the vehicle through the front passenger door.
5. Press down the lock button on the front passenger door and close the front passenger door.
6. Pull the door handles to make sure they are locked. If necessary, repeat the process.

Alarm system

If the vehicle is unlocked with the integrated key via the door lock, the activated alarm system will be triggered when the door is opened.

In this case, use the vehicle key emergency detection to switch off the alarm.

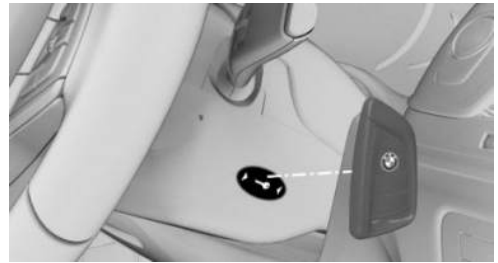

If the doors are manually locked from the inside, the alarm system is not activated.

Emergency detection of the vehicle key



It is not possible to switch on the drive-ready state if the vehicle key has not been detected.





Proceed as follows in this case:

1. Hold the rear of the vehicle key against the mark on the steering column. Pay attention to the display in the instrument cluster.
2.  If the vehicle key is detected:
Turn on drive-ready state within 10 seconds.
-  If the vehicle key is not detected:
Slightly change the position of the vehicle key and repeat the procedure.

Malfunction

A Check Control message is displayed where applicable.

Vehicle key detection by the vehicle may malfunction under the following circumstances:

-  The battery of the vehicle key is discharged.
-  Fault of the radio link from transmission towers or other equipment with high transmitting power.
-  Shielding of the vehicle key due to metal objects.
Do not transport the vehicle key together with metal objects.
-  Fault of the radio link from mobile phones or other electronic devices in direct proximity to the vehicle key.

Do not carry the vehicle key in close proximity to other electronic devices.

- ▷ Fault of radio transmission by a charging process of mobile devices, for instance charging of a mobile phone.
- ▷ The vehicle key is located in direct proximity of the wireless charging tray.
Place the vehicle key in a different location.
- ▷ Fault of the radio link while charging the vehicle.

In the case of interference, the vehicle can also be unlocked and locked from the outside with the integrated key. Use the Emergency detection of the vehicle key to turn on drive-ready state.

Access to vehicle interior

Safety information

Warning

People or animals in the vehicle can lock the doors from the inside and lock themselves in. In this case, the vehicle cannot be opened from the outside. There is a risk of injury. Take the vehicle key with you so that the vehicle can be opened from the outside.

Warning

For some national-market versions, unlocking from the inside is only possible with particular knowledge.

If persons or animals spend a lengthy time in the vehicle and are thereby exposed to extreme temperatures, there is a risk of injury or danger to life. Do not lock the vehicle from the outside when there are people or animals in it. Do not leave babies, toddlers or animals alone in the vehicle.

Warning

Unattended children or animals in the vehicle can cause the vehicle to move and endanger themselves and traffic, for example, due to the following actions:

- ▷ Establishing standby.
- ▷ Releasing the parking brake.
- ▷ Opening and closing the doors or windows.
- ▷ Engaging selector lever position N.
- ▷ Using vehicle equipment.

There is a risk of accident, injury, and property damage. Do not leave children or animals unattended in the vehicle. Take the vehicle key with you when exiting and lock the vehicle.

NOTICE

The window will be lowered slightly when pulling on the door handle. In the event of frost, the window may be frozen solid and may not be able to be lowered. There is a risk of property damage. When pulling on the door handle, make sure that the window is lowered. If necessary, remove snow and ice from the window. Do not open the door with force.

Actions during unlocking

Depending on the settings, the following functions are performed when unlocking the vehicle:

- ▷ Only the driver's door and the charging socket flap will be unlocked or all access to the vehicle will be unlocked.
- ▷ The unlocking of the vehicle can be confirmed with a light signal or a sound signal.
- ▷ The welcome light can be turned on when the vehicle is being unlocked.

In addition, the following functions are executed:

- ▷ If a BMW ID or a driver profile was assigned to the vehicle key, this BMW ID or driver profile will be activated.
- ▷ The interior lights are switched on, unless they were manually switched off.
- ▷ Depending on vehicle equipment, folded-in exterior mirrors are folded out.
If the exterior mirrors were folded in using the button inside the vehicle, they will not fold out when the vehicle is unlocked.
- ▷ Anti-theft protection is switched off.
- ▷ The alarm system is switched off.

Additional information:

- ▷ Settings, refer to page 93.
- ▷ Welcome lights, refer to page 161.
- ▷ BMW ID/driver profiles, refer to page 71.

Actions during locking

Depending on the settings, the following functions are performed when locking the vehicle:

- ▷ The locking of the vehicle can be confirmed with a light signal or a sound signal.
- ▷ Depending on vehicle equipment, the exterior mirrors can be folded in automatically when locking. The exterior mirrors are not folded in when the hazard warning flashers are switched on.

The following functions are executed:

- ▷ All doors, the cargo area, and the charging socket flap are locked.
- ▷ Anti-theft protection is switched on. This prevents the doors from being unlocked using the lock buttons or the door openers.
- ▷ The alarm system is switched on.

If the drive-ready state is still turned on when you lock the vehicle, the vehicle horn will honk twice. In this case, drive-ready state must be turned off using the Start/Stop button.

Additional information:

Settings, refer to page 93.

With the vehicle key

Unlocking the vehicle



Press the button on the vehicle key.

If only the driver's door and charging socket flap have been unlocked due to the settings, press the button on the vehicle key again to unlock the other vehicle access points.

The lighting functions may depend on the ambient brightness.

Locking the vehicle

1. Close the driver's door.



2. Press the button on the vehicle key.

All vehicle access points are locked.

On the door handle

Principle

The vehicle can be accessed without operating the vehicle key.

The vehicle key is automatically detected near the vehicle.

General information

The function is available with Comfort Access.

Functional requirements

- ▷ Carry the vehicle key with you, e.g., in your pants pocket.
- ▷ To lock the vehicle, the vehicle key must be outside of the vehicle near the doors.
- ▷ After locking, approx. 2 seconds must elapse before unlocking is possible.

Unlock vehicle

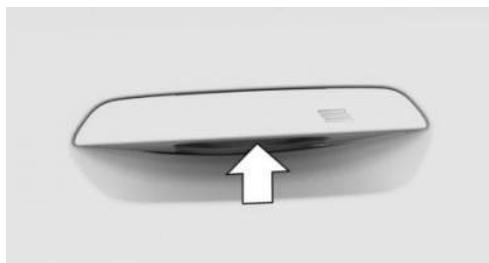

Reach into the recessed grip of a front door.

Locking the vehicle

1. Close the driver's door.
2. With your finger, touch the grooved surface on a closed door handle for approx. 1 second without reaching into the recessed grip.

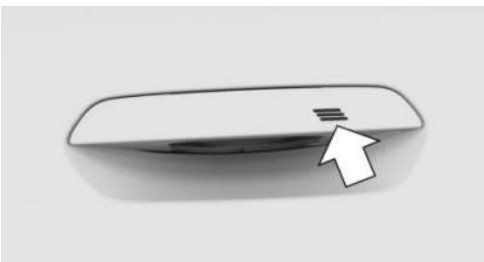

Malfunction

Wet or snowy conditions may disrupt the locking request detection on the door handles.

In the case of a malfunction, unlock and lock the vehicle using the buttons of the vehicle key or use the integrated key.

Touchless unlocking/locking of the vehicle

Principle

When the driver approaches the locked vehicle with the vehicle key, the vehicle is unlocked.

When the driver walks away from the unlocked vehicle with the vehicle key, the vehicle will be locked.

General information

The function is available with Comfort Access.

The vehicle will be unlocked when an authorized vehicle key is detected in the unlocking zone.

The unlocking zone is located within a radius of approx. 5 ft/1.50 m around the side and rear of the vehicle.

The vehicle will be locked when the vehicle key leaves the locking zone.

The locking zone is located within a radius of approx. 9 ft/3 m around the side and rear of the vehicle.

If the vehicle key is located in the unlocking zone for an extended period of time without movement, the vehicle will be locked automatically.

If a passenger is detected in the front passenger seat during locking and the seat belt of the front passenger is engaged in the seat belt buckle during locking:

- ▶ The vehicle will be locked but not secured against theft.
- ▶ The charging socket flap remains unlocked.

Actions during unlocking

If the settings specify that only the driver's door and the charging socket flap will be unlocked, note the following:

The driver's door and the charging socket flap will only be unlocked when the driver is within the unlocking zone of the driver's door.

Settings, refer to page 93.

Functional requirements

- ▶ Carry the vehicle key with you, e.g., in your pants pocket.
- ▶ Unlocking: when entering the unlocking zone, the doors and cargo area must be closed.
- ▶ Locking: when leaving the locking zone, the doors and cargo area must be closed.
- ▶ Automatic unlocking and locking must be activated in the settings.
- ▶ The drive-ready state must be turned off.
- ▶ For contactless locking of the vehicle, no second vehicle key may be within a radius of 18 ft/6 m around the vehicle.
- ▶ If the vehicle has been in the idle state for several days, contactless unlocking/locking will only be available after the vehicle has been driven.

Additional information:

Settings, refer to page [93](#).

With the Key Card

Principle

The Key Card is a chip card on which the digital key is installed. The Key Card can be used to unlock and lock the vehicle.

Additional information:

Key Card, refer to page [87](#).

General information

The Key Card is available with Comfort Access.

Locking/unlocking the vehicle

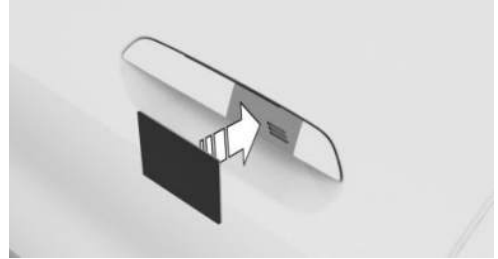

Hold the activated Key Card directly at the center of the driver's door handle.

When locking the vehicle with the Key Card, make sure that all doors and the cargo area are closed.

If the Key Card is not detected, slightly change the position of the Key Card and repeat the procedure.

With the BMW Digital Key

Principle

Depending on vehicle equipment and national-market version, a digital key can be installed on a compatible smartphone and used to unlock and lock the vehicle.

Additional information:

BMW Digital Key, refer to page [89](#).

Locking/unlocking the vehicle

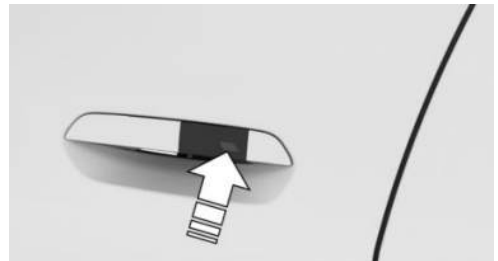

Hold the smartphone NFC antenna directly at the center of the driver's door handle. The po-



sition of the near field communication antenna depends on the smartphone model.

When locking the vehicle with the smartphone, make sure that all doors and the cargo area are closed.

Frequently Asked Questions

What precautions can be taken to be able to open a vehicle, despite accidentally locking in the vehicle key?

- ▶ The app's remote services offer the option to lock and unlock a vehicle.

This requires an active BMW ConnectedDrive contract, and the app must be installed on a smartphone.

- ▶ Unlocking the vehicle can be requested via the BMW ConnectedDrive Call Center.

An active BMW ConnectedDrive contract is required.

Access to the cargo area

General information

The cargo area will be opened to the configured opening height.

Safety information

Warning

Body parts can be jammed when operating the tailgate. There is a risk of injury. Make sure that the travel path of the tailgate is clear during opening and closing.

Warning

The tailgate swings back and up when it opens. There is a risk of injury and risk of property damage. Make sure that the travel path of the tailgate is clear during opening and closing.

Warning

Sharp-edged or pointed objects can hit the windows and heating elements while driving. There is a risk of injury or risk of property damage. Cover the edges and ensure that pointed objects do not hit the windows.

With the vehicle key

General information

To avoid locking the vehicle key in the vehicle, do not place the vehicle key in the cargo area.

Depending on vehicle equipment and national-market version, the following settings can be changed:

- ▶ Unlocking the cargo area with the vehicle key also unlocks the doors.
- ▶ Before unlocking the cargo area with the vehicle key, first unlock the vehicle.

Functional requirements

Selector lever position P must be engaged to open the cargo area with the vehicle key.

You must enable the setting for opening with the vehicle key.

Additional information:

Settings, refer to page 93.

Opening the cargo area



Press and hold the button on the vehicle key for approx. 1 second.

On the cargo area

General information

With Comfort Access, the cargo area can be accessed without activating the vehicle key.

The key is automatically detected near the vehicle.

Functional prerequisite

Carry the vehicle key with you, e.g., in your pants pocket.

Opening the cargo area

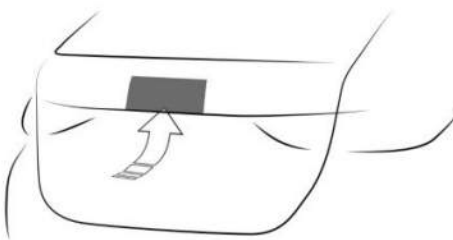



- ▶ Unlock the vehicle and then press the button on the cargo area.
- ▶ With Comfort Access: carry the vehicle key with you and press the button on the cargo area.

Locked doors are not unlocked.

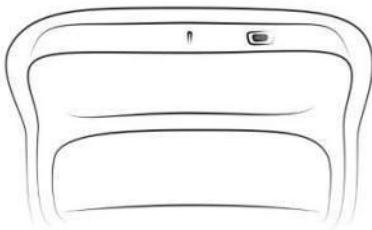
Closing the cargo area



- ▶  Press the button on the trunk.
- ▶  Press the button on the trunk. The vehicle is locked after closing the cargo area. To do so, the driver's door must be closed and the vehicle key must be outside of the vehicle near the cargo area.

Inside the vehicle

Functional requirements

The vehicle key or digital key must be located within the vehicle in order to close the cargo area using the button inside the vehicle.

When the vehicle is locked, selector lever position P must be engaged before the tailgate can be opened using the button inside the vehicle.

Opening the trunk

- ▶  Press the button in the driver's door.

Closing the cargo area

- ▶  Pull and hold the button in the driver's door.

An acoustic signal sounds before the trunk is closed.

Interruption of the opening procedure

The opening procedure is interrupted in the following situations:

- ▶ When the vehicle starts moving.
- ▶ By pressing the button on the outside of the cargo area. Pressing it again closes the cargo area again.
- ▶ By pressing the button on the inside of the cargo area. Pressing it again closes the cargo area again.

- ▶ By pressing the button on the vehicle key. Pressing the button again continues the opening process.
- ▶ By pressing or pulling the button in the driver's door. Pressing again continues the opening procedure.

Interruption of the closing procedure

The closing procedure is interrupted in the following situations:

- ▶ If the vehicle drives off with a jerky movement.
- ▶ By pressing the button on the outside of the cargo area. Pressing it again opens the cargo area again.
- ▶ By pressing the button on the inside of the cargo area. Pressing it again opens the cargo area again.
- ▶ By pressing the button on the vehicle key. Pressing it again opens the cargo area again.
- ▶ By releasing the button in the driver's door. Pulling again and holding continues the closing motion.

Opening and closing the cargo area contactlessly

Principle

You can open the cargo area contactlessly when carrying the vehicle key on your person. With automatic tailgate activation, the cargo area can also be closed contactlessly.

Sensors detect specific foot movements near the center of the rear area, and the cargo area opens or closes.

General information

Function availability depends on vehicle equipment and national-market version.

If the vehicle key is within the sensor range, the cargo area may open or close inadvertently if

you unintentionally move your foot or if a foot movement is detected.

The sensor has an approximate range of 5 ft/1.50 m extending from the rear area.

If contactless opening is used for the cargo area, the locked doors will not be unlocked.

Functional requirements

- ▶ To close the cargo area contactlessly, the automatic tailgate must be installed.
- ▶ Selector lever position P must be engaged.
- ▶ Contactless opening and closing of the cargo area must be activated in the settings.

Depending on vehicle equipment:

- ▶ No trailer hitches should be mounted.

Additional information:

Settings, refer to page 93.

Opening the cargo area

1. To open the cargo area hands-free, walk behind the vehicle and hold the vehicle key in the middle at approx. arm's length.
2. Wave a foot under the vehicle in the driving direction and immediately pull it back. With these movements, the leg must pass through the ranges of both sensors.



Before the cargo area opens, the hazard warning system flashes.

Moving a foot again will stop the opening procedure. The subsequent foot movement will close the cargo area again.

Closing the cargo area

Perform the foot movement for opening the cargo area.

The hazard warning system flashes and an acoustic signal sounds.

Moving a foot again will stop the closing process. The subsequent foot movement will open the cargo area again.

System limits

The detection of the foot movement may be limited due to the following external conditions:

- ▶ Ice, snow or slush on the rear of the vehicle.
- ▶ Dirt or road salt on the rear of the vehicle.

Movement in range of the sensors may cause the cargo area to open unintentionally, e.g., due to running water when cleaning the vehicle or from heavy rainfall, or due to the moving brushes in a car wash. To prevent such unintended opening of the cargo area in such cases, keep the vehicle key at a sufficient distance from the rear of the vehicle.

Depending on vehicle equipment: Objects mounted on a trailer hitch cannot be detected if the trailer power socket is not plugged in.

Emergency cargo area release



Pull the handle inside the cargo area.
The cargo area is unlocked.

Malfunction

Warning

With manual operation of a blocked tailgate, it can release itself unexpectedly from the blocking. There is a risk of injury and risk of property damage. Do not operate the tailgate manually if it is blocked. Have the vehicle checked by an authorized service center or another qualified service center or repair shop.

In the event of an electrical malfunction in the automatic tailgate, operate the unlocked tailgate slowly with a smooth motion by hand.

To close the tailgate fully, press down lightly only. Closing occurs automatically.

Key Card

Principle

The Key Card allows the vehicle to be unlocked and locked, as well as started.

General information

Key Card availability depends on vehicle equipment and national-market version.

A digital key that has already been paired with the vehicle is installed on the Key Card. The digital key must be activated via iDrive.

Before leaving the vehicle, deactivate the Key Card or take the Key Card with you because the active Key Card can be used to start the vehicle. Always take the vehicle key with you to a service appointment.

Safety information

NOTICE

If the Key Card and a mobile device are in the wireless charging tray at the same time, the Key Card could become damaged. There is a risk of property damage. Do not place the Key Card in the wireless charging tray at the same time as a mobile device.

Activating/deactivating Key Card in the vehicle

General information

When the BMW Digital Key is activated for the vehicle, a digital key can be used instead of the vehicle key.

A deactivated Key Card remains in the list of paired digital keys.

Functional requirement

A vehicle key must be located in the vehicle to activate and deactivate the Key Card.

Activating Key Card



1. Open the cover of the smartphone tray.
2. Place Key Card in the center of the smartphone tray.
3. Follow instructions on the control display.

Deactivating Key Card

1.  Apps menu
2. "Vehicle"
3. "Doors and windows"
4. "Digital Key"
5. "Key Card"
6. "Deactivate Key Card"

A deactivated Key Card remains in the list of paired digital keys.

Unlocking and locking the vehicle

The vehicle can be unlocked and locked with the activated Key Card.

Additional information:

Access to the vehicle interior, refer to page 80.

Turning on the drive-ready state



1. Open the cover of the smartphone tray.
2. Place activated Key Card in the center of the smartphone tray.
3. Press the Start/Stop button.

After drive-ready state is switched on, the Key Card can be removed from the tray.

Malfunction

The vehicle may not be able to detect the Key Card if there are objects between the smartphone tray and the Key Card, e.g., a wallet or smartphone case.

BMW Digital Key

Principle

BMW Digital Key lets you lock and unlock and start your vehicle using a digital key.

General information

BMW Digital Key availability and functionality depend on vehicle equipment and national-market version.

BMW Digital Key can be used with a compatible smartphone or other compatible mobile devices.

To unlock and start a vehicle with a compatible smartphone, this function must be offered by the smartphone manufacturer. The My BMW app can be used to check if the smartphone and vehicle are compatible and which functions are supported.

A BMW ID or a driver profile with individual settings can be assigned to a digital key.

When using a smartphone as a digital key, always carry a vehicle key or the activated Key Card with you. This ensures access to the vehicle, even in the event of a smartphone failure. It is also helpful to have the vehicle key or Key Card with you if the vehicle needs to be handed over to another person. You can then hand over the vehicle key or the Key Card instead of your smartphone.

Always take the vehicle key with you to a service appointment.

Additional information:

- ▶ BMW ID/driver profiles, refer to page 71.
- ▶ Key Card, refer to page 87.
- ▶ www.bmw.com/digitalkey

Functional requirements

- ▶ The smartphone is compatible with BMW Digital Key
- ▶ The vehicle is linked with the Connected-Drive account of the vehicle owner.
- ▶ The rechargeable battery of the smartphone has a sufficient charge. The necessary minimum charge of the rechargeable battery depends on the smartphone.
- ▶ Bluetooth must be activated on the smartphone for contactless unlocking and locking using the digital key.

Enabling the main digital key

Vehicle owner's smartphone is enabled as a main digital key in the vehicle. The vehicle owner must prove his authorization for the vehicle for this purpose.

Proof of authorization can be started via the My BMW App or using the activation code in the corresponding smartphone function, e.g., the Wallet app.

Both vehicle keys must be located in the vehicle to be enabled.

Follow the activation instructions in the Digital Key menu, on the app, or on the control display.

Sharing digital keys

General information

Digital Key allows the sharing of digital keys with other people. This option is available via the smartphone that is enabled as main digital key. This function must be supported by the smartphone.

Forwarding authorization

To share the digital key, select the corresponding function on the smartphone, for instance in the Wallet app.

As soon as a digital key is shared with another person, the person will receive an invitation.

When the invitation is accepted, the digital key on the recipient's smartphone will be activated.

Limiting the range of functions

Certain functions of the digital key can be limited before handing it over. For instance, if the digital key is passed on to a novice driver, the switch-off for driving stability control systems can be disabled and the engine power can be reduced. For more information, refer to the ConnectedDrive Portal and My BMW app.

Authentication

Depending on the recipient's smartphone model, an authentication may be required for security and safety reasons.

An authorized vehicle key, the main digital key or another method may be used for authentication. Follow the corresponding instructions on the smartphone or the control display.

Deleting digital keys

General information

Deleted digital keys will be removed from the list of enabled digital keys.

Deleted digital keys cannot be restored.

Deleting the main digital key

The main digital key can be deleted from the smartphone or via iDrive.

The deletion of the main digital key is completed immediately.

Deleting a shared key

Shared keys can be deleted using the smartphone with the master Digital Key, using the smartphone with the shared key to be deleted, or via iDrive.

The deletion via the smartphone using the main digital key will not be performed until the vehicle is used with a key other than the key to be deleted.

If the smartphone associated with a shared key or iDrive is used to delete a shared key, it will be deleted immediately.

Deletion via iDrive

To delete a digital key via iDrive, there must be an authorized vehicle key in the vehicle, or the master Digital Key must be in the smartphone tray.

1.  Apps menu
2. "Vehicle"
3. "Doors and windows"
4. "Digital Key"
5. If necessary, select the digital key.
6. Delete the Digital Key.

Resetting the function

To reset the BMW Digital Key function, an authorized vehicle key must be located in the vehicle.

When resetting the BMW Digital Key function, all digital keys including the main digital key will be deleted. The Key Card's digital key is retained and deactivated.

After the reset, the vehicle can no longer be unlocked, locked or started with a digital key.

The main digital key must be enabled again to be able to use BMW Digital Key again.

1.  Apps menu
2. "Vehicle"
3. "Doors and windows"
4. "Digital Key"
5. "Reset function"

Unlocking and locking the vehicle

The vehicle can be unlocked and locked using the door handle.

Additional information:

Access to the vehicle interior, refer to page [80](#).

Turning on the drive-ready state

Using the smartphone tray



1. Open the cover of the smartphone tray.
2. Place smartphone in the center of the smartphone tray.
Ensure that the display is facing up.
3. Close the cover of the smartphone tray.
4. Press the Start/Stop button to turn on drive-ready state.

Sale of the smartphone

Delete all digital keys on the smartphone prior to selling the smartphone. This ensures that the smartphone can no longer be used for the vehicle.

Changing smartphones

To use a new smartphone as a master Digital Key, activate the new smartphone according to the instructions for the master Digital Key. The previous master key is deleted when the new smartphone is activated.

Sale of the vehicle

Prior to selling a vehicle, reset the Digital Key function or remove the vehicle from the ConnectedDrive account of the current vehicle owner.

When the vehicle is removed from the ConnectedDrive account, all digital keys for the vehicle will be deleted. The Key Card's digital key is retained and deactivated.

System limits

The interior motion sensor and tilt alarm sensor of the alarm system cannot be switched off with a digital key.

Additional information:

Alarm system, refer to page [94](#).

Malfunction

Digital key recognition by the vehicle may malfunction under the following circumstances:

- ▶ The smartphone is shielded from the sensors in the vehicle by a smartphone cover that is not suitable.
- ▶ Objects such as a chip card or the Key Card are located between the smartphone and the smartphone cover.
- ▶ Fault of the connection from transmission towers or other equipment with high transmitting power.
- ▶ Shielding of the smartphone due to buildings or metal objects.

Buttons for the central locking system

General information

The vehicle is automatically locked when driving off.

In the event of a severe accident, the vehicle is automatically unlocked. The hazard warning system and interior lights are illuminated.



Overview

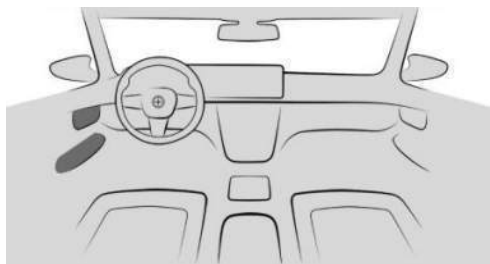

The central locking buttons are located on the front door.



Lock.



Unlock.

Locking the vehicle



Press the button in the driver's door or front passengers door with the front doors closed.

The vehicle is not secured against theft when locking.

Unlocking the vehicle



Press the button in the driver's door or front passenger's door.

Opening the door

- ▶  Press the button to unlock all the doors.
Pull the door opener above the armrest.
- ▶ Front doors: pull the door opener on the door to open the door. The other doors remain locked.
- ▶ Back doors: pull twice on the door opener on the door to be opened; the first time

unlocks the door, the second time opens it. The other doors remain locked.

Valet parking mode

Principle

In the valet parking mode, the control display is disabled.

E.g., this mode can be used when the vehicle is handed over for valet parking.

General information

Depending on the national-market version, the valet parking mode may not be available.

Valet Parking mode has the following restrictions:

- ▶ Vehicle settings cannot be changed via iDrive.
- ▶ Settings stored to a BMW ID or guest profile cannot be changed.
- ▶ Personal data cannot be displayed.
- ▶ The audio system is muted, with the possible volume of the audio system being limited.
- ▶ The integrated Universal Remote Control is deactivated.
- ▶ Dynamic Stability Control cannot be turned off.
- ▶ The availability of certain settings of the driving modes is limited.

Additional information:

BMW ID/driver profiles, refer to page 71.

Functional requirement

The driver has registered in the vehicle with a BMW ID.

Activating the valet parking mode



1.  Apps menu
2. "Vehicle"

3. "System settings"
4. "Valet parking mode"
5. If necessary, "PIN"

If the active BMW ID does not have an assigned PIN, this PIN must be set now. The PIN is needed to deactivate the valet parking mode.

6. If necessary, enter the PIN.
7. "Activate valet parking mode"

Deactivating valet parking mode

1. Select the desired BMW ID on the lock screen.
2.  Enter the assigned PIN for the BMW ID.
If you have forgotten the PIN: enter the access data for the BMW ID.
 -  If the selected BMW ID does not have an assigned PIN: enter the access data for the BMW ID.



Settings

General information

Depending on the equipment and national-market version, various settings for opening and closing are possible.

Unlocking and locking

Doors

1.  Apps menu
2. "Vehicle"
3. "Doors and windows"
4. "Lock/unlock"
5. "Unlock"
6. Select the desired setting:
 -  "Driver's door only"



Only the driver's door and the charging socket flap are unlocked. Pressing again unlocks the entire vehicle.

-  "All doors"
The entire vehicle is unlocked.

Touchless unlocking/locking

1.  Apps menu
2. "Vehicle"
3. "Doors and windows"
4. "Comfort access"
5. Select the desired setting.

Automatic unlocking

1.  Apps menu
2. "Vehicle"
3. "Doors and windows"
4. "Lock/unlock"
5. Select the desired setting:
 -  "Unlock doors at end of trip"
 -  "Unlock doors when in P"

If locked, the vehicle unlocks automatically when drive-ready state is turned off or selector lever position P is engaged.

Automatic locking

1.  Apps menu
2. "Vehicle"
3. "Doors and windows"
4. "Lock/unlock"
5. "Lock after a short time"

The vehicle locks automatically after a short period of time if no door is opened after unlocking.

Confirmation signals from the vehicle

1.  Apps menu
2. "Vehicle"
3. "Doors and windows"



4. "Lock/unlock"
5. Select the desired setting:
 - ▷ "Flash on lock/unlock"

Unlocking is signaled by flashing twice, locking by flashing once.
 - ▷ With alarm system:

"Sound on lock/unlock"

Unlocking is confirmed with two sound signals, locking is confirmed with one sound signal.

Folding mirrors in automatically

1. Apps menu
2. "Vehicle"
3. "Doors and windows"
4. "Lock/unlock"
5. "Fold mirrors on lock/unlock"

Cargo area

Cargo area and doors

1. Apps menu
2. "Vehicle"
3. "Doors and windows"
4. "Tailgate"
5. Select the desired setting:
 - ▷ "Tailgate"

Depending on the equipment, the cargo area will be unlocked or opened.
 - ▷ "Tailgate and door(s)"

Depending on the equipment, the cargo area will be unlocked or opened and the doors are unlocked.
 - ▷ "Tailgate will only open if vehicle is already unlocked"

The vehicle must be unlocked before the cargo area can be operated with the vehicle key.
 - ▷ "Lock tailgate button"

Operating the cargo area with the vehicle key is disabled.

Adjusting the opening height

You can set how far the tailgate can be opened.

When adjusting the opening height, make sure the clearance above the tailgate is at least 4 in/10 cm.

1. Apps menu
2. "Vehicle"
3. "Doors and windows"
4. "Tailgate"
5. "Opening height"
6. Monitor the tailgate and set the desired opening height.

Opening/closing the cargo area contactlessly

1. Apps menu
2. "Vehicle"
3. "Doors and windows"
4. "Tailgate"
5. Select the desired setting.

Alarm system

Principle

The alarm system issues a visual and acoustic signal when someone attempts to open the locked vehicle incorrectly.

General information

When the vehicle is locked, the vehicle alarm system reacts to the following changes:

- ▷ Opening a door, the hood, or the cargo area.
- ▷ Movements in the vehicle interior.

- ▷ Changes in the vehicle inclination such as during attempts at stealing a wheel or when towing the vehicle.
- ▷ Disconnected battery voltage.
- ▷ Improper use of the socket for OBD on-board diagnostics.
- ▷ Locking the vehicle while a device is connected to the diagnostic socket.

The alarm system signals these changes visually and acoustically:

- ▷ Acoustic alarm:
Depending on local regulations, the acoustic alarm may be suppressed.
- ▷ Optical alarm:
By flashing of the hazard warning system and headlights, where required.

Do not modify the system to ensure function of the alarm system.

Turning the alarm system on/off

The alarm system is turned on as soon as the vehicle is locked from the outside.

The alarm system does not turn on if the vehicle is locked manually from the inside.

The alarm system is switched off as soon as the vehicle is unlocked.

Opening the doors with the alarm system switched on

The alarm system is triggered when a door is opened if the door was unlocked using the integrated key in the door lock.

Opening the cargo area with the alarm system switched on

The cargo area can be opened even when the alarm system is switched on.

After closing the cargo area, the cargo area will be locked and monitored again. The hazard warning system flashes once during closing.

Panic mode

You can trigger the alarm system if you find yourself in a dangerous situation.



- ▷ Press the button on the vehicle key and hold for at least 3 seconds.
- ▷ Briefly press the button on the vehicle key three times in succession.

To switch off the alarm: press any button.

Indicator light on the interior mirror



- ▷ The indicator light flashes briefly every 2 seconds:

The alarm system is switched on.

- ▷ The indicator light flashes for approx. 10 seconds, then flashes briefly every 2 seconds:

Interior motion sensor and tilt alarm sensor are not active, as doors, hood, or tailgate are not correctly closed. Correctly closed access points are secured.

When the remaining open access points are closed, the interior motion sensor and tilt alarm sensor will be turned on.

- ▷ The indicator light flashes even though all access points have been closed:
Alarm system error.
- ▷ The indicator light goes out after unlocking:
The vehicle has not been tampered with.
- ▷ The indicator light flashes after unlocking until drive-ready state is switched on, but no longer than approx. 5 minutes:



The alarm has been triggered.

Tilt alarm sensor

The inclination of the vehicle is monitored.

The alarm system responds in situations such as attempts to steal a wheel or when the vehicle is towed.

Interior motion sensor

The vehicle interior is monitored.

The alarm system triggers when movement is detected inside the vehicle.

The windows and the glass sunroof must be closed for the system to function properly.

Avoiding unintentional alarms

General information

The tilt alarm sensor and interior motion sensor can trigger an alarm, although no unauthorized action occurred.

Possible situations for an unwanted alarm:

- ▶ In car washes.
- ▶ In duplex garages.
- ▶ During transport on trains carrying vehicles, at sea or on a trailer.
- ▶ With animals in the vehicle.

The tilt alarm sensor and the interior motion sensor can be switched off in such situations.

Switching off the tilt alarm sensor and interior motion sensor



Press the button on the vehicle key within 30 seconds as soon as the vehicle is locked.

The indicator light illuminates for approx. 2 seconds and then continues to flash.

The tilt alarm sensor and interior motion sensor are switched off until the vehicle is locked again.

Ending the alarm

Unlock the vehicle.

If the vehicle is unlocked with the integrated key, the drive-ready state must subsequently be turned on via the emergency detection of the vehicle key.

Window

General information

When a window is frequently opened to the same position, this task can be performed by the BMW Intelligent Personal Assistant. This is useful if you frequently use the same parking garage, for example.

Additional information:

BMW Intelligent Personal Assistant, refer to page 59.

Safety information

Warning

When operating the windows, body parts and objects can be jammed. There is a risk of injury and risk of property damage. Make sure that the travel path of the windows is clear while opening and closing.

With the vehicle key

Opening windows



Press and hold the button on the vehicle key after unlocking.

The windows open for as long as the button on the vehicle key is pressed.

Closing the windows



With Comfort Access: press and hold the button on the vehicle key after locking.

The windows close for as long as the button on the vehicle key is pressed.

Depending on the vehicle equipment, exterior mirrors are folded in unless they were folded in during locking. The exterior mirrors are not folded in when the hazard warning flashers are switched on.

On the door handle

Principle

The windows can be closed using the door handle without operating the vehicle key.

The vehicle key is automatically detected near the vehicle.

General information

The function is available with Comfort Access.

Functional prerequisite

Carry the vehicle key with you, for instance in your pants pocket.

Closing the windows

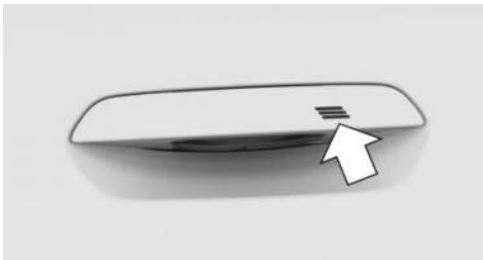

With your finger, touch the grooved surface on a closed door handle without reaching into the recessed grip.

In addition to locking, the windows and glass sunroof with sun protection will be closed.

Depending on the vehicle equipment, exterior mirrors are folded in unless they were folded in during locking. The exterior mirrors are not folded in when the hazard warning flashers are switched on.

Inside the vehicle

Overview

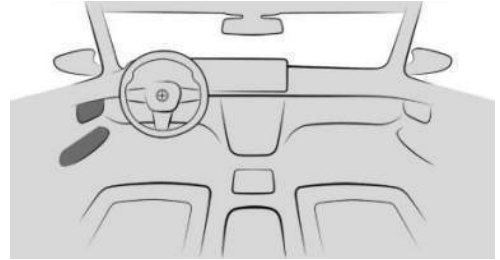



Power windows

Functional requirements

- ▷ Standby state is switched on.
- ▷ Drive-ready state is switched on.

The vehicle key or digital key must be inside the vehicle.

Opening windows

- ▷  Press the switch to the resistance point.
The window opens while the switch is being held.
- ▷  Press the switch beyond the resistance point.
The window opens automatically. Pressing the switch again stops the motion.

Closing the windows

- ▷  Pull the switch to the resistance point.

The window closes while the switch is being held.

- ▶  Pull the switch beyond the resistance point.
The window closes automatically. Pulling again stops the motion.

Anti-trap mechanism

Principle

The anti-trap mechanism prevents objects or body parts becoming jammed between the door frame and window while a window is being closed.

General information

If resistance or blockage is detected while a window is being closed, the closing will be interrupted.

Safety information

Warning

Accessories on the windows such as antennas can impact anti-trap mechanism. There is a risk of injury. Do not install accessories in the area of movement of the windows.

Closing without the anti-trap mechanism

In case of danger from the outside or if icing might prevent normal closing, proceed as follows:

- 1. Pull the  switch past the resistance point and hold it there.

The window closes with limited anti-trap mechanism. If the closing force exceeds a specific threshold, closing is interrupted.

- 2. Pull the  switch past the resistance point again within approx. 4 seconds and hold it there.
The window closes without the anti-trap mechanism.

Safety switch

Principle

The safety switch can be used to prevent children, for instance, from opening and closing the rear windows using the switches in the rear.

If an accident of a certain severity occurs, the safety function is switched off automatically.

Overview

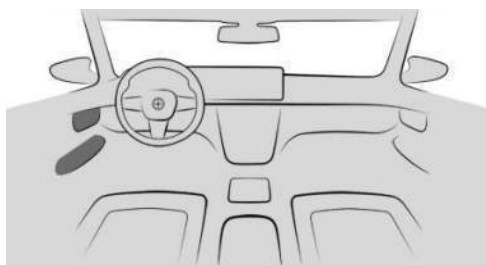

-  The safety switch is located on the driver's door.

Turning the safety functions on/off

-  To activate/deactivate the safety function, press the safety switch on the driver's door.

The LED in the button illuminates when the safety function is switched on.

Glass sunroof

Safety information

Warning

Body parts can be jammed when operating the glass sunroof. There is a risk of injury. Make sure that the area of movement of the glass sunroof is clear during opening and closing.

With the vehicle key

Opening glass sunroof



Press and hold the button on the vehicle key after unlocking.

The glass sunroof with sun protection will be opened for as long as the button on the vehicle key is pressed.

Closing glass sunroof



With Comfort Access: press and hold the button on the vehicle key in close range of the vehicle after locking.

The glass sunroof with sun protection will be closed for as long as the button on the vehicle key is pressed.

Depending on the vehicle equipment, exterior mirrors are folded in unless they were folded in while locking. The exterior mirrors are not folded in when the hazard warning flashers are switched on.

On the door handle

Principle

The glass sunroof can be closed using the door handle without operating the vehicle key. The vehicle key is automatically detected near the vehicle.

Functional prerequisite

Carry the vehicle key with you, for instance in your pants pocket.

Closing glass sunroof

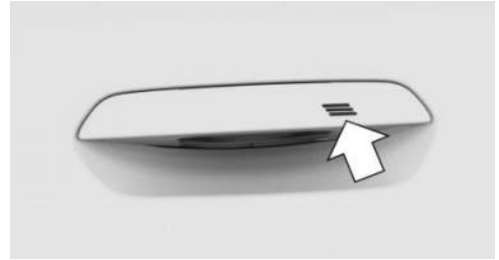

Touch the grooved surface on the external door handle of a closed door with your finger and hold it there without grasping the recessed grip.

In addition to locking, the windows and glass sunroof with sun protection will be closed.

Depending on the vehicle equipment, exterior mirrors are folded in unless they were folded in while locking. The exterior mirrors are not folded in when the hazard warning flashers are switched on.

Inside the vehicle

Functional requirements

The glass sunroof and sun protection can be operated under the following conditions.

- ▶ Standby state is switched on.
- ▶ Drive-ready state is switched on.

The vehicle key must be inside the vehicle.

General information

The glass sunroof and the sun protection are operated using the same switch.

Overview

Button in the vehicle

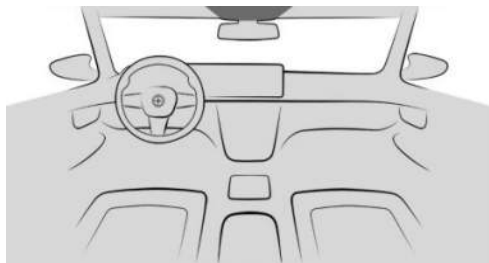

Opening/closing the glass sunroof/sun protection.

Lifting/closing glass sunroof



Push switch briefly upward.

- ▶ The closed glass sunroof tilts and the sun protection opens slightly.
- ▶ The opened glass sunroof closes until it is in the tilted position. The sun protection does not move.

- ▶ The tilted glass sunroof closes.

Opening/closing the glass sunroof and sun protection separately



- ▶ Slide switch back to the resistance point and hold.

Holding down the switch opens the sun protection. If the sun protection is already fully open, the glass sunroof opens.

- ▶ Slide switch forward to the resistance point and hold.

The glass sunroof closes while the switch is being held. If the glass sunroof is already

closed or in the tilted position, the sun protection closes.

- ▶ Slide the switch back past the resistance point.

The sun protection opens automatically. If the sun protection is already fully open, the glass sunroof opens automatically.

Pressing the switch again stops the motion.

- ▶ Push the switch forward past the resistance point.

The glass sunroof closes automatically. If the glass sunroof is already closed or in the tilted position, the sun protection closes automatically.

Pressing the switch again stops the motion.

Opening/closing the glass sunroof and sun protection together



- ▶ Briefly press out the switch twice in succession toward the rear past the resistance point.

The glass sunroof and sun protection open together.

Pressing the switch again stops the motion.

- ▶ Briefly press out the switch twice in succession toward the front past the resistance point.

The glass sunroof and sun protection close together.

Pressing the switch again stops the motion.

Comfort position

In some models, the wind noises in the car's interior are lowest when the glass sunroof is not fully open. In these models, the automatic function initially only opens the glass sunroof up to this comfort position.

Operating the switch inside the vehicle again opens the glass sunroof completely.

Anti-trap mechanism

Principle

The anti-trap mechanism prevents objects or body parts from becoming jammed between the roof frame and glass sunroof while the glass sunroof is closing.

General information

If a resistance or blockage is detected while the glass sunroof is closing, the closing operation is interrupted once the roof reaches the half-open position, or it is stopped when closing from the tilted position.

Closing from the open position without the anti-trap mechanism

If an external hazard or ice prevents normal closure, proceed as follows:



1. Close all doors.
2. Switch on drive-ready state or stop a moving vehicle.
3. Push the switch forward past the resistance point and hold.

The glass sunroof closes with limited anti-trap mechanism. If the closing force exceeds a specific threshold, closing is interrupted.

4. Push the switch forward again past the resistance point and hold until the glass sunroof closes without the anti-trap mechanism. Make sure that the closing path is clear.

Closing from the lifted position without the anti-trap mechanism

In case of danger from the outside or if icing might prevent normal closing, proceed as follows:

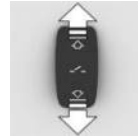

1. Close all doors.
2. Switch on drive-ready state or stop a moving vehicle.
3. Push the switch forward past the resistance point and hold.

Initializing after a power interruption

General information

After a power interruption during the opening or closing process, the glass sunroof can only be operated to a limited extent. Initializing the system can help in this case.

The system can be initialized under the following conditions:

- ▷ The vehicle is parked in a horizontal position.
- ▷ The vehicle will not be moved until the initialization is completed.
- ▷ The drive-ready state is established.
- ▷ The outside temperature is above 41 °F/5 °C.

During initialization, the glass sunroof closes without the anti-trap mechanism.

Make sure that the closing path is clear.

Initializing the system



Press the switch up and hold it until the initialization is complete:



Initialization begins within 15 seconds.

- ▷ If the glass sunroof is closed, it opens then closes again.
- ▷ If the glass sunroof is open, it first closes, then opens and closes again.
- ▷ The sun protection is initialized in the closed position.

Initialization is complete once the glass sunroof and the sun protection have opened then closed again.

Seats, mirrors and steering wheel

Vehicle features and options

This chapter describes model-specific equipment, systems, and functions that are currently available, or may become available in the future, even if they are not present in the vehicle.

Additional information:

Vehicle equipment, refer to page 8.

Sitting safely

An ideal seat position that meets the needs of the occupants can make a vital contribution to relaxed, fatigue-free driving.

In the event of an accident, the correct seat position plays an important role. Follow the information in the following chapters.

Additional information:

- ▶ Seats, refer to page 103.
- ▶ Seat belts, refer to page 107.
- ▶ Head restraints, refer to page 109.
- ▶ Airbags, refer to page 169.

Seats

Safety information

Warning

Seat setting while driving can lead to unexpected movements of the seat. Vehicle control could be lost. There is a risk of accident, injury, and property damage. Only adjust the seat on the driver's side when the vehicle is stationary.

Warning

With a backrest inclined too far to the rear, the protective effect of the seat belt can no longer be ensured. There is a risk of sliding under the seat belt in an accident. There is a risk of injury or danger to life. Adjust the seat prior to starting the trip. Adjust the backrest so that it is in the most upright position as possible and do not adjust again while driving.

Warning

There is a danger of jamming when moving the seats. There is a risk of injury and risk of property damage. Make sure that the travel path of the seat is clear prior to any adjustment.

Manually adjustable seats

Overview



The levers for setting the seats are located on the front seats.

Setting the longitudinal direction

Warning

If a seat is not locked, it may move unexpectedly while driving. Vehicle control could be lost. There is a risk of accident, injury, and property damage. After adjusting, move the seat forward or back slightly, making sure the seat engages properly.



Pull the lever and slide the seat in the desired direction.

Adjusting seat tilt

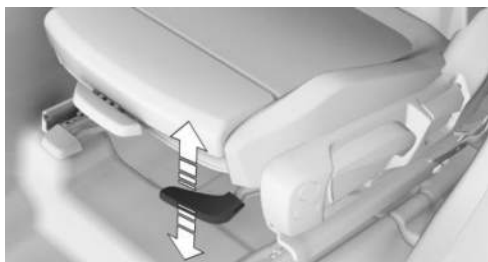

Pull the lever up or press it down as often as needed until the seat has reached the desired inclination.

Adjusting the height

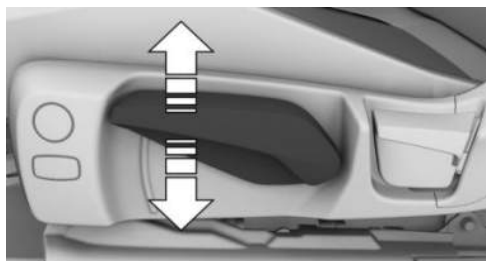

Pull the lever up or press it down as often as needed until the seat has reached the desired height.

Adjusting backrest tilt

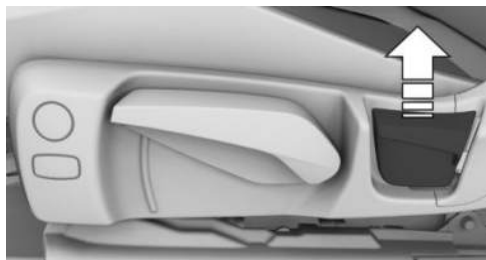

Pull the lever and apply your weight to the backrest or lift it off, as necessary.

Electrically adjustable seats

General information

The current seat position can be stored using the memory function.

Overview



The switches for setting the seats are located on the front seats.

Adjusting seat tilt

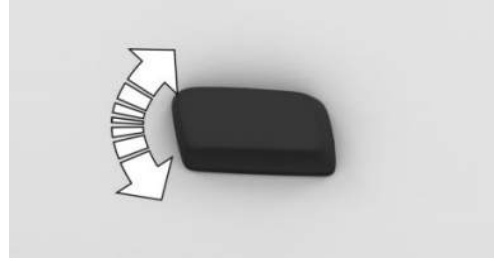

Tilt switch up or down.

Setting the longitudinal direction

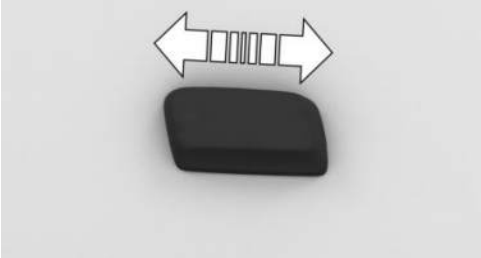

Press switch forward or backward.

Adjusting backrest tilt

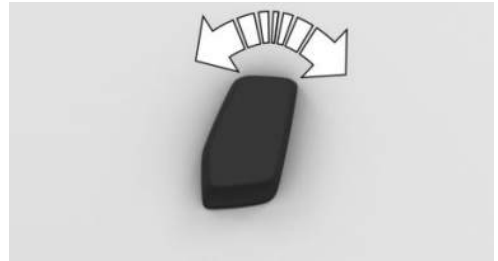

Tilt switch forward or backward.

Adjusting the height

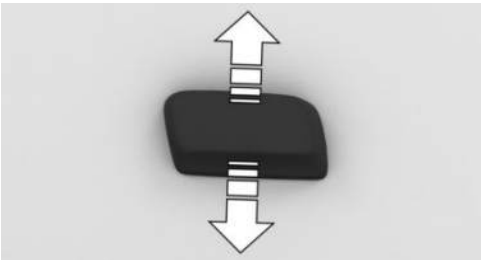

Press switch up or down.

Adjusting the seat position automatically

General information

The seat setting for the driver's seat is stored in the active BMW ID or in the active driver profile. If the BMW ID or the driver profile is reactivated at a later time, the saved position will be called up automatically.

Activate/deactivate the function

1.  Apps menu
2. "Vehicle"
3. "Seat comfort"
4. Select driver's seat.
5. "Use automatically"
6. Select the desired setting.



Thigh support

Sport seat

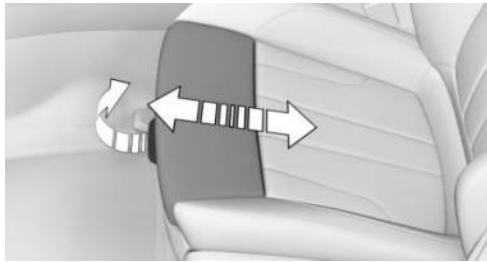

Pull the lever at the front of the seat and push the thigh support forward or back.

Lumbar support

Principle

The curvature of the seat backrest can be adjusted in a way that it supports the lumbar region of the spine. The lower back and the spine are supported for upright sitting position.

Adjusting the lumbar support



- ▶ Press the front/rear section of the button:
The curvature is increased/decreased.
- ▶ Press the upper/lower section of the button:
The curvature is shifted up/down.

Functional limitation

It may not be possible to adjust the lumbar support at very high and very low temperatures.

Backrest width

Principle

Adjusting the backrest width may improve side support when cornering.

General information

The backrest width is changed by adjusting the side sections of the backrest.

Adjusting the backrest width



- ▶ Press the front section of the button:
The backrest width decreases.
- ▶ Press the rear section of the button:
The backrest width increases.

Functional limitation

It may not be possible to adjust the backrest width at very high and very low temperatures.

Calibrating the front seats

General information

As soon as the electric seat setting no longer functions precisely, a Check Control message is displayed on the control display.

To restore the accuracy of the electric seat setting, the front seats must be calibrated.

Safety information

Warning

There is a danger of jamming when moving the seats. There is a risk of injury and risk of property damage. Make sure that the travel path of the seat is clear prior to any adjustment.

Calibrating the front seat

1. Press the longitudinal direction switch forward until the seat stops.
2. Press the switch forward again until the seat stops.

As soon as the message on the control display disappears, the calibration is complete. If the message remains active, repeat the calibration.

If the message is still shown after repeated calibration, have the vehicle checked by an authorized service center or another qualified service center or repair shop.

Seat belts

General information

The vehicle is fitted with five seat belts to ensure occupant safety. However, they can only offer protection when adjusted correctly.

Always make sure that seat belts are being worn by the occupants before driving off. The airbags supplement the seat belts as an additional safety device. The airbags do not replace seat belts.

All seat belt anchorage points are designed to achieve the best possible protective effect for the seat belts when used properly and with the correct seat settings.

The two outer seat belt buckles of the rear seats are intended for the persons sitting on the left and right.

The center seat belt buckle of the rear seats is intended for the person sitting in the middle.

Additional information:

Notes on sitting safely, refer to page [103](#).

Safety information

Warning

Use of a seat belt to buckle more than one person will potentially defeat the ability of the seat belt to serve its protective function. There is a risk of injury or danger to life. Do not strap in more than one person per single seat belt. Infants and children are not allowed on an occupant's lap, and must be transported and secured in designated child restraint systems.

Warning

The protective effect of safety gear, including seat belts, can be limited or lost when seat belts are fastened incorrectly. An incorrectly fastened seat belt can cause additional injuries, for instance in the event of an accident, braking or evasive maneuvers. There is a risk of injury or danger to life. Make sure that all occupants are wearing seat belts correctly.

Warning

With a rear seat backrest that is not locked, the protective effect of the middle seat belt is not guaranteed. There is a risk of injury or danger to life. If you are using the middle seat belt, lock the wider rear seat backrest.

Warning

The protective effect of safety gear, including seat belts, may not be fully operational or fail in the following situations:

- ▷ The seat belts or seat belt buckles are damaged, soiled, or changed in any other way.
- ▷ Seat belt tensioners or seat belt winders were modified.

Seat belts can be imperceptibly damaged in the event of an accident. There is a risk of injury or danger to life. Keep clean and do not modify: seat belts, seat belt buckles, seat belt tensioners, seat belt winders, and seat belt anchors. After an accident, have the seat belts checked by an authorized service center or another qualified service center or repair shop.

To ease accessibility to the seat belt buckle, an adjustable slider is available on the belt to help position the buckle when not in use.

Unbuckling the seat belt

1. Hold down the seat belt firmly.
2. Press the red button in the seat belt buckle.
3. Guide the seat belt back into the seat belt winder.

Correct use of seat belts

- ▶ Wear the seat belt tight to your body over your lap and shoulders, without twisting it.
- ▶ Wear the seat belt deep on your hips over your lap. The seat belt must not press on your stomach.
- ▶ Do not rub the seat belt against sharp edges, or guide it or jam it in across hard or fragile objects.
- ▶ Avoid thick clothing.
- ▶ Re-tighten the seat belt frequently upward around your upper body area.
- ▶ Center seat belt in the rear: after buckling the seat belt, pull the seat belt buckle up to the resistance from the mount.

Seat belt reminder

General information

Make sure that the seat belts are positioned correctly.

The seat belt reminder becomes active in the following situations:

- ▶ When the seat belt on the driver's side or on the passenger's side is not fastened.
- ▶ When the seat belt is unfastened while driving.
- ▶ When objects are lying on a seat.

Buckling the seat belt



1. Guide the seat belt slowly over shoulder and hip to put it on.
2. Insert the buckle tongue into the seat belt buckle. The seat belt buckle must engage audibly.

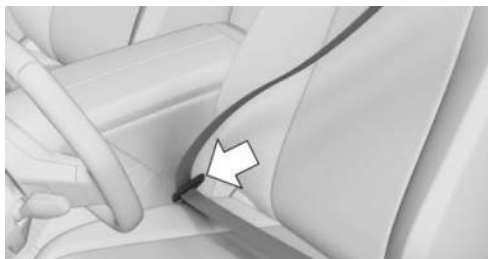

Display in the instrument cluster

The indicator light in the instrument cluster illuminates after turning on the drive-ready state when the seat belt reminder is active.

A Check Control message is displayed where applicable. Check whether the seat belt has been fastened correctly.



Icon	Meaning
	Seat belt on the driver's seat is not buckled.
	Seat belt on the passenger seat or another seat in the vehicle is not buckled.

Icon	Meaning
	Seat belt is buckled on the corresponding seat.
	Seat belt is not buckled on the corresponding seat.

Rear Occupant Alert

Principle

At the end of a trip, the system informs the driver of the possible presence of occupants on the rear seats.

General information

If a door with access to the rear seat row is operated within 30 minutes before starting a drive, a notice appears on the control display and a signal tone sounds at the end of the drive.

If the drive is continued within 30 minutes, the notice is displayed again after the drive is complete.

Activate/deactivate the function

-  Apps menu
- "System settings"
- "Rear Occupant Alert"
- Select the desired setting.

Safety mode

Depending on vehicle equipment, the driver and front passenger seat belt straps are automatically tightened once after driving off, if the seat belt is fastened.

If necessary, in critical driving situations, e.g., during emergency braking, the front seat belts are automatically pretensioned.

After a critical driving situation without an accident, the front seat belts are loosened again. If the belt tension does not loosen automatically,

stop the vehicle and unbuckle the seat belt using the red button in the buckle. Fasten the seat belt before continuing to drive.

Front head restraints

Safety information

Warning

Removal or incorrect adjustment of head restraints can cause injuries in the head and neck area. There is a risk of injury.

- ▷ Before driving, install the removed head restraints on the occupied seats.
- ▷ Adjust the head restraint so its center supports the back of the head at as close to eye level as possible.
- ▷ Adjust the distance so that the head restraint is as close as possible to the back of the head. Adjust the distance via the backrest tilt as needed.
- ▷ For manually adjustable head restraints: After adjusting, make sure that the head restraint is correctly engaged.

Warning

Body parts can be jammed when moving the head restraint. There is a risk of injury. Make sure that the area of movement is clear when moving the head restraint.

Warning

Objects on the head restraint reduce the protective effect in the head and neck area. There is a risk of injury.

- ▷ Do not use seat or head restraint covers.
- ▷ Do not hang objects, for instance clothes hangers, directly on the head restraint.

- ▷ Only use accessories that have been determined to be safe for attachment to a head restraint.
- ▷ Do not use any accessories, for instance pillows, while driving.

Adjusting the height

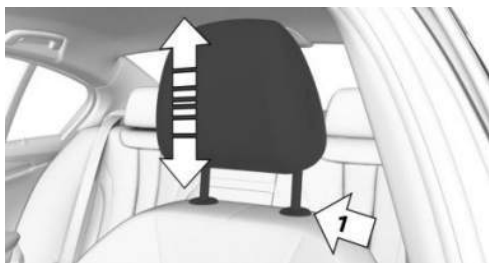

- ▷ To lower: press the button, arrow 1, and push the head restraint down.
- ▷ To raise: push the head restraint up.

Adjusting the height: M Sport seat

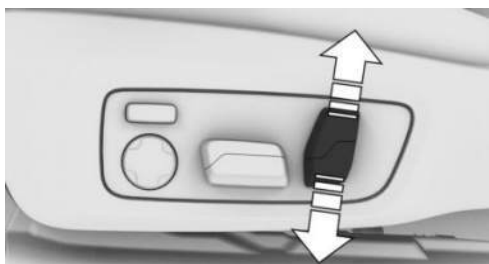

Press switch up or down.

Adjusting the distance



- ▷ Back: press the button and push the head restraint toward the rear.
- ▷ Forward: pull the head restraint toward the front.

Adjusting the distance: M Sport seat

The distance to the back of the head is adjusted via the backrest inclination.

Adjust the distance so that the head restraint is as close as possible to the back of the head.

Removing the head restraints

Only remove the head restraint if no one will be sitting in the seat in question.

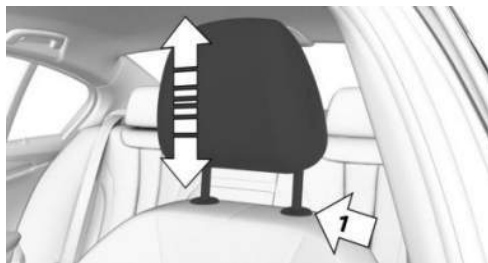

1. Raise the head restraint up against the resistance.
2. Press the button, arrow 1, and pull the head restraint out completely.

Removing the head restraints: M Sport seat

The head restraints cannot be removed.

Installing head restraints

Proceed in the reverse order to install the head restraint.

Rear head restraints

Safety information

Warning

Removal or incorrect adjustment of head restraints can cause injuries in the head and neck area. There is a risk of injury.

- ▷ Before driving, install the removed head restraints on the occupied seats.
- ▷ Adjust the head restraint so its center supports the back of the head at as close to eye level as possible.
- ▷ Adjust the distance so that the head restraint is as close as possible to the back of the head. Adjust the distance via the backrest tilt as needed.
- ▷ For manually adjustable head restraints: After adjusting, make sure that the head restraint is correctly engaged.

Warning

Body parts can be jammed when moving the head restraint. There is a risk of injury. Make sure that the area of movement is clear when moving the head restraint.

Warning

Objects on the head restraint reduce the protective effect in the head and neck area. There is a risk of injury.

- ▷ Do not use seat or head restraint covers.
- ▷ Do not hang objects, for instance clothes hangers, directly on the head restraint.

- ▷ Only use accessories that have been determined to be safe for attachment to a head restraint.
- ▷ Do not use any accessories, for instance pillows, while driving.

Folding down the head restraints

General information

To improve the view to the rear, the head restraints can be folded down. Only fold down the head restraint if no one will be sitting in the corresponding seat.

Folding down the head restraints

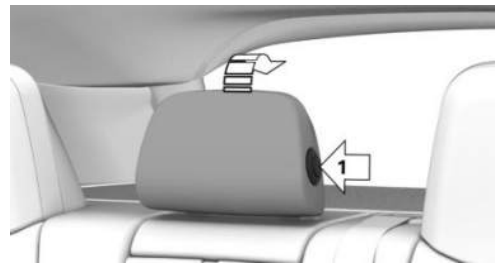

Press button, arrow 1, and fold the head restraint back.

To return the head restraint to its initial position, fold the head restraint forward as far as it will go. Make sure that the head restraint engages correctly.

Removing the outer head restraint

Only remove the head restraint if no one will be sitting in the seat in question.

1. Fold down the rear seat backrest in question.
Enlarging the cargo area, refer to page 273.
2. Raise the head restraint up against the resistance.
3. Insert the integrated key.

Integrated key, refer to page 76.

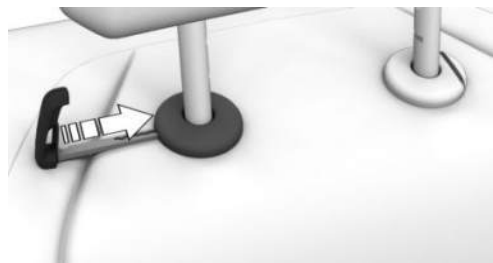

4. Press and hold the integrated key and the button at the same time, arrows 1, and pull out the head restraint completely.



Removing the center head restraint

Only remove the head restraint if no one will be sitting in the center seat.

1. Raise the head restraint up against the resistance.
2. Press the buttons, arrow 1, and pull the head restraint out completely.

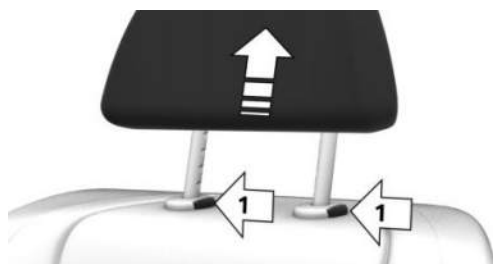

Installing the head restraints

For installation, insert the head restraints in the mounts and slide them down until you feel resistance.

Exterior mirrors

General information

The front passenger's side exterior mirror is more curved than the driver's side mirror.

The exterior mirror adjustment is stored in the active BMW ID or in the active driver profile. If the BMW ID or the driver profile is reactivated at a later time, the stored position is called up automatically.

The current exterior mirror adjustment can be stored using the memory function.

Depending on vehicle equipment, the driver's side exterior mirror also dims automatically. Photocells in the interior mirror are used to control this.

Depending on vehicle equipment, both exterior mirrors are heated automatically as necessary and when drive-ready state is on.



Safety information

Warning

Objects in the mirror are closer than they appear. The distance to the road users behind could be incorrectly estimated, for instance while changing lanes. There is a risk of accident, injury, and property damage. Estimate the distance to the traffic behind by looking over your shoulder.

Overview



Icon	Meaning
	Fold the exterior mirror in and out.
	Adjust the exterior mirrors.
	Select exterior mirror, Automatic Curb Monitor.

Adjusting the exterior mirrors

-  Press the button.
The selected exterior mirror moves along with the button movement.

Selecting the exterior mirror

-  To change over to the other mirror:
Slide the switch.

Malfunction

In case of an electrical malfunction, adjust the exterior mirror by pressing on the edges of the mirror glass.

Folding in/folding out the exterior mirrors

NOTICE

Depending on the vehicle width, the vehicle can be damaged in car washes. There is a risk of property damage. Before washing, fold in the mirrors by hand or with the button.



Press the button.

Folding is possible at vehicle speeds of up to approx. 12 mph/20 km/h.

Folding the exterior mirrors in and out is helpful in the following situations:

- ▶ In car washes.
- ▶ On narrow roads.

Exterior mirrors that were folded in are folded out automatically at a speed of approx. 25 mph/40 km/h.

Automatic heating

Both exterior mirrors are automatically heated as needed and when the drive-ready state is switched on.

Automatic dimming

The exterior mirror on the driver's side is automatically dimmed. Photocells in the interior mirror are used to control this.

Automatic Curb Monitor

Principle

If reverse gear is engaged, the mirror glass on the passenger's side is tilted downward. This improves your view of the curb and other low-lying obstacles when parking, for instance.

Activating the Automatic Curb Monitor



1. Slide the switch to the driver's side mirror position.
2. Engage selector lever position R.

Deactivating the Automatic Curb Monitor

Slide the switch to the front passenger's side exterior mirror position.

Interior mirror, manually dimmable



To reduce the blinding glare of the interior mirror, flip the lever forward.

Interior mirror, automatic dimming feature

General information

The interior mirror is dimmed automatically. Photocells are used for control:

- ▷ In the mirror glass.
- ▷ On the rear of the mirror.

Overview



Functional requirements

- ▷ Keep the photocells clean.
- ▷ Do not cover the area between the interior mirror and the windshield.

Steering wheel

Safety information

Warning

Steering wheel adjustments while driving can lead to unexpected steering wheel movements. Vehicle control could be lost. There is a risk of accident, injury, and property damage. Adjust the steering wheel while the vehicle is stationary only.

Manual steering wheel adjustment

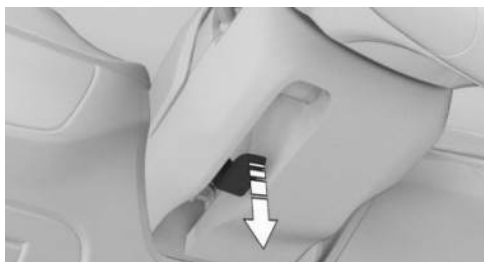

1. Fold the lever down completely.
2. Grip the steering wheel with both hands and move the steering wheel to the preferred height and angle to suit your seat position.
3. Fold the lever back up.

Memory function

Principle

The following settings can be stored and, if necessary, retrieved using the memory function:

- ▶ Seat position.
- ▶ Exterior mirror adjustment.
- ▶ Height of the Head-up display.

General information

Two memory locations with different settings can be set for each driver profile.

The following settings are not stored:

- ▶ Backrest width.
- ▶ Lumbar support.

Safety information

Warning

Using the memory function while driving can lead to unexpected seat or steering wheel movements. Vehicle control could be lost. There is a risk of accident, injury, and property damage. Only retrieve the memory function when the vehicle is stationary.

Warning

There is a danger of jamming when moving the seats. There is a risk of injury and risk of property damage. Make sure that the travel path of the seat is clear prior to any adjustment.

Overview



The memory buttons are located on the front doors.

Storing settings

1. Set the desired position.
2.  Press the button. The LED illuminates.
3. Press the desired memory button 1 or 2 while the LED is illuminated. A signal sounds.

Calling up settings

Press the desired memory button 1 or 2.

The stored position is called up.

The procedure stops when a seat setting switch or one of the memory buttons is pressed again.

The adjustment of the seat position on the driver's side is interrupted after a short time while driving.

Seat climate control

Various climate control functions are available for the seats.

Additional information:

Climate control, refer to page [248](#).

Transporting children safely

Vehicle features and options

This chapter describes model-specific equipment, systems, and functions that are currently available, or may become available in the future, even if they are not present in the vehicle.

Additional information:

Vehicle equipment, refer to page 8.

The right place for children

Safety information

Warning

Unattended children or animals in the vehicle can cause the vehicle to move and endanger themselves and traffic, for example, due to the following actions:

- ▷ Establishing standby.
- ▷ Releasing the parking brake.
- ▷ Opening and closing the doors or windows.
- ▷ Engaging selector lever position N.
- ▷ Using vehicle equipment.

There is a risk of accident, injury, and property damage. Do not leave children or animals unattended in the vehicle. Take the vehicle key with you when exiting and lock the vehicle.

Warning

A hot vehicle may result in death to persons, especially children, or animals. There is a risk of injury or danger to life. Do not leave people, especially children, or animals unattended in the vehicle.

Warning

Exposure to intense sunlight can cause child restraint systems and their components to become very hot. Persons may sustain burn injuries when touching the hot components. There is a risk of injury. Do not expose the child restraint system to direct sunlight or cover where necessary. If necessary, let the child restraint system cool down before transporting a child. Do not leave children unattended in the vehicle.

Children in the rear seat

General information

Accident research shows that the safest place for children is in the rear seat.

Children younger than 13 years of age or shorter than 5 ft/150 cm should be transported in the rear seat in suitable child restraint systems designed for the age, weight and size of the child. Children 13 years of age or older must wear a seat belt as soon as a suitable child restraint system can no longer be used due to their age, weight, or size.

Safety information

Warning

The seat belt cannot be fastened correctly on children shorter than 5 ft/150 cm without suitable additional child restraint systems. The protective effect of safety gear, including seat belts, can be limited or lost when seat belts are fastened incorrectly. An incorrectly fastened seat belt can cause additional injuries, for instance in the event of an accident, braking or evasive maneuvers. There is a risk of injury or danger to life. Secure children shorter than 5 ft/150 cm using suitable child restraint systems.

Children on the front passenger seat

General information

When using a child restraint system on the front passenger seat, make sure that the front passenger airbag is deactivated.

Additional information:

Automatic deactivation of front passenger airbag, refer to page [171](#).

Safety information

Warning

Active front passenger airbags can injure a child in a child restraint system when the airbags are deployed. There is a risk of injury. Make sure that the front passenger airbags are deactivated and that the PASSENGER AIRBAG OFF indicator light illuminates.

Installing child restraint systems

General information

Pay attention to the specifications and the operating and safety information of the child restraint system manufacturer when selecting, installing, and using child restraint systems.

Safety information

Warning

The protective effect of child restraint systems and their fastening systems which have been damaged or exposed to an accident can be limited or lost. A child cannot be properly restrained in the event of an accident, braking or evasive maneuvers. There is a risk of injury or danger to life.

Do not use child restraint systems which have been damaged or exposed to an accident.

If attachment systems have been damaged or strained by an accident, have them checked and replaced by an authorized service center or another qualified service center or repair shop.

Warning

The stability of the child restraint system is limited or compromised with incorrect seat setting or improper installation of the child seat. There is a risk of injury or danger to life. Make sure that the child restraint system fits securely against the backrest. If possible, adjust the backrest tilt for all affected backrests and correctly adjust the seats. Make sure that seats and backrests are securely engaged or locked. If possible and necessary, adjust the height of the head restraints or remove them.

On the front passenger seat

Deactivating the airbag

Warning

Active front passenger airbags can injure a child in a child restraint system when the airbags are deployed. There is a risk of injury. Make sure that the front passenger airbags are deactivated and that the PASSENGER AIRBAG OFF indicator light illuminates.

After mounting a child restraint system on the front passenger seat, make sure that the front passenger airbag is deactivated.

Additional information:

Automatic deactivation of front passenger airbag, refer to page 171.

Seat position and height

After installing a child restraint system, move the front passenger seat as far back as it will go and, if possible, bring it up to the highest position. This seat position and height ensure the best possible position for the belt and offers optimal protection in the event of an accident.

After mounting a universal child restraint system, adjust the tilt of the seat backrest so that the belt is not constrained.

If the upper attachment point of the seat belt is located in front of the seat belt guide of the child seat, move the front passenger seat carefully forward until the best possible seat belt guide position is reached.

Backrest width

Adjustable backrest width: Before installing a child restraint system on the front passenger seat, open the backrest width completely. Do not change the backrest width again and do not call up a memory position.

Child seat security



The seat belts in the rear and the front passenger seat belt can be permanently locked to fasten child restraint systems.

Locking the seat belt

1. Pull out the seat belt strap completely.
2. Secure the child restraint system with the seat belt.
3. Allow the seat belt strap to be pulled in and pull it tight against the child restraint system. The seat belt is disabled.

Unlocking the seat belt

1. Unbuckle the seat belt buckle.
2. Remove the child restraint system.
3. Allow the seat belt strap to be pulled in completely.

Lower anchors for child restraint systems

General information

LATCH: Lower Anchors and Tether for Children.

Pay attention to the specifications, operating tips and safety instructions from the child restraint system manufacturer when selecting, installing, and using child restraint systems.



Mounts for lower anchors

General information

The lower anchors may be used to attach the CRS to the vehicle seat up to a combined child and CRS weight of 65 lbs/30 kg when the child is restrained by the internal harnesses.

Safety information

Warning

If the lower anchors on child restraint system are not engaged correctly, the child restraint system will not be able to provide suitable protection. There is a risk of injury or danger to life. Make sure that the lower anchors are correctly engaged and that the child restraint system fits securely against the backrest.

Warning

The mounts for the lower anchors and attachment points of the child restraint system are intended for attaching child restraint systems only. If other objects are attached, the mounts or attachment points can be damaged. There is a risk of injury and risk of property damage. Only attach child restraint systems at the corresponding mounts for the lower anchors or attachment points.

Position

Icon	Meaning
	<p>The corresponding icon shows the mounts for the lower LATCH anchors.</p> <p>Seats equipped with lower anchors are marked with a pair (2) of LATCH icons.</p> <p>For vehicles equipped with a middle seat:</p> <p>It is not recommended to use the inner lower anchors of standard outer LATCH positions to fasten a child restraint system on the middle seat. Use the vehicle seat belt instead for the middle seat.</p>

Before attaching child restraint systems

Before installing a child restraint system, pull the seat belt away from the lower anchors of the child restraint system.

Installing child restraint systems

1. Mount child restraint system, see manufacturer's information.
2. Make sure that the child restraint system mount is correctly engaged in the lower anchor on both sides.

Child restraint systems with tether strap

General information

When attaching child restraint systems to the upper attachment points, observe the specifications and the operating and safety information of the child restraint system manufacturer.

Safety information

Warning

If the upper retaining strap is incorrectly used for the child restraint system, the protective effect is reduced. There is a risk of injury. Ensure that the upper retaining strap is guided to the upper attachment point without twisting and not over sharp edges.

Warning

If the rear seat backrest is not locked, the protective effect of the child restraint system is limited or nonexistent. In certain situations, for instance braking maneuvers or in case of an accident, the rear seat backrest can fold forward. There is a risk of injury or danger to life. Make sure that the rear seat backrests are locked.

Warning

The mounts for the lower anchors and attachment points of the child restraint system are intended for attaching child restraint systems only. If other objects are attached, the mounts or attachment points can be damaged. There is a risk of injury and risk of property damage. Only attach child restraint systems at the corresponding mounts for the lower anchors or attachment points.

Attachment points for upper retaining strap

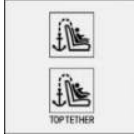
Icon	Meaning
	The respective icon shows the attachment point for the upper retaining strap. Seats with an upper top tether are marked with this icon. It is located on the rear seat backrest, the rear shelf or the rear seat.

Routing the retaining strap

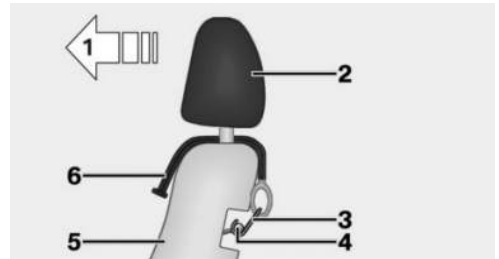

- 1 Driving direction
- 2 Head restraint
- 3 Hook for upper retaining strap
- 4 Attachment point
- 5 Seat backrest
- 6 Upper retaining strap

Attaching the upper retaining strap to the attachment point

1. Outer seats: Guide the upper strap between the head restraint rods, or along both sides of the head restraint rods, to the attachment point.
Center seat: guide the upper strap over the head restraint to the attachment point.
2. If there is a retaining strap, run it between the backrest and the cargo cover.

3. Attach the hook of the retaining strap to the mounting eye.
4. Tighten the retaining strap.

Locking the doors and windows in the rear



General information

In certain situations it may be advisable to secure the rear doors and windows, for instance when transporting children.

Doors



Unlock or lock the safety switch on the rear doors using the integrated key.

Icon	Function
	Child safety lock is unlocked.
	Child safety lock is locked.

The door can now be opened from the outside only.

After locking, make sure that the door cannot be opened from the inside.

Safety switch for rear

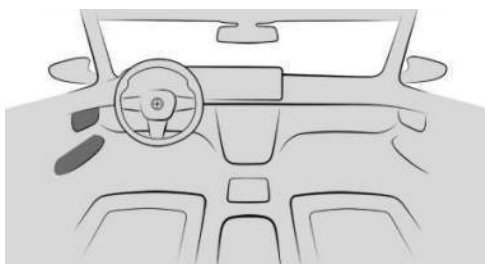

 Press the button on the driver's door. Various functions are locked and cannot be operated in the rear such as the power windows.

Driving

Vehicle features and options

This chapter describes model-specific equipment, systems, and functions that are currently available, or may become available in the future, even if they are not present in the vehicle.

Additional information:

Vehicle equipment, refer to page [8](#).

Start/Stop button

Principle

Pressing the Start/Stop button turns drive-ready state on/off.

General information

Drive-ready state turns on when the brake pedal is pressed while pushing the Start/Stop button.

Pressing the Start/Stop button again turns drive-ready state back off and turns standby state back on.

Drive-ready state cannot be turned on as long as the charging cable is connected or the charging socket cover is open.

Additional information:

- ▶ Drive-ready state, refer to page [47](#).
- ▶ Standby state, refer to page [47](#).
- ▶ Charging cable, refer to page [288](#).

Overview

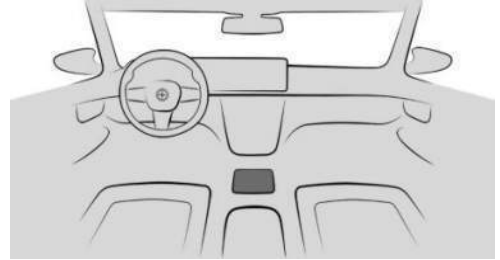

Start/Stop button

Driving off

1. Close the driver's door.
2. Depress brake pedal.
3. Press the Start/Stop button.
4. Engage the desired selector lever position, e.g., D or R.
5. Release the parking brake.
6. To drive off, release the brake pedal and press the accelerator pedal.

Acoustic pedestrian protection

Depending on vehicle equipment and national-market version, Acoustic Pedestrian Protection generates a continuous driving noise in vehicles with electric or electrically assisted drives.

- ▶ With a stationary vehicle and drive-ready state turned on, as soon as the selector lever position P is exited.
- ▶ With electric drive up to approx. 20 mph/30 km/h.

A speaker system broadcasts the noise to the environment. As a result, other road users, for instance pedestrians or cyclists, can better perceive the vehicle.

Drive-ready state in detail

Safety information

Warning

An unsecured vehicle can begin to move and possibly roll away. There is a risk of accident, injury, and property damage. Before leaving the vehicle, secure the vehicle against rolling away.

In order to ensure that the vehicle is secured against rolling away, follow the following:

- ▷ Set the parking brake.
- ▷ Automatic transmission: Make sure that selector lever position P is engaged.
- ▷ On uphill grades or on downhill slopes, turn the front wheels in the direction of the curb.
- ▷ On uphill grades or on downhill slopes, also secure the vehicle, for instance with a wheel chock.

Turning on the drive-ready state

1. Close the driver's door.
2. Depress the brake pedal.
3. Press the Start/Stop button.

A signal tone sounds. Drive-ready state is switched on.

Display in the instrument cluster

The READY display indicates that the vehicle is ready for driving.



READY

Driving off

Functional requirements

Driving is possible when the following prerequisites are met:

- ▷ The state of high-voltage battery charge is sufficient.
- ▷ The driver's door is closed.
- ▷ Charging cable is detached.
- ▷ The charging socket cover is closed.

Driving

1. Turn on drive-ready state.
2. Apply the brake and engage selector lever position D, B, or R.
3. Release the parking brake.
4. Depress the accelerator pedal to drive.

State of charge in strong temperature fluctuations

In the case of strong temperature fluctuations and a low state of charge of the high-voltage battery, it may not be possible to start the vehicle again at the beginning of the next trip. Recharge vehicle with a low state of charge in time.

Selector lever positions

Display

The engaged selector lever position is displayed in the instrument cluster and on the selector lever.

Gear position D

Selector lever position for normal driving.

The vehicle drives off slowly when the brake pedal is released.

R reverse gear

Engage selector lever position R only when the vehicle is stationary.

N Neutral

The vehicle may be pushed or roll without drive, for instance in car washes, in selector lever position N.

Parking position P

Selector lever position for parking the vehicle. In selector lever position P, the drive is blocked.

Engage selector lever position P only when the vehicle is stationary.

Selector lever position P is engaged automatically in situations such as the following:

- ▶ After the drive-ready state is switched off and selector lever position D, R or B is engaged.
- ▶ If the driver's seat belt is unbuckled and the driver's door is opened while the vehicle is stationary and selector lever position D, R, or B is engaged.
- ▶ After standby state is switched off, if selector lever position N is engaged.

Before leaving the vehicle, make sure to engage selector lever position P and apply the parking brake. Otherwise, the vehicle may begin to move.

Additional information:

Parking brake, refer to page [132](#).

B, gear position with highest energy recovery

Principle

Selector lever position B is the gear position with the highest energy recovery.

General information

Selector lever position B offers the following characteristics:

- ▶ High level of energy recovery when the accelerator pedal is released.
- ▶ Major deceleration when releasing the accelerator pedal to a standstill of the vehicle.
- ▶ The vehicle does not drive off when the brake pedal is released.

Engaging selector lever positions

General information

To prevent the vehicle from creeping after you select a gear position or reverse gear, maintain pressure on the brake pedal until you are ready to drive off.

Functional requirements

- ▶ Only when the drive-ready state is switched on and the brake pedal is depressed is it possible to change from selector lever position P to another selector lever position.
- ▶ The selection lever position P cannot be changed until all technical prerequisites are met.
- ▶ Before shifting out of selector lever position P, remove the charging cable from the vehicle; otherwise, the gearshift request will not be executed.

Engage selector lever position R, N, D, B

1. Fasten driver's seat belt.
2. Tilt or pull the selector lever into the desired direction, past a resistance point, if needed. The selector lever automatically returns to the center position when released.



Changing between selector lever position D and B: pull selector lever to D/B.



Engaging selector lever position P



Press button P.

Rolling or pushing the vehicle

General information

In some situations, the vehicle is supposed to roll without its own drive for a short distance, for instance in a car wash or to be pushed.

Engaging selector lever position N

NOTICE

Selector lever position P is automatically engaged when standby state is switched off. The wheels are blocked. There is a risk of property damage. Do not switch off standby if the vehicle is meant to coast, e.g., in a car wash.

1. Switch on drive-ready state while pressing on the brake pedal.
2. If necessary, release the parking brake.
3. If necessary, switch off Automatic Hold.
4. Depress the brake pedal.
5. Touch the selector lever lock and engage selector lever position N.
6. Switch off drive-ready state.

In this way, standby state remains switched on, and a Check Control message is displayed.

The vehicle can roll.

Irrespective of standby state, the selector lever position P is automatically engaged after approx. 35 minutes.

If the system is not operational, you may not be able to change the selector lever position.

Electronically unlock the transmission lock, if needed.

Electronic unlocking of the transmission lock

General information

Unlock the transmission lock electronically, e.g., to maneuver the vehicle out of a hazardous area in the event of a malfunction.

Before unlocking the transmission lock, secure the vehicle against rolling away, for instance with a wheel chock.

Engaging selector lever position N

1. Quickly press the Start/Stop button three times without pressing the brake.
2. Depress the brake pedal.
3. Press the selector lever to position N until position N is shown on the selector lever.
An appropriate Check Control message is displayed.
4. Maneuver the vehicle from the hazardous area and secure it against rolling away.

Turning off drive-ready state

Park the vehicle. Noises from the electrical system such as for cooling the high-voltage system might still be audible.

After stopping the vehicle:

1. Apply brake and engage the selector lever in position P.
2. Set the parking brake.
3. Press the Start/Stop button.

The READY indicator goes out and a signal tone sounds.

The drive-ready state is switched off automatically if the driver's seat belt is not buckled when the driver's door is opened.

If leaving the vehicle stationary for longer periods, follow the instructions in the Mobility chapter.

Additional information:

Service life of the high-voltage battery, long stationary periods, and taking the vehicle out of service, refer to page 299.

Driving in detail: eDRIVE

Safety information

Warning

The braking effect of the electric motor can be stronger than for a vehicle with combustion engine. Abrupt braking and slow-down may confuse other road users. There is a risk of accident, injury, and property damage. Carefully release the accelerator pedal. Adjust driving style to traffic conditions. Watch surrounding traffic closely and actively intervene where appropriate

Warning

When driving in electric mode, pedestrians and other road users might pay less attention to the vehicle due to the lack of engine noise. There is a risk of accident, injury, and property damage. Adjust driving style to traffic conditions. Watch surrounding traffic closely and actively intervene where appropriate

Warning

Without energy recovery, the braking effect of the electric motor is unavailable. The vehicle could roll further than anticipated. There is a risk of accident, injury, and property damage. Adjust driving style to traffic conditions. Watch surrounding traffic closely and actively intervene where appropriate

Accelerator pedal positions, displays

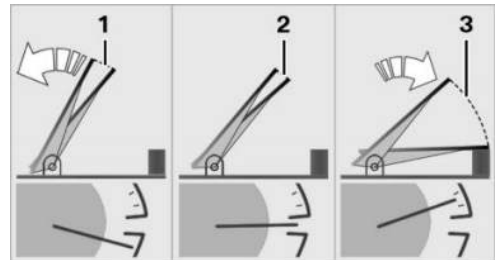

- 1 Deceleration and recuperative braking
- 2 Rolling
- 3 Acceleration or constant speed: ePOWER



Deceleration and recuperative braking

Deceleration

The degree of the deceleration depends on the selector lever position, the energy recovery setting and the driving situation.

Depending on the degree of the deceleration, the brake lights will come on without depressing the brake pedal.

Deceleration is very pronounced in selector lever position B.

During the deceleration, energy is recovered and the high-voltage battery is charged.

Reduced deceleration

Warning

Without energy recovery, the braking effect of the electric motor is unavailable. The vehicle could roll further than anticipated. There is a risk of accident, injury, and property damage. Adjust driving style to traffic conditions. Watch surrounding traffic closely and actively intervene where appropriate

In the event of danger such as with locked wheels, energy recovery and thus deceleration is reduced in order to prevent unstable driving situations.

Energy recovery

Energy recovery is also called recuperation.

With energy recovery, the electric motors act as alternators when decelerating and convert the kinetic energy of the vehicle to electrical energy.

The high-voltage battery is recharged in part through energy recovery.

Energy can be recovered if the following conditions are met:

- ▶ The vehicle is moving.
- ▶ Selector lever position B, D or R is set.
- ▶ The accelerator pedal is not depressed or only slightly depressed.

The energy recovery is displayed in the instrument cluster.

Additional information:

Power gauge, refer to page 148.

Energy cannot be recovered in the following situations, for instance:

- ▶ Selector lever position N is engaged.
- ▶ While drive stability control systems are active or adjusting the vehicle, even though this is not indicated by an indicator light.
- ▶ The high-voltage battery is fully charged.
- ▶ When temperature of the high-voltage battery is very low or very high.
- ▶ The drive's operating temperature is too high.

In winter the energy recovery may be temporarily unavailable after startup.

Driving situations for energy recovery

If deceleration is foreseeable while driving, this can be used for energy recovery.

The following driving situations may be suitable for this:

- ▶ Decelerating downhill.
- ▶ Deceleration before a red traffic light.

Avoid late or strong braking. Instead, decelerate the vehicle using energy recovery.

Strength of recuperative braking

In selector lever position B, the energy recovery is high and the deceleration is pronounced.

For driving in selector lever position D, the strength of recuperative braking can be adjusted via iDrive.

- ▶ Adaptive energy recovery: energy recovery and deceleration are automatically adapted to the respective driving situation.
- ▶ High energy recovery: the vehicle decelerates fast, and more energy is returned to the high-voltage battery.
- ▶ Average energy recovery.
- ▶ Low energy recovery: the vehicle decelerates more slowly, and less energy is returned to the high-voltage battery.

Additional information:

Adaptive recuperation, recuperative braking, refer to page [283](#).

Setting the strength of energy recovery

1.  Apps menu
2. "Vehicle"
3. "Driving settings"
4. "Drivetrain and chassis"
5. "Energy recovery in D"
6. Select the desired setting.

What to do if high-voltage battery is fully charged

If the high-voltage battery is fully charged, the electric motor will be unable to recover additional energy when driving off. To maintain the usual level of deceleration from energy recovery, the vehicle is decelerated by its normal brake when the accelerator pedal is released. This can cause the brake to overheat in certain situations, e.g., when driving downhill or applying continuous, gentle braking.

A Check Control message is displayed.

As such, the driver must apply the brake when driving on long downhill stretches with a fully charged high-voltage battery.

If necessary, adjust your charging strategy, e.g., do not fully charge the high-voltage battery before driving downhill.

Heavily discharged high-voltage battery

If the high-voltage battery is heavily discharged while driving, the drive power and some comfort features are reduced incrementally in order to extend the range.

Heated high-voltage battery

With a stationary vehicle

In isolated cases, when the vehicle is stationary, it is possible for the high-voltage battery to overheat, for instance at extreme outside temperatures and in direct sunlight. Drive-ready state cannot be turned on if the high-voltage battery is overheated.

A Check Control message is displayed.

Another message will indicate when drive-ready state is available again.

While driving

If the high-voltage battery overheats while driving, the drive power is reduced incrementally in order to cool down the high-voltage battery. The ePOWER power gauge in the instrument cluster decreases.

If the temperature increases further, park the vehicle until the high-voltage battery has cooled down.

If the power gauge falls to 0, the drive-ready state is switched off and the vehicle comes to a stop.

i4 M50: Launch Control

Principle

Launch Control enables optimum acceleration on roads with good traction under dry surrounding conditions.

General information

Using Launch Control causes premature component wear since this function represents a very heavy load for the vehicle.

Do not turn the steering wheel when driving off with Launch Control.

Do not use Launch Control when breaking in the vehicle.

Additional information:

Break-in, refer to page 276.

Driving off with Launch Control

1. Turn on drive-ready state.
2. Activate SPORT, SPORT BOOST or SPORT INDIVIDUAL with the Driving Experience Control.
3. With the left foot, press down forcefully on the brake.
4. Press the accelerator pedal all the way down and hold.

A destination flag is displayed in the instrument cluster.

5. Release the brake within a few seconds of the destination flag illuminating.

The vehicle accelerates.

Launch Control stays on as long as the destination flag is displayed and the accelerator pedal is not released.

Driving Experience Control

Principle

The Driving Experience Control influences, among other things, the vehicle's driving dynamics.

The vehicle can be adjusted depending on the situation using various driving modes.

General information



The following systems may be affected, for instance:

- ▷ Drivetrain.
- ▷ Chassis.
- ▷ Steering.
- ▷ Display in the instrument cluster.
- ▷ Cruise control.

Overview

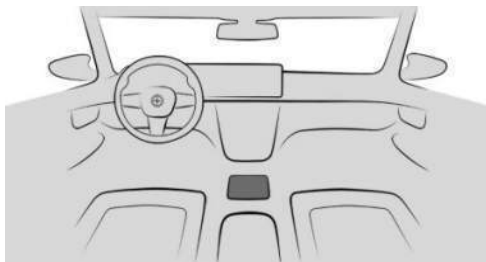
Buttons in the vehicle



Button	Driving mode
	SPORT
	SPORT INDIVIDUAL
	SPORT BOOST
	COMFORT
	ECO PRO
	ECO PRO INDIVIDUAL

Displays in the instrument cluster

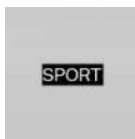

The selected driving mode is displayed in the instrument cluster.

Activating/deactivating drive modes

Press the button for the desired drive mode repeatedly until the desired drive mode is displayed in the instrument cluster.

When changing the drive mode, the current drive mode is deactivated.

Driving modes in detail

COMFORT

The COMFORT driving mode is a balanced setting between sporty and energy-saving driving.

Depending on equipment: SPORT

The SPORT driving mode is a dynamic setting for more agility with an optimized suspension.

Depending on vehicle equipment: SPORT BOOST

Depending on availability, the electric motor provides additional power in SPORT BOOST drive mode. Dynamic setting for maximum agility with an adjusted drive.

Use the accelerator pedal to utilize the additional power with SPORT BOOST active. A display in the instrument cluster shows the availability of the BOOST power.

ECO PRO

In ECO PRO driving mode, power consumption is optimized.

INDIVIDUAL configuration

General information

For some driving modes, there is another mode that can be adjusted individually.

The individual configuration set last is activated directly when the driving mode is called up again.

Configuring and resetting

E.g., ECO PRO INDIVIDUAL drive mode:

1.  Apps menu
2. "Vehicle"
3. "Driving settings"
4. "Drivetrain and chassis"
5. "ECO PRO INDIVIDUAL"
6. Select the desired setting.

Reset ECO PRO INDIVIDUAL to the standard settings:

"Reset to ECO PRO STANDARD"

Enabling INDIVIDUAL

Press the button for the desired driving mode several times.

Drive-off assistant

Principle

On inclines, in selector lever position D or R, this system prevents the vehicle from rolling opposite the set driving direction and provides drive-off support.

Selector lever position B

The system prevents the vehicle from rolling away when the vehicle has come to a standstill and the accelerator pedal is not pressed.

Driving off

Engage a gear position and step on the accelerator pedal to drive off.

The parking brake is released automatically.

Depending on the vehicle load or driving situation, the vehicle may roll back slightly.

If necessary, activate Automatic Hold.

Additional information:

Automatic Hold, refer to page [133](#).

Parking brake

Principle

The parking brake is used to prevent the vehicle from rolling away when it is parked.

Safety information

Warning

An unsecured vehicle can begin to move and possibly roll away. There is a risk of accident, injury, and property damage. Before leaving the vehicle, secure the vehicle against rolling away.

In order to ensure that the vehicle is secured against rolling away, follow the following:

- ▷ Set the parking brake.
- ▷ Automatic transmission: Make sure that selector lever position P is engaged.
- ▷ On uphill grades or on downhill slopes, turn the front wheels in the direction of the curb.
- ▷ On uphill grades or on downhill slopes, also secure the vehicle, for instance with a wheel chock.

Warning

Unattended children or animals in the vehicle can cause the vehicle to move and endanger themselves and traffic, for example, due to the following actions:

- ▷ Establishing standby.
- ▷ Releasing the parking brake.
- ▷ Opening and closing the doors or windows.
- ▷ Engaging selector lever position N.
- ▷ Using vehicle equipment.

There is a risk of accident, injury, and property damage. Do not leave children or animals unattended in the vehicle. Take the vehicle key with you when exiting and lock the vehicle.

Overview

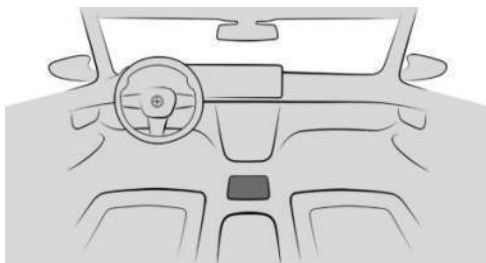

Setting the parking brake

With a stationary vehicle

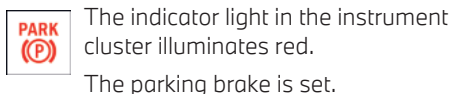
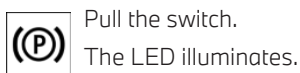

While driving

Use while driving serves as an emergency braking function.

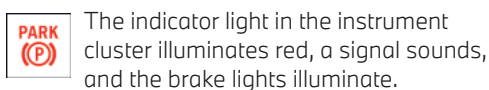
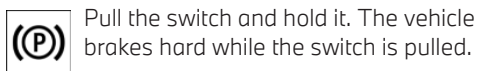

A Check Control message is displayed.

The parking brake is engaged when the vehicle is stationary.

With Emergency Stop Assistant

 Briefly pull the switch to trigger the Emergency Stop Assistant.

Additional information:

Emergency Stop Assistant, refer to page [189](#).

Releasing the parking brake

Releasing the parking brake manually

1. Turn on drive-ready state.

2.  Press the switch while stepping on the brake pedal or selector lever position P is set.

The LED and the indicator light go out.

The parking brake is released.

Releasing the parking brake automatically

The parking brake is released automatically when you drive off.

The LED and the indicator light go out.

Malfunction

If the parking brake fails or malfunctions, secure the vehicle so that it does not roll away before you exit.

A Check Control message is displayed.

Secure the vehicle against rolling away, for instance with a wheel chock, after getting out of the vehicle.

After a power interruption

To reestablish parking brake operability after a power interruption, an initialization may be required.

1. Turn on standby state.

2.  Pull the switch while stepping on the brake pedal or selector lever position P is set and then push.

This process may take a few seconds. Some mechanical sounds associated with this process are normal.

 The indicator light is no longer illuminated as soon as the parking brake is ready for operation again.

Automatic Hold

Principle

Automatic Hold provides assistance by automatically applying and releasing the brake, e.g., when driving off on inclines or in stop-and-go traffic.

The vehicle is automatically held in place when it is stationary.

General information

The parking brake is automatically engaged under the following conditions:

- ▷ If drive-ready state is turned off.
- ▷ If the driver's door is opened while the vehicle is stationary.
- ▷ If the parking brake is used to brake the vehicle to a stop while driving.

Safety information

Warning

An unsecured vehicle can begin to move and possibly roll away. There is a risk of accident, injury, and property damage. Before leaving the vehicle, secure the vehicle against rolling away.

In order to ensure that the vehicle is secured against rolling away, follow the following:

- ▷ Set the parking brake.
- ▷ Automatic transmission: Make sure that selector lever position P is engaged.
- ▷ On uphill grades or on downhill slopes, turn the front wheels in the direction of the curb.
- ▷ On uphill grades or on downhill slopes, also secure the vehicle, for instance with a wheel chock.

Warning

Unattended children or animals in the vehicle can cause the vehicle to move and endanger themselves and traffic, for example, due to the following actions:

- ▷ Establishing standby.
- ▷ Releasing the parking brake.
- ▷ Opening and closing the doors or windows.
- ▷ Engaging selector lever position N.
- ▷ Using vehicle equipment.

There is a risk of accident, injury, and property damage. Do not leave children or animals unattended in the vehicle. Take the vehicle key with you when exiting and lock the vehicle.

NOTICE

If the vehicle is stationary, Automatic Hold engages the parking brake and prevents the vehicle from rolling in a car wash. There is a risk of property damage. Deactivate Automatic Hold prior to entering the car wash.

Overview

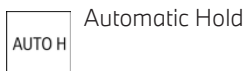
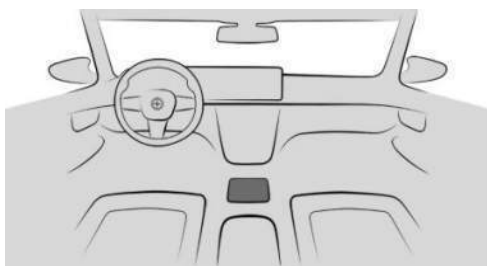

Automatic Hold

Activating Automatic Hold

1. Turn on drive-ready state.

2.  Press the button.
The LED illuminates.

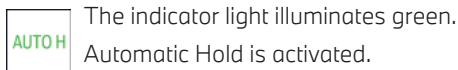

The indicator light illuminates green. Automatic Hold is activated.

Automatic Hold holding the vehicle

Automatic Hold is activated and the driver's door is closed.

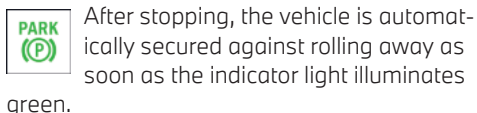

After stopping, the vehicle is automatically secured against rolling away as soon as the indicator light illuminates green.

Automatic parking brake application

The parking brake is automatically set if drive-ready state is switched off while the vehicle is being held by Automatic Hold or if the vehicle is exited.

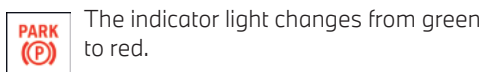

The indicator light changes from green to red.

The parking brake is not set automatically if the drive-ready state was switched off while

the vehicle was coasting. Automatic Hold is temporarily deactivated in this case.

Driving off

Press the accelerator pedal to drive off.

The brake is released automatically and the indicator light of the parking brake is no longer illuminated.

The vehicle may roll back slightly when driving off, depending on the load.

Use the parking brake as needed to prevent the vehicle from rolling back when driving off.

Deactivate Automatic Hold

 Press the button.
The LED goes out.

 The indicator light goes out.

Automatic Hold is deactivated.

If the vehicle is being held by Automatic Hold, also press the brake pedal when deactivating.

Displays

Vehicle features and options

This chapter describes model-specific equipment, systems, and functions that are currently available, or may become available in the future, even if they are not present in the vehicle.

Additional information:

Vehicle equipment, refer to page [8](#).

Instrument cluster

Principle

The instrument cluster comprises various digital displays, e.g., a speedometer, time, range, temperature as well as indicator and warning lights.

General information

The layout of the instrument cluster adapts to the respective driving mode. The positions of some displays may vary, e.g., the selector lever display.

Some of the displays in the instrument cluster may differ from the illustrations in the Owner's Manual.

Safety information

Warning

If the driving information displays on the instrument cluster fail, e.g., the speedometer, do not use the vehicle. There is a risk of accident, injury, and property damage. Immediately park the vehicle in a safe manner.

Turning drive-ready state off and on again may correct the malfunction, allowing you to continue driving. If the malfunction cannot be corrected, have the vehicle checked by an au-

thorized service center or another qualified service center or repair shop.

Overview

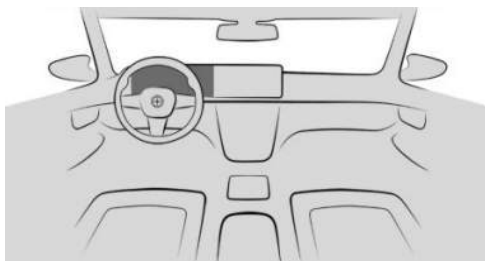

Instrument cluster

Display ranges on the instrument cluster

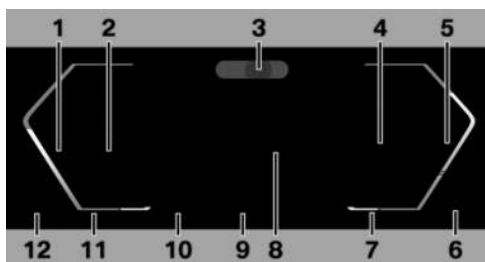

- 1 Speedometer
- 2 Driver assistance systems [203](#)
- 3 Driver Attention Camera [197](#)
- 4 Check Control [139](#)
Selector lever display [124](#)
Selection lists [147](#)
Using eDRIVE efficiently [282](#)
- 5 Power gauge [148](#)
- 6 Range [149](#)
- 7 Selector lever position [124](#)
Outside temperature [150](#)





- 8 Charging screen [150](#)
Central display range [151](#)
- 9 Drive mode [130](#)
- 10 Speed Limit Info [203](#)
Speed Limit Assistant [217](#)
- 11 Time [154](#)
- 12 High-voltage battery charge state indicator [154](#)

Additional information:

Indicator/warning lights, refer to page [140](#).

Operating elements on the steering wheel

Operating element	Function
	Display the menu bar on the instrument cluster.
	Press the corresponding arrow key to move the selection.
	Turn knurled wheel: scroll selection up or down. Press knurled wheel: confirm selection.

Configuring the layout

In COMFORT drive mode, the layout in the instrument cluster can be individually configured and displayed.

1.  Press the button on the steering wheel.
A menu bar is displayed in the instrument cluster.
2. "LAYOUT"

Select the menu using the arrow buttons on the steering wheel where applicable.

3. Select the desired setting using the knurled wheel on the steering wheel.

Settings

Specific displays can be configured individually, e.g., a second actual speed.

1.  Apps menu
2. "Vehicle"
3. "Displays"
4. "Instrument cluster"
5. Select the desired setting.

Live Vehicle

Principle

Live Vehicle is a virtual representation of your vehicle with different information, e.g., vehicle status or current driving condition.

General information

Corresponding information is shown on the control display depending on the driving situation. Fault statuses are not taken into account. Adaptive content or various static content can be selected.

Adaptive content

The following content is displayed in alternating order and, if necessary, depending on the selected drive mode:

- ▶ Vehicle status, refer to page [155](#).
- ▶ Current driving condition, refer to page [155](#).
- ▶ Sport displays, refer to page [156](#).
- ▶ Driving style analysis, refer to page [283](#).
- ▶ Trip data, refer to page [151](#).

Adjusting the display

In the Live Vehicle menu, adaptive content or various static content for the display can be selected on the left-hand side bar:

1.  Apps menu
2. "Vehicle"
3. "Live Vehicle"
4. Select the desired setting.

BMW Head-up display

Principle

The Head-up display projects important information, e.g., speed, onto the windshield in the driver's field of view. Information can be recorded without you having to look away from the road.

The steering wheel buttons can be used to configure various views for the Head-up display. More settings can be configured on the control display, e.g., brightness, height, or rotation.

General information

Follow instructions for cleaning the Head-up display in the Vehicle Care chapter.

Additional information:

Caring for special components, refer to page [352](#).

Overview

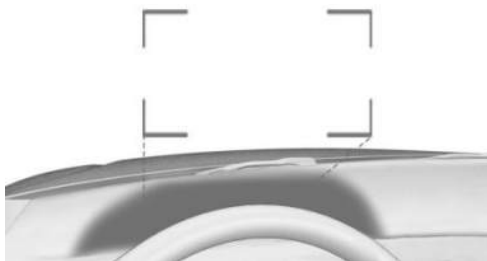

Head-up display views are projected onto the windshield through a protective glass. The protective glass is located between the steering wheel and windshield.

Displayable information

The following information is displayed on the Head-up display:

- ▶ Vehicle speed.
- ▶ Navigation instructions.
- ▶ Check Control messages.
- ▶ Sport displays.
- ▶ Lists and messages.
- ▶ Driver assistance systems.

Some of this information is only displayed briefly as needed.

Configuring a view

The views for the Head-up display can be set independently of the display on the instrument cluster, e.g., a reduced view.

1.  Press the button on the steering wheel.
A menu bar is displayed in the instrument cluster.
2. "HEAD-UP"

Select the menu using the arrow buttons on the steering wheel where applicable.

3. Select the desired setting using the knurled wheel on the steering wheel.

Turning the Head-up display on/off

1.  Apps menu
2. "Vehicle"
3. "Displays"
4. "Head-up display"
5. "Head-up display"

Settings

Various settings can be configured for the Head-up display, e.g., height, brightness, or rotation. In addition, individual displays in the Head-up display can be set up separately such as for Driver Assistance.

1.  Apps menu
2. "Vehicle"
3. "Displays"
4. "Head-up display"
5. Select the desired setting.

Visibility of the display

The visibility of the displays in the Head-up display is influenced by the following factors:

- ▶ Seat position.
- ▶ Objects on the Head-up display's protective glass.
- ▶ Dust or dirt on the Head-up display's protective glass.
- ▶ Windshield dirty on inside or outside.
- ▶ Sunglasses with certain polarization filters.
- ▶ Wet road.
- ▶ Unfavorable light conditions.

If the image is distorted, have the basic settings checked by an authorized service center or another qualified service center or repair shop.

Special windshield

The windshield is part of the system.

The shape and coating of the special windshield enable the system to function.

If damaged, have the special windshield replaced by an authorized service center or another qualified service center or repair shop.

Check Control

Principle

The Check Control system monitors functions in the vehicle and notifies you of faults in the monitored systems.

A Check Control message is displayed as a combination of indicator lights or warning lights and text messages on the instrument cluster and, if applicable, on the Head-up display. In addition, an acoustic signal may sound and a text message may appear on the control display.

Some Check Control messages are hidden automatically after approx. 20 seconds, but they will be stored. Stored Check Control messages can be displayed on the control display. Urgent Check Control messages are permanently displayed but may be hidden temporarily.

Hiding Check Control messages

Permanently displayed Check Control messages can be hidden temporarily. These messages are automatically displayed again after approx. 8 seconds.

 An arrow icon next to the Check Control message indicates whether the Check Control message can be hidden.

 To hide Check Control messages, press the left arrow button on the steering wheel.

Displaying stored Check Control messages

Additional information such as the cause of a fault or the required action can be called up via Check Control.

Depending on the Check Control message, further help can be selected.

1.  Apps menu
2. "Vehicle"
3. "Vehicle status"
4. "Check Control"
5. Select the desired text message.

Display

A Check Control message is displayed in the instrument cluster as a text message with an icon.

For urgent messages, an added text is automatically displayed on the control display.

If several faults occur at once, the messages are displayed consecutively.

Certain messages displayed while driving are displayed again after drive-ready state is switched off.

 Icons in the instrument cluster indicate an active or saved Check Control message.



Indicator lights and warning lights

Principle

The indicator lights and the warning lights on the instrument cluster show the status of some functions in the vehicle. The indicator lights and warning lights indicate faults in monitored systems.

General information

Indicator lights and warning lights can illuminate in a variety of combinations and colors.

Several of the lights are checked for proper functioning and illuminate temporarily when drive-ready state is turned on.

Red lights

Seat belt reminder



Seat belt on the driver's seat is not buckled.

Additional information:

Seat belt reminder, refer to page [108](#).

Airbag system



Warning light illuminates briefly: indicates that the entire airbag system and seat belt tensioners are operational when drive-ready state is switched on.

Warning light does not illuminate or illuminates continuously: the airbag system or the seat belt tensioners may not be operational. Have the vehicle checked immediately by an authorized service center or another qualified service center or repair shop.

Additional information:

Airbags, refer to page [169](#).



Parking brake



The parking brake is set.

Additional information:

Parking brake, refer to page [132](#).

Brake system



The brake pads are worn or there is another issue with the brake system.



The braking assistance may not be operational. A higher pedal force may be required for braking.

Have the vehicle checked immediately by an authorized service center or another qualified service center or repair shop.

System fault



Contact an authorized service center or another qualified service center or repair shop.

Emergency Stop Assistant



The Emergency Stop Assistant is triggered.

Additional information:

Emergency Stop Assistant, refer to page [189](#).

Pedestrian Warning



Warning light illuminates: risk of collision with a person, e.g., a pedestrian or a cyclist. Increased awareness is required.

Warning light flashes and a signal sounds: risk of imminent collision with a person, e.g., a pedestrian or a cyclist. Immediately initiate braking or an evasive maneuver.

Additional information:

Daytime Pedestrian Collision Mitigation, refer to page [178](#).

Forward Collision Warning



Warning light illuminates: risk of collision, e.g., with a vehicle, is detected. Increased awareness is required.

Warning light flashes and a signal sounds: risk of imminent collision with a vehicle detected. Immediately initiate braking or an evasive maneuver.

Additional information:

Forward Collision Warning with braking function, refer to page [177](#).

Intersection Collision Warning: vehicle detected from the right



Warning light illuminates: risk of collision with vehicle crossing from the right detected. Increased awareness is required.

Warning light flashes and a signal sounds: risk of imminent collision with a crossing vehicle detected. Immediately initiate braking or an evasive maneuver.

Additional information:

Intersection Collision Warning with city braking function, refer to page [179](#).

Intersection Collision Warning: vehicle detected from the left



Warning light illuminates: risk of collision with vehicle crossing from the left detected. Increased awareness is required.

Warning light flashes and a signal sounds: risk of imminent collision with a crossing vehicle detected. Immediately initiate braking or an evasive maneuver.

Additional information:

Intersection Collision Warning with city braking function, refer to page [179](#).

Intersection Collision Warning: vehicle from undetectable direction of travel



Warning light illuminates: risk of collision with vehicle from unrecognizable direction of travel detected. Increased awareness is required.

Warning light flashes and a signal sounds: risk of imminent collision with a vehicle detected. Immediately initiate braking or an evasive maneuver.

Additional information:

Intersection Collision Warning with city braking function, refer to page [179](#).

Active Cruise Control with Distance Control



Warning light flashes and acoustic signal sounds: Brake and evade as necessary.

Additional information:

Active Cruise Control with Distance Control, refer to page [210](#).

Steering Assistant



Depending on national-market version: The warning light flashes or illuminates. A signal sounds:

The system is switched off.

Additional information:

Steering Assistant, refer to page [220](#).

Steering and Lane Control Assistant: hands not on steering wheel



Warning light illuminates and acoustic signal sounds:

Hands are not grasping the steering wheel. System interruption is imminent.

The system reduces the speed to a standstill if applicable.

It is possible that the system will not execute any supporting steering movements.

Grab the steering wheel with your hands.

Additional information:

Steering Assistant, refer to page [220](#).

Yellow lights

Antilock Braking System



The system may not be operational. The Antilock Braking System is not available.



The ability to steer may be restricted during full braking.

Have the vehicle checked immediately by an authorized service center or another qualified service center or repair shop.

Additional information:

Antilock Braking System, refer to page [199](#).

Steering Assistant



Warning light illuminates and acoustic signal may sound: A system interruption is imminent.

Warning light flashes: Lane boundary has been crossed.

Additional information:

Steering Assistant, refer to page [220](#).

Steering and Lane Control Assistant: hands not on steering wheel



Hands are not grasping the steering wheel. The system is still active.

Grab the steering wheel with your hands.

Additional information:

Steering Assistant, refer to page [220](#).

Dynamic Stability Control



Warning light flashes: Dynamic Stability Control is regulating the driving and brake power. The vehicle is stabilized. Reduce the vehicle speed and adjust your driving style to the road conditions.

Warning light illuminates: Dynamic Stability Control has malfunctioned or is initializing. Driving stabilization is restricted or has failed.

If the warning light illuminates continuously, have the vehicle checked immediately by an authorized service center or another qualified service center or repair shop.

Additional information:

Dynamic Stability Control, refer to page [199](#).

The Dynamic Stability Control deactivated or the Dynamic Traction Control activated



Dynamic Stability Control is deactivated or Dynamic Traction Control is activated.

Additional information:

- ▷ Dynamic Stability Control, refer to page [199](#).
- ▷ Dynamic Traction Control, refer to page [201](#).

Flat tire monitor



Warning light illuminates: Flat tire or tire pressure loss has been detected.

Reduce your speed and stop cautiously. Avoid sudden braking and steering maneuvers.

Additional information:

Flat tire monitor, refer to page [323](#).

Tire pressure monitor



Warning light illuminates: Flat tire or tire pressure loss has been detected. Follow the information in the Check Control message.

Warning light flashes then illuminates continuously: Flat tires or tire pressure losses cannot be detected.

- ▷ Fault caused by systems or devices with the same radio frequency: after leaving the area of the interference, the system automatically becomes active again.
- ▷ In the case of tires with special approval: the tire pressure monitor was unable to complete the reset. Reset the system again.
- ▷ Wheel without wheel electronics installed: Have it checked by an authorized service center or another qualified service center or repair shop as needed.
- ▷ Malfunction: have the vehicle checked by an authorized service center or another qualified service center or repair shop.

Additional information:

Tire pressure monitor, refer to page [316](#).

Steering system



The steering system may not be operational.

Have the vehicle checked by an authorized service center or another qualified service center or repair shop.

Acoustic pedestrian protection



Acoustic pedestrian protection has malfunctioned. Increased caution when maneuvering.

If malfunctioning repeatedly, have the vehicle checked by an authorized service center or another qualified service center or repair shop.

Additional information:

Acoustic pedestrian protection, refer to page [123](#).

Charging capacity limited



Additional information:
Charge vehicle, refer to page [286](#).

Green lights

Turn signal



Turn signal is on.
Unusually rapid flashing of the indicator light indicates that a turn signal bulb has failed.

Additional information:
Turn signal, refer to page [157](#).

Parking lights



Parking lights are switched on.
Additional information:
Parking lights, low-beam headlights, refer to page [160](#).

Low-beam headlights



Low-beam headlights are switched on.
Additional information:
Parking lights, low-beam headlights, refer to page [160](#).

Automatic High Beam Assistant



Low-beam headlights are switched on and the Automatic High Beam Assistant is activated.

High-beam headlights are switched on and off automatically depending on the traffic situation.

Additional information:

Automatic High Beam Assistant, refer to page [158](#).

Lane departure warning



Depending on vehicle equipment and national-market version:

The indicator light illuminates: the system is switched on. At least one lane boundary has been detected on one side of the vehicle. The system is ready to intervene and issue warnings. The system can perform steering interventions.

Indicator light flashes: the system is performing a steering intervention.

Additional information:
Lane departure warning, refer to page [181](#).

Automatic Hold is activated



After stopping, Automatic Hold automatically secures the vehicle to prevent it from rolling away.

Additional information:
Automatic Hold, refer to page [133](#).

Automatic Hold holding the vehicle



Automatic Hold secures the stopped vehicle to prevent it from rolling away, e.g., when stopped at a traffic light.

Additional information:
Automatic Hold, refer to page [133](#).

Manual Speed Limiter



The indicator light illuminates: the system is switched on.

The indicator light flashes: the set speed limit has been exceeded.

Additional information:
Manual Speed Limiter, refer to page [205](#).

Cruise Control



The system is active.

Additional information:

Cruise control, refer to page [207](#).

Active Cruise Control with Distance Control



Indicator light illuminates: Vehicle has been detected ahead of you. The vehicle icon goes out if no vehicle has been detected ahead of you.

Indicator light flashes: Preceding vehicle has driven off.

Additional information:

Active Cruise Control with Distance Control, refer to page [210](#).

Speed Limit Assistant activated



Depending on vehicle equipment, the indicator light illuminates green, together with the icon for a speed control system. Speed Limit Assistant is active and detected speed limits can be applied manually for the displayed system.

Additional information:

Speed Limit Assistant, refer to page [217](#).

Speed Limit Assist: Apply speed limit



The detected speed limit can be applied with the SET button. As soon as the speed limit has been applied, a green checkmark is displayed.

Additional information:

Speed Limit Assistant, refer to page [217](#).

Steering Assistant



The system is activated and helps to keep the vehicle in the lane.

Additional information:

Steering Assistant, refer to page [220](#).

Lane Change Assistant: lane change in progress



Arrow icon for lane change green: the system carries out a lane change.

Additional information:

Lane Change Assistant, refer to page [225](#).

Lane Change Assistant: lane change not possible



Gray line for lane boundary on the appropriate side: system detected a lane change request. Lane change not currently possible.

Additional information:

Lane Change Assistant, refer to page [225](#).

Lane Change Assistant: functional requirements not met



Depending on the national-market version:

Arrow icon for lane change gray: lane change not possible; functional requirements not met.

Additional information:

Lane Change Assistant, refer to page [225](#).

Assisted Driving Mode Plus



The system is active.

Additional information:

Assisted Driving Mode Plus, refer to page [223](#).

Blue lights

High-beam headlights

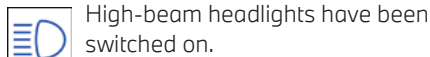

High-beam headlights have been switched on.

Additional information:

- ▶ High-beam headlights, refer to page [157](#).
- ▶ Automatic High Beam Assistant, refer to page [158](#).

Gray lights

Seat belt reminder



Seat belt on the passenger seat or another seat in the vehicle is not buckled.

Additional information:

Seat belts, refer to page [107](#).

Manual Speed Limiter



The system is interrupted.

Additional information:

Manual Speed Limiter, refer to page [205](#).

Cruise Control



The system is interrupted.

Additional information:

Cruise control, refer to page [207](#).

Active Cruise Control with Distance Control



Indicator light is illuminated: the system is interrupted.

Indicator light flashes: Conditions are not adequate for the system to work. The system was deactivated but applies the brakes until you actively resume control by pressing on the brake pedal or accelerator pedal.

Additional information:

Active Cruise Control with Distance Control, refer to page [210](#).

Steering Assistant



The system is on standby and does not manipulate steering movements.

System activates automatically as soon as all function conditions are fulfilled.

Additional information:

Steering Assistant, refer to page [220](#).

Assisted Driving Mode Plus



The system is interrupted and will activate automatically as soon as all functional requirements are met.

Additional information:

Assisted Driving Mode Plus, refer to page [223](#).

White lights

Cruise Control with Distance Control



No Distance Control because accelerator pedal is being pressed.

Additional information:

Active Cruise Control with Distance Control, refer to page [210](#).

Assisted Driving Mode Plus



The system can be activated.

Additional information:

Assisted Driving Mode Plus, refer to page [223](#).

Selection lists

Principle



Lists can be displayed and, if necessary, used for certain functions in the instrument cluster or the Head-up display.

- ▷ Entertainment source.
- ▷ Current audio source.
- ▷ List of most recent telephone calls.

If necessary, the corresponding menu will open on the control display.

Displaying and using the list

The selection lists can be displayed and operated using the operating elements on the steering wheel.



Operating elements	Function
	Turn the knurled wheel: display the entertainment list or scroll up or down in the list. Press knurled wheel: confirm selection.
	Press the corresponding arrow key to change the entertainment source.
	Show list of most recent telephone calls.

Display





Selection lists, e.g., entertainment sources, are displayed on the instrument cluster.

Example: selecting a radio station

1.  Press the entertainment sources button.
2.  To switch to the list of radio stations, tilt the knurled wheel to the right.
3. Turn the knurled wheel to select a radio station.
4. Press the knurled wheel to confirm the selected radio station.

Example: changing the entertainment source

1.  Press the entertainment sources button.
2.  To select an entertainment source, turn the knurled wheel.
3. Press the knurled wheel to confirm the selected entertainment source.

Power gauge

Principle

The power gauge indicates the current electric drive power as a percentage.

Display



In COMFORT and ECO PRO drive modes:
Needle in the area of arrow 1: display of the energy recovered by coasting or when decelerating.

Needle near arrow 2: Drive power in percent.

Energy recovery display

Icon	Meaning
	Low energy recovery. Selector lever position D is engaged.
	Average energy recovery. Selector lever position D is engaged.
	High energy recovery. Selector lever position D or B is set.
	Adaptive recuperation is activated Adaptive recuperation, refer to page 283.

The degree of the energy recovery depends on the settings for the energy recovery.

Additional information:

Driving in detail: eDRIVE, refer to page 127.

Reduced drive power

The available power may be reduced due to certain factors. The power gauge is automatically adjusted accordingly.

In addition, the icons on the power gauge indicate reduced drive power:

Icon	Description
	Blue icon: cold drivetrain. White icon: increased drive system temperature, for instance due to sustained or high power demand when driving on mountain roads.
	Depending on vehicle equipment and national-market version: Drive power limitation defined via the BMW Digital Key.
	Heavily discharged high-voltage battery.
	System-related functional limitation. A Check Control message is displayed in addition where applicable.

Sport Boost function



SPORT BOOST: Increased power can be temporarily called up in this driving mode, which can be selected with the Driving Experience Control, e.g., for very fast acceleration in an overtaking maneuver.

The availability of the increased power is displayed on the instrument cluster.

Display	Meaning
White	Power boost is available but has not yet been retrieved.
Blue	Retrieving power boost. When called up, the Boost display is emptied accordingly.
Gray	Power boost is not available, for instance when the drive system is cold.

Additional information:

Driving Experience Control, refer to page [130](#).

Standby state and drive-ready state



OFF is displayed in the instrument cluster. Drive-ready state is turned off and standby state turned on.

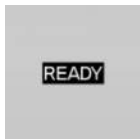

When the drive-ready state is switched on, READY is displayed in the instrument cluster.

Additional information:

- ▷ Operating state of the vehicle, refer to page [46](#).

Range

General information

The expected range for the energy stored in the high-voltage battery is continuously displayed in the instrument cluster.

Always make sure that the range is sufficient for the planned trip. The range is dynamic and can abruptly change.

The range can be reduced or increased based on the following factors:

- ▷ Driving style.
- ▷ Traffic conditions.
- ▷ Drive mode change.
- ▷ Climate and terrain conditions.
- ▷ Automatic climate control settings.
- ▷ After determination of a route through the navigation system depending on the route profile, route distance and selected speed.
- ▷ When exiting a route or recalculating a route.
- ▷ By preheating/precooling the high-voltage battery for a DC charging process.

Information about the current range can be displayed in the instrument cluster.

Check Control messages indicate a limited range.

Additional information:

- ▷ Increasing the range, refer to page [281](#).

Display



The range is continuously displayed in the instrument cluster.

Range with active guidance

 The icon is displayed next to the range when guidance was started in the navigation system. Information from the navigation system is taken into account for the calculation of the current range.

Heavily discharged high-voltage battery

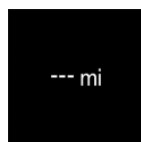

The high-voltage battery is heavily discharged. The drive power will be reduced. Heating and climate control functions will be deactivated.

In this state, the exact range can no longer be calculated. A short range may still be available depending on the environmental condition.

Re-establishing the drive-ready state can help increase the range slightly, for instance to remove the vehicle from a hazardous area.

State of charge in strong temperature fluctuations

In the case of strong temperature fluctuations and a low state of charge of the high-voltage battery, it may not be possible to start the vehicle again at the beginning of the next trip. Recharge vehicle with a low state of charge in time.

Outside temperature

General information

If the indicator drops to +37°F/+3°C or lower, a signal sounds.

A Check Control message is displayed.

There is an increased risk of ice on roads.

When the vehicle is stationary or at low speed, the temperature displayed may differ slightly from the actual outside temperature due to external environmental influences.

Safety information

Warning

Even at temperatures above +37 °F/+3 °C there is a risk of icy roads, for instance on bridges or shady sections of the road. There is a risk of accident, injury, and property damage. Modify your driving style to the weather conditions at low temperatures.

Charging screen

Principle

The charging screen displays information about the charging process in the instrument cluster.

General information

Some of the displays in the instrument cluster may differ from the illustrations in the Owner's Manual.

When the vehicle is locked, the most important information is displayed for a short period of time.

Display charging screen again:



With the charging cable plugged in, press the button on the vehicle key.

The function is not available for the first 10 seconds after locking.

Additional information:

Charge vehicle, refer to page [286](#).

Overview

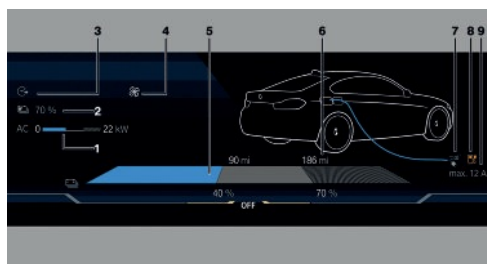

- 1 Current charging capacity [296](#)
- 2 Charge target set [295](#)
End of charging time [296](#)
- 3 Set departure time [297](#)
- 4 Departure air conditioning [297](#)
- 5 Current range [296](#)
Current state of charge [296](#)
- 6 Range when reaching the charging destination [296](#)
- 7 Charging cable status [288](#)
- 8 Charging station restriction [286](#)
- 9 Set or maximum current limit [286](#)

Central display range

Displayable content

The following settings can be selected:

- ▶ Reduced display.
 - ▶ Trip data, refer to page [151](#).
 - ▶ Assisted View, refer to page [153](#).
 - ▶ Navigation system route preview.
 - ▶ Navigation system map view.
 - ▶ G-Meter, refer to page [154](#).
 - ▶ Entertainment.
 - ▶ Android Auto®.
- Depending on vehicle equipment and national-market version, select functions of

a compatible smartphone can also be displayed, e.g., map views.

Some contents for the central display range can also be configured as a view in the Head-up display.

Additional information:

Head-up display, refer to page [138](#).

Owner's Manual for Navigation, Entertainment, and Communication, refer to page [6](#).

Configuring the central display range

The content of the central display range on the instrument cluster can be configured individually, for instance the trip data display.

1.  Press the button on the steering wheel.
A menu bar is displayed in the instrument cluster.
2. "CONTENT"
Select the menu using the arrow buttons on the steering wheel where applicable.
3. Select the desired setting using the knurled wheel on the steering wheel.

Trip data

Principle

The trip data display provides various information about the trip, e.g., average energy consumption or trip distance.

General information

The trip data can be displayed on the control display and in the instrument cluster.





Depending on the setting in the Live Vehicle menu, the trip data is shown on the control display.

The values can be displayed and reset depending on different intervals.

Display on the control display

General information

The following trip data is shown on the control display:

- ▷ Configured interval for displaying trip data.
- ▷  Average energy consumption depending on the set interval.
- ▷  Travel time depending on the configured interval.
- ▷  Distance traveled depending on the configured interval.
- ▷  Counter for energy recovery depending on the configured interval.

Displaying trip data continuously

1.  Apps menu
2. "Vehicle"
3. "Live Vehicle"
4. "Content"
5. "Trip data"

Display in the instrument cluster

Information on energy consumption and distance covered can be displayed in the instrument cluster.



- ▷ Current energy consumption, arrow 1.
- ▷ Average energy consumption, arrow 2.

- ▷ Distance traveled depending on the configured interval, arrow 3.
- ▷ Total mileage, arrow 4.

Current energy consumption

The current energy consumption display lets you check your current energy consumption, e.g., to drive efficiently.

Average energy consumption

The average energy consumption is determined on the basis of various distances.

Adjusting the display of the trip data

The intervals for the display of the trip data in the instrument cluster and on the control display are adjustable.

Using the button on the left steering column switch:

1. Press the button.
The trip data is displayed.

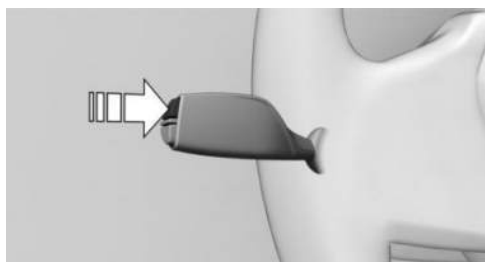

2. Press button repeatedly until the desired setting is displayed.

Via iDrive:

1.  Apps menu
2. "Vehicle"
3. "System settings"
4. "Time period for trip data"
5. "Values"
6. Select the desired setting:

- ▶ "Since start of trip": the values are automatically reset approx. four hours after the vehicle has come to a standstill.
- ▶ "Since last charge": the values are automatically reset after charging.
- ▶ "Since factory": the values since the time of the factory delivery are displayed.
- ▶ "Since Individual": the values since the last manual reset are displayed. The values can be reset at any time.

Resetting average values manually

The following interval can be reset manually at any time:

"Since Individual ()"

Using the button on the left steering column switch:

1. Press the button.
The trip data is displayed.

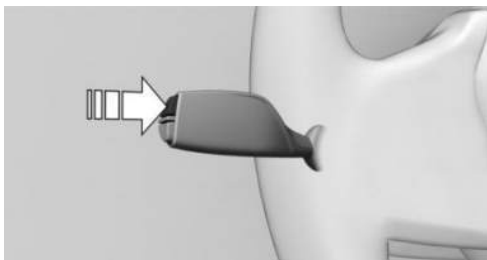

2. Press and hold the button until the values are reset.

Via iDrive:

1.  Apps menu
2. "Vehicle"
3. "System settings"
4. "Time period for trip data"
5. "Reset Individual"

The average values and counters are reset. Once the average values and counters have been reset, the following interval is automatically activated:

"Since Individual ()"

Assisted View

Principle

With Assisted View, information on driver assistance systems can be displayed on the instrument cluster with a vehicle animation.

Information on parking and maneuvering is displayed in the Assisted View whenever the parking assistance system is active.

Safety information

Warning

The system cannot serve as a substitute for the driver's personal judgment in assessing the traffic situation. Based on the limits of the system, it cannot independently react to all traffic situations. There is a risk of accident, injury, and property damage. Adjust driving style to traffic conditions. Watch the surrounding traffic situation closely, be ready to take over steering and braking at any time, and actively intervene where appropriate.

General

You can configure how Assisted View is displayed on the central display range.

Additional information:

Central display area, refer to page [151](#)

Display

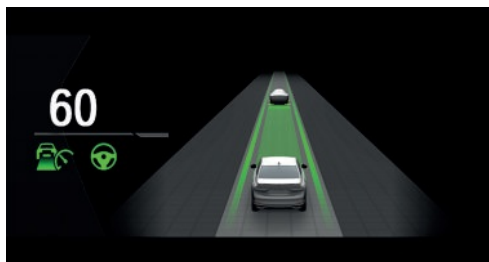

An example of active Driver Assistance: Indicator and warning lights for Distance Control and Assisted Driving Mode are displayed. At the same time, the Distance Control is animated in Assisted View.

System limits

The system's detection capability is limited.

Only objects that are detected by the system are taken into account.

The system may indicate something wrong.

Additional information:

- ▶ Cameras, refer to page 41.
- ▶ Radar sensors, refer to page 42.

G-Meter

General information

The G-Meter indicates the forces that are applied in longitudinal and transverse direction on the vehicle occupants while driving.

The display can be configured on the central display range of the instrument cluster.

The values are automatically reset whenever you start a new drive.

Additional information:

Central display area, refer to page 151

Manually resetting G-Meter values

1. Display the G-Meter on the instrument cluster.
2.  Press and hold the knurled wheel on the steering wheel until the values are reset.

Date and time

Various settings can be applied for the date and time display such as the date format.

Depending on vehicle equipment and national-market version, the time zone can be set or automatic time zone enabled. With automatic time setting, the time, date and, if necessary, the time zone are updated automatically.

1.  Apps menu
2. "Vehicle"
3. "System settings"
4. "Date and time"
5. Select the desired settings.

State of charge indicator

Safety information

Warning

Even when it is indicated that the high-voltage battery is discharged, the high-voltage system is always still under high voltage. There is a risk of fire or a risk of injury. Do not touch or change live parts, e.g., orange high-voltage cables, even when the batteries are discharged.

Display



When standby and drive-ready state are turned on, the available battery charge state of the high-voltage battery is continuously displayed in percent in the instrument cluster.

In case of temperature fluctuations, the battery charge state may change.

Setting the units of measurement

Depending on the national-market version, you can set the units of measurement for some values, for instance energy consumption, distances, and temperature.

1.  Apps menu
2. "Vehicle"
3. "System settings"
4. "Units"
5. Select the desired setting.

Vehicle status





General information

The status can be displayed and actions performed for several systems such as for Check Control.

Displaying vehicle status

1.  Apps menu
2. "Vehicle"
3. "Vehicle status"

Overview

Icon	Description
	"Battery temperature": Temperature of high-voltage battery, refer to page 286 .
	"FLAT TIRE MONITOR": Status of the flat tire monitor, refer to page 323 .
	"Tire Pressure Monitor": status of the Tire Pressure Monitor, refer to page 316 .
	"Check Control": displaying stored Check Control messages, refer to page 139 .
	"Service": display of the service notifications, refer to page 156 .

Current driving condition

General information

The current driving condition is displayed dynamically while driving in the Live Vehicle menu on the control display.

The following states can be displayed:

- ▷ Driving.
- ▷ Coasting mode: "EFFICIENT COASTING".
- ▷ "CHARGING BATTERY"
- ▷ Adaptive recuperation.

Additional information:

- ▷ Adaptive recuperation, refer to page [283](#).
- ▷ Coasting, refer to page [284](#).

Functional requirements

- ▷ COMFORT or ECO PRO driving mode is selected.
- ▷ For Live Vehicle, select the following setting: "Adaptive content".

Display

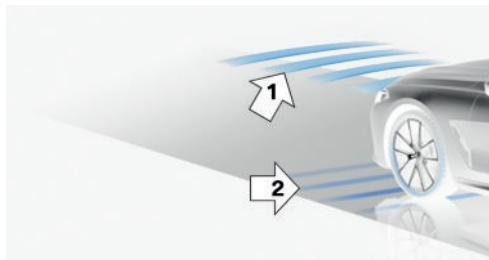

An example:

The adaptive recuperation is active, arrow 1.

The high-voltage battery is charged when the vehicle is decelerating, arrow 2.

Sport displays

Principle

The Sport displays especially support a sporty driving style.

Functional requirements

- ▷ SPORT driving mode is selected.
- ▷ The following setting is selected for Live Vehicle: "Adaptive content"

Display

The sport displays are displayed in the Live Vehicle menu on the control display.

The following information is displayed:

- ▷ Torque.
- ▷ Power.
- ▷ Speed, electric motor.
- ▷ Temperature, electric motor.

Service

Principle

The service notifications indicate recommended maintenance work.

General information

After turning on, the next service appointment or the distance remaining until the next servicing is displayed briefly on the instrument cluster.

A service advisor can read out the maintenance work from the vehicle key.

Display

More information may be displayed on the control display.

1. ■■ Apps menu
2. "Vehicle"
3. "Vehicle status"
4. "Service"

Maintenance measures as well as legally mandated inspections are displayed.

5. Select the desired entry.

Entering appointment dates

Dates for mandatory vehicle inspections can be entered.

Make sure that the vehicle's date and time are set correctly.

1. ■■ Apps menu
2. "Vehicle"
3. "Vehicle status"
4. "Service"
5. "Vehicle inspection"
6. "Date:"
7. Select the desired setting.

Light and view

Vehicle features and options

This chapter describes model-specific equipment, systems, and functions that are currently available, or may become available in the future, even if they are not present in the vehicle.

Additional information:

Vehicle equipment, refer to page 8.

Turn signal

Turn signal in exterior mirror

When driving and during operation of the turn signals or hazard warning system, do not fold in the exterior mirrors so that the turn signal lamps on the exterior mirror are easy to see.

Flashing

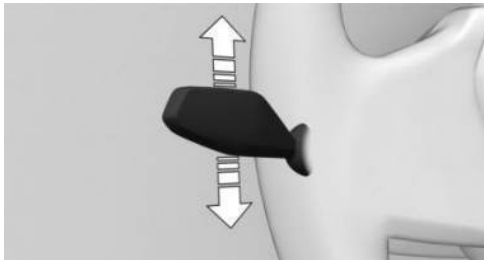

Press the lever past the resistance point.

One-touch signaling

Lightly tap the lever up or down.

The one-touch signaling duration can be adjusted.

1.  Apps menu
2. "Vehicle"
3. "Exterior lighting"

4. If necessary, "Additional settings"
5. "One-touch turn signal"
6. Select the desired setting.

Brief flashing

Press the lever to the resistance point and hold it there for as long as you want the turn signal to flash.

High-beam headlights, headlight flasher

Press the lever forward or pull it backward.



- ▶ High-beam headlights on, arrow 1.
The high-beam headlights illuminate when the low-beam headlights are switched on.
- ▶ High-beam headlights off/headlight flasher, arrow 2.



The indicator light in the instrument cluster illuminates when the high-beam headlights are turned on.

Automatic High Beam Assistant

Principle

The Automatic High Beam Assistant detects other road users early on and automatically switches the high-beam headlights on or off depending on the traffic situation.

General information

The Automatic High Beam Assistant ensures that the high-beam headlights are switched on, whenever the traffic situation allows. In the low speed range, the high-beam headlights are not switched on by the system.

The system responds to light from oncoming traffic and traffic driving ahead of you, and to ambient lighting, for instance in towns and cities.

The high-beam headlights can be switched on and off manually at any time.

Functional requirements

- ▶ Automatic headlight control is activated.
- ▶ Low-beam headlights are switched on.

Activating Automatic High Beam Assistant

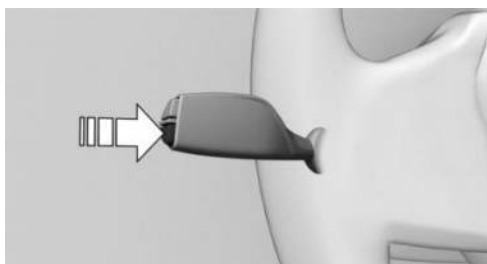

Press the button on the turn signal lever.



The indicator light in the instrument cluster is illuminated when the low-beam headlights are switched on.

The headlights are automatically changed between low-beam headlights and high-beam headlights.



The blue indicator light in the instrument cluster illuminates when the system switches on the high-beam headlights.

Interruption of the journey with activated Automatic High Beam Assistant: the Automatic High Beam Assistant remains activated when continuing the journey.

The Automatic High Beam Assistant is deactivated when manually switching the high-beam headlights on and off.

To reactivate the Automatic High Beam Assistant, press the button on the turn signal lever.

Deactivating Automatic High Beam Assistant

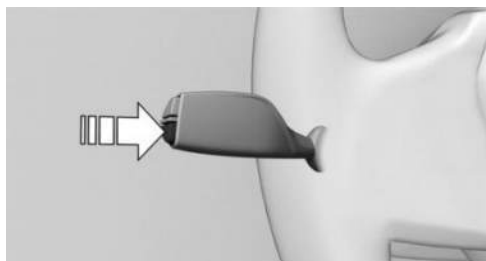

Press the button on the turn signal lever.

Sensitivity of the Automatic High Beam Assistant

General information

The sensitivity of the Automatic High Beam Assistant can be adjusted.

Safety information

Warning

If adjustments have been made or the sensitivity has been modified, oncoming traffic may be momentarily blinded. There is a risk of accident, injury, and property damage. If adjustments have been made and the sensitivity has been modified, make sure that oncoming traffic is not momentarily blinded. Switch off the high-beam headlights manually if required.

Functional requirements

- ▷ Setting at standstill only.
- ▷ Drive-ready state is switched on.
- ▷ Light is turned off.

Increasing sensitivity

Push the turn signal lever to the front for approximately 10 seconds.

A Check Control message is displayed. The system responds more sensitively.

Resetting the sensitivity

Push the turn signal lever to the front again for approx. 10 seconds or switch off the drive-ready state.

The sensitivity of the Automatic High Beam Assistant is reset to the factory settings.

System limits

The Automatic High Beam Assistant cannot replace the driver's personal judgment of when to use the high-beam headlights. When appropriate, dim the high beams manually.

The system may not be fully operational in the following situations, and driver intervention may be necessary:





- ▷ In very unfavorable weather conditions such as fog or heavy precipitation.
- ▷ When detecting poorly-lit road users such as pedestrians, cyclists, horseback riders and wagons; when driving close to train or ship traffic; or at animal crossings.
- ▷ In tight curves, on hilltops or in depressions, in crossing traffic or half-observed oncoming traffic on highways.
- ▷ In poorly-lit towns and cities or in the presence of highly reflective signs.
- ▷ When the windshield in the area in front of the interior mirror is fogged up, dirty or covered with stickers, etc.

Exterior lighting

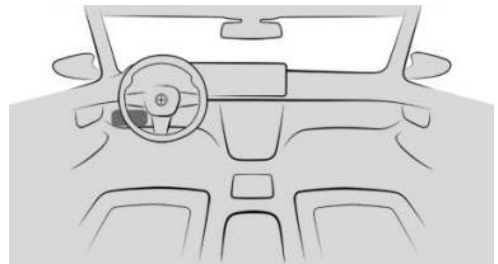
Overview

Buttons in the vehicle



Icon	Function
	Exterior lighting off. Daytime driving lights.
	Parking lights.
	Automatic headlight control. Adaptive lighting functions.
	Low-beam headlights.

Icon Function



Instrument lighting.



Right roadside parking light.



Left roadside parking light.

Buttons on the vehicle key

Icon Function



Interior lighting.

Parts of the exterior lighting.



Pathway lighting.

Driving lights automatic

Principle

The low-beam headlights are switched on and off automatically depending on the ambient brightness, for example in tunnels, in twilight or if there is precipitation.

General information

A blue sky with the sun low on the horizon can cause the lights to be turned on.

If the low-beam headlights are switched on manually, the automatic headlight control is deactivated.

Activate automatic headlight control



Press the button on the light switch.

The LED in the button illuminates.



The indicator light in the instrument cluster is illuminated when the low-beam headlights are switched on.

System limits

The automatic headlight control cannot replace your personal judgment of lighting conditions.

For example, the sensors are unable to detect fog or hazy weather. In these situations, turn the lights on manually.

Parking lights, low-beam headlights and roadside parking lights

General information

If the driver's door is opened when the drive-ready state is switched off, the exterior lighting is automatically switched off after a period of time.

Parking lights

General information

The parking lights can only be turned on at low speeds.

Turning on parking lights



Press the button on the light switch.



The indicator light in the instrument cluster illuminates.

The vehicle is illuminated on all sides.

Do not use the parking lights for extended periods; otherwise, they might drain the vehicle battery and it would then be impossible to switch on drive-ready state.

Turning off parking lights

The following options are available to turn off the parking lights:

- ▶  Press the button on the light switch.
- ▶ Turn on drive-ready state.

After the drive-ready state is switched on, the automatic headlight control will be activated.

Low-beam headlights

Turning on low-beam headlights



Press the button on the light switch.

The low-beam headlights illuminate when drive-ready state is switched on.



The indicator light in the instrument cluster illuminates.

Press the button again to switch on the low-beam headlights when the standby state is switched on.

Turning off low-beam headlights

Depending on the national-market version, the low-beam headlights can be turned off in the low speed range:

- ▶  Press the button on the light switch.

Roadside parking lights

When the vehicle is parked, a one-sided roadside parking light can be switched on.

Button	Function
	Right roadside parking light on.
	Left roadside parking light off.

Switching off the roadside parking light:

- ▶  Press the button on the light switch or turn on drive-ready state.

Welcome lights

Principle

The welcome light turns on automatically for a limited period of time when approaching or unlocking the vehicle.

General information

Depending on the equipment, the exterior lighting of the vehicle can be set individually.

Activating/deactivating welcome light

1.  Apps menu
2. "Vehicle"
3. "Exterior lighting"
4. If necessary, "Additional settings"
5. Depending on the equipment, select the following setting:
 - ▶ "Welcome and goodbye"

When unlocking the vehicle, individual lighting functions are turned on.
 - ▶ "BMW Iconic Glow"

The radiator grille lighting can only be adjusted when the vehicle is stationary and the drive-ready state is switched off.

Turning on the welcome light

- ▷ Automatically on approach.
- ▷ During unlocking.



- ▷ Press the button on the vehicle key with the vehicle locked.

Depending on the settings, the interior lighting and parts of the exterior lighting will be turned on.

The function is not available for the first 10 seconds after locking.

Welcome Light Carpet

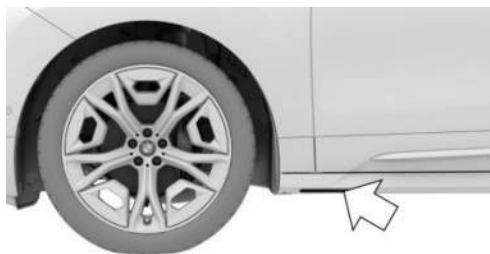

The light source is located in the position indicated.

Keep the light source clean and unobstructed.

Pathway lighting

Principle

For the pathway lighting, the exterior lighting turns on for a certain period of time after leaving the vehicle in order to illuminate the area surrounding the vehicle.

Switching pathway lighting on

- ▷ After switching off the drive-ready state, briefly push the turn signal lever forward.



- ▷ Press and hold the button on the vehicle key for approx. 1 second.

Setting the duration

1. Apps menu
2. "Vehicle"
3. "Exterior lighting"
4. If necessary, "Additional settings"
5. "Pathway lighting"
6. Select the desired setting.

Daytime driving lights

General information

The daytime driving lights illuminate when drive-ready state is switched on.

Activating/deactivating daytime driving lights

In some countries, daytime driving lights are mandatory, so it may not be possible to deactivate the daytime driving lights in front.

1. Apps menu
2. "Vehicle"
3. "Exterior lighting"
4. If necessary, "Additional settings"
5. Depending on vehicle equipment or national-market version:
 - ▷ "Daytime driving lights"
 - ▷ "Rear daytime driving lights"

Adaptive lighting functions

Principle

Adaptive lighting functions enable dynamic illumination of the road.

General information

The adaptive lighting functions may consist of one system or multiple systems, depending on the equipment version:

- ▶ Cornering light.

Activating the adaptive lighting functions

 Press the button on the light switch.

The LED in the button illuminates.

The adaptive lighting functions are active when the drive-ready state is switched on.

Cornering light

Principle

In tight curves, for instance on mountainous roads or when turning, an additional cornering light is switched on that illuminates the inside of the curve when the vehicle is moving below a certain speed.

General information

The cornering light is automatically switched on depending on the steering-wheel angle or, where applicable, the use of turn signals.

When driving in reverse, the cornering lights may be automatically switched on regardless of the steering-wheel angle.

Adaptive headlight range control

The adaptive headlight range control feature balances out acceleration and braking processes as well as the vehicle load conditions in order to avoid blinding oncoming traffic.

Laser tail light

Principle

The LED rear light includes a decorative laser component.

General information

The laser rear light is integrated into the tail light and emits from there.

Depending on the national-market version, additional information can be found on the laser sign in the tail light.

Safety information



Laser class 1.

The sign is located in the tail light and is visible from the outside.

Instrument lighting

Functional requirement

The brightness can only be adjusted when the parking lights or low-beam headlights are turned on.

Setting the brightness



Adjust the brightness with the knurled wheel.

Interior lighting

General information

Depending on the equipment version, interior lights, footwell lights, entry lights, ambient lighting, and speaker lighting are automatically controlled.

Overview

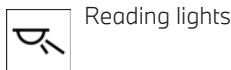

Reading lights

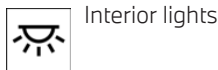

Interior lights

Turning interior lights on/off

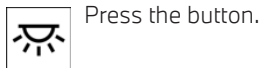

Press the button.

To switch off permanently: press the button and hold for approx. 3 seconds.

The interior lights in the rear of the vehicle can be switched on and off independently. The button is located in the rear headliner.

Turning reading lights on/off

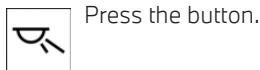

Press the button.

Depending on the vehicle equipment, the reading lights are located next to the interior lights in the front and rear.

Ambient light

General information

Depending on the equipment version, lighting can be adjusted for some lights in the car's interior.

Activating/deactivating ambient light

1. Apps menu
2. "Vehicle"
3. "Interior lighting"
4. If necessary, "Ambience"
5. "Ambient lighting"

Turning ambient light on/off

The ambient light is switched on when the vehicle is unlocked, and switched off when the vehicle is locked.

If the ambient light was deactivated via iDrive, it will not be turned on when the vehicle is unlocked.

Selecting the color

1. Apps menu
2. "Vehicle"
3. "Interior lighting"
4. If necessary, "Ambience"
5. "Color"
6. Select the desired setting.

Setting the brightness

1. Apps menu
2. "Vehicle"
3. "Interior lighting"
4. If necessary, "Ambience"
5. "Brightness"
6. Select the desired setting.

Dynamic light

Individual actions, for example incoming calls or opened doors, are indicated by light effects. If the ambient light is disabled, the light effects are still displayed.

1.  Apps menu
2. "Vehicle"
3. "Interior lighting"
4. If necessary, "Ambience"
5. "Dynamic light"
6. Select the desired setting.

Reduced for night drive

Some lights of the interior lighting are reduced when the vehicle is driven in the dark.

1.  Apps menu
2. "Vehicle"
3. "Interior lighting"
4. If necessary, "Ambience"
5. "Reduced for night driving"

Window wiper system

Safety information

Warning

If the wipers start moving in the folded away state, body parts can be jammed or damage may occur to parts of the vehicle. There is a risk of injury and risk of property damage. Make sure that the vehicle is switched off when the wipers are in the folded-away state and the wipers are folded in when switching on.

NOTICE

The wiper blades can wear out or become damaged prematurely when wiping on a dry window for a longer period of time. The wiper motor can overheat. There is a risk of property damage. Do not use the wipers when the window is dry.

NOTICE

If the wipers are frozen to the windshield, the wiper blades can be torn off and the wiper motor can overheat when switching on. There is a risk of property damage. Defrost the windshield prior to switching the wipers on.

Turning on window wiper system



Press the lever up until the desired position is reached.

- ▷ Rest position of the wipers, position 0.
- ▷ Rain sensor mode, position 1.
- ▷ Normal wiper speed, position 2.
- ▷ Fast wiper speed, position 3.

When the journey is interrupted with the window wiper system turned on: when the journey continues, the wipers resume at their previous speed.

Turning off the window wiper system and flick wipe

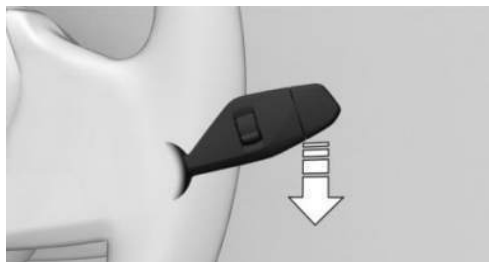

Press the lever down.

- ▶ Turning off: press the lever down until it reaches the 0 position.
- ▶ Flick wipe: press the lever down from the 0 position.
The lever automatically returns to its 0 position when released.

Rain sensor

Principle

The rain sensor automatically controls the wiper operation depending on the intensity of the rainfall.

General information

The sensor is located on the windshield, directly in front of the interior mirror.

Safety information

NOTICE

If the rain sensor is activated, the wipers can accidentally start moving in car washes. There is a risk of property damage. Deactivate the rain sensor in car washes.

Activating rain sensor

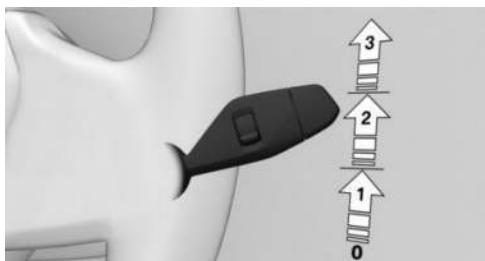

Press lever up once from the 0 position, arrow 1.

Wiping operation is started.

The LED in the wiper lever is illuminated.

In frosty conditions, wiping operation may not start.

Deactivating rain sensor

Press lever back into the 0 position.

Adjusting the rain sensor sensitivity

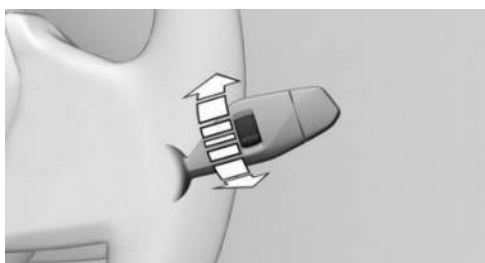

Turn the knurled wheel to adjust the sensitivity of the rain sensor.

- ▶ Upward: high rain sensor sensitivity.
- ▶ Downward: low rain sensor sensitivity.

Window washer system

Safety information

Warning

The washer fluid can freeze onto the window at low temperatures and obstruct the view. There is a risk of accident, injury, and property damage. Only use the window washer system when the washer fluid will not freeze. Use washer fluid with antifreeze, if needed.

NOTICE

When the washer fluid reservoir is empty, the washer pump cannot work as intended. There is a risk of property damage. Do not use the washer system when the washer fluid reservoir is empty.

Cleaning the windshield

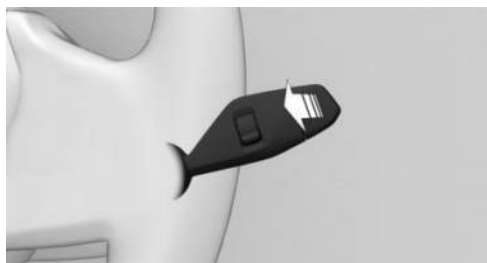

Pull the lever.

The washer fluid is sprayed onto the windshield directly in front of the wiper blade when the wiper moves upward.

Fold-out position of the wipers

Principle

In the fold-out position, the wipers can be folded out from the windshield, which is important, for instance, when changing the wiper

blades or for folding away under frosty conditions.

Safety information

Warning

If the wipers start moving in the folded away state, body parts can be jammed or damage may occur to parts of the vehicle. There is a risk of injury and risk of property damage. Make sure that the vehicle is switched off when the wipers are in the folded-away state and the wipers are folded in when switching on.

NOTICE

If the wipers are frozen to the windshield, the wiper blades can be torn off and the wiper motor can overheat when switching on. There is a risk of property damage. Defrost the windshield prior to switching the wipers on.

Folding out the wipers

1. Turn on standby state.
2. Press and hold the wiper lever down until the wipers stop in a nearly vertical position.

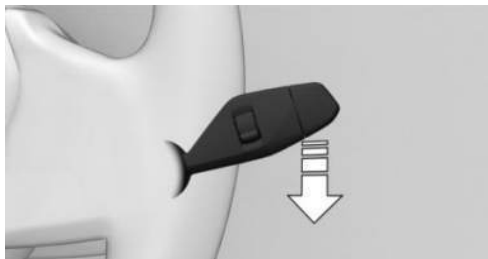

3. Fold the wipers all the way out from the windshield.



Folding in the wipers

1. Fold the wipers back in onto the windshield.
2. Switch on standby state and press and hold the wiper lever down again.

Wipers return to their rest position and are ready again for operation.

Safety

Vehicle features and options

This chapter describes model-specific equipment, systems, and functions that are currently

available, or may become available in the future, even if they are not present in the vehicle.

Additional information:

Vehicle equipment, refer to page 8.

Airbags

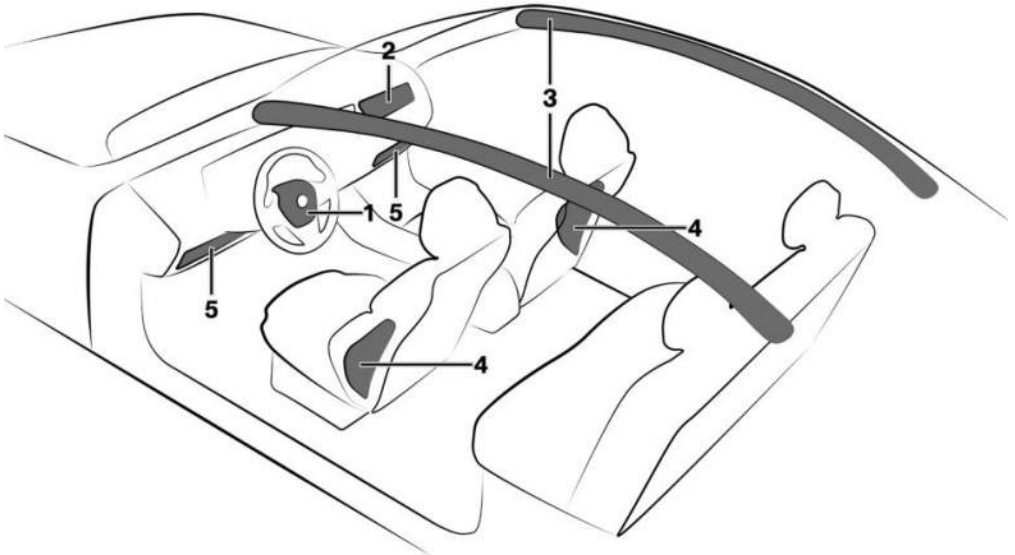

- 1 Front airbag, driver
- 2 Front airbag, front passenger
- 3 Head airbag
- 4 Side airbag
- 5 Knee airbag

Front airbags

The front airbag helps protect the driver and front passenger in the event of a frontal impact in which the seat belts alone would not provide adequate protection.

Side airbag

In the event of a side collision, the side airbag protects the side of the body in the chest and lap area.

Head airbag

In the event of a side collision, the head airbag protects the head.



Ejection Mitigation

The head airbag system is designed as an ejection mitigation countermeasure to reduce the likelihood of ejections of vehicle occupants through side windows during rollovers or side collision events.

Knee airbag

The availability of the knee airbag depends on the national-market version.

The knee airbag protects the legs in the event of a frontal impact.

Protective effect

General information

Airbags are not deployed in every impact situation, e.g., in less severe accidents.

Information on optimum protective effect of the airbags

Warning

If the seat position is incorrect, the seat belts are fastened incorrectly or the deployment area of the airbags is impaired, the airbag system cannot provide protection as intended and may cause additional injuries due to deployment. There is a risk of injury or danger to life. Follow the information on achieving the optimum protective effect of the airbag system.

- ▶ Keep a distance from the airbags.
- ▶ Fasten the seat belts correctly.
- ▶ Always grasp the steering wheel on the steering wheel rim. Hold your hands at the 3 o'clock and 9 o'clock positions to keep the risk of injury to your hands or arms as low as possible when the airbag is deployed.
- ▶ Adjust seat and steering wheel so that hands can be crossed over the steering wheel. Select the settings so that the

shoulder rests against the backrest when crossing the hands and the upper body is as far back as possible while still maintaining a comfortable grip on the steering wheel.

- ▶ Make sure that the front passenger is sitting correctly, i.e., with their feet and legs in the footwell, not resting on the dashboard.
- ▶ Make sure that occupants keep their heads away from the side airbag.
- ▶ There should be no additional persons, animals or objects between an airbag and a person.
- ▶ Dashboard and windshield on the passenger's side must stay clear - do not attach adhesive film or coverings and do not attach brackets or cables, for instance for navigation devices or mobile phones.
- ▶ Do not bond the airbag cover panels with adhesive, do not cover them or modify them in any way.
- ▶ Do not use the cover of the front airbag on the passenger's side as a storage area.
- ▶ Keep storage compartments near the airbags closed, e.g., glove compartment or center armrest.
- ▶ Do not place slip covers, seat cushions, or other objects on the front seats unless they are specifically designed for seats with integrated airbags.
- ▶ Do not hang pieces of clothing such as jackets over the backrests.
- ▶ Do not modify individual components or wiring. This also applies to steering wheel covers, the dashboard, and the seats.
- ▶ Do not disassemble the airbag system.

Even when you follow all instructions very closely, injury from contact with the airbags cannot be fully ruled out in certain situations.

The ignition and inflation noise may lead to short-term and, in most cases, temporary hearing impairment in sensitive occupants.

Vehicle modifications for a person with disabilities may affect the air bag system; contact BMW Customer Relations for further information.

Warnings and information on the airbags are also found on the sun visors.

Operational readiness of the airbag system

Safety information

Warning

Individual components can be hot after deployment of the airbag system. There is a risk of injury. Do not touch individual components.

Warning

Improperly executed work can lead to failure, malfunction or unintentional deployment of the airbag system. In the case of a malfunction, the airbag system might not deploy as intended despite the accident severity. There is a risk of injury or danger to life. Have the airbag system checked, repaired, disassembled, and scrapped by an authorized service center or another qualified service center or repair shop.

Display in the instrument cluster



When drive-ready state is turned on, the warning light in the instrument cluster illuminates briefly, thereby indicating the operational readiness of the entire airbag system and the seat belt tensioners.

Malfunction



- ▷ Warning light does not illuminate when drive-ready state is turned on.
- ▷ The warning light illuminates continuously.

The airbag system or the seat belt tensioners may not be operational. Have the vehicle checked immediately by an authorized service center or another qualified service center or repair shop.

Setting the front seat positions

The power that deploys the driver's/front passenger airbags depends on the position of the driver's/front passenger seat.

To maintain the accuracy of this function, calibrate the electrical front seats as soon as a respective message appears on the control display.

Additional information:

Seats, refer to page [103](#).

Automatic deactivation of front passenger airbag

Principle

The system reads if the front passenger seat is occupied by measuring the human body's resistance.

The front passenger airbag is activated or deactivated.

General information

Before transporting a child on the front passenger seat, refer to the safety information and instructions for children on the front passenger seat, see Children.



Safety information

Warning

To ensure the front passenger airbag function, the system must be able to detect whether a person is sitting in the front passenger seat. The entire seat surface must be used for this purpose. There is a risk of injury or danger to life. Make sure that the front passenger keeps his or her feet in the foot-well.

Functional requirements

To enable accurate recognition of the occupied seat surface:

- ▶ Do not attach covers, cushions, ball mats or other items to the front passenger seat unless they are specifically determined to be safe for use on the front passenger seat.
- ▶ Do not place objects under the seat that can press against the seat from below.
- ▶ Do not place any electronic devices on the front passenger seat if a child restraint system is to be installed on it.
- ▶ No moisture in or on the seat.

Indicator light, front passenger airbag

The front passenger airbag indicator light in the headliner indicates the operating state of the front passenger airbag.

The light indicates whether the airbag is activated or deactivated.

After drive-ready state is switched on, the light illuminates briefly and then indicates whether the airbag is activated or deactivated.



- ▶ The indicator light illuminates when a child is properly seated in a child restraint system or when the seat is empty. The airbag on the

front passenger's side is not activated.

- ▶ The indicator light does not illuminate when, for instance, a correctly seated person of sufficient size is detected on the seat. The airbag on the front passenger's side is activated.

Fault of the automatic deactivation system

For adolescents and adults, the front passenger airbag may deactivate in certain seat positions. In this case, the indicator light for the front passenger airbag illuminates in the headliner.

In this case, change the seat position so that the front passenger airbag activates and the indicator light goes out.

If it is not possible to activate the airbags, have the person sit in the rear seat.

Detected child restraint systems

The system generally detects children seated in a child restraint system, particularly in child restraint systems required by NHTSA at the point in time when the vehicle was manufactured. After installing a child restraint system, make sure that the indicator light for the front passenger airbag illuminates. This indicates that the child restraint system has been detected and the front passenger airbag is not activated.

Collision warning systems

General information

Depending on the equipment, the vehicle has different systems that can help prevent the risk of imminent collision.

- ▶ Forward Collision Mitigation with brake intervention, refer to page [174](#).
- ▶ Lane departure warning, refer to page [181](#).

- ▷ Active Blind Spot Detection, refer to page 184.
- ▷ Side collision mitigation, refer to page 187.
- ▷ Rear-end collision preparation, refer to page 189.
- ▷ Emergency Stop Assistant, refer to page 189.

Safety information

Warning

The system cannot serve as a substitute for the driver's personal judgment in assessing the traffic situation. Based on the limits of the system, it cannot independently react to all traffic situations. There is a risk of accident, injury, and property damage. Adjust driving style to traffic conditions. Watch the surrounding traffic situation closely, be ready to take over steering and braking at any time, and actively intervene where appropriate.

Warning

Indicators and warnings cannot serve as a substitute for the driver's personal judgment. Due to its limits, the system may not issue warnings or responses, or these may be issued late or in a manner that is not consistent with their normal use. There is a risk of accident, injury, and property damage. Adjust driving style to traffic conditions. Watch surrounding traffic closely and actively intervene where appropriate.

Sensors

Depending on vehicle equipment, the Intelligent Safety systems are controlled by the following sensors:

- ▷ Camera behind the windshield.
- ▷ Front radar sensor.

- ▷ Radar sensors, side, front.
- ▷ Radar sensors, side, rear.

Additional information:

Sensors of the vehicle, refer to page 41.

Turning on/turning off collision warning systems

Depending on national-market version, some of the systems are automatically activated whenever you start driving.

The following functions are adjustable.

1.  Apps menu
2. "Vehicle"
3. "Driving settings"
4. "Driver Assistance"
5. "Safety and warnings"
6. Select the desired settings.

Resetting the settings

The settings of the collision warning systems can be reset to the default settings at vehicle outbound delivery.

1.  Apps menu
2. "Vehicle"
3. "Driving settings"
4. "Driver Assistance"
5. "Safety and warnings"
6. "Reset to recommended settings"

System limits

Safety information

Warning

Because of system limitations, this system may either not respond, or respond too late, incorrectly, or without cause. There is a risk of accident, injury, and property damage. Actively intervene as warranted. Refer to the in-

formation in this Owner's Manual regarding the scope of the system's operation and limitations.

- ▷ Intersection Collision Warning with city braking function, refer to page 179.
- ▷ Evasion Assistant, refer to page 180.

Detection capability

The system's detection capability is limited.

The system only takes into account objects that are located in the detection range of the installed sensors and are detected by the system.

Depending on the vehicle equipment, the area is monitored by cameras or radar sensors.

Thus, a system response might not come or might come late.

System limits of the sensors

Additional information:

Sensors of the vehicle, refer to page 41.

Forward Collision Mitigation with brake intervention

Principle

The Forward Collision Mitigation can help prevent accidents. If an accident cannot be avoided, the system can help reduce the severity of the accident.

The system can issue a warning of a possible risk of collision and activate the brakes independently, if needed.

General information

Depending on the equipment version, the Forward Collision Mitigation system includes the following functions:

- ▷ Forward Collision Warning with braking function, refer to page 177.
- ▷ Daytime Pedestrian Collision Mitigation, refer to page 178.

Safety information

Warning

The system cannot serve as a substitute for the driver's personal judgment in assessing the traffic situation. Based on the limits of the system, it cannot independently react to all traffic situations. There is a risk of accident, injury, and property damage. Adjust driving style to traffic conditions. Watch the surrounding traffic situation closely, be ready to take over steering and braking at any time, and actively intervene where appropriate.

Warning

Indicators and warnings cannot serve as a substitute for the driver's personal judgment. Due to its limits, the system may not issue warnings or responses, or these may be issued late or in a manner that is not consistent with their normal use. There is a risk of accident, injury, and property damage. Adjust driving style to traffic conditions. Watch surrounding traffic closely and actively intervene where appropriate.

Sensors

Depending on the equipment, the system is controlled by the following sensors:

- ▷ Camera behind the windshield.
- ▷ Front radar sensor.
- ▷ Radar sensors, side, front.

Additional information:

Sensors of the vehicle, refer to page 41.

Speed range

The system issues a warning of a possible risk of collision at speeds above approx. 3 mph/5 km/h.

If the vehicle speed exceeds approx. 155 mph/250 km/h, the system is deactivated temporarily.

Some functions are deactivated earlier.

The system is enabled as soon as the speed drops below these values again.

Turning the Forward Collision Mitigation on/off

Turning on the system automatically

Depending on the national-market version, the system is automatically active after every departure.

Turning on system manually

The system is activated by setting the warning time.

Additional information:

Setting the warning time, refer to page [175](#).

Turning system off manually

Depending on national-market version, the adjustment can only be made when the vehicle is at a standstill or in a very low speed range.

If necessary, the switch-off must be confirmed successively on the control display.

1.  Apps menu
2. "Vehicle"
3. "Driving settings"
4. "Driver Assistance"
5. "Safety and warnings"
6. "Forward Collision Mitigation"
7. "Off"

Setting the warning time





1.  Apps menu
2. "Vehicle"
3. "Driving settings"
4. "Driver Assistance"
5. "Safety and warnings"
6. "Forward Collision Mitigation"
7. Select the desired setting.

The more sensitive the warning time is set to be, the more warnings will be displayed. The system can therefore also issue more early or unfounded warnings and reactions.

The system checks for visual impairments. Depending on the vehicle equipment, the Driver Attention Camera in the instrument cluster captures the driver's field of vision. Visibility and field of vision also affect the timing of the warnings.

Display in the instrument cluster

The following indicator lights and warning lights are shown on the instrument cluster and, depending on vehicle equipment, on the Head-up display:

Icon	Meaning
	Risk of collision with a person, e.g., a pedestrian.
	Risk of collision, for instance with a preceding vehicle.
	Risk of collision, e.g., with a vehicle crossing from the right.
	Risk of collision, e.g., with a vehicle crossing from the left.
	Risk of collision with a vehicle from an unrecognizable direction of travel.

The corresponding indicator lights and warning lights may display differently if the system detects multiple objects.

Warning function

The Forward Collision Mitigation warns on different warning levels, depending on the respective hazardous situation.

In the event of a prewarning, a warning light illuminates red. In the event of an acute warning, a warning light flashes red and a warning tone sounds.

In the event of a system warning, the driver must intervene immediately and in accordance with the situation.

- ▷ Red warning light illuminates:
 - A hazardous situation has been detected. Increased awareness is required.
- ▷ Red warning light flashes:
 - There is a risk of collision. Intervene immediately.
- ▷ A warning signal sounds:
 - There is a risk of collision. Intervene immediately.
- ▷ Automatic brake intervention:
 - Depending on the equipment and situation in case of risk of imminent collision, the system can also intervene with an automatic brake intervention and automatically decelerate the vehicle, if necessary, to a complete stop.

When the brake pedal is depressed quickly and hard, the maximum brake power of the vehicle is used.

Automatic brake intervention

In case of a risk of collision, the system can assist with an automatic brake intervention, if necessary.

When the vehicle is traveling at a low speed, the vehicle may come to a complete stop.

During automatic brake intervention, Dynamic Stability Control activates automatically.

A brake intervention can be canceled by depressing the accelerator pedal with sufficient force, releasing the brake pedal, or by actively steering.

City brake function: the brake intervention occurs to up to approx. 50 mph/80 km/h.

With radar sensor: the brake intervention occurs to up to approx. 155 mph/250 km/h.

At speeds above approx. 130 mph/210 km/h, only a brief brake intervention will occur.

System limits

Safety information

 **Warning**

Because of system limitations, this system may either not respond, or respond too late, incorrectly, or without cause. There is a risk of accident, injury, and property damage. Actively intervene as warranted. Refer to the information in this Owner's Manual regarding the scope of the system's operation and limitations.

Detection capability

The system's detection capability is limited. The system only takes into account objects that are located in the detection range of the installed sensors and are detected by the system.

Depending on the vehicle equipment, the area is monitored by cameras or radar sensors.

Thus, a system response might not come or might come late.

System limits of the sensors

Additional information:

Sensors of the vehicle, refer to page 41.

Functional limitations

The system may be limited in the following situations:

- ▷ In tight curves.
- ▷ With limitation of the driving stability control systems.
- ▷ Up to 10 seconds after turning on drive-ready state using the Start/Stop button.

Also, do not use Forward Collision Mitigation when towing.

Forward Collision Warning with braking function

Principle

The Forward Collision Warning with braking function is a warning function that notifies the driver of a possible risk of collision and brakes automatically as necessary.

In the event of an accident, the system helps by reducing impact speed.

General information

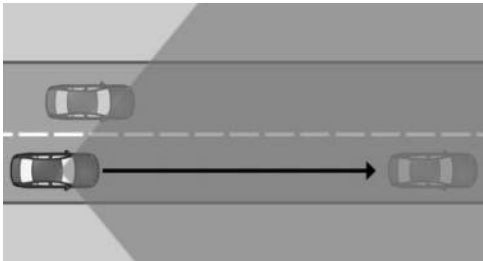

Sensors detect the traffic situation in their detection range.

The system issues a warning of a possible risk of collision with vehicles at speeds above approx. 3 mph/5 km/h. The timing of warnings may vary with the current driving situation.

The system considers the driver's vehicle handling when responding. If an active driving

style is detected, warnings and brake interventions occur less frequently.

Safety information

Follow the safety information in Chapter "Forward Collision Mitigation".

Display in the instrument cluster

If there is a risk of collision with a detected vehicle, a warning light is displayed.

Icon	Meaning
	Forward Collision Warning with a detected vehicle.



Warning function

The warning prompts the driver to intervene.

Additional information:

Forward Collision Mitigation, refer to page 174.

System limits

General information

Follow the system limits in the "Forward Collision Mitigation" chapter.

Detection range

The following situations may not be detected, or only detected with a delay, for instance:

- ▷ Vehicle driving slowly in front and being approached at high speed.
- ▷ Vehicles that suddenly swerve in front of you, or strongly decelerating vehicles.
- ▷ Vehicles with unusual rear designs.
- ▷ Two-wheeled vehicles ahead of you.

Upper speed limit

If the vehicle speed exceeds approx. 155 mph/250 km/h, the system is deactivated temporarily. As soon as the speed drops below this value again, the system is reactivated.

Daytime Pedestrian Collision Mitigation

Principle

The Daytime Pedestrian Collision Mitigation is a warning function that notifies the driver of a possible risk of collision with pedestrians and cyclists and brakes automatically as necessary. The system issues warnings for speeds that are common in towns and cities.

In the event of an accident, the system helps by reducing impact speed.

General information

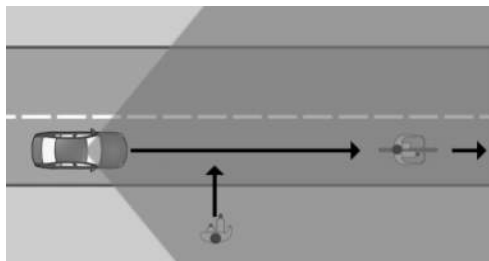

Sensors detect the traffic situation in their detection range.

The system issues a warning of a possible risk of collision with pedestrians or cyclists at speeds above approx. 3 mph/5 km/h.

Safety information

Follow the safety information in Chapter "Forward Collision Mitigation".

Display in the instrument cluster

If there is a risk of collision with a detected pedestrian or cyclist, a warning light is displayed.

Icon	Meaning
	Risk of collision with a person, e.g., a pedestrian.

Warning function

The warning prompts the driver to intervene.

Additional information:

Forward Collision Mitigation, refer to page 174.

System limits

General information

Follow the system limits in the "Forward Collision Mitigation" chapter.

Detection range

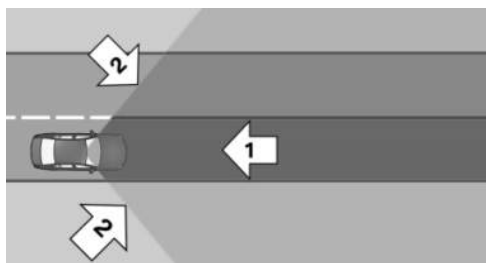

The detection range in front of the vehicle is divided into two areas:

- ▶ Central area, arrow 1, directly in front of the vehicle.
- ▶ Extended area, arrows 2, to the right and left of the central area.

There is a risk of collision if persons, e.g., pedestrians or cyclists, are located within the central area. A warning is issued about pedestrians who are located within the extended area only if they are moving in the direction of the central area.

The following situations may not be detected, for instance:

- ▶ Partially covered pedestrians or bikes.
- ▶ Pedestrians that are not detected as such because of their contour or posture.
- ▶ Pedestrians who are too small for the sensors to detect.

Upper speed limit

Depending on the vehicle equipment, the system responds to pedestrians and cyclists when your vehicle speed is less than approx. 50 mph/80 km/h.

Intersection Collision Warning with city braking function

Principle

The Intersection Collision Warning with city braking function is a warning function that helps prevent accidents with cross traffic at intersections and junctions. At speeds that are common in towns and cities, the system warns the driver of a possible risk of collision and brakes automatically if necessary.

In the event of an accident, the system helps by reducing impact speed.

General information

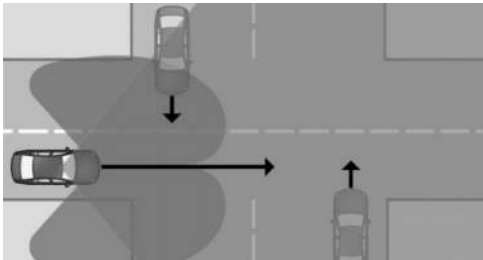

Sensors detect the traffic situation in their detection range.

Vehicles crossing your driving direction can be detected by the system as soon as these vehicles enter into detection range of the sensors.

At intersections and junctions, a warning is issued when a risk of collision with crossing traffic is detected.

The system warns of a possible risk of collision with vehicles at speeds above approx. 6 mph/10 km/h.



The timing of warnings may vary with the current driving situation.

Safety information

Follow the safety information in Chapter "Forward Collision Mitigation".

Display in the instrument cluster

If there is a risk of collision with a detected vehicle, a warning light is displayed.

Icon	Meaning
	Risk of collision with vehicle crossing from the right.
	Risk of collision with vehicle crossing from the left.
	Risk of collision with vehicle for which the driving direction cannot be determined.

Warning function

The warning prompts the driver to intervene.

Additional information:

Forward Collision Mitigation, refer to page 174.

System limits

General information

Follow the system limits in the "Forward Collision Mitigation" chapter.

Detection range

The following situations may not be detected, for instance:

- ▶ Crossing vehicles when they are hidden, e.g. by buildings.
- ▶ Vehicles with an unusual side view.

- ▷ Vehicles in highly dynamic driving situations.
- ▷ Vehicles that suddenly swerve in front of you, or strongly decelerating vehicles.
- ▷ Crossing two-wheeled vehicles.

Upper speed limit

The system responds to crossing vehicles when the vehicle speed is below approx. 50 mph/80 km/h.

Evasion Assistant

Principle

The Evasion Assistant can help the driver perform evasive maneuvers in certain situations, e.g., when obstacles or pedestrians appear suddenly.

General information

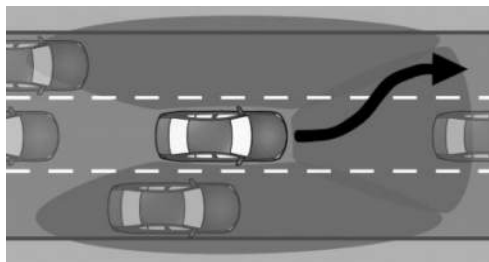

The system issues a warning and intervenes to support the driver if a lateral evasive maneuver is possible.

Sensors monitor and detect the clearance around the vehicle.

If the system detects sufficient free space alongside the vehicle, it helps the driver perform an evasive maneuver safely.

Safety information

Follow the safety information in Chapter "Forward Collision Mitigation".

Functional requirements



- ▷ Forward Collision Mitigation is active.
- ▷ Sensors detect sufficient clearance around vehicle.

Speed range

The Evasion Assistant helps the driver when the vehicle speed is between approx. 19 mph/30 km/h to 100 mph/160 km/h.

Display in the instrument cluster

If there is a risk of collision with a detected vehicle or detected person, e.g., a pedestrian, a warning light is displayed.

Icon	Meaning
	Warning when a vehicle is detected.
	Risk of collision with a pedestrian.

Warning function with evasion support

If the vehicle approaches another object at a high differential speed, a warning is displayed if there is an immediate risk of collision.

Intervene in case of a warning.

The system is designed to provide assistance during evasive maneuvers when there is a risk of collision.

System limits

General information

Follow the system limits in the "Forward Collision Mitigation" chapter.

Detection range

The following situations may not be detected, for instance:

- ▷ Vehicle driving slowly in front and being approached at high speed.
- ▷ Vehicles that suddenly swerve in front of you, or strongly decelerating vehicles.
- ▷ Vehicles with unusual rear designs.
- ▷ Two-wheeled vehicles ahead of you.
- ▷ Partially covered pedestrians or bikes.
- ▷ Pedestrians that are not detected as such because of their contour or posture.
- ▷ Pedestrians who are too small for the sensors to detect.

Lane Departure Warning

Principle

The lane departure warning alerts when the vehicle is about to run off the road or exit the lane.

General information

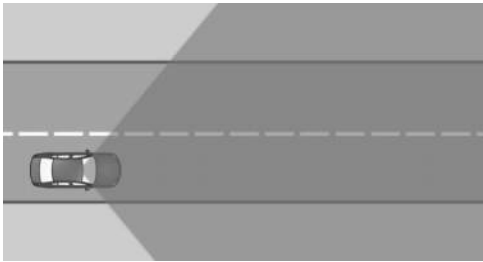

Sensors detect the traffic situation in their detection range.

The system issues a warning starting at a minimum speed. The minimum speed is country-specific and displayed on the control display.

Various warning functions from this system help the driver keep their vehicle in their lane.

The system does not provide a warning if the turn signal is set in the respective direction before exiting the lane.

Safety information

Warning

The system cannot serve as a substitute for the driver's personal judgment in assessing road and traffic situations. There is a risk of accident, injury, and property damage. Adjust driving style to traffic conditions. Watch surrounding traffic closely and actively intervene where appropriate. Do not jerk the steering wheel in response to a warning.

Warning

Indicators and warnings cannot serve as a substitute for the driver's personal judgment. Due to its limits, the system may not issue warnings or responses, or these may be issued late or in a manner that is not consistent with their normal use. There is a risk of accident, injury, and property damage. Adjust driving style to traffic conditions. Watch surrounding traffic closely and actively intervene where appropriate.

Functional requirement

The camera must detect the lane boundaries for the lane departure warning to be active.

The areas of the sensors must be clean and clear.

Sensors

The system is controlled by a camera behind the windshield.

Turning the Lane Departure Warning on/off

Turning on the system automatically

Depending on the national-market version, the system is automatically active after every departure.



Turning on system manually

The system is activated by setting the warning time.

Additional information:

Setting the warning time, refer to page [182](#).

Turning system off manually

Depending on vehicle equipment and national-market version, you must successively confirm the switch-off on the control display.

1. ■■ Apps menu
2. "Vehicle"
3. "Driving settings"
4. "Driver Assistance"
5. "Safety and warnings"
6. "Lane Departure Warning"
7. "Off"

Setting Lane Departure Warning

Setting the warning time

1. ■■ Apps menu
2. "Vehicle"
3. "Driving settings"
4. "Driver Assistance"
5. "Safety and warnings"
6. "Lane Departure Warning"
7. Select the desired setting.
 - ▷ "Early"
 - ▷ "Medium"
 - ▷ "Reduced"

Some warnings are suppressed depending on the situation, for instance when purposely driving over lane markings in curves or with dynamic passing without a turn signal.

Setting the intensity of the steering wheel vibration

1. ■■ Apps menu
2. "Vehicle"
3. "Driving settings"
4. "Driver Assistance"
5. "Feedback via steering wheel"
6. "Vibration intensity"
7. Select the desired setting.

The setting is applied to all collision warning systems.

Depending on the national-market version: turning steering intervention on/off

1. ■■ Apps menu
2. "Vehicle"
3. "Driving settings"
4. "Driver Assistance"
5. "Safety and warnings"
6. "Lane Departure Warning"
7. "Steering intervention"

Depending on the national-market version, the steering intervention is automatically active after every driving off.

Display in the instrument cluster

Different system statuses are displayed on the instrument cluster, depending on vehicle equipment and national-market version.

Icon	Meaning
	Indicator light illuminates green: System is switched on. At least one lane boundary has been detected on one side of the vehicle. The system is ready to intervene and issue warnings. The system can perform steering interventions.
	Indicator light flashes green: System is performing a steering intervention.



Indicator light illuminates green: System is switched on. At least one lane boundary has been detected on one side of the vehicle. The system is ready to intervene and issue warnings. The system can perform steering interventions.



Indicator light flashes green: System is performing a steering intervention.

Depending on vehicle equipment and national-market version, information for the system is displayed in the Assisted View of the instrument cluster.

Additional information:

Assisted View, refer to page 153.

Warning function

General information

Different warnings are issued by the Lane Departure Warning system, depending on situation and speed:

- ▷ Indicator lights and warning lights on the instrument cluster.
- ▷ Vibration of steering wheel.
- ▷ Steering intervention.
- ▷ Warning tone.

Steering wheel vibration

If you leave the lane and if a lane boundary has been detected, the steering wheel vibrates in accordance with the steering wheel vibration setting.

When the turn signal is switched on in the corresponding direction before changing the lane, a warning is not issued.

Steering intervention

Depending on the equipment and the national-market version: if a lane marking is crossed in the speed range up to 130 mph/210 km/h, the system intervenes with a brief active steering intervention in addition to vibrating. The system supports the driver in keeping the vehicle within the lane. The steering intervention can be noticed on the steering wheel and can be manually overridden at any time.

During an active steering intervention, a light is displayed on the instrument cluster.

For instance, the steering intervention will be suppressed in the following situations:

- ▷ With hard accelerating or braking.
- ▷ When flashing.
- ▷ With hazard warning system switched on.
- ▷ In driving situation with high driving dynamics.
- ▷ While Dynamic Stability Control regulates driving stability.
- ▷ Immediately following a steering intervention by the vehicle systems.
- ▷ When actively merging back to your own lane after passing.

End of warning

For instance, the warning or an active steering intervention will be canceled in the following situations:

- ▷ Automatically after a few seconds.
- ▷ When returning to your own lane.
- ▷ With hard accelerating or braking.
- ▷ With hazard warning system switched on.
- ▷ When flashing.
- ▷ While Dynamic Stability Control regulates driving stability.
- ▷ While Dynamic Stability Control is disabled.
- ▷ Immediately following a steering intervention by the vehicle systems.

- ▷ With manual steering intervention.
- ▷ When another driver assistance system is activated, if applicable.
- ▷ No lane boundaries detected.
- ▷ When the system limits are reached.

Warning signal

A warning tone sounds if the driver does not actively steer after the Lane Departure Warning system has performed multiple active steering interventions within three minutes.

- ▷ A short warning tone will sound after the second steering intervention.
- ▷ A longer warning tone will sound following the third steering intervention.

In addition, a Check Control message is displayed.

The warning tone and Check Control message advise the driver to pay closer attention to their lane.

The longer warning tone is stopped if the driver takes control of the steering.

System limits

General information

Follow the system limits in the "Collision warning systems" chapter.

Functional limitations

The system may be limited in the following situations:

- ▷ In the event of missing, worn, poorly visible, merging, diverging, or multiple lane boundaries such as in construction areas.
- ▷ With lane boundaries that are covered in snow, ice, dirt or water.
- ▷ In tight corners or on narrow roads.
- ▷ With lane boundaries that are covered by objects.

- ▷ When driving very close to the vehicle in front of you.
- ▷ Up to 10 seconds after turning on drive-ready state using the Start/Stop button.
- ▷ While Dynamic Stability Control is disabled.

A Check Control message may be displayed when the system is limited. A yellow warning light also illuminates, depending on national-market version.

Active Blind Spot Detection

Principle

Active Blind Spot Detection detects vehicles in the blind spot or vehicles approaching from behind in the adjacent lane.

The warning light in the exterior mirror gives warnings at different levels.

General information

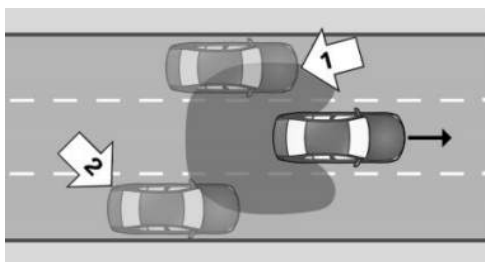

Radar sensors monitor the area behind and next to the vehicle when traveling faster than a minimum speed.

The minimum speed is country-specific and displayed in the Active Blind Spot Detection menu.

The system indicates whether there are vehicles in your blind spot, arrow 1, or approaching from behind in an adjacent lane, arrow 2. The warning light in the exterior mirror illuminates dimly.

Before you change lanes after setting the turn signal, the system issues a warning in the

situations described above. The warning light in the exterior mirror flashes and the steering wheel vibrates.

When turning at a speed of up to approx. 12 mph/20 km/h, the steering wheel will not vibrate.

Safety information

Follow the safety information in the "Forward Collision Mitigation" chapter.

Sensors

The system is controlled by the following sensors:

- ▶ Camera behind the windshield.
- ▶ Radar sensors, side, rear.

Functional requirement

The areas of the sensors must be clean and clear.

Turning Active Blind Spot Detection on/off

1.  Apps menu
2. "Vehicle"
3. "Driving settings"
4. "Driver Assistance"
5. "Safety and warnings"
6. "Active Blind Spot Detection"
7. Select the desired setting.

Adjusting the Active Blind Spot Detection

Setting the warning time

1.  Apps menu
2. "Vehicle"
3. "Driving settings"
4. "Driver Assistance"

5. "Safety and warnings"
6. "Active Blind Spot Detection"
7. Select the desired setting.

Setting the intensity of the steering wheel vibration

1.  Apps menu
2. "Vehicle"
3. "Driving settings"
4. "Driver Assistance"
5. "Feedback via steering wheel"
6. "Vibration intensity"
7. Select the desired setting.

The setting is applied to all collision warning systems.

Depending on the national-market version: turning steering intervention on/off

1.  Apps menu
2. "Vehicle"
3. "Driving settings"
4. "Driver Assistance"
5. "Safety and warnings"
6. "Active Blind Spot Detection"
7. "Steering intervention"

Display in the instrument cluster

Depending on vehicle equipment and national-market version, information for the system is displayed in the Assisted View of the instrument cluster.

Additional information:

Assisted View, refer to page [153](#).

Warning function

Warning light in exterior mirror



The warning light in the exterior mirror warns of a possible collision with a detected vehicle.

Prewarning

The dimmed warning light in the exterior mirror indicates when vehicles are in your blind spot or approaching from the rear.

Acute warning

When an acute warning occurs, the steering wheel vibrates briefly. The warning light in the exterior mirror flashes brightly.

An acute warning is issued if the following conditions are met:

- ▶ Another vehicle is located in the critical area.
- ▶ Your own vehicle is approaching the other lane.
- ▶ Depending on the system setting when the turn signal is turned on.

The warning stops when the other vehicle has left the critical area or the turn signal has been turned off.

Steering intervention

Depending on the national-market version: when there is no response to the vibration of the steering wheel at speeds of up to 130 mph/210 km/h and the lane marking is crossed, the system engages the active

steering intervention. The steering intervention helps return the vehicle into the lane. The steering intervention can be noticed on the steering wheel and can be manually overridden at any time.

The steering intervention is carried out from a minimum speed. The minimum speed is displayed on the control display.

Warning light flashing

When the vehicle is unlocked, the warning light in the exterior mirror flashes for self-testing purposes.

System limits

General information

Follow the system limits in the "Collision warning systems" chapter.

Upper speed limit

If the vehicle speed exceeds approx. 155 mph/250 km/h, the system is deactivated temporarily.

If the vehicle speed falls below approx. 155 mph/250 km/h, the system is reactivated.

Displaying warnings

The number of warnings shown depends on how the settings are configured. However, there may also be an excess of unwarranted warnings of critical situations.

Functional limitations

The system may be limited in the following situations:

- ▶ When a vehicle is approaching at a speed much faster than your own.
- ▶ In tight corners or on narrow roads.
- ▶ The bumper is dirty, iced up or covered, for instance by stickers.

Depending on the national-market version, the steering intervention e.g. in the following situations:

- ▷ In the event of missing, worn, poorly visible, merging, diverging, or multiple lane boundaries such as in construction areas.
- ▷ With lane boundaries that are covered in snow, ice, dirt or water.
- ▷ With lane boundaries that are not white.
- ▷ With lane boundaries that are covered by objects.
- ▷ When driving very close to the vehicle in front of you.
- ▷ If the camera is impaired.
- ▷ Up to 10 seconds after turning on drive-ready state using the Start/Stop button.

A Check Control message may be displayed when the system is limited. A yellow warning light also illuminates, depending on national-market version.

Side collision mitigation

Principle

The side-collision warning helps to avoid an impending side collision.

General information

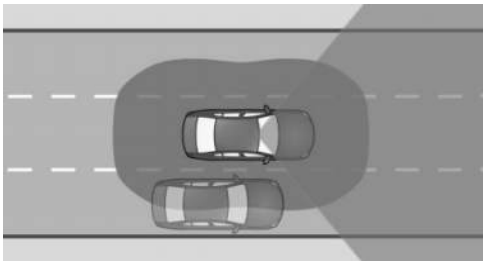

Radar sensors monitor the space next to the vehicle when traveling faster than a minimum speed and up to approx. 130 mph/210 km/h.

The minimum speed is country-specific and displayed on the control display.

If, for example, another vehicle is detected next to your vehicle and there is a risk of collision with this vehicle, the system helps avoid a collision. For this purpose, the system issues a warning with a flashing LED in the exterior mirror, a Check Control message and a vibrating steering wheel. If necessary, an active steering intervention is performed by the system.

Safety information

Follow the safety information in the "Forward Collision Mitigation" chapter.

Functional requirement

The camera behind the windshield determines the lane boundary positions.

The camera must detect the lane markings for the side collision mitigation with steering intervention to be active.

Sensors

The system is controlled by the following sensors:

- ▷ Camera behind the windshield.
- ▷ Radar sensors, side, front.
- ▷ Radar sensors, side, rear.

Turning the side collision warning on/off

1.  Apps menu
2. "Vehicle"
3. "Driving settings"
4. "Driver Assistance"
5. "Safety and warnings"
6. "Side collision warning"
7. Select the desired setting.

Setting the intensity of the steering wheel vibration

1.  Apps menu
2. "Vehicle"
3. "Driving settings"
4. "Driver Assistance"
5. "Feedback via steering wheel"
6. "Vibration intensity"
7. Select the desired setting.

The setting is applied to all collision warning systems.

Display in the instrument cluster

Depending on vehicle equipment and national-market version, information for the system is displayed in the Assisted View of the instrument cluster.

Additional information:

Assisted View, refer to page [153](#).

Warning function

Warning light in exterior mirror



The warning light in the exterior mirror warns of a possible collision with a detected vehicle.

Acute warning

If there is a risk of collision, the warning light in the exterior mirror flashes and the steering wheel starts vibrating.

A Check Control message is displayed at the same time.

Steering intervention

Depending on the national-market version, if necessary, the system engages the active steering intervention to prevent a collision and maintain the vehicle within its own lane. The steering intervention can be noticed on the steering wheel and can be manually overridden at any time.

System limits

General information

Follow the system limits in the "Collision warning systems" chapter.

Functional limitations

The system may be limited in the following situations:

- ▷ When a vehicle is approaching at a speed much faster than your own.
- ▷ In tight corners or on narrow roads.
- ▷ In the event of missing, worn, poorly visible, merging, diverging, or multiple lane boundaries such as in construction areas.
- ▷ With lane boundaries that are covered in snow, ice, dirt or water.
- ▷ With lane boundaries that are not white.
- ▷ With lane boundaries that are covered by objects.
- ▷ When driving very close to the vehicle in front of you.
- ▷ Up to 10 seconds after turning on drive-ready state using the Start/Stop button.

A Check Control message may be displayed when the system is limited.

Rear-end collision preparation

Principle

Depending on the equipment and national-market version, the rear-end collision preparation can react to vehicles approaching from behind.

General information

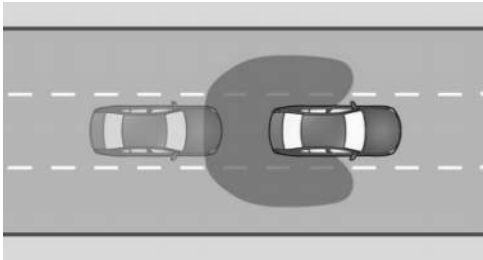

Radar sensors monitor the area behind the vehicle.

When a vehicle approaches from the rear at a certain speed, the system can react as follows:

- ▶ Where applicable, the hazard warning flashers will be switched on.
- ▶ Where applicable, the PreCrash functions are triggered.

Safety information

Follow the safety information in the "Forward Collision Mitigation" chapter.

Sensors

The system is controlled by the radar sensors on the sides and rear.

Turning rear-end collision preparation on/off

The system is automatically active when the vehicle is turned on.

The system is deactivated when reversing.

System limits

General information

Follow the system limits in the "Collision warning systems" chapter.

Functional limitations

This function may be restricted if the speed of the approaching vehicle is much higher or similar to your own speed.

Emergency Stop Assistant

Principle

If the driver can no longer drive the vehicle safely, the Emergency Stop Assistant helps to bring the vehicle to a safe standstill.

General information

The Emergency Stop Assistant is not triggered automatically. The system can only be triggered manually by the occupants.

When the system is triggered, the vehicle is brought to a standstill in its own lane by use of lane keeping.

Depending on the vehicle equipment and national-market version, the system includes a lane change function.

With lane change function: on motorways or motorway-like roads, the system steers the vehicle to the side of the road or shoulder where possible. On other roads or with high traffic volume, the vehicle is brought to a standstill in the current lane.

Overview

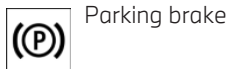
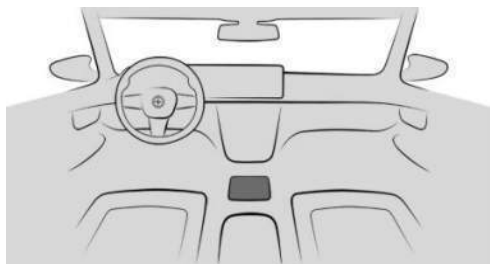

Functional requirements

- ▶ The Emergency Stop Assistant can be triggered at speeds of approx. 6 mph/10 km/h up to approx. 155 mph/250 km/h.
- ▶ With lane change function: lane changes are executed when the traffic situation allows.

Triggering the Emergency Stop Assistant

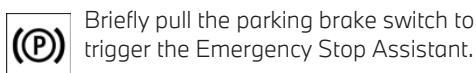

- ▶ With lane change function: releasing the switch may trigger an automatic lane change.
- ▶ The system will take control of the vehicle for a maximum of 2 minutes.
- ▶ The hazard warning system is switched on.
- ▶ An emergency call is triggered when stationary, depending on vehicle equipment.

Canceling Emergency Stop Assistant

The driver can cancel the Emergency Stop Assistant by actively taking control of driving the vehicle throughout the entire process.

The system is stopped by the following actions, for example:

- ▶ By pressing the accelerator pedal.
- ▶ By operating the turn signal.
- ▶ By turning off the hazard warning system.
- ▶ By steering.
- ▶ By changing the selector lever position when stopped.
- ▶ By stopping the emergency call.
- ▶ By pressing the parking brake switch.

At standstill

As soon as the vehicle is stationary, the system will carry out the following settings:

- ▶ The vehicle is secured against rolling away.
- ▶ The interior lights are switched on.
- ▶ The central locking system is unlocked.

Display in the instrument cluster

Icon	Status
	Emergency Stop Assistant is triggered.

Without lane change function:

Icon	Status
	When lane markings are detected, the system keeps the vehicle in the lane.
	Lane keeping is briefly interrupted.
	Lane boundary driven over. When lane markings are detected, the system keeps the vehicle in the lane.
	The hands are not grasping the steering wheel. The system is still active.

Icon Status

Warning light illuminates red and acoustic signal sounds: Hands not grasping steering wheel. Interruption of lane keeping is imminent.



Warning light illuminates red and acoustic signal sounds: lane keeping is switched off.

System limits

Use the system only in the event of a driver failure.

The system cannot replace the roadworthy driving performance of a driver.

Cross Traffic Warning

Principle

At blind driveway exits or when driving out of perpendicular parking spaces, road users approaching from the side are detected sooner by the cross traffic warning than is possible from the driver's seat.

General information

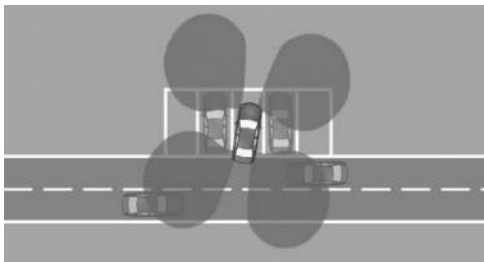

The area behind the vehicle is monitored by sensors.

Depending on the vehicle equipment, the area around the vehicle in front of the vehicle is monitored as well.

The system indicates approaching road users.

Follow the information in the "Parking assistance systems" chapter.

Safety information

Warning

The system cannot serve as a substitute for the driver's personal judgment in assessing the traffic situation. Based on the limits of the system, it cannot independently react to all traffic situations. There is a risk of accident, injury, and property damage. Adjust driving style to traffic conditions. Watch the surrounding traffic situation closely, be ready to take over steering and braking at any time, and actively intervene where appropriate.

Sensors

The system is controlled by the following sensors:

- ▷ Radar sensors, side, rear.
- ▷ Depending on the equipment: radar sensors, side, front.

Activating/deactivating Cross Traffic Warning

The system must be activated on the control display for the Cross Traffic Warning to switch on automatically.

1.  Apps menu
2. "Vehicle"
3. "Driving settings"
4. "Driver Assistance"
5. "Parking and maneuvering"
6. Depending on the equipment, select the following setting:
 - ▷ "Rear warning"
 - ▷ "Front and rear warning"

Turning on the cross traffic warning automatically

The system must be activated on the control display. The system turns on automatically as soon as Park Distance Control or a camera view activates and you engage a gear position.

If reverse gear is engaged, the rear system is switched on.

Depending on the equipment, the front system is turned on when a gear position is engaged.

Depending on the national-market version, the system is automatically active when the vehicle is started.

Turning off the cross traffic warning automatically

The system is automatically turned off in the following situations:

- ▶ When the speed exceeds walking speed.
- ▶ When a certain distance covered is exceeded.

Warning function

General information

The control display shows the corresponding view, an acoustic signal may sound as necessary, and the warning light in the exterior mirror flashes.

Visual warning

Warning light in exterior mirror



The warning light in the exterior mirror flashes if the rear sensors detect other vehicles when the vehicle is reversing.

Display in the Park Distance Control view



In the Park Distance Control view, the respective boundary area flashes red if vehicles are detected by the sensors.

Depending on vehicle equipment: display in camera image

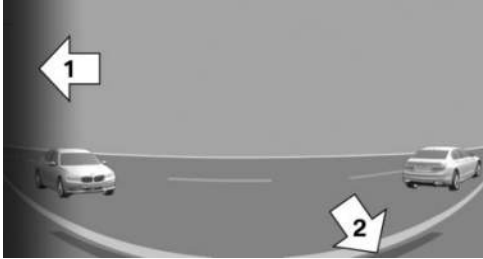

Depending on the direction of travel, the view to the front or back is displayed in the camera image.

The respective boundary area, arrow 1, in the camera image flashes red if vehicles are detected by the sensors.

Yellow lines, arrow 2, mark the bumper of your own vehicle.

Acoustic warning

In addition to the visual warning, a signal tone sounds if your own vehicle moves into the respective direction.

Depending on the national-market version, the signal tone will already sound when the gear position is engaged.

System limits

System limits of the sensors

Additional information:

Sensors of the vehicle, refer to page 41.

Functional limitations

The function can be limited, for instance in the following situations:

- ▶ In tight curves.
- ▶ Crossing objects are moving at a very slow or a very fast speed.
- ▶ Other objects that hide cross traffic are in the capture range of the sensors.

BMW Drive Recorder

Principle

The BMW Drive Recorder stores brief video recordings of the vehicle surroundings, e.g., to document surrounding traffic.

Vehicle features and options

This system may not be available in the owned vehicle, e.g. due to the selected optional equipment, the national-market version or the option for later enabling and software updates. This also applies to individual functions of the system.

For information on whether a function is currently available in the vehicle or when the function can be installed in the vehicle, contact an authorized service center or another qualified service center or repair shop.

Additional information:

Vehicle equipment, refer to page 8.

General information

Video recordings can be saved in different ways:

- ▶ Automatic storage of the recording.
 - The function makes it possible to document the accident with the correspondingly set recording type.
- ▶ Manual storage of the recording.
 - This function is used to document traffic situations with the configured recording type.

The assistance systems' cameras are used to record, e.g., Panorama View.

Additionally, the following parameters are stored for the trip:

- ▶ Date.
- ▶ Time.
- ▶ Vehicle speed.
- ▶ Global Positioning System coordinates.

Data protection

The permissibility of recording and using video recordings is contingent upon the statutory regulations of the country in which the system is to be used. The user is responsible for the use of the system and compliance with respective applicable regulations.

The manufacturer of the vehicle recommends confirming there are no statutory or regulatory constraints on use of the system in your state or country prior to the initial use. In addition, the laws with respect to use of the system should be verified in regular intervals, especially when borders are frequently crossed.

Other drivers of the vehicle must be informed about the system. In addition, information about the system is required when handing off the vehicle.

Functional requirements

- ▶ Standby state or drive-ready state is switched on.
- ▶ BMW Drive Recorder is activated.
- ▶ Privacy Policy was accepted.
- ▶ Recording type was selected.
- ▶ Recording time was selected.

Activating/deactivating the BMW Drive Recorder

The BMW Drive Recorder must be activated before the first use of the recording function.

1.  Apps menu
2. "All apps"
3. "Drive Recorder"
4. Accept Privacy Policy.
5. "Settings"
6. "Allow recording"
7. Select the desired setting.

Recording functions

Automatic recording

Recordings are saved automatically when the vehicle sensors detect an accident.

The system saves recordings up to 20 seconds before and after storage is triggered.

If the vehicle accelerates rapidly, an automatic recording may be taken.

Manual recording

Using the button

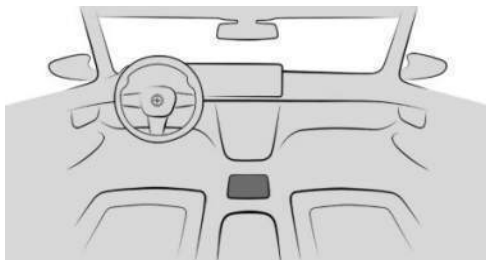

Press and hold this button.

Via iDrive

Start the recording:

1.  Apps menu
2. "All apps"
3. "Drive Recorder"
4. "Recording"
5. "Start recording"

The system saves recordings up to 20 seconds before and after storage is triggered.

Recording playback and administration

Stored video recordings can be played back, exported and deleted.

For your own safety, the video recording is only displayed on the control display up to ap-

prox. 2 mph/3 km/h. In some national-market versions, the video recording is only displayed if the parking brake is engaged or if the selector lever is in the P position.

1.  Apps menu
2. "All apps"
3. "Drive Recorder"
4. "Recordings"
5. Select desired recording.

If a camera change occurred during the recording, different segments of the video can be selected.

Settings

Recording type

1.  Apps menu
2. "All apps"
3. "Drive Recorder"
4. "Settings"
5. Select the desired setting.

Recording time

1.  Apps menu
2. "All apps"
3. "Drive Recorder"
4. "Settings"
5. Select the desired setting.

Cameras

Different cameras can be selected.

1.  Apps menu
2. "All apps"
3. "Drive Recorder"
4. "Settings"
5. "Cam. selection"
6. Select desired camera.

"All": In the event of an accident, the system switches automatically.

If driver assistance systems are enabled, their camera views are automatically selected.

System limits

In the event of serious accidents, it may not be possible to store recordings if the damage on the vehicle is too great or the power supply was interrupted.

If you repeatedly overwrite a USB drive, it may not be possible to export recordings correctly.

The preferred file system for USB storage is NTFS. Other file systems may have limitations.

Active Protection

Principle

Active Protection prepares occupants and the vehicle for a possible accident in critical driving or collision situations.

General information

Depending on vehicle equipment and national-market version, Active Protection consists of various PreCrash functions.

The system is used to detect certain critical driving situations that might lead to an accident. This includes the following critical driving situations:

- ▷ Emergency braking.
- ▷ Severe understeering.
- ▷ Severe oversteering.

Certain functions of several systems can, within the system limits, lead to Active Protection triggering:

- ▷ Forward Collision Warning with braking function: automatic brake intervention.
- ▷ Forward Collision Warning with braking function: brake booster.
- ▷ Rear-end collision preparation: detection of impending rear-end collisions.



Safety information

Warning

The system cannot serve as a substitute for the driver's personal judgment. Due to the system limits, critical situations might not be detected reliably or in time. There is a risk of accident. Adjust driving style to traffic conditions. Watch surrounding traffic closely and actively intervene where appropriate

Function

Depending on the equipment and requirements, the following individual functions are active in accident-critical driving situations:

- ▶ Automatic closing of the windows.
The windows remain open with a small gap.
- ▶ Automatic closing of the glass sunroof.
The sun protection is also closed.
- ▶ Automatic positioning of the backrest for the front passenger seat.

Systems can be returned to the desired settings following a critical driving situation without accident.

PostCrash iBrake

Principle

In certain accident situations, the PostCrash iBrake can automatically bring the vehicle to a standstill without intervention by the driver.

General information

The PostCrash iBrake can reduce the risk of a further collision and its consequences.

At standstill

After coming to a halt, the brake is released automatically.

Harder vehicle deceleration

In certain situations, it may be necessary to bring the vehicle to a stop more quickly than automatic braking with PostCrash iBrake.

To do this, quickly apply extra force to the brake. The brake pressure will then be higher than the brake pressure generated by automatic braking. Automatic braking with Post-Crash iBrake is canceled.

Abort automatic braking

It may be necessary to cancel PostCrash iBrake automatic braking in certain situations, e.g., when making an evasive maneuver.

Abort automatic braking:

- ▶ By depressing the brake pedal for slightly longer.
- ▶ By pressing the accelerator pedal for slightly longer.

Fatigue alert

Principle

The Fatigue Alert break recommendation feature can detect when the driver is fatigued or less alert during long, monotonous trips, for instance on highways. This function recommends taking a break.

Safety information

Warning

The system cannot serve as a substitute for the driver's personal judgment in assessing one's physical state. An increasing lack of alertness or fatigue may not be detected or not be detected in time. There is a risk of accident, injury, and property damage. Make sure that the driver is rested and alert. Adjust driving style to traffic conditions.

Break recommendation

Function

Once a drive is started, this function is trained to the driver, enabling it to detect when the driver is less alert or is fatigued.

This procedure takes, for example, the following criteria into account:

- ▷ Personal driving style, for instance steering behavior.
- ▷ Driving conditions, for instance time, length of trip.
- ▷ Depending on the equipment: attention of the driver through the Driver Attention Camera.

This function activates at speeds greater than approx. 43 mph/70 km/h and can also display a break recommendation.

Setting break recommendation

The break recommendation can be switched on, off and adjusted via iDrive.

1.  Apps menu
2. "Vehicle"
3. "Driving settings"
4. "Driver Assistance"
5. "Safety and warnings"
6. "Fatigue Alert"
7. Select the desired setting.

Despite this function being off, some driver assistance systems may issue break recommendations.

Display

If the driver becomes less alert or fatigued, a message is displayed in the control display with the recommendation to take a break.

During the display, various settings can be selected.

The system is reset approx. 45 minutes after parking the vehicle. A break recommendation

can only be displayed again after this time has elapsed.

System limits

The Fatigue Alert system may be limited. If the system is limited, either no warning may be issued or an unwarranted warning may be issued.

The break recommendation function may be limited in the following situations:

- ▷ If the time is set incorrectly.
- ▷ At a predominantly driven speed below approx. 43 mph/70 km/h.
- ▷ With a sporty driving style such as during rapid acceleration or when cornering fast.
- ▷ In active driving situations such as when changing lanes frequently.
- ▷ When the road condition is poor.
- ▷ In the event of strong side winds.

Driver Attention Camera

Principle

A camera in the instrument cluster monitors the driver's activity and, depending on the equipment, the driver's viewing direction.

General information

The assistance systems help drivers by analyzing whether they are paying attention, e.g., by evaluating their head position and eyes.

Functional requirements

For full operability, make sure that the field of view of the Driver Attention Camera is not obstructed.

The steering wheel and driver's seat height must be adjusted so that the entire instrument cluster is visible. This enables the Driver Attention Camera to record the driver's entire face.



Overview



Depending on vehicle equipment, the instrument cluster may have some infrared light sources. Depending on the light conditions, these light sources can be visible when the vehicle is in standby mode.

System limits

The Driver Attention Camera may not be fully operational in the following situations:

- ▶ When the Driver Attention Camera is covered by the steering wheel.
- ▶ With sunglasses with high protection from infrared light.

Driving stability control systems

Vehicle features and options

This chapter describes model-specific equipment, systems, and functions that are currently available, or may become available in the future, even if they are not present in the vehicle.

Additional information:

Vehicle equipment, refer to page 8.

Antilock Braking System

Principle

The Antilock Braking System prevents locking of the wheels during the braking process.

You remain able to steer your vehicle even during full braking, which increases active driving safety.

General information

The Antilock Braking System is ready after each time drive-ready state is turned on.

Malfunction



The warning light on the instrument cluster illuminates.



A Check Control message is displayed.

- ▷ The Antilock Braking System is not available.
- ▷ Steerability is limited during full braking.

Have the vehicle checked immediately by an authorized service center or another qualified service center or repair shop.

Brake assistant

The brake assistant automatically applies maximum braking assistance when the brake pedal is depressed quickly. This reduces the braking distance to a minimum for full braking.

To make full use of braking assistance, do not reduce the pressure on the brake pedal during full braking.

Dynamic Stability Control

Principle

Dynamic Stability Control helps keep the vehicle on a steady course in critical driving situations. The drive power is reduced depending on the situation, and wheels can be braked individually.

General information

The system detects the following unstable driving conditions, for instance:

- ▷ Skidding, which can lead to oversteering.
- ▷ Loss of adhesion of the front wheels, which can lead to understeering.

Safety information

Warning

The system cannot serve as a substitute for the driver's personal judgment in assessing the traffic situation. Based on the limits of the system, it cannot independently react to all traffic situations. There is a risk of accident, injury, and property damage. Adjust driving style to traffic conditions. Watch the surrounding traffic situation closely, be ready

to take over steering and braking at any time, and actively intervene where appropriate.

Warning

When driving with a roof load, e.g., roof bars, the vehicle's center of gravity is higher. This increases the risk of the vehicle tipping in critical driving situations. There is a risk of accident, injury, and property damage. Drive with roof load only with activated Dynamic Stability Control.

Overview

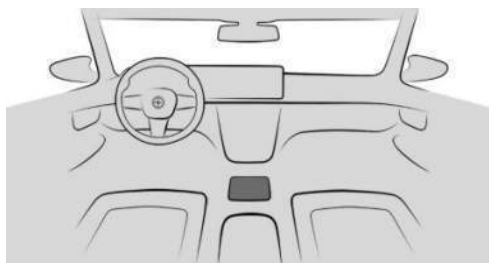

 Dynamic Stability Control

Activating/deactivating Dynamic Stability Control



General information

Dynamic Stability Control is automatically activated whenever drive-ready state is switched on.

If Dynamic Stability Control is deactivated, driving stability is limited when accelerating and cornering.

To support driving stability, reactivate Dynamic Stability Control as soon as possible.

Activating/deactivating the system

-  Press the button to open the menu.
- "DSC OFF"
Dynamic Stability Control is deactivated.
-  Press the button again to reactivate Dynamic Stability Control.

Displays in the instrument cluster

 View when Dynamic Stability Control is deactivated.

 Indicator light illuminates: Dynamic Stability Control is deactivated.

 Warning light flashes: Dynamic Stability Control is regulating the driving and brake power. The vehicle is stabilized. Reduce speed and modify your driving style to the driving circumstances.

 Warning light illuminates: Dynamic Stability Control has failed or is initializing. Driving stabilization is restricted or has failed.

If the warning light illuminates continuously, have the vehicle checked immediately by an authorized service center or another qualified service center or repair shop.

Automatic program change

Dynamic Stability Control can be activated automatically by Forward Collision Mitigation depending on the situation. Deactivate Forward Collision Mitigation as necessary.

Additional information:

Forward Collision Mitigation with brake intervention, refer to page 174.

Dynamic Traction Control

Principle

The Dynamic Traction Control is a variant of the Dynamic Stability Control where the drive power is optimized.

The system ensures maximum drive power on unusual road conditions, for instance unplowed snow covered roads or loose road surfaces, but with somewhat limited driving stability.

General information

The vehicle has maximum traction when Dynamic Traction Control is on. Driving stability is limited during acceleration and when cornering.

A brief activation of the Dynamic Traction Control may be useful in the following situations:

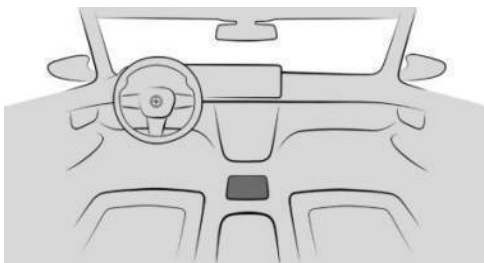

- ▶ When driving in slush or on uncleared, snow-covered roads.
- ▶ When driving off from deep snow or loose ground.
- ▶ When driving with snow chains.

Overview



Dynamic Stability Control

Activating/deactivating the Dynamic Traction Control

1.  Press the button to open the menu.
2. "Traction"
Dynamic Traction Control is activated and Dynamic Stability Control is deactivated.
3.  Press the button again to reactivate Dynamic Stability Control.

Displays in the instrument cluster



View when Dynamic Traction Control is activated.



Indicator light illuminates: Dynamic Traction Control is activated.

Automatic program change

In certain situations, Dynamic Stability Control is activated automatically:

- ▶ Active Cruise Control with Distance Control is activated.
- ▶ In case of a brake intervention by Forward Collision Mitigation. Deactivate Forward Collision Mitigation as necessary.
- ▶ If the suspension control system fails.
- ▶ The vehicle has a flat tire.

Additional information:

Forward Collision Mitigation with brake intervention, refer to page [174](#).

BMW xDrive

Principle

BMW xDrive is the all-wheel-drive system of the vehicle. Concerted action by the BMW



xDrive and other suspension control systems such as Dynamic Stability Control further optimizes traction and driving dynamics.

General information

BMW xDrive variably distributes the drive forces to the front and rear axles as required by the driving situation and road conditions.

Servotronic

Principle

Servotronic is a speed-dependent steering support.

The system provides the steering force with more support at low speeds than at higher ones. This makes it easier to park, for instance, and makes steering firmer when driving at faster speeds.

Setting

The steering force adapts to the drive mode to convey a firm, sporty feel or a comfortable steering response.

Variable sport steering

The variable sports steering facilitates direct and agile handling with little steering effort. The variable sports steering responds independently of the current speed, varying the steering gear ratio in line with the steering angle.

- ▶ In situations that require large movements of the steering wheel, e.g., when maneuvering or turning, even minor movements of the steering wheel will result in a greater wheel steering angle. As a result, the variable sports steering increases steering com-

fort by reducing the necessary steering effort.

- ▶ The wheel angle is reduced in situations that require minor or rapid corrections of the direction of travel when driving at higher speeds, e.g., swerving quickly or correcting for crosswinds. In these cases, the variable sports steering increases driving stability when moving the steering wheel.

Driver assistance systems

Vehicle features and options

This chapter describes model-specific equipment, systems, and functions that are currently available, or may become available in the future, even if they are not present in the vehicle.

Additional information:

Vehicle equipment, refer to page 8.

Speed warning

Principle

The speed warning can be used to set a speed limit. A warning will be issued when this speed limit is exceeded.

General information

Another warning occurs when the set speed limit is exceeded again after it has dropped by 3 mph/5 km/h.

Activating/deactivating the speed warning

1.  Apps menu
2. "Vehicle"
3. "Driving settings"
4. "Driver Assistance"
5. "Safety and warnings"
6. "Speed warning"

Adjusting the speed

1.  Apps menu
2. "Vehicle"
3. "Driving settings"
4. "Driver Assistance"
5. "Safety and warnings"

6. "Speed warning"
7. "Warning above:"
8. Select the desired setting.

Applying current speed as the speed warning

1.  Apps menu
2. "Vehicle"
3. "Driving settings"
4. "Driver Assistance"
5. "Safety and warnings"
6. "Speed warning"
7. "Adopt current speed"

Speed Limit Info

Speed Limit Info

Principle

Speed Limit Info shows the currently valid speed limit in the instrument cluster and, if necessary, the Head-up display.

General information

The camera in the area of the interior mirror detects traffic signs at the edge of the road as well as overhead sign posts.

Traffic signs with extra icons are considered and compared with the vehicle's onboard data. The traffic sign will then be either displayed or ignored depending on the situation in the instrument cluster and the Head-up display.

The system may also show speed limits that apply to routes that are not signposted if the navigation system has current map data.

For Speed Limit Info to function correctly, current map data for the country in which the vehicle is operated must be downloaded.

For information on the current map version and map updates, see Map update in the Navigation system chapter.

Without map data, the system is subject to certain technical limitations. Traffic signs with speed limitations are detected and displayed only. Speed limits due to entering towns/cities, highway signs, etc., are not displayed. Speed limits with extra traffic signs are always displayed.

Additional information:

- ▶ Owner's Manual for Navigation, Entertainment, and Communication, refer to page 6.

Safety information

Warning



The system cannot serve as a substitute for the driver's personal judgment in assessing the traffic situation. Based on the limits of the system, it cannot independently react to all traffic situations. There is a risk of accident, injury, and property damage. Adjust driving style to traffic conditions. Watch the surrounding traffic situation closely, be ready to take over steering and braking at any time, and actively intervene where appropriate.

Sensors

The system is controlled by a camera behind the windshield.

Display

Speed Limit Info

Icon	Description
	Current speed limit. Depending on the national-market version, it is possible to switch between the units of measurement.
	
	No data on current speed limit available.

Warning signals

Depending on the settings, an acoustic signal sounds if the detected speed limit is exceeded or the speed limit changes. The display also flashes if the detected speed limit is exceeded.

Settings

Individual settings can be configured for Speed Limit Info, e.g., warnings issued if the speed is exceeded or the permissible maximum speed changes.

1.  Apps menu
2. "Vehicle"
3. "Driving settings"
4. "Driver Assistance"
5. "Driving"
6. "Speed Limit Assistance"
7. Select the desired setting.

System limits

System limits of the sensors

Additional information:

- ▶ Camera, refer to page 41.

Functional limitations

The system function may be limited and may provide incorrect information in the following situations:

- ▶ Traffic signs are fully or partially concealed by objects, stickers, or paint.
- ▶ Traffic signs do not comply with the standard.
- ▶ In areas that are not included in the navigation system map data.
- ▶ If navigation system map data is invalid, outdated, or unavailable.
- ▶ When roads deviate from the navigation such as due to changes in road layout.
- ▶ When driving very close to the vehicle in front of you.
- ▶ When passing buses or trucks with traffic signs applied to them.
- ▶ In case of electronic traffic signs.
- ▶ When traffic signs that are valid for a parallel road are detected.
- ▶ In the presence of country-specific road signs or road layouts.

Manual Speed Limiter

Principle



The Manual Speed Limiter can be used to set a speed limit, for instance to prevent the vehicle from exceeding speed limits.

General information

The system can limit the speed, starting at 20 mph/30 km/h. The vehicle can be driven at any speed below the set speed limit.

Overview

Buttons on the steering wheel

Button	Function
	System on/off.
	Store current speed. Speed Limit Assistant: accept suggested speed manually.
	Rocker switch: Changing the speed limit.

Operation

Turning on the speed limiter

 Press the button on the steering wheel.

The current speed is adopted as the speed limit.

If the system is turned on while the vehicle is stationary or driving at low speeds, 20 mph/30 km/h is set as the speed limit.

The marking in the speedometer is set to the corresponding speed.

When the speed limit is activated, Dynamic Stability Control is switched on and the vehicle may change drive mode.

Turning off the speed limiter

 Press the button on the steering wheel.

The system switches off automatically in the following situations, for example:

- ▷ When drive-ready state is switched off.
- ▷ When Cruise Control is switched on.
- ▷ When certain driving modes are activated via Driving Experience Control.

The displays turn off.

Stopping the speed limiter

If the reverse gear is engaged or in Neutral, the system is interrupted when rolling backwards.

Changing the speed limit



Press the rocker switch up or down repeatedly until the desired speed limit is set.

- ▷ Each time the rocker switch is pressed to the resistance point, the speed limit increases or decreases by 1 mph/1 km/h.
- ▷ Each time the rocker switch is pressed past the resistance point, the desired speed changes by a maximum of 5 mph/10 km/h.

If the set speed limit is reached or unintentionally exceeded such as when driving downhill, the vehicle is not actively braked.

When the speed limit is set during a trip to a value below the current speed, the vehicle coasts until it drops to the set speed limit.

The current speed can also be stored by pressing a button:



Press the button on the steering wheel.

Exceeding the speed limit

When the vehicle speed exceeds the set speed limit, a warning is issued.

The speed limit can be exceeded intentionally.

Press the accelerator pedal all the way down to intentionally exceed the set speed limit.

When the vehicle speed drops below the set speed limit, the limit is automatically reactivated.

Warning when the speed limit is exceeded

Visual warning



If the speed limit is exceeded: the indicator light in the instrument cluster flashes while the vehicle speed is greater than the set speed limit.

Acoustic warning

- ▷ If the speed limit is exceeded unintentionally, a signal sounds.
- ▷ When the speed limit is reduced to below the current vehicle speed, the signal sounds after some time.
- ▷ When the speed limit is intentionally exceeded by stepping on the accelerator pedal all the way down, there is no signal.

Displays in the instrument cluster



Display in the speedometer

Depending on the equipment, a mark in the speedometer displays the status of the system.



- ▷ Green marking: system is active.
- ▷ Gray marking: system is interrupted.
- ▷ No marking: system is switched off.

Indicator light

Icon	Description
	The indicator light illuminates: the system is switched on. The indicator light flashes: the set speed limit has been exceeded.
	Gray indicator light: the system has been interrupted.

Cruise Control without Distance Control

Principle

With the Cruise Control, a set speed can be adjusted using the buttons on the steering wheel. The system maintains the set speed. The system accelerates and brakes automatically as needed.

General information

The system can be activated starting at 20 mph/30 km/h.

Depending on the vehicle setting, the cruise control settings may change under certain conditions. For instance, acceleration can change depending on the driving mode.

Safety information

Warning

The system cannot serve as a substitute for the driver's personal judgment in assessing the traffic situation. Based on the limits of the system, it cannot independently react to all traffic situations. There is a risk of accident, injury, and property damage. Adjust driving style to traffic conditions. Watch the surrounding traffic situation closely, be ready

to take over steering and braking at any time, and actively intervene where appropriate.

Warning

The use of the system can lead to an increased risk of accidents in the following situations, for instance:

- ▷ On winding roads.
- ▷ With high traffic volume.
- ▷ On slippery roads, in fog, snow, or wet conditions, or on a loose road surface.





There is a risk of accident, injury, and property damage. Only use the system if driving at constant speed is possible.

Warning

The set speed can be incorrectly adjusted or called up by mistake. There is a risk of accident, injury, and property damage. Adjust the set speed to the traffic conditions. Watch surrounding traffic closely and actively intervene where appropriate

Overview

Buttons on the steering wheel

Button	Function
	Cruise control on/off.
	
	Continue cruise control with the last setting.
	Interrupt cruise control.

Button Function

 Store current speed.
Speed Limit Assistant: accept suggested speed manually.

 Rocker switch:
Set speed.

Turning Cruise Control on/off

Turning on the system

 Depending on the equipment version, press the relevant button on the steering wheel.



The indicator lights in the instrument cluster illuminate and the mark on the speedometer is set to the current speed.

Cruise control is active. The current speed is maintained and stored as desired speed.

If necessary, the Dynamic Stability Control will be turned on.

Turning off the system

 Depending on the equipment version, press the relevant button on the steering wheel.



The displays turn off. The stored set speed is deleted.

Interrupting Cruise Control

Stopping the system manually

 When active, press the button.

Stopping the system automatically

The system is automatically interrupted in the following situations, for example:

- ▷ When performing a manual braking process.
- ▷ Selector lever position D is disengaged.
- ▷ While Dynamic Traction Control is enabled or Dynamic Stability Control is disabled.
- ▷ While Dynamic Stability Control regulates driving stability.

Adjusting the speed

Maintaining and storing the speed



Press the rocker switch up or down once while the system is interrupted.

When the system is switched on, the current speed is maintained and stored as the set speed.

The stored speed is displayed on the speedometer.

If necessary, the Dynamic Stability Control will be turned on.

The speed can also be stored by pressing a button.

 Press the button.

Changing the speed



Press the rocker switch up or down repeatedly until the desired speed is set.

If active, the displayed speed is stored and the vehicle reaches the stored speed when the road is clear.

- ▶ Each time the rocker switch is tapped to the resistance point, the set speed increases or decreases by 1 mph/1 km/h.
- ▶ Each time the rocker switch is pressed past the resistance point, the desired speed changes by a maximum of 5 mph/10 km/h.

The maximum speed that can be set depends on the vehicle.

- ▶ Pressing the rocker switch to the resistance point and holding it: vehicle accelerates or decelerates without pressure on the accelerator pedal.

After the rocker switch is released, the vehicle maintains its final speed. Pressing the switch beyond the resistance point causes the vehicle to accelerate more rapidly.

Continuing cruise control

Warning

The set speed can be incorrectly adjusted or called up by mistake. There is a risk of accident, injury, and property damage. Adjust the set speed to the traffic conditions. Watch surrounding traffic closely and actively intervene where appropriate

An interrupted cruise control can be continued by calling up the stored speed. The difference between the current speed and the stored speed should be as little as possible.

 RESUME

Press the button with the system interrupted.

Cruise control is continued with the stored values.

In the following cases, the stored speed value is deleted and cannot be called up again:

- ▶ When the system is switched off.
- ▶ When drive-ready state is switched off.

Displays in the instrument cluster

Display in the speedometer

Depending on the equipment, a mark in the speedometer displays the status of the system.



- ▶ Green marking: system is active, the marking indicates the desired speed.

- ▶ Gray marking: system is interrupted, the marking indicates the stored speed.

- ▶ No marking: system is switched off.

Indicator light

Icon	Description
	No indicator light: system is switched off.
	Indicator light green: system is active.
	Gray indicator light: the system has been interrupted.





Displays in the Head-up display

Some system information can also be displayed in the Head-up display.



The icon is displayed when the set speed is reached.

System limits

The set speed is also maintained downhill. The speed may not be maintained on uphill grades if the drive power is insufficient.

In ECO PRO driving mode, the vehicle may exceed or drop below the set desired speed in some situations, for instance on downhill or uphill grades.

Do not use Cruise Control when towing.

Active Cruise Control with Distance Control

Principle

Using the Cruise Control, a desired speed and a distance to a vehicle ahead can be adjusted using the buttons on the steering wheel.

General information

The system maintains the set speed on clear roads. The vehicle accelerates or brakes automatically.

If a vehicle is driving ahead of you, the system adjusts the speed of the vehicle so that the set distance to the vehicle ahead is maintained. The speed is adjusted as far as the given situation allows.

The distance can be adjusted at several levels. For safety reasons, it depends on the respective speed.

If the vehicle ahead of you brakes to a stand-still and then drives off again within a brief period, the system is able to detect this within the given system limits.

Otherwise, drive off on your own such as by pressing the accelerator pedal or the rocker switch on the steering wheel.

Depending on the vehicle setting, the cruise control settings may change under certain conditions. For instance, acceleration can change depending on the driving mode.

Safety information

Warning

The system cannot serve as a substitute for the driver's personal judgment in assessing the traffic situation. Based on the limits of the system, it cannot independently react to all traffic situations. There is a risk of accident, injury, and property damage. Adjust driving style to traffic conditions. Watch the surrounding traffic situation closely, be ready to take over steering and braking at any time, and actively intervene where appropriate.

Warning

An unsecured vehicle can begin to move and possibly roll away. There is a risk of accident, injury, and property damage. Before leaving the vehicle, secure the vehicle against rolling away.

In order to ensure that the vehicle is secured against rolling away, follow the following:

- ▷ Set the parking brake.
- ▷ Automatic transmission: Make sure that selector lever position P is engaged.
- ▷ On uphill grades or on downhill slopes, turn the front wheels in the direction of the curb.
- ▷ On uphill grades or on downhill slopes, also secure the vehicle, for instance with a wheel chock.

Warning

The set speed can be incorrectly adjusted or called up by mistake. There is a risk of accident, injury, and property damage. Adjust the set speed to the traffic conditions. Watch surrounding traffic closely and actively intervene where appropriate

Warning





Risk of accident is greater when there is a high speed differential to other vehicles, for instance in the following situations:

- ▷ When approaching a slowly moving vehicle at speed.
- ▷ Vehicle suddenly swerving into own lane.
- ▷ When approaching stationary vehicles at speed.







There is a risk of injury or danger to life. Watch surrounding traffic closely and actively intervene where appropriate

Overview

Buttons on the steering wheel

Button	Function
	With Steering Assistant: Cruise control on/off.
	With Steering Assistant: Select function.
	Without Steering Assistant: Cruise control on/off.
	Store current speed. Speed Limit Assistant: accept suggested speed manually.

Button Function

	With Steering Assistant: Interrupt cruise control. Continue cruise control with the last setting.
	Without Steering Assistant: Continue cruise control with the last setting.
	Without Steering Assistant: Interrupt cruise control.
	Increase the distance. Switch Distance Control on/off.
	Reduce distance. Switch Distance Control on/off.
	Rocker switch: Set speed.

Sensors

The system is controlled by the following sensors:

- ▷ Cameras behind the windshield.
- ▷ Front radar sensor.

Additional information:

Sensors of the vehicle, refer to page 41.

Application range

The system is best used on well-maintained roads.

The minimum speed that can be set is 20 mph/30 km/h.

The maximum speed that can be set is limited and depends, for example, on the vehicle and the vehicle equipment.

The system can also be activated when stationary.

Do not use Cruise Control and Distance Control when towing.

Turning Cruise Control on/off or stopping it

With Steering Assistant: Assisted Driving Mode



General information

 This button is used to switch the configured function on and off.

 The button can be used to set the primarily used function.

Setting the function

 When the system is active, press the button repeatedly until the desired function is selected in the toolbar. The toolbar for Assisted Driving mode is displayed at the bottom of the instrument cluster.

Icon	Function
	Cruise Control with Distance Control.
	Cruise Control with Distance Control and Steering Assistant.

The selected function is shown in green.

Turning on the system

With Steering Assistant:

1.  Press the button on the steering wheel.

2.  If necessary, set the cruise control.

Without Steering Assistant:

 Press the button on the steering wheel.

The indicator lights in the instrument cluster illuminate and the mark on the speedometer is set to the current speed.

Cruise control is active. The current speed is maintained and stored as desired speed.

If necessary, the Dynamic Stability Control will be turned on.

Turning off the system

To switch off the system while stationary, step on brake pedal at the same time.

Press the button on the steering wheel:

 With Steering Assistant.

 Without Steering Assistant.

The displays turn off. The stored set speed is deleted.

Stopping the system manually

When active, press the button on the steering wheel:

 With Steering Assistant.

 Without Steering Assistant.

If interrupting the system while stationary, press on the brake pedal at the same time.

Stopping the system automatically

The system is automatically interrupted in the following situations:

- ▷ When performing a manual braking process.
- ▷ Selector lever position D is disengaged.
- ▷ While Dynamic Traction Control is enabled or Dynamic Stability Control is disabled.

- ▷ While Dynamic Stability Control regulates driving stability.
- ▷ When the vehicle is stationary, the seat belt is unbuckled and the driver's door is opened.
- ▷ The system has not detected objects for an extended period, for instance on a road with very little traffic without curb or shoulder markings.
- ▷ The detection range of the radar is impaired, for instance by contamination or heavy precipitation.
- ▷ After a longer stationary period when the vehicle has been braked to a stop by the system.

Adjusting the speed

Maintaining and storing the speed



Press the rocker switch up or down once while the system is interrupted. The system will be activated.

The current speed is maintained and stored as desired speed.

The stored speed is displayed on the speedometer.

If necessary, the Dynamic Stability Control will be turned on.

The speed can also be stored by pressing a button.

 Press the button.

Changing the speed



Press the rocker switch up or down repeatedly until the desired speed is set.

If active, the displayed speed is stored and the vehicle reaches the stored speed when the road is clear.

- ▷ Each time the rocker switch is tapped to the resistance point, the set speed increases or decreases by 1 mph/1 km/h.
- ▷ Each time the rocker switch is pressed past the resistance point, the desired speed changes by a maximum of 5 mph/10 km/h.

Hold the rocker switch in position to repeat the action.

Adjusting the distance

Safety information

Warning

The system cannot serve as a substitute for the driver's personal judgment. Due to the system limits, deceleration can be late. There is a risk of accidents and risk of property damage. Be aware of the surrounding traffic situation at all times. Adjust the distance to the traffic and weather conditions and maintain the prescribed safety distance, possibly by braking.

Reducing the distance



Press the button repeatedly until the desired distance is set.

Instrument cluster will display selected distance.

Increasing the distance



Press the button repeatedly until the desired distance is set.

Instrument cluster will display selected distance.

Automatic adaptation of the distance

Depending on the equipment and national-market version: the system can be set so that the distance to the vehicle in front is automatically adjusted within the set distance. The system analyzes the traffic situation and ambient conditions, e.g., poor visibility.

1. Apps menu
2. "Vehicle"
3. "Driving settings"
4. "Driver Assistance"
5. "Driving"
6. "Speed Limit Assistance"
7. "Situational distance control"

Continuing cruise control

Warning

The set speed can be incorrectly adjusted or called up by mistake. There is a risk of accident, injury, and property damage. Adjust the set speed to the traffic conditions. Watch surrounding traffic closely and actively intervene where appropriate

An interrupted cruise control can be continued by calling up the stored speed. The difference

between the current speed and the stored speed should be as little as possible.

Press the button on the steering wheel with the system interrupted:



With Steering Assistant.



Without Steering Assistant.

Cruise control is continued with the stored values.

In the following cases, the stored speed value is deleted and cannot be called up again:

- ▶ When the system is switched off.
- ▶ When drive-ready state is switched off.

Changing between Cruise Control with/without Distance Control

Safety information

Warning

The system does not react to traffic driving ahead of you, but instead maintains the stored speed. There is a risk of accident, injury, and property damage. Adjust the set speed to the traffic conditions and brake as needed.

Changing over the Cruise Control mode

Switching Cruise Control without Distance Control off and on:



▶ Press and hold this button.



▶ Press and hold this button.

With Steering Assistant: switch on Distance Control:



Press the button.

Without Steering Assistant: switch on Distance Control:



▶ Press the button.



▶ Press the button.

After changing, a Check Control message is displayed.

Displays in the instrument cluster

General information

Depending on the equipment version, the displays in the instrument cluster may vary.

Display in the speedometer

Depending on the equipment, a mark in the speedometer displays the status of the system.

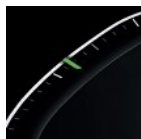

- ▶ Green marking: system is active, the marking indicates the desired speed.
- ▶ Gray marking: system is interrupted, the marking indicates the stored speed.

▶ No marking: system is switched off.

Indicator lights and warning lights

Depending on the equipment:

Icon	Description
	White indicator light: No Distance Control because accelerator pedal is being pressed.
	Indicator light illuminates green: Vehicle has been detected ahead of you. The vehicle icon goes out if no vehicle has been detected ahead of you.
	Indicator light flashes green: Preceding vehicle has driven off.
	Indicator light illuminates gray: System interrupted.
	Indicator light flashes gray: Conditions are not adequate for the system to work. The system was deactivated but applies the brakes until you actively resume control by pressing on the brake pedal or accelerator pedal.
	Warning light flashes red and acoustic signal sounds: Brake and make an evasive maneuver, if necessary.

Assisted View

Depending on the equipment and national-market version, information for the system is displayed in the Assisted View in the central display area of the instrument cluster.

Additional information:

Assisted View, refer to page [153](#).

Displays in the Head-up display

Set speed

Some system information can also be displayed in the Head-up display.



The icon is displayed when the set speed is reached.

Distance information



The icon is displayed when the distance from the vehicle traveling ahead is too short.

The distance information is active in the following situations:

- ▶ Active Cruise Control with Distance Control switched off.
- ▶ Display in the Head-up display selected. Head-up display, refer to page 138.
- ▶ Distance too short.
- ▶ Speed greater than approx. 40 mph/70 km/h.

System limits

System limits of the sensors

Additional information:

- ▶ Cameras, refer to page 41.
- ▶ Radar sensors, refer to page 42.

Detection range

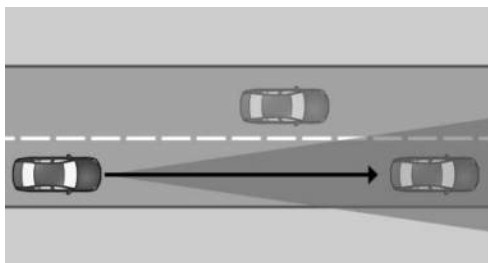

The detection capability of the system and the automatic braking performance are limited.

For instance, two-wheeled vehicles may not be detected.

Deceleration

The system does not decelerate in the following situations:

- ▶ For pedestrians or similarly slow-moving road users.
- ▶ Depending on the vehicle equipment and national availability, for red traffic lights.
- ▶ For cross traffic.
- ▶ For oncoming traffic.

Merging vehicles

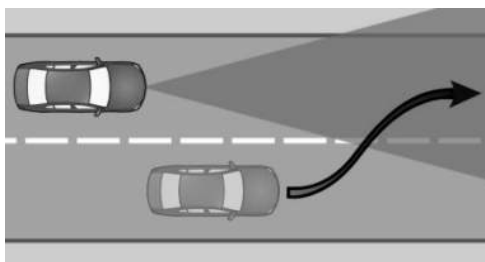

If a vehicle driving ahead of you suddenly merges into your lane, the system may not be able to automatically restore the selected distance. It may not be possible to restore the selected distance in certain situations, including if you are driving significantly faster than vehicles driving ahead of you, for instance when rapidly approaching a truck. When a vehicle driving ahead of you is reliably detected, the system requests that the driver intervene by braking and making an evasive maneuver, if needed.

Cornering



When the set speed is too high for a curve, the speed is reduced slightly. Because curves may not be anticipated in advance, drive into a curve at an appropriate speed.

The system has a limited detection range. Situations can arise in tight curves where a vehicle driving ahead will not be detected or will be detected very late.



When you approach a curve the system may briefly report vehicles in the next lane due to the bend of the curve. If the system decelerates you may compensate for it by briefly accelerating. After releasing the accelerator pedal the system is reactivated and controls speed independently.

Driving off

In some situations, the vehicle cannot drive off automatically; for example:

- ▷ On steep uphill grades.
- ▷ In front of bumps in the road.

In these cases, step on the accelerator pedal.

Weather

The following restrictions can occur under unfavorable weather or light conditions:

- ▷ Poorer vehicle detection.
- ▷ Short-term interruptions for vehicles that are already recognized.

Drive attentively, and react to the current surrounding traffic situation. If necessary, intervene actively, for instance by braking, steering or making an evasive maneuver.

Drive power

The set speed is also maintained downhill. The speed may not be maintained on uphill grades if the drive power is insufficient.

In ECO PRO driving mode, the vehicle may exceed or drop below the set desired speed in some situations, for instance on downhill or uphill grades.

Speed Limit Assistant

Principle

Speed Limit Assistant supports driving at the speed limit. A suggested speed can be applied.

General information

When the systems in the vehicle, e.g., Speed Limit Info, detect a change of the speed limit, this new speed value can be applied for the following systems:

- ▷ Manual Speed Limiter.
- ▷ Cruise control.
- ▷ Active Cruise Control with Distance Control.

The speed value is suggested as the new desired speed to be applied. To apply the speed value, the corresponding system must be activated.

Safety information

Warning

The system cannot serve as a substitute for the driver's personal judgment in assessing the traffic situation. Based on the limits of the system, it cannot independently react to all traffic situations. There is a risk of accident, injury, and property damage. Adjust driving style to traffic conditions. Watch the surrounding traffic situation closely, be ready to take over steering and braking at any time, and actively intervene where appropriate.

Warning

The set speed can be incorrectly adjusted or called up by mistake. There is a risk of accident, injury, and property damage. Adjust the set speed to the traffic conditions. Watch surrounding traffic closely and actively intervene where appropriate



5. "Driving"
6. "Speed Limit Assistance"
7. "Speed limits"
8. Select the desired setting:
 - ▶ "Adjust manually": detected speed limits can be applied manually.
 - ▶ "Show anticipation": Depending on the national-market version: current and upcoming speed limits are displayed in the instrument cluster without being applied.
 - ▶ "Show current limit": current speed limits are displayed without being applied in the instrument cluster.
 - ▶ "Off": depending on the national-market version, Speed Limit Info and Speed Limit Assistant will be turned off.

Displays in the instrument cluster

A message is displayed in the instrument cluster when the system and a driver assistance system are activated.





Overview

Buttons on the steering wheel

Button	Function
	Accept suggested speed manually.
	Rocker switch: Set speed, refer to Cruise Control.

Turning Speed Limit Assistant on/off

1.  Apps menu
2. "Vehicle"
3. "Driving settings"
4. "Driver Assistance"

Icon	Function
	Depending on the equipment version, the indicator light illuminates green, together with the icon for a speed control system: Speed Limit Assistant is active and detected speed limits can be applied manually for the displayed system.
	Detected change of a speed limit with immediate effect.
	Depending on the national-market version, it is possible to switch between the units of measurement.
	Indicator light illuminates green: the detected speed limit can be applied with the SET button. After it has been applied, a green checkmark is displayed.

Manual adoption

A detected speed limit can be applied manually for the active driver assistance system.

SET When the SET icon illuminates, press the button.

Speed adjustment

Principle

It can be adjusted whether the speed limit is applied exactly or with a tolerance.

General information

You can configure a speed adaptation for all speed limits and an additional speed adaptation for speed limits up to 40 mph/60 km/h.

The additional speed adaptation for speed limits up to 40 mph/60 km/h can be activated or deactivated.

Setting the speed adjustment

1.  Apps menu
2. "Vehicle"
3. "Driving settings"
4. "Driver Assistance"
5. "Driving"
6. "Speed Limit Assistance"
7. Select the desired setting:
 - ▷ "Adjust speed limits": set tolerance for the speed adaptation that affects all speeds.
 - ▷ "2nd adjustment up to": activate or deactivate additional speed adaptation.
 - ▷ "Adjust speed limits": With additional speed adjustment activated, set the tolerance for speed limits up to 40 mph/60 km/h.

Adapting to route

Principle

Depending on the national-market version, the system can be configured so that the vehicle adapts the speed automatically to the route.

For instance, the speed will be reduced in the following situations, if necessary:

- ▷ Before making turns.
- ▷ Before a roundabout.
- ▷ Before a curve.

Adapting speed automatically to route

1.  Apps menu
2. "Vehicle"
3. "Driving settings"
4. "Driver Assistance"
5. "Driving"
6. "Speed Limit Assistance"
7. "Adjust to route" or "Automatically adjust speed to route"

System limits

Speed Limit Assistant is based on the Speed Limit Info system.

Consider the system limits of Speed Limit Info.

Upcoming speed limits can only be applied to Active Cruise Control with Distance Control.

The system does not react or reacts to a limited extent to the route ahead in the following situations:

- ▷ If the vehicle location cannot be clearly determined by the navigation system.
- ▷ With wintry road conditions.

Additional information:

- ▷ System limits of Speed Limit Information, refer to page [205](#).
- ▷ System limits of the sensors, refer to page [41](#).

Steering Assistant

Principle

The Steering Assistant helps keep the vehicle in the lane. For this purpose, the system executes supporting steering movements, for instance when cornering.

General information

Depending on the speed, the system orients itself according to the lane boundaries or vehicles in front.

Sensors on the steering wheel detect whether the steering wheel is being touched.

Safety information

Warning

The system cannot serve as a substitute for the driver's personal judgment in assessing the traffic situation. Based on the limits of the system, it cannot independently react to all traffic situations. There is a risk of accident, injury, and property damage. Adjust driving style to traffic conditions. Watch the surrounding traffic situation closely, be ready to take over steering and braking at any time, and actively intervene where appropriate.

Overview

Buttons on the steering wheel

Button	Function
	Steering Assistant with Traffic Jam Assistant on/off.
	Switch function on.



Sensors

The system is controlled by the following sensors:

- ▷ Cameras behind the windshield.
- ▷ Front radar sensor.
- ▷ Radar sensors, side, front.
- ▷ Radar sensors, side, rear.

Additional information:

Sensors of the vehicle, refer to page 41.

Functional requirements

- ▷ Speed below 130 mph/210 km/h.
- ▷ Sufficient lane width.
- ▷ Above approx. 43 mph/70 km/h: lane boundary on both sides is detected.
- ▷ Below approx. 43 mph, 70 km/h: lane boundary on both sides or vehicle driving ahead is detected.
- ▷ Hands on the steering wheel rim.
- ▷ Wide curves.
- ▷ Drive in the center of the lane.
- ▷ Turn signal switched off.
- ▷ The sensor system calibration process is complete.
- ▷ Cruise Control with Distance Control active.
- ▷ Seat belt on the driver's side fastened.
- ▷ Forward Collision Warning with braking function on.
- ▷ Daytime Pedestrian Collision Mitigation on.
- ▷ Side Collision Warning active.

Turning Steering Assistant on/off

Assisted Driving Mode

General information



This button is used to switch the configured function on and off.





The button can be used to set the primarily used function.

Setting the function



When the system is active, press the button repeatedly until the desired function is selected in the toolbar. The toolbar for Assisted Driving mode is displayed at the bottom of the instrument cluster.

Icon	Function
	Cruise Control with Distance Control.
	Cruise Control with Distance Control and Steering Assistant.

The selected function is shown in green.

Turning on the system



Press the button on the steering wheel.

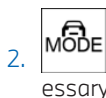

Adjust the Steering Assistant if necessary.



Indicator light illuminates gray.

The system is on standby and does not manipulate steering movements.

System activates automatically as soon as all function conditions are fulfilled.



The indicator light illuminates green.

The system is active.

With the system switched on, the Daytime Pedestrian Collision Mitigation system and the Side Collision Warning are activated.

Turning off the system



Press the button on the steering wheel.

The indicator goes out.

The system does not perform supportive steering wheel movements.

Stopping Steering Assistant automatically

The system interrupts the supporting steering movements automatically, for example in the following situations:

- ▶ At a speed above 130 mph/210 km/h.
- ▶ When the steering wheel is released.
- ▶ When performing a manual braking process.
- ▶ With strong steering intervention.
- ▶ When leaving own lane.
- ▶ When the turn signal is switched on.
- ▶ When the lane is too narrow.
- ▶ If a lane boundary is not detected for a certain period of time and no vehicle is driving ahead.
- ▶ Active Cruise Control with Distance Control is stopped.
- ▶ The seat belt on the driver's side is unfastened.









Indicator light illuminates gray.

The system is on standby and does not manipulate steering movements.

System activates automatically as soon as all function conditions are fulfilled.

Displays in the instrument cluster

Icon	Description
	Indicator light illuminates gray: The system is ready.
	Indicator light illuminates green: The system is activated. The system supports the driver in keeping the vehicle within the lane.
	Warning light flashes yellow: A lane boundary has been crossed. The steering wheel vibrates where applicable.
	Warning light illuminates yellow and acoustic signal may sound: System interruption is imminent.
	Depending on national-market version: The warning light flashes or illuminates red. A signal sounds: The system is switched off.
	Warning light illuminates yellow: Hands are not grasping the steering wheel. The system is still active.
	Warning light illuminates red, acoustic signal sounds: Hands are not grasping the steering wheel. System interruption is imminent. The system reduces the speed to a standstill if applicable. It is possible that the system will not execute any supporting steering movements.

Depending on vehicle equipment and national-market version, information for the system is displayed in the Assisted View of the instrument cluster.

Additional information:

Assisted View, refer to page 153.

Displays on the steering wheel



The two LED lights above the buttons illuminate analogously to the displays in the instrument cluster:

- ▶ Yellow: system interruption is imminent.
- ▶ Red: system will be deactivated.

The steering wheel displays can be switched on/off if required.

1.  Apps menu
2. "Vehicle"
3. "Driving settings"
4. "Driver Assistance"
5. "Feedback via steering wheel"
6. "Light elements"

Displays in the Head-up display

All system information can also be displayed in the Head-up display.

System limits

General information

The system cannot be activated or meaningfully used in certain situations, e.g., while towing a trailer.

Safety information

Warning

Because of system limitations, this system may either not respond, or respond too late, incorrectly, or without cause. There is a risk of accident, injury, and property damage. Actively intervene as warranted. Refer to the information in this Owner's Manual regarding the scope of the system's operation and limitations.

System limits of the sensors

Additional information:

- ▶ Cameras, refer to page 41.
- ▶ Radar sensors, refer to page 42.

Hands on the steering wheel

The sensors cannot detect hand-steering wheel contact in the following situations:

- ▶ Driving with gloves.
- ▶ Protective covers on the steering wheel.

Narrow lanes

When driving within narrow lanes, the system cannot be activated or effectively used, for instance in the following situations:

- ▶ In construction areas.
- ▶ Depending on the equipment, with automatic formation of emergency lanes.
- ▶ Within city limits.

Weather

The following restrictions can occur under unfavorable weather or light conditions:

- ▶ Poorer recognition of vehicles and lane boundaries.
- ▶ Short-term interruptions for vehicles that are already recognized.

Drive attentively, and react to the current surrounding traffic situation. If necessary, intervene actively, for instance by braking, steering or making an evasive maneuver.

Assisted Driving Mode Plus

Principle

Assisted Driving Mode Plus helps drivers guide their vehicle through traffic jams.

Supporting steering movements take place without the driver actively steering.

General information

The system uses the sensors of the Steering Assistant.

Safety information

Warning

The system cannot serve as a substitute for the driver's personal judgment in assessing the traffic situation. Based on the limits of the system, it cannot independently react to all traffic situations. There is a risk of accident, injury, and property damage. Adjust driving style to traffic conditions. Watch the surrounding traffic situation closely, be ready to take over steering and braking at any time, and actively intervene where appropriate.

Federal, state, or local laws may differ, and the use of this function may be prohibited or limited. Before use, check federal, state, and local laws.

Additionally, the notices for the Steering Assistant apply.

Additional information:

Steering Assistant, refer to page 220.

Functional requirements

- ▷ The functional requirements of the Steering Assistant are fulfilled.
Functional requirements, refer to page 220.
- ▷ The Steering Assistant is active.
- ▷ The function is only available on certain street types, e.g. freeways.
- ▷ Driving on a road without pedestrians or cyclists.
- ▷ Sufficient lane width.
- ▷ Lane markings and a vehicle driving ahead are detected.
- ▷ Speed below approx. 40 mph/60 km/h.
- ▷ The Driver Attention Camera in the instrument cluster detects that the driver is paying attention to the surrounding traffic.
- ▷ The function must be available in the country in which the vehicle is driven.

Switching on Assisted Driving Mode Plus



As soon as all functional requirements are met, an additional icon for Assisted Driving Mode Plus will be displayed on the toolbar. The toolbar is displayed at the bottom of the instrument cluster.



Select Assisted Driving Mode Plus with the button on the steering wheel.

The icon for Assisted Driving Mode Plus is shown in green.

Two green LED lights are illuminated on the steering wheel.

The indicator light in the instrument cluster is shown in green.

The system begins to assist the driver with vehicle control.

Depending on vehicle equipment, this function can be enabled/disabled on the control display.

1. ■■ Apps menu
2. "Vehicle"
3. "Driving settings"
4. "Driver Assistance"
5. "Driving"
6. "Assisted Driving"
7. "Assisted Driving Plus"

Displays in the instrument cluster

Icon	Description
	Indicator light green: system is active.
	Indicator light white: system is ready.
	Gray indicator light: the system has been interrupted.

Displays on the steering wheel



The two LED lights above the buttons illuminate analogously to the displays in the instrument cluster:

- ▷ Green: the system is active.
- ▷ Yellow: system will be interrupted.
- ▷ Red: system will be deactivated.

System limits

General information

The limits of the Steering Assistant system apply.

Additional information:

Steering Assistant, refer to page [220](#).

Driver Attention Camera

The limits of the Driver Attention Camera system apply.

Additional information:

Driver Attention Camera, refer to page [197](#).

Lane Change Assistant

Principle

The Lane Change Assistant also assists when changing lanes on multi-lane roads.

General information

The system uses the sensors of the Steering Assistant.

Safety information

Warning

The system cannot serve as a substitute for the driver's personal judgment in assessing the traffic situation. Based on the limits of the system, it cannot independently react to all traffic situations. There is a risk of accident, injury, and property damage. Adjust driving style to traffic conditions. Watch the surrounding traffic situation closely, be ready to take over steering and braking at any time, and actively intervene where appropriate.

Additionally, the notices for the Steering Assistant apply.

Additional information:

Steering Assistant, refer to page [220](#).

Functional requirements

- ▶ The functional requirements of the Steering Assistant are fulfilled.
Functional requirements, refer to page [220](#).
- ▶ Driving on a road without pedestrians or cyclists and with physical barriers to oncoming traffic such as crash barriers.
- ▶ Crossable lane boundaries are detected.
- ▶ Maximum speed approx. 110 mph/180 km/h.
- ▶ The minimum speed is country-specific.
- ▶ The function must be available in the country in which the vehicle is driven.

Turning on/turning off Lane Change Assistant

1.  Apps menu
2. "Vehicle"
3. "Driving settings"
4. "Driver Assistance"
5. "Driving"
6. "Assisted Driving"
7. "Lane Change Assistant"

Changing lanes

1. Ensure that the traffic situation permits changing lanes.
2. Press the turn signal lever in the desired direction to the resistance point.

A supporting steering movement in the required direction can be detected a short time later.

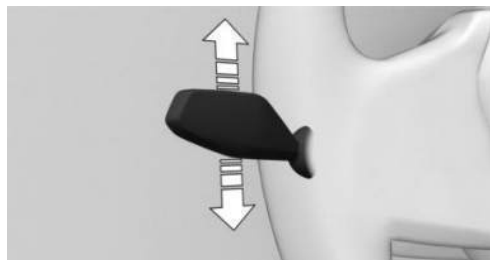



After the lane change, the system helps keep the vehicle in the new lane.

Canceling a lane change

The lane change can be canceled by steering movement into the opposite direction.

Displays in the instrument cluster

Icon	Description
	Green steering wheel icon. Green arrow icon for lane-changing. The system carries out a lane change.
	Green steering wheel icon. Gray line for lane marking on the appropriate side. The system detected the lane change request. Lane change not currently possible.
	Depending on the national-market version: Green steering wheel icon. Gray arrow icon for lane-changing. Lane change not possible; functional requirements not met.

Depending on vehicle equipment and national-market version, information for the system is

displayed in the Assisted View of the instrument cluster.

Additional information:

Assisted View, refer to page [153](#).

System limits

The limits of the Steering Assistant system apply.

Additional information:

Steering Assistant, refer to page [220](#).

Parking

Vehicle features and options

This chapter describes model-specific equipment, systems, and functions that are currently available, or may become available in the future, even if they are not present in the vehicle.

Additional information:

Vehicle equipment, refer to page 8.

Parking assistance systems

General information

The parking assistance systems include different individual systems. The individual systems help the driver when parking, maneuvering, or reversing by providing various assistance functions, sensors, and camera views.

Additional information:

- ▶ Rearview camera, refer to page 232.
- ▶ Automatic camera perspective, refer to page 232.
- ▶ Side view, refer to page 233.
- ▶ 3D view, refer to page 234.
- ▶ Car wash view, refer to page 234.
- ▶ Panorama View, refer to page 234.
- ▶ Door opening angle, refer to page 236.
- ▶ Remote 3D View, refer to page 236.
- ▶ Park Distance Control, refer to page 237.
- ▶ Active Park Distance Control, refer to page 240.
- ▶ Automatic Parking Assistant, refer to page 241.
- ▶ Back-up Assistant, refer to page 245.

Safety information

Warning

The system cannot serve as a substitute for the driver's personal judgment in assessing the traffic situation. Based on the limits of the system, it cannot independently react to all traffic situations. There is a risk of accident, injury, and property damage. Adjust driving style to traffic conditions. Watch the surrounding traffic situation closely, be ready to take over steering and braking at any time, and actively intervene where appropriate.

Overview

Button in the vehicle

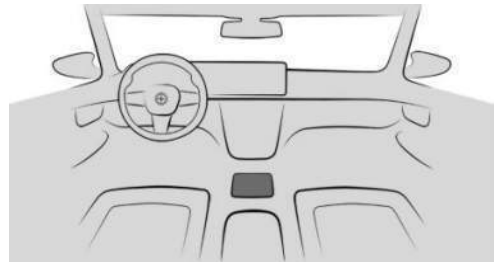

Park assistance button



Panorama View

Sensors

The parking assistance systems are controlled by the following sensors:

- ▶ Ultrasonic sensors in the front/rear bumpers.
- ▶ Ultrasonic sensors, side.

- ▷ Front camera.
- ▷ Top view cameras.
- ▷ Rearview camera.

Additional information:

Sensors of the vehicle, refer to page 41.

Operating concept

The camera-based individual systems are operated with the function bars on the control display. The camera views can be viewed by selecting the appropriate icon.

In the Parking menu, some parking assistance systems can be configured individually.

Some parking assistance systems can be started by voice control as needed, e.g., driving in/out of a parking space with the Automatic Parking Assistant.

Additional information:

BMW Intelligent Personal Assistant, refer to page 59.

Calling up Park menu

Via Parking Assistant button



1. Press the button.
2.  "Settings"
3. Select the desired settings.

Via iDrive

1.  Apps menu
2. "Vehicle"
3. "Driving settings"
4. "Driver Assistance"
5. "Parking and maneuvering"
6. Select the desired settings.

Display

Principle

With the Park Distance Control display and various camera views, the parking assistance systems help you park, maneuver, and reverse your vehicle.

General information

Depending on the equipment, one or more cameras capture the area from different selectable perspectives.

Depending on the view, the vehicle's surroundings or a part of it is depicted.

Depending on national-market version, the automatic camera perspective or the rearview camera is displayed.

Turning display on/off

General information

The parking assistance systems view switches off automatically when driving forwards or if a certain distance or speed is exceeded.

With reverse gear

When drive-ready state is switched on, the display is automatically switched on if selector lever position R is engaged.

With the Park Assist key



Press the button.

Display on the control display

General information

Depending on vehicle equipment and on the activated parking assistance system, the control display will vary.

Without Parking Assistant Plus

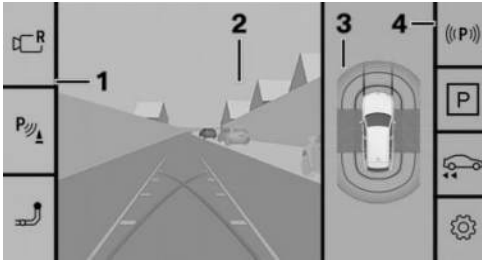

- 1 Toolbar, left
- 2 Camera image
- 3 Vehicle top view
- 4 Toolbar, right

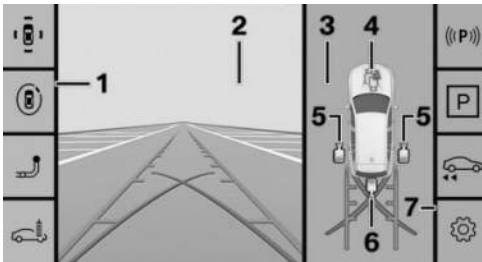

With Parking Assistant Plus





- 1 Toolbar, left
- 2 Camera image
- 3 Selection window
- 4 Automatic camera perspective
- 5 Side view
- 6 Rearview camera
- 7 Toolbar, right

Toolbar, left

Different views can be selected using the left toolbar depending on vehicle equipment:



- ▷  "Rear view camera"
The view of the rearview camera is displayed.
- ▷  "Parking sensors only"

The Park Distance Control view is displayed.

- ▷  "Parking"
The view of different camera perspectives is displayed.
- ▷  "3D view"
A three-dimensional view of the vehicle is displayed.
- ▷  "Car wash"
Your own lane can be displayed to make it easier to drive into a car wash.



Toolbar, right

The parking assistance functions are displayed in the right toolbar. The display may vary depending on vehicle equipment.

- ▷ Status of the parking assistance systems.
- ▷  "Automatic Parking"
Functions of the Automatic Parking Assistant.
- ▷  "Back-Up Assistant"
Functions of the Back-up Assistant.
- ▷  "Settings"
Settings in the Park menu.

Status of parking assistance systems

The status of active parking assistance systems is indicated by icons in the right-hand toolbar.

Icon	Meaning
	No search for Automatic Parking Assistant offers. Automatic Parking Assistant has failed.
	Search for Automatic Parking Assistant offers is active.
	Automatic Parking Assistant: if the icon is green, the Automatic Parking Assistant is active. The system assumes vehicle control. Back-up Assistant: if the icon is green, the Back-up Assistant is active. The system takes over the steering.

Additional displays

General information

Additional displays can be shown in the camera image of the display of the parking assistance systems, e.g., parking aid lines, to make parking and maneuvering easier.

Several additional displays can be active at the same time.

Turning additional displays on/off

Via Parking Assistant button

1. Enable the camera image.
2.  "Settings"
3. Select the desired settings.

Via iDrive

1.  Apps menu
2. "Vehicle"
3. "Driving settings"
4. "Driver Assistance"
5. "Parking and maneuvering"
6. Select the desired setting.

Parking aid lines

Pathway lines



Pathway lines help you to estimate the space required when parking and maneuvering on level roads.

Lane lines are displayed in front of or behind the vehicle depending on the gear engaged.

The pathway lines are continuously adjusted to the steering movements depending on the steering-wheel angle.

Turning circle lines



Turning circle lines can only be superimposed on the camera image together with pathway lines.

The lines show the course of the smallest possible turning circle on a level road.

Only one turning circle line is displayed after the steering wheel is turned past a certain angle.

Using parking aid lines

1. Position the vehicle so that the red turning circle line leads to within the limits of the parking space.
2. Turn the steering wheel to the point where the green pathway line covers the corresponding turning circle line.

Obstacle marking

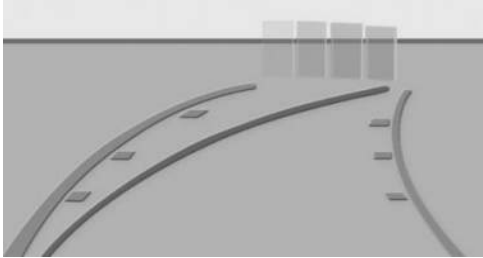

Obstacles are detected by the sensors.

The obstacles detected by the Park Distance Control are shown by marks in the camera image.

Colored gradients for the obstacle markings in green, yellow and red indicate the distances.

Functional limitations

The system can be used only to a limited extent in the following situations:

- ▶ With a door open.
- ▶ With open cargo area.
- ▶ With exterior mirrors folded in.

Areas with gray hatching with an icon in the camera image identify areas that are currently not shown such as an open door.

System limits

Safety information

Warning

Because of system limitations, this system may either not respond, or respond too late, incorrectly, or without cause. There is a risk of accident, injury, and property damage. Actively intervene as warranted. Refer to the information in this Owner's Manual regarding the scope of the system's operation and limitations.

System limits of the sensors

Additional information:

Sensors of the vehicle, refer to page 41.

Field of view

Because of the camera angle, the areas under the vehicle cannot be viewed by the cameras.

Detection of objects

Very low obstacles as well as high, protruding objects such as ledges may not be detected by the system.

Objects shown on the control display may be closer than they appear. Do not estimate the distance to the objects on the control display.

The camera's detection range can be limited by protruding cargo or a rear carrier.

Malfunction

A camera failure is displayed on the control display.

The malfunctioning camera's detection range is shown by the shaded area on the control display.

Rearview camera

Principle

The rearview camera helps when reverse parking and maneuvering. The area behind the vehicle is shown on the control display.

Additional views can be shown on the display, e.g., parking aid lines and obstacle markings.

General information

Follow the information in the "Parking assistance systems" chapter.

Functional requirements

- ▷ The cargo area is fully closed.
- ▷ The camera area is clean and clear.

Turning the rearview camera on/off

Turning the camera view on automatically

When drive-ready state is switched on, the rearview camera is automatically switched on if selector lever position R is engaged.

Turning the camera view off automatically

The rearview camera turns off automatically when driving forward or when a certain distance or speed is exceeded.



Turning the camera view on/off manually

Without Parking Assistant Plus

1.  Press the button.
2.  "Rear view camera"

To exit the rearview camera view, select another camera view on the left toolbar.

With Parking Assistant Plus

1.  Press the button.
2.  Select the icon in the selection window.
To exit the rearview camera view, select another camera view in the selection window.

Deactivated rearview camera

When the rearview camera is deactivated, for instance when the cargo area is open, the camera image is displayed with gray shading.

Automatic camera perspective

Principle

The automatic camera perspective shows a steering-dependent view in the respective driving direction.

This perspective adapts to the respective driving situation.

General information

As soon as obstacles are detected, the view changes to a fixed display of the area in front of or behind the bumper, or switches to side Park Distance Control as necessary.

When the reverse gear is engaged, the automatic camera perspective is exited if necessary and the rearview camera view is displayed.

If necessary, select the automatic camera perspective when reverse gear is engaged. The automatic camera perspective will then be maintained for the current parking operation. Follow the information in the "Parking assistance systems" chapter.

Turning the automatic camera perspective on/off

Turning the camera view on/off automatically

When the parking assistance systems' display is turned on, automatic camera perspective is selected automatically.

 The icon in the selection window is selected automatically.

To exit the steering-dependent camera view, select another camera view in the selection window.

Turning the camera view on/off manually



1. Press the button.
2.  Select the icon in the selection window. To exit the steering-dependent camera view, select another camera view in the selection window.

Side protection

Principle

The side Park Distance Control is automatically displayed when the automatic camera perspective is turned on. The function shows obstacles located next to the vehicle.

Display



To protect the sides of the vehicle, obstacle markings are displayed on the sides of the vehicle.

- ▷ No markings: no obstacles detected.
- ▷ Color marks: warning against detected obstacles.

System limits

The system only displays stationary obstacles that were previously detected by sensors while passing them.

The system does not detect whether an obstacle moves later on. For this reason, at standstill, the marks are not shown anymore in the display after a certain time. The area next to the vehicle must be newly captured.

Side view

Principle

Side view shows the vehicle's side surroundings, making it easier to position the vehicle at the curb or with other obstacles on the side.



The side view looks from rear to front and, in case of danger, focuses automatically on possible obstacles.

General information

Follow the information in the "Parking assistance systems" chapter.

Turning the side view on/off

The selection window lets you choose the side view for the left or right side of the vehicle.

1.  Press the button.
2.  Select the icon for the desired vehicle side in the selection window.
To exit the side view, select another camera view in the selection window.

3D view

Principle

With 3D view, a circle is displayed around the vehicle top view in the selection window.



Specified perspectives can be selected on the circle.

General information

The current perspective is marked with a camera icon.

Follow the information in the "Parking assistance systems" chapter.

Turning the 3D view on/off

1.  Press the button.
2.  "3D view"
To exit the 3D view, select another camera view on the left toolbar.

Car wash view



Principle

The car wash view helps when driving into a car wash.

General information

Follow the information in the "Parking assistance systems" chapter.

Turning the car wash view on/off

1.  Press the button.
2.  "Car wash"
To exit the car wash view, select a different camera view in the left toolbar.

Display

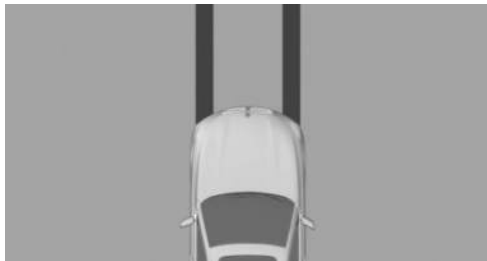

Your own lane is displayed for easier driving into a car wash.

This view can be used to position the vehicle correctly within the washing system guide rails.

In a car wash, the vehicle must be able to roll freely forward.

Additional information:

Rolling or pushing the vehicle, refer to page [126](#).

Panorama View

Principle

The panoramic view gives you an earlier view of crossing traffic at blind driveway exits and intersections.

General information

Road users concealed by obstacles to the left and right of the vehicle can only be detected relatively late from the driver's seat. The front camera and rearview camera capture the area around the side of the vehicle to improve the driver's view.

This function can be turned on automatically by saving activation points.

The camera image shows different levels of distortion in some areas and is thus not suitable for distance estimations.

Depending on vehicle equipment, the function can be used when driving forward or in reverse.

Follow the information in the "Parking assistance systems" chapter.

Sensors

The system is controlled by the following cameras:

- ▷ Rearview camera.
- ▷ Front camera.

Turning the panoramic view on/off



Press the button.

Display



Yellow lines on the screen display identify the bumpers of your own vehicle.

Depending on the engaged selector lever position, the camera view of the rearview camera or front camera will be displayed.

Automatic activation of panorama view

Principle

Positions at which panorama view should switch on automatically can be saved as activation points.

General information

Up to ten activation points can be stored.

The activation points can be used when driving forward and, depending on national-market version, when reversing.

Follow instructions in the Parking assistance systems chapter.

Functional requirements

- ▷ A GPS signal must be received.
- ▷ Depending on national-market version: A BMW ID or driver profile must be activated.
- ▷ The reversing camera and front camera must be installed.
- ▷ The direction of travel, selector lever position, and vehicle angle must correspond to a stored activation point.

Storing activation points

1. Drive your vehicle to the location where you want the system to turn on, then stop.



2.  Press the button.

3. "Activation point"
The current position is displayed.

4. "Save activation point"

Activation points are stored with one of the following pieces of information if possible:

- ▷ With the city/town.
- ▷ With the city/town and the street.
- ▷ With the GPS coordinates.

Using activation points

The use of activation points can be switched on and off.



1. Press the button.
2. "Settings"
3. "GPS-based"

Displaying activation points



1. Press the button.
2. "Manage points"
A list of all activation points is displayed.

Editing activation points



1. Press the button.
2. "Manage points"
A list of all activation points is displayed.
3. Select an activation point as needed.
4. Select the desired setting.

Door opening angle

Principle

Depending on vehicle equipment, the door opening angle display is shown automatically when stationary.

This display helps estimate how far the doors can be opened when parking.

If obstacle marking is activated, the parking view indicates fixed obstacles that obstruct the opening angles of the doors.

General information

Follow the information in the "Parking assistance systems" chapter.

Display



The maximum opening angle of the doors is displayed in selector lever position P.

System limits

The system does not provide a warning of approaching road users.

The vehicle's surroundings are distorted in the display for technical reasons.

Even if the door opening angle indicator on the control display does not overlap with any other objects, it is necessary to park carefully next to other objects.

Because of the perspective, higher, protruding objects may be closer than they appear on the control display.

Remote 3D View

Principle

The My BMW App and camera views in parking view such as automatic camera perspective enable you to display the vehicle's surroundings on a mobile device.

The function displays a snapshot of the situation.

General information

For reasons of data protection, the function can only be used three times within two hours. Follow the information in the "Parking assistance systems" chapter.

Sensors

The system is controlled by the following cameras:

- ▶ Front camera.
- ▶ Top view cameras.
- ▶ Rearview camera.

Functional requirements

- ▶ Data transfer must be activated. Data protection, refer to page 70.
- ▶ The My BMW App must be installed on the mobile end device.
- ▶ ConnectedDrive countries: a BMW ID with an existing ConnectedDrive account must be activated. BMW ID/driver profiles, refer to page 71.

Activating/deactivating Remote 3D View

The function can be activated or deactivated individually or together with other functions.

1.  Apps menu
2. "Vehicle"
3. "System settings"
4. "Data privacy"
5. Select the desired setting.

After activation, Remote 3D View can be accessed using the My BMW App.

System limits

The system may not be fully operational or may not be available in the following situations:

- ▶ With a door or the cargo area open. Dark fields in the display indicate areas that are not recorded by the system.
- ▶ With manually folded-in exterior mirrors.
- ▶ When other camera functions are being performed in the vehicle.
- ▶ The vehicle moves faster than walking speed.
- ▶ In case of missing or weak Internet connection.

Park Distance Control

Principle

Park Distance Control assists with parking. Acoustic and visual warnings signal obstacles in front of or behind the vehicle.

Obstacles that are detected by the side ultrasonic sensors can also be reported.

General information

The range of the system, depending on obstacles and environmental conditions, is approx. 6 ft/2 m.

An acoustic warning sounds in case of an impending collision at a distance to the object of approx. 27 in/70 cm.

For objects behind the vehicle, the acoustic warning is issued as early as a distance to the object of approx. 5 ft/1.50 m.

Follow the information in the "Parking assistance systems" chapter.

Safety information

Warning

The system cannot serve as a substitute for the driver's personal judgment in assessing the traffic situation. Based on the limits of the system, it cannot independently react to all traffic situations. There is a risk of acci-

dent, injury, and property damage. Adjust driving style to traffic conditions. Watch the surrounding traffic situation closely, be ready to take over steering and braking at any time, and actively intervene where appropriate.

 **Warning**

Due to high speeds when the Park Distance Control is activated, the warning can be delayed due to physical circumstances. There is a risk of injury and risk of property damage. Avoid approaching an object too fast. Avoid driving off quickly while Park Distance Control is not yet active.

Sensors

The system is controlled by the following sensors:

- ▶ Ultrasonic sensors in the front/rear bumpers.
- ▶ Ultrasonic sensors, side.

Turning Park Distance Control on/off

Turning on the system automatically

The system switches on automatically in the following situations:

- ▶ When drive-ready state is switched on when selector lever position R is engaged.
- ▶ While approaching detected obstacles if the speed is lower than approx. 2.5 mph/4 km/h. The activation distance depends on the situation in question.

The automatic activation of detected obstacles can be activated or deactivated.

1.  Apps menu
2. "Vehicle"
3. "Driving settings"
4. "Driver Assistance"

5. "Parking and maneuvering"
6. "Automatic PDC activation"

Turning off the system automatically

When driving forward, the system turns off automatically as needed when a certain distance or speed is exceeded.

Turning the system on/off manually



Press the button.

- ▶ On: the LED illuminates.
- ▶ Off: the LED goes out.

If the system is manually switched on when the reverse gear is engaged, the rearview camera image is displayed.

Depending on the national-market version, the system cannot be turned off manually when the reverse gear is engaged.

Acoustic warning

General information

An intermittent tone indicates when the vehicle is approaching an object. E.g., when an object is detected at the rear left of the vehicle, a sound is heard from the rear left speaker.

The shorter the distance to the object, the shorter the intervals of the intermittent tones.

When the distance to a detected object is less than approx. 8 in/20 cm, a continuous tone is sounded.

When there are objects in front of and behind the vehicle at the same time, at a distance smaller than approx. 8 in/20 cm, an alternating continuous tone will sound between the front and rear speakers.

The intermittent tones and the continuous tone are turned off when selector lever position P is engaged.

Depending on national-market version, the intermittent tones are switched off after a short time when the vehicle is stationary.

If an object approaches when the vehicle is stationary, the acoustic signal is reactivated.

Adjusting the volume

The volume of the acoustic warning can be adjusted.

1.  Apps menu
2. "Vehicle"
3. "Driving settings"
4. "Driver Assistance"
5. "Parking and maneuvering"
6. "PDC signal volume"
7. Set the desired value.

Visual warning

General information

The approach to an object is displayed on the control display as soon as the system is activated.

Objects that are farther away are already displayed before a signal sounds.

Depending on the view, pathway lines, turning circle lines and obstacle markings are shown for a better estimation of the space required.

Depending on vehicle equipment, the sensor detection range is shown by the shaded, ring-shaped area. Green, yellow, and red markings indicate when obstacles are detected within the detection range.

If vehicle is equipped with Cross Traffic Warning: A warning is also shown on the display for vehicles approaching from the side at the rear and front.

To protect the sides of the vehicle, obstacle markings are displayed on the sides of the vehicle.

Display

Depending on vehicle equipment, warnings may be displayed in front of, next to, and behind the vehicle.



Example display of warnings behind the vehicle.

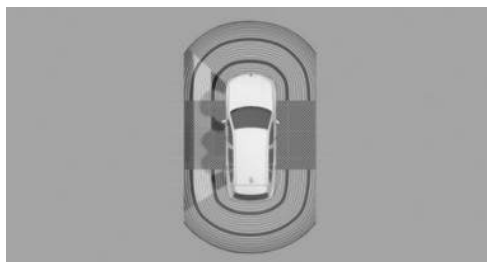

Example display of warnings next to the vehicle.

- ▶ Gray shaded area: Sensor detection range. No obstacles were detected within detection range.
- ▶ Colored marks in shaded area: Obstacles have been detected within the detection range.
- ▶ Shaded area interrupted: the area next to the vehicle has not yet been detected.

System limits

General information

The function for protecting the vehicle sides only shows stationary obstacles that were previously detected by the sensors when passing by.

The system does not detect whether an obstacle moves later on. When the vehicle is stationary, the gray shaded areas on the sides are hidden after a certain time. The area on the side of the vehicle must be newly captured.



Also follow the information on system limits in the "Parking assistance systems" chapter.

Unwarranted warnings

Reaching the system limits can cause unwarranted warnings.

To prevent unwarranted warnings, for instance in car washes, turn off automatic Park Distance Control activation on obstacle detection.

Malfunction



An icon is displayed on the control display.

Depending on vehicle equipment: The sensor detection range may not be shown on the control display.

A Check Control message is displayed.

Park Distance Control malfunction. Have the vehicle checked by an authorized service center or another qualified service center or repair shop.

Active Park Distance Control

Principle

The Park Distance Control brake function initiates emergency braking if there is an acute risk of collision.

General information

Due to system limits, a collision cannot be prevented under all circumstances.

The function is available below walking speed when driving in reverse or rolling backward.

Pressing the accelerator pedal interrupts the brake intervention. Emergency braking is not performed.

After emergency braking to a stop, further creeping toward an obstacle is possible. Proceed with caution. To move forward, lightly

press the accelerator pedal and release as needed.

If the accelerator pedal is depressed longer, the vehicle drives off. Manual braking is possible at any time.

Follow the information in the "Parking assistance systems" chapter.

Safety information

Warning

The system cannot serve as a substitute for the driver's personal judgment in assessing the traffic situation. Based on the limits of the system, it cannot independently react to all traffic situations. There is a risk of accident, injury, and property damage. Adjust driving style to traffic conditions. Watch the surrounding traffic situation closely, be ready to take over steering and braking at any time, and actively intervene where appropriate.

Sensors

The system is controlled by the following sensors:

- ▶ Ultrasonic sensors in the rear bumpers.
- ▶ Ultrasonic sensors, side.

Deactivating Active Park Distance Control temporarily

After emergency braking, the function can be temporarily deactivated on the control display. A corresponding message is displayed.

1. "Configure"
2. "Deactivate temporarily"

During continued driving in this surrounding situation, no further emergency braking will occur.

The function is automatically reactivated when Park Distance Control is switched on again.

Settings

It is possible to set which areas on the vehicle will be protected by the system.

1.  Apps menu
2. "Vehicle"
3. "Driving settings"
4. "Driver Assistance"
5. "Parking and maneuvering"
6. "Active PDC emergency braking"
7. Select the desired setting.

Display



As soon as the system engages, an icon is displayed with a corresponding message.

System limits

General information

Follow the system limits in the "Parking assistance systems" chapter.

Automatic Parking Assistant

Principle

Automatic Parking Assistant provides support when parallel parking and parking transverse to the road.

In addition, the system makes it easier to park out of parallel parking spaces.

The ultrasonic sensors measure both sides of the vehicle when driving slowly forward. Suitable parking spaces are calculated based on the objects detected, e.g., parking vehicles. The system status is displayed.

The system calculates the best possible parking line for driving in or out of parking spaces, and takes control of the vehicle while parking.

The operating principle and operation of the system is divided into the following steps:

- ▷ Parking space search.
- ▷ Turning on.
- ▷ Parking.
- ▷ Driving out of parking spaces.

The parking manoeuvre while parking is performed automatically.

When driving out of parallel parking spaces, the vehicle maneuvers automatically until it reaches a position where it can be driven out of the parking space without further steering movements.

General information

Follow the information in the "Parking assistance systems" chapter.

Safety information

Warning

The system cannot serve as a substitute for the driver's personal judgment in assessing the traffic situation. Based on the limits of the system, it cannot independently react to all traffic situations. There is a risk of accident, injury, and property damage. Adjust driving style to traffic conditions. Watch the surrounding traffic situation closely, be ready to take over steering and braking at any time, and actively intervene where appropriate.

Warning

The system can steer the vehicle over or onto curbs. There is a risk of injury and risk of property damage. Watch surrounding traffic closely and actively intervene where appropriate.

Parking methods

Park Assist supports the following functions:

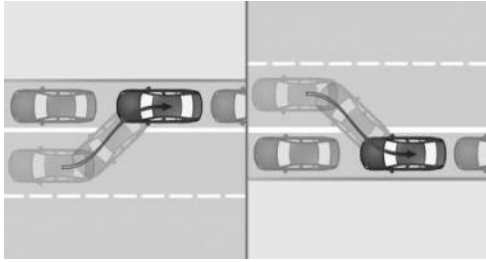

Parallel parking: reverse parking parallel to the road.

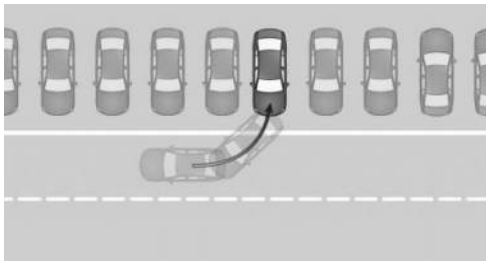

Perpendicular parking: reverse parking perpendicular to the road.

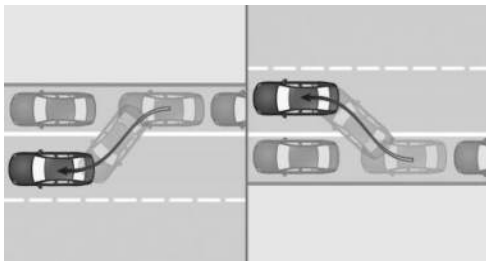

Driving out of parallel parking spaces.

Sensors

The Automatic Parking Assistant is controlled by the following sensors:

- ▶ Ultrasonic sensors in the front/rear bumpers.
- ▶ Ultrasonic sensors, side.

Functional requirements

Measurement of parking spaces

- ▶ Maximum speed while driving forward approx. 22 mph/35 km/h.
- ▶ Maximum distance to row of parked vehicles: 5 ft/1.5 m.

Suitable parking space

Longitudinal parking:

- ▶ Minimum length of a detected object, e.g., a parking vehicle: approx. 3 ft/1 m.
- ▶ Minimum length of gap between two objects: own vehicle length plus approx. 2.6 ft/0.8 m.
- ▶ Minimum depth: approx. 5 ft/1.5 m.

Perpendicular parking:

- ▶ Minimum length of a detected object, e.g., a parking vehicle: approx. 3 ft/1 m.
- ▶ Minimum width of the gap: own vehicle width plus approx. 2.3 ft/0.7 m.
- ▶ Minimum depth: own vehicle length.

The depth of perpendicular parking spaces must be estimated by the driver. Due to technical limitations, the system is only able to approximate the depth of perpendicular parking spaces.

Parking operation

- ▶ Doors and cargo area are closed.
- ▶ Driver's seat belt is fastened.

Leaving parking spaces

- ▶ The vehicle was parked using the Automatic Parking Assistant, and an object has been detected in the area around the vehicle.
- ▶ The vehicle was manually parked in reverse, and objects have been detected in the immediate vicinity of the vehicle. The

distance to a detected curb is at least 6 inches/15 cm.

- ▷ The parking space is at least 2.6 ft/0.8 m longer than the vehicle.

Displays

The current status of the parking space search is displayed in the right toolbar.

If a parallel or perpendicular parking space is clearly detected, the system automatically adjusts to the suitable parking method. If there are parking spaces for parallel or perpendicular parking, both parking spaces are shown on the control display. The parking direction can be selected by selecting the parking space.

Turning the signal tone on/off

The signal tone for suitable parking spaces can be turned on and off.

1.  Apps menu
2. "Vehicle"
3. "Driving settings"
4. "Driver Assistance"
5. "Parking and maneuvering"
6. "Sound when available"

Parking using the Automatic Parking Assistant

1. For the parking space search when driving past parked vehicles at a speed of up to approx. 22 mph/35 km/h and a distance of max. 5 ft/1.5 m.
() The parking space search is activated.



2. Press the  button or engage reverse gear.

The parking assistance systems view is displayed.

The status of the parking space search and possible parking spaces are displayed on the control display.

3. Select suggested parking method.
 Green: the system takes control of the parking operation.
4. Follow the instructions on the control display.
The speed can be reduced with the brake. Other interventions will cancel the system. Depending on national-market version, an intermittent or continuous tone sounds for Park Distance Control.
At the end of the parking operation, selector lever position P is set.
The end of the parking operation is indicated on the control display.
5. Adjust the parking position yourself, if needed.

Driving out of a parking space using the Automatic Parking Assistant

1. Turn on drive-ready state.
2.  With the vehicle at a standstill, press button or engage reverse gear.
The parking assistance systems view is displayed.
3. Select the desired direction for driving out of the parking space on the control display.
4. Follow the instructions on the control display.
 Green: the system takes control of maneuvering.
The speed can be reduced with the brake. Other interventions will cancel the system. A message will be displayed at the end of the maneuver.
5. Make sure that the traffic situation permits driving out of parking space and driving off as usual.
The Automatic Parking Assistant is turned off automatically.

Canceling Automatic Parking Assistant manually

The Automatic Parking Assistant can be canceled manually at any time, e.g.:

- ▷  Press the button.

- ▷  "Automatic Parking": select the icon on the control display.

Canceling Automatic Parking Assistant automatically

The system automatically cancels in situations such as the following:

- ▷ When the driver grasps the steering wheel or takes over steering.
- ▷ Possibly on snow-covered or slippery road.
- ▷ When there are obstacles that are hard to overcome such as curbs.
- ▷ When there are obstacles that suddenly appear.
- ▷ With insufficient distances, which are indicated by Park Distance Control.
- ▷ When a maximum number of parking attempts or the time taken for parking is exceeded.
- ▷ When changing over to another function on the control display.
- ▷ The turn signal opposite to the desired parking side is switched on.
- ▷ With open cargo area.
- ▷ With the doors open.
- ▷ When setting the parking brake.
- ▷ When operating the accelerator pedal or the selector lever.
- ▷ The brake pedal remains depressed for longer while the vehicle is at a standstill.
- ▷ When unfastening the driver's seat belt.

A Check Control message is displayed where applicable.

Continuing the parking operation

If parking or leaving a parking space has been interrupted, the operation can be continued, if needed.

Restart the Automatic Parking Assistant and follow the instructions on the control display.

System limits

General information

Follow the system limits in the "Parking assistance systems" chapter.

No parking assistance

The Automatic Parking Assistant does not offer assistance in the following situations:

- ▷ In tight curves.
- ▷ For diagonal parking spaces.
- ▷ For parking spaces that are only marked with lines on the ground. The system orients itself according to objects.
- ▷ For special parking spaces, e.g., metered parking spaces with automatic locking mechanisms, or mechanical parking systems.

Functional limitations

The system may be limited in the following situations:

- ▷ On bumpy road surfaces such as gravel roads.
- ▷ On slippery ground.
- ▷ On steep uphill or downhill grades.
- ▷ With accumulations of leaves/snow in the parking space.
- ▷ In case of changes to an already-measured parking space.

- ▷ With ditches or edges, for instance an edge of a port.
- ▷ Parking spaces that are not suitable may be detected or suitable parking spaces may not be detected at all.

Malfunction

A Check Control message is displayed.

The Automatic Parking Assistant may not be operational. Have the vehicle checked by an authorized service center or another qualified service center or repair shop.

Back-up assistant

Principle

The Back-up Assistant helps when reversing, e.g., when pulling out of tight or unclear parking or road situations.

General information

The vehicle stores the driving movements of the last distance covered. This stored distance can be driven in reverse with automated steering.

The system takes over the steering. The driver must control the speed using the accelerator and brake pedals.

A maximum of 164 ft/50 m are stored.

Follow the information in the "Parking assistance systems" chapter.

Safety information

Warning

The system cannot serve as a substitute for the driver's personal judgment in assessing the traffic situation. Based on the limits of the system, it cannot independently react to all traffic situations. There is a risk of accident, injury, and property damage. Adjust

driving style to traffic conditions. Watch the surrounding traffic situation closely, be ready to take over steering and braking at any time, and actively intervene where appropriate.

Warning

The system can steer the vehicle over or onto curbs. There is a risk of injury and risk of property damage. Watch surrounding traffic closely and actively intervene where appropriate.

Functional requirements

- ▷ Drive forward without interruption to store the distance covered.
- ▷ To store the distance covered, do not drive faster than 22 mph/35 km/h.
- ▷ Dynamic Stability Control is activated.

Driving in reverse with automated steering

1. Turn on drive-ready state.



2.  With the vehicle at a standstill, press button or engage reverse gear.

The parking assistance systems view is displayed.

3.  "Back-Up Assistant"

Follow the instructions on the control display where required.

4. Take your hands off the steering wheel and carefully drive in reverse with the accelerator pedal and the brake.

 Green: the system takes control of steering.

When driving in reverse, observe the vehicle's surroundings.

In case of obstacles, stop immediately and take over control of the vehicle. Follow the instructions for Park Distance Control.

- 5. Right before the end of the stored distance covered, a signal tone will sound and a message is displayed.

Stop no later than when normal road traffic is reached and take control of the vehicle such as by shifting to forward gear.

Canceling the Back-up Assistant manually

The assisted reversing by the Back-up Assistant can be canceled manually:

- ▷ Via touchscreen:  "Back-Up Assistant"

- ▷  Press the button.

Canceling the Back-up Assistant automatically

The system automatically cancels in situations such as the following:

- ▷ When the driver grasps the steering wheel or takes over steering.
- ▷ When shifting from reverse gear to another selector lever position.
- ▷ During activation or intervention by driver assistance systems.
- ▷ After an extended period of time when the vehicle is stationary.
- ▷ When exiting the stored lane when reversing, for instance with maximum steering-wheel angle.
- ▷ When the view on the control display is overlaid with messages.
- ▷ In case of a slippery surface.
- ▷ When the vehicle is rolling such as on a slope.
- ▷ In case of changed ambient conditions.
- ▷ If the vehicle speed exceeds approx. 6 mph/9 km/h.

System limits

- ▷ The maximum speed when reversing is limited to approx. 6 mph/9 km/h.
A warning is issued at a speed of approx. 4 mph/7 km/h.
If the maximum speed is exceeded, the function is interrupted.
- ▷ After driving a stored distance covered with major steering-wheel angles, the function of the system will be limited for the return trip.

Different influences can lead to side deviations when driving the stored distance covered in reverse. For example, this includes the following factors:

- ▷ Steering movements when the vehicle is stationary while storing the distance covered.
- ▷ The speed is not adapted to the distance covered.
- ▷ Certain road characteristics such as gradients, inclines or slippery road surface.
- ▷ Greatly deviating conditions when storing and driving the route, for instance other tires or changed ambient conditions like weather.

Also follow the information on system limits in the "Parking assistance systems" chapter.

Driving comfort

Vehicle features and options

This chapter describes model-specific equipment, systems, and functions that are currently available, or may become available in the future, even if they are not present in the vehicle.

Additional information:

Vehicle equipment, refer to page [8](#).

Adaptive M chassis

Principle

The Adaptive M chassis is an intelligent, controllable sport chassis.

The chassis reduces body movements with a sporty driving style or on an uneven road.

General information

The intelligent control of the chassis increases the driving dynamics and driving comfort depending on the road condition and driving style.

Setting

The system offers different shock absorber settings ranging from comfortable travel to sporty driving.

The shock absorbers are adjusted depending on the selected driving mode as well as the road condition and driving style.

Additional information:

Driving Experience Control, refer to page [130](#).

Self-leveling suspension

Principle

The air suspension on the rear axle helps the self-leveling suspension keep the vehicle height and ground clearance constant.

Irrespective of the load, the system maintains the height of the vehicle at the rear axle at a predefined vehicle level thus offering consistent driving comfort.

Malfunction

A Check Control message is displayed. Vehicle handling may be altered and driving comfort may be noticeably reduced. Visit the nearest authorized service center or another qualified service center or repair shop.

Long stationary periods

During long stationary periods, the vehicle may lower itself. This is not a malfunction.

When the drive-ready state is switched on with the doors closed, the vehicle is raised to the normal level automatically.

BMW IconicSounds

Depending on vehicle equipment and national-market version, the vehicle drive sound can be adjusted using BMW IconicSounds.

1.  Apps menu
2. "Vehicle"
3. "Driving settings"
4. "Drivetrain and chassis"
5. "IconicSounds"
6. Select the desired setting.

Climate control

Vehicle features and options

This chapter describes model-specific equipment, systems, and functions that are currently available, or may become available in the future, even if they are not present in the vehicle.







Additional information:







Vehicle equipment, refer to page 8.

Climate control

Overview



Functions in the Climate menu

Icon	Function
	Turn the climate control system on/off.
	Automatic program.
	Temperature.
	Air conditioning.
	Maximum cooling.
	Air recirculation mode.
	Automatic recirculated-air control.

Icon	Function
	Fresh air.
	Air flow.
	Air distribution.
	SYNC program.
	Seat heating.
	Active seat ventilation.
	Steering wheel heating.

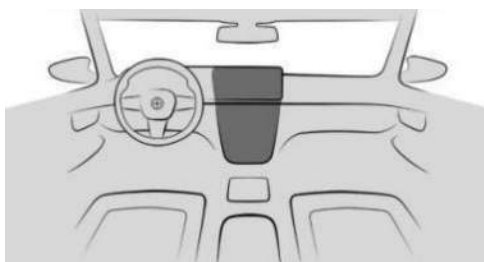



Buttons, automatic climate control

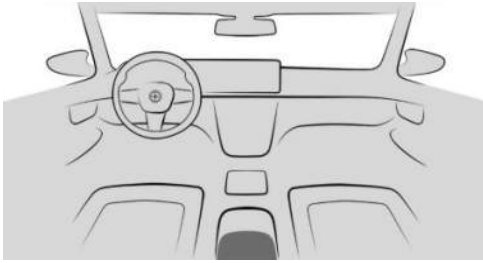

Icon	Function
	Defrost function.
	Rear window defroster.

Buttons, rear automatic climate control



Icon	Function
	Automatic program.
	Temperature.
	Air distribution.
	Seat heating.
	Switching off.

Calling up climate control functions

The Climate menu can be accessed via iDrive:



 Tap the icon for the Climate menu on the menu bar.

Or:

-  Apps menu
- "Vehicle"
- "Climate control"

Turning the air conditioning system on/off

The climate control system can be turned on or off via iDrive.

-  Tap the icon for the Climate menu on the menu bar.
-  Tap the power button.

The entire climate control system is turned on or off with the last settings applied.

When the air conditioning system is turned on, individual climate control functions can be turned off.

Settings

You can configure individual settings for climate control functions via iDrive, e.g.:

- ▷ Intensity of seat heating.
- ▷ Pre-conditioning.
- ▷ Air conditioning when getting in.

-  Tap the icon for the Climate menu on the menu bar.
- "Individual settings" or "General settings"
- Select the desired setting.

Turning rear automatic climate control on/off

Functional requirements

- ▷ Automatic climate control is turned on.
- ▷ Defrost function is deactivated.

Via iDrive

-  Tap the icon for the Climate menu on the menu bar.
- "Individual settings"

3. "Second row of seats"
4. "Rear climate control"
5. Select the desired setting.

The rear climate control can be activated with the default settings for temperature and the AUTO program:

"Activate with default settings"

Switching on using the button

Press one of the following buttons:

- ▷ Temperature.
- ▷ Automatic program.
- ▷ Air distribution, manual.

Switching off using the button

OFF

Press the button.

Locking the rear automatic climate control



1. Tap the icon for the Climate menu on the menu bar.
2. "Individual settings"
3. "Second row of seats"
4. "Lock rear climate control"

Automatic program

Principle

The automatic program ensures a comfortable climate, which can be modified with the desired temperature and individual settings.

The automatic program cools, ventilates or heats the vehicle interior automatically.

General information

Depending on the equipment, the automatic program provides the best possible settings

for climate control functions depending on the outside temperature, interior temperature, sunlight, seat occupancy and the desired temperature setting:

- ▷ Air flow.
- ▷ Air distribution.
- ▷ Temperature.
- ▷ Seat heating.
- ▷ Active seat ventilation.

The automatic program takes seat occupancy into account, regulating the climate in an energy-efficient manner that is tailored to the occupants.

At the same time, a condensation sensor controls the automatic program in order to prevent window condensation to the extent possible.

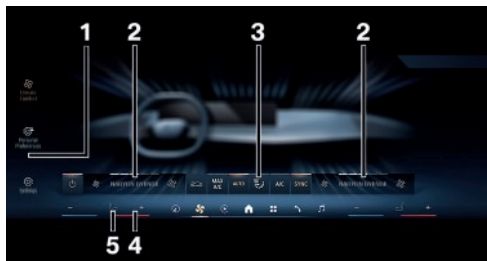

Overview



- 1 Settings
- 2 Air flow intensity
- 3 Climate control functions bar
- 4 Temperature
- 5 Seat heating
Active seat ventilation

Turning the automatic program on/off

The AUTO program can be switched on or off via iDrive.

-  Tap the icon for the Climate menu on the menu bar.
-  Tap the AUTO program button.

Switching the rear climate control automatic program on/off

Using the button

-  Press the button.
The LED of the button is illuminated when the automatic program is turned on.

Setting the intensity

When the automatic program is activated, the intensity of individual climate control functions, e.g., seat heating, is adjusted individually.

-  Tap the icon for the Climate menu on the menu bar.
- "Individual settings"
- Select the desired setting.

Each level has a specific control range of the intensity.

Based on the stored data models, the intensities are dynamically adjusted while driving. It is not necessary to manually change the desired intensity to lower or higher levels while driving.

The individually selected settings of the climate control functions are stored and automatically set up again such as after the vehicle is started again.

Display

The indicator on the menu bar provides information about the temperature difference between the configured desired temperature and current interior temperature.

- ▶ The red or blue bar next to the temperature display indicates the progress of heating or cooling.
- ▶ The desired interior temperature is reached as soon as the bar is no longer displayed.

Active climate control functions, e.g., seat heating, are indicated by the icons on the menu bar.

Temperature

Principle

The automatic climate control cools or heats to the configured temperature and then keeps the temperature constant.

General information

Do not rapidly switch between different temperature settings. Otherwise, the automatic climate control will not have sufficient time to adjust the set temperature.

Setting the temperature



You can set the desired temperature for driver and front passenger individually on the menu bar.

- ▷ + Raise the temperature.
- ▷ — Lower the temperature.

Setting the rear automatic climate control temperature

Via iDrive

1.  Tap the icon for the Climate menu on the menu bar.
2. "Individual settings"
3. "Second row of seats"
4. Set the desired temperature.

Using the button

-  Press the left or right button side to set the desired temperature.

Upper body temperature

General information

The air temperature in the upper body area can be adjusted.

This does not change the set interior temperature for the driver and front passenger.

Adjusting the upper body temperature

1.  Tap the icon for the Climate menu on the menu bar.
2. "Individual settings"
3. "Temperature adjustment upper body"
4. Increase or decrease temperature.

Air flow



Principle

The air flow generated by the blower can be adjusted as needed.

The air flow may be reduced to preserve the vehicle battery.

Adjusting the air flow

The air flow can be set via iDrive.

1.  Tap the icon for the Climate menu on the menu bar.
2.  Select the desired setting.

Automatic program:

- ▷ Tap the large air flow icon to increase the air flow.
- ▷ Tap the small air flow icon to reduce the air flow.

Manual mode:

- ▷ Tap up arrow: Increase air flow.
- ▷ Tap down arrow: Reduce air flow.



Air distribution settings

Principle

In manual mode, the air distribution can be adjusted as needed.

Adjusting the air distribution

The air distribution can be set via iDrive:

-  Tap the icon for the Climate menu on the menu bar.
-  Tap the air distribution icon on the climate control functions bar.
- Select the desired setting:
 - ▶ Aim the air flow into the footwell, arrow 1.
 - ▶ Aim the air flow toward the upper body area, arrow 2.
 - ▶ Aim the air flow at the windshield, arrow 3.

The selected air distribution is displayed.

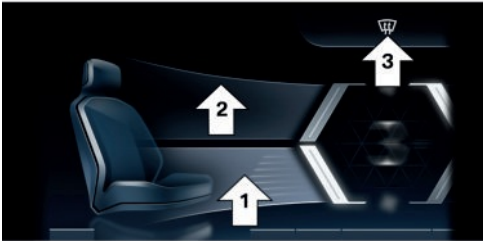

Adjusting the air distribution of the rear climate control

-  Press the button repeatedly. Select the desired setting.
The selected air distribution is shown on the rear climate control display.

Air conditioning

Principle

With the climate control function, the air inside the vehicle is cooled and dehumidified, then



warmed again depending on the temperature settings.

Functional requirement

Standby or drive-ready state is turned on.

Switching the cooling function on/off

The air conditioning can be switched on or off via iDrive:

-  Tap the icon for the Climate menu on the menu bar.
-  Tap the air conditioning button.

In recirculated-air mode, air conditioning is automatically switched on to dry the air and avoid window condensation.

Depending on the weather, the windshield and the side windows may fog up briefly when drive-ready state is switched on.

When using the cooling mode, condensation that will exit below the vehicle.

Maximum cooling

Principle

Maximum cooling lets you cool the vehicle interior quickly and effectively.

The lowest temperature and the maximum air flow are set automatically.

The function is automatically activated in the rear when the SYNC program is turned on.



Functional requirement

The following functional requirements must be met for maximum cooling:

- ▶ The outside temperature is higher than approx. 32°F / 0°C.
- ▶ Standby or drive-ready state is turned on.

Turning maximum cooling on/off

Maximum cooling can be turned on or off via iDrive:

1.  Tap the icon for the Climate menu on the menu bar.
2.  Tap the maximum cooling button.

Air flows out of the air vents to the upper body area. Open the vents.

Air recirculation mode

Principle

You may react to unpleasant odors or pollutants in the immediate environment by temporarily suspending the supply of outside air. The system then recirculates the interior air.

In automatic recirculated-air control mode, outside air is fed in or the interior air recirculated depending on the outside air quality.

When the air recirculation is turned off, outside air is directed into the interior.

General information

If there is window condensation, turn off the air recirculation.



The interior filter cleans the incoming fresh air or the circulated interior air in recirculation mode.

Turning air recirculation on/off

Air recirculation mode can be switched on or off via iDrive:

1.  Tap the icon for the Climate menu on the menu bar.
2. The current operating mode is displayed on the climate control functions bar. Tap the

button until the desired operating mode is set.

- ▶  Recirculating air.
- ▶  Fresh air.
- ▶  Automatic air recirculation.

Depending on vehicle equipment, the air recirculation turns off automatically after some time based on the ambient conditions in order to prevent condensation.

SYNC program

Principle

If the SYNC program is activated, the settings for the driver's side are transferred to the passenger's side and to the rear.

For improved comfort, when the SYNC program is deactivated, the following settings are adjusted automatically in the automatic program depending on seat occupancy:

- ▶ If the front passenger seat is unoccupied, the settings for the driver's side are applied to the front passenger side.
- ▶ If the seats in the rear are unoccupied, the default settings for the rear are applied.

When the seat is occupied again, the most recent settings are reapplied.



General information

The following settings can be applied:

- ▶ Temperature.
- ▶ Air distribution.
- ▶ Automatic program.

Turning the SYNC program on/off

The SYNC program can be switched on or off via iDrive:

-  Tap the icon for the Climate menu on the menu bar.
-  Tap the SYNC program button.

If the settings on the front passenger side or in the rear are changed, the program is automatically switched off.

Defrost function

Principle

With the defrost function, ice and condensation are quickly removed from the windshield and the front side windows.

The air flow and air temperature are automatically optimized for the removal of ice and condensation.

The air distribution is directed toward the windshield and front side windows.

If there is window condensation, turn on the automatic program to take advantage of the condensation sensor.

When the defrost function is turned on, the rear automatic climate control is deactivated to provide maximum performance.

Turning the defrost function on/off

-  Press the defrost button on the instrument panel.
 The LED of the button is illuminated when the system is switched on.

Make sure that air is able to flow to the windshield and front side windows.

Rear window defroster

Principle

With the rear window defroster, ice and condensation are quickly removed from the rear window.

Functional requirement

Standby or drive-ready state is turned on.

Turning the rear window defroster on/off

-  Press the rear window heating button on the instrument panel.

The LED in the button illuminates when the rear window heating is turned on.

The rear window defroster switches off automatically after a certain period of time.

If pre-conditioning is turned on, the rear window defroster is activated as needed.

Seat heating

Principle

The system heats the seats as necessary.

General information

If the trip is continued within approx. 15 minutes after an intermediate stop, the functions are turned on automatically with the temperature that was last set.

Adjusting seat heating

Automatic program

When the automatic program is activated, the intensity of seat heating can be adjusted: As you drive, the heater output is automatically adjusted according to your set intensity.

Adjusting seat heating manually

The heater output level can be adjusted manually:



1. Tap the icon for seat climate control on the menu bar, arrow 1.

2.  Press the seat heating button repeatedly until the desired level is selected, arrow 2.

If a consumption-optimized drive mode is selected, the heater output is reduced.

Turning the rear automatic climate control seat heating on/off

-  Press the button once for each temperature level.

The maximum temperature is reached when three LEDs are illuminated.

Active seat ventilation

Principle

The system cools the seat and backrest as necessary, ensuring a pleasant seat temperature.

Adjusting active seat ventilation

Automatic program

When the AUTO program is on, the intensity of seat ventilation can be adjusted. As you

drive, the ventilation is automatically adjusted according to the set intensity.

Adjusting the active seat ventilation manually

The ventilation level can be adjusted manually:



1. Tap the seat climate control icon on the menu bar, arrow 1.
2.  Press the seat ventilation button repeatedly until the desired level is selected, arrow 2.

Steering wheel heating

Principle

The system heats the steering wheel as necessary.

Adjusting steering wheel heating

Automatic program

When the automatic program is activated, the intensity of steering wheel heating can be adjusted. As you drive, the heater output is automatically adjusted according to your set intensity.

Adjusting steering wheel heating manually

The heater output level can be adjusted manually:



1. Tap the seat climate control icon on the menu bar, arrow 1.
2.  Press the steering wheel heating button repeatedly until the desired level is selected, arrow 2.

If a consumption-optimized drive mode is selected, the heater output is reduced.

Ventilation

Principle

The ventilation system offers individual adjustment ranges for direct/indirect ventilation in order to optimize the flow of air within the vehicle.

General information

Open the air vents and position them to ensure effective air conditioning.

The air flow heats or cools noticeably, depending on the set desired temperature.

Front ventilation



Setting the air flow direction and air volume at the vent.

- ▷ Changing the air flow direction: press the button in the desired air flow direction.
- ▷ Changing the air volume:
 - ▷ Turn the knob clockwise: increase the air volume.
 - ▷ Turn the knob counterclockwise to decrease the air volume.

Ventilation in the rear

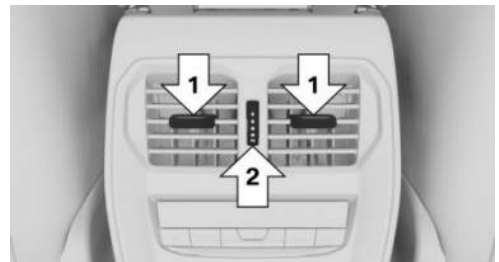

- ▷ Lever for changing the airflow direction, arrows 1.
- ▷ Knurled wheel for variable opening and closing of the air vents, arrow 2.

Setting the ventilation

Depending on the desired ventilation, align the air flow directly or indirectly toward the passengers.

Air quality

General information

The air quality in the interior is improved by the following components:

- ▷ Emission tested passenger compartment.
- ▷ Interior filter.
- ▷ Air conditioning system to control the temperature, air flow and recirculated-air mode.
- ▷ Pre-conditioning.

Interior filter

The interior filter cleans the incoming fresh air or the circulated interior air in recirculation mode.

Depending on the equipment:

- ▷ Dust and pollen is filtered out from the in-flowing air.
- ▷ Nano-particle emissions are reduced.
- ▷ Gaseous pollutants are filtered.
- ▷ Microbial particles, viruses and allergens are filtered.

The manufacturer of the vehicle recommends having the interior filter changed during vehicle maintenance.

Pre-conditioning

Principle

Pre-conditioning cools or heats the vehicle interior to a comfortable temperature, depending on the inside/outside temperature, prior to starting a drive. This function makes it easier to remove snow and ice.

General information

The pre-conditioning can be switched on and off directly or via a preset departure time.

The air automatically exits through the air vents to the windshield, the side windows, the upper body area and into the footwell.

The system switches off automatically after approx. 30 minutes or when the drive-ready state is activated.

Preconditioning the vehicle while it charges, makes it easier for the climate control system to regulate the temperature while driving. This increases the range.

Functional requirements

- ▷ The vehicle is in idle state or standby state.
- ▷ The high-voltage battery is sufficiently charged or the charging process is ongoing. If the high-voltage battery is deeply discharged, it may take some time for the pre-conditioning to be ready after the charging process is started.
- ▷ Time and date are set correctly.
- ▷ The ventilation air vents are open.

Turning on/turning off the pre-conditioning

Turning on/turning off via iDrive



1. Tap the icon for the Climate menu on the menu bar.
2. "Pre-conditioning"
3. Select the desired setting.

Turning on via vehicle key

The system can be switched on using the vehicle key.



Press the button on the vehicle key three times within 1 second.

After using the vehicle key, it takes approx. 3 seconds until pre-conditioning turns on.

Automatic switch-off

To ensure the vehicle's minimum range, the preconditioning may turn off automatically, e.g., after repeated activation or because the high-voltage battery has insufficient charge. If the preconditioning turns off because the vehicle has insufficient charge, charge the high-voltage battery. The pre-conditioning is then available again.

Air conditioning for departure time

General information

Departure times can be set with time and day of the week.

The switch-on point is determined automatically based on the temperature.

On the desired weekdays, the system will be turned on promptly before the set departure time.

The departure time is preselected in two steps:

- ▶ Set departure times.
- ▶ Activate departure times.

A minimum of 10 minutes should pass between setting and activating the departure time and the planned departure time to allow a sufficient period of time for the air conditioning.

Pre-conditioning will be turned off automatically a few minutes after the set departure time.

Setting the departure time



1. Tap the icon for the Climate menu on the menu bar.
2. "Pre-conditioning"
3. "Departure plan"
4. Set the desired departure time.
5. Select day of the week, if needed.

Activating the departure time

To turn on the pre-conditioning prior to a departure time, the respective departure time must be activated beforehand.



1. Tap the icon for the Climate menu on the menu bar.
2. "Pre-conditioning"
3. "Pre-conditioning for departure"

Display on the instrument cluster

Icon	Description
	Icon illuminates: a departure time is activated. Icon flashes: pre-conditioning is switched on.

Activating with My BMW App

Depending on vehicle equipment, the My BMW App with remote functionality can be used to turn on pre-conditioning at a preset departure time or immediately.



Interior equipment

Vehicle features and options

This chapter describes model-specific equipment, systems, and functions that are currently available, or may become available in the future, even if they are not present in the vehicle.

Additional information:

Vehicle equipment, refer to page 8.

Integrated universal remote control

Principle

The integrated universal remote control in the interior mirror can operate remote-controlled systems such as garage door openers, alarm systems or locking systems.

General information

The integrated universal remote control replaces up to three different hand-held transmitters. To operate the remote control, the buttons on the interior mirror must be programmed with the desired functions.

Before selling the vehicle, delete the stored functions for the sake of security.

If possible, do not install the antenna of the remote-controlled system near metal objects to ensure the best possible operation.

Safety information

Warning

The operation of remote-controlled systems with the integrated universal remote control such as the garage door may result in injury, for example, body parts becoming jammed in a garage door. There is a risk of injury and

risk of property damage. Make sure that the travel path of the respective system is clear during programming and operation. Also follow the safety information for the hand-held transmitter.

Compatibility



If this icon is printed on the packaging or in the operating instructions of the remote-controlled system, the system is generally compatible with the integrated universal remote control.

Additional questions are answered by:

- ▶ An authorized service center or another qualified service center or repair shop.
- ▶ www.homelink.com on the Internet.

HomeLink is a registered trademark of Gentex Corporation.

For any additional questions, contact an authorized service center or another qualified service center or repair shop.

Operating elements on the interior mirror



- ▶ Buttons, arrow 1.
- ▶ LED, arrow 2.
- ▶ Hand-held transmitter of the remote-controlled system, arrow 3.

Programming the integrated universal remote control

Functional requirement

The battery of the hand-held transmitter must be fully charged at the time of programming to ensure an optimal range of the integrated universal remote control.

Programming individual buttons

1. Park the vehicle within range of the remote-controlled system.
2. Turn on standby state.
3. Select desired button on the interior mirror:
 - ▶ Program available button:
Press the button.
 - ▶ Program already assigned button:
Press and hold the button for approx. 20 seconds.

The LED on the interior mirror will slowly begin flashing orange.

4. Hold the hand-held transmitter for the remote-controlled system approx. 1 to 12 in/2.5 to 30 cm away from the buttons on the interior mirror.
The required distance depends on the hand-held transmitter.
5. Press and hold the button on the hand-held transmitter.
Canada: if programming with the hand-held transmitter was interrupted, hold down the interior mirror button and repeatedly press and release the hand-held transmitter button for 2 seconds.
6. The LED can illuminate in different ways:
 - ▶ The LED illuminates green: programming completed.
Release button.
 - ▶ The LED flashes green rapidly: the hand-held transmitter was detected but programming is not complete.

Press and hold the button on the interior mirror for approx. 2 seconds. Perform this procedure three times.

If the integrated universal remote control remains nonoperational, continue with the special features for rolling code radio systems.

- ▶ LED does not illuminate green after 60 seconds: programming not completed.
Repeat steps 3 to 5.

Special feature of the rolling code wireless system

For systems with a rolling code radio system, the integrated universal remote control and the system also have to be synchronized.

Refer to information on synchronization in the operating instructions of the remote-controlled system.

1. Program the desired button on the interior mirror.
2. Locate and press the synchronizing button on the remote-controlled system such as on the garage door.

You have approx. 30 seconds for the next step.

Synchronizing is easier with the aid of a second person.

3. Press and hold the programmed button on the interior mirror for approx. 3 seconds.
If necessary, repeat this step up to three times in order to end synchronization. Once synchronization is complete, the programmed function will be carried out.

Operation

After programming, the remote-controlled system can be operated with the button on the interior mirror.

Press and hold the desired button of the remote-controlled system within range until the function is triggered.

The LED on the interior mirror is continuously illuminated green during the transmission of the radio signal.

Deleting a button assignment

The button assignment cannot be deleted individually.

Press and hold the two outer buttons on the interior mirror simultaneously for approximately 10 seconds until the LED flashes green rapidly.

All stored button assignments will be deleted.

Sun visor

Glare shield

Fold the sun visor down or up.

Glare shield from the side

Folding the sun visor out

1. Fold the sun visor down.
2. Detach it from the holder and swing it toward the side window.
3. Shift it back to the desired position.

Folding the sun visor in

Proceed in the reverse order to close the sun visor.

Vanity mirror

A vanity mirror is located in the sun visor behind a cover.

Sockets

Principle

The socket can be used for electronic devices when the standby or drive-ready state is switched on.

General information

The total load of all sockets must not exceed 140 watts at 12 volts.

Do not damage the socket by using unsuitable connectors.

Safety information

 **Warning**

Devices and cables in the unfolding area of the airbags such as portable navigation devices can hinder the unfolding of the airbag or be thrown around in the car's interior while unfolding. There is a risk of injury and risk of property damage. Make sure that devices and cables are not in the airbag's area of unfolding.

 **NOTICE**

Battery chargers that charge the vehicle battery via sockets or cigarette lighters in the vehicle may overload or damage the 12 V electrical system. There is a risk of property damage. If the vehicle battery has discharged, contact an authorized service center or another qualified service center or repair shop.

 **Warning**

If metal objects fall or are plugged into electronic interfaces, e.g., sockets or USB ports, these objects can cause a short circuit and destroy the interface. There is a risk of injury

and risk of property damage. Make sure to prevent metal objects from falling or being plugged into electronic interfaces. Insert the cigarette lighter or socket cover again after using the socket.

Front center console

1. Press on the cover.



2. A socket is located between the cup holders. Detach the cover.



In the cargo area



Depending on vehicle equipment, there is a socket in the cargo area on the right side. Unfold the cover.

USB port

General information

Follow the information regarding the connection of mobile devices to the USB port in the section on USB connections.

Additional information:

USB connection, see Owner's Manual for Navigation, Entertainment, Communication;

Safety information

Warning

If metal objects fall or are plugged into electronic interfaces, e.g., sockets or USB ports, these objects can cause a short circuit and destroy the interface. There is a risk of injury and risk of property damage. Make sure to prevent metal objects from falling or being plugged into electronic interfaces. Insert the cigarette lighter or socket cover again after using the socket.

In the center armrest



A USB port is located in the center armrest.

Properties:

- ▷ USB port Type C.
- ▷ For charging mobile devices.
- ▷ Charge current: max. 3 A.

In the front center console

NOTICE

Objects in the storage compartment, e.g., large USB connectors, may block or damage the cover when it is being opened or closed. There is a risk of property damage. Make sure that the area of movement of the cover is clear while opening and closing it.



If necessary, push on the cover.



A USB port is located in the center console.

Properties:

- ▷ USB port Type A.
- ▷ For charging mobile devices and for data transfer.
- ▷ Charge current: max. 1.5 A.

In the rear center console



Depending on the equipment, there are two USB ports in the center console in the rear.

Properties:

- ▷ USB port Type C.
- ▷ For charging mobile devices.
- ▷ Charge current: maximum 3 A per port.

Wireless charging tray

Principle

The wireless charging tray is used to wirelessly charge Qi-certified smartphones.

General information

When inserting the smartphone to be charged, make sure that there is nothing between the smartphone to be charged and the wireless charging tray.

 The charging process is shown by the charge indicator on the control display.

Safety information

Warning

When charging a Qi-compatible device in the wireless charging tray, any metal objects on the tray together with the device can become very hot. Storage media or electronic cards, e.g., chip cards, cards with magnetic strips, or cards for transmitting signals, may not func-

tion correctly when placed together on the tray with the device. There is a risk of injury and risk of property damage. When charging mobile devices, make sure there are no objects on the tray together with the device.

Overview

Tray in the center console:



- 1 LED
- 2 Storage area

Functional requirements

- ▷ The smartphone to be charged must be Qi-certified.
- ▷ Standby state is switched on.
- ▷ Smartphone must not exceed maximum dimensions of approx. 6.0 x 3.1 x 0.7 in/154.5 x 80 x 18 mm.
- ▷ Protective sleeves and covers must be suitable for wireless charging.
- ▷ The smartphone to be charged is located in the center of the tray. The smartphone display is facing up.

Inserting a smartphone

1. Open the tray cover.
2. Place the smartphone in the middle of the tray, with the display facing up.
3. Close the tray cover.

LED displays

Color Meaning

Blue	Smartphone is charging. The blue LED continues to illuminate when the Qi-capable smartphone is fully charged.
Orange	Smartphone is not charging. Temperature on the smartphone may be too high, or foreign object may be in charging tray.
Red	Smartphone is not charging. Contact an authorized service center or another qualified service center or repair shop.

Forgotten warning

General information

A warning may be issued if a Qi-certified smartphone was forgotten in the wireless charging tray when leaving the vehicle.

The forgotten warning is displayed in the instrument cluster.

Enable/Disable Forgotten Warning

1.  Apps menu
2. "Vehicle"
3. "System settings"
4. "Wireless charging tray"
5. "Mobile phone reminder"

System limits

The charge current may be reduced or charging may be temporarily interrupted in the wireless charging tray in the following situations:

- ▷ Due to excessive temperatures on the tray and smartphone.
- ▷ If there are objects between the smartphone and wireless charging tray.

- ▷ If storage media or electronic cards, e.g., chip cards, cards with magnetic stripes, or cards for signal transmission, are located between the smartphone and wireless charging tray.
- ▷ Due to protective sleeves and covers that exceed a thickness of 0.07 in/2 mm
- ▷ Due to protective sleeves and covers made of unsuitable material, e.g., with magnetic parts.
- ▷ Due to add-on parts for the smartphone, e.g., holders.
- ▷ By configuring the smartphone settings, e.g., for charging. Follow the instructions given on the control display and smartphone, as applicable.

Storage compartments

Vehicle features and options

This chapter describes model-specific equipment, systems, and functions that are currently available, or may become available in the future, even if they are not present in the vehicle.

Additional information:

Vehicle equipment, refer to page 8.

Safety information

Warning

When driving, loose items or devices connected to the vehicle with a cable, i.e., mobile phones, may be thrown around the vehicle, e.g., in the event of an accident or when braking or performing evasive maneuvers. There is a risk of injury and risk of property damage. Secure loose objects or devices that are connected to the vehicle via a cable.

Warning

Open flaps of the storage compartments, e.g., glove compartment or center armrest, protrude into the interior when folded open and may be in the way of an airbag that deploys. In addition, objects in the open storage compartment can be thrown into the vehicle interior during the trip, for instance, in the event of an accident or when braking or making an evasive maneuver. There is a risk of injury. Always close storage compartments immediately after use.

Warning

Anti-slip pads such as anti-slip mats can damage the dashboard. Attached objects could come loose. There is a risk of injury and risk of property damage. Do not use anti-slip pads.

Glove compartment

Opening the glove compartment



Pull the handle.

Closing the glove compartment

Fold the lid closed.

Locking the glove compartment

The glove compartment can be locked with an integrated key. This prevents access to the glove compartment.

After the glove compartment has been locked, the vehicle key can be given to someone without the integrated key, for example, when the car is being parked by a parking attendant.

Additional information:

Integrated key, refer to page 76.

Fold-out compartment

Opening the fold-out compartment



Press the button and open the cover.

Storage compartments in the doors

General information

There are storage compartments in the doors.

Safety information

Warning

Breakable objects such as glass bottles or glasses can break in the event of an accident, braking or an evasive maneuver. Broken glass can be scattered in the car's interior. There is a risk of injury and risk of property damage. Do not use any breakable objects while driving. Only stow breakable objects in closed storage compartments.

Storage tray in center console

Opening the storage compartment



Press on the cover.

Closing the storage compartment

Pull the cover on the handle back.

Front center armrest

General information

A storage compartment is located in the center armrest between the seats.

Opening the center armrest

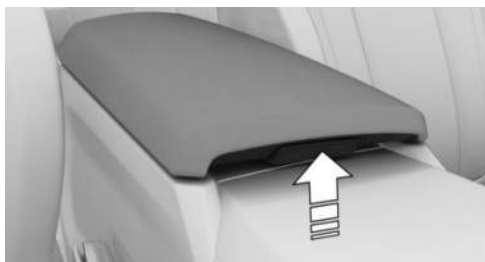

Press the button.

Closing the center armrest

Press the lid down until it engages.

Front cup holder

Safety information

Warning

Unsuitable containers in the cup holders may damage the cup holders or be thrown about the car's interior in the event of an accident, an evasive maneuver, or forceful braking. Spilled liquids can distract from the surrounding traffic conditions, lead to an accident and damage vehicle components. Hot drinks can damage the cup holder or lead to scalding. There is a risk of injury and risk of property damage. Do not force objects into the cup holder. Make sure that drink containers are secured firmly in the cup holder. Use lightweight, shatterproof, and sealable containers. Clean up spilled liquids immediately. Do not transport hot beverages.

Opening the cup holder



Press on the cover.



Two cup holders are located in the center console.

Closing the cup holder

Pull the cover on the handle back.

Rear cup holder

Safety information

Warning

Unsuitable containers in the cup holders may damage the cup holders or be thrown about the car's interior in the event of an accident, an evasive maneuver, or forceful braking. Spilled liquids can distract from the surrounding traffic conditions, lead to an accident and damage vehicle components. Hot drinks can damage the cup holder or lead to scalding. There is a risk of injury and risk of property damage. Do not force objects into the cup holder. Make sure that drink containers are secured firmly in the cup holder. Use lightweight, shatterproof, and sealable containers. Clean up spilled liquids immediately. Do not transport hot beverages.

 **NOTICE**

With an open cup holder, the center armrest cannot be folded back up. There is a risk of property damage. Press back the covers before the center armrest is folded up.

Opening the cup holder

1. Fold down the center armrest.

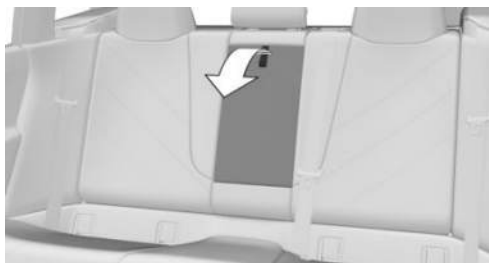

2. Press the button to open the cup holder.

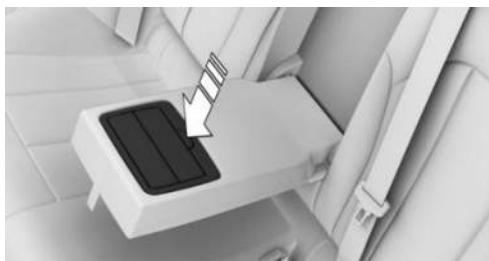

Closing the cup holder

Press both covers back inward in sequence and fold the center armrest back.

Coat hooks

General information

The coat hooks are located in the grab handles in the rear.

Safety information

 **Warning**

Clothing articles on the coat hooks can obstruct the view while driving. There is a risk of accident, injury, and property damage. When suspending clothing articles from the coat hooks, ensure that they will not obstruct the driver's view.

 **Warning**

Improper use of the coat hooks can lead to a risk of objects flying about during braking and evasive maneuvers. There is a risk of injury and risk of property damage. Only hang light-weight objects, for instance clothing articles, from the coat hooks.

Cargo area

Vehicle features and options

This chapter describes model-specific equipment, systems, and functions that are currently available, or may become available in the future, even if they are not present in the vehicle.

Additional information:

Vehicle equipment, refer to page 8.

Loading

Safety information

Warning

High gross vehicle weight can overheat the tires, damage them internally and cause a sudden tire pressure loss. Driving characteristics may be negatively impacted, reducing directional stability, lengthening the braking distances and changing the steering response. There is a risk of accident, injury, and property damage. Pay attention to the permitted load-carrying capacity of the tires and never exceed the permitted gross vehicle weight.

Warning

When driving, loose items or devices connected to the vehicle with a cable, i.e., mobile phones, may be thrown around the vehicle, e.g., in the event of an accident or when braking or performing evasive maneuvers. There is a risk of injury and risk of property damage. Secure loose objects or devices that are connected to the vehicle via a cable.

Warning

Improperly stowed objects can slip and be thrown into the car's interior, for instance in the event of an accident, braking or an evasive maneuver. Vehicle occupants can be hit and injured. There is a risk of injury and risk of property damage. Stow and secure objects and cargo properly.

NOTICE

Fluids in the cargo area can cause damage. There is a risk of property damage. Make sure that no fluids leak in the cargo area.

Steps for determining correct load limit

1. Locate the statement "The combined weight of occupants and cargo should never exceed XXX kg or XXX lbs" on the vehicle's placard.
2. Determine the combined weight of the driver and passengers that will be riding in the vehicle.
3. Subtract the combined weight of the driver and passengers from XXX kg or XXX lbs.
4. The resulting figure equals the available amount of cargo and luggage load capacity. For example, if the "XXX" amount equals 1,400 lbs and there will be five 150 lbs passengers in the vehicle, the amount of available cargo and luggage load capacity is 650 lbs (1,400 - 750 (5 x 150) = 650 lbs).
5. Determine the combined weight of luggage and cargo being loaded on the vehicle. That weight may not safely exceed the



available cargo and luggage load capacity calculated in Step 4.

- If the vehicle will be towing a trailer, load from your trailer will be transferred to the vehicle. Consult this manual to determine how this reduces the available cargo and luggage load capacity of the vehicle.

Payload

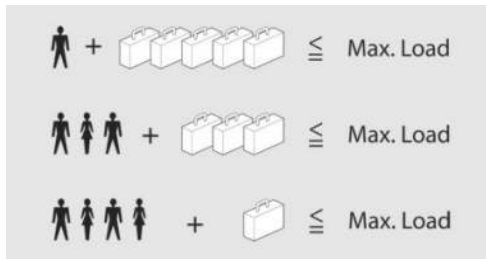

The maximum payload is the sum of the weight of the occupants and the cargo.

The greater the weight of the occupants, the less cargo that can be transported.

Stowing and securing cargo

- ▶ Cover sharp edges and corners on the cargo.
- ▶ Do not stack cargo above the upper edge of the backrests.
- ▶ If necessary, fold down the rear backrests to stow large cargo.
- ▶ Fasten the aids for securing the load to the lashing eyes in the cargo area.
- ▶ Small and light cargo: secure with tensioning straps or tension bands or with a luggage compartment net.
- ▶ Larger and heavy cargo: secure with cargo straps.
- ▶ Heavy cargo: stow as far forward as possible, directly behind and at the bottom of the rear seat backrests.
- ▶ Very heavy cargo: stow as far forward as possible, directly behind and at the bottom

of the rear seat backrests. When the rear seat is not occupied, secure each of the outer seat belts in the opposite buckle.

Lashing eyes in the cargo area

General information

Attach auxiliary materials to secure the cargo such as lashing straps, tensioning straps, draw straps, or cargo nets to the lashing eyes.

Overview



The lashing eyes are located in the cargo area.

Multifunction hook

General information

Depending on the vehicle equipment, a multifunction hook is located on the right side in the cargo area.

Safety information

Warning

Improper use of the multifunction hooks can lead to a risk of objects flying about, e.g., during braking and evasive maneuvers. There is a risk of injury and risk of property damage. Only hang lightweight objects from the multi-

function hooks. Heavy luggage in the cargo area must be properly secured.

Folding out the multifunction hook

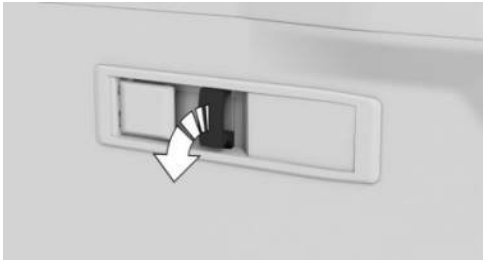

Fold down the multifunction hook until it noticeably engages in the lower position.

Net

Depending on the equipment, smaller objects can be stowed in the net on the left or right side. To transport larger objects, slide the net down.

Cargo floor panel

General information

There is a storage compartment under the cargo area floor.

Opening the storage compartment

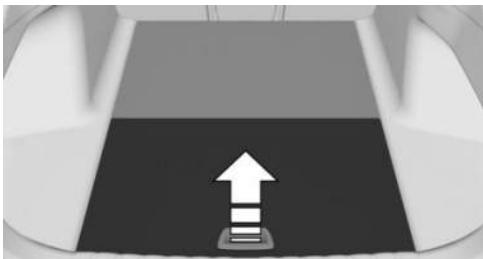

Fold cargo area floor forwards.

Enlarging the cargo area

Principle

The cargo area can be enlarged by folding down the rear seat backrests.

General information

The rear seat backrest is divided at a ratio of 40–20–40. The right rear seat backrest and the center section can be folded down separately. The left rear seat backrest can be folded down together with the center section.

The rear seat backrests can be folded down from the rear.

Safety information

Warning

Vehicle parts can be damaged or body parts jammed when folding down the rear seat backrest. There is a risk of injury or risk of property damage. Make sure that the area of movement of the rear seat backrest including head restraint is clear when folding down.

Warning

If a rear seat backrest is not locked, unsecured cargo can be thrown about the car's interior; for instance, in the event of an accident, braking or an evasive maneuver. There is a risk of injury. Make sure that the rear seat backrest is locked after folding it back.

Warning

The stability of the child restraint system is limited or compromised with incorrect seat setting or improper installation of the child seat. There is a risk of injury or danger to life. Make sure that the child restraint system fits securely against the backrest. If possible, ad-

just the backrest tilt for all affected backrests and correctly adjust the seats. Make sure that seats and backrests are securely engaged or locked. If possible and necessary, adjust the height of the head restraints or remove them.

Folding down the rear seat backrest

From the rear

1. If necessary, remove the respective head restraint.
2. Pull the lever in the recess and fold the rear seat backrest forward.



Folding back the rear seat backrest

Return the rear seat backrest to the seat position and engage it. Make sure that the seat belt is not caught behind the backrest or in between the backrest and the rear seats. The red marking behind the recess disappears completely.

Folding down middle section

1. Fold down the center head restraint.
2. Pull lever and fold the center section forward.

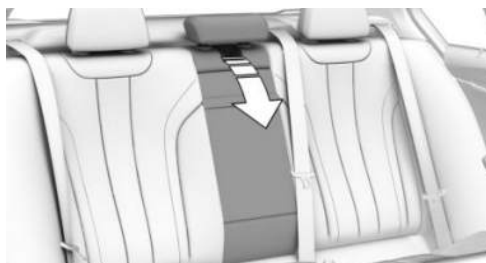

Cargo cover

Safety information

 **Warning**

When driving, loose items or devices connected to the vehicle with a cable, i.e., mobile phones, may be thrown around the vehicle, e.g., in the event of an accident or when braking or performing evasive maneuvers. There is a risk of injury and risk of property damage. Secure loose objects or devices that are connected to the vehicle via a cable.

 **Warning**

Body parts can become trapped when the folding cargo cover is operated. There is a risk of injury. When operating the folding cargo cover, make sure that the travel path of the cover is clear.

⚠ Warning

An incorrectly inserted cargo cover can be thrown about the car's interior such as in the event of an accident or a braking or evasive maneuver. There is a risk of injury and risk of property damage. Make sure the cargo cover is securely engaged in the brackets.

Inserting the cargo covers

Proceed in the reverse order to reinstall. Make sure that the cargo covers are positioned correctly in the brackets and that they are engaged.

Removing cargo covers

The cover can be removed to load bulky luggage.

Cover in the cargo area

1. Push the rear edge of the cargo cover up and out of the side brackets, arrow 1.

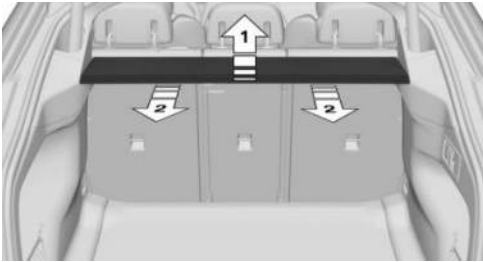

2. Pull out cargo cover, arrows 2.

Cover in the tailgate

1. Open lid at the rear edge, arrow 1, and slightly fold the cargo cover open.

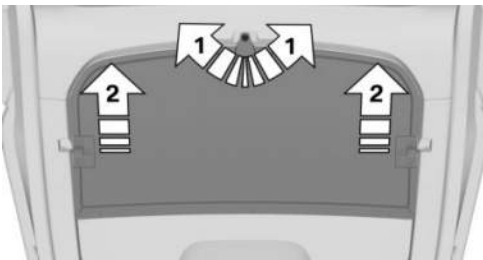

2. Pull the cargo cover up and out of the brackets, arrows 2.

Things to remember when driving

Vehicle features and options

This chapter describes model-specific equipment, systems, and functions that are currently available, or may become available in the future, even if they are not present in the vehicle.

Additional information:

Vehicle equipment, refer to page 8.

Break-in procedures

General information

Moving parts need to work together smoothly.

The following instructions will help you to achieve a long vehicle life and good efficiency.

During break-in, do not use the Launch Control.

Safety information

Warning

Due to new parts and components, safety and driver assistance systems can react with a delay. There is a risk of accident, injury, and property damage. After installing new parts or with a new vehicle, drive conservatively and intervene early if necessary. Observe the break-in procedures of the respective parts and components.

Drive system

Drive restrained for the first 300 miles/500 km and avoid full load.

Tires

Tire traction is not optimal due to manufacturing circumstances when tires are brand new.

Drive conservatively for the first 200 miles/300 km.

Brake system

Brake disks and brake pads must be broken in to avoid possible brake noise. Drive cautiously for the first approx. 300 miles/500 km.

Following part replacement

Observe the break-in procedures again if components mentioned above are replaced.

General driving notes

Closing the tailgate

Safety information

Warning

An open tailgate protrudes from the vehicle and can endanger occupants and other road users or damage the vehicle in the event of an accident, braking or evasive maneuvers. In addition, water may enter the vehicle interior. There is a risk of injury and risk of property damage. Do not drive with the tailgate open.

Driving with the tailgate open

If the vehicle still needs to be driven with the tailgate open:

- ▶ Close all windows and the glass sunroof.
- ▶ Greatly increase the blower output.
- ▶ Drive moderately.
- ▶ Secure the tailgate, e.g., with a tensioning belt.

Ground clearance

⚠ NOTICE

If the ground clearance is insufficient, e.g., underground garage entrances, speed bumps, or curbs, the ground may come into contact with vehicle parts, e.g., spoiler, and the underbody. There is a risk of property damage. Ensure that there is sufficient ground clearance available. Adjust your driving style to the respective conditions.

Driving at high speeds

⚠ Warning

Damage to vehicle components can negatively impact handling at high speeds. This includes, among other things, tires, underbody and parts for improving aerodynamics. There is a risk of accident, injury, and property damage. Have damage corrected by an authorized service center or another qualified service center or repair shop. Do not drive at high speeds until the damage is corrected.

Attachment point for radio systems

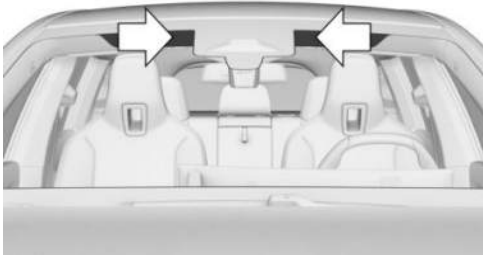

With climate comfort windshield: the marked area is not covered with heat-reflective coating.

The marked area can be used for the attachment of radio systems, e.g.:

- ▷ Garage door opener.
- ▷ Electronic fee collection devices.
- ▷ Payment systems.

Mobile communications in the vehicle

⚠ Warning

Vehicle electronics and mobile communication devices can influence one another. There is radiation due to the transmission operations of mobile communication devices. There is a risk of injury and risk of property damage. If possible, only use mobile communication devices, e.g., mobile phones, when connected directly to an external antenna or Personal eSIM in order to prevent mutual interference and to deflect radiation from the vehicle interior.

Aquaplaning

On wet or slushy roads, a wedge of water can form between the tires and road surface.

This phenomenon is referred to as aquaplaning. It is characterized by a partial or complete loss of contact between the tires and the road surface, ultimately undermining your ability to steer and brake the vehicle.

Driving through water

General information

When driving through water, follow the following:

- ▷ Drive through calm water only.
- ▷ Drive through water only up to a maximum height of 9.8 inches/25 cm.
- ▷ Drive through water at a maximum of walking speed, up to 3 mph/5 km/h.

Safety information

NOTICE

When driving too quickly through deep water, the water can penetrate under the hood, into the electrical system or into the transmission. There is a risk of property damage. When driving through water, do not exceed the maximum indicated water level and the maximum speed for driving through water.

Braking safely

General information

The vehicle is equipped with an Antilock Braking System as a standard feature.

Perform full braking when appropriate. To achieve the best possible braking assistance, do not reduce the pressure on the brake pedal during full braking. Steering is still responsive. You can still avoid any obstacles with a minimum of steering movement.

Sounds from the hydraulic circuits indicate that the Antilock Braking System is regulating.

Objects in the travel path of the pedals

Warning

Objects in the driver's footwell can limit the pedal travel or block a depressed pedal. There is a risk of accident, injury, and property damage. Stow objects in the vehicle such that they are secured and cannot enter into the driver's footwell. Use floor mats that are suitable for the vehicle and can be safely attached to the floor. Do not use loose floor mats and do not layer several floor mats. Make sure that there is sufficient clearance for the pedals. Ensure that the floor mats are securely fastened again after they were removed, for instance for cleaning.

Pedal feel when driving off

After turning on drive-ready state from idle state, the pedal may feel unusual, e.g., the pedal travel path may feel short or long. After the brake pedal has been fully released, the pedal will feel as usual again.

Driving in wet conditions

In case of wet roads, exposure to road salt or in heavy rain, gently depress the brake pedal every few kilometers. Ensure that this action does not endanger other road users.

The heat generated while braking dries brake disks and brake pads and protects them against corrosion.

In this way the brake power will be available when you need it.

Hills

General information

The braking effect of the drivetrain can be influenced through the energy recovery process.

Safety information

Warning

Light but constant pressure on the brake pedal can lead to high temperatures, brake wear, and even failure of the brake system. There is a risk of accident, injury, and property damage. Avoid placing excessive stress on the brake system.

Warning

In Neutral or with drive-ready state switched off, safety functions, for instance engine braking effect, braking assistance and steering assistance, may be restricted or not available. There is a risk of accident, injury, and

property damage. Do not attempt to drive in Neutral or with drive-ready state switched off.

Brake disk corrosion

Corrosion on the brake disks and contamination on the brake pads are increased by the following circumstances:

- ▷ Low mileage.
- ▷ Extended stationary periods.
- ▷ Infrequent use of the brakes.
- ▷ Aggressive, acidic, or alkaline cleaning agents.

Corrosion buildup on the brake disks will cause a pulsating effect on the brakes when braking slowly - generally this cannot be corrected.

Condensation water under the parked vehicle

When using the automatic climate control, condensation water develops and collects underneath the vehicle.

Driving on racetracks

Warning

The vehicle is not designed for use in M Sport or motorsport-like competition. There is a risk of accident, injury, and property damage. Do not use the vehicle for M Sport or motorsport-like competitions.

Higher mechanical and thermal loads during racetrack operation lead to increased wear. Use of the vehicle in M Sport or motor sport type competition is an improper use of the vehicle and may affect your warranty coverage. Please consult the New Vehicle Limited Warranty Booklet for further information on warranty matters.

The vehicle manufacturer recommends using special sport tires, e.g., high-performance tires. Sports tires are matched to the special requirements of a sporty driving style. For more information on sport tires, contact an authorized service center or another qualified service center or repair shop.

Before and after driving on a racetrack, have the vehicle checked by an authorized service center or another qualified service center or repair shop.

Roof bars

General information

Roof racks are available as optional accessories.

Safety information

Warning

When driving with a roof load, e.g., roof bars, the vehicle's center of gravity is higher. This increases the risk of the vehicle tipping in critical driving situations. There is a risk of accident, injury, and property damage. Drive with roof load only with activated Dynamic Stability Control.

Roof strip with flaps

The mounting points are located in the roof strip above the doors.

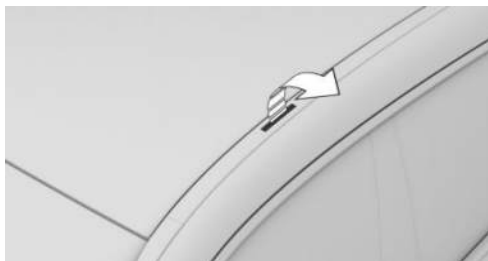

Fold the cover outward.

Installation

Follow the assembly instructions for the roof bars.

Be sure that adequate clearance is maintained for tilting and opening the glass sunroof.

Loading

Because luggage racks raise the vehicle's center of gravity when loaded, they have a major effect on vehicle handling and steering response.

When loading and driving, note the following:

- ▷ Do not exceed the approved roof/axle weights and the approved gross vehicle weight.
- ▷ Distribute the roof load uniformly.
- ▷ The roof load should not extend past the loading area.
- ▷ Always place the heaviest pieces on the bottom.
- ▷ Secure the roof luggage firmly, for instance using luggage straps.
- ▷ Do not let objects project into the swiveling range of the tailgate.
- ▷ Drive carefully. Do not drive off or brake suddenly or take corners at speed.

Increasing range

Vehicle features and options

This chapter describes model-specific equipment, systems, and functions that are currently available, or may become available in the future, even if they are not present in the vehicle.

Additional information:

Vehicle equipment, refer to page 8.

Increasing the range

Principle

The vehicle contains comprehensive technologies for reducing energy consumption and for maximizing the range.

There are some actions you can take to increase your range:

- ▶ Remove unnecessary cargo from the vehicle.
- ▶ Remove add-on parts, e.g., a rear carrier, after use.
- ▶ Close the windows and glass sunroof while driving.
- ▶ Check the tire pressure regularly and increase it as necessary.
- ▶ Use pre-conditioning before driving.
- ▶ Anticipatory driving and letting the vehicle coast more often.
- ▶ Deactivate functions that are not required, e.g., rear window heating.
- ▶ Have the vehicle serviced regularly.

Additional information:

Range, refer to page 149.

ECO PRO

Principle

ECO PRO supports a power-saving driving style. For this purpose, the engine control and comfort features, for instance the climate control output, are adjusted.

In addition, situational instructions and ECO PRO tips can be displayed to help promote a power-saving driving style.

General information

The system includes the following EfficientDynamics functions and EfficientDynamics displays:

- ▶ ECO PRO seat climate control.
- ▶ ECO PRO air conditioning.
- ▶ ECO PRO view.
- ▶ Driving style analysis.

Overview

Button in the vehicle

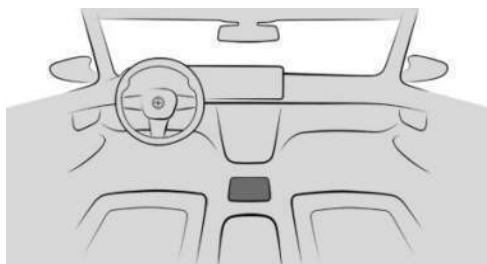

ECO PRO

Selecting the driving mode

 Press the button. ECO PRO is displayed in the instrument cluster.

Configuring ECO PRO INDIVIDUAL

Via iDrive

1.  Apps menu
2. "Vehicle"
3. "Driving settings"
4. "Drivetrain and chassis"
5. "ECO PRO INDIVIDUAL"
6. Select the desired setting.

Activating/deactivating ECO PRO functions

The following ECO PRO functions can be activated/deactivated:

- ▷ ECO PRO seat heating.
- ▷ ECO PRO air conditioning.
- ▷ ECO PRO light.

ECO PRO seat climate control

The activation of ECO PRO will reduce the output of the seat heating.

ECO PRO air conditioning

The air conditioning is adjusted to save energy.

This means it is possible to deviate slightly from the set temperature and heat or cool the car interior more slowly to economize on electrical consumption.

ECO PRO light

The output of exterior mirror heating and rear window defroster is reduced.

Depending on the equipment version, the dynamic ECO lighting function is activated in addition.

Resetting the settings

1.  Press the button.
2. "Settings"
3. "Reset to ECO PRO STANDARD"

Using eDRIVE efficiently

Principle

eDRIVE operates automatically. Anticipatory driving utilizes energy consumption and energy recovery optimally. Energy recovery is used to charge the high-voltage battery. Energy recovery is important for the supply of electrical components and thus a prerequisite for a long range. Energy consumption and energy recovery depend very much on your driving style, among other factors.

Optimizing driving style

Power gauge

When ECO PRO driving mode is activated, the display switches to a special configuration.

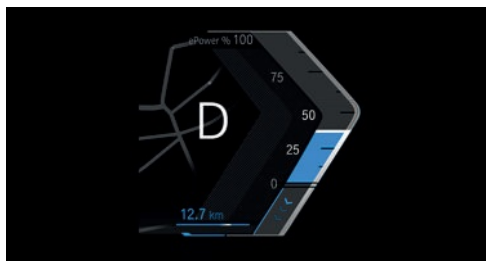

When driving efficiently, the power gauge is colored blue.

The display will change to gray if the driving style is inefficient.

Activate adaptive recuperative braking for efficient driving.

Additional information:

Driving in detail: eDRIVE, refer to page 127.

Display in case of inefficient driving style



When driving above the efficient range, an arrow will be displayed.

For instance, this is displayed for the following situations:

- ▷ Excessive acceleration.
- ▷ Excessive speed.

In addition, a notice to coast in advance is displayed.

Driving style analysis

Principle

In this situation, the function helps develop an especially efficient driving style and to save energy.

For this purpose, the driving style is analyzed. The assessment is done in various categories and is displayed on the control display.

This display will help you adjust your driving style and save some energy.

General information

The range of the vehicle can be extended by adjusting your driving style.

The current trip is analyzed.

Functional requirement

This function is available in ECO PRO driving mode.

Calling up the efficiency evaluation

1. Apps menu
2. "Vehicle"
3. "Live Vehicle"

Additional information:

Live Vehicle, refer to page 137

Display on the control display

The display of the efficiency analysis shows the efficiency of the driving style.

The more efficient the driving style, the larger the bars of the evaluation categories.

In contrast, a reduced area will be displayed with an inefficient driving style.

Adaptive recuperation

Principle

Adaptive recuperation supports an anticipatory and comfort-oriented driving style.

The system decides based on the situation if and how much the energy is recovered through recuperation or if the vehicle coasts. Depending on the strength of the recuperation, the vehicle is decelerated differently while coasting.

General information

Various sensors analyze the current driving situation, e.g., the distance to the vehicle in front.

Adaptive recuperation is available depending on the equipment and national-market version.

Functional requirements

The system active under the following conditions:

- ▷ Selector lever position D is engaged.
- ▷ Brake pedal not depressed.
- ▷ Accelerator pedal not operated.
- ▷ Dynamic Stability Control is activated.

Activating/deactivating adaptive recuperation

Adaptive recuperation activates when all functional requirements have been met.

Depending on vehicle equipment and national-market version, adaptive recuperation can be deactivated/activated manually on the control display.

1.  Apps menu
2. "Vehicle"
3. "Driving settings"
4. "Drivetrain and chassis"
5. "Energy recovery in D"
6. Select the desired setting.

Configuring the recuperation level

The recuperation level can be adjusted.

Additional information:

Driving in detail: eDRIVE, refer to page [127](#).

Display

Display in the instrument cluster

Adaptive recuperation can be displayed on the instrument cluster.

Additional information:

Power gauge, refer to page [148](#).

Display on the control display

The adaptive recuperation can be displayed on the control display.

Additional information:

Current driving condition, refer to page [155](#).

System limits

Adaptive recuperation cannot be used, or can only be used to a limited extent, in the following situations:

- ▶ When Active Cruise Control is on.
- ▶ If driver assistance system sensors are defective, dirty, or covered.

Coasting

Principle

The electric drivetrain makes it possible to roll without consuming energy. This driving condition is referred to as coasting.

General information

An anticipatory driving style helps the driver to use the function often and supports the energy-saving effect of coasting.

Coasting is automatically adapted to the respective driving situation.

Depending on vehicle equipment, "coasting" is displayed in the Live Vehicle menu as "Efficient coasting".

Additional information:

Current driving condition, refer to page [155](#).

Exemplary driving situations

If you can travel a certain distance without any foreseeable need to brake, it is beneficial to coast.

The following exemplary driving situations may be suitable:

- ▶ Rolling on a straight downhill route without obstacles.
 - ▶ Coasting on a distance without obstacles.
- Avoid late or strong braking.

Functional requirements

- ▶ Selector lever position D is engaged.
- ▶ The brake has not been applied.
- ▶ The accelerator pedal has not been pressed.
- ▶ Dynamic Stability Control is activated.

System limits

Coasting cannot be used, or can only be used to a limited extent, in the following situations:

- ▷ While Active Cruise Control is active.
- ▷ If driver assistance system sensors are defective, dirty, or covered.

Charging the vehicle

Vehicle features and options

This chapter describes model-specific equipment, systems, and functions that are currently available, or may become available in the future, even if they are not present in the vehicle.

Additional information:

Vehicle equipment, refer to page 8.

General information

The vehicle can be charged using various charging cables at charging stations, domestic socket outlets or industrial sockets.

Control and monitoring of the charging process are handled fully automatically. When charging with AC, the charge current level can be adjusted via iDrive.

Safety information

Warning

Working with electrical current improperly can lead to electric shock due to high voltages or high currents. There is a risk of fire, danger to life, and a risk of property damage. Observe the general safety regulations when working with electrical current.

Warning

A faulty or incorrectly designed charging device at the charging location can cause damage to the vehicle and overload the power supply at the charging location. There is a risk of fire, injury, and property damage.

The manufacturer of the vehicle recommends that, prior to your first use of a charging location, you have the compatibility of the following components confirmed:

- ▷ Charging cable.
- ▷ Charging station.
- ▷ Domestic socket outlet and connected circuits.

Warning

Damaged or worn charging equipment, e.g., worn contacts, can become hot. There is a risk of fire, injury, and property damage. Only use chargers that are in good condition.

Warning

Even when it is indicated that the high-voltage battery is discharged, the high-voltage system is always still under high voltage. There is a risk of fire or a risk of injury. Do not touch or change live parts, e.g., orange high-voltage cables, even when the batteries are discharged.

Warning

Contact with live components can lead to an electric shock. High voltage is present at the charging connection. There is a risk of injury or danger to life.

It is recommended that work on the charging connection, for example cleaning, is performed by an authorized service center or another qualified service center or repair shop.

⚠ NOTICE

The charging cable connected to the vehicle and the charging cable connections may be damaged due to mechanical load. There is a risk of damage to property. Do not apply mechanical loads to the charging cable and the charging cable connections. Route the charging cable to the vehicle freely and avoid stress due to pulling or bending.

Charging the high-voltage battery

The high-voltage battery serves as energy storage. The high-voltage battery can be charged utilizing energy recovery during the trip or via the power grid.

Charge the vehicle at a suitable charging device.

Charge the high-voltage battery regularly so that it operates optimally.

When charging via the power grid, you can choose between the following variants:

- ▶ Domestic socket outlet.
- ▶ Industrial socket.
- ▶ AC charging station.
- ▶ DC charging station.

For optimal use of the energy from the power grid, charging at a charging station, e.g., at a BMW Wallbox, is recommended.

The power grid and charging station should enable a charging capacity of at least 11 kW.

A lower charging capacity will extend the charging time.

Ensure that the charging station is installed according to the technical requirements of the power grid, e.g. by a qualified electrician.

Charge current

General information

The charge current strength is indicated in amperes.

There are differences in the maximum permissible charging current depending on the local power grid.

Before charging, set a suitable current limit for the charging current.

When charging at charging stations, the permissible charging current is automatically detected and a current limit is set.

When charging at a domestic socket outlet, set the current limit yourself.

Safety information

⚠ Warning

If the charge current strength is adjusted incorrectly, the power grid of the domestic socket outlet can be overloaded and overheat. There is a risk of fire, injury, and property damage. Adjust the charge current strength to the power grid prior to charging on domestic socket outlets. With unknown power networks, set on the lowest level.

Charging on a domestic socket outlet

The permitted charge current strength must be determined, for instance by a qualified electrician, before first charging with your own domestic socket outlet or when charging with third-party domestic socket outlets.

Current limit

General information

The current limit for charging with the Mode 2 charging cable and the Mode 3 charging cable can be set via iDrive.

When charging at domestic sockets on another power grid, the set charging current again may need to be checked again. The permitted charge current strength must be determined, for instance by a qualified electrician, before charging with a domestic socket outlet.

If the approved charging current strength is unknown, set the current limit to the lowest level.

Activating/deactivating current limit

1.  Apps menu
2. "Vehicle"
3. "Charging"
4. "AC limit"
5. "AC limit"

Setting the current limit

1.  Apps menu
2. "Vehicle"
3. "Charging"
4. "AC limit"
5. Select the desired setting.

Settings are stored. When you change charging locations you also might need to change the setting for charging.

Charging cable

General information

Use a Mode 2 charging cable, Mode 3 charging cable, or the permanently installed charging cable of a charging station to charge the vehicle.

Depending on national-market version, different charging cables are required and are included in the vehicle's scope of delivery.

Safety information

Warning

Incompatible charging cables, adapters, or unsuitable charging stations can heat up, cause damage to the vehicle, or lead to an electric shock. There is a risk of injury, danger to life, and risk of property damage. Use only charging cables, adapters, or charging stations that are recommended for the respective vehicle type.

An authorized service center will be glad to provide information about suitable charging cables and adapters.

Warning

Improper use of the charging cable can prevent charging and lead to damage, for instance cable fire. There is a risk of fire and an injury hazard. Use the charging cable only for charging the vehicle, and do not extend it using cables or adapters.

Warning

Damaged charging cables can become hot or cause electric shock. There is a risk of fire or an injury hazard. Use undamaged charging cables only.

Warning

An incorrectly connected charging cable can lead to damage, for instance cable fire. There is a risk of injury and risk of damage to property. Make sure that the charging cable con-

connector is completely inserted in the charging socket.

AC charging cable

Mode 2 charging cable

Mode 2 charging cables can be used to charge the vehicle from grounded domestic socket outlets. Charging at domestic socket outlet electrical connections is performed with alternating current.

When a Mode 2 charging cable is used, the efficiency values may differ from those stated on the energy label.

The Mode 2 charging cable is also referred to as standard charging cable.

Flexible Fast Charger, Mode 2 charging cable

The Flexible Fast Charger is a special mode 2 charging cable.

The interchangeable mains plugs of the Flexible Fast Charger allow you to charge flexibly using domestic socket outlets or industrial sockets with protective conductors.

Mode 3 charging cable

The Mode 3 charging cable makes it possible to quickly recharge at sockets of designated AC charging stations using a special connector. Charging is performed with alternating current at designated AC charging stations. The charging process can be completed faster than at domestic socket outlets.

Depending on vehicle equipment and national-market version, a maximum charge current level of 16 A to 32 A is possible.

The charging cable may be permanently installed at the charging station.

The Mode 3 charging cable is also referred to as AC quick charging cable.

DC charging cable

The DC charging cable that is permanently installed at the charging station makes it possible to charge at DC charging stations. Charging is performed with direct current at designated DC charging stations. At the higher dimensioned electrical connection of a DC charging station, the charging time is normally substantially shorter compared to a domestic socket outlet or AC charging station.

While charging at a DC charging station, an indication in the instrument cluster is displayed.

Charge the vehicle only with a DC charging cable with a length less than 98 ft/30 m.

The DC charging cable is also referred to as Mode 4 charging cable.

Storage

For the outbound delivery, the charging cable is stowed in the cargo area, for instance under the cargo area floor or in a bag.

Stow charging cable after use in the same place again.

If the charging cable is stowed in a bag, fasten the bag at an open lashing eye in the cargo area.

Roll up the charging cable loosely and make sure that it is not damaged when stowed, e.g., cable becomes bent.

If required, store the charging cable with the connector cover attached in order to keep moisture out of the charging cable plug.

Connecting the charging cable

General information

Before connecting, if necessary clean the charging cable plug and the area between the charging socket flap and charging socket, e.g., remove snow.

Functional requirements

- ▷ Selector lever position P is engaged.
- ▷ The drive-ready state is switched off.
- ▷ The vehicle is unlocked.
- ▷ The parking brake is set.

Charging socket flap



The charging socket flap is located in the rear on the right side of the vehicle.

Keep charging socket clean and unobstructed.

If the charging socket is not being used, open the charging socket flap and, if necessary, keep the charging socket lid closed.

Connecting a charging cable

When charging at a charging station, follow the instructions on the charging station.

1. To open the charging socket flap, press on the rear edge, arrow.

The charging socket flap opens.



2. Open the charging socket cover.
3. Remove the cover of the charging cable connector, if needed.

4. Connect the Mode 2 charging cable to the domestic socket outlet or the Mode 3 charging cable to the port at the AC charging station as needed.
5. Insert the charging cable connector for the charging socket and push it in until it engages.
6. Hold the charging cable until it is correctly locked.

Removing the charging cable

General information

AC charging: The charging cable is locked while charging with the vehicle locked. Unlock the vehicle before removing.

Direct current charging: during the charging process, the charging cable is locked. When the charging process is completed, the charging cable is unlocked.

Before unplugging, clean the area between the charging socket flap and charging socket as necessary, for instance remove snow.

Disconnecting a charging cable

1. If necessary, unlock the vehicle or the charging cable via iDrive.

The charging process ends when the charging cable is unlocked via iDrive or at the charging station directly.

2. Press the release button on the handle, arrow 1, and grasp the charging cable at the gripping areas.

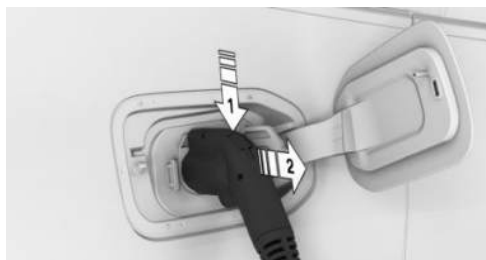

3. Detach the charging cable from the charging socket, arrow 2.
4. Close the charging power socket cover until it clicks into place.
5. Press the charging socket flap closed until it engages.
6. Attach cover of the charging cable connector, if needed.
7. Remove the mode 2 charging cable from the domestic socket outlet or the fast charging cable (mode 3) from the socket on the AC charging station as needed.
8. Stow the charging cable as required.

At a charging station, insert the permanently installed charging cable in the place provided for it.

Unlocking the charging cable

Principle

Depending on charging socket, when the vehicle is unlocked, the charging cable can be released using the button on the charging socket.

DC charging cable: the charging cable is unlocked via iDrive or by ending the charging process at the charging station.

Releasing the charging cable using the key



The charging cable release key is located next to the charging socket.

Unlocking charging cable via iDrive

Selecting unlock directly

Depending on the display on the control display, the function can be selected directly.



1. "Unlock charging cable now"
2. "Unlock charging cable now"

Unlocking via the menu

1.  Apps menu
2. "Vehicle"
3. "Charging"
4. "Unlock charging cable"
5. "Unlock charging cable now"
6. "Stop and unlock charging cable"

Additional settings for unlocking

1.  Apps menu
2. "Vehicle"
3. "Charging"
4. "Unlock charging cable"
5. Select the desired setting:
 - ▶ "Unlock AC charging cable at end of charging": The AC charging cables unlock automatically as soon as the charging process is finished.
 - ▶ "Unlock charging socket flap permanently": The charging socket flap can be kept unlocked so that it can be opened even when the vehicle is locked.

Charging process

Principle

The charging process can be adapted to constraints such as the cost of electricity, available current sources, or a low ambient temperature. The vehicle controls the charging process in

such a way that the charging process is completed if possible at the departure time. A departure time must be set for this purpose.

General information

High or low outside temperatures can cause longer charging times.

When charging the vehicle, a charge target can be set, thereby shortening the charging duration.

If the Mode 2 charging cable is exposed to high temperatures and direct sunlight, this may interrupt the charging process. Charging will resume automatically.

A charging procedure is canceled or not started due to the installation of a Remote Software Upgrade. The charging procedure may not continue automatically after the successful installation.

Safety information

NOTICE

The charging socket flap and charging socket cover may be damaged by strain. There is a risk of property damage. Do not strain the charging socket flap and charging socket cover, e.g., by dropping the charging cable.

Plug & Charge

Principle

With Plug & Charge, data from multiple charging contracts with different charging providers can be saved to the vehicle. At compatible charging stations, the vehicle automatically sends saved data to the charging station. This makes it easier to charge at public charging stations that are settled by charging contract. Once the charging cable is connected, charging can begin immediately.

General information

A contract with a charging service provider is usually required for public charging stations. To log in at the charging station, enter your contract information into the charging station, e.g., by using a charging card. With Plug & Charge, there is no need to manually log in at the charging station any more.

More information on Plug & Charge is provided in the My BMW App or online: www.bmwusa.com.

Functional requirements

Contract information is sent to the charging station under the following conditions:

- ▶ The charging contract must contain Plug & Charge and include the respective vehicle.
- ▶ The charging station must support Plug & Charge.
- ▶ Plug & Charge must be activated in the vehicle.

Saving contract information to the vehicle

To save contract information to the vehicle, proceed as follows:

1.  Apps menu
2. "Vehicle"
3. "Charging"
4. "Plug & Charge"
5. Select the desired setting.

Saved charging contracts are listed.

Activating/deactivating Plug & Charge

To activate/deactivate Plug & Charge, proceed as follows:

1.  Apps menu
2. "Vehicle"
3. "Charging"

4. "Plug & Charge"
5. Select the desired setting.

Using Plug & Charge

1. Before connecting the charging cable, make sure that Plug & Charge is activated in the vehicle and that the desired charging contract is selected.
2. Connect the charging cable.

Charging can be started immediately or will begin automatically. Follow any instructions given at the charging station.

Preparing the high-voltage battery

Principle

Charging at the optimal high-voltage battery temperature increases the charging power and decreasing the charging time.

General information

The battery heat management system prepares the high-voltage battery for upcoming charging at a DC charging station. The high-voltage battery temperature is adjusted during this process.

Battery thermal management can reduce range and increase energy consumption.

Functional requirement

The following requirements must be met for battery heat management system to activate automatically.

- ▶ BMW Navigation route guidance is activated.
- ▶ Sufficient remaining range.

Automatic activation

When guidance to a DC charging station is started, the high-voltage battery is pre-

heated/precooled as much as possible until the destination is reached.

1.  Apps menu
2. "Vehicle"
3. "Charging"
4. "Pre-condition battery"
5. Select the desired setting.

Additional information:

Destination input, see Owner's Manual for Navigation, Entertainment, Communication;

Activating/deactivating manually

The high-voltage battery preheating/precooling can be activated and deactivated manually.

1.  Apps menu
2. "Vehicle"
3. "Charging"
4. "Pre-condition battery"
5. Select the desired setting.

The availability of this function is affected by certain factors. Manual activation is not possible in the following situations, for example:

- ▶ The remaining range is too low.
- ▶ The high-voltage battery's charge is too high.
- ▶ Automatic preparation of the high-voltage battery is on.
- ▶ The vehicle is charging.

At low outside temperatures, preheating the high-voltage battery can take considerably longer.

Depending on vehicle equipment, the system can also be operated with the My BMW App on a smartphone.

Status display

The control display can show information on the temperature of the high-voltage battery and whether it is ready for DC charging.

1.  Apps menu
2. "Vehicle"
3. "Vehicle status"
4. "Battery temperature"

This information can be permanently displayed using the widgets.

Additional information:

- ▶ Vehicle status, refer to page 155.
- ▶ Widgets, refer to page 50.

Starting the charging process

1. Engage selector lever position P. Set the parking brake, if needed.
2. Set charging mode or schedule charging process.
Scheduling the charging process, see Charging in the time frame, refer to page 295.
3. Switch off drive-ready state.
4. Connect the Mode 2 charging cable to the domestic socket outlet or the Mode 3 charging cable to the port at the AC charging station as needed.
5. Connect the charging cable to the vehicle.
Connecting the charging cable, refer to page 289.
6. Lock vehicle if it is unlocked.

After the charging cable connector is plugged into the high-voltage charging socket, the charging cable is locked automatically.

Charging status display

Indicator light on the charging socket

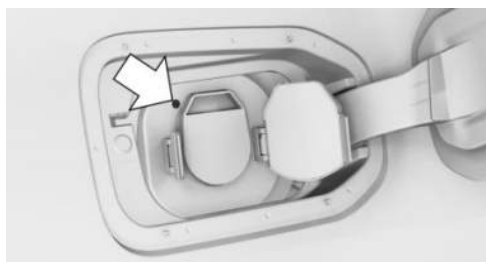

The charging status is indicated on the indicator light on the charging socket.

Charging status

Light	Meaning
White	Charging cable can be connected.
Yellow	Charging cable is locked.
Flashing yellow	Charging process is being prepared.
Blue	Charging process paused.
Flashing blue	Charging process is active.
Flashing red	Fault in the charging process.
Green	Charging process is complete.

When the vehicle is locked, the indicator light goes out after some time.

When the vehicle is unlocked, the blue indicator light flashes continuously. The other indicator lights turn off after some time.

 Press the button on the vehicle key to check the charging state. The charging status is indicated on the indicator light. In some cases the vehicle is locked.

Additional messages about charging status can be shown on the instrument cluster or on the mobile device using the My BMW App.

Setting the charging mode

1.  Apps menu
2. "Vehicle"
3. "Charging"
4. "Charging mode"
5. Select the desired settings:
 - ▶ "Immediately": the charging process starts as soon as the charging cable is connected.
 - ▶ "Time slot": If a departure time is set, a time frame for charging can be set, e.g., to charge using a cheap electricity rate.

Charging in the time frame

General information

A time frame can be set for the charging process, e.g., to charge with a cheap electricity rate.

The vehicle can also start the charging process before the selected time frame begins or end it after the selected time frame finishes. The starting point of the charging process is adjusted so the vehicle can be as fully charged as possible and, if applicable, its climate adjusted by the departure time.

Functional requirement

A departure time is defined.

Setting a time frame for charging

1.  Apps menu
2. "Vehicle"
3. "Charging"
4. "Charging mode"
5. "Time slot"
6. Select the desired setting.

Charge target

Principle

A target value in percent can be set for charging the high-voltage battery.

When a lower target value is set, the charging time may be shortened.

General information

A target value of 80 % is recommended for fast charging and optimal service life of the high-voltage battery.

Target values below 20 % cannot be set.

Set charge target

1.  Apps menu
2. "Vehicle"
3. "Charging"
4. "Charging target"
5. Select the desired setting.

Permissible volume of DC charging

When the vehicle is charged at a DC charging station, the noise emission during the charging process can be limited, for instance to comply with the local noise level restrictions. A limitation of the noise emission can lead to longer charging times.

1.  Apps menu
2. "Vehicle"
3. "Charging"
4. "Fan loudness"
5. Select the desired setting.

Stopping the charging process

The charging process can be stopped at any time by removing the charging cable and continued at a later time by connecting the charging cable. For example, so that other people can use the electrical connection in the mean-

time, or in order to avoid excessive strain on the electrical connection.

Additional information:

Detach, refer to page 290.

Continuing the charging process

If the charging process is interrupted, for instance due to a temporary power failure, the charging process will continue automatically after the interruption.

When the vehicle is charged at a public charging station, the charging process may not continue automatically after an interruption.

Ending the charging process

1. Remove the charging cable from the vehicle.
Detach, refer to page 290.
2. Stow the charging cable as required.
3. Press the charging socket flap closed until it engages.
4. Lock vehicle if it is unlocked.













Goodbye screen on control display

When drive-ready state is switched off, a menu is shown on the control display, in which, among other things, some settings can be applied for charging via iDrive.

Displays in the instrument cluster

If standby state is on, the charge state indicator on the instrument cluster shows the high-voltage battery charge.

Information regarding the charging process is shown on the charging screen.

Display	Meaning
	Charging the vehicle with a Mode 2 charging cable or Mode 3 charging cable.
	Charging the vehicle with a DC charging cable.
	Current charging capacity. + Icon indicates that the maximum charging capacity of the vehicle has been reached.
	Maximum charging current strength or currently set current limit.
	Charging cable locked.
	Charging cable unlocked.
	Set charge target.
	Departure time set.
	One-time departure time set.
	Air conditioning activated at departure time.
	Flashing: Pre-conditioning is turned on.
	Blue icon: Reduced charging power due to low temperature of high-voltage battery.
	White icon: Reduced charging power due to high temperature of high-voltage battery.

Display Meaning

The temperature of the high-voltage battery is adjusted for an upcoming charging process.

Preparing the high-voltage battery, refer to page [293](#)



Charging station charging power may be restricted or not available.

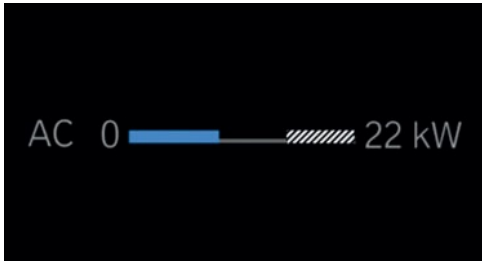

The shaded area indicates a limitation in the charging capacity that can occur, for instance due to the connected charging infrastructure.

Additional information:

- ▷ Charge state indicator, refer to page [154](#)
- ▷ Charging screen, refer to page [150](#).

Departure time

Principle

For optimum range and air conditioning, the departure time can be set before parking the vehicle.

General information

With a set departure time, the vehicle is pre-heated or pre-cooled if air conditioning is set.

The following settings are possible for departure time:

- ▷ Air conditioning for departure time.
- ▷ Scheduling of up to three regular departure times.
- ▷ Planning a one-time departure time.

Air conditioning for departure time

1.  Apps menu
2. "Vehicle"
3. "Charging"
4. "Departure plan"
5. "Pre-conditioning for departure"

Setting the departure time

1.  Apps menu
2. "Vehicle"
3. "Charging"
4. "Departure plan"
5. Select the desired departure time.
6. Set the time and weekday.

Activating the departure time

1.  Apps menu
2. "Vehicle"
3. "Charging"
4. "Departure plan"
5. Activate the desired departure time.

The set departure time will be deactivated if the departure time was ignored three times in a row.

Climate control

The following settings for vehicle air conditioning are possible:

- ▷ Activate pre-conditioning immediately.

The range will be reduced if pre-conditioning is activated without a charging cable connected.

- ▶ Planned air conditioning at the set departure time.

Additional information:

Pre-conditioning, refer to page [258](#).

Location-based charging settings

Principle

Various settings can be selected for charging at charging stations.

To simplify recharging at known charging locations, some changed settings such as charging mode can be saved based on location.

General information

When the function is activated, some settings are automatically saved as soon as the charging process is finished and the charging cable is disconnected.

The settings are saved based on the GPS coordinates of the charging location.

Saved settings are enabled as soon as the vehicle approaches a known charging location again.

Before charging, ensure that the settings enabled match the desired charging station, e.g., charging mode.

When the vehicle leaves a known charging location, the settings are automatically set to factory settings.

Functional requirement

To use the function, a GPS signal must be received.

Activate/deactivate the function

1. ■■ Apps menu
2. "Vehicle"
3. "Charging"
4. "Location-based charging settings"
5. "Save based on location"

If the function is deactivated, no location-based settings are saved and saved settings are not enabled.

Depending on vehicle equipment, the system can also be operated with the My BMW App on a smartphone.

Display on the control display



If the function is enabled, the icon indicates the location-based settings, which are automatically saved and enabled.

Saving active charging settings for other charging locations

The charging settings currently set in the menu can be saved as default settings for other charging locations.

1. ■■ Apps menu
2. "Vehicle"
3. "Charging"
4. "Location-based charging settings"
5. "Apply current settings for new locations"

Deleting location-based charging settings

1. ■■ Apps menu
2. "Vehicle"
3. "Charging"
4. "Location-based charging settings"
5. "Delete all location-based charging settings"

Discharged high-voltage battery and vehicle battery

General information

In addition to the high-voltage battery, the vehicle has a 12 volt vehicle battery, which is required for operation of the onboard electronics.

With a discharged vehicle battery, no operation of the vehicle is possible.

Service life of high-voltage battery

General information

The performance of the high-voltage battery, and thus the vehicle's range, decreases over its service life. The service life of the high-voltage battery can be optimized by how it is used.

Charging instructions

Charging habits have a significant effect on the high-voltage battery's service life:

- ▶ If the vehicle is stationary for long periods of time with a battery charge of over 80 %, this may negatively affect the battery's usable energy, charging time, and charging power during DC charging.
- ▶ Frequent DC charging with a charging power greater than 100 kW may negatively affect the battery's usable energy, charging time, and charging power during DC charging.
- ▶ If the vehicle has been charged several times in a row with DC, this system may temporarily reduce the charging power to protect the high-voltage battery. If reduced, the charging power is reset after a few hours. DC charging again can extend this time.

Optimizing the high-voltage battery's service life

Proper use can optimize the high-voltage battery's service life:

- ▶ Charge high-voltage batteries with a low charging capacity at an AC charging station or Wallbox.
- ▶ For daily use, operate the vehicle with a charge level between 10% and 80%. A charging target of 80% can be set for this. Charge target, refer to page 295.

- ▶ Recharge the high-voltage battery as close to a planned departure as possible. A time frame can be set for charging.

Charging in the time frame, refer to page 295.

- ▶ Reduce the load on the high-voltage battery by using an efficient, anticipatory driving style.

Increasing the range, refer to page 281.

- ▶ Avoid direct sunlight at high outside temperatures.

Long stationary periods, vehicle shutdown

If planning to leave the vehicle stationary for long periods of time, note the following:

- ▶ If the vehicle is to be stationary for more than 6 months, park the vehicle with a battery charge between 50 % and 80 %. Check the battery charge every 6 months.
- ▶ If the vehicle is stationary for less than 6 months, park the vehicle with a charge level between 30 % and 50 %.
- ▶ Do not park the vehicle for longer than 14 days if the electric range is depleted.
- ▶ Do not leave the charging cable connected.

Maintenance

The high-voltage battery is maintenance-free.

End of high-voltage battery service life

If unrestricted driving can no longer be ensured because the high-voltage battery is exhibiting very advanced aging, Check Control messages appear to indicate power and range restrictions.

The vehicle must be inspected by an authorized service center or another qualified service center or repair shop. If, in this case, no inspection is performed, it may no longer be possible to put the vehicle into operation.



A system error appears before it becomes impossible to put the vehicle into operation.

It is not necessary to interrupt the current trip, which can be ended as planned.

However, it will no longer be possible to continue driving the next time the vehicle is started.

Additional information:

- ▶ Check Control, refer to page [139](#).
- ▶ Indicator lights and warning lights, refer to page [140](#).

Wheels and tires

Vehicle features and options

This chapter describes model-specific equipment, systems, and functions that are currently available, or may become available in the future, even if they are not present in the vehicle.

Additional information:

Vehicle equipment, refer to page 8.

Tire pressure

General information

The tire condition and tire pressure influence the following:

- ▷ The service life of the tires.
- ▷ Driving safety.
- ▷ Driving comfort.
- ▷ Electrical consumption.

Safety information

Warning

A tire with too little or no tire inflation pressure may heat up significantly and sustain damage. This will have a negative impact on aspects of handling such as steering and braking response. There is a risk of accident, injury, and property damage. Regularly check the tire inflation pressure, and correct it as needed, for instance twice a month and before a long trip.

Tire pressure specifications

In the tire pressure table

The tire pressure table contains all tire inflation pressure specifications for given tire sizes

at ambient temperature. The tire inflation pressure specifications apply to the tire sizes approved by the vehicle manufacturer for the corresponding vehicle types.

To identify the correct tire inflation pressure, please note the following:

- ▷ Tire sizes of the vehicle.
- ▷ Maximum speed for driving.

On the control display

The current tire inflation pressure values and the intended tire inflation pressure values for the mounted tires can be displayed on the control display.

To ensure that they are displayed correctly, the tire sizes must be stored in the system and must have been set for the mounted tires.

The current tire inflation pressure value is located on each tire.

The reference tire inflation pressure value is located in the lower area of the control display.

Checking the tire pressure

General information

The tires heat up while driving. The tire pressure increases with the tire temperature.

Tires have a natural, consistent tire pressure loss.

The displays of inflation devices may under-read by up to 0.1 bar/2 psi.

Checking via tire inflation pressure specifications in tire pressure table

1. Determine the intended tire inflation pressure levels for the mounted tires.
2. Check the tire inflation pressure in all four tires, using a pressure gage, for example.

3. Correct the tire inflation pressure if the actual tire inflation pressure deviates from the intended tire inflation pressure.
4. Make sure that all valve caps are screwed onto the tire valves.

The tire inflation pressure specifications in the tire inflation pressure table only relate to cold tires or tires at the same temperature as the ambient temperature.

Only check the tire inflation pressure levels when the tires are cold, i.e.:

- ▷ A distance traveled of max. 1.25 miles/2 km has not been exceeded.
- ▷ If the vehicle has not moved again for at least two hours after a trip.

If equipped with an emergency wheel: check the tire pressure of the emergency wheel in the cargo area regularly and correct if necessary.

Checking using the tire inflation pressure specifications on the control display

1.  Apps menu
2. "Vehicle"
3. "Vehicle status"
4. "Tire Pressure Monitor"
5. Check whether the current tire inflation pressure levels deviate from the intended tire pressure value.
6. Correct the tire inflation pressure if the actual tire inflation pressure deviates from the intended tire inflation pressure.

The display of current tire pressure on the control display may be restricted when the vehicle is stationary. After a short drive, the tire pressure is updated.

After correcting the tire pressure

If equipped with a Tire Pressure Monitor, the corrected tire pressures are applied automatically. Make sure that the tire settings are correct. With tires that cannot be found in the tire

pressure values on the control display, reset the Tire Pressure Monitor (TPM).

If equipped with a flat tire monitor, reinitialize the flat tire monitor.

Tire inflation pressures up to 100 mph/160 km/h

For speeds of up to 100 mph/160 km/h and for optimum driving comfort, follow the tire inflation pressure specifications in the tire pressure table and adjust as necessary.



The tire inflation pressure specifications can also be found on the tire pressure label on the driver's door pillar.

Do not exceed a speed of 100 mph/160 km/h.

Tire pressure values up to 100 mph/160 km/h

i4 eDrive40, i4 eDrive35

Tire size	Pressure specifications in bar/PSI	
Specifications in bar/PSI with cold tires		
245/45 R 18 100 H XL M+S	2.5 / 36	3.0 / 44
225/50 R 18 99 W XL	2.6 / 38	3.1 / 45

Tire size	Pressure specifications in bar/PSI	
Front: 245/40 R 19 98 H XL A/S	2.5 / 36	-
Rear: 255/40 R 19 100 H XL A/S	-	3.0 / 44
Front: 245/40 R 19 98 Y XL	2.5 / 36	-
Rear: 255/40 R 19 100 Y XL	-	3.0 / 44
Front: 245/35 R 20 95 Y XL	2.5 / 36	-
Rear: HL 255/35 R 20 100 Y XL	-	3.0 / 44
Front: 245/40 R 19 98 V XL M+S	2.5 / 36	-
Rear: 255/40 R 19 100 V XL M+S	-	3.0 / 44

i4 xDrive40

Tire size	Pressure specifications in bar/PSI	
Specifications in bar/PSI with cold tires		
245/45 R 18 100 H XL M+S	2.5 / 36	3.0 / 44
225/50 R 18 99 W XL	2.6 / 38	3.1 / 45
Front: 245/40 R 19 98 H XL A/S	2.6 / 38	-
Rear: 255/40 R 19 100 H XL A/S	-	3.0 / 44

Tire size	Pressure specifications in bar/PSI	
Front: 245/40 R 19 98 Y XL	2.6 / 38	-
Rear: 255/40 R 19 100 Y XL	-	3.0 / 44
Front: 245/35 R 20 95 Y XL	2.9 / 42	-
Rear: HL 255/35 R 20 100 Y XL	-	3.0 / 44
Front: 245/40 R 19 98 V XL M+S	2.6 / 38	-
Rear: 255/40 R 19 100 V XL M+S	-	3.0 / 44

i4 M50

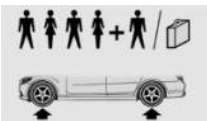
Tire size	Pressure specifications in bar/PSI	
Specifications in bar/PSI with cold tires		
245/45 R 18 100 H XL M+S	2.5 / 36	3.0 / 44
Front: 245/45 R 18 100 H XL A/S	2.4 / 35	-
Rear: 255/45 R 18 103 H XL A/S	-	2.7 / 39
Front: 245/40 R 19 98 H XL A/S	2.6 / 38	-
Rear: 255/40 R 19 100 H XL A/S	-	3.0 / 44
Front: 245/45 R 18 100 Y XL	2.4 / 35	-

Tire size	Pressure specifications in bar/PSI	
Rear: 255/45 R 18 103 Y XL	-	2.7 / 39
Front: 245/40 R 19 98 Y XL	2.6 / 38	-
Rear: 255/40 R 19 100 Y XL	-	3.0 / 44
Front: 255/35 R 20 97 Y XL	2.7 / 39	-
Front: 285/30 R 20 99 Y XL	-	3.1 / 45
Front: 245/35 R 20 95 Y XL	2.9 / 42	-
Rear: HL 255/35 R 20 100 Y XL	-	3.0 / 44
Front 245/40 R 19 98 W XL M+S	2.6 / 38	-
Rear: 255/40 R 19 100 W XL M+S	-	3.0 / 44

Tire pressures over 100 mph/160 km/h

 **Warning**

When driving at speeds greater than 100 mph/160 km/h, incorrect tire pressures can negatively affect vehicle handling, e.g., safety or comfort while driving. The tires can become damaged, which may cause an accident. There is a risk of accident, injury, and property damage. To drive at maximum speeds, note the specified tire pressure for driving above 100 mph/160 km/h in the tire inflation pressure table, and adjust as necessary.

Tire pressure values over 100 mph/160 km/h

i4 eDrive40, i4 eDrive35

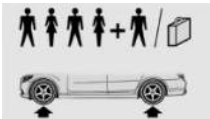
Tire size	Pressure specifications in bar/PSI	
Specifications in bar/PSI with cold tires		
245/45 R 18 100 H XL M+S	2.7 / 39	3.2 / 46
225/50 R 18 99 W XL	2.7 / 39	3.2 / 46
Front: 245/40 R 19 98 H XL A/S	2.7 / 39	-
Rear: 255/40 R 19 100 H XL A/S	-	3.2 / 46
Front: 245/40 R 19 98 Y XL	2.5 / 36	-
Rear: 255/40 R 19 100 Y XL	-	3.0 / 44
Front: 245/35 R 20 95 Y XL	2.5 / 36	-
Rear: HL 255/35 R 20 100 Y XL	-	3.0 / 44
Front: 245/40 R 19 98 V XL M+S	2.7 / 39	-
Rear: 255/40 R 19 100 V XL M+S	-	3.2 / 46

i4 xDrive40

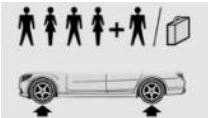
Tire size	Pressure specifications in bar/PSI	
Specifications in bar/PSI with cold tires		
225/50 R 18 99 W XL	2.8 / 41	3.3 / 48
245/45 R 18 100 H XL M+S		
Front: 245/40 R 19 98 H XL A/S	2.9 / 42	-
Rear: 255/40 R 19 100 H XL A/S	-	3.3 / 48
Front: 245/40 R 19 98 Y XL	2.6 / 38	-
Rear: 255/40 R 19 100 Y XL	-	3.0 / 44
Front: 245/35 R 20 95 Y XL	2.9 / 42	-
Rear: HL 255/35 R 20 100 Y XL	-	3.0 / 44
Front: 245/40 R 19 98 V XL M+S	2.9 / 42	-
Rear: 255/40 R 19 100 V XL M+S	-	3.3 / 48

i4 M50

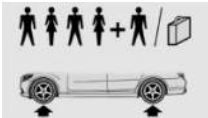
Tire size	Pressure specifications in bar/PSI	
Specifications in bar/PSI with cold tires		
245/45 R 18 100 H XL M+S	2.8 / 41	3.3 / 48
Front: 245/45 R 18 100 H XL A/S	2.6 / 38	-
Rear: 255/45 R 18 103 H XL A/S	-	2.9 / 42
Front: 245/40 R 19 98 H XL A/S	2.9 / 42	-
Rear: 255/40 R 19 100 H XL A/S	-	3.3 / 48
Front: 245/45 R 18 100 Y XL	2.5 / 36	-
Rear: 255/45 R 18 103 Y XL	-	2.7 / 39
Front: 245/40 R 19 98 Y XL	2.7 / 39	-
Rear: 255/40 R 19 100 Y XL	-	3.0 / 44
Front: 255/35 R 20 97 Y XL	2.7 / 39	-
Front: 285/30 R 20 99 Y XL	-	3.2 / 46
Front: 245/35 R 20 95 Y XL	2.9 / 42	-
Rear: HL 255/35 R 20 100 Y XL	-	3.0 / 44

Tire size	Pressure specifications in bar/PSI	
Front 245/40 R19 98 W XL M+S	2.9 / 42	-
Rear: 255/40 R19 100 W XL M+S	-	3.3 / 48

Designation	Maximum speed
H	up to 131 mph/210 km/h
V	up to 150 mph/240 km/h
W	up to 167 mph/270 km/h
Y	up to 186 mph/300 km/h
(Y)	above 186 mph/300 km/h

Tire marking

Tire size

245/45 R 18 96 Y

245: nominal width in mm

45: cross-sectional relationship in %

R: radial tire code

18: rim diameter in inches

96: load index

Y: speed code letter

ZR tires: reinforced radial tire for speeds exceeding 150 mph/240 km/h

Maximum tire load

Maximum tire load is the maximum permissible weight for which the tire is approved.

Locate the maximum tire load on the tire sidewall and the Gross Axle Weight Rating – GAWR – on the certification label on the driver door B-pillar. Divide the tire load by 1.1. It must be greater than one-half of the vehicle's Gross Axle Weight Rating – GAWR. Note, front vs. rear GAWR and tire loads, respectively.

Speed letter

Designation	Maximum speed
Q	up to 100 mph/160 km/h
R	up to 106 mph/170 km/h
S	up to 112 mph/180 km/h
T	up to 118 mph/190 km/h

Tire Identification Number

DOT code: DOT xxxx xxx 1924

xxxx: manufacturer code for the tire brand

xxx: tire size and tire design

1924: tire age

Tires with DOT codes meet the guidelines of the U.S. Department of Transportation.

Tire age

Recommendation

Regardless of the tire tread depth, replace tires at least every 6 years.

Production date

You can find the tire production date on the tire sidewall.

Designation	Production date
DOT ... 1924	19th week of 2024

Uniform Tire Quality Grading

Quality grades can be found where applicable on the tire sidewall between tread shoulder and maximum section width.

E.g.: Treadwear 200; Traction AA; Temperature A

DOT Quality Grades

Treadwear

Traction AA A B C

Temperature A B C

All passenger vehicle tires must conform to Federal Safety Requirements in addition to these grades.

Treadwear

The treadwear grade is a comparative rating based on the wear rate of the tire when tested under controlled conditions on a specified government test course. E.g., a tire graded 150 would wear one and one-half, 1 g, times as well on the government course as a tire graded 100. The relative performance of tires depends upon the actual conditions of their use, however, and may depart significantly from the norm due to variations in driving habits, service practices and differences in road characteristics and climate.

Traction

The traction grades, from highest to lowest, are AA, A, B, and C.

Those grades represent the tire's ability to stop on wet pavement as measured under controlled conditions on specified government test surfaces of asphalt and concrete. A tire marked C may have poor traction performance.

The traction grade assigned to this tire is based on straight-ahead braking traction tests, and does not include acceleration, cornering, hydroplaning, or peak traction characteristics.

Temperature

The temperature grades are A, the highest, B, and C, representing the tire's resistance to the generation of heat and its ability to dissipate heat when tested under controlled conditions on a specified indoor laboratory test wheel. Sustained high temperature can cause the material of the tire to degenerate and reduce tire life, and excessive temperature can lead to sudden tire failure. The grade C corresponds to a level of performance which all passenger

car tires must meet under the Federal Motor Vehicle Safety Standard No. 109. Grades Band A represent higher levels of performance on the laboratory test wheel than the minimum required by law.

Warning

The temperature grade for this tire is established for a tire that is properly inflated and not overloaded. Excessive speed, underinflation, or excessive loading, either separately or in combination, can cause heat buildup and possible tire failure. There is a risk of accident, injury, and property damage.

Runflat tires

Runflat tires, refer to page 311, are labeled with a circular icon containing the letters RSC marked on the tire sidewall.

M+S

Winter tires, as well as all-season tires with better winter performance than summer tires, can be identified by the M+S marking on the tire side wall.

Tire tread

Safety information

Warning

If the tire tread depth is too low, driving safety may be impaired in critical situations such as aquaplaning or slush on the road. There is a risk of accident, injury, and property damage. The tire tread depth may not fall below 0.12 in/3 mm for summer tires and 0.16 in/4 mm for winter and all-season tires, or observe the statutory regulations on minimum tread depth.

Minimum tread depth



The tire manufacturer's wear indicators are distributed over the tire circumference. These indicators have a height of min. 0.06 in/1.6 mm and serve as an indicator for tire tread wear.

The positions of the wear indicators are marked on the tire sidewall with TWI, Tread Wear Indicator.

Tire damage

General information

Check your tires regularly for damage, foreign objects lodged in the tread, and tread wear.

Indications of tire damage or another vehicle malfunction:

- ▷ Unusual vibrations.
- ▷ Unusual tire or running noises.
- ▷ Unusual vehicle handling such as a strong tendency to pull to the left or right.
- ▷ Uneven wear pattern, e.g., increased wear in the area of the tire shoulder.

Damage can be caused by the following situations, for instance:

- ▷ Driving over curbs.
- ▷ Road damage.
- ▷ Tire pressure too low.
- ▷ Vehicle overloading.
- ▷ Incorrect tire storage.

Safety information

Warning

Damaged tires can lose tire inflation pressure, which can lead to loss of vehicle control. There is a risk of accident, injury, and property damage. If tire damage is suspected while driving, immediately reduce speed and stop. Have wheels and tires checked. To do so, drive carefully to an authorized service center or another qualified service center or repair shop. Have the vehicle towed or transported as needed. Do not repair damaged tires, but have them replaced.

Warning

The wheels, tires and chassis components can become damaged when driving over curbs, road damage, or other obstacles. Larger wheels have a smaller tire cross-section. The smaller the tire cross-section, the higher the risk of tire damage. There is a risk of accident, injury, and property damage. If possible, avoid driving over curbs, road damage or other obstacles, or drive over them slowly and carefully.

Exchanging wheels and tires

Mounting and wheel balancing

Have the wheel mounted and balanced by an authorized service center or another qualified service center or repair shop.

Suitable wheels and tires

General information

Only certain wheel/tire combinations are suitable depending on vehicle and equipment.

The vehicle manufacturer determines wheel/tire combinations on the basis of the following criteria:

- ▷ Tire size, e.g., tire width, aspect ratio.
- ▷ Wheel size, e.g., rim diameter, offset.

For more information on wheel/tire combinations and special equipment, contact an authorized service center or another qualified service center or repair shop.

Safety information

Warning

Wheels and tires that are not suitable for the vehicle can damage parts of the vehicle. There is a risk of accident, injury, and property damage. The vehicle manufacturer recommends that you use only wheels and tires that have been recommended for the vehicle type.

Warning

Mounted steel wheels can cause technical problems, for instance unexpected loosening of the lug bolts and damage to the brake disks. There is a risk of accident, injury, and property damage. Do not mount steel wheels.

Warning

Wheel/tire combinations that are not suitable for the vehicle can affect vehicle handling and a number of system functions, e.g., the Antilock Braking System or Dynamic Stability Control. There is a risk of accident, injury, and property damage. The manufacturer of the vehicle recommends that you use wheels and tires that have been recommended by the vehicle manufacturer for the vehicle type. Following tire damage, have the original wheel/

tire combination remounted on the vehicle as soon as possible.

Recommended tire brands



Tire types are developed for each vehicle and optimized specifically for the individual requirements of that vehicle, e.g.:

- ▷ Vehicle handling.
- ▷ Comfort.
- ▷ Noise characteristics.

Specially developed tires are marked with a star on the tire sidewall. After replacing wheels and tires, the vehicle manufacturer recommends using star-marked tires again. The vehicle manufacturer recommends that you use tires of the same make and tread design.

New tires

Tire traction is not optimal due to manufacturing circumstances when tires are brand new.

Drive conservatively for the first 200 miles/300 km.

Retreaded tires

Warning

Retreaded tires can have different tire casing structures. With advanced age the service life can be limited. There is a risk of accident, injury, and property damage. The manufac-

turer of the vehicle does not recommend the use of retreaded tires.

Maximum speed

Safety information

Warning

If the maximum permissible speed of your mounted tires is exceeded, the tires may be damaged. There is a risk of accident, injury, and property damage. Do not exceed the maximum permissible speed of the tires.

Maximum speed of winter tires

If the maximum speed of the vehicle is higher than the maximum permissible speed of the winter tires, the maximum permissible speed must be indicated with a sign placed in the field of vision. The info label is available from an authorized service center or another qualified service center or repair shop.

Winter tires



Winter tires are recommended for operating on winter roads.

Winter tires can be identified by the mountain/snowflake icon and the letters M+S on the tire sidewall.

So-called all-season tires with M+S marking but without mountain and snowflake icon have better winter properties than summer tires.

As a rule, all-season tires do not perform the same as winter tires.

Changing runflat tires

When changing from runflat tires to standard tires, it must be ensured that the vehicle contains an emergency wheel or tire mobility kit. For more information, contact an authorized service center or another qualified service center or repair shop.

Wheel change between axles

Warning

A wheel change between the axles on vehicles with different tire sizes or rim sizes on the front and rear axles can cause damage to the tires and the vehicle. There is a risk of accident, injury, and property damage. Do not rotate the tires between the axles on vehicles with different tire sizes or rim sizes on the front and rear axles.

Different abrasion patterns can occur on the front and rear axles depending on individual driving conditions. The tires can be rotated in pairs between the axles to achieve even abrasion. For more information, contact an authorized service center or another qualified service center or repair shop. After changing, check the tire pressure and correct, if needed.

Storing tires

Tire pressure

Do not exceed the maximum tire inflation pressure indicated on the tire sidewall.

Storage

- ▶ Store wheels and tires in a cool, dry and dark place.
- ▶ Always protect tires against all contact with oil, grease, and solvents.

- ▷ Do not leave the tires in plastic bags.
- ▷ Remove dirt from wheels or tires.

Runflat tires

Principle

Runflat tires permit continued driving under limited conditions even in the event of a complete tire pressure loss.

General information

The wheels consist of tires that are self-supporting to a limited degree and may also include special rims.

The reinforcement of the sidewall allows the tire to remain drivable to a limited degree in the event of a tire pressure loss.

Follow the instructions for continued driving with a flat tire.

Safety information

Warning

The vehicle handles differently when a runflat tire has insufficient or no tire pressure; for instance, reduced directional stability when braking, braking distances are longer and the self-steering properties will change. There is a risk of accident, injury, and property damage. Drive moderately and do not exceed a speed of 50 mph/80 km/h.

Warning

Vibrations or loud noises while driving can indicate the final failure of a tire. Tire components may come loose. There is a risk of accident, injury, and property damage. Reduce your speed and stop. Do not continue driving. Contact an authorized service center or another qualified service center or repair shop.

Identification



Runflat tires are labeled with a circular icon containing the letters RSC marked on the tire sidewall.

Repairing a flat tire

Safety precautions

- ▷ Park the vehicle on solid and non-slip ground at a safe distance from road traffic.
- ▷ Turn on the hazard warning system.
- ▷ Set the parking brake.
- ▷ Turn the steering wheel until the front wheels are in the straight-ahead position and engage the steering wheel lock.
- ▷ As soon as permitted by the traffic flow, have all vehicle occupants get out and make sure that they remain outside the hazardous area such as behind a guardrail.
- ▷ If necessary, set up the hazard triangle or hazard warning lights at an appropriate distance.

Tire repair set

Principle

The tire repair set is used to temporarily seal minor tire damage so that it is possible to continue driving.

General information

- ▶ The filled in tire sealant closes the damage from the inside when it hardens.
- ▶ Follow the instructions for using the tire repair set, which are provided on the compressor and sealant bottle.
- ▶ The tire repair set may be insufficient if the tire damage measures more than approx. 0.16 in/4 mm.
- ▶ Do not remove foreign objects that have penetrated the tire. Remove foreign objects only when they are visibly protruding from the tire.
- ▶ The compressor can be used to check the tire inflation pressure.

Overview

Storage

Depending on vehicle equipment, the tire repair set is stored as follows:

- ▶ In the cargo area under the cargo area floor.
- ▶ In the cargo area on the left or right side.
- ▶ In the cargo area behind a side trim panel.

Sealant bottle and filler hose



- 1 Sealant bottle
- 2 Sealant bottle outlet
- 3 Filler hose
- 4 Sealant bottle connection
- 5 Wheel valve connection

Compressor

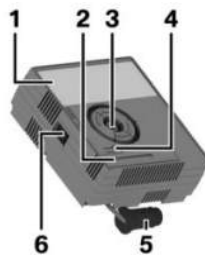

- 1 Compressor
- 2 Tire pressure display
- 3 Sealant bottle mount
- 4 Pressure reducing valve button
- 5 Connector for socket
- 6 Power switch

Safety precautions

- ▶ Park the vehicle as far away as possible from passing traffic and on solid ground.
- ▶ Turn on the hazard warning system.
- ▶ Set the parking brake.
- ▶ Turn the steering wheel until the front wheels are in the straight-ahead position and engage the steering wheel lock.
- ▶ As soon as permitted by the traffic flow, have all vehicle occupants get out and make sure that they remain outside the hazardous area such as behind a guardrail.
- ▶ If necessary, set up the hazard triangle or hazard warning lights at an appropriate distance.
- ▶ Remove the warning label for the maximum permissible speed from the sealant bottle and attach it in the visible area in the vehicle interior.

Preparing the tire repair set

1. Insert the sealant bottle into the mount on the housing of the compressor.



2. Turn the sealant bottle clockwise by 90° to the stop.

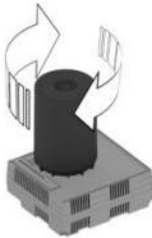

3. Connect the filler hose to the outlet of the sealant bottle and turn clockwise by 90° to the stop.



4. Unscrew the valve cap on the wheel.

5. Screw the filler hose connector clockwise onto the valve.

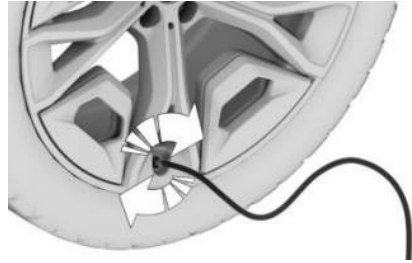

6. With the compressor switched off, insert the connector into the power socket in the vehicle interior.

Filling the tire with sealing compound

Safety information

NOTICE

The compressor can overheat during extended operation. There is a risk of property damage. Do not run the compressor for more than 10 minutes.

Filling the tire with sealing compound

1. With standby state or drive-ready state on, turn on the compressor on the device.
Let the compressor run for max. 10 minutes to fill in the tire sealant and reach a tire pressure of 2.5 bar/36 psi.
While the tire is being filled with tire sealant, the tire pressure can briefly reach approx. 6 bar/87 psi. Do not turn off the compressor in this phase.
2. Turn off the compressor on the device.

Checking the tire pressure

Read the tire pressure on the tire pressure display of the compressor. The tire pressure must be at least 2.5 bar/36 psi.

Tire pressure too high

If the tire pressure is too high, reduce the tire pressure with the pressure reducing valve on the compressor.

Minimum tire inflation pressure is not reached

Do not continue driving unless a minimum tire pressure of 2.5 bar/36 psi is reached. Contact an authorized service center or another qualified service center or repair shop.

Minimum tire inflation pressure is reached

1. Pull the connector out of the socket in the vehicle interior.
2. Disconnect the filler hose from the sealant bottle and the valve on the wheel.
3. Screw the valve cap onto the valve.
4. Stow the tire repair set in the cargo area.
5. Immediately drive 6 miles/10 km to ensure that the tire sealant is evenly distributed in the tire.

Do not exceed the speed limit of 50 mph/80 km/h.

If possible, do not drive at speeds less than 12 mph/20 km/h.

Tire sealant may spray from the damaged area during the initial wheel rotations.

Adjusting the tire pressure

1. Stop at a suitable location.
2. Connect the filler hose directly to the compressor, then turn it clockwise 90° in the mount until it engages audibly.
3. Unscrew the valve cap on the wheel.

4. Screw the filler hose connector onto the valve.

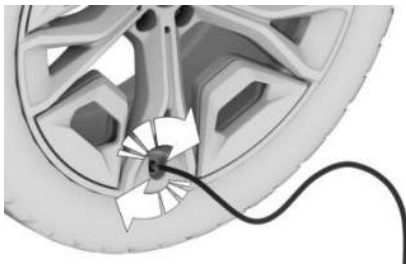

5. Insert the connector into the socket in the vehicle interior.
6. Read the tire pressure on the tire pressure display of the compressor.

Do not continue driving unless a minimum tire pressure of 1.3 bar/19 psi is displayed. Contact an authorized service center or another qualified service center or repair shop.
7. Correct the tire pressure to 2.5 bar/36 psi.
 - ▶ Increase tire pressure: with standby or drive-ready state turned on, turn on the compressor and let it run for a maximum of 10 minutes.
 - ▶ Reduce tire pressure: Press the pressure reducing valve button on the compressor.

Removing and stowing the tire repair set

1. Switch off the compressor.
2. Pull the connector out of the socket in the vehicle interior.
3. Disconnect the filler hose from the compressor and the valve on the wheel.
4. Screw the valve cap onto the valve.
5. Stow the tire repair set together with the filler hose in the cargo area.

Continuing the trip

Re-initialize the flat tire monitor or reset the Tire Pressure Monitor.

Do not exceed the speed limit of 50 mph/80 km/h.

Do not exceed a maximum distance traveled of 125 miles/200 km.

Replace the faulty tire and the sealant bottle from the tire repair set as soon as possible.

Additional information:

- ▶ Flat tire monitor, refer to page [323](#).
- ▶ Tire pressure monitor, refer to page [316](#).

System limits

If the tire cannot be made drivable, contact an authorized service center or another qualified service center or repair shop.

With Tire Pressure Monitor: Using sealant can damage the air pressure sensor. In this case, have the electronics checked and replaced at the next opportunity.

Snow chains

Safety information

Warning

Mounting snow chains on unsuitable tires can cause the snow chains to come into contact with vehicle parts. There is a risk of accident, injury, and property damage. Only fit snow chains on tires recommended by the vehicle manufacturer for use with snow chains.

Warning

Insufficiently tight snow chains may damage tires and vehicle components. There is a risk of accident, injury, and property damage. Make sure that the snow chains are always sufficiently tight. Re-tighten as needed according to the snow chain manufacturer's instructions.

Fine-link snow chains

The manufacturer of the vehicle recommends the use of fine-link snow chains. Certain types of fine-link snow chains have been tested by the manufacturer of the vehicle and recommended as road-safe and suitable.

For information on suitable snow chains, contact an authorized service center or another qualified service center or repair shop.

Use

Use is only permitted in pairs on rear wheels equipped with the tires of the following wheel/tire sizes:

Tire size	Wheel size	Rim offset (IS)
245/45 R18	8.5J x 18	36

Information on the wheel size and rim offset is located on the inside of the wheel.

The list can also include wheel/tire sizes that are only suitable for certain models.

Information on wheels and tires approved for the vehicle can be requested from an authorized service center or another qualified service center or repair shop.

Follow the snow chain manufacturer's instructions.

If vehicle is equipped with Tire Pressure Monitor: When using snow chains, do not reset the Tire Pressure Monitor, otherwise, incorrect values may be displayed.

If vehicle is equipped with flat tire monitor: When using snow chains, do not initialize the flat tire monitor, otherwise, incorrect values may be displayed.

When driving with snow chains, activate the Dynamic Traction Control briefly to optimize the drive power.

Maximum speed with snow chains

Do not exceed a speed of 30 mph/50 km/h when using snow chains.

Tire pressure monitor

Principle

The Tire Pressure Monitor monitors the tire pressure and issues a warning if the tire pressure has dropped.

General information

Sensors in the tire valves measure the tire inflation pressure and tire temperature.

Depending on the tires detected or registered, the system displays the specified nominal pressures on the control display and compares them with the current tire pressures.

If tires are being used that are not specified in the tire inflation pressure details on the vehicle such as tires with special approval, the system needs to be actively reset. The system will then take over the actual tire inflation pressures as the target pressures.

When operating the system, also note the information found in the Tire inflation pressure chapter.

Additional information:

Tire inflation pressure, refer to page [301](#).

Safety information

Warning

The display of the target pressures is not a substitute for the tire inflation pressure details on the vehicle. Incorrect entries in the tire settings can lead to incorrect target tire inflation pressure values. In this case, it cannot be guaranteed that the notification of a tire pressure loss will be reliable. There is a risk of injury and risk of property damage. Make sure that the sizes of your mounted tires are displayed correctly and match the information on the tires and the tire inflation pressure specifications on the vehicle.

Functional requirements

The following prerequisites must be met for the system; otherwise, reliable notification of a tire pressure loss is not assured:

- ▶ After each tire or wheel change, the system detects and updates the mounted tires on the control display and displays them after a short trip.
 - Enter the information about the mounted tires in the tire settings when the system does not automatically detect the tires.
- ▶ The Tire Pressure Monitor does not activate until after driving for a few minutes:
 - ▶ After a tire or wheel change.
 - ▶ After a reset, when using tires with special approval.
 - ▶ After changing the tire setting.
- ▶ For tires with special approval:
 - ▶ After a tire or wheel change, a reset was performed with the correct tire inflation pressure.
 - ▶ After the tire inflation pressure was adjusted to a new value, a reset was performed.
- ▶ Wheels with air pressure sensor.

Tire settings

General information

The information about the mounted tires can be entered in the tire settings if the system does not automatically detect the tires.

The tire sizes of the mounted tires can be gathered from the tire inflation pressure details on the vehicle or directly on the tires.

The tire details do not need to be re-entered when the tire pressure is corrected.

For summer and winter tires, the tire details entered last are stored. After a tire or wheel change, the settings of the tire sets used last can be selected.

Adjusting the tires

1.  Apps menu
2. "Vehicle"
3. "Vehicle status"
4. "Tire Pressure Monitor"
5. "Tire settings"
6. "Tire selection"
7. "Manual"
8. "Tire type"
9. Select the tire size for the rear axle.
For tires with special approval:
"Other tires"
Observe further proceeding in the perform a reset section.
10. Select the maximum speed to be driven.
11. "Save tire settings"

The measurement of the current tire inflation pressure is started. The measurement progress is displayed.

Status display

Current status

The system status can be displayed on the control display, e.g., whether or not the system is active.

1.  Apps menu
2. "Vehicle"
3. "Vehicle status"
4. "Tire Pressure Monitor"

The current status is displayed.

Current tire pressure

The current tire pressure is displayed for each tire.

The current tire inflation pressures may change while driving or depending on the outside temperature.

Current tire temperature

The current tire temperatures are displayed depending on the model.

The current tire temperatures may change while driving or due to the outside temperature.

Nominal pressure

The nominal pressure for the tires on the front and rear axles is displayed.

The specified nominal pressures take the influence of driving and outside temperature on the tire temperature into account. The appropriate nominal pressure is always displayed, independent of the weather situation, tire temperatures and travel times.

The displayed nominal pressure may change and may differ from the tire inflation pressure details on the door pillar of the driver's door. The tire inflation pressure can thus be corrected to the value of the displayed target pressures.

The nominal pressure is immediately adjusted if the vehicle load state is changed in the tire settings.

Tire conditions

General information

Tire and system status are indicated by the color of the wheels and a text message on the control display.

Any existing messages may not be deleted if the nominal pressure is not reached after the tire inflation pressure is corrected.

All wheels green

- ▶ The system is active and bases warnings on the target pressures.
- ▶ For tires with special approval: the system is active and bases warnings on the tire inflation pressures stored during the last reset.

One to four yellow wheels

A flat tire or major tire pressure loss has occurred in the indicated tires.

Gray wheels

It may not be possible to identify tire pressure losses.

Possible causes:

- ▷ Malfunction.
- ▷ During tire inflation pressure measurement, after confirmation of the tire settings.
- ▷ For tires with special approval: a reset is performed for the system.

For tires with special approval: performing a reset

1.  Apps menu
2. "Vehicle"
3. "Vehicle status"
4. "Tire Pressure Monitor"
5. Make sure that the tire settings are correct. Tire settings, refer to page 316.
6. Turn on drive-ready state and do not drive off.
7. "Perform reset".
8. Drive off.

The wheels are shown in gray and the tire pressure is reset.

After a travel time of several minutes, the set tire inflation pressures are accepted as the predefined tire inflation pressures. The reset is completed automatically while driving.

After resetting, the wheels are shown in green on the control display and a message appears.

You may interrupt this trip at any time. When you continue driving the reset resumes automatically.

Messages: for tires without special approval

General information

When a flat tire is indicated, the Dynamic Stability Control may be turned on.

Safety information

Warning

A damaged regular tire with low or no tire inflation pressure impacts handling such as steering and braking response. Runflat tires can maintain limited stability. There is a risk of accident, injury, and property damage. Do not continue driving if the vehicle is equipped with normal tires. Follow the information on runflat tires and continued driving with these tires.

If a tire inflation pressure check is required

Message

An icon with a Check Control message appears on the control display.

Icon	Possible cause
	Leak detected on the tire. Inflation was not carried out according to specifications, for instance when the tire has not been sufficiently inflated or in the case of a natural steady tire pressure loss.

Measure

Check the tire pressure and correct as needed.

If the tire inflation pressure is too low

Message



A yellow warning light is illuminated in the instrument cluster.

In addition, an icon with a Check Control message appears on the control display.

Icon	Possible cause
	There is a tire pressure loss.

Measure

1. Reduce the vehicle speed. Do not exceed a speed of 80 mph/130 km/h.
2. At the next opportunity, for instance at a filling station, check the tire inflation pressure in all four tires and correct if necessary.

If there is a significant tire pressure loss

Message



A yellow warning light is illuminated in the instrument cluster.

In addition, an icon with the affected tire appears in a Check Control message on the control display.

Icon	Possible cause
	There is a flat tire or a major tire pressure loss.

Measure

1. Reduce your speed and stop cautiously. Avoid sudden braking and steering maneuvers.
2. Check whether the vehicle is fitted with standard tires or runflat tires.

Runflat tires are labeled with a circular icon containing the letters RSC marked on the tire sidewall.

Runflat tires, refer to page 311.

3. Read the description on what to do in case of a flat tire.

Actions in the event of a flat tire, refer to page 321.

Messages: for tires with special approval

General information

When a flat tire is indicated, the Dynamic Stability Control may be turned on.

Safety information

Warning

A damaged regular tire with low or no tire inflation pressure impacts handling such as steering and braking response. Runflat tires can maintain limited stability. There is a risk of accident, injury, and property damage. Do not continue driving if the vehicle is equipped with normal tires. Follow the information on runflat tires and continued driving with these tires.

If a tire inflation pressure check is required

Message

An icon with a Check Control message appears on the control display.

Icon	Possible cause
------	----------------



Inflation was not carried out according to specifications, e.g., the tire has not been sufficiently inflated.

The system has detected a wheel change, but no reset was done.

The tire inflation pressure has fallen below the level of the last reset.

No reset was performed for the system. The system issues a warning based on the tire inflation pressures stored during the last reset.

Measure

1. Check the tire pressure and correct as needed.
2. Perform a system reset.

If the tire inflation pressure is too low

Message



A yellow warning light is illuminated in the instrument cluster.

In addition, an icon with a Check Control message appears on the control display.

Icon	Possible cause
------	----------------



There is a tire pressure loss.
No reset was performed for the system. The system issues a warning based on the tire inflation pressures stored during the last reset.

Measure

1. Reduce the vehicle speed. Do not exceed a speed of 80 mph/130 km/h.
2. At the next opportunity, for instance at a filling station, check the tire inflation pressure in all four tires and correct if necessary.
3. Perform a system reset.

If there is a significant tire pressure loss

Message



A yellow warning light is illuminated in the instrument cluster.

In addition, an icon with the affected tire appears in a Check Control message on the control display.

Icon	Possible cause
------	----------------



There is a flat tire or a major tire pressure loss.

No reset was performed for the system. The system issues a warning based on the tire inflation pressures stored during the last reset.

Measure

1. Reduce your speed and stop cautiously. Avoid sudden braking and steering maneuvers.
2. Check whether the vehicle is fitted with standard tires or runflat tires.
Runflat tires are labeled with a circular icon containing the letters RSC marked on the tire sidewall.
Runflat tires, refer to page 311.
3. Read the description on what to do in case of a flat tire.
Actions in the event of a flat tire, refer to page 321.

Actions in the event of a flat tire

Standard tires

1. Identify the damaged tire.

Check the tire pressure in all four tires, for instance using the tire pressure display of a flat tire kit.

For tires with special approval: when the tire pressure in all four tires is correct, the Tire Pressure Monitor may not have been reset. In this case, perform the reset.

If no tire damage can be identified, contact an authorized service center or another qualified service center or repair shop.

2. Repair the flat tire, e.g., with a flat tire kit or by changing the wheel.

Using sealant, e.g., from the flat tire kit, may damage the air pressure sensor. Replace the air pressure sensor at the next opportunity.

Runflat tires

Safety information

Warning

The vehicle handles differently when a runflat tire has insufficient or no tire pressure; for instance, reduced directional stability when braking, braking distances are longer and the self-steering properties will change. There is a risk of accident, injury, and property damage. Drive moderately and do not exceed a speed of 50 mph/80 km/h.

Warning

Vibrations or loud noises while driving can indicate the final failure of a tire. Tire components may come loose. There is a risk of accident, injury, and property damage. Reduce your speed and stop. Do not continue driving.

Contact an authorized service center or another qualified service center or repair shop.

Maximum speed

You may continue driving with a damaged tire at speeds up to 50 mph/80 km/h.

Continued driving with a flat tire

Follow the following when continuing to drive with a damaged tire:

1. Avoid sudden braking and steering maneuvers.
2. Do not exceed a speed of 50 mph/80 km/h.
3. Check the tire inflation pressure in all four tires at the next opportunity.

Possible driving distance with a flat tire

The possible driving distance which may be safely traveled varies depending on how the vehicle is loaded and used, e.g., speed, road conditions, outside temperature. The distance traveled may be less but may also be more if an economical driving style is used.

If the vehicle is loaded with an average weight and used under favorable conditions, the possible distance traveled may be up to 50 miles/80 km.

Vehicle handling with damaged tires

Vehicles driven with a damaged tire will handle differently, potentially leading to conditions such as the following:

- ▶ Greater likelihood of skidding of the vehicle.
- ▶ Longer braking distances.
- ▶ Changed self-steering properties.

Modify your driving style. Avoid abrupt steering or driving over obstacles, for instance curbs or potholes.

System limits

Temperature

The tire inflation pressure depends on the tire's temperature.

Driving or exposure to the sun will increase the tire temperature, thus increasing the tire inflation pressure.

The tire inflation pressure is reduced when the tire temperature falls again.

These circumstances may cause a warning when temperatures fall very sharply.

Following a temperature-related warning, the target pressures are displayed on the control display again after a short distance.

Sudden tire pressure loss

The system cannot indicate sudden and serious tire damage caused by external circumstances.

Failure performing a reset

Tires with special approval: the system will not function correctly if a reset was not performed, for example a flat tire may be indicated although the tire inflation pressures are correct.

Malfunction

Message



The yellow warning light flashes and is then illuminated continuously. A Check Control message is displayed. It may not be possible to identify tire pressure losses.

Measure

- ▶ A wheel without air pressure sensor is mounted: Have the wheels checked as needed.
- ▶ Fault caused by systems or devices with the same transmission frequency: The sys-

tem automatically reactivates after leaving the area of the interference.

- ▶ For tires with special approval: the system was unable to complete the reset. Perform a system reset again.
- ▶ If the Tire Pressure Monitor malfunctions: Have the vehicle checked by an authorized service center or another qualified service center or repair shop.

Declaration according to NHTSA/ FMVSS 138 Tire Pressure Monitoring System

Each tire, including the spare (if provided) should be checked monthly when cold and inflated to the inflation pressure recommended by the vehicle manufacturer on the vehicle placard or tire inflation pressure label. (If the vehicle has tires of a different size than the size indicated on the vehicle placard or tire inflation pressure label, you should determine the proper tire inflation pressure for those tires.) As an added safety feature, the vehicle has been equipped with a tire pressure monitoring system (TPMS) that illuminates a low tire pressure telltale when one or more of your tires is significantly under-inflated. Accordingly, when the low tire pressure telltale illuminates, you should stop and check your tires as soon as possible, and inflate them to the proper pressure. Driving on a significantly under-inflated tire causes the tire to overheat and can lead to tire failure. Under-inflation also reduces fuel efficiency and tire tread life, and may affect the vehicle's handling and stopping ability. Please note that the TPMS is not a substitute for proper tire maintenance, and it is the driver's responsibility to maintain correct tire pressure, even if under-inflation has not reached the level to trigger illumination of the TPMS low tire pressure telltale. The vehicle has also been equipped with a TPMS malfunction indicator to indicate when the system is not operating properly. The TPMS malfunction indicator is combined with the low tire pres-

sure telltale. When the system detects a malfunction, the telltale will flash for approximately one minute and then remain continuously illuminated. This sequence will continue upon subsequent vehicle start-ups as long as the malfunction exists. When the malfunction indicator is illuminated, the system may not be able to detect or signal low tire pressure as intended. TPMS malfunctions may occur for a variety of reasons, including the installation of replacement or alternate tires or wheels on the vehicle that prevent the TPMS from functioning properly. Always check the TPMS malfunction telltale after replacing one or more tires or wheels on the vehicle to ensure that the replacement or alternate tires and wheels allow the TPMS to continue to function properly.

Flat tire monitor

Principle

The flat tire monitor detects a tire pressure loss while driving and issues a warning if the tire pressure has dropped.

General information

The system detects tire pressure loss on the basis of rotation speed differences between the individual wheels while driving.

In the event of a tire pressure loss, the diameter and therefore the rate of rotation of the corresponding wheel changes. The difference will be detected and reported as a flat tire.

The system does not measure the actual inflation pressure in the tires.

Functional requirements

The following prerequisites must be met for the system; otherwise, reliable notification of a tire pressure loss is not assured:

- ▷ After a tire or wheel change, an initialization was carried out at the correct tire pressure.
- ▷ After the tire pressure was adjusted to a new value, an initialization was performed.

Status display

The current status of the flat tire monitor can be displayed, e.g., whether the flat tire monitor is active.

1.  Apps menu
2. "Vehicle"
3. "Vehicle status"
4. "FLAT TIRE MONITOR"

The status is displayed.

Initialization required

An initialization must be performed in the following situations:

- ▷ After the tire inflation pressure has been adjusted.
- ▷ After a tire or wheel change.

Performing initialization

When initializing, the set tire inflation pressures serve as reference values in order to detect a flat tire. Initialization is started by confirming the tire inflation pressures.

Do not initialize the system when driving with snow chains.

1.  Apps menu
2. "Vehicle"
3. "Vehicle status"
4. "FLAT TIRE MONITOR"
5. Turn on drive-ready state and do not drive off.
6. "Perform reset"
7. Drive off.

The initialization is completed while driving, which can be interrupted at any time.

The initialization automatically continues when driving continues.

Messages

General information

When a flat tire is indicated, the Dynamic Stability Control (DSC) is turned on, if needed.

Safety information

Warning

A damaged regular tire with low or no tire inflation pressure impacts handling such as steering and braking response. Runflat tires can maintain limited stability. There is a risk of accident, injury, and property damage. Do not continue driving if the vehicle is equipped with normal tires. Follow the information on runflat tires and continued driving with these tires.

Indication of a flat tire



A yellow warning light is illuminated in the instrument cluster.

In addition, an icon with a Check Control message appears on the control display.

Icon	Possible cause
	There is a flat tire or a major tire pressure loss.

Measure

1. Reduce your speed and stop cautiously. Avoid sudden braking and steering maneuvers.
2. Check whether the vehicle is fitted with standard tires or runflat tires. Runflat tires are labeled with a circular icon containing the letters RSC marked on the tire sidewall.

Runflat tires, refer to page 311.

3. Read the description on what to do in case of a flat tire.

Actions in the event of a flat tire

Standard tires

1. Identify the damaged tire.

To do this, check the tire pressure in all four tires, for instance using the tire pressure display of a flat tire kit.

When the tire inflation pressure in all four tires is correct, the flat tire monitor may not have been initialized. In this case, initialize the system.

If tire damage cannot be identified, contact an authorized service center or another qualified service center or repair shop.

2. Repair the flat tire, e.g., with a flat tire kit or by changing the wheel.

Runflat tires

Safety information

Warning

The vehicle handles differently when a runflat tire has insufficient or no tire pressure; for instance, reduced directional stability when braking, braking distances are longer and the self-steering properties will change. There is a risk of accident, injury, and property damage. Drive moderately and do not exceed a speed of 50 mph/80 km/h.

Warning

Vibrations or loud noises while driving can indicate the final failure of a tire. Tire components may come loose. There is a risk of accident, injury, and property damage. Reduce your speed and stop. Do not continue driving.

Contact an authorized service center or another qualified service center or repair shop.

Maximum speed

You may continue driving with a damaged tire at speeds up to 50 mph/80 km/h.

Continued driving with a flat tire

Follow the following when continuing to drive with a damaged tire:

1. Avoid sudden braking and steering maneuvers.
2. Do not exceed a speed of 50 mph/80 km/h.
3. Check the tire inflation pressure in all four tires at the next opportunity.

When the tire inflation pressure in all four tires is correct, the flat tire monitor may not have been initialized. In this case, initialize the system.

Possible driving distance with a flat tire

The possible driving distance which may be safely traveled varies depending on how the vehicle is loaded and used, e.g., speed, road conditions, outside temperature. The distance traveled may be less but may also be more if an economical driving style is used.

If the vehicle is loaded with an average weight and used under favorable conditions, the possible distance traveled may be up to 50 miles/80 km.

Vehicle handling with damaged tires

Vehicles driven with a damaged tire will handle differently, potentially leading to conditions such as the following:

- ▶ Greater likelihood of skidding of the vehicle.
- ▶ Longer braking distances.
- ▶ Changed self-steering properties.

Modify your driving style. Avoid abrupt steering or driving over obstacles, for instance curbs or potholes.

System limits

The system may be delayed or malfunction in the following situations:

- ▶ A natural, even tire pressure loss in all four tires will not be recognized. Therefore, check the tire inflation pressure regularly.
- ▶ Sudden and serious tire damage caused by external circumstances cannot be recognized in advance.
- ▶ The system has not been initialized.
- ▶ When driving on a snowy or slippery road.
- ▶ Sporty driving style: slip on traction wheels, high lateral acceleration (drifting).
- ▶ When driving with snow chains.

Changing wheels/tires

General information

When using run-flat tires or a tire repair set, wheels do not always need to be changed immediately if the vehicle has broken down because the flat tire has caused a tire pressure loss.

If necessary, a suitable wheel change tool, e.g., a jack, is available as an accessory from an authorized service center or another qualified service center or repair shop.

Safety information

Warning

The jack is only provided for short-term lifting of the vehicle for wheel changes. Even if all safety precautions are observed, there is a risk of the raised vehicle falling if the jack tips over. There is a risk of injury or danger to life. When the vehicle is raised with the jack, do



not lie under the vehicle and do not switch on the drive-ready state.

⚠ Warning

Placing supports, e.g., wooden blocks or similar, under the jack may reduce its ability to bear weight because of the limited height. The load-carrying capacity of the wooden blocks may be exceeded and the vehicle may tip over. There is a risk of injury or danger to life. Do not place supports under the jack.

⚠ Warning

The jack, issued by the vehicle manufacturer, is provided in order to perform a wheel change in the event of a breakdown. The jack is not designed for frequent use, e.g., changing from summer to winter tires. Using the jack frequently may cause it to become jammed or damaged. There is a risk of injury and risk of property damage. Only use the jack to change an emergency or spare wheel in the event of a breakdown.

⚠ Warning

The jack may slip on soft, uneven, or slippery ground, e.g., snow, ice, tiles, etc. There is a risk of injury. If possible, change the wheel on a flat, solid, slip-resistant surface.

⚠ Warning

The jack is optimized for lifting the vehicle and for the jacking points on the vehicle only. There is a risk of injury. Do not lift any other vehicle or cargo using the jack.

⚠ Warning

When the jack is not inserted into the jacking point provided for this purpose, the vehicle may be damaged or the jack may slip when it is being cranked up. There is a risk of injury and risk of property damage. When cranking up the jack, ensure that it is inserted in the jacking point next to the wheel well.

⚠ Warning

A vehicle that is raised on a jack may fall off of the jack if lateral forces are exerted on it. There is a risk of injury and risk of property damage. While the vehicle is raised, do not exert lateral effort on the vehicle or pull abruptly on the vehicle. Have a stuck wheel removed by an authorized service center or another qualified service center or repair shop.

⚠ Warning

Incorrect handling of the jack can damage the vehicle's underbody and expose high-voltage components. There is a risk of injury and risk of property damage. When cranking up the jack, ensure that it is inserted in the jacking point next to the wheel well. Make sure not to damage any of the underbody parts.

⚠ NOTICE

Using an impact wrench to loosen or tighten the wheel lock bolt can damage the wheel lock bolt. There is a risk of property damage. Only use a lug wrench to loosen and tighten the wheel lock bolt.

Securing the vehicle against rolling away

General information

The vehicle manufacturer recommends to additionally secure the vehicle against rolling away when changing a wheel.

On a level surface



Place chocks or other suitable objects in front and behind the wheel that is diagonal to the wheel being changed.

On a slight downhill gradient



If it is necessary to change a wheel on a slight downhill gradient, place chocks and other suitable objects, e.g., rocks, under the wheels of the front and rear axles, against the direction that the vehicle will move.

Lug bolt lock

Principle

The wheel lug bolts have a special coding. The lug bolts can only be released with the adapter which matches the coding.

Overview

Depending on vehicle equipment, store the lug bolt lock adapter as follows:

- ▶ In the cargo area under the cargo area floor.
- ▶ In the cargo area on the left or right side.
- ▶ In the cargo area behind a side trim panel.

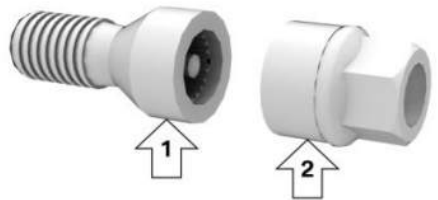

- ▶ Lug lock bolt, arrow 1.
- ▶ Adapter, arrow 2.

Unscrewing

1. Attach the adapter to the lug lock bolt.
2. Unscrew the lug lock bolt.
3. Remove the adapter after unscrewing the lug bolt.

Screwing on

1. Attach the adapter to the lug lock bolt. Turn the adapter until it fits onto the wheel lock bolt.
2. Screw on the lug lock bolt. The tightening torque is 101 lbs ft/140 Nm.
3. Remove the adapter and stow it after screwing on the lug bolt.

Safety precautions

- ▶ Park the vehicle on solid and non-slip ground at a safe distance from road traffic.
- ▶ Turn on the hazard warning system.
- ▶ Set the parking brake.
- ▶ Turn the steering wheel until the front wheels are in the straight-ahead position and engage the steering wheel lock.
- ▶ Engage a gear or move the selector lever to position P.
- ▶ As soon as permitted by the traffic flow, have all vehicle occupants get out and make sure that they remain outside the hazardous area such as behind a guardrail.
- ▶ If necessary, set up the hazard triangle or hazard warning lights at an appropriate distance.
- ▶ Depending on vehicle equipment, remove the wheel change set and, if necessary, the emergency wheel from the vehicle.
- ▶ Secure the vehicle additionally against rolling away.
- ▶ Loosen the lug bolts a half turn.

Jacking points

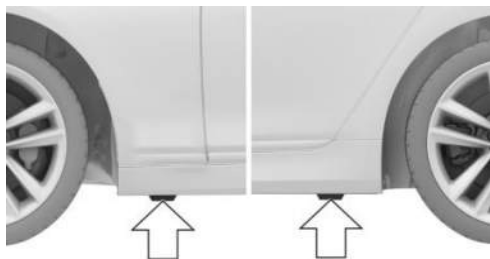

The jacking points are located at the indicated positions.

Jacking up the vehicle

Warning

Hands and fingers can be jammed when using the jack. There is a risk of injury. Comply with the described hand position and do not change this position while using the jack.

1. Hold the vehicle jack with one hand, arrow 1, and grasp the jack crank handle or lever with your other hand, arrow 2.

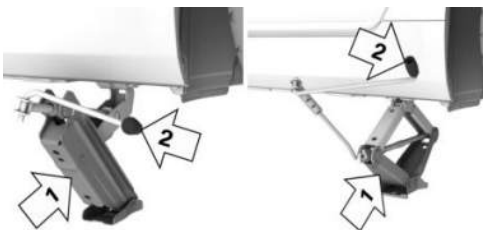

2. Insert the jack into the rectangular recess of the jacking point closest to the wheel to be changed.



3. Extend the jack by turning the jack crank handle or lever clockwise.



4. Take your hand away from the jack as soon as the jack is under load and continue turning the jack crank handle or lever with one hand.
5. Make sure that the car jack foot extends vertically and is at a right angle beneath the jacking point.

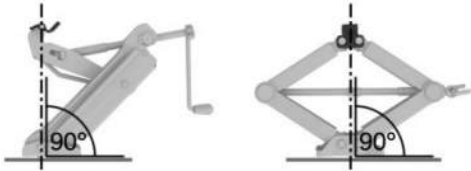

6. Crank the vehicle up until the entire jack surface is on the ground and the corresponding wheel is lifted max. 1.2 inches/3 cm above the ground.

Mounting a wheel

Mount one emergency wheel only, as required.

1. Unscrew the lug bolts.
2. Remove the wheel.
3. Put the new wheel or emergency wheel on and screw in at least two lug bolts in a crosswise pattern until hand-tight.
When non-original light-alloy wheels of the vehicle manufacturer are mounted, the accompanying lug bolts may have to be used as well.
4. Hand-tighten the remaining lug bolts and tighten all lug bolts well in a crosswise pattern.
5. Turn the jack crank handle counterclockwise to retract the jack and lower the vehicle.
6. Remove the jack and stow it securely.

After the wheel change

1. Tighten the lug bolts crosswise. The tightening torque is 101 lbs ft/140 Nm.
2. Stow the faulty wheel in the cargo area, if necessary.
3. Check tire inflation pressure at the next opportunity and correct as needed.
4. Re-initialize the flat tire monitor or reset the Tire Pressure Monitor.
5. Check to make sure the lug bolts are tight with a calibrated torque wrench.
6. Drive to the nearest authorized service center or another qualified service center or repair shop, then have the damaged tire replaced.

Under the hood

Vehicle features and options

This chapter describes model-specific equipment, systems, and functions that are currently

available, or may become available in the future, even if they are not present in the vehicle.

Additional information:

Vehicle equipment, refer to page 8.

Overview

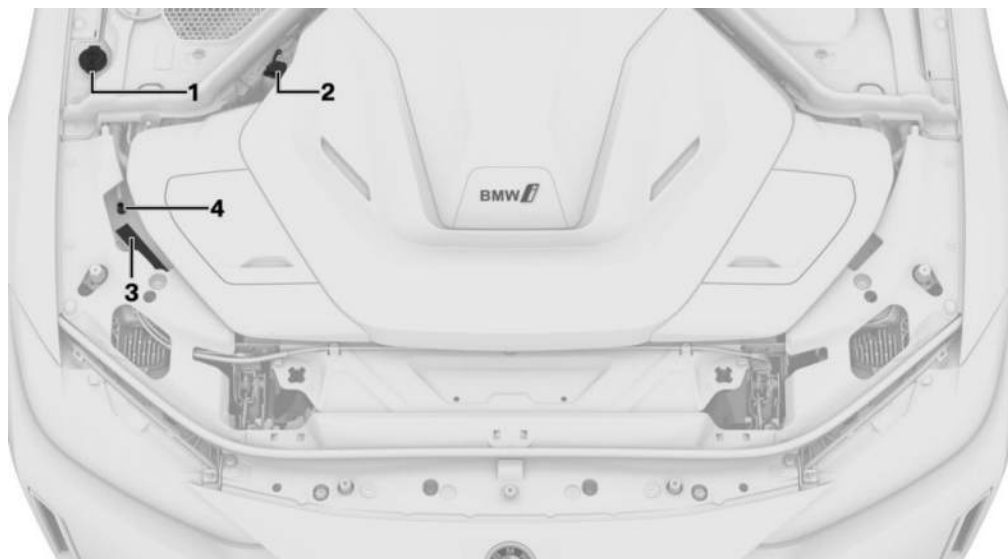

1 Filler neck for washer fluid

2 Jump-starting, positive battery terminal

3 Vehicle identification number

4 Jump-starting, negative battery terminal

Hood

Safety information

Warning

An incorrectly locked hood can open while driving and restrict visibility. There is a risk of accident, injury, and property damage. Stop immediately and correctly close the hood.

Warning

Body parts can be jammed when opening and closing the hood. There is a risk of injury. Make sure that the area of movement of hood is clear while opening and closing.

Warning

Improperly executed work under the hood can damage components and lead to a safety hazard. There is a risk of accident, injury, and property damage. The vehicle manufacturer recommends having work under the hood performed by an authorized service center or another qualified service center or repair shop.

Warning

There are protruding parts, for instance locking hooks, on the inside of the hood. There is a risk of injury. If the hood is open, pay attention to protruding parts and keep clear of these areas.

Warning

There are moving components under the hood. Certain components under the hood can also move with the vehicle switched off, for instance the radiator fan. There is a risk of

injury. Do not reach into the area of moving parts. Keep articles of clothing and hair away from moving parts.

NOTICE

Folded-out wipers can be jammed when the hood is opened. There is a risk of property damage. Make sure that the wipers with the wiper blades mounted are folded down onto the windshield before opening the hood.

NOTICE

When the hood is closed, it must engage on both sides. Pressing again can damage the hood. There is a risk of property damage. Open the hood again and then close it energetically. Avoid pressing again.

Opening hood

1. Pull the lever, arrow 1.

Hood is unlocked.

An acoustic signal and a notice in the instrument cluster indicate that the hood is open.



2. Release the lever and pull it again, arrow 2. Hood can be opened.
3. Be careful of protruding parts on the hood.

Closing the hood

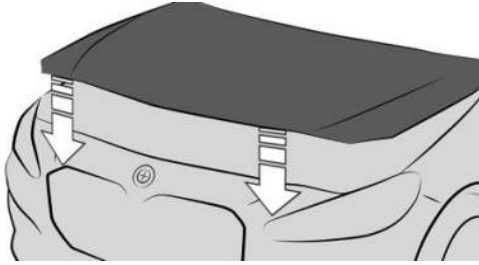

Energetically close the hood from approx.
20 in/50 cm.

The hood must engage on both sides.

Operating fluids

Vehicle features and options

This chapter describes model-specific equipment, systems, and functions that are currently available, or may become available in the future, even if they are not present in the vehicle.

Additional information:

Vehicle equipment, refer to page 8.

Coolant

General information

The cooling system is maintenance-free.

Have coolant topped up by an authorized service center or another qualified service center or repair shop.

Coolant level

A Check Control message is displayed when the coolant level is low.

Washer fluid

General information

All spray nozzles are supplied from one tank.

Use a mixture of tap water and windshield washer concentrate. If desired, a windshield washer concentrate containing antifreeze can be used.

Recommended minimum fill quantity: 0.4 US gal/2 liters.

Safety information

Warning

Some types of antifreeze can contain harmful substances and are flammable. There is a risk of fire and an injury hazard. Follow the instructions on the containers. Keep antifreeze away from ignition sources. Do not fill operating fluids into different bottles. Store operating fluids out of reach of children.

United States: the washer fluid mixture ratio is regulated by the U.S. EPA and many individual states; do not exceed the allowable washer fluid dilution ratio limits that apply. Follow the usage instructions on the washer fluid container.

Use of BMW's Windshield Washer Concentrate or the equivalent is recommended.

NOTICE

Silicon-containing additives in the washer fluid for the water-repelling effect on the windows can lead to damage to the car wash. There is a risk of property damage. Do not add silicon-containing additives to the washer fluid.

NOTICE

Mixing different windshield washer fluid concentrates or antifreeze can damage the washer system. There is a risk of property damage. Do not mix different windshield washer fluid concentrates or antifreeze. Follow the information and mixture ratios provided on the containers.

Overview



The washer fluid reservoir is located under the hood.

Malfunction

The use of undiluted windshield washer fluid concentrate or alcohol-based antifreeze can lead to incorrect readings at temperatures below +5 °F/-15 °C.

Maintenance

Vehicle features and options

This chapter describes model-specific equipment, systems, and functions that are currently available, or may become available in the future, even if they are not present in the vehicle.

Additional information:

Vehicle equipment, refer to page 8.

Maintenance system

Principle

The maintenance system provides service notifications and thereby provides support in maintaining road safety and the operational reliability of the vehicle.

General information

In some cases, scopes and intervals of the maintenance system may vary according to the country version. Replacement work, spare parts, fuels and lubricants, and wear materials are calculated separately. Further information is available from an authorized service center or another qualified service center or repair shop.

Safety information

Warning

Improperly performed work, in particular maintenance and repair on the high-voltage system, can lead to electric shock. There is a risk of injury, fire and danger to life.

It is recommended that the work on the vehicle, in particular maintenance and repair, is performed by an authorized service center or another qualified service center or repair shop.

Condition Based Service

Principle

Condition Based Service determines the maintenance recommendation using sensors and special algorithms that take into account the operating conditions of the vehicle.

The system makes it possible to adapt the maintenance measures to your user profile.

General information

Service notifications can be displayed on the control display.

Additional information:

Service notifications, refer to page 156.

Service data in the vehicle key

Information on the service notifications is continuously stored in the vehicle key. An authorized service center can read this data out and suggest a maintenance scope for the vehicle.

Therefore, hand the service advisor the vehicle key with which the vehicle was driven most recently.

Stationary periods

Stationary periods during which the vehicle battery was disconnected are taken into account.

Have any time-dependent maintenance measures, e.g., replacing operating fluids, performed

by an authorized service center or another qualified service center or repair shop.

Maintenance Booklet for US Models

Please consult your Maintenance Booklet for additional information on the performance of service and maintenance work.

The manufacturer of the vehicle recommends that maintenance and repair be performed by an authorized service center or another qualified service center or repair shop. Records of regular maintenance and repair work should be retained.

Diagnostic socket

General information

Devices connected to the diagnostic socket will trigger the alarm system after the vehicle is locked.

Disconnect devices from the diagnostic socket before locking the vehicle.

Additional information:

Indicator/warning lights, refer to page [140](#).

Safety information

NOTICE

The socket for Onboard Diagnosis is an intricate component intended to be used in conjunction with specialized equipment to check the vehicle's primary emissions system. Improper use of the socket for Onboard Diagnosis, or contact with the socket for Onboard Diagnosis for other than its intended purpose, can cause vehicle malfunctions and creates risks of personal and property damage. As such, it is strongly recommended that access to the diagnostic socket be limited to

an authorized service center or another qualified service center or repair shop, or other persons who have specialized training and equipment and who are able to use the diagnostic socket correctly.

Overview

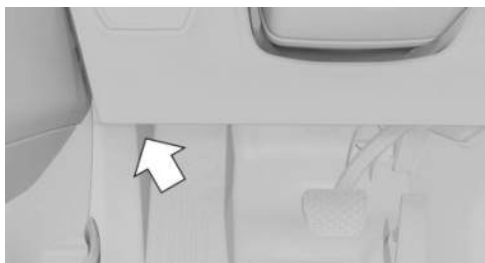

There is a diagnostic socket on the driver's side for reading out vehicle data.

Taking the vehicle out of service

When the vehicle is shut down for longer than three months, special measures must be taken. For more information, contact an authorized service center or another qualified service center or repair shop.

Additional information:

High-voltage battery service life, refer to page [299](#).

Replacing components

Vehicle features and options

This chapter describes model-specific equipment, systems, and functions that are currently available, or may become available in the future, even if they are not present in the vehicle.

Additional information:

Vehicle equipment, refer to page 8.

Onboard vehicle tool kit



The on-board toolkit is located in the left storage compartment in the cargo area, under a cover.

Wiper blades

Safety information

NOTICE

The window may sustain damage if the wiper falls onto it without the wiper blade installed. There is a risk of property damage. Hold the wiper firmly when changing the wiper blade. Do not fold in or switch on the wiper without a wiper blade installed.

NOTICE

Folded-out wipers can be jammed when the hood is opened. There is a risk of property damage. Make sure that the wipers with the wiper blades mounted are folded down onto the windshield before opening the hood.

Replacing the wiper blades

1. To change the wiper blades, bring wipers into fold-out position.
Fold-out position of the wipers, refer to page 167.
2. Fold out and hold the wiper arm firmly.
3. Squeeze the retaining spring, arrow 1, and fold up the wiper blade, arrow 2.

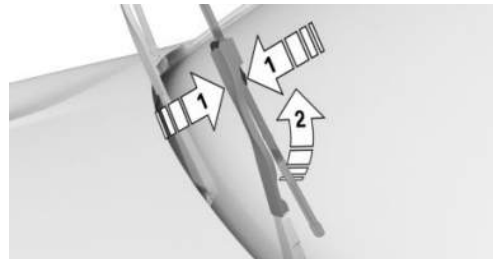

4. Remove the wiper blade forward from the detent.
5. Insert the new wiper blade in reverse order of removal until it locks in place.
6. Fold in the wipers.

Lights and bulbs

General information

Lights and bulbs make an essential contribution to driving safety.

All headlights and lights are designed using LED technology at least.

In the event of a malfunction, the vehicle manufacturer recommends having any necessary work performed by an authorized service center or another qualified service center or repair shop.

Safety information

Warning

Focused laser light can irritate or permanently damage the retina of the eye. There is a risk of injury. The vehicle manufacturer recommends having work on the lighting system, including bulb replacement, performed by an authorized service center or another qualified service center or repair shop.

Warning

Intense brightness can irritate or damage the retina of the eye. There is a risk of injury. Do not look directly into the headlights or other light sources. Do not remove the LED covers.

Headlight glass

The inside of the headlight glass can fog up in cool or humid weather. When driving with the lights switched on, the condensation evaporates after a short time. The headlight glass does not need to be changed.

If, despite driving with the headlights switched on, moisture such as water droplets increasingly forms in the light, have the headlights checked.

Vehicle battery

General information

In addition to the high-voltage battery, the vehicle has a 12 volt vehicle battery. The vehicle battery supplies the onboard electronics with energy.

The vehicle battery is maintenance-free.

More information on the vehicle battery can be requested from an authorized service center or another qualified service center or repair shop.

Safety information

DANGER

Contact with live components can lead to an electric shock. There is a risk of injury or danger to life. Do not touch any components that are under voltage.

Warning

Vehicle batteries that are not recommended can damage vehicle systems and impair vehicle functions. There is a risk of accident, injury, and property damage. Only use vehicle batteries recommended by the vehicle manufacturer. For information on suitable vehicle batteries, contact an authorized service center or another qualified service center or repair shop.







Registering the vehicle battery in the vehicle

The vehicle manufacturer recommends having an authorized service center or another qualified service center or repair shop register the vehicle battery to the vehicle after the battery has been changed. Once the battery has been registered again, all comfort features will be available without limitation and any Check

Control messages displayed which relate to comfort features will disappear.

Hazard icons

The following hazard icons can be found on the vehicle battery:

Icon	Meaning
	No smoking, no open flames, no sparks.
	Wear safety goggles.
	Keep away from children.
	Risk of chemical burn: wear gloves, do not tilt battery.
	Flush acid splashes with water immediately. In the event of contact with the eyes or swallowing, seek a physician immediately.
	No direct daylight, no frost.
	Follow the operating instructions.
	Explosive gas mixture. Do not close any openings of the battery.

Charging the vehicle battery

A charger that is installed in the vehicle supplies the vehicle battery with power. The charger receives the necessary energy from the high-voltage battery.

Additional information:

Charge vehicle, refer to page [286](#).

Power interruption

After a power interruption, some equipment needs to be newly initialized or individual settings updated, for example:

- ▷ Parking brake, refer to page [133](#).
- ▷ With Memory function: store the positions again.
- ▷ Time: update.
- ▷ Date: update.
- ▷ Glass sunroof: initialize the system.

Disposing of old batteries



Have old batteries disposed of by an authorized service center or another qualified service center or repair shop, or take them to a collection point.

Transport and store full vehicle batteries in an upright position. Secure the battery so that it does not tip over during transport.



Batteries contain harmful chemicals. It is prohibited by law to dispose of batteries together with household waste.

Fuses

General information

The fuses are located at different places in the vehicle.

Information on the fuse layout and the positions of the fuse boxes is available on the Internet: fusecard.bmw.com.

Safety information

Warning

Incorrect and repaired fuses can overload electrical lines and components. There is a risk of fire, injury, and property damage. Never attempt to repair a blown fuse. Do not



replace a nonworking fuse with a substitute of another color or amperage rating.

Replacing fuses

The vehicle manufacturer recommends having the fuses replaced by an authorized service center or another qualified service center or repair shop.

Breakdown Assistance

Vehicle features and options

This chapter describes model-specific equipment, systems, and functions that are currently available, or may become available in the future, even if they are not present in the vehicle.

Additional information:

Vehicle equipment, refer to page 8.

Hazard warning system

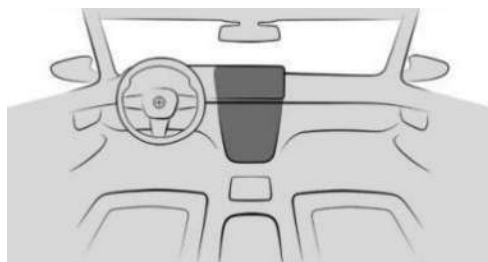

Hazard warning system button

The red light in the button flashes when the hazard warning system is turned on.

Warning triangle

The warning triangle is located in the tailgate.

1. Turn the screw cap in the tailgate by 90°, arrow 1, and fold down the trim panel, arrow 2.

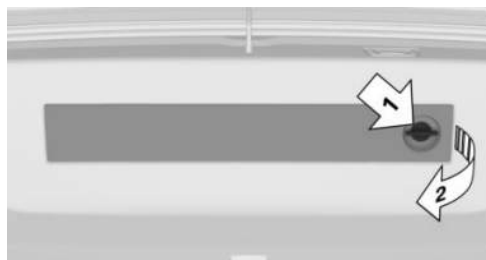

2. Push the warning triangle sideways to the left and remove it.

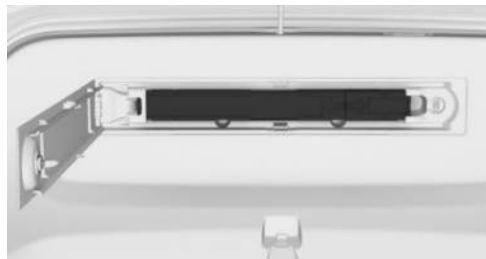

First-aid kit

General information

Depending on the vehicle equipment and national-market version, the vehicle is equipped with a first-aid kit.

Some of the articles have a limited service life.

Check the expiration dates of the contents regularly and replace any expired items promptly.

Storage

Storage for the first-aid kit is provided in the right side of the cargo area.

BMW Assist

Principle

In the event of a breakdown, accident or if you have any questions about the vehicle, BMW Assist can be used to contact BMW Group's customer support.

General information

The offering depends on the vehicle equipment and the national-market version.

For more information on this service, the vehicle manufacturer recommends contacting an authorized service center or the hotline/customer support.

Starting services

1.  Apps menu
2. "All apps"
3. "BMW Assist"
4. Select the BMW Assistance option.

A voice connection to customer support is being established.

BMW Roadside Assistance

Principle

The BMW Group Accident Assistance is standing by to provide help in the event of a breakdown.

General information

In the event of a breakdown, data on the vehicle's condition is transmitted to the BMW Roadside Assistance.

There are various ways of contacting BMW Roadside Assistance.

- ▶ Via additional text in the Check Control message.
- ▶ Via a call with a mobile phone.
- ▶ Via the My BMW App.

Functional requirements

To use BMW Roadside Assistance, the following functional requirements must be met:

- ▶ Active ConnectedDrive contract, equipment with intelligent emergency call or BMW ConnectedDrive services.
- ▶ Cellular network reception.
- ▶ Standby state is switched on.

Starting BMW Roadside Assistance manually

If the vehicle is equipped with Teleservices, support is first offered through Teleservice Diagnosis and, where applicable, then through Teleservice Help.

BMW Roadside Assistance can be started manually as follows:

1.  Apps menu
2. "All apps"
3. "BMW Assist"
4. "BMW Roadside Assistance" or select the desired service.

Follow the displays on the control display. A voice connection is established as necessary.

Teleservice Diagnosis

Teleservice Diagnostics enables detailed vehicle data to be transmitted via mobile communications, which is necessary for vehicle diagnosis. This data is transmitted automatically. It may be necessary to approve this on the control display.

Teleservice Help

Depending on the country, Teleservice Help enables an in-depth diagnosis of the vehicle by BMW Roadside Assistance via wireless transmission.

You can launch Teleservice Help by requesting it through BMW Roadside Assistance.

1. Park vehicle in a safe place.
2. Engage the parking brake.
3. Turn on the control display.
4. Consent to Teleservice Help.

BMW Accident Assistance

Principle

The BMW Group Accident Assistance is standing by to provide help in the event of an accident.

General information

If the vehicle sensors detect a minor to moderately severe accident, which did not deploy any airbags, a Check Control message is displayed in the instrument cluster. In addition, a text message appears on the control display.

When BMW Accident Assistance is triggered, data on the vehicle's condition is sent to BMW.

Functional requirements

To use BMW Roadside Assistance, the following functional requirements must be met:

- ▶ Active ConnectedDrive contract, equipment with intelligent emergency call or BMW ConnectedDrive services.
- ▶ Cellular network reception.
- ▶ Standby state is switched on.

Starting BMW Accident Assistance

If an accident is detected automatically

A text message relating to BMW Accident Assistance appears on the control display.

The connection can be established directly: "Contact accident assistance"

The Check Control message for BMW Accident Assistance can also be called up from the stored Check Control messages for a certain length of time.

Additional information:

Check Control, refer to page [139](#).

Starting BMW Accident Assistance manually

BMW Accident Assistance can also be contacted independently of the automatic accident detection function.

BMW Accident Assistance can be started manually as follows:

1.  Apps menu
2. "All apps"
3. "BMW Assist"
4. "BMW Accident Assistance" or select the desired service.

Follow the displays on the control display. A voice connection is established.

Emergency Call

Principle

In case of an emergency, an emergency call can be triggered automatically by the system or manually.

Intelligent emergency call

The vehicle features an Intelligent Emergency Call system, depending on vehicle equipment.

The Intelligent Assist system establishes a connection with the BMW Response Center.

Intelligent emergency calls are made using a SIM card that is integrated into the vehicle.

The BMW Response Center then makes contact with the occupants of the vehicle and initiates further steps to help.

If an intelligent emergency call is made, the data used to determine necessary rescue measures, e.g., the vehicle's current location if it can be determined, is sent to the BMW Response Center.

Even if the driver is unable to respond, the BMW Response Center can, under certain circumstances, initiate steps to provide further assistance.

Even if the BMW Response Center is no longer heard through the loudspeakers, the BMW Response Center may still be able to hear the occupants of the vehicle.

The BMW Response Center ends the emergency call.

General information

Only press the SOS button in the headliner in an emergency.

For technical reasons, the emergency call cannot be guaranteed under unfavorable conditions.

Overview



The SOS button is located in the headliner.

Functional requirements

To use the emergency call, the following functional requirements must be met:

- ▶ Standby state is switched on.
- ▶ The Emergency Call system is functioning correctly.
- ▶ The integrated SIM card in the vehicle has been activated.

Automatic triggering

Under certain conditions, for example if the airbags are deployed, an emergency call is automatically triggered immediately after an accident of corresponding severity. Automatic Collision Notification is not affected by pressing the SOS button.

If an emergency call is placed, all other signal tones and audio sources such as the Park Distance Control are muted.

Manual triggering

To initiate an emergency call manually, proceed as follows:

1. Tap the cover flap.
2. Press and hold the SOS button in the headliner until the LED near the button illuminates green.

- ▶ The LED is illuminated green when an Emergency Call has been initiated.

If a cancel prompt appears on the control display, the emergency call can be aborted.

If the situation allows, wait in the vehicle until the voice connection has been established.

- ▶ The LED flashes green when the connection to the BMW Response Center has been established.

Malfunction

The function of the emergency call may be impaired.

The LED near the SOS button flashes for approximately 30 seconds. A Check Control message is displayed.

An emergency call may be disrupted in the following circumstances, among others:

- ▶ Extended vehicle idle times.
- ▶ Intense sunlight on vehicle roof.

Have the vehicle checked by an authorized service center or another qualified service center or repair shop.

What to do after an accident

General information

After an accident, take the following safety precautions for the high-voltage system:

- ▶ Apply the parking brake, then turn off drive-ready state and standby state.
- ▶ Secure the accident site.
- ▶ Lock the vehicle after exiting.
- ▶ Immediately inform the emergency responders, police, fire department, or towing service that the vehicle is equipped with high-voltage system.
- ▶ The vehicle must be recovered by an authorized service center or another qualified service center or repair shop.
- ▶ Do not inhale any gases escaping from the high-voltage battery; if needed, maintain a safe distance from the vehicle.

Safety information

DANGER

Contact with live components can lead to an electric shock. There is a risk of injury or danger to life. After an accident, do not touch any high-voltage components such as orange colored high-voltage cables or parts

that are in contact with exposed high-voltage cables.

Warning

Fluids in the high-voltage battery are corrosive. There is a risk of injury. Do not touch fluids escaping from the high-voltage battery.

Jump-starting

General information

Have only an authorized service center or another qualified service center or repair shop perform the jump-start.

Safety information

DANGER

Contact with live components can lead to an electric shock. There is a risk of injury or danger to life. Do not touch any components that are under voltage.

Towing

Safety information

Warning

When towing while safety systems or driver assistance systems are activated, the behavior of the individual systems may lead to an accident, e.g., due to automatic braking or acceleration. There is a risk of accident, injury, and property damage. Do not use the corresponding safety systems or driver assistance systems when towing.

Pushing the vehicle

To remove a broken-down vehicle from the hazard area, it can be pushed for distances of approx. 328 ft/100 m at a speed of max. 6 mph/10 km/h.

Additional information:

Rolling or pushing the vehicle, refer to page 126.

Transporting the vehicle

General information

The vehicle must be transported on a loading platform or tow dolly.

The vehicle must be transported by an authorized service center or another qualified service center or repair shop.

Safety information

NOTICE

The vehicle can be damaged when towing the vehicle with a single lifted axle. There is a risk of property damage. Have vehicle transported on a loading platform or use a tow dolly. Tow dollies must be used under the rear wheels only. Also make sure that no wheel is touching the ground.

Warning

The vehicle can become damaged when lifting and securing it. There is a risk of injury and risk of property damage.

- ▷ Only lift the vehicle using a suitable device.
- ▷ Do not lift or secure the vehicle on the towing eye, rims, body components, or chassis components.
- ▷ For transport, secure the vehicle by placing special tire straps over the tire tread surfaces in the vehicle's longitudinal direction.

Tow truck

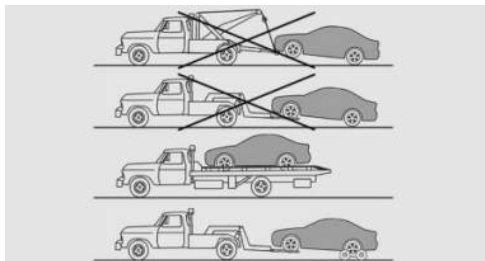

Have vehicle transported on a loading platform or use a tow dolly.

When using a tow dolly, make sure that none of the wheels touch the ground. This method should be used for distances of 124 miles/200 km. Follow the instructions, as well as specified loads and speeds, given by the tow dolly manufacturer.

Towing other vehicles

Principle

Switch on the hazard warning system, depending on local regulations.

If the electrical system has failed, clearly identify the vehicle being towed by placing a sign or a warning triangle in the rear window.

Safety information

Warning

If the approved gross vehicle weight of the towing vehicle is lighter than the vehicle to be towed, the towing eye can tear off or it will not be possible to control vehicle handling. There is a risk of accident, injury, and property damage. Make sure that the gross vehicle weight of the towing vehicle is heavier than the vehicle to be towed.

Warning

Different levels of braking may occur when towing with adaptive recuperation. There is a risk of accident, injury, and property damage. Deactivate adaptive recuperation before towing.

NOTICE

If the tow bar or tow rope is attached incorrectly, damage to other vehicle parts can occur. There is a risk of property damage. Correctly attach the tow bar or tow rope to the towing eye.

Tow bar

The towing eyes used should be on the same side on both vehicles.

If it is impossible to avoid mounting the tow bar at an inclination, note the following:

- ▷ Free movement is limited when cornering.
- ▷ The tow bar will generate lateral forces if it is secured with an inclination.

Tow rope

Observe the following notes when using the tow rope:

- ▷ Use nylon ropes or straps, which will enable the vehicle to be towed without jerking.
- ▷ Make sure the tow rope is not twisted when fastening.
- ▷ Check the attachment of the towing eye and tow rope in regular intervals.
- ▷ Do not exceed a towing speed of 30 mph/50 km/h.
- ▷ Do not exceed a towing distance of 3 miles/5 km.
- ▷ When driving off to tow the vehicle, make sure that the tow rope is taut.

Towing eye

Principle

The towing eye is a device that can be screwed onto the vehicle in order to, e.g., secure tow cables or tow rods.

General information



The screw-in towing eye should always be carried in the vehicle.

The towing eye can be screwed in at the front or rear of the vehicle.

Safety information

NOTICE

If the towing eye is not used as intended, there may be damage to the vehicle or to the towing eye. There is a risk of property damage. Follow the notes on using the towing eye.

Storage

Depending on vehicle equipment, the towing eye may be stored in a bag as follows:

- ▶ In the cargo area under the cargo area floor.
- ▶ In the cargo area on the left or right side.
- ▶ In the cargo area behind a side trim panel.

Using the towing eye

When using the towing eye, note the following:

- ▶ Use only the towing eye provided with the vehicle.
- ▶ Turn the towing eye at least 5 turns clockwise and screw it in as far as it will go. If necessary, tighten with a suitable object.
- ▶ After use, unscrew the towing eye counter-clockwise.
- ▶ Use the towing eye for towing on paved roads only.
- ▶ Avoid lateral loading of the towing eye, for instance do not lift the vehicle by the towing eye.
- ▶ Check the attachment of the towing eye in regular intervals.

Towing eye thread



The thread for the towing eye is located behind a cover on the front and rear bumper.

Press on the mark on the edge of the cover to push it out.

Vehicle care

Vehicle features and options

This chapter describes model-specific equipment, systems, and functions that are currently available, or may become available in the future, even if they are not present in the vehicle.

Additional information:

Vehicle equipment, refer to page 8.

Washing the vehicle

General information

Regularly remove foreign objects such as leaves or snow in the area below the windshield.

Wash the vehicle frequently, particularly in winter. Intense contamination and road salt can damage the vehicle.

Additional information:

Fold-out position of the wipers, refer to page 167.

Safety information

Warning

Contact with live components can lead to an electric shock. High voltage is present at the charging connection. There is a risk of injury or danger to life.

It is recommended that work on the charging connection, for example cleaning, is performed by an authorized service center or another qualified service center or repair shop.

NOTICE

When washing with an open charging socket flap, the charging socket can be damaged. There is a risk of damage to property. Close the charging socket flap before washing. Clean dirt behind the charging socket flap with a cloth.

Steam-jet cleaner and high pressure cleaner

Safety information

NOTICE

When using high-pressure cleaners, components can be damaged due to the pressure or high temperatures or because an insufficient distance was maintained. There is a risk of property damage. Maintain sufficient distance and do not spray too long continuously. Follow the operating instructions for the high pressure cleaners.

Distances and temperature

- ▶ Maximum temperature: 140 °F/60 °C.
- ▶ Minimum distance from sensors, cameras, seals and lights: 12 inches/30 cm.
- ▶ Minimum distance from glass sunroof: 31.5 in/80 cm.

Automatic car washes or car washes

Safety information

NOTICE

Using a car wash with high pressure washers may result in water penetration of window areas. There is a risk of property damage. Do not drive into high-pressure car wash systems.

NOTICE

Improper use of automatic car washes can cause damage to the vehicle. There is a risk of property damage. Follow the following instructions:

- ▶ Give preference to cloth car washes or those that use soft brushes in order to avoid paint damage.
- ▶ Note the permissible vehicle dimensions for the car wash.
- ▶ Do not drive through a car wash with guide rails higher than 4 in/10 cm to avoid damage to the body.
- ▶ Observe the tire width of the guide rail to avoid damage to tires and rims.
- ▶ Fold in exterior mirrors to avoid damage to the exterior mirrors.
- ▶ Deactivate the wiper and, if necessary, rain sensor to avoid damage to the window wiper system.
- ▶ Take off all removable attachments, e.g., antennas.

Driving into a car wash

NOTICE

Selector lever position P is automatically engaged when standby state is switched off. The wheels are blocked. There is a risk of property damage. Do not switch off standby if the vehicle is meant to coast, e.g., in a car wash.

In a car wash, the vehicle must be able to roll freely.

Some car washes do not permit persons in the vehicle. The vehicle cannot be locked from the outside when in selector lever position N. A signal sounds when an attempt is made to lock the vehicle.

Additional information:

Rolling or pushing the vehicle, refer to page [126](#).

Driving out of a car wash

Ensure that the vehicle key is in the car.

Turn on drive-ready state.

Additional information:

Drive-ready state, refer to page [47](#).

Lights

Do not rub wet lights dry and do not use abrasive or acidic cleaning agents or cleaning agents containing alcohol.

Soak areas that have been dirtied, for instance from insects, with auto shampoo and wash off with water.

Thaw ice with de-icing spray; do not use an ice scraper.

After washing the vehicle

After washing the vehicle, apply the brakes briefly to dry them. Otherwise, their braking effect may be reduced. The heat generated

while braking dries brake disks and brake pads and protects them against corrosion.

Completely remove all residues on the windows to minimize loss of visibility due to smearing and to reduce wiper noises and wiper blade wear.

Vehicle care

Vehicle care products

General information

BMW recommends using vehicle care and cleaning agents from BMW. Suitable vehicle care products are available from an authorized service center or another qualified service center or repair shop.

Safety information

Warning

Cleaning agents can contain substances that are dangerous and harmful to your health. There is a risk of injury and risk of property damage. When cleaning the interior, open the doors or windows. Only use cleaning agents that are intended for cleaning the respective component. Follow the instructions on the packaging.

Vehicle paintwork

General information

Regular vehicle care contributes to driving safety and value retention. Environmental influences in areas with elevated air pollution or natural contaminants such as tree resin or pollen can affect the vehicle paintwork. Tailor the frequency and extent of the vehicle care to these influences.

Corrosive substances such as grease or bird droppings must be removed immediately to

prevent the finish from being altered or discolored.

Matte paintwork

Only use cleaning and care products suitable for vehicles with matte paintwork.

Plastic wrap

Use only cleaning and care products that are suitable for vehicles with a plastic wrap.

Leather care

Remove dust from the leather regularly, using a cloth or vacuum cleaner.

Otherwise, particles of dust and road grime chafe in pores and folds, and lead to heavy abrasion and premature degradation of the leather surface.

To guard against discoloration such as from clothing, clean leather and provide leather care roughly every two months.

Clean light-colored leather more frequently because contamination on such surfaces is substantially more visible.

Use leather care products; otherwise, dirt and grease will gradually break down the protective coating of the leather surface.

Remove aggressive substances, e.g., sunscreen, immediately to prevent alterations or discolorations of the leather.

Synthetic leather care

Clean synthetic leather regularly with a damp microfiber cloth or vacuum cleaner.

Otherwise, dust and road grime particles will rub into pores and folds, causing significant abrasion and premature degradation of the surface.

In case of major soiling, use a moist soft sponge or microfiber cloth with suitable interior cleaners.

Immediately remove aggressive substances, e.g., sunscreen, to prevent alterations or discolorations of the synthetic leather.

Fabric care

General information

In case of major contaminations such as beverage stains, use a moist soft sponge or microfiber cloth with a suitable interior cleaners.

Immediately remove aggressive substances, e.g., sunscreen, to prevent alterations or discolorations of the fabric.

Safety information

NOTICE

Open hook and loop fasteners, zippers, or applications, e.g., studs on clothing can damage the seat covers and the other fabric and leather covers in the vehicle. There is a risk of property damage. Make sure that the fasteners are closed.

Upholstery material care

Vacuum regularly with a vacuum cleaner.

Clean extensively down to the seams. Avoid rubbing the material vigorously.

Textile care

Use a microfiber cloth for cleaning minor contamination.

Dampen the cloth with water.

Alcantara

Use microfiber cloth soaked with water to clean minor soiling. Avoid rubbing the material vigorously.

Caring for special components

Displays, operating elements, and protective glass of the Head-up display

NOTICE

Surfaces can be damaged by improper cleaning, e.g., by using chemical cleaners, or from moisture or liquid of any kind. There is a risk of property damage.

- ▷ Avoid pressure that is too high and do not use any scratching materials.
- ▷ Use a dry, clean antistatic microfiber cloth for cleaning displays.
- ▷ Clean the operating elements and, depending on vehicle equipment, the protective glass of the Head-up display with a damp microfiber cloth and standard household dish soap.

Light-alloy wheels

When cleaning the vehicle, use only neutral rim cleaners having a pH value from 5 to 9. Do not use abrasive cleaning agents or steam-jet cleaners above 140 °F/60 °C. Follow the manufacturer's instructions.

Corrosive, acidic, or alkaline cleaning agents can damage the rim surface and the protective layer on adjacent components, e.g., the brakes.

After cleaning, apply the brakes briefly to dry them. The heat generated while braking dries brake disks and brake pads and protects them against corrosion.

Chrome surfaces

Carefully clean chrome-like surfaces, especially if exposed to road salt, using plenty of water as well as auto shampoo as needed.

Rubber components

Environmental influences can cause surface contamination of rubber parts and a loss of gloss. Use only water and suitable cleaning agents for cleaning.

Treat especially worn rubber parts with rubber care products at regular intervals. When cleaning rubber seals, do not use any silicon-containing vehicle care products in order to avoid damage or noises.

Wiper blades

The wiper blades are cleaned by using the window washer system.

Avoid cleaning the wiper blades manually, as this may reduce wiper performance.

Fine wood parts

Clean the fine wood veneer and fine wood components with a damp cloth. Then dry with a soft cloth.

Plastic components

NOTICE

Solvent cleaners that contain alcohol or solvents such as lacquer thinners, cold cleaning agents, fuel and such, can damage plastic parts. There is a risk of property damage. Clean with a microfiber cloth. Dampen the cloth lightly with water, if needed.

When cleaning plastic parts, make sure that no fabric parts, e.g., the headliner, become wet.

Carbon parts

For easy cleaning of carbon parts, use a microfiber cloth, water, and silicone-free cleaner to remove everyday soiling.

Corrosive, acidic, or alkaline cleaning agents can alter the surface.

If necessary, have carbon parts removed by an authorized service center or another qualified service center or repair shop.

Seat belts

Warning

Chemical solvent cleaners can destroy the fabric of the seat belts and lead to seat belts no longer having their protective effect. There is a risk of injury or danger to life. Use only a mild soap solution for cleaning the seat belts.

Dirty belt straps impede the reeling action and thus should be avoided for safety reasons.

Use only a mild soap solution for cleaning the installed belt straps.

Seat belts should only be allowed to retract if they are dry.

Carpets and floor mats

Warning

Objects in the driver's footwell can limit the pedal travel or block a depressed pedal. There is a risk of accident, injury, and property damage. Stow objects in the vehicle such that they are secured and cannot enter into the driver's footwell. Use floor mats that are suitable for the vehicle and can be safely attached to the floor. Do not use loose floor mats and do not layer several floor mats. Make sure that there is sufficient clearance for the pedals. Ensure that the floor mats are securely fastened again after they were removed, for instance for cleaning.

The floor mats can be removed from the interior for cleaning.

If the floor carpets are very contaminated, clean with a microfiber cloth and water or a textile cleaner. To prevent matting of the car-



pet, rub back and forth in the driving direction only.

Sensors and camera lenses

To clean sensors and camera lenses, use a cloth moistened with a small amount of glass detergent.

Technical data

Vehicle features and options

This chapter describes model-specific equipment, systems, and functions that are currently available, or may become available in the future, even if they are not present in the vehicle.

Additional information:

Vehicle equipment, refer to page 8.

General information

The technical data and specifications in the Owner's Manual are used as guidance values. Vehicle-specific data may deviate from this,

for instance due to the optional equipment chosen, national-market version, or country-specific measuring process. More specific values can be obtained in approval documents, on the vehicle info label, or from an authorized service center or another qualified service center or repair shop.

Dimensions

The dimensions can vary depending on the model version, equipment version or country-specific measurement procedure.

The height of the vehicle can also differ, e.g., due to tires and vehicle load.

Detailed technical data

BMW i4 Gran Coupe

Dimensions

Width with mirrors	in	81.6
	mm	2,073
Width without mirrors	in	72.9
	mm	1,852
Height	in	57.0
	mm	1,448
Length	in	188.5
	mm	4,787
Wheelbase	in	112.4
	mm	2,856
Turning circle Ø	ft	41.0
	m	12.5

BMW i4 M50 xDrive Gran Coupe**Weight**

Maximum permissible payload	lb	948
	kg	430
Maximum permissible total weight	lb	6,030
	kg	2,735
Maximum permissible front axle load	lb	2,844
	kg	1,290
Maximum permissible rear axle load	lb	3,417
	kg	1,550

BMW i4 eDrive35 Gran Coupe**Weight**

Maximum permissible payload	lb	944
	kg	428
Maximum permissible total weight	lb	5,611
	kg	2,545
Maximum permissible front axle load	lb	2,491
	kg	1,130
Maximum permissible rear axle load	lb	3,362
	kg	1,525

BMW i4 eDrive40 Gran Coupe**Weight**

Maximum permissible payload	lb	950
	kg	431
Maximum permissible total weight	lb	5,732
	kg	2,600
Maximum permissible front axle load	lb	2,535
	kg	1,150

BMW i4 eDrive40 Gran Coupe

Weight

Maximum permissible rear axle load	lb	3,417
	kg	1,550

BMW i4 xDrive40 Gran Coupe

Weight

Maximum permissible payload	lb	972
	kg	441
Maximum permissible total weight	lb	6,030
	kg	2,735
Maximum permissible front axle load	lb	2,844
	kg	1,290
Maximum permissible rear axle load	lb	3,417
	kg	1,550

Appendix

General information

Any updates to the Owner's Manual of the vehicle are listed here.

Updates made after the editorial deadline

The following chapters were updated in the printed version of the Owner's Manual after the editorial deadline for the Integrated Owner's Manual in the vehicle had closed:

Everything from A to Z

Index

0-9

3D view [234](#)

A

ABS, see Antilock Braking System [199](#)

Acceleration Assistant, see Launch Control [129](#)

Acceleration sensor, see G-Meter [154](#)

Accelerator pedal positions [127](#)

Accessories and parts [9](#)

AC charging station, see Charging vehicle [286](#)

Accident Assistance, see BMW Accident Assistance [343](#)

Accident prevention, see Active Protection [195](#)

Accident, what to do [345](#)

ACC, see Cruise Control with Distance Control [210](#)

Acoustic pedestrian protection [123](#)

AC quick charging cable, see Mode 3 charging cable [288](#)

Activated carbon filter, see Interior filter [258](#)

Activation points, panorama view [234](#)

Activation word [60](#)

Active Blind Spot Detection [184](#)

Active Cruise Control [210](#)

Active damping control, see Adaptive M suspension [247](#)

Active Guard, see Collision warning systems [172](#)

Active Park Distance Control [240](#)

Active Protection [195](#)

Active seat ventilation [256](#)

Adaptive lighting functions [162](#)

Adaptive M suspension [247](#)

Adaptive recuperation [283](#)

Additional camera view displays [230](#)

Advance climate control, see Pre-conditioning [258](#)

Advanced Real Time Traffic Information, see Owner's Manual for Navigation, Entertainment, Communication [6](#)

Airbags [169](#)

Airbags, warning light [171](#)

Air circulation, see Recirculated-air mode [254](#)

Air conditioning, climate [253](#)

Air distribution, manual [252](#)

Air drying, see air conditioning [253](#)

Air flow, automatic climate control [252](#)

Air outlets, see Ventilation [257](#)

Air pressure, tires [301](#)

Air quality [258](#)

Air vent, see Ventilation [257](#)

Alarm, avoiding [96](#)

Alarm signal, high-voltage battery [19](#)

Alarm system [94](#)

Alcantara, care, see Fabric care [352](#)

All-season tires, see Winter tires [310](#)

All-season tires, tread [307](#)

All-wheel drive, see BMW xDrive [201](#)

Ambient light [164](#)

Android Auto, see Owner's Manual for Navigation, Entertainment, Communication [6](#)

Antifreeze, see Washer fluid [333](#)

Antilock Braking System [199](#)

Anti-theft protection, lug bolt lock [327](#)

Anti-trap mechanism, glass sunroof [101](#)

Anti-trap mechanism, windows [98](#)

Apple CarPlay, see Owner's Manual for Navigation, Entertainment, Communication [6](#)

Applications see Owner's Manual for Navigation, Entertainment, Communication [6](#)

Applications, see Owner's Manual for Navigation, Entertainment, Communication [6](#)

Apps, see Owner's Manual for Navigation, Entertainment, Communication [6](#)

Aquaplaning [277](#)

Artificial engine noise, see Acoustic pedestrian protection [123](#)

Assistance, BMW [342](#)
Assistance with breakdown [341](#)
Assistance with driving off on inclines, see drive-off assistant [131](#)
Assisted Driving Mode Plus [223](#)
Assisted Driving Mode, see Steering Assistant [220](#)
Assisted View [153](#)
Attaching radio systems [277](#)
Attachment point of radio systems [277](#)
Audio player, see Owner's Manual for Navigation, Entertainment, Communication [6](#)
Audio, see Owner's Manual for Navigation, Entertainment and Communication [6](#)
Authorized service center, see BMW Accident Assistance [343](#)
Authorized service center, see BMW Roadside Assistance [342](#)
AUTO H, see Automatic Hold [133](#)
Automatic camera perspective [232](#)
Automatic climate control [248](#)
Automatic control, headlight [160](#)
Automatic Curb Monitor, exterior mirror [113](#)
Automatic deactivation, front-seat passenger airbags [171](#)
Automatic deactivation, high-voltage system [20](#)
Automatic dimming, see Automatic High Beam Assistant [158](#)
Automatic headlight control [160](#)
Automatic High Beam Assistant [158](#)
Automatic Hold [133](#)
Automatic locking [93](#)
Automatic Parking Assistant [241](#)
Automatic program, automatic climate control [250](#)
Automatic time setting [154](#)
Automatic unlocking [93](#)
Automatic wiper system, see Rain sensor [166](#)
Automating routines, BMW Intelligent Personal Assistant [63](#)
AUTO program, automatic climate control [250](#)
Average consumption, see Trip data [151](#)

B

Backrest curvature, see Lumbar support [106](#)
Backrest, seats [103](#)
Backrest tilt [105](#)
Backrest width [106](#)
Back-up Assistant [245](#)
Bandages, see First-aid kit [341](#)
Bar for tow-starting/towing [347](#)
Battery, charge state indicator [154](#)
Battery, charging see Vehicle, charging [286](#)
Battery, disposal [339](#)
Battery heat management, see Preparing the high-voltage battery [293](#)
Battery high-voltage system, long stationary periods [299](#)
Battery, vehicle [338](#)
B Brake, see Gear position B [125](#)
Being towed, see Towing [345](#)
Belts, see Seat belts [107](#)
Belt tension [107](#)
Beverage holder, front [269](#)
Beverage holder, rear [269](#)
Blind spot collision warning [184](#)
Blocking, power window, see Safety switch [98](#)
Blower, see Air flow [252](#)
Bluetooth audio, see Owner's Manual for Navigation, Entertainment, Communication [6](#)
Bluetooth connection, see Owner's Manual for Navigation, Entertainment, Communication [6](#)
BMW Accident Assistance [343](#)
BMW app, see Owner's Manual for Navigation, Entertainment, Communication [6](#)
BMW Assist, see Owner's Manual for Navigation, Entertainment and Communication [6](#)
BMW Curved Display [53](#)
BMW Digital Key [89](#)
BMW Drive Recorder [193](#)
BMW eDrive [16](#)
BMW IconicSounds [247](#)
BMW ID [71](#)
BMW iDrive [50](#)
BMW Intelligent Personal Assistant [59](#)
BMW Live Cockpit Plus, see BMW Curved Display [53](#)

BMW Live Cockpit Professional, see BMW Curved Display [53](#)
 BMW maintenance system, see Maintenance system [335](#)
 BMW Operating System, see BMW iDrive [50](#)
 BMW Roadside Assistance [342](#)
 BMW SIM Reader, see Owner's Manual for Navigation, Entertainment, Communication [6](#)
 BMW Theater Screen, see Owner's Manual for Navigation, Entertainment, Communication [6](#)
 BMW xDrive [201](#)
 Bottle holder, front, see Cup holder, front [269](#)
 Bottle holder, rear, see Cup holder, rear [269](#)
 Brake assistant [199](#)
 Brake disks, see Brake system [276](#)
 Brake pads, see Brake system [276](#)
 Brake, see Gear position B [125](#)
 Brake system [276](#)
 Braking, information [278](#)
 Breakdown assistance [341](#)
 Break-in [276](#)
 Break-in procedures [276](#)
 Break recommendation, see Fatigue alert [196](#)
 Brightness, control display [54](#)
 Button, central locking system [91](#)
 Buttons on the steering wheel [36](#)
 Button, SOS, see Intelligent emergency call [343](#)
 Button, Start/Stop [123](#)
 Bypassing, see Jump-starting [345](#)

C

Cable for tow-starting/towing [347](#)
 Calibration of the front seats [106](#)
 California Proposition 65 Warning [10](#)
 Camera cleaning [354](#)
 Camera, instrument cluster, see Driver Attention Camera [197](#)
 Camera lenses, care [354](#)
 Camera perspective, automatic [232](#)
 Camera, rearview camera [232](#)
 Cameras, see Vehicle sensors [41](#)
 Camera view aid lines [230](#)
 CANCEL button, Active Cruise Control [210](#)
 CANCEL button, Cruise Control [207](#)

Care [349](#)
 Care, displays, screens [352](#)
 Care, Head-up display [352](#)
 Care, light-alloy wheels [352](#)
 Care, vehicle [351](#)
 Cargo [271](#)
 Cargo area [271](#)
 Cargo area, enlarging [273](#)
 Cargo cover [274](#)
 Cargo straps, see Lashing eyes in the cargo area [272](#)
 Car key, see Vehicle key [76](#)
 Carpet, care [353](#)
 Car seats, see Transporting children safely [117](#)
 Car wash [349](#)
 Car wash, automatic [349](#)
 Car wash view [234](#)
 CBS, see Condition Based Service [335](#)
 Cell phone, see Owner's Manual for Navigation, Entertainment and Communication [6](#)
 Center armrest, front [268](#)
 Center console [38](#)
 Central display area, instrument cluster [151](#)
 Central Information Display (CID), see Control display [54](#)
 Central locking switch, see Central locking system [91](#)
 Central locking system [91](#)
 Central screen, see Control display [54](#)
 Changes, technical, see For Your Own Safety [9](#)
 Change, wheels and tires [308](#)
 Changing parts [337](#)
 Changing wheels [325](#)
 CHARGE, energy recovery [17](#)
 Charge state indicator, high-voltage battery [154](#)
 Charging cable, high-voltage battery [288](#)
 Charging cradle [264](#)
 Charging display [150](#)
 Charging process, see Charging display [150](#)
 Charging, see Vehicle, charging [286](#)
 Charging settings, location-based [298](#)
 Charging smartphone, see Wireless charging tray [264](#)
 Charging status, indicator light on the charging socket [294](#)

- Charging status indicator, see Charging display [150](#)
- Charging tray for smartphones, see Wireless charging tray [264](#)
- Charging, vehicle [286](#)
- Chassis number, see Vehicle identification number [14](#)
- Check Control [139](#)
- Children, seating position [117](#)
- Children, transporting safely [117](#)
- Child restraint seats [117](#)
- Child restraint system LATCH [119](#)
- Child restraint systems, mounting [118](#)
- Child restraint systems, see Transporting children safely [117](#)
- Child safety latch [122](#)
- Child safety locks [122](#)
- Child seat installation [118](#)
- Child seat, mounting [118](#)
- Child seats, see Transporting children safely [117](#)
- Chrome-plated surfaces, care [352](#)
- Chrome surfaces, care [352](#)
- Cleaning, see Care [351](#)
- Climate comfort windshield, see Attachment point of radio systems [277](#)
- Climate control [248](#)
- Closing with the Key Card [87](#)
- Closing with the smartphone, see BMW Digital Key [89](#)
- Clothes hooks [270](#)
- Coasting [284](#)
- Coasting with idling engine [284](#)
- Coat hooks [270](#)
- Collision warning systems [172](#)
- Comfort Access [82](#)
- COMFORT, see Driving Experience Control [130](#)
- Communication, see Owner's Manual for Navigation, Entertainment and Communication [6](#)
- Comparison of entries, see Entry comparison [52](#)
- Compartments in the doors [268](#)
- Compressor [312](#)
- Concierge Service, see BMW Assist [342](#)
- Condensation water under the parked vehicle [279](#)
- Condensation, windshield [255](#)
- Condition Based Service [335](#)
- ConnectedDrive, see Owner's Manual for Navigation, Entertainment and Communication [6](#)
- ConnectedDrive services, see Owner's Manual for Navigation, Entertainment and Communication [6](#)
- Connected Music, see Owner's Manual for Navigation, Entertainment, Communication [6](#)
- Connecting mobile devices to the vehicle [64](#)
- Connection, electrical devices, see Sockets [262](#)
- Consumption, see Trip data [151](#)
- Contactless trunk opening/closing [86](#)
- Contacts, see Owner's Manual for Navigation, Entertainment, Communication [6](#)
- Contact with water, high-voltage system [19](#)
- Continued driving with a flat tire, see Tire Pressure Monitor [316](#)
- Continued driving with flat tire, see Flat tire monitor [323](#)
- Control display [54](#)
- Controller [55](#)
- Control systems, driving stability [199](#)
- Convoy Assistant, see Assisted Driving Mode Plus [223](#)
- Coolant [333](#)
- Cooling, maximum [253](#)
- Cooling system [333](#)
- Cornering light [163](#)
- Corrosion, brake disks [279](#)
- Cosmetic mirror [262](#)
- Cross Traffic Warning [191](#)
- Cruise Control, see Cruise Control with Distance Control [210](#)
- Cruise Control with Distance Control [210](#)
- Cruise Control without Distance Control [207](#)
- Cup holder, front [269](#)
- Cup holder, rear [269](#)
- Current driving condition [155](#)
- Curved Display [53](#)
- Customer support [342](#)
- ## D
- Damage, tires [308](#)

- Damping control, active, see Adaptive M suspension [247](#)
- Dashboard [36](#)
- Dashboard, see Instrument cluster [136](#)
- Dashcam, see BMW Drive Recorder [193](#)
- Data memory [11](#)
- Data protection, settings [70](#)
- Data, see Personal data, deleting [70](#)
- Data, technical [356](#)
- Date [154](#)
- Day, see Date [154](#)
- Daytime driving lights [162](#)
- Daytime running lights [162](#)
- DC charging cable [288](#)
- DCC, see Cruise Control without Distance Control [207](#)
- Deceleration and energy recovery [127](#)
- Defrosting, windshield [255](#)
- Deleting, personal data [70](#)
- Departure schedule, see Pre-conditioning [258](#)
- Departure time, pre-conditioning [259](#)
- Destination input [6](#)
- Diagnostic connection [336](#)
- Diagnostic socket [336](#)
- Digital Key [89](#)
- Digital key, see BMW Digital Key [89](#)
- Dimmable interior mirror [114](#)
- Dimming exterior mirror [113](#)
- Direct dial buttons, see Shortcuts [53](#)
- Display and operating concept, see BMW iDrive [50](#)
- Display charge state, high-voltage battery [154](#)
- Display, iDrive [52](#)
- Display lighting, see Instrument lighting [163](#)
- Display panel, see Instrument cluster [136](#)
- Displays [136](#)
- Displays and icons [7](#)
- Displays for the vehicle, see Live Vehicle [137](#)
- Display speed limit, see Speed Limit Info [203](#)
- Disposal, vehicle battery [339](#)
- Distance Control, see Cruise Control [210](#)
- Distance Warning, see Park Distance Control [237](#)
- Door handle lighting, see Welcome lights [161](#)
- Door opening angle [236](#)
- Drive-off assistant [131](#)
- Drive power reduced [148](#)
- Driver activity, see Driver Attention Camera [197](#)
- Driver Assistance, parking, see Parking assistance systems [227](#)
- Driver assistance systems [203](#)
- Driver Attention Camera [197](#)
- Drive-ready state in detail [124](#)
- Drive-ready state, see Operating state of vehicle [46](#)
- Drive-ready state, turning off [124](#)
- Drive-ready state, turning on [124](#)
- Drive Recorder [193](#)
- Driver profiles [71](#)
- Driver profiles, welcome screen [71](#)
- Drive sound, see BMW IconicSounds [247](#)
- Driving [123](#)
- Driving Assistant, see Collision warning systems [172](#)
- Driving comfort [247](#)
- Driving condition, display [155](#)
- Driving Experience Control [130](#)
- Driving in detail [127](#)
- Driving instructions, eDRIVE drivetrain [282](#)
- Driving mode, see Driving Experience Control [130](#)
- Driving notes [276](#)
- Driving, see Drive-ready state in detail [124](#)
- Driving stability control systems [199](#)
- Driving style analysis, ECO PRO [283](#)
- Driving through flood [277](#)
- Driving through water [277](#)
- Driving tips, see General driving notes [276](#)
- DSC, see Dynamic Stability Control [199](#)
- Dynamic Cruise Control, see Cruise Control [207](#)
- Dynamic damping, see Adaptive M suspension [247](#)
- Dynamic Stability Control [199](#)
- Dynamic Traction Control [201](#)

E

- ECO PRO, driving style analysis [283](#)
- ECO PRO, see Driving Experience Control [130](#)
- eDRIVE drivetrain, driving instructions [282](#)
- eDRIVE, electric drive, see BMW eDRIVE [16](#)

- Efficient rolling, see Current driving condition [155](#)
- Electric drive, see BMW eDRIVE [16](#)
- Electric drive, see Driving in detail [127](#)
- Electric range [149](#)
- Electromechanical parking brake [132](#)
- Electronic stability program, see Dynamic Stability Control [199](#)
- Emergency brake, see Emergency Stop Assistant [189](#)
- Emergency braking, see PostCrash iBrake [196](#)
- Emergency call [343](#)
- Emergency cargo area release [87](#)
- Emergency release, transmission lock [126](#)
- Emergency Stop Assistant [189](#)
- Emergency unlocking, tailgate [87](#)
- Energy recovery and deceleration [127](#)
- Energy recovery, CHARGE [17](#)
- Engine compartment, see Under the hood [330](#)
- Engine idling when driving, see Coasting [284](#)
- Engine noise, artificial, see Acoustic pedestrian protection [123](#)
- Engine sound, see BMW IconicSounds [247](#)
- Engine start, see Jump-starting [345](#)
- Entering a destination, see Owner's Manual for Navigation, Entertainment, Communication [6](#)
- Entering an address, navigation, see Owner's Manual for Navigation, Entertainment and Communication [6](#)
- Entertainment, see Owner's Manual for Navigation, Entertainment and Communication [6](#)
- Entertainment, selection list in the instrument cluster [147](#)
- Entry comparison [52](#)
- Error indicators, see Check Control [139](#)
- eSIM telephony, see Owner's Manual for Navigation, Entertainment, Communication [6](#)
- ESP, see Dynamic Stability Control [199](#)
- Evasion Assistant, see Forward Collision Mitigation [174](#)
- Event Data Recorder EDR [13](#)
- Exchange, wheels and tires [308](#)
- Exterior lighting, locked vehicle [162](#)
- Exterior mirror [112](#)
- Exterior mirror, Automatic Curb Monitor [113](#)
- Exterior mirror cameras, see Vehicle sensors [41](#)
- External start, see Jump-starting [345](#)
- Eye for towing [347](#)
- Eyes, see Lashing eyes in the cargo area [272](#)
- ## F
- Factory settings, see Vehicle data, resetting [70](#)
- Failure message, see Check Control [139](#)
- Fastening seat belts, see Seat belts [107](#)
- Fatigue Alert [196](#)
- Fatigue Alert, see Driver Attention Camera [197](#)
- Fatigue warner, see Fatigue Alert [196](#)
- Fault indicators, see Check Control [139](#)
- Filter, see Interior filter [258](#)
- Fine wood parts, care [353](#)
- First-aid kit [341](#)
- Flat tire, changing wheels [325](#)
- Flat tire, continued driving, see Flat tire monitor [323](#)
- Flat tire, continued driving, see Tire Pressure Monitor [316](#)
- Flat tire message, see Flat tire monitor [324](#)
- Flat tire message, see Tire Pressure Monitor [319](#)
- Flat tire monitor [323](#)
- Flat tire, repairing [311](#)
- Flat tire, see Flat tire monitor [323](#)
- Flat tire, see Tire Pressure Monitor [316](#)
- Flat tire warning light, see Flat tire monitor [324](#)
- Flat tire warning light, see Tire Pressure Monitor [319](#)
- Flexible Fast Charger [289](#)
- Floor carpet, care [353](#)
- Floor mats, care [353](#)
- Fold-away position, wiper [167](#)
- Fold-out position [167](#)
- Foot brake [278](#)
- Forward Collision Mitigation [174](#)
- Forward Collision Warning, see Forward Collision Mitigation [174](#)
- For Your Own Safety [9](#)
- Front airbags [169](#)
- Front camera, see Vehicle sensors [41](#)

Front lights, replacing, see Lights and bulbs [337](#)
 Front passenger's side exterior mirror, tilting down, see Automatic Curb Monitor [113](#)
 Front passenger airbags, automatic deactivation [171](#)
 Front radar sensor, see Vehicle sensors [41](#)
 Front-seat passenger airbag, indicator light [172](#)
 Front seats [103](#)
 Fuses [339](#)

G

Garage door opener, see Integrated Universal Remote Control [260](#)
 Gear position B [125](#)
 Gear position, see Selector lever positions [124](#)
 General driving notes [276](#)
 Glare shield, see Sun visor [262](#)
 Glass sunroof [99](#)
 Glass sunroof, initializing the glass sunroof and sun protection [101](#)
 Glove compartment [267](#)
 G-Meter [154](#)
 GPS navigation, navigation, see Owner's Manual for Navigation, Entertainment, Communication [6](#)
 Guest profile, see BMW ID [71](#)

H

Handbrake, see Parking brake [132](#)
 Hand-held transmitter, alternating code [261](#)
 Hands-free device, see Owner's Manual for Navigation, Entertainment, Communication [6](#)
 Hands-free system [6](#)
 Hazard warning system [341](#)
 Head airbag [169](#)
 Headlight control, automatic [160](#)
 Headlight flasher [157](#)
 Headlight glass [338](#)
 Headlights, care [350](#)
 Headlights, replacing, see Lights and bulbs [337](#)
 Headlights, turning up, dimming, see Automatic High Beam Assistant [158](#)

Headliner [40](#)
 Head restraints and seats [103](#)
 Head restraints, front [109](#)
 Head restraints, rear [111](#)
 Head-up display [138](#)
 Head-up display, care [352](#)
 Head-up display, store position, see Memory function [115](#)
 Heavy cargo, stowing [272](#)
 High-beam headlights [157](#)
 Higher speed range [277](#)
 High-voltage battery, alarm signal [19](#)
 High-voltage battery, charge state indicator [154](#)
 High-voltage battery, heated [129](#)
 High-voltage battery, heavily discharged [129](#)
 High-voltage battery, long stationary periods [299](#)
 High-voltage battery, service life [299](#)
 High-voltage battery, vehicle shutdown [299](#)
 High-voltage system, automatic deactivation [20](#)
 High-voltage system battery, vehicle shutdown [299](#)
 High-voltage system, contact with water [19](#)
 High-voltage system, safety [19](#)
 High-voltage system, work [19](#)
 Hill Ascent Control, see drive-off assistant [131](#)
 Hills [278](#)
 Hill-start assist, see drive-off assistant [131](#)
 HomeLink, see Integrated Universal Remote Control [260](#)
 Homepage, see Internet [7](#)
 Hood [330](#)
 Horn [36](#)
 Hotel function, see Valet parking mode [92](#)
 Hotline, see Customer support [342](#)
 Hour, see Time [154](#)

I

iBrake PostCrash [196](#)
 Ice warning, see Outside temperature [150](#)
 IconicSounds [247](#)
 Icons and displays [7](#)
 Identification marks, tires [306](#)

Identification number, see Vehicle identification number [14](#)

Idle state, see Operating state of vehicle [46](#)

iDrive [50](#)

Inclination [105](#)

Increasing the range [281](#)

Indicator light, front-seat passenger airbag [172](#)

Indicator light on the charging socket, see Display, charging status [294](#)

Indicator lights [140](#)

Individual air distribution [252](#)

Individual settings, see BMW ID [71](#)

Inductive charging, smartphone, see Wireless charging tray [264](#)

Information [6](#)

Information on Driver Assistance, displaying, see Assisted View [153](#)

Information window, control display [53](#)

Initialization, see flat tire monitor [323](#)

Input, iDrive [52](#)

Installation of child restraint systems [118](#)

Instrument cluster [136](#)

Instrument lighting [163](#)

Instrument panel, see Instrument cluster [136](#)

Integrated key [77](#)

Integrated Owner's Manual in the vehicle [6](#)

Integrated Universal Remote Control [260](#)

Intelligent emergency call [343](#)

Intelligent Personal Assistant [59](#)

Intelligent Safety, see Collision warning systems [172](#)

Intended use [9](#)

Interior equipment [260](#)

Interior filter [258](#)

Interior lights [164](#)

Interior lights, locked vehicle [162](#)

Interior mirror [114](#)

Interior mirror, automatic dimming feature [114](#)

Interior mirror, manually dimmable [114](#)

Interior motion sensor [96](#)

Internet page [7](#)

Intersection Collision Warning, see Forward Collision Mitigation [174](#)

Interval indicator, see Service notifications [156](#)

J

Jacking points [328](#)

Jacking points for the vehicle jack [328](#)

Journey data [151](#)

Jump-starting [345](#)

K

Key Card [87](#)

Keyless Go, see Comfort Access [82](#)

Key, mechanical [77](#)

Key, see Vehicle key [76](#)

Knee airbag [170](#)

L

Labeling [306](#)

Lane boundary [181](#)

Lane Change Assistant [225](#)

Lane departure warning [181](#)

Lane Keeping Assistant, see Steering Assistant [220](#)

Lane Keeping Assistant with active side collision protection, see Side Collision Warning [187](#)

Lane lines, additional camera view displays [230](#)

Lane threshold, warning [181](#)

Language, setting [62](#)

Laser headlights, changing, see Lights and bulbs [337](#)

Lashing eyes in the cargo area [272](#)

LATCH child restraint system [119](#)

Lateral Parking Aid [232](#)

Launch Control [129](#)

Leather care [351](#)

LED headlights, changing, see Lights and bulbs [337](#)

Letters and numbers, entering [52](#)

Level 1 charging cable, see Mode 2 charging cable [288](#)

Level 1 charging, see Charging vehicle [286](#)

Level 2 charging cable, see Mode 3 charging cable [288](#)

Level 3 charging cable, see DC charging cable [288](#)
 Light-alloy wheels, care [352](#)
 Light carpet, see Welcome Light Carpet [161](#)
 Light in exterior mirror, see Active Blind Spot Detection [184](#)
 Light in exterior mirror, see Cross Traffic Warning [191](#)
 Lighting [159](#)
 Light replacement, see Lights and bulbs [337](#)
 Lights [157](#)
 Lights and bulbs [337](#)
 Lights, care [350](#)
 Light switch [159](#)
 LIM button, see Manual Speed Limiter [205](#)
 List, instrument cluster, see Selection lists [147](#)
 Live Cockpit Plus, see BMW Curved Display [53](#)
 Live Cockpit Professional, see BMW Curved Display [53](#)
 Live Vehicle [137](#)
 Load [272](#)
 Loading [271](#)
 Loading the cargo area, see Cargo [271](#)
 Local time, see Time [154](#)
 Location-based charging settings [298](#)
 Locking, see Opening and Closing [76](#)
 Locking, settings [93](#)
 Locking the rear automatic climate control [250](#)
 Lock, lug bolts [327](#)
 Long stationary periods, high-voltage battery [299](#)
 Loop, see Towing eye [347](#)
 Low-beam headlights [161](#)
 Lower back support, see Lumbar support [106](#)
 Lug bolt lock [327](#)
 Luggage rack, refer to Roof bars [279](#)
 Luggage straps [272](#)
 Lumbar support [106](#)

M

Maintenance [335](#)
 Maintenance recommendation, see Condition Based Service [335](#)
 Maintenance system [335](#)
 Make-up mirror [262](#)

Malfunction, vehicle key [79](#)
 Manually unlocking doors, see Integrated key [77](#)
 Manual Speed Limiter [205](#)
 Map, see Owner's Manual for Navigation, Entertainment, Communication [6](#)
 Map update, see Owner's Manual for Navigation, Entertainment, Communication [6](#)
 Marking, run-flat tire [311](#)
 Matte paintwork [351](#)
 Matt paint, care [351](#)
 Maximum cooling [253](#)
 Maximum speed, display, see Speed Limit Info [203](#)
 Maximum speed, winter tires [310](#)
 Medical supplies, see First-aid kit [341](#)
 Memory function [115](#)
 Messages, see Check Control [139](#)
 Messages, see Owner's Manual for Navigation, Entertainment, Communication [6](#)
 Meters, see Instrument cluster [136](#)
 Microfilter, see Interior filter [258](#)
 Minimum tread depth, tires [308](#)
 Minute, see Time [154](#)
 Mobile communications in the vehicle [277](#)
 Mobile devices, connecting [64](#)
 Mobile phone, see Owner's Manual for Navigation, Entertainment and Communication [6](#)
 Mobile Service, see BMW Accident Assistance [343](#)
 Mobile Service, see BMW Roadside Assistance [342](#)
 Mobility system, see Tire repair set [311](#)
 Mode 2 charging cable [288](#)
 Mode 2 charging, see Vehicle, charging [286](#)
 Mode 3 charging cable [288](#)
 Mode 4 charging cable, see DC charging cable [288](#)
 MODE button, see Active Cruise Control [210](#)
 Modifications, technical, see For Your Own Safety [9](#)
 Moisture in headlight, see Headlight glass [338](#)
 Monitoring of the high-voltage battery [19](#)
 Monitor, see Control display [54](#)
 Mounting of child restraint systems [118](#)

MP3 player, see Owner's Manual for Navigation, Entertainment, Communication [6](#)
M suspension, adaptive, see Adaptive M suspension [247](#)
Mug holder, front, see Cup holder, front [269](#)
Mug holder, rear, see Cup holder, rear [269](#)
Multifunction hook [272](#)
Multi-function steering wheel [36](#)
Multifunction steering wheel, buttons [36](#)
My BMW app, see Owner's Manual for Navigation, Entertainment, Communication [6](#)

N

Neck restraints, front, see Head restraints, front [109](#)
Neck restraints, rear, see Head restraints, rear [111](#)
Net, cargo area [273](#)
Neutral cleaner, see Light-alloy wheels, care [352](#)
Notifications, see Owner's Manual for Navigation, Entertainment, Communication [6](#)
No-touch opening and closing of the tailgate [86](#)
Nylon rope for tow-starting/towing [347](#)

O

OBD, see On-board diagnosis [336](#)
Obstacle marking, additional camera view displays [230](#)
Odometer, see Trip data [151](#)
OFF indicator, see Standby and drive-ready state [149](#)
Old battery [339](#)
On-board computer, see Trip data [151](#)
On-board diagnosis [336](#)
Onboard toolkit [337](#)
On-call service, see BMW Accident Assistance [343](#)
On-call service, see BMW Roadside Assistance [342](#)
One-touch signaling [157](#)
Opening and closing [76](#)
Opening and closing the cargo area [84](#)

Opening and closing the tailgate [84](#)
Opening with the Key Card [87](#)
Opening with the smartphone, see BMW Digital Key [89](#)
Operating fluids [333](#)
Operating principle, see BMW iDrive [50](#)
Operating state of vehicle [46](#)
Operating system, see BMW iDrive [50](#)
Operation via voice [59](#)
Optional equipment, see Vehicle equipment [8](#)
Outside temperature [150](#)
Overwintering, see Long-term vehicle storage [336](#)
Owner's Manual via voice operation, BMW Intelligent Personal Assistant [61](#)

P

Paint, vehicle care [351](#)
Paintwork [351](#)
Panic alarm, see Panic mode [95](#)
Panic mode [95](#)
Panorama View [234](#)
Panorama View, see Panorama View [234](#)
Panoramic display, see Owner's Manual for Navigation, Entertainment, Communication [6](#)
Panoramic glass sunroof, see Glass sunroof [99](#)
Park Distance Control [237](#)
Parked car ventilation, see Pre-conditioning [258](#)
Parking aid lines, additional camera view displays [230](#)
Parking assistance systems [227](#)
Parking assistant [241](#)
Parking Assistant Plus, see Parking assistance systems [227](#)
Parking Assistant, see Park Distance Control [237](#)
Parking Assistant, see Parking assistance systems [227](#)
Parking brake [132](#)
Parking brake function, see Active Park Distance Control [240](#)
Parking lights [160](#)
Parking with Automatic Hold [133](#)

Parts and accessories [9](#)
 Pathway lighting [162](#)
 Pathway lighting, turning on [162](#)
 Payload [272](#)
 PDC, see Park Distance Control [237](#)
 Pedestrian protection, acoustic [123](#)
 Pedestrian Warning, see Forward Collision Mitigation [174](#)
 Performance display, see Sport displays [156](#)
 Personal Assistant [59](#)
 Personal data, deleting [70](#)
 Personal eSIM, see Owner's Manual for Navigation, Entertainment, Communication [6](#)
 Personal hotspot, see Owner's Manual for Navigation, Entertainment, Communication [6](#)
 Personal profile, see BMW ID [71](#)
 Personal settings [70](#)
 Physical units, see Setting units of measurement [155](#)
 Plastic parts, care [353](#)
 Plug & Charge [292](#)
 Pop-up [53](#)
 PostCrash iBrake [196](#)
 Power Display, instrument cluster [148](#)
 Power failure [339](#)
 Power interruption [339](#)
 Power Meter, see Power Display [148](#)
 Power windows [96](#)
 Pre-conditioning [258](#)
 PreCrash functions, see Active Protection [195](#)
 Preparing the battery, see Preparing the high-voltage battery [293](#)
 Preparing the high-voltage battery [293](#)
 Pressure monitor, tire, see Tire Pressure Monitor [316](#)
 Pressure, tires [301](#)
 Pressure warning, see Flat tire monitor [323](#)
 Pressure warning, see Tire Pressure Monitor [316](#)
 Pretensioning, seat belt [107](#)
 Prevention of rear-end collision, see Rear-end collision preparation [189](#)
 Primary user, see BMW ID [72](#)
 Protective function, glass sunroof, see Anti-trap mechanism [101](#)

Protective function, windows, see Anti-trap mechanism [98](#)
 Push-and-turn reel, see Controller [55](#)

Q

Quick charging cable, see Mode 3 charging cable [288](#)

R

Racing track [279](#)
 Radar sensors, see Vehicle sensors [41](#)
 Radiator fluid [333](#)
 Radio information, see Owner's Manual for Navigation, Entertainment, Communication [6](#)
 Radio, see Owner's Manual for Navigation, Entertainment and Communication [6](#)
 Radio stations, see Owner's Manual for Navigation, Entertainment, Communication [6](#)
 Rain sensor [166](#)
 Rain sensor mode [166](#)
 Range [149](#)
 READY indicator, see Standby and drive-ready state [149](#)
 Rear automatic climate control [248](#)
 Rear-end collision preparation [189](#)
 Rear lights, replacing, see Lights and bulbs [337](#)
 Rear seat backrests, folding down [273](#)
 Rearview camera [232](#)
 Rearview camera, see Vehicle sensors [41](#)
 Rear-view mirror, exterior [112](#)
 Rear-view mirror, interior [114](#)
 Rear window defroster [255](#)
 Rechargeable battery, charging, see Vehicle, charging [286](#)
 Recirculated-air mode [254](#)
 Recirculating air filter, see Interior filter [258](#)
 Recommended tire brands [309](#)
 Recuperation, adaptive [283](#)
 Recuperative braking, see Energy recovery [17](#)
 Reduced drive power [148](#)
 Remaining range, see Range [149](#)
 Remote 3D View [236](#)
 Remote control, see Vehicle key [76](#)

- Remote control, universal [260](#)
 - Remote services, see Owner's Manual for Navigation, Entertainment, Communication [6](#)
 - Remote Software Upgrade [66](#)
 - Renewal, wheels and tires [308](#)
 - Replacement, wheels and tires [308](#)
 - Replacing bulbs, see Lights and bulbs [337](#)
 - Replacing light diodes, see Lights and bulbs [337](#)
 - Replacing parts [337](#)
 - Replacing the battery, vehicle key [77](#)
 - Reporting safety malfunctions [15](#)
 - RES CNCL button, Active Cruise Control [210](#)
 - RES CNCL button, Cruise Control [207](#)
 - Reserve warning, see Range [149](#)
 - Reservoir, washer fluid [333](#)
 - Resetting, vehicle data [70](#)
 - Reset, Tire Pressure Monitor [318](#)
 - Reset, vehicle settings [70](#)
 - Restricted Driving, see BMW Digital Key [89](#)
 - RESUME button, Active Cruise Control [210](#)
 - RESUME button, Cruise Control [207](#)
 - Retreaded tires [309](#)
 - Reversing Assistant [245](#)
 - Roadside Assistance, see BMW Roadside Assistance [342](#)
 - Roadside parking lights [161](#)
 - Rolling code hand-held transmitter [261](#)
 - Rolling to a stop with engine decoupled, see Coasting [284](#)
 - Roof bars [279](#)
 - Roofliner [40](#)
 - Roof luggage rack, refer to Roof bars [279](#)
 - Rope for tow-starting/towing [347](#)
 - Route, navigation, see Owner's Manual for Navigation, Entertainment, Communication [6](#)
 - RSC, see Runflat tires [311](#)
 - Rubber components, care [353](#)
 - Runflat tires [311](#)
 - Runflat tires, see Runflat tires [311](#)
- S**
- Safe braking [278](#)
 - Safe Share function, see BMW Digital Key [89](#)
 - Safety and warning, see Collision warning systems [172](#)
 - Safety locks, doors, and windows [122](#)
 - Safety of the high-voltage system [19](#)
 - Safety package, see Active Protection [195](#)
 - Safety switch, windows [98](#)
 - Safety systems, see Airbags [169](#)
 - Safety systems, see Collision warning systems [172](#)
 - Satellite radio, see Owner's Manual for Navigation, Entertainment, Communication [6](#)
 - Saved stations, see Owner's Manual for Navigation, Entertainment, Communication [6](#)
 - Screen, see BMW Curved Display [53](#)
 - Screen, see Control display [54](#)
 - Sealant, see Tire repair set [311](#)
 - Search for charging stations, see Owner's Manual for Navigation, Entertainment, Communication [6](#)
 - Seat belt reminder, see Seat belt warning [108](#)
 - Seat belts [107](#)
 - Seat belts, care [353](#)
 - Seat belt warning [108](#)
 - Seat calibration [106](#)
 - Seat heating [255](#)
 - Seating position for children [117](#)
 - Seats and head restraints [103](#)
 - Seats, front [103](#)
 - Seat ventilation, active [256](#)
 - Securing, cargo [272](#)
 - Securing vehicle to prevent rolling away, see Parking brake [132](#)
 - Selection list on the instrument cluster [147](#)
 - Selector lever position [124](#)
 - Selector lever position B, see Energy recovery [B 124](#)
 - Selector lever position B, see Gear position [B 125](#)
 - Selector lever positions, see Steptronic transmission [124](#)
 - Sensors, care [354](#)
 - Service and warranty [10](#)
 - Service life of high-voltage battery [299](#)
 - Service notifications [156](#)
 - Service notifications, see Condition Based Service [335](#)

- Servotronic [202](#)
- SET button, Active Cruise Control [210](#)
- SET button, Cruise Control [207](#)
- Setting the time, see Time [154](#)
- Setting units of measurement [155](#)
- Shortcuts, iDrive [53](#)
- Side airbag [169](#)
- Side Collision Warning [187](#)
- Side protection, see Automatic camera perspective [232](#)
- Side view [233](#)
- Signaling, horn [36](#)
- Signals when unlocking, see Confirmation signals [93](#)
- SIM Reader, see Owner's Manual for Navigation, Entertainment, Communication [6](#)
- Sitting safely [103](#)
- Slipperiness, see Outside temperature [150](#)
- Slippery road, see Outside temperature [150](#)
- Smartphone, see Owner's Manual for Navigation, Entertainment and Communication [6](#)
- Smartphone, using via voice control [63](#)
- Snow chains [315](#)
- Sockets, electrical devices [262](#)
- Software Update, see Remote Software Upgrade [66](#)
- Software Upgrade, see Remote Software Upgrade [66](#)
- SOS button, see Intelligent emergency call [343](#)
- Sound settings, see Owner's Manual for Navigation, Entertainment, Communication [6](#)
- Sound system, see Owner's Manual for Navigation, Entertainment, Communication [6](#)
- Speed control, see Cruise Control [207](#)
- Speed Limit Assist [217](#)
- Speed Limit Assistant [217](#)
- Speed Limit Device, Speed Limiter [205](#)
- Speed limit, display, see Speed Limit Info [203](#)
- Speed Limit Info [203](#)
- Speed warning [203](#)
- SPORT BOOST, see Driving Experience Control [130](#)
- Sport displays [156](#)
- Sport steering, variable [202](#)
- Sport suspension, see Adaptive M suspension [247](#)
- Stability control systems [199](#)
- Standard charging cable [288](#)
- Standard charging, see Vehicle, charging [286](#)
- Standard equipment, see Vehicle equipment [8](#)
- Standby state, see Operating state of vehicle [46](#)
- Start/Stop button, driving [123](#)
- Starting the engine with the Key Card [87](#)
- Starting vehicle [123](#)
- Start Stop button [123](#)
- Stations, see Owner's Manual for Navigation, Entertainment, Communication [6](#)
- Status control display, tires [317](#)
- Status information, iDrive [51](#)
- Status of Owner's Manual [8](#)
- Status, vehicle [155](#)
- Steering Assistant [220](#)
- Steering column adjustment [114](#)
- Steering support, see Servotronic [202](#)
- Steering wheel, adjusting [114](#)
- Steering wheel, buttons [36](#)
- Storage, charging cable [289](#)
- Storage compartment, center console [268](#)
- Storage compartments [267](#)
- Storage, tires [310](#)
- Store Mirror position, see Memory function [115](#)
- Store seat position, see Memory function [115](#)
- Store steering wheel position, see Memory function [115](#)
- Storing the vehicle [336](#)
- Stowage, cargo [272](#)
- Stowing the charging cable, see Storage [289](#)
- Straps for cargo, see Lashing eyes in the cargo area [272](#)
- Summer tires, tread [307](#)
- Sun visor [262](#)
- Supplementary Owner's Handbooks [7](#)
- Supplementary Owner's Manuals [7](#)
- Suspension settings, see Driving Experience Control [130](#)
- Switches, see Dashboard [36](#)
- Switch for driving dynamics, see Driving Experience Control [130](#)
- SYNC program, automatic climate control [254](#)
- System language, setting, see Language, setting [62](#)

T

- Tailgate, emergency unlocking [87](#)
- Tailgate, opening and closing with no-touch activation [86](#)
- Tail lights, replacing, see Lights and bulbs [337](#)
- Taking the vehicle out of service [336](#)
- Technical changes, see For Your Own Safety [9](#)
- Technical data [356](#)
- Telephone, see Owner's Manual for Navigation, Entertainment and Communication [6](#)
- Telephone, selection list in the instrument cluster [147](#)
- Teleservices, see Owner's Manual for Navigation, Entertainment, Communication [6](#)
- Temperature, automatic climate control [251](#)
- Temperature display, see outside temperature [150](#)
- Theft alarm system, see Alarm system [94](#)
- Thigh support [106](#)
- Tilt alarm sensor [96](#)
- Tilt, backrest [105](#)
- Tilting down, front passenger's side exterior mirror, see Automatic Curb Monitor [113](#)
- Time [154](#)
- Time of day, see Time [154](#)
- Time setting, automatic [154](#)
- Time zone [154](#)
- Tire brands, recommendation [309](#)
- Tire change [308](#)
- Tire damage [308](#)
- Tire identification marks [306](#)
- Tire inflation pressure [301](#)
- Tire marking [306](#)
- Tire pressure [301](#)
- Tire Pressure Monitor [316](#)
- Tire pressure monitoring, see Flat tire monitor [323](#)
- Tire Pressure Monitor, reset [318](#)
- Tire pressure, tires [301](#)
- Tire pressure warning, see Flat tire monitor [323](#)
- Tire repair set [311](#)
- Tires and wheels [301](#)
- Tire sealant, see Tire repair set [311](#)
- Tire settings [316](#)
- Tires, run-flat [311](#)
- Tire tread [307](#)
- Tools [337](#)
- Torque display, see Sport displays [156](#)
- Touchpad, Controller [57](#)
- Tow bar [347](#)
- Towing [345](#)
- Towing eye [347](#)
- Tow rope [347](#)
- Traction Control [201](#)
- Traction control system, see Dynamic Stability Control [199](#)
- TRACTION, driving dynamics [201](#)
- Traction, see Dynamic Traction Control [201](#)
- Traffic bulletins, see Owner's Manual for Navigation, Entertainment, Communication [6](#)
- Traffic Jam Assistant, see Assisted Driving Mode Plus [223](#)
- Traffic jam assistant, see Steering and Lane Control Assistant [220](#)
- Transporting children safely [117](#)
- Tread, tires [307](#)
- Trip data [151](#)
- Trip odometer, see Trip data [151](#)
- Trunk, see Cargo area [271](#)
- Turn indicators, see Turn signals [157](#)
- Turning circle lines, additional camera view displays [230](#)
- Turn signal, indicator light [144](#)
- Turn signal, replacing bulbs, see Lights and bulbs [337](#)
- Turn signals [157](#)

U

- Ultrasonic sensors, see Vehicle sensors [41](#)
- Unintended alarm, see Unintentional alarm, avoiding [96](#)
- Unintentional alarm, avoiding [96](#)
- Units, see Setting units of measurement [155](#)
- Universal remote control [260](#)
- Unlocking, see Opening and Closing [76](#)
- Unlocking, settings [93](#)
- Unlocking the transmission lock, electronic [126](#)
- Updates made after the editorial deadline [8](#)
- Upgrade, see Remote Software Upgrade [66](#)

Upholstery material care [352](#)
 Upper retaining strap, top tether [120](#)
 USB audio, see Owner's Manual for Navigation, Entertainment, Communication [6](#)
 USB port, position in vehicle [263](#)
 Used battery, disposing of [339](#)
 Use, intended [9](#)
 User, see BMW ID [71](#)
 Using menus, see BMW iDrive [50](#)

V

Valet parking mode [92](#)
 Vanity mirror [262](#)
 Variable sport steering [202](#)
 Vehicle battery [338](#)
 Vehicle breakdown, see Breakdown assistance [341](#)
 Vehicle care [351](#)
 Vehicle care products [351](#)
 Vehicle, charging [286](#)
 Vehicle data, resetting [70](#)
 Vehicle equipment [8](#)
 Vehicle identification number [14](#)
 Vehicle issues [341](#)
 Vehicle key [76](#)
 Vehicle key, additional [76](#)
 Vehicle key, loss [77](#)
 Vehicle paint, care [351](#)
 Vehicle paintwork [351](#)
 Vehicle rolling away, see Parking brake [132](#)
 Vehicle sensors [41](#)
 Vehicle shutdown, high-voltage battery [299](#)
 Vehicle starting [123](#)
 Vehicle status [155](#)
 Vehicle storage [336](#)
 Ventilation [257](#)
 Venting, see Pre-conditioning [258](#)
 Venting, see Ventilation [257](#)
 Version Software, see Remote Software Upgrade [66](#)
 Video recording, see BMW Drive Recorder [193](#)
 Video, see Owner's Manual for Navigation, Entertainment and Communication [6](#)
 VIN, see Vehicle identification number [14](#)
 Voice activation system [59](#)

Voice control [59](#)
 Voice control, see BMW Intelligent Personal Assistant [59](#)
 Voice recognition [59](#)
 Volume, see Owner's Manual for Navigation, Entertainment, Communication [6](#)

W

Wake word [60](#)
 Warning for crossing traffic [191](#)
 Warning function, rear-end collision [189](#)
 Warning light in exterior mirror, see Active Blind Spot Detection [184](#)
 Warning light in exterior mirror, see Cross Traffic Warning [191](#)
 Warning lights [140](#)
 Warning messages, see Check Control [139](#)
 Warning systems for collision hazards [172](#)
 Warning triangle [341](#)
 Warranty [9](#)
 Warranty Booklet, see Warranty [9](#)
 Washer fluid [333](#)
 Washing the vehicle [349](#)
 Washing, vehicle [349](#)
 Water, high-voltage system [19](#)
 Water on road [277](#)
 Water, see Condensation water under the parked vehicle [279](#)
 Website, see Internet [7](#)
 Welcome Light Carpet, see Welcome light [161](#)
 Welcome lights [161](#)
 Welcome screen, driver profiles [71](#)
 Wheel change [325](#)
 Wheels and tires [301](#)
 Wheels and tires, exchange [308](#)
 Widgets, iDrive [51](#)
 Widgets, instrument cluster, see Central display area [151](#)
 Wi-Fi connection, see Owner's Manual for Navigation, Entertainment, Communication [6](#)
 Wind deflector, defrosting [255](#)
 Wind deflector, removing condensation [255](#)
 Window, defrosting [255](#)
 Windows, powered [96](#)

Windshield cleaning system, see Wiper system [165](#)
Windshield, defrosting [255](#)
Windshield, removing condensation [255](#)
Windshield washer fluid, see Washer fluid [333](#)
Windshield wipers, see Wiper system [165](#)
Winter storage, see Long-term vehicle storage [336](#)
Winter tires [310](#)
Winter tires, tread [307](#)
Wiper blades, replacing [337](#)
Wiper fluid, see Washer fluid [333](#)
Wiper, fold-away position [167](#)
Wipers, see Wiper system [165](#)
Wiper system [165](#)
Wireless charging, smartphone, see Wireless charging tray [264](#)
Wireless charging tray for smartphones [264](#)
Wood parts, care [353](#)
Wordmatch principle, see Entry comparison [52](#)

X

xDrive [201](#)



01405B45E30 ue

California Proposition 65 Warning

For vehicles sold in California:

California Proposition 65 Warning



WARNING

Operating, servicing and maintaining a passenger vehicle or off-highway motor vehicle can expose you to chemicals including engine exhaust, carbon monoxide, phthalates, and lead, which are known to the State of California to cause cancer and birth defects or other reproductive harm. To minimize exposure, avoid breathing exhaust, do not idle the engine except as necessary, service your vehicle in a well-ventilated area and wear gloves or wash your hands frequently when servicing your vehicle. For more information go to www.P65Warnings.ca.gov/passenger-vehicle.

BMW DRIVER'S GUIDE APP.

YOUR DIGITAL VEHICLE INFORMATION.

The BMW Driver's Guide app explains the equipment of your vehicle and offers further scopes and functions:

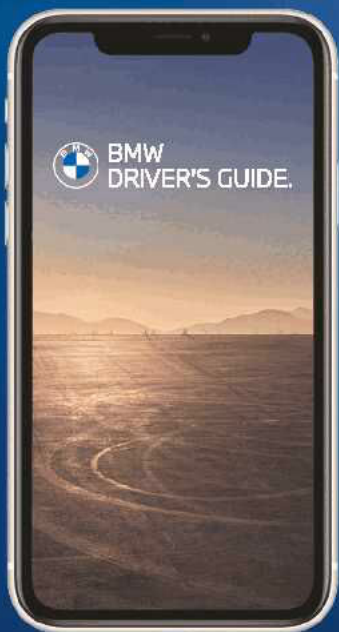

All information surrounding navigation, entertainment and communication

Photorealistic animations for various vehicle functions

Keyword search

360° view: Explore your vehicle interactively inside and out

Smart Scan for Apple iPhone: Icon and optical character recognition on the buttons in the vehicle

Available in more than 30 languages

Can be used offline after download

