

<b>Pictorial index</b>	Search by illustration	
<b>For safety and security</b>	Make sure to read through them (Main topics: Child seat, theft deterrent system)	1
<b>Vehicle status information and indicators</b>	Reading driving-related information (Main topics: Meters, multi-information display)	2
<b>Before driving</b>	Opening and closing the doors and windows, adjustment before driving (Main topics: Keys, doors, seats)	3
<b>Driving</b>	Operations and advice which are necessary for driving (Main topics: Starting engine, refueling)	4
<b>Interior features</b>	Usage of the interior features (Main topics: Air conditioner, storage features)	5
<b>Maintenance and care</b>	Caring for your vehicle and maintenance procedures (Main topics: Interior and exterior, light bulbs)	6
<b>When trouble arises</b>	What to do in case of malfunction and emergency (Main topics: Battery discharge, flat tire)	7
<b>Vehicle specifications</b>	Vehicle specifications, customizable features (Main topics: Fuel, oil, tire inflation pressure)	8
<b>For owners</b>	Reporting safety defects for U.S. owners, and seat belt, SRS airbag and headlight aim instructions for Canadian owners	9
<b>Index</b>	Search by symptom	
	Search alphabetically	

For your information .....	5
Reading this manual .....	10
How to search .....	11
Pictorial index .....	12

## 1 For safety and security

<b>1-1. For safe use</b>	
Before driving .....	22
For safe driving .....	23
Seat belts .....	25
SRS airbags .....	29
Front passenger occupant classification system .....	56
Exhaust gas precautions .....	62
<b>1-2. Child safety</b>	
Riding with children .....	63
Child restraint systems .....	64
<b>1-3. Emergency assistance</b>	
Safety Connect .....	75
<b>1-4. Theft deterrent system</b>	
Engine immobilizer system .....	80
Alarm .....	81

## 2 Vehicle status information and indicators

<b>2-1. Instrument cluster</b>	
Warning lights and indicators .....	84
Gauges and meters .....	88
Multi-information display .....	93

## 3 Before driving

<b>3-1. Key information</b>	
Keys .....	102
<b>3-2. Opening, closing and locking the doors and trunk</b>	
Doors .....	105
Trunk .....	107

Smart key system .....	111
------------------------	-----

### 3-3. Adjusting the seats

Front seats .....	119
Rear seats .....	121
Head restraints .....	123

### 3-4. Adjusting the steering wheel and mirrors

Steering wheel .....	125
Inside rear view mirror .....	126
Outside rear view mirrors .....	127

### 3-5. Opening, closing the windows

Power windows .....	129
---------------------	-----

## 4 Driving

### 4-1. Before driving

Driving the vehicle .....	132
Cargo and luggage .....	140
Vehicle load limits .....	143
Trailer towing .....	143
Dinghy towing .....	144

### 4-2. Driving procedures

Engine (ignition) switch .....	145
Automatic transmission .....	149
Manual transmission .....	153
Turn signal lever .....	155
Parking brake .....	156
ASC (Active Sound Control) .....	157

### 4-3. Operating the lights and wipers

Headlight switch .....	158
High Beam Assist .....	162
Windshield wipers and washer .....	165

### 4-4. Refueling

Opening the fuel tank cap ..	167
------------------------------	-----

### 4-5. EyeSight

EyeSight .....	170
----------------	-----

Pre-Collision Braking System ..... 179

Adaptive Cruise Control ..... 190

Conventional Cruise Control ..... 207

Pre-Collision Throttle Management ..... 215

Lane Departure Warning .... 220

Lane Sway Warning ..... 222

Lead Vehicle Start Alert..... 224

List of alert/notification sounds ..... 226

EyeSight malfunction and temporary stop ..... 228

**4-6. Using other driving systems**

BSD/RCTA ..... 232

Reverse Automatic Braking (RAB) system ..... 240

Rear view camera ..... 250

Conventional Cruise Control ..... 255

Driving mode select switch ..... 258

Hill-start assist control ..... 259

Driving assist systems..... 262

**4-7. Driving tips**

Winter driving tips..... 266

**5 Interior features**

**5-1. Using the air conditioning system**

Automatic air conditioning system ..... 270

Seat heaters..... 276

**5-2. Using the interior lights**

Interior lights list ..... 277

**5-3. Using the storage features**

List of storage features ..... 279

Trunk features ..... 282

**5-4. Using the other interior features**

Other interior features ..... 283

**6 Maintenance and care**

**6-1. Maintenance and care**

Cleaning and protecting the vehicle exterior..... 288

Cleaning and protecting the vehicle interior..... 291

Cleaning and protecting the Ultrasuede® area ..... 293

**6-2. Maintenance**

Maintenance requirements ..... 295

General maintenance..... 296

Emission inspection and maintenance (I/M) programs ..... 299

**6-3. Do-it-yourself maintenance**

Do-it-yourself service precautions ..... 300

Hood ..... 302

Positioning a floor jack ..... 303

Engine compartment..... 305

Tires ..... 312

Replacing the tire ..... 319

Tire inflation pressure..... 323

Wheels ..... 325

Air conditioning filter..... 327

Electronic key battery..... 328

Checking and replacing fuses ..... 330

Headlight aim ..... 332

Light bulbs..... 333

**7 When trouble arises**

**7-1. Essential information**

Emergency flashers ..... 338



<p>If your vehicle has to be stopped in an emergency ..... 338</p> <p>If the vehicle is submerged or water on the road is rising ..... 339</p> <p><b>7-2. Steps to take in an emergency</b></p> <p>If your vehicle needs to be towed ..... 341</p> <p>If you think something is wrong ..... 346</p> <p>Fuel pump shut off system ..... 347</p> <p>If a warning light turns on or a warning buzzer sounds .... 348</p> <p>If a warning message is displayed ..... 357</p> <p>If you have a flat tire ..... 358</p> <p>If the engine will not start ... 367</p> <p>If you lose your keys ..... 369</p> <p>If the fuel filler door cannot be opened ..... 369</p> <p>If the electronic key does not operate properly ..... 370</p> <p>If the vehicle battery is discharged ..... 372</p> <p>If your vehicle overheats .... 375</p> <p>If the vehicle becomes stuck ..... 377</p>	<div style="border: 1px solid black; padding: 5px; margin-bottom: 10px;"> <p><b>9 For owners</b></p> </div> <p><b>9-1. For owners</b></p> <p>Reporting safety defects for U.S. owners ..... 408</p> <p>Reporting safety defects for Canadian owners ..... 409</p> <p>Seat belt instructions for Canadian owners (in French) ... 409</p> <p>SRS airbag instructions for Canadian owners (in French) ..... 411</p> <p>Headlight aim instructions for Canadian owners (in French) ..... 423</p>
<div style="border: 1px solid black; padding: 5px; margin-bottom: 10px;"> <p><b>8 Vehicle specifications</b></p> </div> <p><b>8-1. Specifications</b></p> <p>Maintenance data (fuel, oil level, etc.) ..... 380</p> <p>Fuel information ..... 388</p> <p>Tire information ..... 390</p> <p><b>8-2. Customization</b></p> <p>Customizable features ..... 400</p>	<div style="border: 1px solid black; padding: 5px; margin-bottom: 10px;"> <p><b>Index</b></p> </div> <p>What to do if... (Troubleshooting) ..... 426</p> <p>Alphabetical Index ..... 429</p>

## For your information

### Main Owner's Manual

Please note that this manual applies to all models and explains all equipment, including options. Therefore, you may find explanations for equipment not installed on your vehicle and the illustrations used may differ from your vehicle.

All specifications provided in this manual are current at the time of printing. Over time, your vehicle may receive updates that modify the vehicle and make material in this manual incomplete and/or inaccurate. Because of Toyota's interest in continual product improvement, Toyota reserves the right to make changes to this manual at any time without notice.

If Toyota chooses to update the manual, updated versions can be viewed by selecting your vehicle by model and year at the following URL or on your mobile device if you have access to the Toyota app.

[www.toyota.com/owners](http://www.toyota.com/owners)

### Noise from under vehicle after turning off the engine

Approximately five hours after the engine is turned off, you may hear sound coming from

under the vehicle for several minutes. This is the sound of a fuel evaporation leakage check and, it does not indicate a malfunction.

### Accessories, spare parts and modification of your Toyota

A wide variety of non-genuine spare parts and accessories for Toyota vehicles are currently available in the market. You should know that Toyota does not warrant these products and is not responsible for their performance, repair, or replacement, or for any damage they may cause to, or adverse effect they may have on, your Toyota vehicle.

This vehicle should not be modified with non-genuine Toyota products. Modification with non-genuine Toyota products could affect its performance, safety or durability, and may even violate governmental regulations. In addition, damage or performance problems resulting from the modification may not be covered under warranty.

### Installation of a mobile two-way radio system

The installation of a mobile two-way radio system in your vehicle could affect electronic

systems such as:

- Multiport fuel injection system/sequential multiport fuel injection system
- EyeSight system
- Cruise control system
- Anti-lock brake system
- Vehicle dynamics integrated management
- SRS airbag system
- Seat belt pretensioner system

Be sure to check with your Toyota dealer for precautionary measures or special instructions regarding installation of a mobile two-way radio system.

### Vehicle data recording

The vehicle is equipped with sophisticated computers that will record certain data, such as:

- Engine speed / Electric motor speed (traction motor speed)
- Accelerator status
- Brake status
- Vehicle speed
- Operation status of the driving assist systems
- Images from the cameras

Your vehicle is equipped with cameras. Contact your Toyota dealer for the location of recording cameras.

The recorded data varies according to the vehicle grade level and options with which it is equipped.

These computers do not record conversations or sounds, and only record images outside of the vehicle in certain situations.

#### ● Data Transmission

Your vehicle may transmit the data recorded in these computers to Toyota and third parties contracted by Toyota without notification to you.

#### ● Data usage

Toyota and third parties contracted by Toyota may use the data recorded in this computer to diagnose malfunctions, conduct research and development, and improve quality.

Toyota and third parties contracted by Toyota will not disclose the recorded data to a third party except:

- With the consent of the vehicle owner or with the consent of the lessee if the vehicle is leased
- In response to an official request by the police, a court of law or a government agency
- For use by Toyota in a lawsuit
- For research purposes where the data is not tied to a specific vehicle or vehicle owner
- To learn more about the vehicle data collected, used and shared by Toyota, please visit [www.toyota.com/privacyvts/](http://www.toyota.com/privacyvts/).

### Usage of data collected through Safety Connect (U.S. mainland only)

If your Toyota has Safety Connect and if you have subscribed to those services, please refer to the Safety Connect Telematics Subscription Service Agreement for information on data collected and its usage.

To learn more about the vehicle data collected, used and shared by Toyota, please visit [www.toyota.com/privacyvts/](http://www.toyota.com/privacyvts/).

### Event data recorder

This vehicle is equipped with an event data recorder (EDR). The main purpose of an EDR is to record, in certain crash or near crash-like situations, such as an air bag deployment or hitting a road obstacle, data that will assist in understanding how a vehicle's systems performed. The EDR is designed to record data related to vehicle dynamics and safety systems for a short period of time, typically 30 seconds or less.

The EDR in this vehicle is designed to record such data as:

- How various systems in your vehicle were operating;
- Whether or not the driver and passenger safety belts were

buckled/fastened;

- How far (if at all) the driver was depressing the accelerator and/or brake pedal; and,
- How fast the vehicle was traveling.

These data can help provide a better understanding of the circumstances in which crashes and injuries occur.

NOTE: EDR data are recorded by your vehicle only if a non-trivial crash situation occurs; no data are recorded by the EDR under normal driving conditions and no personal data (e.g., name, gender, age, and crash location) are recorded. However, other parties, such as law enforcement, could combine the EDR data with the type of personally identifying data routinely acquired during a crash investigation.

To read data recorded by an EDR, special equipment is required, and access to the vehicle or the EDR is needed. In addition to the vehicle manufacturer, other parties, such as law enforcement, that have the special equipment, can read the information if they have access to the vehicle or the EDR.

#### ● Disclosure of the EDR data

Toyota will not disclose the data recorded in an EDR to a third party except when:

- An agreement from the vehicle's

owner (or the lessee for a leased vehicle) is obtained

- In response to an official request by the police, a court of law or a government agency

- For use by Toyota in a lawsuit

However, if necessary, Toyota may:

- Use the data for research on vehicle safety performance
- Disclose the data to a third party for research purposes without disclosing information about the specific vehicle or vehicle owner

### Scrapping of your Toyota

The SRS airbag and seat belt pretensioner devices in your Toyota contain explosive chemicals. If the vehicle is scrapped with the airbags and seat belt pretensioners left as they are, this may cause an accident such as fire. Be sure to have the systems of the SRS airbag and seat belt pretensioner removed and disposed of by a qualified service shop or by your Toyota dealer before you scrap your vehicle.

### Perchlorate Material

Special handling may apply, See [www.dtsc.ca.gov/hazardouswaste/perchlorate](http://www.dtsc.ca.gov/hazardouswaste/perchlorate).

Your vehicle has components that may contain perchlorate. These components may include airbag, seat belt pretensioners,

and wireless remote control batteries.

### “QR Code”

The word “QR Code” is registered trademark of DENSO WAVE INCORPORATED in Japan and other countries.

### WARNING

#### ■ General precautions while driving

**Driving under the influence:** Never drive your vehicle when under the influence of alcohol or drugs that have impaired your ability to operate your vehicle. Alcohol and certain drugs delay reaction time, impair judgment and reduce coordination, which could lead to an accident that could result in death or serious injury.

**Defensive driving:** Always drive defensively. Anticipate mistakes that other drivers or pedestrians might make and be ready to avoid accidents.

**Driver distraction:** Always give your full attention to driving. Anything that distracts the driver, such as adjusting controls, talking on a cellular phone or reading can result in a collision with resulting death or serious injury to you, your occupants or others.



**WARNING****■ General precaution regarding children's safety**



Never leave children unattended in the vehicle, and never allow children to have or use the key.

Children may be able to start the vehicle or shift the vehicle into neutral. There is also a danger that children may injure themselves by playing with the windows or other features of the vehicle. In addition, heat build-up or extremely cold temperatures inside the vehicle can be fatal to children.

**Reading this manual**



**Explains symbols used in this manual.**

**Symbols in this manual**

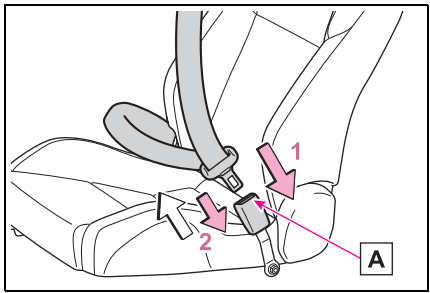

Symbols	Meanings
	<b>WARNING:</b> Explains something that, if not obeyed, could cause death or serious injury to people.
	<b>NOTICE:</b> Explains something that, if not obeyed, could cause damage to or a malfunction in the vehicle or its equipment.
1 2 3...	Indicates operating or working procedures. Follow the steps in numerical order.

**Symbols in illustrations**

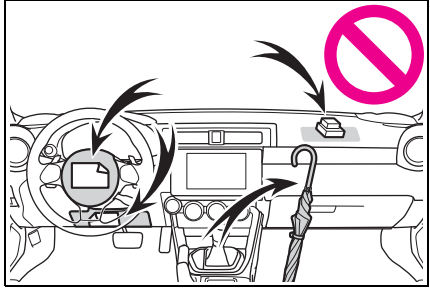

Symbols	Meanings
	Indicates the action (pushing, turning, etc.) used to operate switches and other devices.
	Indicates the outcome of an operation (e.g. a lid opens).



Symbols	Meanings
	Indicates the component or position being explained.
	Means <b>Do not</b> , <b>Do not do this</b> , or <b>Do not let this happen</b> .

## How to search

### ■ Searching by name

- Alphabetical index: →P.429

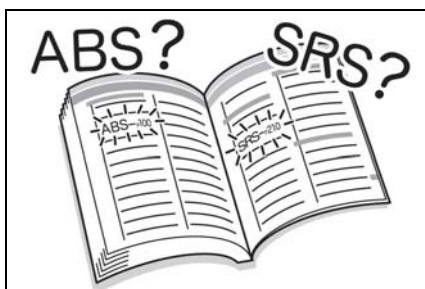

### ■ Searching by installation position

- Pictorial index: →P.12

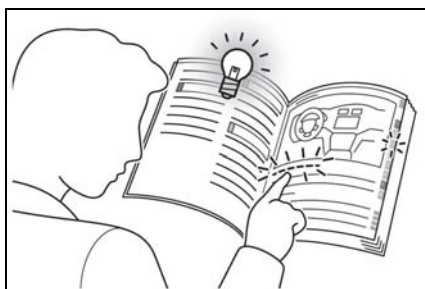

### ■ Searching by symptom or sound

- What to do if... (Troubleshooting): →P.426



### ■ Searching by title

- Table of contents: →P.2

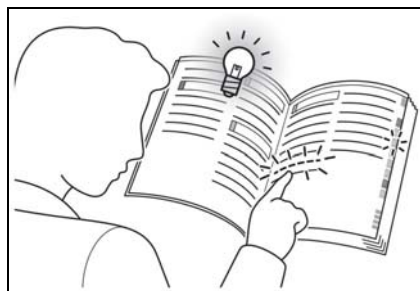

## Pictorial index

### ■ Exterior

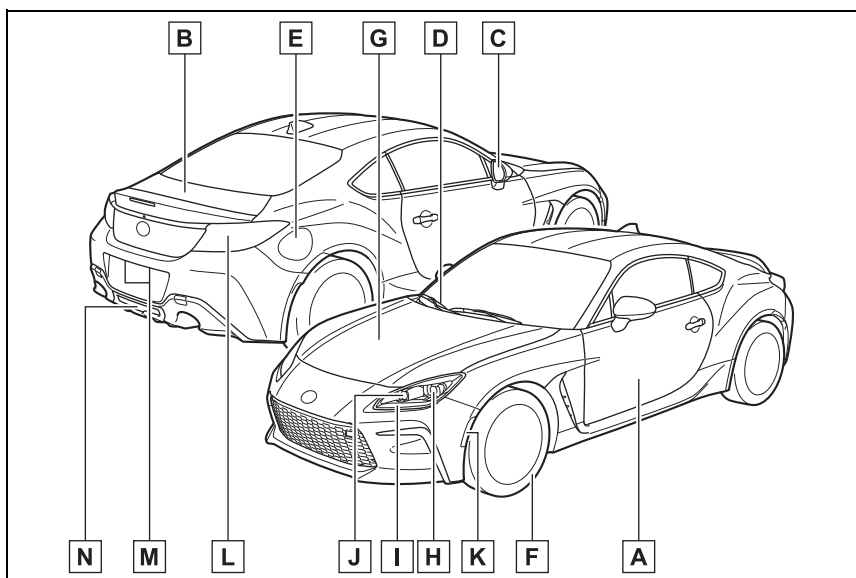

<b>A</b>	<b>Doors</b> .....	<b>P.105</b>
	Locking/unlocking .....	P.105
	Opening/closing the side windows .....	P.129
	Locking/unlocking by using the mechanical key .....	P.370
	Warning lights .....	P.348
<b>B</b>	<b>Trunk</b> .....	<b>P.107</b>
	Opening from inside the cabin .....	P.109
	Opening from outside.....	P.109
	Warning lights .....	P.348
<b>C</b>	<b>Outside rear view mirrors</b> .....	<b>P.127</b>
	Adjusting the mirror angle .....	P.127
	Folding the mirrors .....	P.127
	Defogging the mirrors .....	P.272
<b>D</b>	<b>Windshield wipers</b> .....	<b>P.165</b>
	Precautions for winter season.....	P.266
<b>E</b>	<b>Fuel filler door</b> .....	<b>P.167</b>

	Refueling method .....	P.167
	Fuel type/fuel tank capacity .....	P.381
<b>F</b>	<b>Tires</b> .....	<b>P.312</b>
	Tire size/inflation pressure .....	P.386
	Winter tires/tire chain .....	P.266
	Checking/rotation/tire pressure warning system .....	P.312
	Coping with flat tires.....	P.358
<b>G</b>	<b>Hood</b> .....	<b>P.302</b>
	Opening .....	P.302
	Engine oil .....	P.382
	Coping with overheating .....	P.375
	Warning messages .....	P.357

#### Light bulbs of the exterior lights for driving

(Replacing method: P.333, Watts: P.387)

<b>H</b>	<b>Headlights</b> .....	<b>P.158</b>
<b>I</b>	<b>Parking lights/daytime running lights</b> .....	<b>P.158</b>
<b>J</b>	<b>Turn signal lights</b> .....	<b>P.155</b>
<b>K</b>	<b>Side marker lights</b> .....	<b>P.158</b>
<b>L</b>	<b>Stop lights/tail lights/side marker lights/ turn signal lights</b> .....	<b>P.155, 158</b>
<b>M</b>	<b>License plate lights</b> .....	<b>P.158</b>
<b>N</b>	<b>Back up light</b>	
	Shifting the shift lever to R .....	P.150, 153

■ Instrument panel

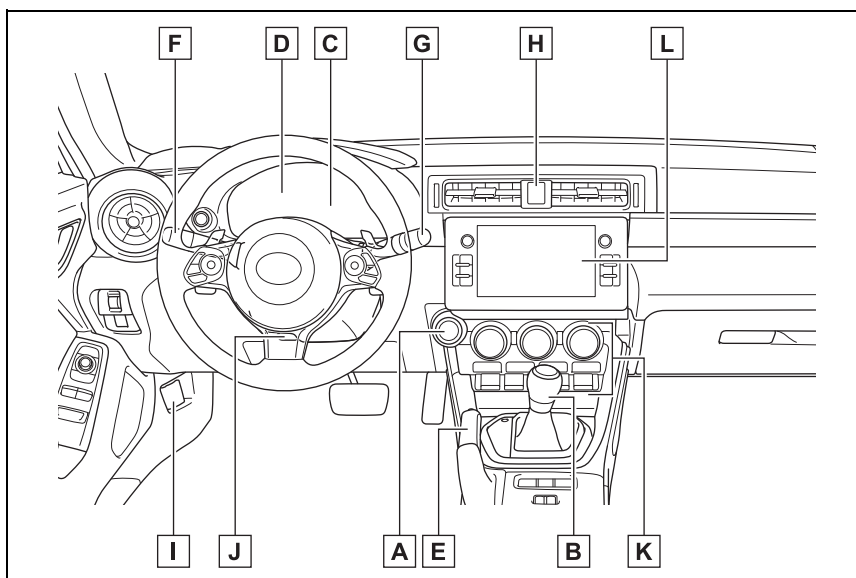

- A Engine switch ..... P.145**
  - Starting the engine/changing the mode ..... P.145
  - Emergency stop of the engine ..... P.338
  - When the engine will not start ..... P.367
  - Warning messages ..... P.357
- B Shift lever ..... P.149,153**
  - Changing the shift position ..... P.150,153
  - Precautions for towing ..... P.341
  - When the shift lever does not move\*1 ..... P.150
- C Multi-information display ..... P.93**
  - Display ..... P.93
  - When a warning message is displayed ..... P.357
- D Meters ..... P.88**
  - Reading the meters/adjusting the instrument panel lights ..... P.88
  - Warning lights/indicator lights ..... P.84
  - When a warning light comes on ..... P.348

<b>E</b>	<b>Parking brake</b> .....	<b>P.156</b>
	Applying/releasing .....	P.156
	Precautions for winter season .....	P.267
	Warning lights .....	P.348
<b>F</b>	<b>Headlight switch</b> .....	<b>P.158</b>
	<b>Turn signal lever</b> .....	<b>P.155</b>
	Headlights/parking lights/tail lights/side marker lights/daytime running lights .....	P.158
<b>G</b>	<b>Windshield wiper and washer switch</b> .....	<b>P.165</b>
	Usage .....	P.165
	Adding washer fluid .....	P.311
<b>H</b>	<b>Emergency flasher switch</b> .....	<b>P.338</b>
<b>I</b>	<b>Hood lock release lever</b> .....	<b>P.302</b>
<b>J</b>	<b>Tilt and telescopic steering lock release lever</b> .....	<b>P.125</b>
	Adjustment .....	P.125
<b>K</b>	<b>Air conditioning system</b> .....	<b>P.270</b>
	Usage .....	P.270
	Rear window defogger .....	P.272
<b>L</b>	<b>Audio system</b> <sup>*2</sup>	

\*1: Vehicles with an automatic transmission

\*2: Refer to "MULTIMEDIA OWNER'S MANUAL".

■ Switches

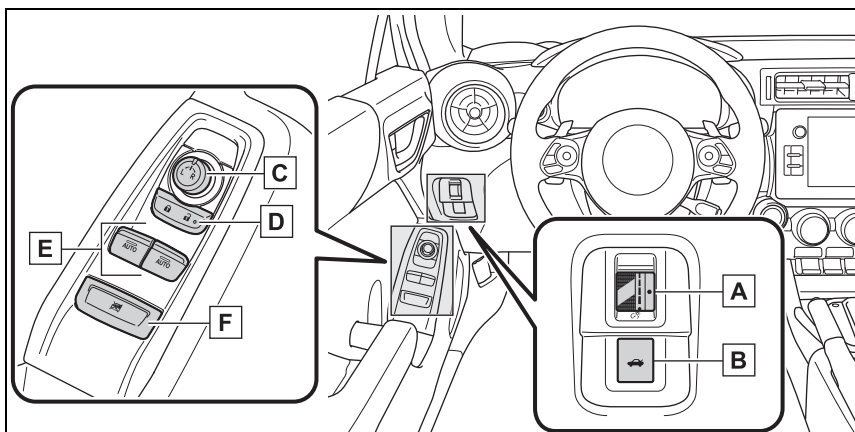

- A** Instrument panel light control dial ..... P.91
- B** Trunk opener switch ..... P.109
- C** Outside rear view mirror switches ..... P.127
- D** Door lock switches ..... P.106
- E** Power window switches ..... P.129
- F** Window lock switch ..... P.130

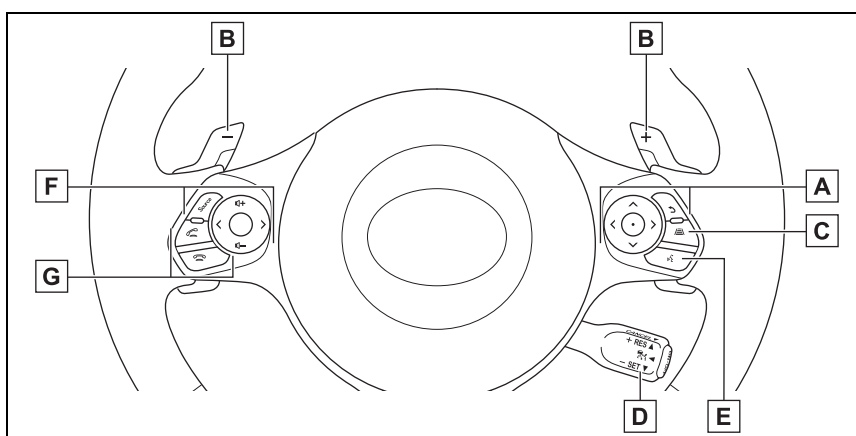

- A** Meter control switches ..... P.94
- B** Paddle shift switches \*1 ..... P.151, 152



- C**  (Following distance setting) switch<sup>\*1</sup> ..... P.178
- D** **Cruise control switch**
  - Adaptive cruise control<sup>\*1</sup> ..... P.190
  - Conventional cruise control<sup>\*1</sup> ..... P.207, 255
- E** **Talk switch<sup>\*2</sup>**
- F** **Audio remote control switches<sup>\*2</sup>**
- G** **Telephone switches<sup>\*2</sup>**

<sup>\*1</sup>: If equipped

<sup>\*2</sup>: Refer to “MULTIMEDIA OWNER’S MANUAL”.

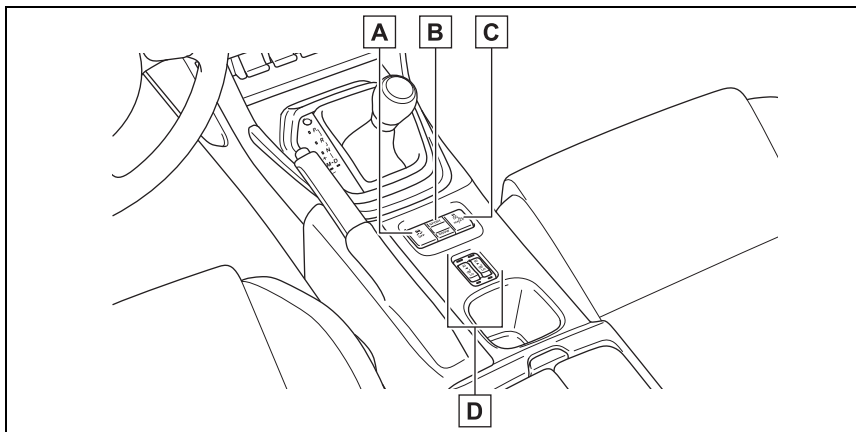

- A** **VSC OFF switch** ..... P.262
- B** **Driving mode select switch<sup>\*</sup>** ..... P.258
- C** **TRACK switch** ..... P.263
- D** **Seat heater switches<sup>\*</sup>** ..... P.276

<sup>\*</sup>: If equipped

■ Interior

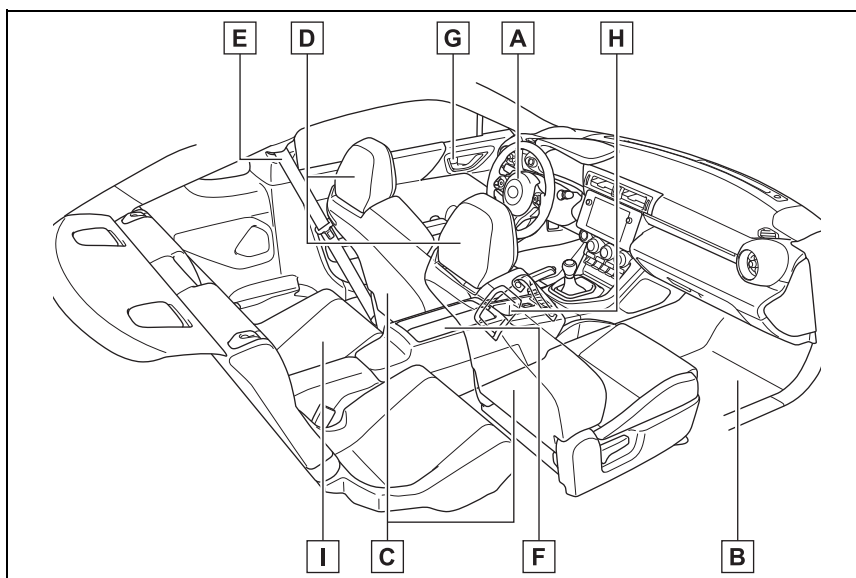

<b>A</b>	<b>SRS airbags</b> .....	<b>P.29</b>
<b>B</b>	<b>Floor mats</b> .....	<b>P.22</b>
<b>C</b>	<b>Front seats</b> .....	<b>P.119</b>
<b>D</b>	<b>Head restraints</b> .....	<b>P.123</b>
<b>E</b>	<b>Seat belts</b> .....	<b>P.25</b>
<b>F</b>	<b>Console box/cup holders</b> .....	<b>P.280</b>
<b>G</b>	<b>Inside lock buttons</b> .....	<b>P.107</b>
<b>H</b>	<b>Cup holders*</b> .....	<b>P.281</b>
<b>I</b>	<b>Rear seats</b> .....	<b>P.121</b>

\*: If equipped

■ Ceiling

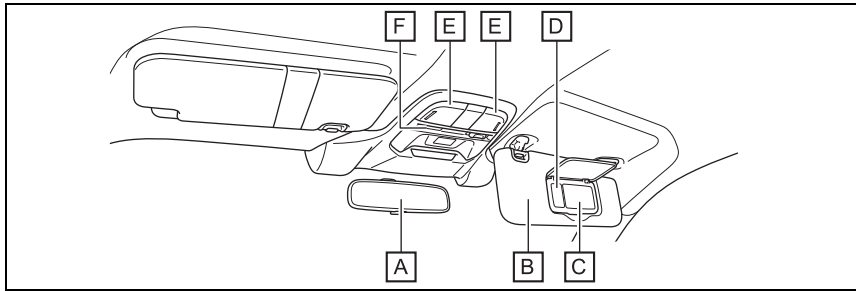

<b>A</b>	<b>Inside rear view mirror .....</b>	<b>P.126</b>
<b>B</b>	<b>Sun visors.....</b>	<b>P.284</b>
<b>C</b>	<b>Vanity mirrors.....</b>	<b>P.284</b>
<b>D</b>	<b>Vanity mirror lights* .....</b>	<b>P.284</b>
<b>E</b>	<b>Interior lights .....</b>	<b>P.277</b>
<b>F</b>	<b>“SOS” button*/“i” button* .....</b>	<b>P.75</b>

\*: If equipped



**For safety and security**

1

21

**1-1. For safe use**

- Before driving ..... 22
- For safe driving ..... 23
- Seat belts ..... 25
- SRS airbags ..... 29
- Front passenger occupant classification system .... 56
- Exhaust gas precautions ..... 62

**1-2. Child safety**

- Riding with children ..... 63
- Child restraint systems... 64

**1-3. Emergency assistance**

- Safety Connect ..... 75

**1-4. Theft deterrent system**

- Engine immobilizer system ..... 80
- Alarm..... 81

1

For safety and security

### Before driving

Observe the following before starting off in the vehicle to ensure safety of driving.

### Floor mats

Use only floor mats designed specifically for vehicles of the same model and model year as your vehicle. Fix them securely in place onto the carpet.

- 1 Insert the retaining hooks (clips) into the floor mat eyelets.

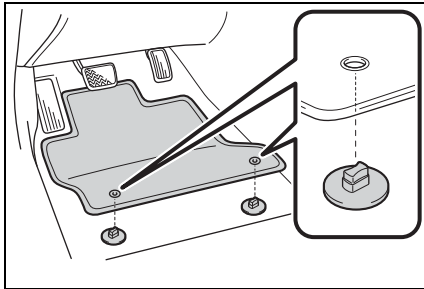

- 2 Turn the upper knob of each retaining hook (clip) to secure the floor mats in place.

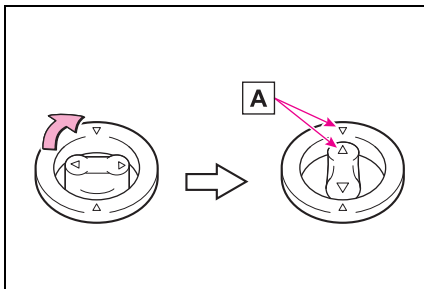

Always align the  $\triangle$  marks **A**.

The shape of the retaining hooks (clips) may differ from that shown in the illustration.

### ⚠ WARNING

Observe the following precautions. Failure to do so may cause the driver's floor mat to slip, possibly interfering with the pedals while driving. An unexpectedly high speed may result or it may become difficult to stop the vehicle. This could lead to an accident, resulting in death or serious injury.

#### ■ When installing the driver's floor mat

- Do not use floor mats designed for other models or different model year vehicles, even if they are Toyota Genuine floor mats.
- Only use floor mats designed for the driver's seat.
- Always install the floor mat securely using the retaining hooks (clips) provided.
- Do not use two or more floor mats on top of each other.
- Do not place the floor mat bottom-side up or upside-down.

**⚠ WARNING****■ Before driving**

- Check that the floor mat is securely fixed in the correct place with all the provided retaining hooks (clips). Be especially careful to perform this check after cleaning the floor.

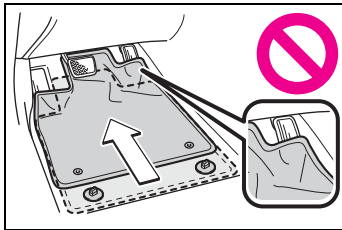

- With the engine stopped and the shift lever in P (Automatic transmission) or N (manual transmission), fully depress each pedal to the floor to make sure it does not interfere with the floor mat.

**For safe driving**

**For safe driving, adjust the seat and mirror to an appropriate position before driving.**

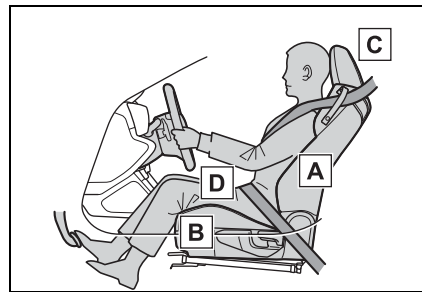
**Correct driving posture**

- A** Adjust the angle of the seat-back so that you are sitting straight up and so that you do not have to lean forward to steer. (→P.119)
- B** Adjust the seat so that you can depress the pedals fully and so that your arms bend slightly at the elbow when gripping the steering wheel. (→P.119)
- C** Lock the head restraint in place with the center of the head restraint closest to the top of your ears. (→P.123)
- D** Wear the seat belt correctly. (→P.25)

**WARNING****■ For safe driving**

Observe the following precautions.

Failure to do so may result in death or serious injury.

- Do not adjust the position of the driver's seat while driving. Doing so could cause the driver to lose control of the vehicle.
- Do not place a cushion between the driver or passenger and the seatback. A cushion may prevent correct posture from being achieved, and reduce the effectiveness of the seat belt and head restraint.
- Do not place anything under the front seats. Objects placed under the front seats may become jammed in the seat tracks and stop the seat from locking in place. This may lead to an accident and the adjustment mechanism may also be damaged.
- Always observe the legal speed limit when driving on public roads.
- When driving over long distances, take regular breaks before you start to feel tired. Also, if you feel tired or sleepy while driving, do not force yourself to continue driving and take a break immediately.

child becomes large enough to properly wear the vehicle's seat belt. (→P.64)

**Adjusting the mirrors**

Make sure that you can see backward clearly by adjusting the inside and outside rear view mirrors properly. (→P.126, 127)

**Correct use of the seat belts**

Make sure that all occupants are wearing their seat belts before driving the vehicle. (→P.25)

Use a child restraint system appropriate for the child until the



## Seat belts

**Make sure that all occupants are wearing their seat belts before driving the vehicle.**

### WARNING

Observe the following precautions to reduce the risk of injury in the event of sudden braking, sudden swerving or an accident. Failure to do so may cause death or serious injury.

#### ■ Wearing a seat belt

- Ensure that all passengers wear a seat belt.
- Always wear a seat belt properly.
- Each seat belt should be used by one person only. Do not use a seat belt for more than one person at once, including children.
- Toyota recommends that children be seated in the rear seat and always use a seat belt and/or an appropriate child restraint system.
- To achieve a proper seating position, do not recline the seat more than necessary. The seat belt is most effective when the occupants are sitting up straight and well back in the seats.
- Do not wear the shoulder belt under your arm.
- Always wear your seat belt low and snug across your hips.

#### ■ Pregnant women

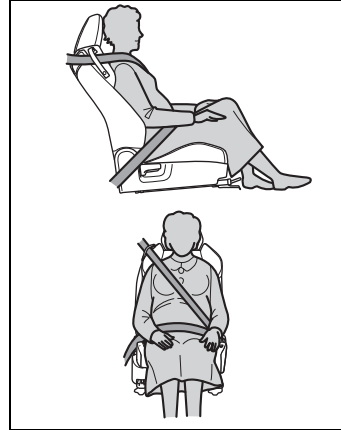

Obtain medical advice and wear the seat belt in the proper way. (→P.26)

Women who are pregnant should position the lap belt as low as possible over the hips in the same manner as other occupants, extending the shoulder belt completely over the shoulder and avoiding belt contact with the rounding of the abdominal area.

If the seat belt is not worn properly, not only the pregnant woman, but also the fetus could suffer death or serious injury as a result of sudden braking or a collision.

#### ■ People suffering illness

Obtain medical advice and wear the seat belt in the proper way. (→P.26)

#### ■ When children are in the vehicle

Do not allow children to play with the seat belt. If the seat belt becomes twisted around a child's neck, it may lead to choking or other serious injuries that could result in death.

If this occurs and the buckle cannot be unfastened, scissors should be used to cut the belt.

**⚠ WARNING****■ Seat belt damage and wear**

- Do not damage the seat belts by allowing the belt, plate, or buckle to be jammed in the door.
- Inspect the seat belt system periodically. Check for cuts, fraying, and loose parts. Do not use a damaged seat belt until it is replaced. Damaged seat belts cannot protect an occupant from death or serious injury.
- Ensure that the belt and plate are locked and the belt is not twisted.  
If the seat belt does not function correctly, immediately contact your Toyota dealer.
- Replace the seat assembly, including the belts, if your vehicle has been involved in a serious accident, even if there is no obvious damage.
- Do not attempt to install, remove, modify, disassemble or dispose of the seat belts. Have any necessary repairs carried out by your Toyota dealer. Inappropriate handling may lead to incorrect operation.

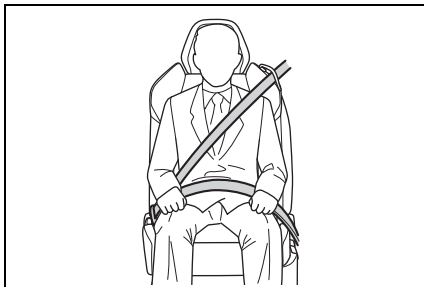
**Correct use of the seat belts**

- Extend the shoulder belt so

that it comes fully over the shoulder, but does not come into contact with the neck or slide off the shoulder.

- Position the lap belt as low as possible over the hips.
- Adjust the position of the seatback. Sit up straight and well back in the seat.
- Do not twist the seat belt.

**■ Child seat belt usage**

The seat belts of your vehicle were principally designed for persons of adult size.

- Use a child restraint system appropriate for the child, until the child becomes large enough to properly wear the vehicle's seat belt. (→P.64)
- When the child becomes large enough to properly wear the vehicle's seat belt, follow the instructions regarding seat belt usage. (→P.25)

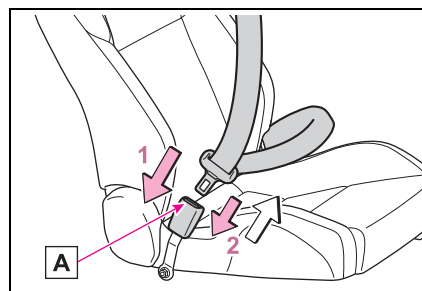
**Fastening and releasing the seat belt**

- 1 To fasten the seat belt, push the plate into the buckle until a click sound is heard.
- 2 To release the seat belt,

press the release button **A**.

#### ■ Emergency locking retractor (ELR)

The retractor will lock the belt during a sudden stop or on impact. It may also lock if you lean forward too quickly. When the seat belt locks, pull the belt strongly and then release the belt, then a slow and easy pulling will allow the belt to extend.

#### ■ Automatic locking retractor (ALR)

When a passenger's shoulder belt is completely extended and then retracted even slightly, the belt is locked in that position and cannot be extended. This feature is used to hold a child restraint system (CRS) firmly. To free the belt again, fully retract the belt and then pull the belt out once more. (→P.64)

### Seat belt guide

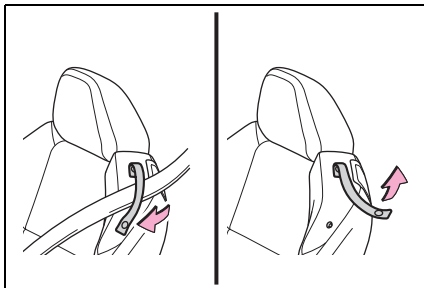

When fastening a front seat belt, ensure that it is passed through the seat belt guide. Passing the seat belt through the guide enables the seat belt to be easily extended.

When you get into or out of the rear seats, release the seat belt from the seat belt guide.

#### ⚠ WARNING

##### ■ When using the seat belt guide

- Always make sure that the belt is not twisted, and runs freely through the guide.
- Regardless of whether the guide is used or not, always secure the seat belt guide button.
- Do not hang from or pull the guide forcefully.

### Seat belt pretensioners (front seats)

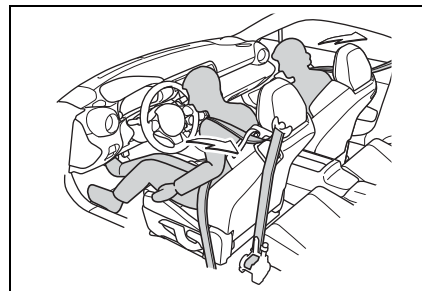

The pretensioners help the seat belts to quickly restrain the occupants by retracting the seat belts when the vehicle is subjected to certain types of severe frontal collision or a vehicle roll-over.

The front seat belt pretensioners also activate when the vehicle is subjected to certain types of severe side collision.

The pretensioners do not activate in the event of a minor frontal impact, a minor side impact or a rear impact.

**■ Replacing the belt after the pretensioner has been activated**

If the vehicle is involved in multiple collisions, the pretensioner will activate for the first collision, but will not activate for the second or subsequent collisions.

**WARNING****■ Seat belt pretensioners**

- Do not place anything, such as a cushion, on the front passenger's seat. Doing so will disperse the passenger's weight, which prevents the sensor from detecting the passenger's weight properly. As a result, the seat belt pretensioner for the front passenger's seat may not activate in the event of a collision.
- If the pretensioner has activated, the SRS warning light will come on. In that case, the seat belt cannot be used again and must be replaced at your Toyota dealer.

## SRS airbags

**Supplemental Restraint System (SRS) name is used because the airbag system supplements the vehicle's seatbelts.**

**This vehicle is equipped with a supplemental restraint system which consists of seven airbags.**

**The configurations are as follows.**

- Driver's and front passenger's frontal airbags
- Driver's and front passenger's side airbags
- Curtain shield airbags (for driver, front passenger and rear passengers)
- Knee airbag for driver

**These SRS airbags are designed only to be a supplement to the primary protection provided by the seatbelt.**

**The system also controls front seatbelt pretensioners. For operation instructions and precautions concerning the seatbelt pretensioner, refer to P.27.**

## Components

### ■ Location of the SRS airbags

The SRS airbags are stowed in the following locations.

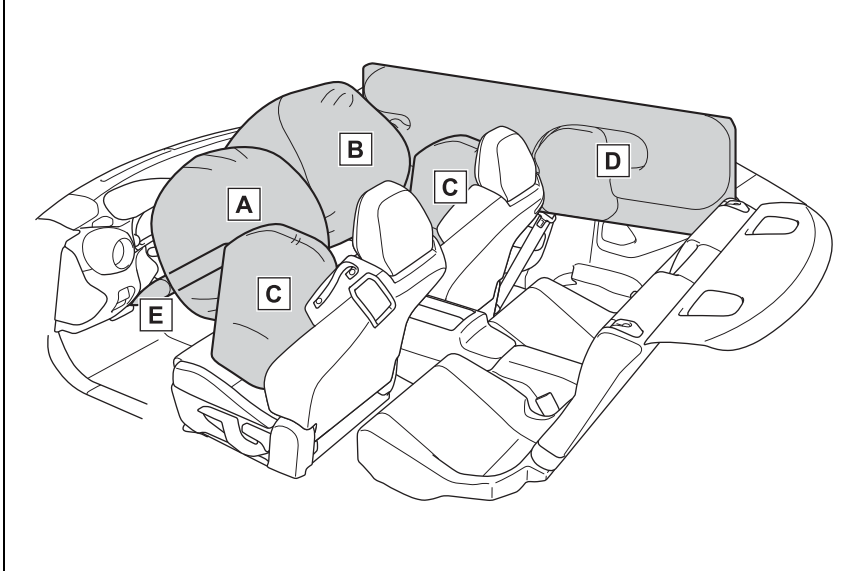

**A** Driver's SRS frontal airbag: in the center portion of the steering wheel

An "SRS AIRBAG" mark is located on the pad of the airbag.

**B** Front passenger's SRS frontal airbag: near the top of the right side of dashboard

An "SRS AIRBAG" mark is located on the right corner of the dashboard.

**C** SRS side airbag: in the door side of each front seat seatback

An "SRS AIRBAG" marks are located on the door side of each front seat cushion.

**D** SRS curtain shield airbag: in the roof side (between the front pillar and a point over the rear seat)

"SRS AIRBAG" marks are located at the top of each center pillar.

**E** SRS knee airbag: under the steering column

An "SRS AIRBAG" mark is located at the door of the airbag.

### ■ SRS airbag system components

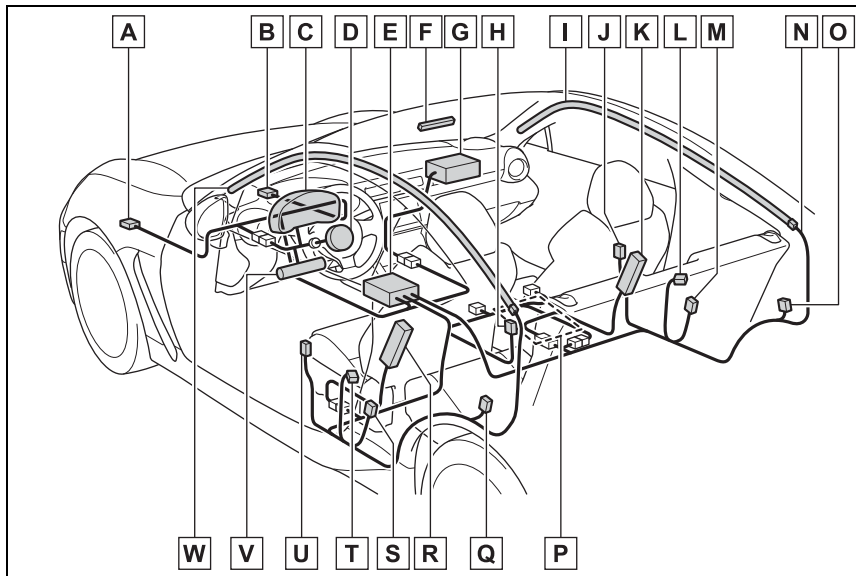

- A** Front impact sensor (left-hand side)
- B** Front impact sensor (right-hand side)
- C** SRS warning light
- D** Frontal airbag module (driver's side)
- E** Airbag control module (including impact sensor and rollover sensor)
- F** Front passenger's frontal airbag ON and OFF indicator
- G** Frontal airbag module (front passenger's side)
- H** Seatbelt buckle switch (front passenger's side)
- I** Curtain shield airbag module (right-hand side)
- J** Side impact sensor (door right-hand side)
- K** Side airbag module (front passenger's side)
- L** Seatbelt pretensioner and adaptive force limiter (front passenger's side)
- M** Side impact sensor (center pillar right-hand side)
- N** Airbag wiring
- O** Side impact sensor (rear wheel house right-hand side)
- P** Front passenger's occupant detection system sensor

- Q Side impact sensor (rear wheel house left-hand side)
- R Side airbag module (driver's side)
- S Side impact sensor (center pillar left-hand side)
- T Seatbelt pretensioner (driver's side)
- U Side impact sensor (door left-hand side)
- V Knee airbag module (driver's side)
- W Curtain shield airbag module (left-hand side)

**■ If the SRS airbag deploys**

If the SRS airbag deploys, fuel supply will be cut off to reduce the risk of fire caused by leaking fuel. For details about restarting of the engine, refer to P.347.

**■ SRS Airbag System Servicing**

In the following cases, contact your Toyota dealer as soon as possible.

- The front part of the vehicle was involved in an accident in which only the driver's SRS frontal airbag or both driver's and front passenger's SRS frontal airbags did not deploy.
- The pad of the steering wheel, the cover over the front passenger's SRS frontal airbag, or either roof side (from the front pillar to a point over the rear seat) is scratched, cracked, or otherwise damaged.
- The center pillar, door, rear wheel house or rear sub frame, or an area near these parts, was involved in an accident in which the SRS side airbag and SRS curtain shield airbag did not deploy.
- The fabric or leather of either front seatback is cut, frayed, or otherwise damaged.
- The rear part of the vehicle was involved in an accident in which no SRS airbag was deployed.

**■ When you sell your vehicle**

When you sell your vehicle, we urge you to inform the buyer that the

vehicle is equipped with SRS airbags. Also, notify the buyer of the applicable section in this Owner's Manual.

 **WARNING**

**■ General Precautions regarding SRS Airbag System**

- To obtain maximum protection in the event of an accident, the driver and all passengers must always wear seatbelts when in the vehicle. The SRS airbag is designed only to be a supplement to the primary protection provided by the seatbelt. It does not eliminate the need to fasten seatbelts. In combination with the seatbelts, it offers the best protection in case of a serious accident.

Not wearing a seatbelt increases the chance of severe injury or death in a crash even when the vehicle has the SRS airbag.

For instructions and precautions concerning the seatbelt system, refer to P.25.



**⚠ WARNING**

- The SRS side airbags and SRS curtain shield airbags are designed only to be a supplement to the primary protection provided by the seatbelt. They do not eliminate the need to fasten seatbelts. It is also important to wear a seatbelt to help avoid injuries that can result when an occupant is not seated in a proper upright position.
- The SRS airbags deploy with considerable speed and force. Occupants who are not seated in proper upright position when the SRS airbag deploys could suffer serious injury. Because the SRS airbag needs enough space for deployment, the driver should always sit upright and back in the seat as far from the steering wheel as practical while still maintaining full vehicle control, and the front passenger should move the seat as far back as possible and sit upright and well back in the seat.

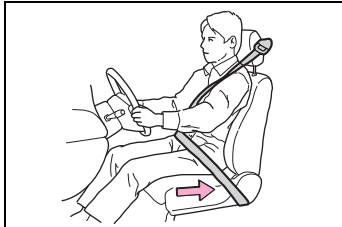

- Do not sit or lean close to either door. The SRS side airbags are stored in both front seat seat-backs next to the door, and they provide protection by deploying rapidly in the event of a side impact collision. However, the force of SRS side airbag deployment can injure an occupant whose body is too close to an SRS airbag.



- Since your vehicle is equipped with SRS curtain shield airbags, do not sit or lean close to the door on either side. Do not put body parts out of the window. The SRS curtain shield airbags on both sides of the cabin are stored in the roof side (between the front pillar and a point behind the rear quarter glass), and they provide protection by deploying rapidly in the event of a side impact, rollover or an offset frontal collision. However, the force of its deployment can injure an occupant whose body is too close to an SRS airbag.

**⚠ WARNING**

- Do not sit or lean unnecessarily close to the SRS airbag. Because the SRS airbag deploys with considerable speed and force to protect in high speed collisions, the force of an airbag can injure an occupant whose body is too close to SRS airbag.

It is also important to wear seatbelts to help avoid injuries that can result when the SRS airbag contacts an occupant not in their proper position.

Even when properly positioned, there remains a possibility that an occupant may suffer minor injury, such as abrasions and bruises to the face or arms, because of the SRS airbag deployment force.

- Keep arms away from either door or its internal trim. They could be injured in the event of SRS side airbag deployment.



- Do not place any objects over or near the SRS airbag cover or between you and the SRS airbag. If the SRS airbag deploys, these objects could interfere with its proper operation and could be propelled inside the vehicle, causing injury.

**■ If the SRS airbag deploys**

- When the SRS airbag deploys, some smoke will be released. This smoke could cause breathing problems for people with a history of asthma or other breathing trouble. If you or your passengers have breathing problems after SRS airbag deploys, get fresh air promptly.

- A deploying SRS airbag releases hot gas. Occupants could get burned if they come into direct contact with the hot gas.

**■ General Precautions regarding SRS Airbag System for Accessories and Any Objects**

- Do not put any objects (including straps or cord) over the steering wheel pad, column cover, or dashboard.
- These objects could be entangled with the steering wheel, preventing the SRS frontal airbag, etc. from operating properly.
- If the SRS frontal airbag deploys, these objects could be propelled inside the vehicle, causing injury.

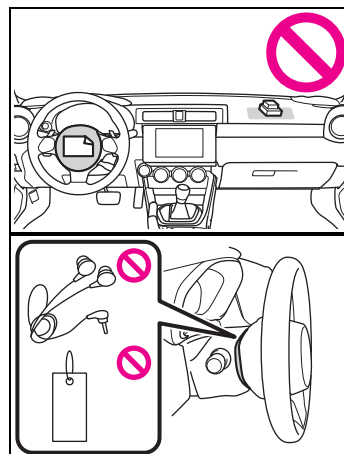

**⚠ WARNING**

- Do not put any objects under the driver's side of the instrument panel. If the SRS knee airbag deploys, those objects could interfere with its proper operation and could be propelled inside the vehicle, causing injury.
- Do not attach accessories to the windshield, or fit an extra-wide mirror over the inside rear view mirror. If the SRS airbag deploys, those objects could become projectiles that could seriously injure vehicle occupants.

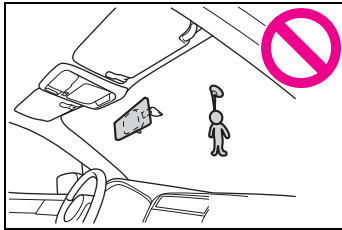

- Do not attach accessories to the door trim or near either SRS side airbags and do not place objects near the SRS side airbags. In the event of SRS side airbag deployment, they could be propelled dangerously toward the vehicle's occupants and cause injuries.

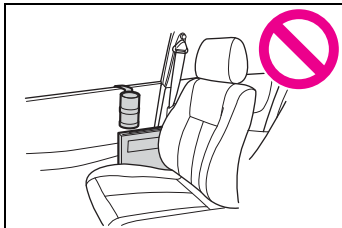

- Do not attach a hands-free microphone or any other accessory to a front pillar, a center pillar, a rear pillar, the windshield, a side window, or any other cabin surface that would be near a deploying SRS curtain shield airbag. A hands-free microphone or other accessory in such a location could be propelled through the cabin with great force by the curtain shield airbag, or it could prevent correct deployment of the curtain shield airbag. In either case, the result could be serious injuries.
- Do not put any kind of clothes or other objects over the front seatback and do not attach labels or stickers to the front seat surface on or near the SRS side airbag. They could prevent proper deployment of the SRS side airbag, reducing protection available to the front seat's occupant.
- Do not install a seat cover unless it is a genuine Toyota seat cover exclusively designed for use with the SRS airbag. Even when using a genuine Toyota seat cover, the SRS side airbag system may not function normally if the seat cover is not installed correctly.

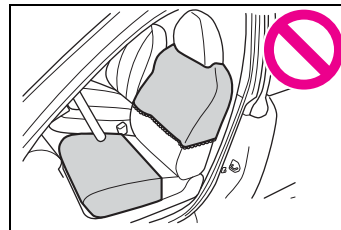

**⚠ WARNING**

■ **General Precautions regarding SRS Airbag System and Children**

- Place children in the rear seat properly restrained at all times. The SRS airbag deploys with considerable speed and force and can injure or even kill children, especially if they are not restrained or improperly restrained. Because children are lighter and weaker than adults, their risk of being injured from deployment is greater. For that reason, we strongly recommend that ALL children (including those in child restraint systems) sit in the REAR seat properly restrained at all times in a child restraint device or in a seatbelt, whichever is appropriate for the child's age, height and weight. Secure ALL types of child restraint systems (including forward facing child restraint system) in the REAR seats at all times. According to accident statistics, children are safer when properly restrained in the rear seating positions than in the front seating positions. For instructions and precautions concerning the child restraint system, refer to P.64.

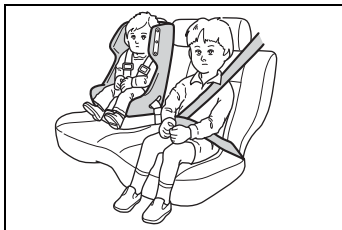

- NEVER INSTALL A CHILD RESTRAINT SYSTEM IN THE FRONT SEAT. DOING SO RISKS SERIOUS INJURY OR DEATH TO THE CHILD BY PLACING THE CHILD'S HEAD TOO CLOSE TO THE SRS AIRBAG.

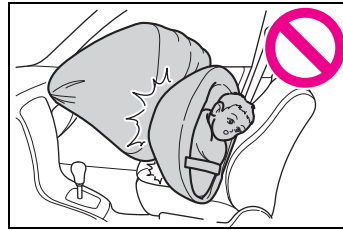

- Never allow a child to stand up or kneel on the front passenger's seat. The SRS airbag deploys with considerable force and can injure or even kill the child.

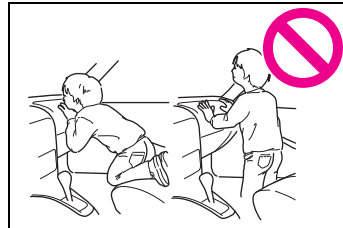

- Never hold a child on your lap or in your arms. The SRS airbag deploys with considerable force and can injure or even kill the child.

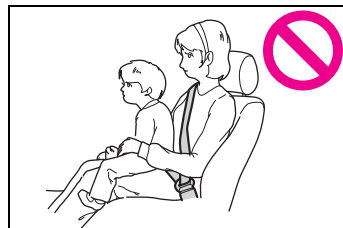

- Never allow a child to do the following.
  - Kneel on any passenger's seat facing the side window

**⚠ WARNING**

- Wrap his/her arms around the front seat seatback
- Put his/her head, arms or other parts of the body out of the window



In the event of an accident, the force of SRS side airbag and/or SRS curtain shield airbag deployment could injure the child seriously because his/her head, arms or other parts of the body are too close to the SRS side airbag and/or SRS curtain shield airbag.

- Since your vehicle is also equipped with a front passenger's SRS frontal airbag, children should be placed in the rear seat and should be properly restrained at all times.

**■ SRS Airbag System Servicing**

The SRS airbag has no user-serviceable parts. Do not use electrical test equipment on any circuit related to the SRS airbag system. For required servicing of the SRS airbag, consult your nearest Toyota dealer. Tampering with or disconnecting the system's wiring could result in accidental inflation of the SRS airbag or could make the system inoperative, which may result in serious injury.

**■ Precautions against Vehicle Modification**

- To avoid accidental activation of the system or rendering the system inoperative, which may result in serious injury, no modifications should be made to any components or wiring of the SRS airbag system. This includes following modifications.
  - Installation of custom steering wheels
  - Attachment of additional trim materials to the dashboard
  - Installation of custom seats
  - Replacement of seat fabric or leather
  - Installation of additional fabric or leather on the front seat
  - Attachment of a hands-free microphone or any other accessory to a front pillar, a center pillar, a rear pillar, the windshield, a side window, an assist grip, or any other cabin surface that would be near a deploying SRS curtain shield airbag.

**⚠ WARNING**

- Installation of additional electrical/electronic equipment such as a mobile two-way radio on or near the SRS airbag system components and/or wiring is not advisable. This could interfere with proper operation of the SRS airbag system.
- Modifications on or inside the door panels for the purpose of a speaker replacement or sound insulation
- The impact sensors, which detect the pressure of an impact, are located in the doors. Do not modify any components of the doors or door trims, such as the addition of door speakers for example. Any modifications to the doors will create a risk of the airbag system becoming inoperative or unintended airbag deployment.
- Do not perform any of the following modifications. Such modifications can interfere with proper operation of the SRS airbag system.
- Attachment of any equipment (bush bar, winches, snow plow, skid plate, etc.) other than genuine Toyota accessory parts to the front end.
- Modification of the suspension system or front end structure.
- Installation of a tire of different size and construction from the tires specified on the vehicle placard attached to the driver's center pillar or specified for individual vehicle models in this Owner's Manual.

- Attachment of any equipment (side steps or side sill protectors, etc.) other than genuine Toyota accessory parts to the side body.

Always consult your Toyota dealer if you want to install any accessory parts on your vehicle.

**⚠ NOTICE****■ SRS Airbag System Servicing**

- When discarding an airbag module or scrapping the entire vehicle damaged by a collision, consult your Toyota dealer.
- If you need service or repair in areas indicated in the following list, have the work performed by an authorized Toyota dealer. The SRS airbag control module, impact sensors and airbag modules are stored in these areas.
- Under the center of the instrument panel
- On both the right and left sides at the front of the vehicle
- Steering wheel and column and nearby areas
- Bottom of the steering column and nearby areas
- Top of the dashboard on front passenger's side and nearby areas
- Each front seat and nearby area
- Inside each center pillar
- Inside each door
- In each roof side (from the front pillar to a point over the rear seat)

**NOTICE**

- Between the rear seat cushion and rear wheel house on each side
- In the event that the SRS airbag is deployed, replacement of the system should be performed only by an authorized Toyota dealer. When the components of the SRS airbag system are replaced, use only genuine Toyota parts.

**Toyota Advanced Frontal Airbag System**

This vehicle is equipped with a Toyota advanced frontal airbag system that complies with the advanced frontal airbag requirements in the amended Federal Motor Vehicle Safety Standard (FMVSS) No. 208.

The Toyota advanced frontal airbag system automatically determines the deployment force of the driver's SRS frontal airbag at the time of deployment as well as whether or not to activate the front passenger's SRS frontal airbag and, if activated, the deployment force of the SRS frontal airbag at the time of deployment.

Always wear your seatbelt. The Toyota advanced frontal airbag system is a supplemental restraint system and must be used in combination with a seatbelt. All occupants should wear a seatbelt or be seated in an

appropriate child restraint system.

For the locations of the SRS airbags, refer to P.29.

In a moderate to severe frontal collision, the following components deploy.

- SRS frontal airbag for driver
- SRS frontal airbag for front passenger
- SRS curtain shield airbag\*
- SRS knee airbag for driver

\*: When an offset frontal collision that is severe enough to deploy the front airbag occurs.

These components supplement the seatbelts by reducing the impact to the occupant's head, chest and knees.

**■ Driver's SRS frontal airbag**

The driver's SRS frontal airbag uses a dual stage inflator. The inflator operates in different ways depending on the severity of impact.

**■ Front passenger's SRS frontal airbag**

The front passenger's SRS frontal airbag uses a dual stage inflator. The inflator operates in different ways depending on the severity of impact.

**■ Occupant detection system**

The occupant detection system sensors are installed between the seat and seat rails, and

monitor the physique and posture of the front passenger. Using this information, the occupant detection system determines whether the front passenger's SRS frontal airbag should be deployed or not.

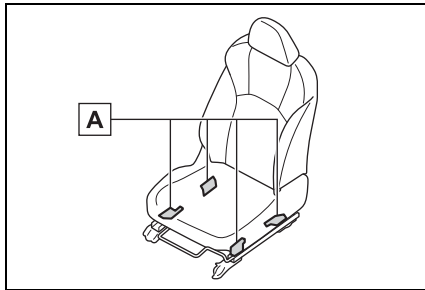

**A** Occupant detection sensors

The occupant detection system may not inflate the front passenger's SRS frontal airbag even when the driver's SRS frontal airbag deploys. This is normal. In this case, although the front passenger's SRS frontal airbag does not operate, the front passenger's seatbelt pretensioner operates with the driver's seatbelt pretensioner. For details about the seatbelt pretensioner, refer to P.27.

■ **Passenger's frontal airbag ON and OFF indicators**

Refer to P.85.

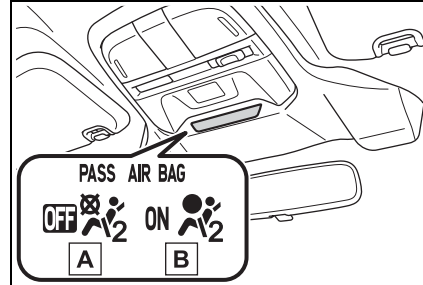

**A** Front passenger's frontal airbag OFF indicator

**B** Front passenger's frontal airbag ON indicator

■ **Operation**

► **Driver's side**

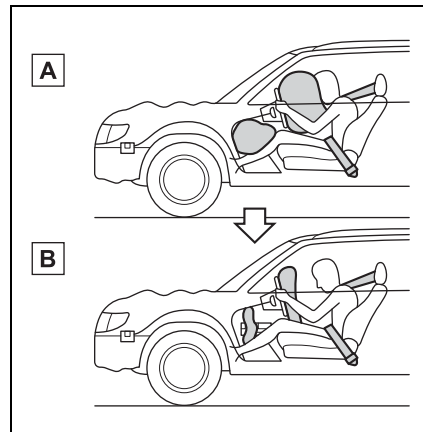

**A** SRS AIRBAGs deploy as soon as a collision occurs.

**B** After deployment, SRS AIRBAGs start to deflate immediately so that the driver's vision is not obstructed.



► Passenger's side

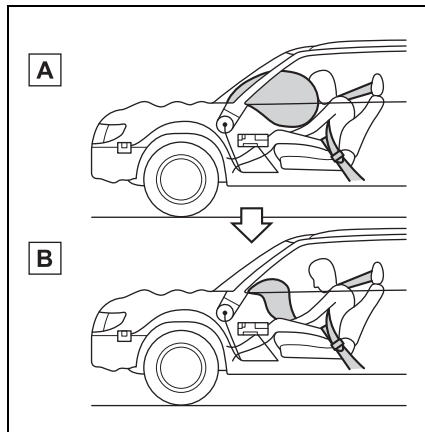

**A** SRS AIRBAG deploy as soon as a collision occurs.

**B** After deployment, SRS AIRBAG start to deflate immediately so that the driver's vision is not obstructed.

The SRS airbags can function only when the engine switch is in ON.

The Toyota advanced frontal airbag system is designed to determine the activation or deactivation condition of the front passenger's SRS frontal airbag depending on the characteristic of item(s) or person on the front passenger's seat monitored by the front passenger's occupant detection system sensor. For this reason, only the driver's SRS frontal airbag may deploy in the event of a collision, but this does not mean failure of the system.

If the following sensors detect a

predetermined amount of force during a frontal collision, the control module sends signals to the airbag module(s) (only driver's module or both driver's and front passenger's modules) instructing the module(s) to inflate the SRS frontal airbag(s).

- The front impact sensors
- The impact sensors in the airbag control module

On the driver's side, the SRS knee airbag also inflates with the SRS frontal airbag.

The driver's and front passenger's SRS frontal airbags use dual stage inflators. The two inflators of each airbag are triggered either sequentially or simultaneously, depending on the severity of impact, in the case of the driver's SRS frontal airbag and depending on the severity of impact and the characteristic of item(s) or person on the seat in the case of the front passenger's SRS frontal airbag.

■ **After deployment**

After deployment, the SRS airbag immediately starts to deflate so that the driver's vision is not obstructed and the driver's ability to maintain control of the vehicle is not impaired. The time required from detecting impact to the deflation of the SRS airbag after deployment is shorter than the blink of an eye.

Both when only the driver's SRS frontal airbag deploys and the driver's and front passenger's SRS frontal airbags deploy, the driver's and front passenger's seatbelt pretensioners operate at the same time.

When the SRS airbag deploys, a sudden, fairly loud inflation noise will be heard and some smoke will be released. These occurrences are a normal result of the deployment. This smoke does not indicate a fire in the vehicle.

#### ■ Example of the type of accident

The driver's SRS frontal airbag and front passenger's SRS frontal airbag are designed as follows.

- To deploy in the event of an accident involving a moderate to severe frontal collision
- To function on a one-time-only basis

The driver's SRS frontal airbag and front passenger's SRS frontal airbag are not designed as follows.

- To deploy in most lesser frontal impacts<sup>\*1</sup>
- To deploy in most side or rear impacts or in most rollover accidents<sup>\*2</sup>

<sup>\*1</sup>: Because the necessary protection can be achieved by the seat-

belt alone.

<sup>\*2</sup>: Because deployment of only the driver's SRS frontal airbag or both the driver's and front passenger's SRS frontal airbags would not protect the occupant in those situations.

SRS airbag deployment depends on the level of force experienced in the passenger compartment during a collision. That level differs from one type of collision to another, and it may have no bearing on the visible damage done to the vehicle itself.

- Example of accident in which the driver's/driver's and front passenger's SRS frontal airbag(s) will most likely deploy

A head-on collision against a thick concrete wall at a vehicle speed of 12 to 19 mph (20 to 30 km/h) or higher activates only the driver's SRS frontal airbag or both driver's and front passenger's SRS frontal airbags. The airbag(s) will also be activated when the vehicle is exposed to a frontal impact similar in fashion and magnitude to the collision described above.

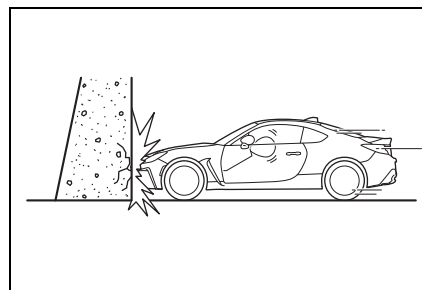

- Examples of the types of acci-

dents in which it is possible that the driver's/driver's and front passenger's SRS frontal airbag(s) will deploy

Only the driver's SRS frontal airbag or both driver's and front passenger's SRS frontal airbags may be activated when the vehicle sustains a hard impact in the undercarriage area from the road surface (such as when the vehicle plunges into a deep ditch, is severely impacted or knocked hard against an obstacle on the road such as a curb).

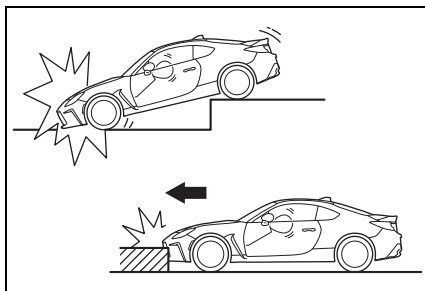

- Examples of the types of accidents in which deployment of the driver's/driver's and front passenger's SRS frontal airbag(s) is unlikely to occur

There are many types of collisions which might not necessarily require deployment of driver's/driver's and front passenger's SRS frontal airbag(s). In the event of accidents like those illustrated, the driver's/driver's and front passenger's SRS frontal airbag(s) may not deploy depending on the level of accident forces involved.

- The vehicle strikes an object, such as a telephone pole or sign pole.

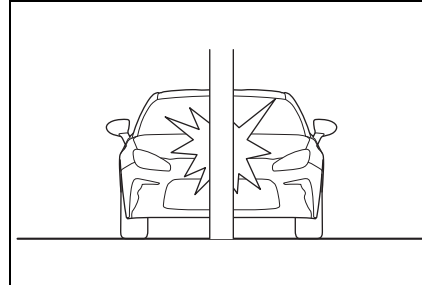

- The vehicle slides under the load bed of a truck.

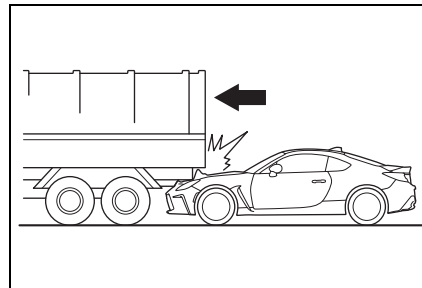

- The vehicle sustains an oblique offset frontal impact.

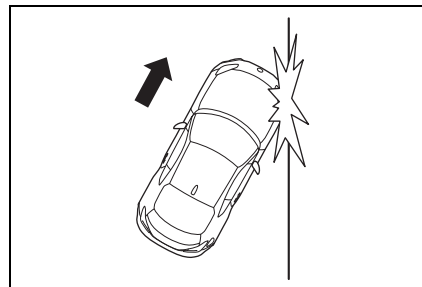

- The vehicle sustains an offset frontal collision.

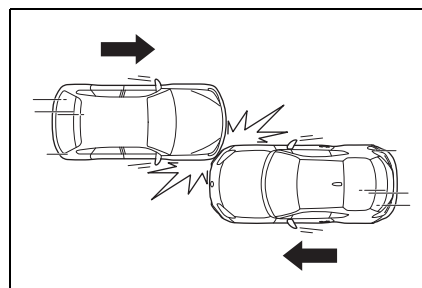

- The vehicle strikes an object that can move or deform, such as a parked vehicle.

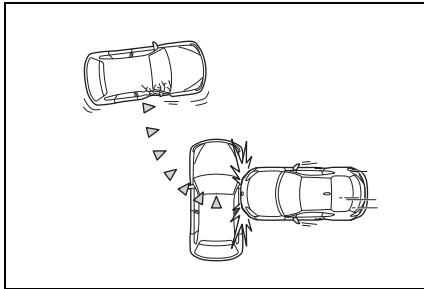

- Examples of the types of accidents in which the driver's/driver's and front passenger's SRS frontal airbag(s) are not designed to deploy in most cases

The driver's and front passenger's SRS frontal airbags are not designed to deploy in most of the following cases.

- If the vehicle is struck from the side or from behind

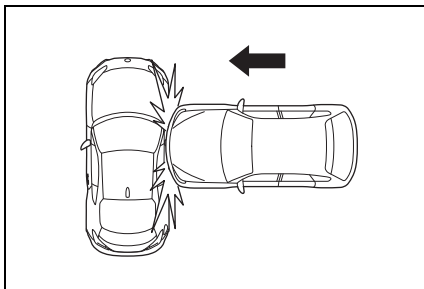

- If the vehicle rolls onto its side or roof

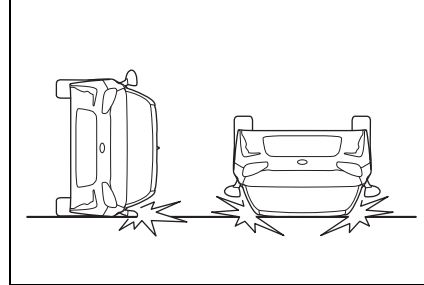

- If the vehicle is involved in a low-speed frontal collision

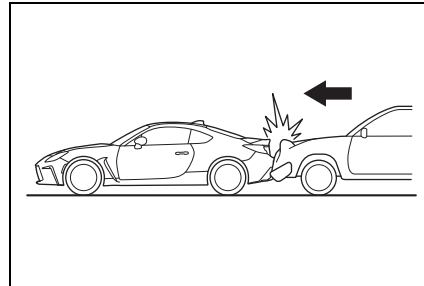

In an accident where the vehicle is impacted more than once, the driver's and/or front passenger's SRS frontal airbag(s) will deploy only once on the first impact of sufficient severity.

Example: In the case of a double collision, first with another vehicle, then against a concrete wall in immediate succession, once either or both of the driver's and front passenger's SRS frontal airbags is/are activated on the first impact, it/they will not be activated on the second impact.

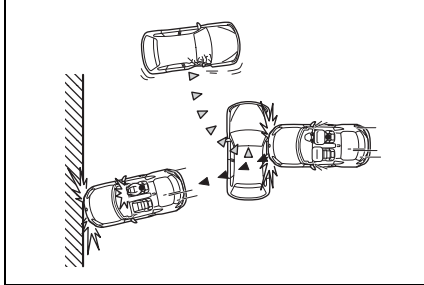

### ■ Warning labels and tag

This vehicle has warning labels on the driver's and front passenger's sun visors beginning with the phrase "EVEN WITH ADVANCED AIR BAGS" and a tag attached to the glove box lid beginning with the phrase "Even with Advanced Air Bags". Make sure that you carefully read the instructions on the warning labels and tag.

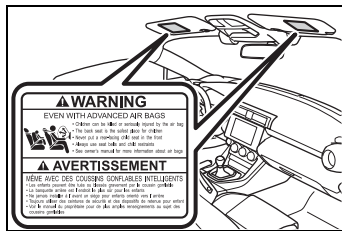

### ■ Toyota advanced frontal airbag system

- The SRS side airbag and seatbelt pretensioner are not controlled by the Toyota advanced frontal airbag system.
- The front passenger's SRS side airbag and SRS curtain shield airbag are not controlled by the Toyota advanced frontal airbag system.

### ■ Conditions in which front passenger's SRS frontal airbag is not activated

The front passenger's SRS frontal airbag will not be activated when any of the following conditions are met regarding the front passenger's seat:

- The seat is empty.
  - The seat is equipped with an appropriate child restraint system and an infant or a child is restrained in it. (See WARNING that follows.)
  - The front passenger's occupant detection system is malfunctioning.
- ### ■ Conditions in which front passenger's SRS frontal airbag is activated

The front passenger's SRS frontal airbag will be activated for deployment upon impact when any of the following conditions are met regarding the front passenger's seat.

- When the seat is occupied by an adult.
- When certain items (e.g. jug of water) are placed on the seat.

### ■ If the front passenger's frontal airbag ON indicator illuminates and the OFF indicator turns off

If you think that the Front passenger's frontal airbag ON/OFF indicator is incorrect, take the following actions.

- Ensure that no article is placed on the seat other than the occupant.
- Ensure that the backward-forward position and seatback of front passenger's seat are locked into place securely by moving the seat back and forth.

If the ON indicator still remains illuminated while the OFF indicator turns off after taking relevant corrective actions described above, immediately contact your Toyota dealer for an inspection.

Even if the system has passed the dealer inspection, it is recommended that on subsequent trips the small adult always take the rear seat.

■ **If the passenger's frontal airbag OFF indicator illuminates and the ON indicator turns off even when the front passenger's seat is occupied by an adult**

This can be caused by the adult incorrectly sitting in the front passenger's seat.

- 1 Turn the engine switch off.
- 2 Ask the front passenger to set the seatback to the upright position, sit up straight in the center of the seat cushion, correctly fasten the seatbelt, position his/her legs out forward, and adjust the seat to the rearmost position.
- 3 Turn the engine switch to ON.

If the OFF indicator remains illuminated while the ON indicator remains off, take the following actions.

- 1 Turn the engine switch off.
- 2 Make sure that the front passenger does not use a blanket, extra seat cushion, seat cover, extra seat heater or massager, etc.
- 3 If wearing excessive layers of clothing, the front passenger should remove any unnecessary items before sitting in the front passenger's seat, or should sit in a rear seat.
- 4 Turn the engine switch to ON and wait 6 seconds to allow the system to complete self-checking. Following the system check, both indicators turn off for 2 seconds. Now, the ON indicator should illuminate while the OFF indicator remains off.

If the OFF indicator still remains illuminated while the ON indicator remains off, ask the occupant to move to the rear seat and immediately contact your Toyota dealer for an inspection.

■ **If the seatbelt buckle switch and/or front passenger's occupant detection system have failed**

If the seatbelt buckle switch and/or front passenger's occupant detection system have failed, the SRS warning light will illuminate. Have the system inspected by your Toyota dealer immediately if the SRS warning light illuminates.

■ **When to contact your Toyota dealer**

If your vehicle has sustained impact, this may affect the proper function of the Toyota advanced frontal airbag system. Have your vehicle inspected at your Toyota dealer. Do not use the front passenger's seat while driving the vehicle to your Toyota dealer.

 **WARNING**

■ **When using a child restraint system**

NEVER INSTALL A CHILD RESTRAINT SYSTEM IN THE FRONT PASSENGER'S SEAT EVEN IF THE FRONT PASSENGER'S SRS FRONTAL AIRBAG IS DEACTIVATED. Be sure to install it in the REAR seat in a correct manner. Also, it is strongly recommended that any forward facing child seat or booster seat be installed in the REAR seat, and that even children who have outgrown a child restraint system be also seated in the REAR seat. This is because children sitting in the front passenger's seat may be killed or severely injured should the front passenger's SRS frontal airbag deploy. REAR seats are the safest place for children.

**⚠ WARNING****■ General Precautions regarding front passenger's SRS frontal airbag**

When the front passenger's seat is occupied by an adult, observe the following precautions. Failure to do so may lessen the load on the front passenger's seat, deactivating the front passenger's SRS frontal airbag despite the fact that the seat is occupied by an adult. This may result in personal injury.

- Do not allow the rear seat occupant to lift the front passenger's seat cushion using his/her feet.
- Do not place any article under the front passenger's seat, or squeeze any article from behind and under the seat.
- Do not squeeze any article between the front passenger's seat and side trim/pillar, door or center console box. This may lift the seat cushion.

**■ When a small adult is seated in the front passenger's seat**

When a small adult is seated in the front passenger's seat, the Toyota advanced frontal airbag system may or may not activate the front passenger's SRS frontal airbag depending on the occupant's seating posture. If the OFF indicator remains illuminated while the ON indicator turns off when a small adult is seated in the front passenger's seat, refer to P.45.

**■ General Precautions regarding occupant detection system**

Do not kick the front passenger seat or subject it to severe impact. Otherwise, the SRS warning light may illuminate to indicate a malfunction of the front passenger occupant detection system. In this case, contact your Toyota dealer immediately.

**■ After deployment**

Do not touch the SRS airbag system components around the steering wheel and dashboard with bare hands right after deployment. Doing so can cause burns because the components can be very hot as a result of deployment.

**⚠ NOTICE****■ Toyota advanced frontal airbag system precautions**

Observe the following precautions. Failure to do so may prevent the Toyota advanced frontal airbag system from functioning correctly or cause the system to fail.

- Do not apply any strong impact to the front passenger's seat such as by kicking.
- Do not let rear passengers rest their feet between the front seatback and seat cushion.
- Do not spill liquid on the front passenger's seat. If liquid is spilled, wipe it off immediately.
- Do not remove or disassemble the front passenger's seat.

**NOTICE**

- Do not install any accessory (such as an audio amplifier) other than a genuine Toyota accessory under the front passenger's seat.
  - Do not place anything (shoes, umbrella, etc.) under the front passenger's seat.
  - Do not place any objects (books, etc.) around the front passenger's seat.
  - Do not use the front passenger's seat with the head restraint removed.
  - Do not leave any articles on the front passenger's seat or the seatbelt tongue and buckle engaged when you leave your vehicle.
  - Do not put sharp object(s) on the seat or pierce the seat upholstery.
  - Do not place a magnet near the seatbelt buckle and the seatbelt retractor.
  - Do not use front seats with their backward-forward position adjuster and seatback adjuster not being locked into place securely. If any of them are not locked securely, adjust them again. For adjusting procedure, refer to P.119.
- **When using the front passenger's seat**
- Observe the following precautions as it increase the load on the front passenger's seat and not work properly.
- Do not install any accessory such as a table or TV onto the seatback.

- Do not allow the rear seat occupant to place his/her hands or legs on the front passenger's seatback, or allow him/her to pull the seatback.

### SRS side airbag and SRS curtain shield airbag

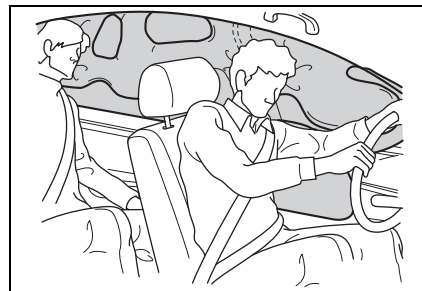

#### ■ SRS side airbag

The SRS side airbag is stored in the door side of each front seat seatback, which bears an "SRS AIRBAG" mark.

In a moderate to severe side impact collision, the SRS side airbag on the impacted side of the vehicle deploys between the occupant and the door panel and supplements the seatbelt by reducing the impact on the occupant's chest and waist. The SRS side airbag operates only for front seat occupants.

#### ■ SRS curtain shield airbag

Your vehicle is equipped with a SRS curtain shield airbag system that complies with the Federal Motor Vehicle Safety Standard (FMVSS) No. 226.

The SRS curtain shield airbag



on each side of the cabin is stored in the roof side (between the front pillar and a point over the rear seat). An “SRS AIR-BAG” mark is located at the top of each center pillar.

In a moderate to severe side impact collision, the SRS curtain shield airbag on the impacted side of the vehicle deploys between the occupant and the side window and supplements the seatbelt by reducing the impact on the occupant’s head.

In a rollover, SRS curtain shield airbags on both sides of the vehicle deploy between the occupant and the side window and supplement the seatbelt by reducing the impact to the occupant’s head.

In an offset frontal collision, SRS curtain shield airbags on both sides of the vehicle deploy between the occupant and the side window and supplement the seatbelt by reducing the impact to the occupant’s head and chest.

#### ■ Operation

The SRS side airbag and SRS curtain shield airbag can function only when the engine switch is in ON.

The following airbags deploy independently of each other since each has its own impact sensor.

- Driver’s SRS side airbag
- Front passenger’s SRS side airbag
- SRS curtain shield airbag (right-hand side)
- SRS curtain shield airbag (left-hand side)

Therefore, they may not both deploy in the same accident. Also, the SRS side airbag and SRS curtain shield airbag deploys independently of the driver’s and front passenger’s SRS frontal airbags in the steering wheel and instrument panel.

For the locations of the sensors and control modules, refer to P.29.

#### ■ After deployment

After the deployment, the SRS side airbag immediately starts to deflate. The time required from detection of an impact to deflation of an SRS side airbag after deployment is shorter than the blink of an eye.

The SRS curtain shield airbag remains inflated for a while following deployment then slowly deflates.

The SRS side airbag and SRS curtain shield airbag deploy even when no one occupies the seat on the side on which an impact is applied.

When the SRS side airbag and SRS curtain shield airbag

deploy, a sudden, fairly loud inflation noise will be heard and some smoke will be released. These occurrences are a normal result of the deployment. This smoke does not indicate a fire in the vehicle.

#### ■ Example of the type of accident

The SRS side airbag and SRS curtain shield airbag are designed as follows:

- To deploy in the event of an accident involving a moderate to severe side impact collision
- To function on a one-time-only basis.

The SRS side airbag and SRS curtain shield airbag are not designed to deploy in the following cases:

- In most lesser side impact
- In most frontal or most rear impacts (because the SRS side airbag and SRS curtain shield airbag deployment would not protect the occupant in those situations)

The SRS curtain shield airbags are also designed to deploy when the vehicle is in an extremely inclined state such as during a rollover. They are not designed to deploy in most lesser inclined states.

SRS side airbag and SRS curtain shield airbag deployment

depend on the level of force experienced in the passenger compartment during a side impact collision. That level differs from one type of collision to another, and it may have no bearing on the visible damage done to the vehicle itself.

- Example of the type of accident in which the SRS side airbag will most likely deploy.

A severe side impact near the front seat.

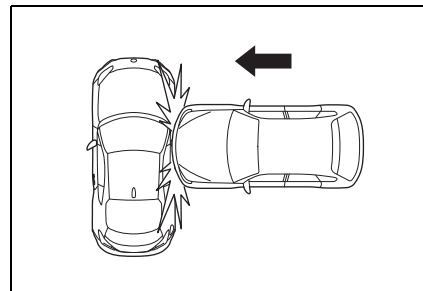

- Examples of the types of accidents in which the SRS curtain shield airbag will most likely deploy.
- The vehicle is involved in a severe side impact near the front seat or the rear seat.

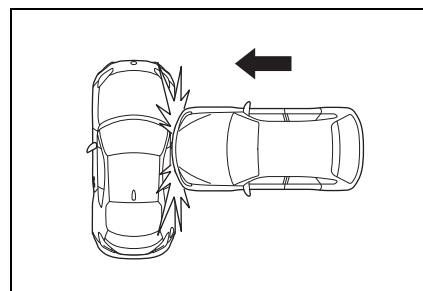

- The vehicle rolls onto its side or the roof.

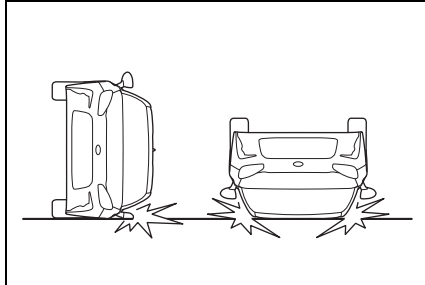

- The angle of vehicle tip-up is marginal or the skidding vehicle's tires hit a curbstone laterally.

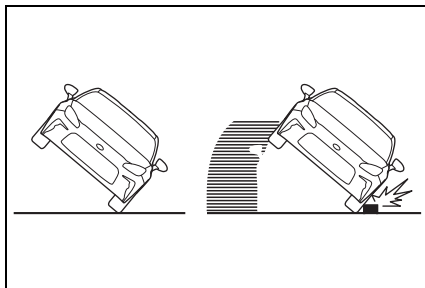

- An offset frontal collision that is severe enough to deploy the front airbag.

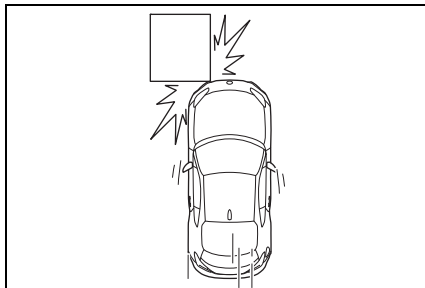

- Examples of the types of accidents in which it is possible that the SRS side airbag and the SRS curtain shield airbag will deploy.

It is possible that the SRS side and curtain shield airbags will deploy if a serious impact occurs to the

underside of your vehicle. Some examples are shown in the illustration.

- Hitting a curb, edge of pavement or hard surface

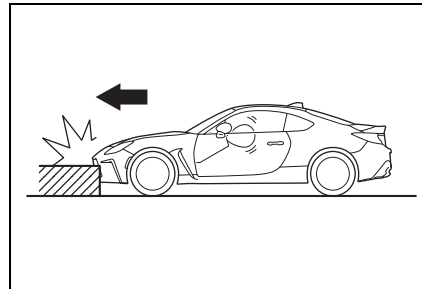

- Falling into or jumping over a deep hole

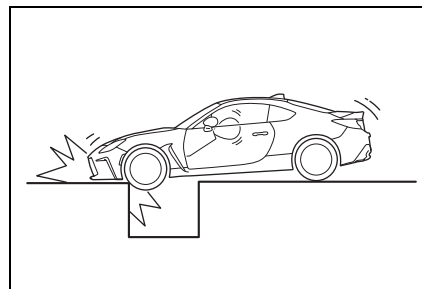

- Landing hard or vehicle falling

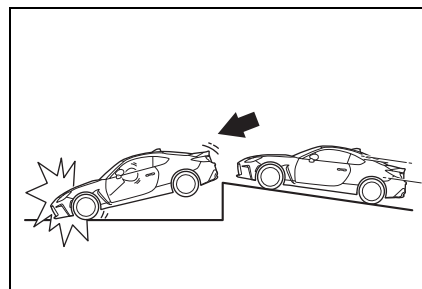

- Examples of the types of accidents in which the SRS side airbag is unlikely to deploy.

There are many types of collisions which might not necessarily require SRS side airbag deployment. In the

event of accidents like those illustrated, the SRS side airbag may not deploy depending on the level of accident forces involved.

- The vehicle is involved in an oblique side-on impact.

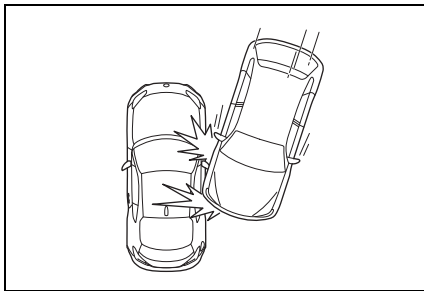

- The vehicle is involved in a side-on impact in an area outside the vicinity of the passenger compartment.

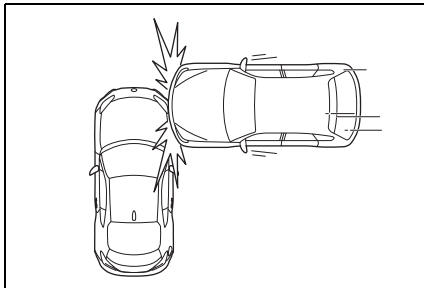

- The vehicle strikes a telephone pole or similar object.

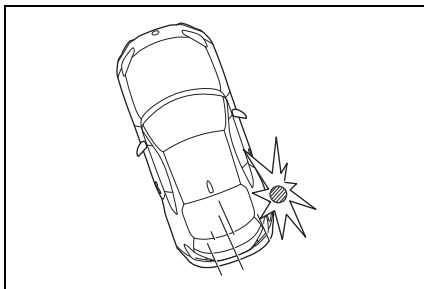

- The vehicle is involved in a side-on impact from a motorcycle.

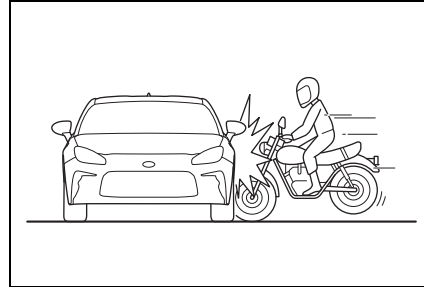

- The vehicle rolls onto its side or the roof.

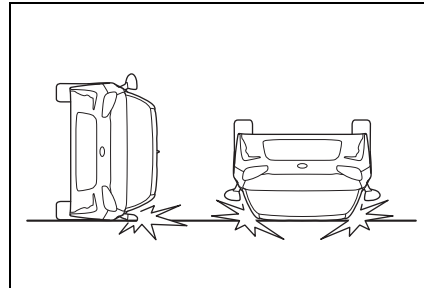

- Examples of the types of accidents in which the SRS curtain shield airbag is unlikely to deploy.

There are many types of collisions which might not necessarily require SRS curtain shield airbag deployment. In the event of accidents like those illustrated, the SRS curtain shield airbag may not deploy depending on the level of accident forces involved.

- The vehicle is involved in an oblique side-on impact.

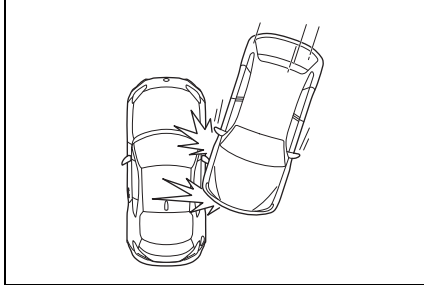

- The vehicle is involved in a side-on impact in an area outside the vicinity of the passenger compartment.

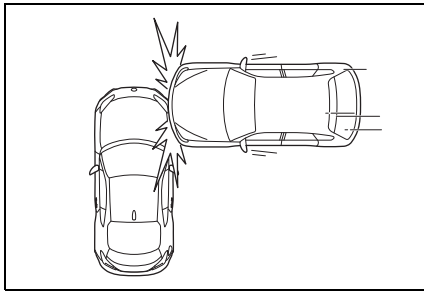

- The vehicle strikes a telephone pole or similar object.

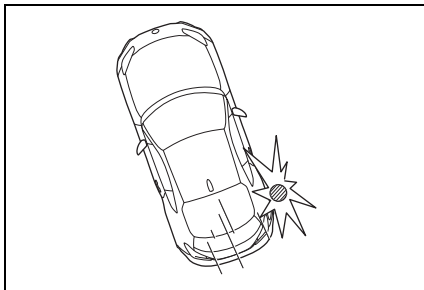

- The vehicle is involved in a side-on impact from a motorcycle.

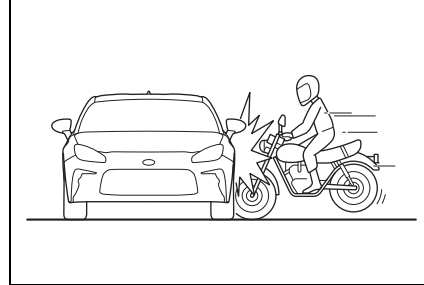

- Examples of the types of accidents in which the SRS side airbag and SRS curtain shield airbag are not designed to deploy in most cases

In the event of accidents like those illustrated, the SRS side airbag and SRS curtain shield airbag are not designed to deploy in most cases.

- The vehicle is involved in frontal collision with another vehicle (moving or stationary).

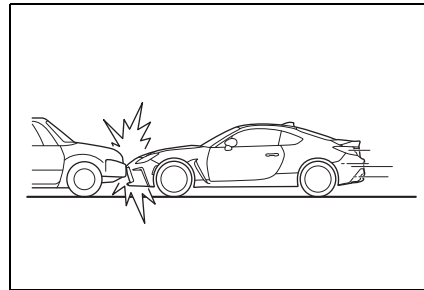

- The vehicle is struck from behind.

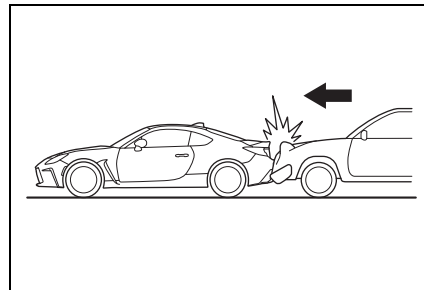

- The vehicle pitches end over end.

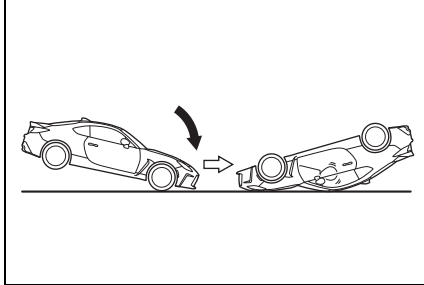

In an accident where the vehicle is struck from the side more than once, the SRS side airbag and SRS curtain shield airbag deploy only once on the first impact.

Example: In the case of a double side impact collision, first with one vehicle and immediately followed by another from the same direction, once the SRS side airbag and SRS curtain shield airbag are activated on the first impact, they will not be activated on the second.

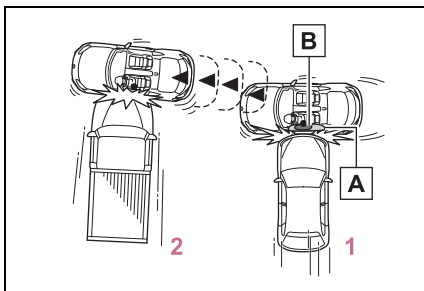

**A** SRS curtain shield airbag

**B** SRS side airbag

**1** First impact

**2** Second impact

### **⚠ WARNING**

#### ■ After deployment

- Do not touch the SRS side airbag system components around the front seat seatback with bare hands right after deployment. Doing so can cause burns because the components can be very hot as a result of deployment.
- After deployment, do not touch any part of the SRS curtain shield airbag system (from the front pillar to the part of the roof side over the rear seat). Doing so can cause burns because the components can be very hot as a result of deployment.

### SRS Airbag System Monitors

A diagnostic system continually monitors the readiness of the SRS airbag system (including seatbelt pretensioners) with the engine switch is in ON. The SRS warning light will show normal system operation by illuminating for approximately 6 seconds when the engine switch is turned to ON.

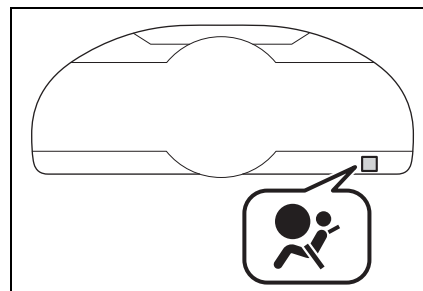

The following components are monitored by the indicator:

- Front impact sensor
  - Right-hand side
  - Left-hand side
- Airbag control module (including impact sensor and rollover sensor)
- Frontal airbag module
  - Driver's side
  - Front passenger's side
- Knee airbag module
  - Driver's side
- Side impact sensor
  - Center pillar left-hand side
  - Center pillar right-hand side
  - Forward of rear wheel house left-hand side
  - Forward of rear wheel house right-hand side
  - Door left-hand side
  - Door right-hand side
- Side airbag module
  - Driver's side
  - Front passenger's side
- Curtain shield airbag module
  - Right-hand side
  - Left-hand side
- Seatbelt pretensioner
  - Driver's side
- Seatbelt pretensioner and adaptive force limiter
  - Front passenger's side
- Seatbelt buckle switch
  - Front passenger's side
- Front passenger's occupant

detection system sensors

- Front passenger's frontal airbag ON and OFF indicator
- All related wiring

#### ■ SRS warning light

Have the system inspected by your Toyota dealer immediately if the SRS warning light illuminates.

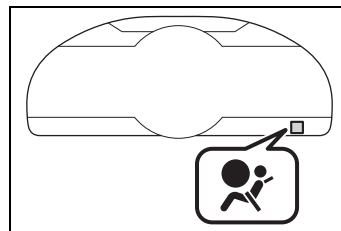

#### ⚠ WARNING

##### ■ SRS warning light

If the warning light exhibits any of the following conditions, immediately stop the vehicle in a safe place, and consult a Toyota dealer. Unless a technician checks and repairs the system as needed, the seatbelt pretensioners and/or the SRS airbag may not operate properly in the event of a collision, which may result in injury.

- Flashing or flickering of the warning light
- No illumination of the warning light when the engine switch is first turned to ON
- Continuous illumination of the warning light
- Illumination of the warning light while driving

## Front passenger occupant classification system

Your vehicle is equipped with a front passenger occupant classification system. This system detects the conditions of the front passenger seat and activates or deactivates the front passenger airbag.

### System components

The front passenger's frontal airbag ON and OFF indicators show you the status of the front passenger's SRS frontal airbag. When the engine switch is turned to ON, both the ON and OFF indicators illuminate while the system is checked, after which both indicators turn off.

After that, one of the indicators illuminates depending on the status of the front passenger's SRS frontal airbag determined by the Toyota advanced frontal airbag monitoring system.

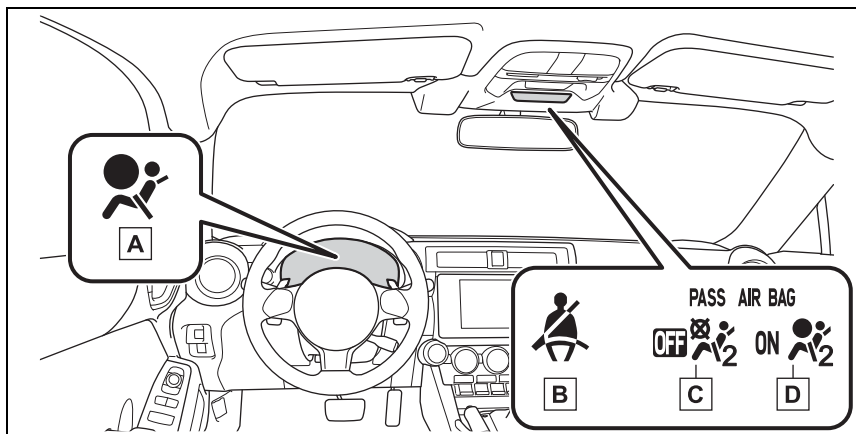

- A** SRS warning light
- B** Front passenger's seat belt reminder light
- C** "AIR BAG OFF" indicator light
- D** "AIR BAG ON" indicator light



**WARNING****■ Front passenger occupant classification system precautions**

Observe the following precautions regarding the front passenger occupant classification system. Failure to do so may cause the occupant classification system to not function correctly, resulting in death or serious injury.

- Wear the seat belt properly.
- Do not apply excessive force to the seat.
- Do not put sharp object(s) on the seat or pierce the seat upholstery.
- Do not put objects under the front passenger seat.
- Do not use a seat accessory, such as a cushion or seat cover, that covers the seat cushion surface.
- Do not spill liquid on the front passenger seat. If liquid is spilled, wipe it off immediately and dry the seat. If the SRS warning light illuminates, dry the seat until the warning light turns off. If the SRS warning light stays on even when the seat has dried, do not allow anyone to sit on the front passenger seat and have the system checked by your Toyota dealer. If the SRS warning light does not illuminate, check that the airbag ON/OFF indicator light works properly. If the indicator light does not work properly, do not allow anyone to sit in the front passenger's seat and have the system inspected by your Toyota dealer.
- Do not remove or disassemble the front passenger seat. Also, do not replace or modify the seat upholstery or foam inside the seat.
- Do not install any accessory (such as an audio amplifier) other than a genuine Toyota accessory under the front passenger's seat.
- Do not place a magnetized items near the seat belt buckle.
- Never install a rearward facing child seat in the front passenger's seat even if the front passenger's SRS frontal airbag is deactivated. Be sure to install it in the rear seat in a correct manner. Also, it is strongly recommended that any forward facing child seat or booster seat be installed in the rear seat, and that even children who have outgrown a child restraint system be also seated in the rear seat. This is because children sitting in the front passenger's seat may be killed or severely injured should the front passenger's SRS frontal airbag deploy. Toyota believes that the rear seats are the safest place for children.
- If luggage or electronic devices are placed on the front passenger seat, the OFF indicator may turn off and the ON indicator may illuminate. If this occurs, the front passenger's airbag may deploy during a collision. If this is not desirable, remove the luggage or electronic devices from the front passenger seat.

**WARNING**

- Modifications for persons with disabilities that may affect the front passenger occupant classification system. (U.S. only)  
Removing, replacing or modifying any parts of the front seats, seat belts, front bumper, front side frame, instrument panel, meter, steering wheel, steering column, tires, suspension or floor panel can affect the operation of the Toyota front passenger occupant classification system.

### Condition and operation in the front passenger occupant classification system <sup>\*1</sup>

#### ■ Adult <sup>\*2</sup>

Indicator/warning light	“AIR BAG ON” and “AIR BAG OFF” indicator lights	“AIR BAG ON”
	SRS warning light	Off
	Front passenger’s seat belt reminder light	Flashing <sup>*3</sup>
Devices	Front passenger airbag	On
	Front side airbag <sup>*4</sup>	
	Front curtain shield airbag <sup>*4</sup>	
	Front passenger’s seat belt pretensioner <sup>*4</sup>	

#### ■ Child <sup>\*5, \*6</sup>

Indicator/warning light	“AIR BAG ON” and “AIR BAG OFF” indicator lights	“AIR BAG OFF” <sup>*5</sup>
	SRS warning light	Off
	Front passenger’s seat belt reminder light	Flashing <sup>*3</sup>

Devices	Front passenger airbag	Off
	Front side airbag <sup>*4</sup>	On
	Front curtain shield airbag <sup>*4</sup>	
	Front passenger's seat belt pretensioner <sup>*4</sup>	

■ Child restraint system with infant<sup>\*6, \*7, \*8</sup>

Indicator/warning light	"AIR BAG ON" and "AIR BAG OFF" indicator lights	"AIR BAG OFF" <sup>*9</sup>
	SRS warning light	Off
	Front passenger's seat belt reminder light	
Devices	Front passenger airbag	Off
	Front side airbag <sup>*4</sup>	On
	Front curtain shield airbag <sup>*4</sup>	
	Front passenger's seat belt pretensioner <sup>*4</sup>	

■ Unoccupied

Indicator/warning light	"AIR BAG ON" and "AIR BAG OFF" indicator lights	"AIR BAG OFF"
	SRS warning light	Off
	Front passenger's seat belt reminder light	
Devices	Front passenger airbag	Off
	Front side airbag <sup>*4</sup>	On
	Front curtain shield airbag <sup>*4</sup>	
	Front passenger's seat belt pretensioner <sup>*4</sup>	

■ There is a malfunction in the system

Indicator/warning light	"AIR BAG ON" and "AIR BAG OFF" indicator lights	"AIR BAG OFF"
	SRS warning light	On
	Front passenger's seat belt reminder light	Off
Devices	Front passenger airbag	Off
	Front side airbag <sup>*4</sup>	On
	Front curtain shield airbag <sup>*4</sup>	
	Front passenger's seat belt pretensioner <sup>*4</sup>	

- \*1: The occupant classification system does not operate during selfchecking.
- \*2: The system judges a person of adult size as an adult. When a smaller adult sits in the front passenger seat, the system may not recognize him/her as an adult depending on his/her physique and posture.
- \*3: In the event the front passenger does not wear a seat belt.
- \*4: The front passenger's SRS side airbag, SRS curtain shield airbag and seat belt pretensioner are not controlled by the occupant classification system.
- \*5: For some children, child in seat, child in booster seat or child in convertible seat, the system may not recognize him/her as a child. Factors which may affect this can be the physique or posture. Children who have outgrown a child restraint system should always wear the seat belt when sitting in the seat irrespective of whether the airbag is deactivated or activated.
- \*6: Do not place more than one child on the front passenger seat. Failure to do so may prevent the front passenger occupant classification system from functioning correctly.
- \*7: When a child restraint system is installed on the front passenger seat, do not place any article on the seat other than the child occupant and a child restraint system. Failure to do so may prevent the front passenger occupant classification system from functioning correctly or cause the system to fail.
- \*8: Never install a rear-facing child restraint system on the front passenger seat. See the caution that follows regarding installation of a child restraint system. (→P.64)

\*9: In case the indicator is not illuminated, consult this manual on how to installing the child restraint system properly. (→P.64)

## Exhaust gas precautions

**Harmful substance to the human body is included in exhaust gases if inhaled.**

### WARNING

Exhaust gases include harmful carbon monoxide (CO), which is colorless and odorless. Observe the following precautions. Failure to do so may cause exhaust gases enter the vehicle and may lead to an accident caused by light-headedness, or may lead to death or a serious health hazard.

#### ■ Important points while driving

- Keep the trunk lid closed.
- If you smell exhaust gases in the vehicle even when the trunk lid is closed, open the windows and have the vehicle inspected at your Toyota dealer as soon as possible.

#### ■ When parking

- If the vehicle is in a poorly ventilated area or a closed area, such as a garage, stop the engine.
- Do not leave the vehicle with the engine on for a long time. If such a situation cannot be avoided, park the vehicle in an open space and ensure that exhaust fumes do not enter the vehicle interior.
- Do not leave the engine running in an area with snow build-up, or where it is snowing. If snowbanks build up around the vehicle while the engine is running, exhaust gases may collect and enter the vehicle.

#### ■ Exhaust pipe

The exhaust system needs to be checked periodically. If there is a hole or crack caused by corrosion, damage to a joint or abnormal exhaust noise, be sure to have the vehicle inspected and repaired by your Toyota dealer.

**Riding with children**

**Observe the following precautions when children are in the vehicle.**

**Use a child restraint system appropriate for the child, until the child becomes large enough to properly wear the vehicle's seat belt.**

- It is recommended that children sit in the rear seats to avoid accidental contact with the shift lever, wiper switch, etc.
- Use the window lock switch to avoid children operating the power window accidentally. (→P.130)
- Do not let small children operate equipment which may catch or pinch body parts, such as the power window, hood, trunk, seats etc.

 **WARNING****■ When children are in the vehicle**

Never leave children unattended in the vehicle, and never allow children to have or use the key.

Children may be able to start the vehicle or shift the vehicle into neutral. There is also a danger that children may injure themselves by playing with the windows or other features of the vehicle. In addition, heat build-up or extremely cold temperatures inside the vehicle can be fatal to children.

### Child restraint systems

**Before installing a child restraint system in the vehicle, there are precautions that need to be observed, different types of child restraint systems, as well as installation methods, etc., written in this manual.**

**Use a child restraint system when riding with a small child that cannot properly use a seat belt. For the child's safety, install the child restraint system to a rear seat. Be sure to follow the installation method that is in the operation manual enclosed with the restraint system.**

### Table of contents

- Points to remember: →P.64
- Child restraint system: →P.66
- When using a child restraint system: →P.66
- Child restraint system installation method
  - Fixed with a seat belt: →P.67
  - Fixed with child restraint LATCH anchors: →P.71
  - Using an anchor bracket (for top tether strap): →P.73

### Points to remember

The laws of all 50 states of the U.S.A. as well as Canada now require the use of child restraint systems.

- Prioritize and observe the warnings, as well as the laws and regulations for child restraint systems.
- Use a child restraint system until the child becomes large enough to properly wear the vehicle's seat belt.
- Choose a child restraint system that suits your vehicle and is appropriate to the age and size of the child.

### WARNING

#### ■ When a child is riding

Observe the following precautions.

Failure to do so may result in death or serious injury.

- For effective protection in automobile accidents and sudden stops, a child must be properly restrained, using a seat belt or child restraint system which is correctly installed. For installation details, refer to the operation manual enclosed with the child restraint system. General installation instruction is provided in this manual.



**WARNING**

- Toyota strongly urges the use of a proper child restraint system that conforms to the weight and size of the child, installed on the rear seat. According to accident statistics, the child is safer when properly restrained in the rear seat than in the front seat.
- Holding a child in your or someone else's arms is not a substitute for a child restraint system. In an accident, the child can be crushed against the windshield or between the holder and the interior of the vehicle.

**■ Handling the child restraint system**

If the child restraint system is not properly fixed in place, the child or other passengers may be seriously injured or even killed in the event of sudden braking, sudden swerving, or an accident.

- If the vehicle were to receive a strong impact from an accident, etc., it is possible that the child restraint system has damage that is not readily visible. In such cases, do not reuse the restraint system.
- Make sure you have complied with all installation instructions provided with the child restraint system manufacturer and that the system is properly secured.
- Keep the child restraint system properly secured on the seat even if it is not in use. Do not store the child restraint system unsecured in the passenger compartment.
- If it is necessary to detach the child restraint system, remove it from the vehicle or store it securely in the trunk.

**Child restraint system**

■ **Types of child restraint system installation methods**

Confirm with the operation manual enclosed with the child restraint system about the installation of the child restraint system.

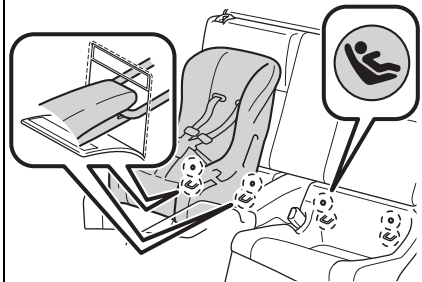
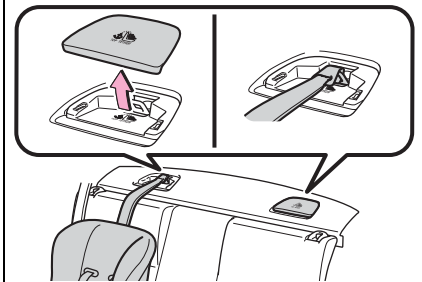
Installation method		Page
Seat belt attachment		P.67
Child restraint LATCH anchors attachment		P.71
Anchor brackets (for top tether strap) attachment		P.73

**When using a child restraint system**

Child restraint systems cannot be installed to the front passenger's seat.

■ **When installing a child restraint system to a front passenger seat**

**⚠ WARNING****■ When installing a child restraint system**

Observe the following precautions.

Failure to do so may result in death or serious injury.

- Never use a child restraint system on the front passenger seat. The force of the rapid inflation of the front passenger airbag can cause death or serious injury to children in the event of an accident.
- Do not allow the child to lean his/her head or any part of his/her body against the door or the area of the seat, front pillars or roof side rails from which the SRS side airbags or SRS curtain shield airbags deploy even if the child is seated in the child restraint system. It is dangerous if the SRS side and curtain shield airbags inflate, and the impact could cause death or serious injury to the child.



- When a booster seat is installed, always ensure that the shoulder belt is positioned across the center of the child's shoulder. The belt should be kept away from the child's neck, but not so that it could fall off the child's shoulder.
- Use child restraint system suitable to the age and size of the child and install it to the rear seat.

- If the driver's seat interferes with the child restraint system and prevents it from being attached correctly, attach the child restraint system to the right-hand rear seat.

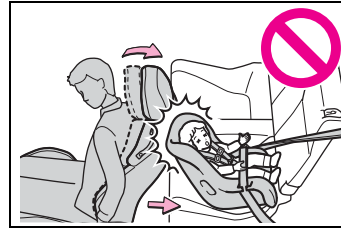

- Adjust the front passenger seat so that it does not interfere with the child restraint system.

**Child restraint system fixed with a seat belt**

A child restraint system for a small child or baby must itself be properly restrained on the seat with the lap portion of the lap/shoulder belt.

**■ Installing child restraint system using a seat belt (child restraint lock function belt)**

Install the child restraint system in accordance to the operation manual enclosed with the child restraint system.

### ■ Rear-facing—Infant seat/convertible seat

- 1 Place the child restraint system on the rear seat facing the rear of the vehicle.

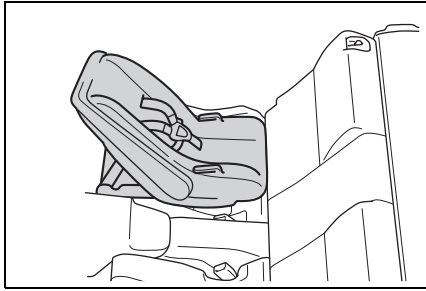

- 2 Run the seat belt through the child restraint system and insert the plate into the buckle. Make sure that the belt is not twisted.

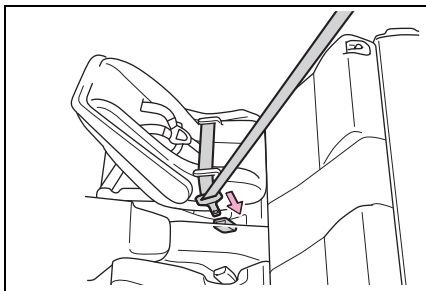

- 3 Fully extend the shoulder belt and allow it to retract to put it in lock mode. In lock mode, the belt cannot be extended.

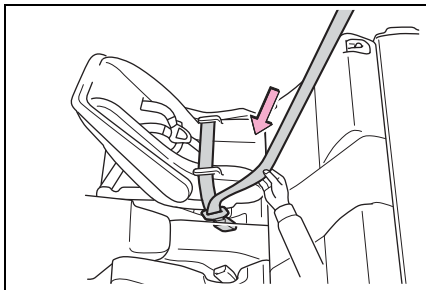

- 4 While pushing the child restraint system down into the rear seat, allow the shoulder belt to retract until the child restraint system is securely in place.

After the shoulder belt has retracted to a point where there is no slack in the belt, pull the belt to check that it cannot be extended.

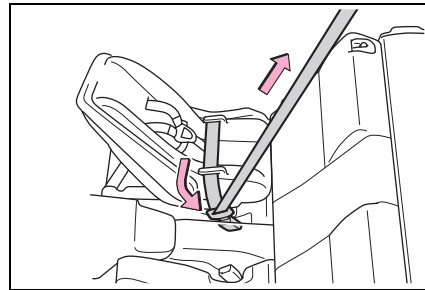

- 5 After installing the child restraint system, rock it back and forth to ensure that it is installed securely. (→P.70)

### ■ Forward-facing—Convertible seat

- 1 Place the child restraint system on the seat facing the front of the vehicle.

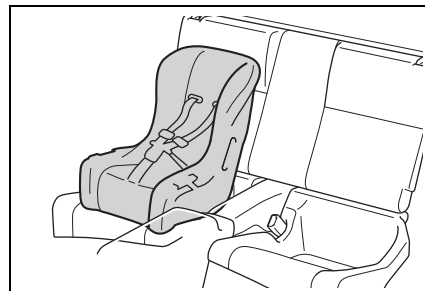

- 2 Run the seat belt through the child restraint system and insert the plate into the

buckle. Make sure that the belt is not twisted.

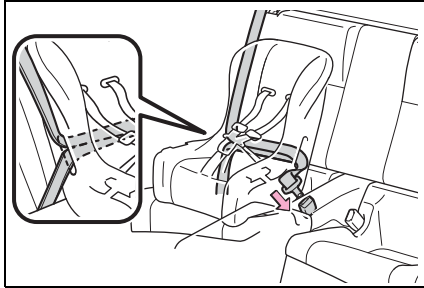

- 3 Fully extend the shoulder belt and allow it to retract to put it in lock mode. In lock mode, the belt cannot be extended.

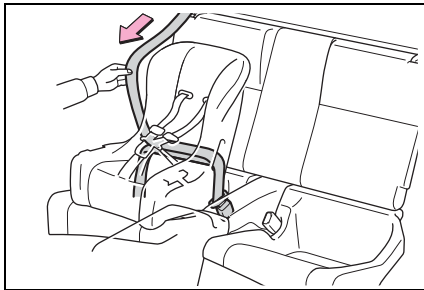

- 4 While pushing the child restraint system into the rear seat, allow the shoulder belt to retract until the child restraint system is securely in place.

After the shoulder belt has retracted to a point where there is no slack in the belt, pull the belt to

check that it cannot be extended.

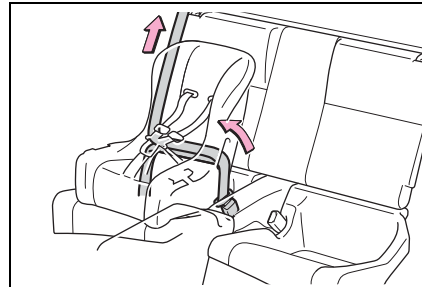

- 5 If the child restraint has a top tether strap, follow the child restraint manufacturer's operation manual regarding the installation, using the top tether strap to latch onto the top tether strap anchor. (→P.73)
- 6 After installing the child restraint system, rock it back and forth to ensure that it is installed securely. (→P.70)

#### ■ Booster seat

- 1 Place the child restraint system on the seat facing the front of the vehicle.

#### ► Booster type

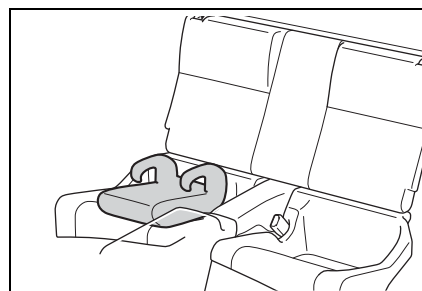

► High back type

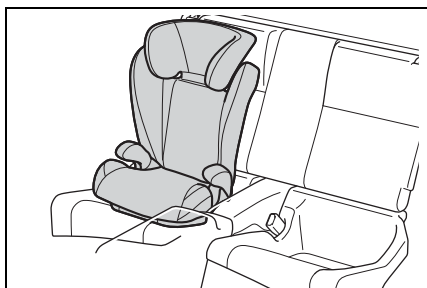

- 2 Sit the child in the child restraint system. Fit the seat belt to the child restraint system according to the manufacturer's instructions and insert the plate into the buckle. Make sure that the belt is not twisted.

Check that the shoulder belt is correctly positioned over the child's shoulder and that the lap belt is as low as possible. (→P.25)



■ **Removing a child restraint system installed with a seat belt**

Press the buckle release button and fully retract the seat belt.

When releasing the buckle, the child restraint system may spring up due to the rebound of the seat cushion. Release the buckle while holding down the child restraint

system.

Since the seat belt automatically reels itself, slowly return it to the stowing position.

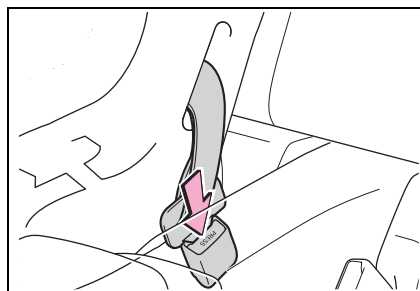

**⚠ WARNING**

■ **When installing a child restraint system**

Observe the following precautions. Failure to do so may result in death or serious injury.

- Do not allow children to play with the seat belt. If the seat belt becomes twisted around a child's neck, it may lead to choking or other serious injuries that could result in death. If this occurs and the buckle cannot be unfastened, scissors should be used to cut the belt.
- Ensure that the belt and plate are securely locked and the seat belt is not twisted.
- Shake the child restraint system left and right, and forward and backward to ensure that it has been securely installed.
- When a booster seat is installed, always ensure that the shoulder belt is positioned across the center of the child's shoulder. The belt should be kept away from the child's neck, but not so that it could fall off the child's shoulder.

**⚠ WARNING**

- Follow all installation instructions provided by the child restraint system manufacturer.
- If the seat is adjusted, reconfirm the security of the child restraint system.

**■ When installing a booster seat**

To prevent the belt from going into ALR lock mode, do not fully extend the shoulder belt. ALR mode causes the belt to tighten only. This could cause injury or discomfort to the child. (→P.27)

**■ Do not use a seat belt extender**

If a seat belt extender is used when installing a child restraint system, the seat belt will not securely hold the child restraint system, which could cause death or serious injury to the child or other passengers in the event of sudden braking, sudden swerving or an accident.

**Child restraint system fixed with child restraint LATCH anchors****■ Child restraint LATCH anchors**

LATCH anchors are provided for the each rear seat. (Buttons displaying the location of the anchors are attached to the seats.)

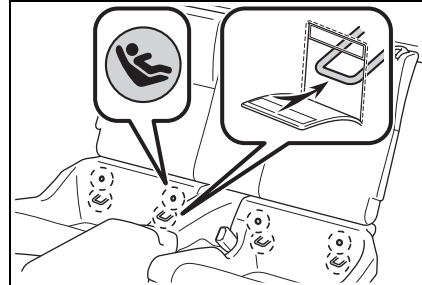
**■ When installing in the each rear seats**

Install the child restraint system in accordance to the operation manual enclosed with the child restraint system.

- ▶ With flexible lower attachments

- 1 Open the anchor covers, and install the child restraint system to the seat.

The bars are installed behind the anchor covers.

For owners in Canada:  
The symbol on a child restraint system indicates the presence of a

lower connector system.

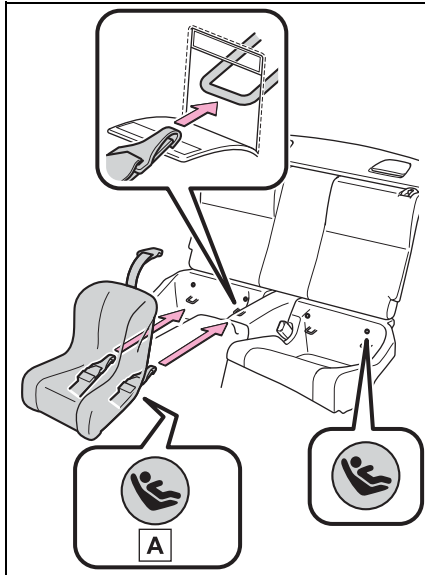

**A** Canada only

► With rigid lower attachments

- 1 Open the anchor covers, and install the child restraint system to the seat.

The bars are installed behind the anchor covers.

For owners in Canada:  
The symbol on a child restraint system indicates the presence of a

lower connector system.

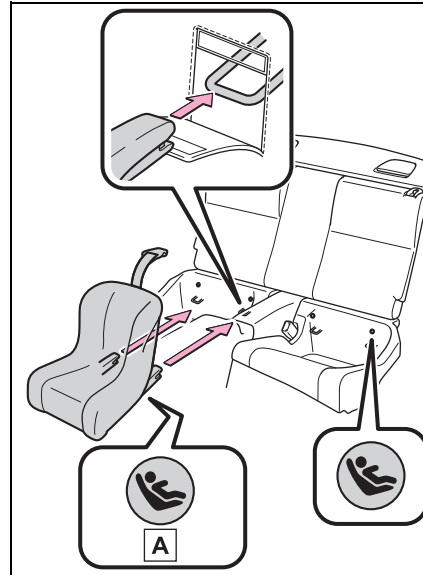

**A** Canada only

- 2 If the child restraint has a top tether strap, follow the child restraint manufacturer's operation manual regarding the installation, using the top tether strap to latch onto the top tether strap anchor. (→P.73)
- 3 After installing the child restraint system, rock it back and forth to ensure that it is installed securely. (→P.70)

#### ■ Laws and regulations pertaining to anchorages

The LATCH system conforms to FMVSS225 or CMVSS210.2.

Child restraint systems conforming to FMVSS213 or CMVSS213 specifications can be used.

This vehicle is designed to conform to the SAE J1819.



**⚠ WARNING**

**■ When installing a child restraint system**

Observe the following precautions. Failure to do so may result in death or serious injury.

- When using the LATCH anchors, be sure that there are no foreign objects around the anchors and that the seat belt is not caught behind the child restraint system.
- Follow all installation instructions provided by the child restraint system manufacturer.
- If the seat is adjusted, reconfirm the security of the child restraint system.

**Using an anchor bracket (for top tether strap)**

**■ Anchor brackets (for top tether strap)**

Anchor brackets are provided for the each rear seat.

Use anchor brackets when fixing the top tether strap.

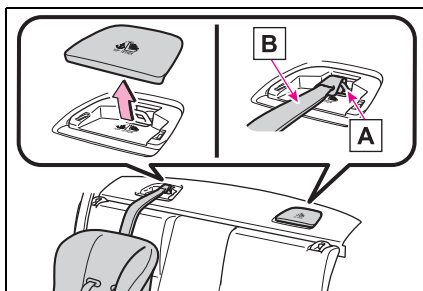

- A** Anchor brackets
- B** Top tether strap

**■ Fixing the top tether strap to the anchor bracket**

Install the child restraint system in accordance to the operation manual enclosed with the child restraint system.

Open the anchor bracket cover, latch the hook onto the anchor bracket and tighten the top tether strap.

Make sure the top tether strap is securely latched. (→P.70)

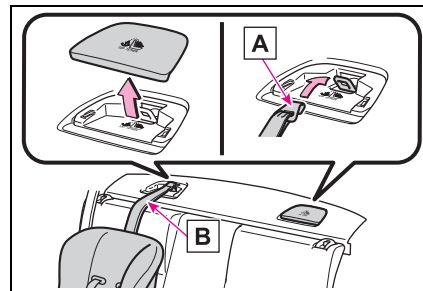

- A** Hook
- B** Top tether strap

**■ Laws and regulations pertaining to anchorages**

The LATCH system conforms to FMVSS225 or CMVSS210.2. Child restraint systems conforming to FMVSS213 or CMVSS213 specifications can be used. This vehicle is designed to conform to the SAE J1819.

**■ When using an anchor bracket (for top tether strap)**

Store the removed cover in a safe place.

Also, after removing a child restraint system, make sure to install the removed cover to its original position.

**WARNING****■ When installing a child restraint system**

Observe the following precautions.

Failure to do so may result in death or serious injury.

- Firmly attach the top tether strap and make sure that the belt is not twisted.
- Do not attach the top tether strap to anything other than the anchor bracket.
- Follow all installation instructions provided by the child restraint system manufacturer.
- If the seat is adjusted, reconfirm the security of the child restraint system.

## Safety Connect\*

\*: If equipped

**Safety Connect is a subscription-based telematics service that uses Global Positioning System (GPS) data and embedded cellular technology to provide safety and security features to subscribers. Safety Connect is supported by Toyota's designated response center, which operates 24 hours per day, 7 days per week.**

**Safety Connect service is available by subscription on select, telematics hardware-equipped vehicles.**

**By using the Safety Connect service, you are agreeing to be bound by the Telematics Subscription Service Agreement and its Terms and Conditions, as in effect and amended from time to time, a current copy of which is available at [Toyota.com](http://Toyota.com) in the United States and [Toyota.ca](http://Toyota.ca) in Canada. All use of the Safety Connect service is subject to such then-applicable Terms and Conditions.**

## System components

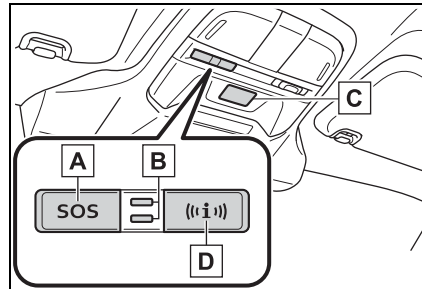

- A** "SOS" button
- B** LED light indicators
- C** Microphone
- D** "i" button

### ■ Multimedia system screen

As with the "i" button, the "Roadside Assist" icon displayed on the home screen of the multimedia system can be used to operate Enhanced Roadside Assistance.

## Services

Subscribers have the following Safety Connect services available:

- Automatic Collision Notification\*

Helps drivers receive necessary response from emergency service providers. (→P.77)

\*: U.S. Patent No. 7,508,298 B2

- Stolen Vehicle Location

Helps drivers in the event of vehicle theft. (→P.77)

- Emergency Assistance Button ("SOS" button)

Connects drivers to response-center support. (→P.77)

- Enhanced Roadside Assistance (“i” button)

Provides drivers various on-road assistance. (→P.78)

### Subscription

After you have signed the Telematics Subscription Service Agreement and are enrolled, you can begin receiving services.

A variety of subscription terms are available for purchase. Contact your Toyota dealer, call the following appropriate Customer Experience Center or push the “SOS” button in your vehicle for further subscription details.

- The United States

1-800-331-4331

- Canada

1-888-869-6828

### ■ Safety Connect Services Information

- Phone calls using the vehicle’s Bluetooth® technology will not be possible when Safety Connect is active and in use.
- Safety Connect is available beginning Fall 2009 on select Toyota models (in the contiguous United States only). Contact with the Safety Connect response center is dependent upon the telematics device being in operative condition, cellular connection availability, and GPS satellite signal reception, which can limit the abil-

ity to reach the response center or receive emergency service support. Enrollment and Telematics Subscription Service Agreement are required. A variety of subscription terms are available; charges vary by subscription term selected and location.

- Automatic Collision Notification, Emergency Assistance and Stolen Vehicle Location are available in the United States, including Hawaii and Alaska, and Canada, and Enhanced Roadside Assistance are available in the United States and Canada.
- Automatic Collision Notification, Emergency Assistance, Stolen Vehicle and Enhanced Road Assistance are not available in the U.S. Virgin Islands. For vehicles first sold in the U.S. Virgin Islands, no Safety Connect services will function in or outside the U.S. Virgin Islands.
- Safety Connect services are not subject to section 255 of the Telecommunications Act and the device is not TTY compatible.

### ■ Languages

The Safety Connect response center will offer support in multiple languages. The Safety Connect system will offer voice prompts in English and French. Please indicate your language of choice when enrolling.

### ■ When contacting the response center

You may be unable to contact the response center if the network is busy.

### Safety Connect LED light Indicators

When the engine switch is turned to “ON”, the red indicator light and green indicator light will

illuminate and then turn off. Then, the green indicator light will illuminate to indicate that the service is active.

The following indicator light patterns indicate specific system usage conditions:

- Green indicator light on = Active service
- Green indicator light flashing = Safety Connect call in process
- Red indicator light on (except at vehicle start-up) = System malfunction (contact your Toyota dealer)
- No indicator light (off) = Safety Connect service not active

### Safety Connect services

#### ■ Automatic Collision Notification

In case of either airbag deployment or severe rear-end collision, the system is designed to automatically call the response center. The responding agent receives the vehicle's location and attempts to speak with the vehicle occupants to assess the level of emergency. If the occupants are unable to communicate, the agent automatically treats the call as an emergency, contacts the nearest emergency services provider to

describe the situation, and requests that assistance be sent to the location.

#### ■ Stolen Vehicle Location

If your vehicle is stolen, Safety Connect can work with local authorities to assist them in locating and recovering the vehicle. After filing a police report, call the Customer Experience Center at 1-800-331-4331 in the United States or 1-888-869-6828 in Canada, and follow the prompts for Safety Connect to initiate this service.

In addition to assisting law enforcement with recovery of a stolen vehicle, Safety-Connect-equipped vehicle location data may, under certain circumstances, be shared with third parties to locate your vehicle. Further information is available at Toyota.com in the United States and Toyota.ca in Canada.

#### ■ Emergency Assistance Button ("SOS" button)

In the event of an emergency on the road, push the "SOS" button to reach the Safety Connect response center. The answering agent will determine your vehicle's location, assess the emergency, and dispatch the necessary assistance required.

If the "SOS" button is pressed unintentionally, press and hold the "SOS" button for approximately 2 seconds or more or operate the

connection screen on the multimedia system screen to cancel the connection to a response-center agent.

#### ■ **Enhanced Roadside Assistance (“i” button)**

Enhanced Roadside Assistance adds GPS data to the already included warranty-based Toyota roadside service.

Subscribers can press the “i” button on the interior lights to contact a Roadside Assistance provider, who can help with a wide range of needs, such as: towing, flat tire, fuel delivery, etc. For a description of the Enhanced Roadside Assistance services and their limitations, please see the Safety Connect Terms and Conditions, which are available at Toyota.com in the United States and Toyota.ca in Canada.

If the “i” button on the interior lights is pressed unintentionally, press and hold the “i” button for approximately 2 seconds or more or operate the connection screen on the multimedia system screen to cancel the connection to a roadside assistance provider.

#### **Safety information for Safety Connect**

Important! Read this information before using Safety Con-

nect.

#### ■ **Exposure to radio frequency signals**

The Safety Connect system installed in your vehicle is a low-power radio transmitter and receiver. It receives and also sends out radio frequency (RF) signals.

In August 1996, the Federal Communications Commission (FCC) adopted RF exposure guidelines with safety levels for mobile wireless phones. Those guidelines are consistent with the safety standards previously set by the following U.S. and international standards bodies.

- ANSI (American National Standards Institute) C95.1 [1992]
- NCRP (National Council on Radiation Protection and Measurement) Report 86 [1986]
- ICNIRP (International Commission on Non-Ionizing Radiation Protection) [1996]

Those standards were based on comprehensive and periodic evaluations of the relevant scientific literature. Over 120 scientists, engineers, and physicians from universities, and government health agencies and industries reviewed the available body of research to develop the ANSI Standard

(C95.1).

The design of Safety Connect complies with the FCC guidelines in addition to those standards.

### Engine immobilizer system

The vehicle's keys have built-in transponder chips that prevent the engine from starting if a key has not been previously registered in the vehicle's on-board computer.

Never leave the keys inside the vehicle when you leave the vehicle.

This system is designed to help prevent vehicle theft but does not guarantee absolute security against all vehicle thefts.

### Operating the system

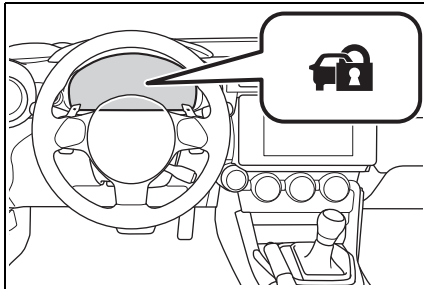

The indicator light flashes after the engine switch has been turned off to indicate that the system is operating.

The indicator light stops flashing after the engine switch has been turned to ACC or ON to indicate that the system has been canceled.

### System maintenance

The vehicle has a maintenance-free type engine immobilizer system.

### Conditions that may cause the system to malfunction

- If the grip portion of the key is in contact with a metallic object
- If the key is in close proximity to or touching a key registered to the security system (key with a built-in transponder chip) of another vehicle



### NOTICE

#### To ensure the system operates correctly

Do not modify or remove the system. If modified or removed, the proper operation of the system cannot be guaranteed.



## Alarm

**The alarm's default setting is set to off. To use the alarm, perform the activating the alarm system procedures.**

**The alarm uses light and sound to give an alert when an intrusion is detected. The alarm is triggered in the following situations when the alarm is set:**

- A locked door or trunk is unlocked or opened in any way other than using the entry function or wireless remote control.
- The hood is opened.

### Setting/canceling/stopping the alarm system

#### ■ Items to check before locking the vehicle

To prevent unexpected triggering of the alarm and vehicle theft, make sure of the following:

- Nobody is in the vehicle.
- The windows are closed before the alarm is set.
- No valuables or other personal items are left in the vehicle.

#### ■ Setting

Close the doors, trunk and

hood, and lock both side doors using the entry function or wireless remote control. The system will set automatically after 30 seconds.

The indicator light changes from being on to flashing when the system is set.

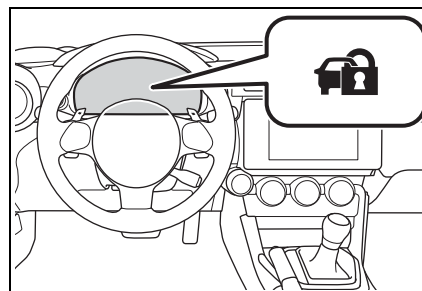



#### ■ Canceling or stopping

Do one of the following to deactivate or stop the alarms:

- Unlock the doors or open the trunk using the entry function or wireless remote control.
- Turn the engine switch to ACC or ON, or start the engine.

### Activating/deactivating the alarm system

- 1 Check that both side doors and the trunk are closed.
- 2 Turn the engine switch to ON.
- 3 Open the driver's door while pressing and holding  on the door lock switch and continue to press  for approxi-

mately 10 seconds after the driver's door has opened.

The alarm system changes between activated and deactivated as follows.

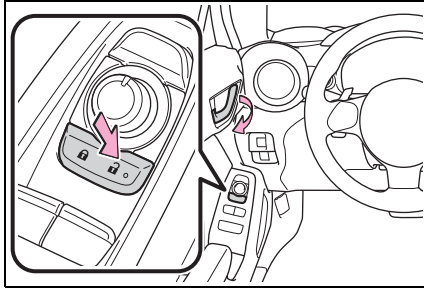

Alarm status	Horn	Multi-information display
Deactivated	Sounds twice	"AL OFF"
Activated	Sounds once	"AL ON"

■ System maintenance

The vehicle has a maintenance-free type alarm system.

■ Opening and closing the trunk

- If the alarm setting operations are performed with the trunk left open, the alarm will not be set. After closing the trunk, the alarm is set after 30 seconds or more elapse.
- When the trunk is unlocked using the entry function or wireless remote control while the alarm is set, the alarm goes into standby mode. After closing the trunk, the alarm is set again after 30 seconds or more elapse.

■ Triggering of the alarm

The alarm may be triggered in the following situations:  
(Stopping the alarm deactivates the alarm system.)

- The doors are unlocked using the key or the mechanical key.

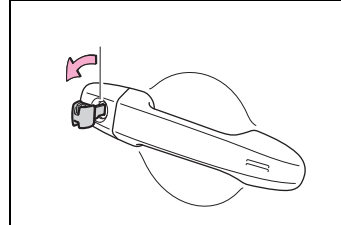

- A person inside the vehicle opens a door, the trunk or hood, or unlocks the vehicle using an inside lock button.



- The battery is recharged or replaced when the vehicle is locked. (→P.373)

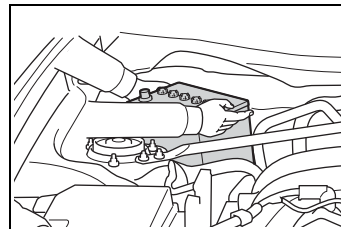

⚠ NOTICE

■ To ensure the system operates correctly

Do not modify or remove the system. If modified or removed, the proper operation of the system cannot be guaranteed.

**Vehicle status information  
and indicators**

**2**

83

**2-1. Instrument cluster**

- Warning lights and indicators ..... 84
- Gauges and meters ..... 88
- Multi-information display  
..... 93

**2**

Vehicle status information and indicators

Warning lights and indicators

The warning lights and indicators on the instrument cluster and overhead console inform the driver of the status of the vehicle's various systems.



Warning lights and indicators displayed on the instrument cluster

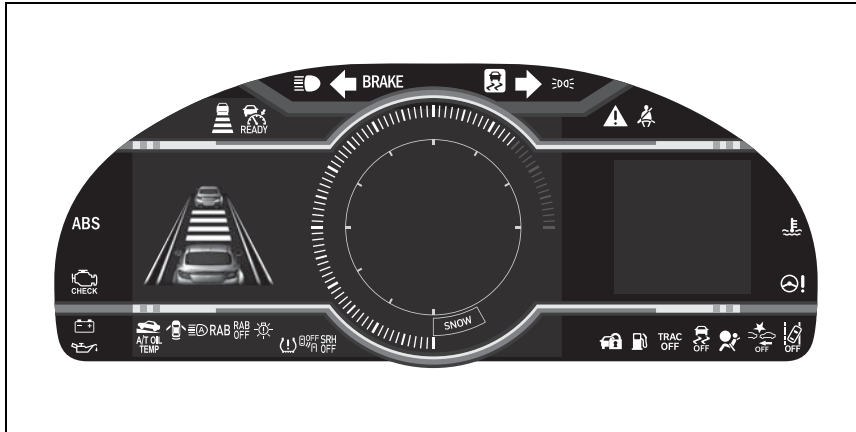





For the purpose of explanation, the following illustrations display all warning lights and indicators illuminated.



















Warning lights

Warning lights inform the driver of malfunctions in the indicated vehicle systems.

-  Brake system warning light\*<sup>1</sup> (→P.348) (U.S.A.)
-  Brake system warning light\*<sup>1</sup> (→P.348) (Canada)
-  High coolant temperature warning light\*<sup>1</sup> (→P.348) (red)

-  Charging system warning light\*<sup>1</sup> (→P.348)
-  Low engine oil pressure warning light\*<sup>1</sup> (→P.349)
-  Malfunction indicator lamp\*<sup>1</sup> (→P.349) (U.S.A.)
-  Malfunction indicator lamp\*<sup>1</sup> (→P.349) (Canada)
-  SRS warning light\*<sup>1</sup> (→P.54, 349)
-  ABS warning light\*<sup>1</sup> (→P.349) (U.S.A.)

	ABS warning light* <sup>1</sup> (→P.349)
(Canada)	
	Electric power steering system warning light* <sup>1</sup> (→P.350)
	Slip indicator* <sup>1</sup> (→P.350)
	Automatic transmission fluid temperature warning light (if equipped) (→P.350)
	Open door warning light (→P.351)
	Low fuel level warning light* <sup>1</sup> (→P.351)
	Driver's and front passen- ger's seat belt reminder light* <sup>1, 2</sup> (→P.351)
	Rear passengers' seat belt reminder lights* <sup>1, 3</sup> (→P.352)
	Conventional Cruise Con- trol indicator (if equipped) (yellow) (→P.352)
	BSD/RCTA warning light (if equipped) (→P.352)
	SRH warning light (if equipped) (→P.352)
	RAB warning light (if equipped) (→P.353)
	LED headlight warning light (→P.353)
	Automatic headlight level- ing system warning light (→P.353)
	Master warning light* <sup>1</sup> (→P.353)

	EyeSight warning light (if equipped) (→P.353)
	Tire pressure warning light* <sup>1</sup> (→P.354)

\*<sup>1</sup>: These lights turn on when the engine switch is turned to ON to indicate that a system check is being performed. They will turn off after the engine is started, or after a few seconds. There may be a malfunction in a system if a light does not come on, or turn off. Have the vehicle inspected by your Toyota dealer.

\*<sup>2</sup>: The front passenger's seat belt reminder light is located on the overhead console.

\*<sup>3</sup>: This light illuminates on the overhead console.



#### WARNING



























##### **■ If a safety system warning light does not come on**

Should a safety system light such as the ABS and SRS warning light not come on when you start the engine, this could mean that these systems are not available to help protect you in an accident, which could result in death or serious injury. Have the vehicle inspected by your Toyota dealer immediately if this occurs.

#### Indicators

The indicators inform the driver of the operating state of the vehicle's various systems.

	Turn signal indicator (→P.155)
	Tail light indicator (→P.158)

	Headlight high beam indicator (→P.160)		SRH OFF indicator* <sup>2</sup> (if equipped) (→P.161)
	High beam assist indicator (if equipped) (→P.162)		RAB OFF indicator* <sup>1, 2</sup> (if equipped) (→P.247)
	EyeSight temporary stop indicator (if equipped) (→P.229)		Slip indicator* <sup>1</sup> (→P.262)
	Pre-Collision Braking System OFF indicator* <sup>1, 2</sup> (if equipped) (→P.189)		VSC OFF indicator* <sup>1, 2</sup> (→P.263)
	Conventional Cruise Control indicator (if equipped) (→P.208, 255)		TRAC OFF indicator* <sup>1, 2</sup> (→P.262)
(white/green)			Smart key system indicator* <sup>3</sup> (→P.145)
)			Hill-start assist control ON indicator (→P.259)
	Adaptive Cruise Control indicator (if equipped) (→P.196)		Security indicator (→P.80, 81)
(white/green)			Low coolant temperature indicator* <sup>4</sup>
)		(blue)	
	“READY” indicator (if equipped) (→P.196)		Upshift/downshift indicator (vehicles with an automatic transmission) (→P.151)
	Lead vehicle indicator (if equipped) (→P.196)		Shift-up indicator (vehicles with a manual transmission) (→P.155)
	Lead vehicle indicator* <sup>3</sup> (if equipped) (→P.196)		Passenger's frontal airbag ON and OFF indicator* <sup>1, 5</sup> (→P.29)
	Your vehicle indicator (if equipped) (→P.196)		Low outside temperature indicator* <sup>6</sup> (→P.88)
	Following distance setting indicator (if equipped) (→P.196)		
	Following distance setting indicator* <sup>3</sup> (if equipped) (→P.196)		
	Lane Departure Warning OFF indicator* <sup>1, 2</sup> (if equipped) (→P.221)		
	BSD/RCTA OFF indicator* <sup>2</sup> (if equipped) (→P.236)		

● Drive mode indicators

► Normal mode

 Snow mode indicator (if equipped) (→P.258)

 "SPORT" indicator (if equipped) (→P.258)

► TRACK mode

 Snow mode indicator (if equipped) (→P.258)

 "SPORT" indicator (if equipped) (→P.258)

 "TRACK" indicator (→P.263)

\*1: These lights turn on when the engine switch is turned to ON to indicate that a system check is being performed. They will turn off after the engine is started, or after a few seconds. There may be a malfunction in a system if a light does not come on, or turn off. Have the vehicle inspected by your Toyota dealer.

\*2: The light comes on when the system is turned off.

\*3: This light illuminates on the multi-information display.

\*4: This indicator turns on when the engine coolant temperature is low.

\*5: This light illuminates on the overhead console.

\*6: When the outside temperature is approximately 37°F (3°C) or lower, this indicator will illuminate.

## Gauges and meters

## Meter display

## ■ Locations of gauges and meters

## ► Normal mode

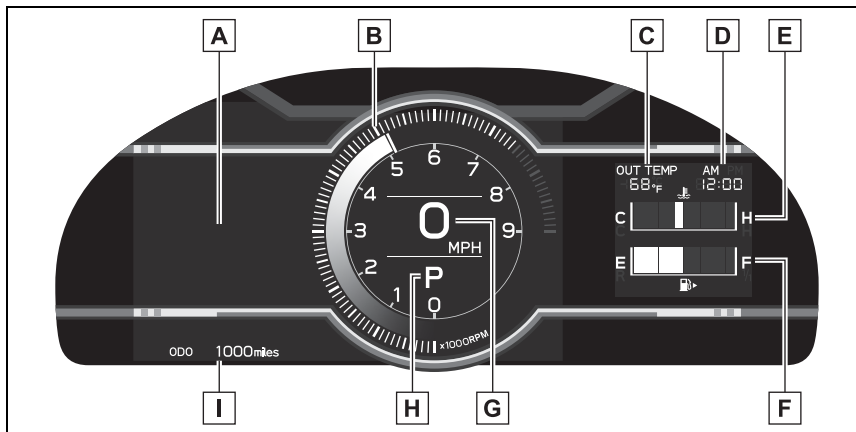
**A** Multi-information display

Presents the driver with a variety of vehicle data (→P.93)

Displays warning messages in case of a malfunction (→P.357)

**B** Tachometer

Displays the engine speed in revolutions per minute

The red zone will be lower than normal, when the engine is cold

**C** Outside temperature

Displays the outside temperature within the range of -40°F (-40°C) to 122°F (50°C). Low outside temperature indicator comes on when the ambient temperature is 37°F (3°C) or lower.

**D** Clock**E** Engine coolant temperature gauge

Displays the engine coolant temperature

**F** Fuel gauge**G** Speedometer**H** Shift position and gear position (→P.149, 154)**I** Odometer and trip meter display (→P.90)

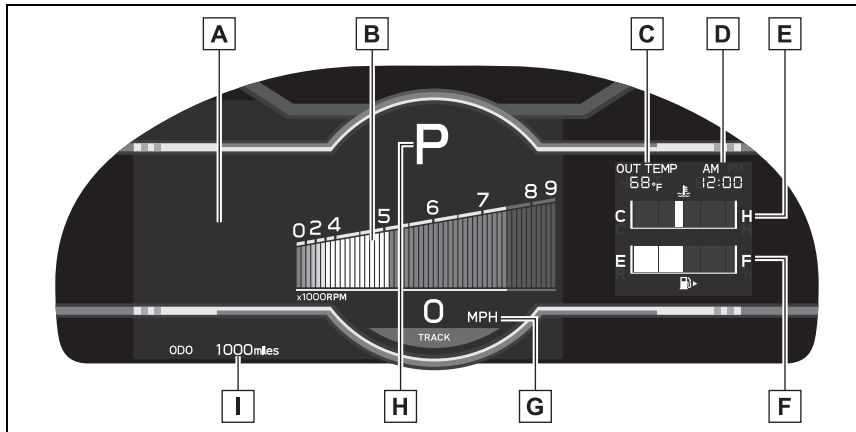

## ▶ TRACK mode

**A** Multi-information display

Presents the driver with a variety of vehicle data (→P.93)

Displays warning messages in case of a malfunction (→P.357)

**B** Tachometer

Displays the engine speed in revolutions per minute

The red zone will be lower than normal, when the engine is cold

**C** Outside temperature

Displays the outside temperature within the range of  $-40^{\circ}\text{F}$  ( $-40^{\circ}\text{C}$ ) to  $122^{\circ}\text{F}$  ( $50^{\circ}\text{C}$ ). Low outside temperature indicator comes on when the ambient temperature is  $37^{\circ}\text{F}$  ( $3^{\circ}\text{C}$ ) or lower.

**D** Clock**E** Engine coolant temperature gauge

Displays the engine coolant temperature

**F** Fuel gauge**G** Speedometer**H** Shift position and gear position (→P.149, 154)**I** Odometer and trip meter display (→P.90)■ **REV indicator**

When the engine speed reaches a set speed, the shift position and shift range indicator will illuminate in orange and a buzzer will sound. If the engine speed

enters the red zone, the shift position and shift range indicator will illuminate in red.

The default setting for the REV indicator is disabled. The setting can be enabled/disabled on  of the

multi-information display. (→P.400)

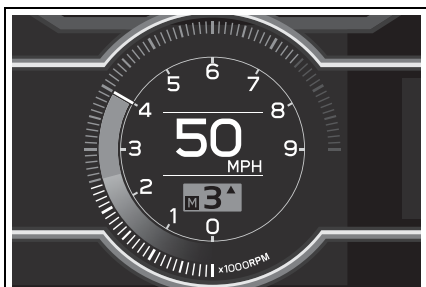

The engine speed at which the REV indicator is displayed can be changed on  of the multi-information display. (→P.400)

■ **Outside temperature display**

- In the following situations, the correct outside temperature may not be displayed, or the display may take longer than normal to change:
  - When stopped, or driving at low speeds (less than 12 mph [20 km/h])
  - When the outside temperature has changed suddenly (at the entrance/exit of a garage, tunnel, etc.)
- When “--” is displayed, the system may be malfunctioning. Take your vehicle to your Toyota dealer.

■ **Liquid crystal display**

→P.94

■ **Customization**

The meter display can be customized on the multi-information display. (→P.400)

 **WARNING**

■ **The information display at low temperatures**

Allow the interior of the vehicle to warm up before using the liquid crystal information display. At extremely low temperatures, the information display monitor may respond slowly, and display changes may be delayed.

For example, there is a lag between the driver’s shifting and the new gear number appearing on the display. This lag could cause the driver to downshift again, causing rapid and excessive engine braking and possibly an accident resulting in death or injury.

 **NOTICE**

■ **To prevent damage to the engine and its components**

- Do not let the indicator needle of the tachometer enter the red zone, which indicates the maximum engine speed.
- Pay extra attention to the engine speed when the engine is cold, as the red zone will be lower than normal.
- If the engine coolant temperature gauge indicator is flashing, the engine may be overheating. Immediately stop the vehicle in a safe place, and check the engine after it has cooled completely. (→P.375)

**Odometer and trip meter display**

■ **Changing the display**

Press the display change button until the desired item is dis-

played.

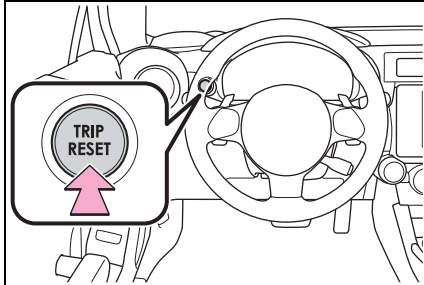

### ■ Display items

#### ● Odometer

Displays the total distance the vehicle has been driven.

#### ● Trip meter A/Trip meter B

Displays the distance the vehicle has been driven since the meter was last reset. Trip meters A and B can be used to record and display different distances independently.

To reset, display the desired trip meter and press and hold the display change button.

### Changing the instrument panel light brightness

When the headlights or front position lights are on, the brightness of the meter and instrument panel lights can be adjusted using the instrument panel brightness dial.

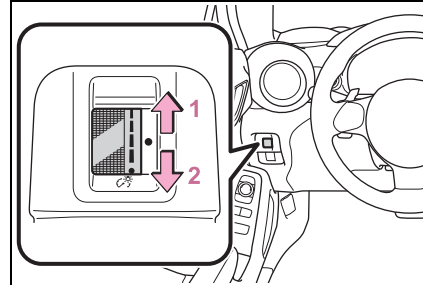

- 1 Brighter
- 2 Darker

### ■ Instrument panel light brightness adjustment

When the headlights or front position lights are turned on, the meter and instrument panel lights will be dimmed. However, if the instrument panel brightness dial is set to the highest position, the lights will not dim even if the headlights or front position are turned on.

### ■ Auto dimmer cancel

When the surrounding area is bright, such as during the day, or if the lights are turned on before necessary, the automatic dimming function will be cancelled. In this case, the brightness cannot be adjusted, even if the instrument panel brightness dial is turned.

### ■ Customization

Some functions can be customized. (→P.400)

### Adjusting the clock

The clocks can be adjusted on the multimedia system screen.



### ■ Setting the clock to be adjusted automatically (vehicles with safety connect)

- 1 Press .

- 2 Select .
- 3 Select "General".
- 4 Select "Clock".
- 5 Select "Time Setting".
- 6 Select "AUTO".



The clock will be set automatically where a GPS signal is available.

■ **Setting the clock to be adjusted automatically (vehicles without safety connect)**

- 1 Press .
- 2 Select .
- 3 Select "General".
- 4 Select "Clock".
- 5 Select "Time Setting".
- 6 Select "Sync With Phone".



The clock will be set and adjusted automatically when a smartphone is connected via Bluetooth® for transferring phonebook data. For details, refer to the "MULTIMEDIA OWNER'S MANUAL".

■ **Adjusting the clock manually**

- 1 Press .
- 2 Select .
- 3 Select "General".
- 4 Select "Clock".
- 5 Select "Time Setting".

- 6 Select "Manual" then adjust the clock.
- 7 Select "OK".

■ **Changing the clock between 12H/24H format**

- 1 Press .
- 2 Select .
- 3 Select "General".
- 4 Select "Clock".
- 5 Select "12H" or "24H".

---

■ **Clock settings screen**

The clock setting screen can also be displayed by touching the clock on the status bar.

Multi-information display

The multi-information display presents the driver with a variety of vehicle data.

Displays and menu icons

■ Display

► Normal display

By selecting menu icons on the multi-information display, a variety of driving-related information can be displayed. The multi-information display can also be used to change display settings and other vehicle settings.

Warning or advice pop-up displays are also displayed in certain situations.

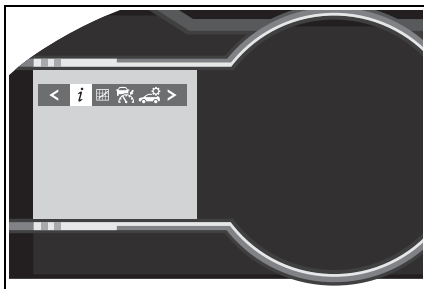

► TRACK mode display

Vehicles without EyeSight:  
When in TRACK mode, the TRACK mode display will remain displayed.

Vehicles with EyeSight:  
When in TRACK mode, if the

Pre-Collision Braking System is turned off, the TRACK mode display will be displayed. (→P.189)

Warning or advice pop-up displays are also displayed in certain situations.

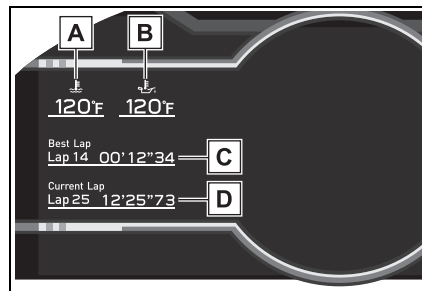

**A** Engine coolant temperature (→P.88)

**B** Engine oil temperature  
Displays the engine oil temperature.

**C** Fastest lap time  
Refer to P.97 for the operating method.

**D** Current lap time  
Refer to P.97 for the operating method.

■ Menu icons





Select a menu icon to display its content.

 Driving information (→P.94)

 Sport information (→P.96)

 Navigation system-linked display\* (→P.98)

 Audio system-linked display (→P.98)

-  Driving support system information display (if equipped) (→P.98)
-  Driving support system setting display (→P.98)
-  Settings display (→P.98)
-  Warning message display (→P.357)

\*: Displayed when the navigation system of Apple CarPlay or Android Auto is operating. For details, refer to the “MULTIMEDIA OWNER’S MANUAL”.

■ **Liquid crystal display**

Small spots or light spots may appear on the display. This phenomenon is characteristic of liquid crystal displays, and there is no problem continuing to use the display.

 **WARNING**

■ **The multi-information display at low temperatures**

Allow the interior of the vehicle to warm up before using the liquid crystal information display. At extremely low temperatures, the information display monitor may respond slowly, and display changes may be delayed.

For example, there is a lag between the driver’s shifting and the new gear number appearing on the display. This lag could cause the driver to downshift again, causing rapid and excessive engine braking and possibly an accident resulting in death or injury.

**Changing the meter display**

The multi-information display is

operated using the meter control switches.

For information pertaining to the content of each menu icon, refer to the explanation of each item under the heading of the relevant menu icon.

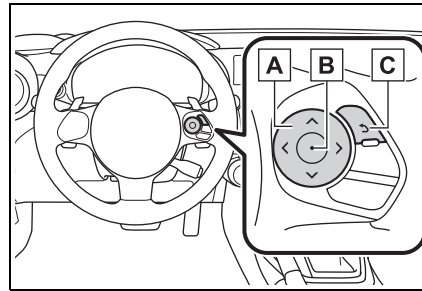

- A** < / > : Select menu icons  
 ^ / v : Change displayed content, scroll up/down the screen and move the cursor
- B** Press: Enter  
 Press and hold: Reset/change scale of the G-force display
- C** Return to the previous screen

**Content of driving information**

■ **Display items**

Press < or > of the meter control switch and select .

Then press ^ or v to display the following items:

- Driving information (page 1)
- Driving information (page 2)
- Driving information (page 3)

- Driving information (page 4)
  - **Driving information (page 1)**
- Use the display as a reference.

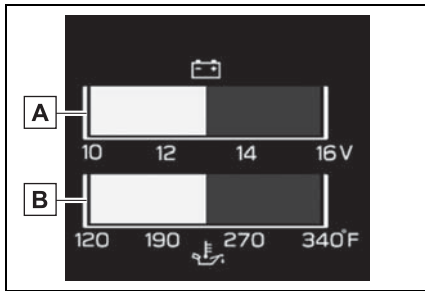

- A** Voltmeter
- Displays the charging voltage. As voltage displayed may be different from the actual battery voltage, use the voltmeter as a guideline.

- B** Engine oil temperature gauge
- Displays the engine oil temperature.

- **Driving information (page 2)**
- Use the display as a reference.

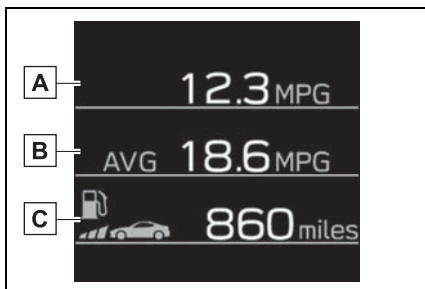

- A** Current fuel consumption
- Displays the current rate of fuel consumption.
- B** Average fuel consumption
- Displays the average fuel consumption since the function was reset.

- C** Driving range
- Displays the estimated maximum distance that can be driven with the quantity of fuel remaining.

This distance is computed based on your average fuel consumption. As a result, the actual distance that can be driven may differ from that displayed.

When only a small amount of fuel is added to the tank, the display may not be updated. When refueling, turn the engine switch off. If the vehicle is refueled without turning the engine switch off, the display may not be updated.

- **Driving information (page 3)**
- Use the display as a reference.

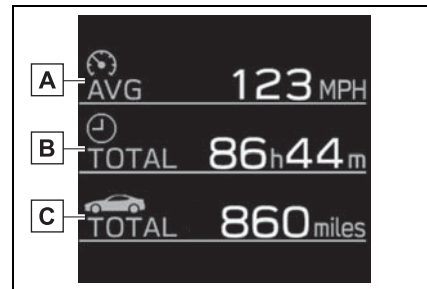

- A** Average vehicle speed
- Displays the average vehicle speed since display was reset.

- B** Driving time
- Displays the cumulative time the vehicle has been driven since display was reset.

- C** Driving distance
- Displays the cumulative distance the vehicle has been driven since display was reset.

Pressing and holding  will reset the average vehicle

speed/driving time/driving distance.

#### ■ Driving information (page 4)

Displays each tire pressure.  
(→P.315)

### Sport information

#### ■ Display items

Press  $\leftarrow$  or  $\rightarrow$  of the meter control switch and select . Then press  $\wedge$  or  $\vee$  to display the following items:

##### ● G-force

Suitable for confirming current lateral G-forces on the vehicle.

##### ● G-force (peak hold function)

Suitable for confirming the size and direction of the maximum lateral G-forces on the vehicle.

##### ● Power and torque curve

##### ● Stopwatch

#### ■ G-force

Displays lateral G-forces on the vehicle.

Also displays, around the periphery of the G-force display, the left and right steering amount, accelerator pedal input, and brake fluid pressure.

This display is intended for use as a guideline. Depending on factors such as the road surface condition, temperature and vehicle speed, the display may not show the actual condition of the

vehicle.

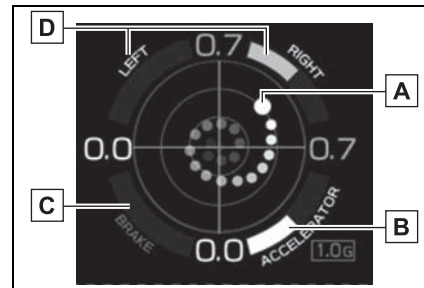

- A** Acceleration G-force on the vehicle
- B** Accelerator pedal input
- C** Brake fluid pressure
- D** Steering amount

Press and hold  to change the range of the acceleration G-force display between 1.0 G and 0.5 G.

#### ■ G-force (peak hold function)

Displays lateral G-forces on the vehicle.

Also displays, around the periphery of the G-force display, the left and right steering amount, accelerator pedal input, and brake fluid pressure.

This display is intended for use as a guideline. Depending on factors such as the road surface condition, temperature and vehicle speed, the display may not show the actual condition of the vehicle.



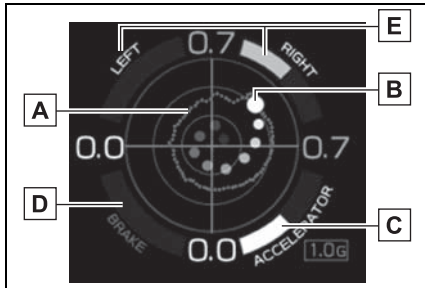

**A** Record of the maximum G-forces

Press and hold to reset the record of maximum G-forces.

**B** Acceleration G-force on the vehicle

**C** Accelerator pedal input

**D** Brake fluid pressure

**E** Steering amount

■ **Power and torque curve**

This chart is intended for reference only and does not show the actual engine torque or output.

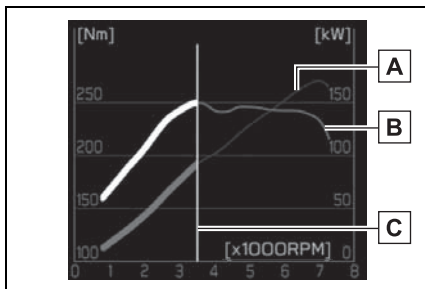

**A** Power output

**B** Torque

**C** Current engine speed

The vertical bar will slide laterally according to the current engine speed.

■ **Stopwatch**

Measures and displays current lap time and previous lap times.

► Top screen



**A** Fastest lap time (top screen)

When the timer is reset, “- - - - -” will be displayed.

► Measurement screen

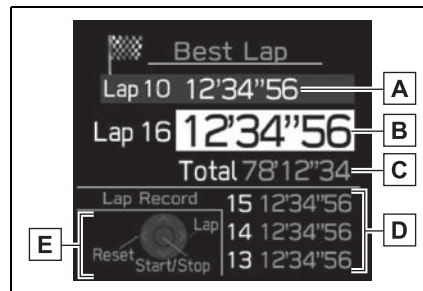

**A** Fastest lap time (measurement screen)

**B** Current lap time

**C** Total lap time

**D** Past lap times

Records of the 50 most recent lap times will be displayed.

**E** Meter control switch operation guide

● Changing between the stopwatch screens

To change to the measurement

screen: Press .

To change to the top screen: Press



.

- Operating the measurement screen

 : Start/stop measurement

 : Mark off one lap

 : Reset measured lap times

  : Scroll through the lap times

- Resetting measured lap times

After stopping the measurement, press .

- To display other content while the stopwatch is operating

If the measurement screen is displayed, press  to display the top screen.

Then operate the meter control switches to display other content. While other items are displayed, the measurement will continue but the stopwatch cannot be operated.

### Navigation system-linked display

Select to display the route guidance information.

### Audio system-linked display

Select to enable selection of an audio source or track on the display using the meter control

switches.

### Driving support system information display (if equipped)

Select to display the operational status of the Adaptive Cruise Control system (→P.190, 207)

### Driving support system setting display

The settings of the following systems can be changed.

- LDW (Lane Departure Warning) (if equipped)
- PCB (Pre-Collision Braking) (if equipped)
- BSD/RCTA (if equipped)
- RAB (Reverse Automatic Braking system) (if equipped)
-  (Sonar Audible Alarm) (if equipped)
- SRH (Steering Responsive Headlight) (if equipped)

### Settings display

#### ■ Meter display settings that can be changed

- Units

Select to change the units of measure displayed.

- Startup Scrn

Select to enable/disable the startup screen when the engine switch is turned to ON.

- GSI (if equipped)

Select to enable/disable the shift position indicator and shift-up indicator.

- REV. (REV indicator)
  - Select to enable/disable the REV indicator.
  - Select to enable/disable the sounding of a buzzer when the REV indicator is illuminated.
  - Select to set the engine speed at which the REV indicator (orange) will begin to be displayed.

#### ■ Vehicle functions and settings that can be changed

→P.400

#### ■ Suspension of the settings display

- Some settings cannot be changed while driving. When changing settings, park the vehicle in a safe place.
- If a warning message is displayed, operation of the settings display will be suspended.



#### NOTICE

##### ■ While setting up the display

To prevent battery discharge, ensure that the engine is running while setting up the display features.



#### WARNING

##### ■ Cautions during setting up the display

As the engine needs to be running during setting up the display, ensure that the vehicle is parked in a place with adequate ventilation. In a closed area such as a garage, exhaust gases including harmful carbon monoxide (CO) may collect and enter the vehicle. This may lead to death or a serious health hazard.



**Before driving****3****3-1. Key information**

Keys ..... 102

**3-2. Opening, closing and locking the doors and trunk**

Doors ..... 105

Trunk ..... 107

Smart key system ..... 111

**3-3. Adjusting the seats**

Front seats ..... 119

Rear seats ..... 121

Head restraints ..... 123

**3-4. Adjusting the steering wheel and mirrors**

Steering wheel ..... 125

Inside rear view mirror  
..... 126Outside rear view mirrors  
..... 127**3-5. Opening, closing the windows**

Power windows ..... 129

## Keys

### The keys

The following keys are provided with the vehicle.

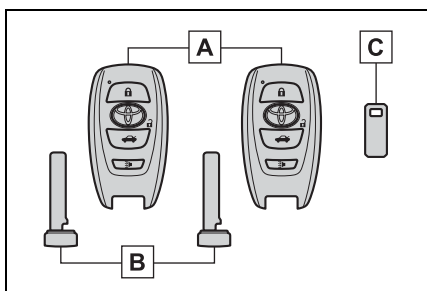

#### A Electronic keys

- Operating the smart key system (→P.111)
- Operating the wireless remote control function (→P.103)

#### B Mechanical keys

#### C Key number plate

### ■ When riding in an aircraft

When bringing an electronic key onto an aircraft, make sure you do not press any buttons on the electronic key while inside the aircraft cabin. If you are carrying an electronic key in your bag etc., ensure that the buttons are not likely to be pressed accidentally. Pressing a button may cause the electronic key to emit radio waves that could interfere with the operation of the aircraft.

### ■ Electronic key battery depletion

- The standard battery life is 1 to 2 years.
- If the battery becomes low, an alarm will sound in the cabin and a message will be shown on the multi-information display when the engine is stopped.

- To reduce key battery depletion when the electronic key is to not be used for long periods of time, set the electronic key to the battery-saving mode. (→P.112)
- As the electronic key always receives radio waves, the battery will become depleted even if the electronic key is not used. The following symptoms indicate that the electronic key battery may be depleted. Replace the battery when necessary. (→P.328)
  - The smart key system or the wireless remote control does not operate.
  - The detection area becomes smaller.
  - The LED indicator on the key surface does not turn on.
- To avoid serious deterioration, do not leave the electronic key within 3 ft. (1 m) of the following electrical appliances that produce a magnetic field:
  - TVs
  - Personal computers
  - Cellular phones, cordless phones and battery chargers
  - Recharging cellular phones or cordless phones
  - Table lamps
  - Induction cookers

### ■ Replacing the battery

→P.328

### ■ Confirmation of the registered key number

The number of keys already registered to the vehicle can be confirmed. Ask your Toyota dealer for details.

### ⚠ NOTICE

#### ■ To prevent key damage

- Do not drop the keys, subject them to strong shocks or bend them.

 **NOTICE**

- Do not expose the keys to high temperatures for long periods of time.
- Do not get the keys wet or wash them in an ultrasonic washer etc.
- Do not attach metallic or magnetic materials to the keys or place the keys close to such materials.
- Do not disassemble the keys.
- Do not attach a sticker or anything else to the surface of the electronic key.
- Do not place the keys near objects that produce magnetic fields, such as TVs, audio systems and induction cookers.

■ **Carrying the electronic key on your person**

Carry the electronic key 3.9 in. (10 cm) or more away from electric appliances that are turned on. Radio waves emitted from electric appliances within 3.9 in. (10 cm) of the electronic key may interfere with the key, causing the key to not function properly.

■ **In case of a smart key system malfunction or other key-related problems**

→P.370

■ **When an electronic key is lost**

→P.369

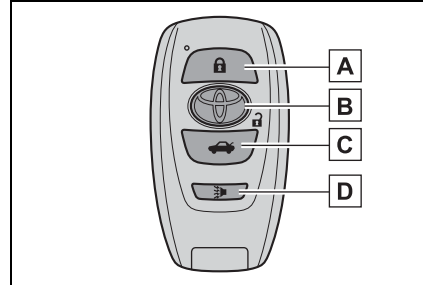

- A** Locks the doors (→P.105)
- B** Unlocks the doors (→P.105)
- C** Opens the trunk (→P.110)
- D** Sounds the alarm

■ **Panic mode**

When  is pressed for longer than about one second, an alarm will sound intermittently and the vehicle lights will flash to deter any person from trying to break into or damage your vehicle.

To stop the alarm, press any button on the electronic key.



■ **Vehicle finder function**

When the function is set, a buzzer (sounds once) and the emergency flashers (flash 3 times) are used to inform the driver of the vehicle's location.

Press  3 times within 5 seconds while within a circumference of approximately 30 ft. (10 m) from of the vehicle.

However, if the interval between the 3 presses is short, the system may not be activated.

**Wireless remote control**

The electronic keys are equipped with the following wireless remote control:

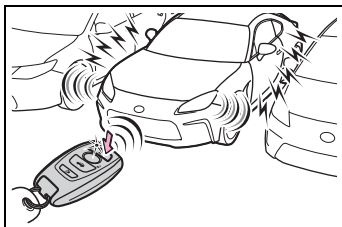

■ **Customization**

Some functions can be customized.  
(→P.400)

**Using the mechanical key**

To take out the mechanical key, push the release button and take the key out.

The mechanical key can only be inserted in one direction, as the key only has grooves on one side. If the key cannot be inserted in a lock cylinder, turn it over and re-attempt to insert it.

After using the mechanical key, store it in the electronic key. Carry the mechanical key together with the electronic key. If the electronic key battery is depleted or the entry function does not operate properly, you will need the mechanical key.  
(→P.370)

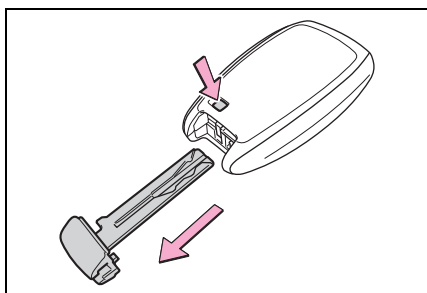

■ **If you lose your mechanical keys**

→P.369



## Doors

## Unlocking and locking the doors from the outside

## ■ Smart key system

Carry the electronic key to enable this function.

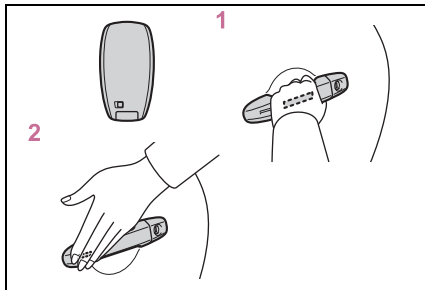

- 1 Grip the driver's door handle to unlock the door. Grip the passenger's door handle to unlock all the doors.\*

Make sure to touch the sensor on the back of the handle.

The doors cannot be unlocked for 3 seconds after the doors are locked.

\*: The door unlock settings can be changed.

- 2 Touch the lock sensor (indentation on the side of the door handle) to lock the doors.

Check that the door is securely locked.

## ■ Wireless remote control

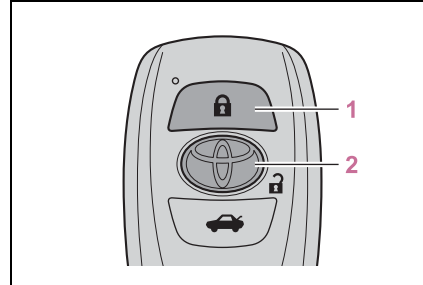

- 1 Locks both side doors

Check that the door is securely locked.

- 2 Unlocks both side doors

Pressing the button unlocks the driver's door. Pressing the button again within 3 seconds unlocks the other door.

## ■ Side window open/close function linked to door operation

In order to make opening and closing the doors easier, completely closed windows are linked to door operations. Therefore, when a door is opened, its window opens slightly. When a door is closed, its window closes completely.

However, if the battery has discharged or is disconnected, this function will not operate. (→P.374)

## ■ Operation signals

A buzzer sounds and the emergency flashers flash to indicate that the doors have been locked/unlocked. (Locked: once; Unlocked: twice)

## ■ When the door cannot be locked by the lock sensor on the surface of the door handle

If the doors cannot be locked by touching the lock sensor with a finger, touch the lock sensor with the palm of your hand.

If you are wearing gloves, remove

3

Before driving

them.

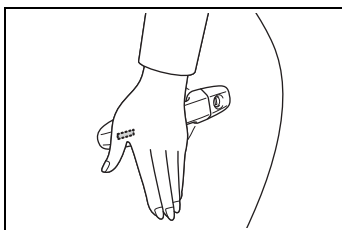

■ **Door lock buzzer**

If an attempt to lock the doors using the entry function or wireless remote control is made when a door is not fully closed, a buzzer will sound continuously for 5 seconds. Fully close the door to stop the buzzer, and lock the doors again.

■ **Alarm**

Locking the doors will set the alarm system. (→P.81)

■ **Conditions affecting the operation of the smart key system or wireless remote control**

→P.112

■ **If the smart key system or the wireless remote control does not operate properly**

Use the mechanical key and/or inside lock buttons to lock and unlock the doors. (→P.370)  
 Replace the key battery with a new one if it is depleted. (→P.328)

■ **If the battery is discharged**

The doors cannot be locked and unlocked using the smart key system or wireless remote control. Lock or unlock the doors using the mechanical key. (→P.370)

■ **Customization**

Some functions can be customized. (→P.400)

**! WARNING**

■ **To prevent an accident**

Ensure that both side doors are properly closed and locked while driving the vehicle. Failure to do so may result in a door opening and an occupant being thrown out of the vehicle, resulting in death or serious injury.

■ **When opening or closing a door**

Check the surroundings of the vehicle such as whether the vehicle is on an incline, whether there is enough space for a door to open and whether a strong wind is blowing. When opening or closing the door, hold the door handle tightly to prepare for any unpredictable movement.

■ **Side window open/close function linked to door operation**

Do not hold the upper edge of the side window when you close the door. Otherwise, your fingers or hand may be caught in the window.

**Unlocking and locking the doors from the inside**

■ **Door lock switches (to lock/unlock)**

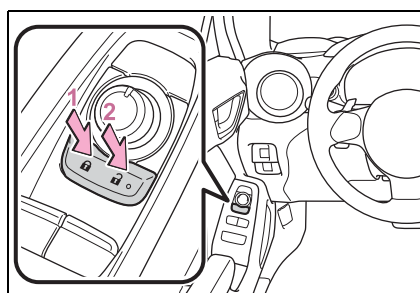

- 1 Locks both side doors
- 2 Unlocks both side doors

### ■ Inside lock buttons (to lock/unlock)

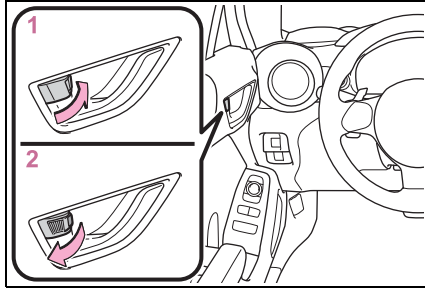

- 1 Locks the door
- 2 Unlocks the door

### ■ Locking the doors from the outside without a key

- 1 Move the inside lock button to the lock position.
- 2 Close the door.

The door cannot be locked if the engine switch is in ACC or ON, or the electronic key is left inside the vehicle. However, the key may not be detected correctly and the door may be locked.

### ■ Door lock prevention function

This function prevents the doors from being locked if an electronic key is left inside the vehicle.

### ■ Customization

Some functions can be customized. (→P.400)

## Trunk

The trunk can be opened using the trunk opener switch, entry function or wireless remote control.

### ⚠ WARNING

Observe the following precautions.

Failure to do so may result in death or serious injury.

### ■ Before driving

- Make sure that the trunk lid is closed before driving. If not fully closed, while driving, it may open unexpectedly, hit near-by objects, or luggage may fall out, possibly leading to an accident. Also, exhaust gasses may enter the vehicle, possibly leading to death or a serious health hazard.

- Do not allow children to play in the trunk. If a child is accidentally locked in the trunk, they could suffer from heat exhaustion, suffocation or other injuries.

- Do not allow a child to open or close the trunk lid. Doing so may cause the trunk lid to open unexpectedly, or cause the child's hands, head, or neck to be caught by the closing trunk lid.

### ■ Important points while driving

Never let anyone sit in the trunk. In the event of sudden braking or a collision, they are susceptible to death or serious injury.

3

Before driving

**⚠ WARNING**

**■ Using the trunk**

Observe the following precautions. Failure to do so may cause parts of the body to be caught, resulting in serious injury.

- Remove any heavy loads, such as snow and ice, from the trunk lid before opening it. Failure to do so may cause the trunk lid to suddenly shut again after it is opened.
- Be careful not to come into contact with the exhaust gasses when opening or closing the trunk. If the engine is running, there is a risk of being burned by the exhaust gasses.
- When opening or closing the trunk lid, thoroughly check to make sure the surrounding area is safe.
- If anyone is in the vicinity, make sure they are safe and let them know that the trunk is about to open or close.
- Use caution when opening or closing the trunk lid in windy weather as it may move abruptly in strong wind.

- The trunk lid may suddenly shut if it is not opened fully. It is more difficult to open or close the trunk lid on an incline than on a level surface, so beware of the trunk lid unexpectedly opening or closing by itself. Make sure that the trunk lid is fully open and secure before using the trunk.

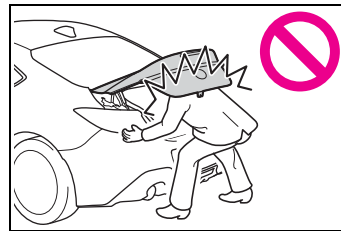

- When closing the trunk lid, take extra care to prevent your fingers etc. from being caught.

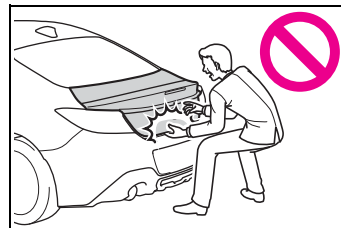



- When closing the trunk lid, make sure to press it lightly on its outer surface.
- Do not attach any accessories other than genuine Toyota parts to the trunk lid. Such additional weight on the trunk lid may cause the lid to suddenly shut again after it is opened.

**■ Trunk lid damper stays**

Do not pull on or disassemble the trunk lid damper stays, or dispose of them in a fire. Illustrations on the trunk lid damper stays indicate the following:

-  : Do not pull

**⚠ WARNING**

-  : Do not disassemble
-  : Do not dispose of in fire

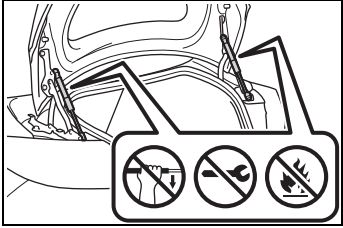

- Do not pull on the trunk damper stay to close the trunk, and do not hang on the trunk damper stay. Doing so may cause hands to be caught or the trunk damper stay to break, causing an accident.

**⚠ NOTICE**

■ **Using the trunk**  
When closing the trunk lid, do not strongly push down on the trunk lid. Doing so may dent the trunk lid.

■ **Trunk damper stays**  
The trunk lid is equipped with damper stays that hold the trunk lid in place. Observe the following precautions.  
Failure to do so may cause damage to trunk damper stays, resulting in a malfunction.

- Do not attach any foreign objects such as stickers, plastic sheets and adhesives to damper stay rods.
- Do not touch damper stay rods with gloves or other fabric items.

- Do not attach any accessories other than genuine Toyota parts to the trunk lid.
- Do not apply lateral force to damper stays or place your hand on it.

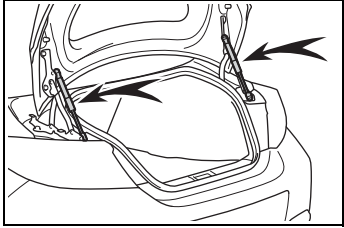

**Opening/closing the trunk**

■ **Trunk opener switch**  
Press and hold the trunk opener switch.

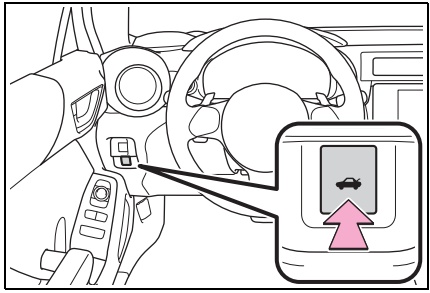

■ **Smart key system**  
While carrying the electronic key, press the button on the trunk lid.  
When all of the doors are unlocked, the trunk lid can be opened while not carrying an electronic key. However, as the doors will be locked when the vehicle is driven (at a vehicle speed of 3 mph [5 km/h] or more), the trunk will not be able

to be opened until a door is opened.

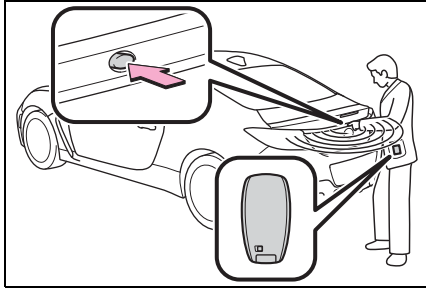

■ **Wireless remote control**

Press and hold the switch.

A buzzer sounds.



■ **Trunk light**

The trunk light turns on when the trunk is opened.

■ **Function to prevent the trunk being locked with the electronic key inside**

- When both side doors are locked, closing the trunk lid with the electronic key left inside the trunk will sound an alarm.

In this case, the trunk lid can be opened by pressing the trunk release button on the trunk lid.

- If the spare electronic key is put in the trunk with both side doors locked, the key confinement prevention function is activated so the trunk can be opened. In order to prevent theft, take all electronic keys with you when leaving the

vehicle.

- If the electronic key is put in the trunk with both side doors locked, the key may not be detected depending on the location of the key and the surrounding radio wave conditions. In this case, the key confinement prevention function cannot be activated, causing the doors to lock when the trunk is closed. Make sure to check where the key is before closing the trunk.
- The key confinement prevention function cannot be activated if either door is unlocked. In this case, open the trunk using the trunk opener.

■ **Internal trunk release lever**

The trunk lid can be opened by pulling the glow-in-the-dark lever located on the inside of the trunk lid upward.

The lever will continue to glow for some time after the trunk lid is closed.

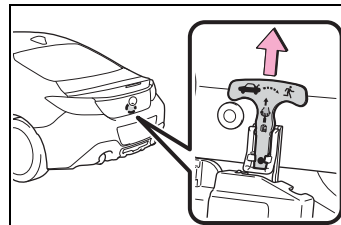

■ **If the smart key system or the wireless remote control does not operate properly**

Replace the key battery with a new one if it is depleted. (→P.328)

■ **Customization**

Some functions can be customized. (→P.400)

### Smart key system

The following operations can be performed simply by carrying the electronic key on your person, for example in your pocket. The driver should always carry the electronic key.

- Locks and unlocks the doors (→P.105)
- Opens the trunk (→P.109)
- Starts the engine (→P.145)

#### Antenna location

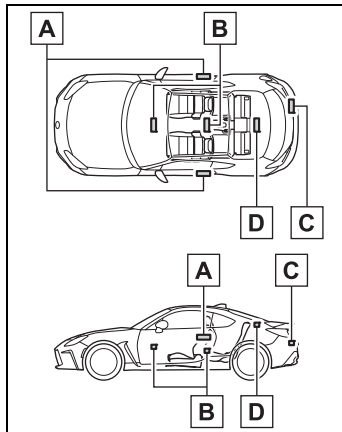

- A** Antennas outside the cabin
- B** Antennas inside the cabin
- C** Antenna outside the trunk
- D** Antenna inside the trunk

#### Effective range (areas within which the electronic key is detected)

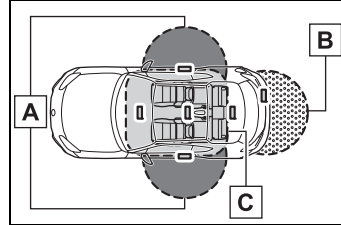

- A** When locking or unlocking the doors

The system can be operated when the electronic key is within about 1.3 — 2.6 ft. (0.4 — 0.8 m) of an outside door handle. (Only the doors detecting the key can be operated.)

- B** When opening the trunk

The system can be operated when the electronic key is within about 1.3 — 2.6 ft. (0.4 — 0.8 m) of the trunk release button.

- C** When starting the engine or changing engine switch modes

The system can be operated when the electronic key is inside the vehicle.

#### Alarms and warning messages

An alarm sounds and warning messages are displayed on the multi-information display to protect against unexpected accidents or theft of the vehicle resulting from erroneous operation. When a warning message is displayed, take appropriate measures based on the displayed message. (→P.357)

When only an alarm sounds, circumstances and correction procedures are as follows.

- When an exterior alarm sounds once for 5 seconds

Situation	Correction procedure
An attempt was made to lock the vehicle while a door was open.	Close both side doors and lock the doors again.

- When an exterior alarm sounds once for 2 seconds

Situation	Correction procedure
The trunk was closed while the electronic key was still inside the trunk and both side doors were locked.	Retrieve the electronic key from the trunk and close the trunk lid.

- When an interior alarm sounds continuously

Situation	Correction procedure
The engine switch was turned to ACC while the driver's door was open (or the driver's door was opened while the engine switch was in ACC).	Turn the engine switch off and close the driver's door.
The engine switch was turned off while the driver's door was open.	Close the driver's door.

■ **Battery-saving function**

The battery-saving function will be activated in order to prevent the electronic key battery and the vehicle battery from being discharged while the vehicle is not in operation for a long time.



- In the following situations, the

smart key system may take some time to unlock the doors.

- The electronic key has been left within approximately 6 ft. (2 m) of the outside of the vehicle for 10 minutes or longer.
- The smart key system has not been used for 5 days or longer.
- If the smart key system has not been used for 14 days or longer, the doors cannot be unlocked at the passenger door. In this case, take hold of the driver's door handle, or use the wireless remote control or mechanical key, to unlock the doors.

■ **Electronic Key Battery-Saving Function**

When battery-saving mode is set, battery depletion is minimized by stopping the electronic key from receiving radio waves.

Press  twice while pressing and holding . Confirm that the electronic key indicator flashes 4 times.

While the battery-saving mode is set, the smart key system cannot be used. To cancel the function, press any of the electronic key buttons.

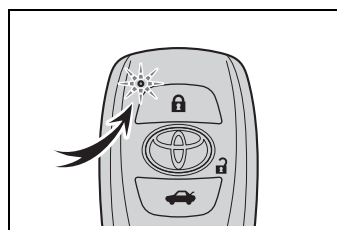

■ **Conditions affecting operation**

The smart key system uses weak radio waves. In the following situations, the communication between the electronic key and the vehicle may be affected, preventing the smart key system, wireless remote control and engine immobilizer system from operating properly. (Ways of coping: →P.370)

- When the electronic key battery is



depleted

- Near a TV tower, electric power plant, gas station, radio station, large display, airport or other facility that generates strong radio waves or electrical noise
  - When carrying a portable radio, cellular phone, cordless phone or other wireless communication device
  - When the electronic key is in contact with, or is covered by the following metallic objects
    - Cards to which aluminum foil is attached
    - Cigarette boxes that have aluminum foil inside
    - Metallic wallets or bags
    - Coins
    - Hand warmers made of metal
    - Media such as CDs and DVDs
  - When other wireless keys (that emit radio waves) are being used nearby
  - When carrying the electronic key together with the following devices that emit radio waves
    - Another vehicle's electronic key or a wireless key that emits radio waves
    - Personal computers or personal digital assistants (PDAs)
    - Digital audio players
    - Portable game systems
  - If window tint with a metallic content or metallic objects are attached to the rear window
  - When the electronic key is placed near a battery charger or electronic devices
- **Note for the entry function**
- Even when the electronic key is within the effective range (detection areas), the system may not operate properly in the following cases:
    - The electronic key is too close to the window or outside door handle, near the ground, or in a high place when the doors are locked or unlocked.
    - The electronic key is near the ground or in a high place, or too close to the rear bumper center when the trunk is unlocked.
    - The electronic key is on the instrument panel, rear package tray or floor, or in the door pockets or glove box when the engine is started or engine switch modes are changed.
  - Do not leave the electronic key on top of the instrument panel or near the door pockets when exiting the vehicle. Depending on the radio wave reception conditions, it may be detected by the antenna outside the cabin and the doors will become lockable from the outside, possibly trapping the electronic key inside the vehicle.
  - As long as the electronic key is within the effective range, the doors may be locked or unlocked by anyone. However, only the doors detecting the electronic key can be used to unlock the vehicle.
  - Even if the electronic key is not inside the vehicle, it may be possible to start the engine if the electronic key is near the window.
  - The doors may unlock or lock if a large amount of water splashes on the door handle, such as in the rain or in a car wash, when the electronic key is within the effective range. (The doors will automatically be locked after approximately 60 seconds if the doors are not opened and closed.)
  - If the wireless remote control is used to lock the doors when the electronic key is near the vehicle, there is a possibility that the door may not be unlocked by the entry function. (Use the wireless remote control to unlock the doors.)
  - Touching the door lock or unlock sensor while wearing gloves may prevent lock or unlock operation.
  - When the lock operation is per-

formed using the lock sensor, recognition signals will be shown up to three consecutive times. After this, no recognition signals will be given.

- If the door handle becomes wet while the electronic key is within the effective range, the door may lock and unlock repeatedly. In this case, follow the following correction procedures to wash the vehicle:
  - Place the electronic key in a location 6 ft. (2 m) or more away from the vehicle. (Take care to ensure that the key is not stolen.)
  - Set the electronic key to battery-saving mode to disable the smart key system. (→P.112)
- If the electronic key is inside the vehicle and a door handle becomes wet during a car wash, a message may be shown on the multi-information display and a buzzer will sound outside the vehicle. To turn off the alarm, lock both side doors.
- The lock sensor may not work properly if it comes into contact with ice, snow, mud, etc. Clean the lock sensor and attempt to operate it again.
- A sudden handle operation or a handle operation immediately after entering the effective range may prevent the doors from being unlocked. Touch the door unlock sensor and check that the doors are unlocked before pulling the door handle again.
- Unlocking the vehicle may take more time if another electronic key is within the effective range.

#### ■ When the vehicle is not driven for extended periods

- To prevent theft of the vehicle, do not leave the electronic key within 6 ft. (2 m) of the vehicle.
- The smart key system can be deactivated in advance. (→P.115)

- Setting the electronic key to battery-saving mode helps to reduce key battery depletion. (→P.112)

#### ■ To operate the system properly

- Make sure to carry the electronic key when operating the system. Do not get the electronic key too close to the vehicle when operating the system from the outside of the vehicle.

Depending on the position and holding condition of the electronic key, the key may not be detected correctly and the system may not operate properly. (The alarm may go off accidentally, or the door lock prevention function may not operate.)

- Do not leave the electronic key inside the trunk. The key confinement prevention function may not operate, depending on the location of the key (the inside edge of the Trunk), conditions (inside a metal bag, close to metallic objects) and the radio waves in the surrounding area. (→P.111)

#### ■ If the smart key system does not operate properly

- Locking and unlocking the doors: →P.370
- Starting the engine: →P.370

#### ■ Customization

Some functions can be customized. (→P.400)

#### ■ If the smart key system has been disabled

- Locking and unlocking the doors: Use the wireless remote control or mechanical key. (→P.105, 370)
- Starting the engine and changing engine switch modes: →P.370
- Stopping the engine: →P.147

**⚠ WARNING**

■ **Caution regarding interference with electronic devices**

- People with implantable cardiac pacemakers, cardiac resynchronization therapy-pacemakers or implantable cardioverter defibrillators should keep away from the smart key system antennas. (→P.111)

The radio waves may affect the operation of such devices. If necessary, the entry function can be disabled. Ask your Toyota dealer for details, such as the frequency of radio waves and timing of the emitted radio waves. Then, consult your doctor to see if you should disable the entry function.

- Users of any electrical medical device other than implantable cardiac pacemakers, cardiac resynchronization therapy-pacemakers or implantable cardioverter defibrillators should consult the manufacturer of the device for information about its operation under the influence of radio waves.

Radio waves could have unexpected effects on the operation of such medical devices.

The smart key system can be disabled. (→P.115)

**When to disable the smart key system**

In the following situations, the smart key system should be disabled.

- When people with implantable cardiac pacemakers, cardiac resynchronization therapy pacemakers or implantable

cardioverter defibrillators ride in the vehicle.

- When the vehicle will not be used for a long time, or the smart key system is not used.
- When storing an electronic key near or inside the vehicle cannot be avoided.



When the smart key system is disabled, use the wireless remote control to lock and unlock the doors.

When starting the engine, it will be necessary to hold the electronic key near the engine switch. (→P.370)

■ **Disabling the smart key system**

The smart key system can be disabled by opening and closing the doors or using the wireless remote control.

▶ **Door opening/closing method**

- 1 While sitting in the driver's seat, close the door.
- 2 Press  of the door lock switch.
- 3 Within 5 seconds of performing step 2, open the driver's door.
- 4 Within 5 seconds of performing step 3, press  of the door lock switch 2 times with the door open.
- 5 Within 10 seconds of performing step 4, close and

open the driver's door 2 times.



- 6** Within 10 seconds of performing step **5**, press  of the door lock switch 2 times with the door open.
- 7** Within 10 seconds of performing step **6**, close and open the driver's door 1 time.
- 8** Within 5 seconds of performing step **7**, close the driver's door.

A buzzer will sound for approximately 2 seconds and the smart key system will be disabled.

▶ **Wireless remote control method**

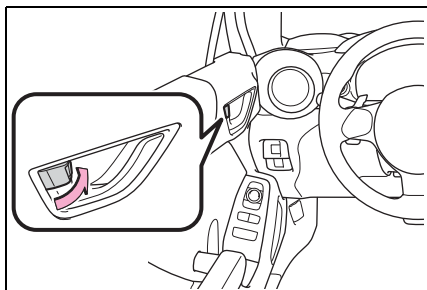
- 1** Open the driver's door and push the lock lever forward.



- 2** Press and hold  and  of the wireless remote control at the same time for 5 seconds or more.

A buzzer will sound for approximately 2 seconds and the smart key system will be disabled.

■ **Enabling the smart key system**

The smart key system can be enabled by performing the pro-

cedure used to disable it again. When enabled a buzzer will sound.

■ **Door opening/closing method**

Make sure to firmly press the door lock switch in steps **4** and **6**. If the switch is pressed for a very short time, the system may not be disabled.

■ **Wireless remote control method**

To use the wireless remote control method to disable the smart key system, it is necessary to register a PIN code for the PIN code smart entry. (→P.117)

■ **When enabling the smart key system**

If the method used to disable the smart key system is unknown, press the engine switch.

- If the wireless remote control system was used, a buzzer inside the vehicle will sound.
- If the door opening/closing method was used, the buzzer will not sound.

■ **Customization**

Some functions can be customized. (→P.400)

 **NOTICE**

■ **When disabling the smart key system**

When disabling or enabling the system to accommodate persons with implantable cardiac pacemakers, cardiac resynchronization therapy pacemakers or implantable cardioverter defibrillators, always use the door opening/closing method. If the wireless remote control method is used, the system may be enabled accidentally.

### Unlocking the doors using PIN code smart entry

By registering a 5 digit PIN code, all of the doors and the fuel filler door can be unlocked without an electronic key by pressing the trunk opener switch.



#### ■ PIN code registration method

- 1 Turn the engine switch off.
- 2 Close all of the doors and the trunk.
- 3 Press and hold  of the wireless remote control.

At this time, all of the doors and the fuel filler door will lock.

- 4 Within 5 seconds of performing step 3, press and hold the trunk opener switch.

After 5 seconds or more, a buzzer will sound.

- 5 Release  of the wireless remote control and the trunk opener switch.
- 6 Within 30 seconds after the buzzer begins sounding, press  of the wireless remote control.

The buzzer will stop.

- 7 A PIN code can now be registered. Press the trunk opener switch the same number of times as the first digit of the PIN code.

For example: If registering 32468, press the switch 3 times.

- 8 Wait for the buzzer to sound 1 time and then press the switch the same number of times as for the next digit.

For example: If registering 32468, press the switch 2 times.

- 9 Repeat step 8 for the remaining digits.
- 10 Within 30 seconds after the buzzer begins sounding intermittently, perform steps 7 through 9 again to confirm the PIN code.

Registration is complete and all of the doors and the fuel filler door will unlock.

#### ■ Unlocking method

Press the trunk opener switch using the same procedure as steps 7 through 9.

#### ■ PIN code registration

- To prevent theft, the same digit for all 5 digits and 12345 cannot be registered as the PIN code. Also, avoid using the same number as on your license plate or other simple codes.
- To use 0 as a digit, press the trunk opener switch 10 times.
- If a mistake is made during registration, unlock the doors or trunk using the wireless remote control to cancel registration. Then perform registration again, starting from step 1. However, if the mistake was made in step 10, a buzzer will sound and step 10 can be performed again.
- To clear the PIN code, perform the registration procedure and enter 22222.

- After registering a new PIN code, make sure to check that the doors can be unlocked using the code.
- If the smart key system has been disabled using the wireless remote control method, the PIN code for the PIN code smart entry cannot be cleared. (→P.115)
- In the following cases, perform the PIN code registration procedure again.
  - If the PIN code has been forgotten.
  - When you wish to change the PIN code.
- Make sure to change the PIN code periodically.
- If the vehicle has been loaned to another person, make sure that the PIN code has not been changed or cleared. If the PIN code has been changed or cleared, perform PIN code registration again.

■ **Unlocking method**

- If an electronic key is within a detection area, operation of the smart entry will be given priority.
- If a mistake is made while entering the PIN code, wait 5 seconds or more before performing the procedure again.
- If the incorrect PIN code is entered 5 times consecutively, a buzzer will sound for approximately 2 seconds and operation will not be possible for 5 minutes.

Front seats

Adjustment procedure

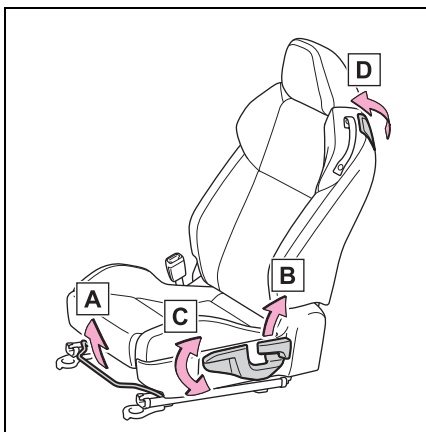

- A** Seat position adjustment lever
- B** Seatback angle adjustment lever
- C** Vertical height adjustment lever (driver's side only)
- D** Seatback fold lever

Getting in and out of the rear seats

To get in and out of the rear seats, use the seatback angle adjustment lever or seatback fold lever.

■ Before getting in or out of the rear seats

Remove the seat belt from the seat belt guide. (→P.27)

■ When getting in or out of the rear seats

▶ Driver's side

Pull the seatback fold lever (A) or lift the seatback angle adjustment lever (B).

The seatback will fold forward.

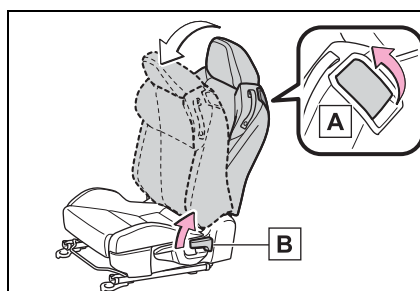

▶ Front passenger's side

Pull the seatback fold lever (A) or lift the seatback angle adjustment lever (B).

The seatback will fold forward.

The seat can be slid forward and backward.

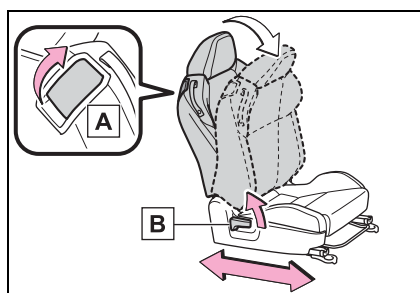

■ After getting in or out of the rear seats

Return the seatback to the upright position until the seat locks.

Front passenger seat only: The

seat will lock in position at the point where the seatback reaches the upright position.

■ **Seat dust cover**

Always remove the seat dust cover that may be attached at the time of purchase before using the seat.

 **WARNING**

■ **Seat adjustment**

To reduce the risk of sliding under the lap belt during a collision, do not recline the seat more than necessary.

If the seat is too reclined, the lap belt may slide past the hips and apply restraint forces directly to the abdomen, or your neck may contact the shoulder belt, increasing the risk of death or serious injury in the event of an accident.

Adjustments should not be made while driving as the seat may unexpectedly move and cause the driver to lose control of the vehicle.

- After adjusting the seat, make sure that the seat is locked in position.
- Take care not to hit passengers with the seat. When sliding the seat rearward, make sure not to squash the legs of the rear passengers.
- When returning the seatback upright, perform seatback angle adjustment while holding down the seatback.
- Do not pull on or use the seat belt guide to adjust or fold the front seat.

- Do not put your hands under the seat or near the moving parts to avoid injury. Fingers or hands may become jammed in the seat mechanism.

■ **When driving the vehicle**

Never operate the seat position adjustment lever, seatback angle adjustment lever or seatback fold lever. Doing so could cause an accident resulting in death or serious injury.

■ **Getting in and out of the rear seats**

- When getting in or out of the rear seats, make sure not to get your hands, legs, etc. squashed in the movable or connecting parts.
- When getting in or out of the rear seats, make sure not to trip on the seat rails.
- After getting in or out of the rear seats, always make sure the front seat is locked in position.

■ **When operating the front seat from the rear seat**

Make sure that no passenger is seated in the front seat.

 **NOTICE**

■ **When adjusting a front seat**

When adjusting a front seat, make sure that the head restraint does not contact the headliner. Otherwise, the head restraint and headliner may be damaged.



 **NOTICE**

■ **When getting in and out the vehicle**

Do not rub your back against the side support pad of backrest. Otherwise surface of the side support pad is damaged early. You can move the seat backward to prevent the contact.

**Rear seats**

**The rear seatbacks can be folded down.**

**Folding down the rear seatbacks**

**1** Move the front seats forward.  
(→P.119)

**2** Fold the seatback down.

► **Lock release buttons**

Press the seatback lock release buttons and fold the seatback down.

Press the button until the lock is released.

To return the seatbacks to its original position, lift it up until it locks.

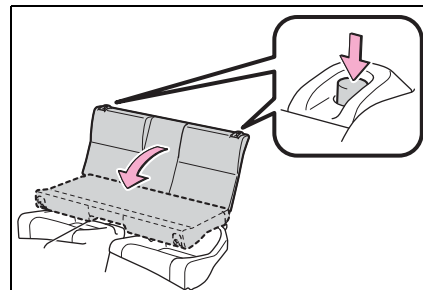

► **Lock release straps**

Pull the seatback lock release straps in the trunk for the seatback you wish to fold down.

To return the seatbacks to its original position, lift it up until it locks.

**3**

Before driving

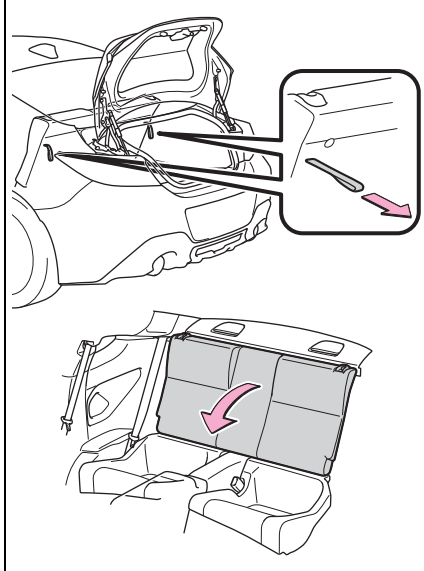

■ **Seat dust cover**

Always remove the seat dust cover that may be attached at the time of purchase before using the seat.

**⚠ WARNING**

Observe the following precautions. Failure to do so may result in death or serious injury.

■ **When folding the rear seat-backs down**

- Do not fold the seatbacks down while driving.
- Stop the vehicle on level ground, set the parking brake and shift the shift lever to P (automatic transmission) or N (manual transmission).
- Do not allow anyone to sit on a folded seatback or in the trunk while driving.
- Do not allow children to enter the trunk.

■ **After returning the rear seat-back to the upright position**

- Push the rear seatback and then check that it is securely locked in position by lightly pushing it back and forth. If the seatback is not securely locked, the red portion of the seatback lock indicator will be visible. Make sure that the red portion is not visible.

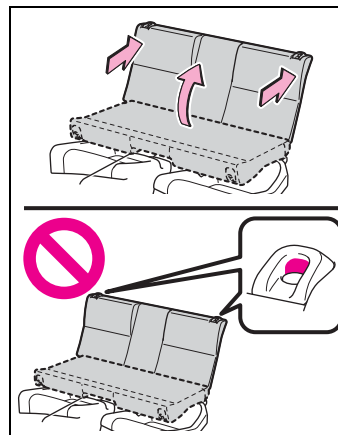

- Check that the seat belts are not twisted or caught in the seatback.

■ **Before using the rear seat belts**

Always make sure that the seat belt is not caught in the seatback or twisted in one of the hooks that secure the seatback. Failure to do so may cause the seat belt to not be fastened correctly or to become ineffective in a collision, resulting in death or serious injury.

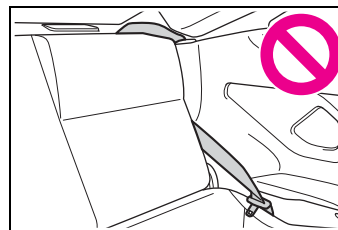

**Head restraints**

**Head restraints are provided for front seats.**

**⚠ WARNING****■ Head restraint precautions**

Observe the following precautions regarding the head restraints. Failure to do so may result in death or serious injury.

- Use the head restraints designed for each respective seat.
- Adjust the head restraints to the correct position at all times.
- After adjusting the head restraints, push down on them and make sure they are locked in position.
- Do not drive with the head restraints removed.

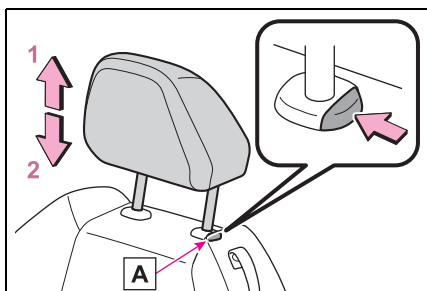
**Adjusting a head restraint vertically****1 Up**

Pull the head restraints up.

**2 Down**

Push the head restraint down while pressing the lock release button **A**.

**■ Adjusting the height of the head restraints**

Make sure that the head restraints are adjusted so that the center of the head restraint is closest to the top of your ears.

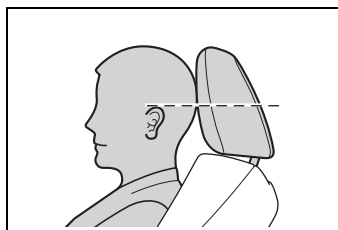
**Removing the head restraints**

Pull the head restraint up while pressing the lock release button **A**.

If the head restraint touches the ceiling, making the removal difficult, change the seat height or angle. (→P.119)

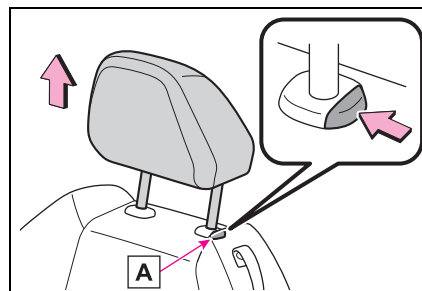
**Installing the head restraints**

Align the head restraint with the installation holes and push it down to the lock position.

Press and hold the lock release

**3**

Before driving

button **A** when lowering the head restraint.

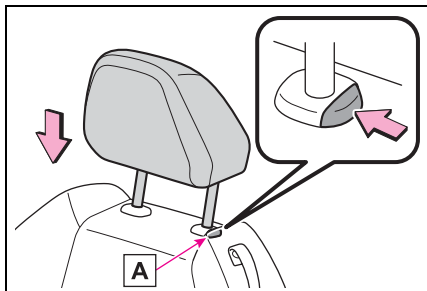

**Steering wheel**

**Adjustment procedure**

- 1 Hold the steering wheel and push the lever down.

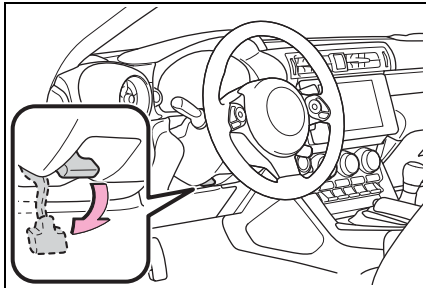

- 2 Adjust to the ideal position by moving the steering wheel horizontally and vertically.

After adjustment, pull the lever up to secure the steering wheel.

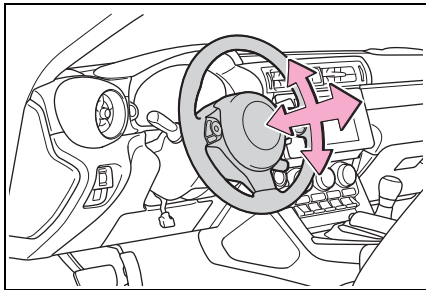

**⚠ WARNING**

■ **Caution while driving**

Do not adjust the steering wheel while driving.

Doing so may cause the driver to mishandle the vehicle and cause an accident, resulting in death or serious injury.

■ **After adjusting the steering wheel**

Make sure that the steering wheel is securely locked.

Otherwise, the steering wheel may move suddenly, possibly causing an accident, and resulting in death or serious injury. Also, the horn may not sound if the steering wheel is not securely locked.

**Horn**

To sound the horn, press on or close to the  mark.

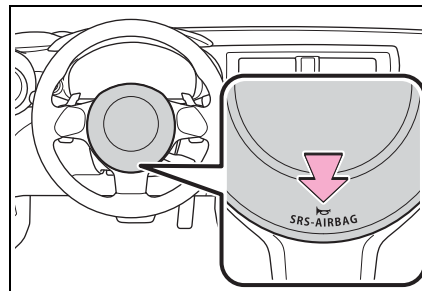

3

Before driving

### Inside rear view mirror

The rear view mirror's position can be adjusted to enable sufficient confirmation of the rear view.

### Adjusting the height of rear view mirror

The height of the rear view mirror can be adjusted to suit your driving posture.

Adjust the height of the rear view mirror by moving it up and down.

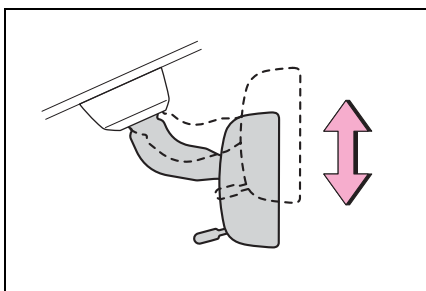

### ⚠ WARNING

#### ■ Caution while driving

Do not adjust the position of the mirror while driving.

Doing so may lead to mishandling of the vehicle and cause an accident, resulting in death or serious injury.

### Anti-glare function

Reflected light from the headlights of vehicles behind can be reduced by operating the lever.

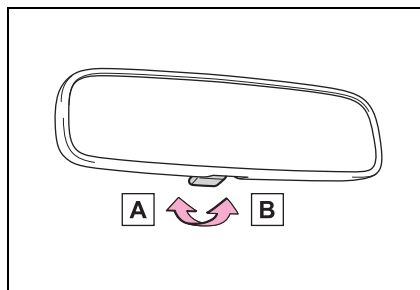

A Normal position

B Anti-glare position

**Outside rear view mirrors**

The rear view mirror's position can be adjusted to enable sufficient confirmation of the rear view.

**⚠ WARNING**

■ **Important points while driving**

Observe the following precautions while driving. Failure to do so may result in loss of control of the vehicle and cause an accident, resulting in death or serious injury.

- Do not adjust the mirrors while driving.
- Do not drive with the mirrors folded.
- Both the driver and passenger side mirrors must be extended and properly adjusted before driving.

**Adjustment procedure**

- 1 To select a mirror to adjust, turn the switch.

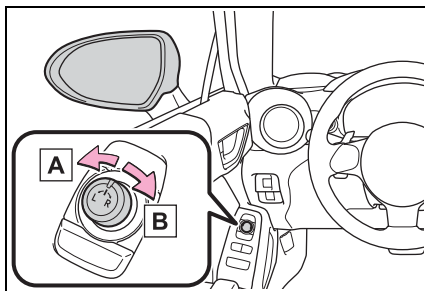

- A Left
- B Right

- 2 To adjust the mirror, operate the switch.

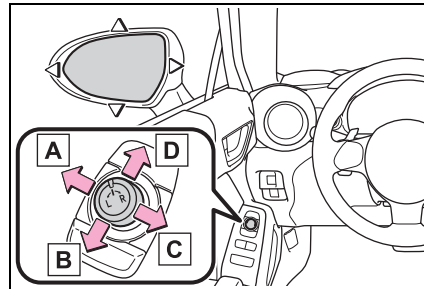

- A Left
- B Down
- C Right
- D Up

■ **Mirror angle can be adjusted when**

The engine switch is in ACC or ON.

■ **When the mirrors are fogged up**

The outside rear view mirrors can be cleared using the mirror defoggers. Turn on the rear window defogger to turn on the outside rear view mirror defoggers. (→P.272)

**⚠ WARNING**

■ **When the mirror defoggers are operating**

Do not touch the rear view mirror surfaces, as they can become very hot and burn you.

**Folding the mirrors**

Push the mirror back in the direction of the vehicle's rear.

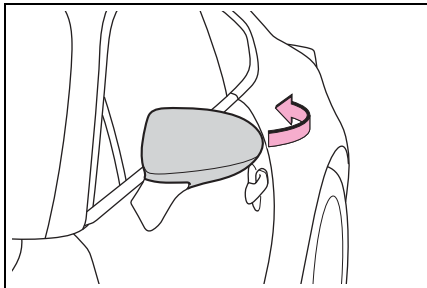



**Power windows**

**Opening and closing the power windows**

The power windows can be opened and closed using the switches.

Operating the switch moves the windows as follows:

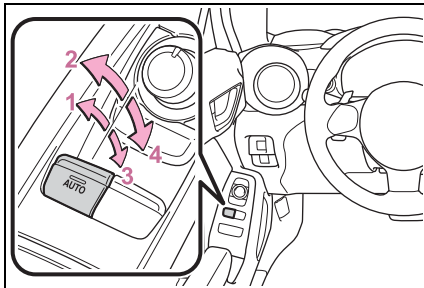

- 1 Closing
- 2 One-touch closing\*
- 3 Opening
- 4 One-touch opening\*

\*: To stop the window partway, operate the switch in the opposite direction.

**■ The power windows can be operated when**

The engine switch is in ON.

**■ Operating the power windows after turning the engine off**

The power windows can be operated for approximately 40 seconds after the engine switch is turned to ACC or OFF. They cannot, however, be operated once either front door is opened.

**■ Jam protection function**

If an object becomes jammed between the window and the body

while the window is closing, window movement is stopped and the window is opened slightly.

**■ Catch protection function**

If an object becomes caught between the door and window while the window is opening, window movement is stopped.

**■ When the window cannot be opened or closed**

When the jam protection function or catch protection function operates unusually and the door window cannot be opened or closed, perform the following operations with the power window switch of that door.

- 1 Check that all of the doors are closed.
- 2 Turn the engine switch to ON.
- 3 Press and hold the power window switch in the one-touch opening position. After the window is fully opened, continue pressing the switch for approximately 1 second.
- 4 Pull and hold the power window switch in the one-touch closing position. After the window is fully closed, continue pulling the switch for approximately 1 second.

If you push the power window switch to the opening position while the window is moving, start again from the beginning. If the window continues to close but then re-open slightly even after performing the above procedure correctly, have the vehicle inspected by your Toyota dealer.

**⚠ WARNING**

Observe the following precautions. Failure to do so may result in death or serious injury.

**⚠ WARNING**

**■ Closing the windows**

- The driver is responsible for all the power window operations, including the operation for the passengers. In order to prevent accidental operation, especially by a child, do not let a child operate the power windows. It is possible for children and other passengers to have body parts caught in the power window. Also, when riding with a child, it is recommended to use the window lock switch. (→P.130)
- Check to make sure that all passengers do not have any part of their body in a position where it could be caught when a window is being operated.

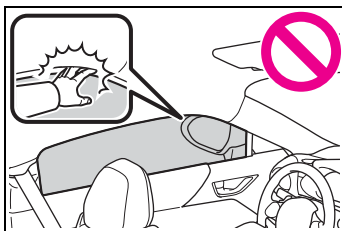

- When exiting the vehicle, turn the engine switch off, carry the key and exit the vehicle along with the child. There may be accidental operation, due to mischief, etc., that may possibly lead to an accident.

**■ Jam protection function**

- Never use any part of your body to intentionally activate the jam protection function.
- The jam protection function may not work if something gets jammed just before the window is fully closed. Be careful not to get any part of your body jammed in the window.

**■ Catch protection function**

- Never use any part of your body or clothing to intentionally activate the catch protection function.
- The catch protection function may not work if something gets caught just before the window is fully opened. Be careful not to get any part of your body or clothing caught in the window.

**Preventing accidental operation (window lock switch)**

Press the switch down to lock the passenger window glasses.

Use this switch to prevent children from accidentally opening or closing a passenger window.

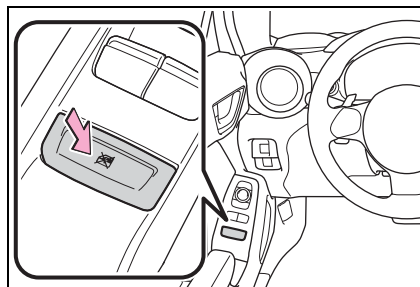

- 4-1. Before driving**
  - Driving the vehicle..... 132
  - Cargo and luggage ..... 140
  - Vehicle load limits ..... 143
  - Trailer towing..... 143
  - Dinghy towing ..... 144
- 4-2. Driving procedures**
  - Engine (ignition) switch  
..... 145
  - Automatic transmission  
..... 149
  - Manual transmission ... 153
  - Turn signal lever..... 155
  - Parking brake ..... 156
  - ASC (Active Sound Control)  
..... 157
- 4-3. Operating the lights and wipers**
  - Headlight switch ..... 158
  - High Beam Assist..... 162
  - Windshield wipers and washer..... 165
- 4-4. Refueling**
  - Opening the fuel tank cap  
..... 167
- 4-5. EyeSight**
  - EyeSight..... 170
  - Pre-Collision Braking System ..... 179
  - Adaptive Cruise Control  
..... 190
- Conventional Cruise Control  
..... 207
- Pre-Collision Throttle Management ..... 215
- Lane Departure Warning  
..... 220
- Lane Sway Warning .... 222
- Lead Vehicle Start Alert  
..... 224
- List of alert/notification sounds..... 226
- EyeSight malfunction and temporary stop ..... 228
- 4-6. Using other driving systems**
  - BSD/RCTA..... 232
  - Reverse Automatic Braking (RAB) system ..... 240
  - Rear view camera ..... 250
  - Conventional Cruise Control  
..... 255
  - Driving mode select switch  
..... 258
  - Hill-start assist control . 259
  - Driving assist systems  
..... 262
- 4-7. Driving tips**
  - Winter driving tips..... 266

**Driving the vehicle**

**The following procedures should be observed to ensure safe driving:**

**Driving procedure**

■ **Starting the engine**

→P.145

■ **Driving**

▶ **Automatic transmission**

- 1 With the brake pedal depressed, shift the shift lever to D. (→P.149)
- 2 Release the parking brake. (→P.156)
- 3 Gradually release the brake pedal and gently depress the accelerator pedal to accelerate the vehicle.

▶ **Manual transmission**

- 1 While depressing the clutch pedal, shift the shift lever to 1. (→P.153)
- 2 Release the parking brake. (→P.156)
- 3 Gradually release the clutch pedal. At the same time, gently depress the accelerator pedal to accelerate the vehicle.

■ **Stopping**

▶ **Automatic transmission**

- 1 With the shift lever in D, depress the brake pedal.

- 2 If necessary, set the parking brake.

If the vehicle is to be stopped for an extended period of time, shift the shift lever to P. (→P.149)

▶ **Manual transmission**

- 1 While depressing the clutch pedal, depress the brake pedal.
- 2 If necessary, set the parking brake.

If the vehicle is to be stopped for an extended period of time, shift the shift lever to N. (→P.153)

■ **Parking the vehicle**

▶ **Automatic transmission**

- 1 With the shift lever in D, depress the brake pedal to stop the vehicle completely.
- 2 Set the parking brake (→P.156), shift the shift lever to P. (→P.149)

Check the parking brake indicator is illuminated.

- 3 Press the engine switch to stop the engine.
- 4 Slowly release the brake pedal.
- 5 Lock the door, making sure that you have the key on your person.

If parking on a hill, block the wheels as needed.

▶ **Manual transmission**

- 1 While depressing the clutch pedal, depress the brake pedal to stop the vehicle completely.

- 2 Set the parking brake.  
(→P.156)

Check that the parking brake indicator is illuminated.

- 3 Shift the shift lever to N.  
(→P.153)

If parking on a hill, shift the shift lever to 1 or R and block the wheels as needed.

- 4 Press the engine switch to stop the engine.
- 5 Slowly release the brake pedal.
- 6 Lock the door, making sure that you have the key on your person.

■ **Starting off on a steep uphill**

▶ Automatic transmission

- 1 Make sure that the parking brake is set and shift the shift lever to D.
- 2 Gently depress the accelerator pedal.
- 3 Release the parking brake.

▶ Manual transmission

- 1 Make sure that the parking brake is set and shift the shift lever to 1.
- 2 Lightly depress the accelerator pedal at the same time as gradually releasing the clutch pedal.
- 3 Release the parking brake.

■ **When starting off on an uphill**

The hill-start assist control will acti-

vate. (→P.259)

■ **Driving in the rain**

- Drive carefully when it is raining, because visibility will be reduced, the windows may become fogged-up, and the road will be slippery.
- Drive carefully when it starts to rain, because the road surface will be especially slippery.
- Refrain from high speeds when driving on an expressway in the rain, because there may be a layer of water between the tires and the road surface, preventing the steering and brakes from operating properly.

■ **Engine speed while driving (vehicles with an automatic transmission)**

In the following conditions, the engine speed may become high while driving. This is due to automatic up-shifting control or down-shifting implementation to meet driving conditions. It does not indicate sudden acceleration.

- The vehicle is judged to be driving uphill or downhill
- When the accelerator pedal is released
- When driving on curves
- When the brake pedal is firmly depressed

■ **Restraining the engine output (Brake Override System)**

When the accelerator and brake pedals are depressed at the same time, the engine output may be restrained.

■ **New vehicle break-in driving (the first 1000 miles [1600 km])**

The performance and long life of your vehicle are dependent on how you handle and care for your vehicle while it is new. Follow these instructions during the first 1000 miles (1600 km):

- Do not race the engine. And do not allow the engine speed to exceed 4000 rpm except in an emergency.
- Do not drive at one constant engine or vehicle speed for a long time, either fast or slow.
- Avoid starting suddenly and rapid acceleration, except in an emergency.
- Avoid hard braking, except in an emergency.  
The same break-in procedures should be applied to an overhauled engine, newly mounted engine or when brake pads or brake linings are replaced with new ones.

■ **Drum-in-disc type parking brake system**

Your vehicle has a drum-in-disc type parking brake system. This type of brake system needs bedding-down of the brake shoes periodically or whenever the parking brake shoes and/or drum are replaced. Have your Toyota dealer perform the bedding down operation.

■ **After the engine starts**

For a short time after the engine is started, in order to ensure emissions performance, intake and exhaust noise and vibration may increase, but this does not indicate a malfunction.

■ **Operating your vehicle in a foreign country**

Comply with the relevant vehicle registration laws and confirm the availability of the correct fuel. (→P.381)



**WARNING**

Observe the following precautions. Failure to do so may result in death or serious injury.

■ **When starting the vehicle (vehicles with an automatic transmission)**

- Always keep your foot on the brake pedal while stopped with the engine running. This prevents the vehicle from creeping.
- Firmly depress the brake pedal because engine speed may increase immediately after starting the engine, when the air conditioning system is operating, when turning the steering wheel, etc., thereby causing creeping to become stronger. Apply the parking brake as necessary.

■ **When driving the vehicle**

- Do not drive if you are unfamiliar with the location of the brake and accelerator pedals to avoid depressing the wrong pedal.
- Accidentally depressing the accelerator pedal instead of the brake pedal will result in sudden acceleration that may lead to an accident.
- When backing up, you may twist your body around, leading to a difficulty in operating the pedals. Make sure to operate the pedals properly.
- Make sure to keep a correct driving posture even when moving the vehicle only slightly. This allows you to depress the brake and accelerator pedals properly.
- Depress the brake pedal using your right foot. Depressing the brake pedal using your left foot may delay response in an emergency, resulting in an accident.

**WARNING**

- Do not drive the vehicle over or stop the vehicle near flammable materials.  
The exhaust system and exhaust gases can be extremely hot. These hot parts may cause a fire if there is any flammable material nearby.
- Vehicles with a manual transmission: Do not release the clutch pedal too quickly. Doing so may propel the vehicle forward, possibly causing an accident.
- During normal driving, do not turn off the engine. Turning the engine off while driving will not cause loss of steering or braking control, but the power assist to these systems will be lost. This will make it more difficult to steer and brake, so you should pull over and stop the vehicle as soon as it is safe to do so. However, in the event of an emergency, such as if it becomes impossible to stop the vehicle in the normal way:  
→P.338
- Use engine braking (downshift) to maintain a safe speed when driving down a steep hill. Using the brakes continuously may cause the brakes to overheat and lose effectiveness.  
(→P.149, 153)
- Do not adjust the positions of the steering wheel, the seat, or the inside or outside rear view mirrors while driving. Doing so may result in a loss of vehicle control.
- Always check that all passengers' arms, heads or other parts of their body are not outside the vehicle.

- Do not drive in excess of the speed limit. Even if the legal speed limit permits it, do not drive over 85 mph (140 km/h) unless your vehicle has high-speed capability tires. Driving over 85 mph (140 km/h) may result in tire failure, loss of control and possible injury. Be sure to consult a tire dealer to determine whether the tires on your vehicle are high-speed capability tires or not before driving at such speeds.

**When driving on slippery road surfaces**

- Sudden braking, acceleration and steering may cause tire slippage and reduce your ability to control the vehicle.
- Sudden acceleration, engine braking due to shifting, or changes in engine speed could cause the vehicle to skid.
- After driving through a puddle, lightly depress the brake pedal to make sure that the brakes are functioning properly. Wet brake pads may prevent the brakes from functioning properly. If the brakes on only one side are wet and not functioning properly, steering control may be affected.

**When shifting the shift lever**

- Vehicles with an automatic transmission: Do not let the vehicle roll backward while the shift lever is in a driving position, or roll forward while the shift lever is in R. Doing so may cause the engine to stall or lead to poor brake and steering performance, resulting in an accident or damage to the vehicle.

 **WARNING**

- Vehicles with an automatic transmission: Do not shift the shift lever to P while the vehicle is moving. Doing so can damage the transmission and may result in a loss of vehicle control.
- Do not shift the shift lever to a driving position while the vehicle is moving backward. Doing so can damage the transmission and may result in a loss of vehicle control.
- Do not shift the shift lever to R while the vehicle is moving forward. Doing so can damage the transmission and may result in a loss of vehicle control.
- Moving the shift lever to N while the vehicle is moving will disengage the engine from the transmission. Engine braking is not available when N is selected.
- Vehicles with an automatic transmission: Be careful not to shift the shift lever with the accelerator pedal depressed. Shifting the shift lever to a gear other than P or N may lead to unexpected rapid acceleration of the vehicle that may cause an accident and result in death or serious injury.
- Do not place items in the shift lever's surrounding area. It may cause incorrect operation.
- If the shift boot is pulled out during cleaning, return it to its previous position. If the shift boot is left pulled out, the shift lever may become difficult to operate.

**■ If you hear a squealing or scraping noise (brake pad wear limit indicators)**

Have the brake pads checked and replaced by your Toyota dealer as soon as possible. Rotor damage may result if the pads are not replaced when needed.

It is dangerous to drive the vehicle when the wear limits of the brake pads and/or those of the brake discs are exceeded.

**■ When the vehicle is stopped**

- Do not race the engine. If the vehicle is in any gear other than P (automatic transmission) or N, the vehicle may accelerate suddenly and unexpectedly, causing an accident.
- Vehicles with an automatic transmission: In order to prevent accidents due to the vehicle rolling away, always keep depressing the brake pedal while the engine is running, and apply the parking brake as necessary.
- If the vehicle is stopped on an incline, in order to prevent accidents caused by the vehicle rolling forward or backward, always depress the brake pedal and securely apply the parking brake as needed.
- Avoid revving or racing the engine. Running the engine at high speed while the vehicle is stopped may cause the exhaust system to overheat, which could result in a fire if combustible material is nearby.



**WARNING****■ When the vehicle is parked**

- Do not leave glasses, cigarette lighters, spray cans, or soft drink cans in the vehicle when it is in the sun. Doing so may result in the following:
  - Gas may leak from a cigarette lighter or spray can, and may lead to a fire.
  - The temperature inside the vehicle may cause the plastic lenses and plastic material of glasses to deform or crack.
  - Soft drink cans may fracture, causing the contents to spray over the interior of the vehicle, and may also cause a short circuit in the vehicle's electrical components.
- Do not leave cigarette lighters in the vehicle. If a cigarette lighter is in a place such as the glove box or on the floor, it may be lit accidentally when luggage is loaded or the seat is adjusted, causing a fire.
- Do not attach adhesive discs to the windshield or windows. Do not place containers such as air fresheners on the instrument panel or dashboard. Adhesive discs or containers may act as lenses, causing a fire in the vehicle.
- Do not leave a door or window open if the curved glass is coated with a metallized film such as a silver-colored one. Reflected sunlight may cause the glass to act as a lens, causing a fire.

- Always apply the parking brake, shift the shift lever to P (vehicles with an automatic transmission), stop the engine and lock the vehicle.

Do not leave the vehicle unattended while the engine is running.

If the vehicle is parked with the shift lever in P but the parking brake is not set, the vehicle may start to move, possibly leading to an accident.

- Do not touch the exhaust pipes while the engine is running or immediately after turning the engine off. Doing so may cause burns.

**■ When taking a nap in the vehicle**

Always turn the engine off. Otherwise, if you accidentally move the shift lever or depress the accelerator pedal, this could cause an accident or fire due to engine overheating. Additionally, if the vehicle is parked in a poorly ventilated area, exhaust gases may collect and enter the vehicle, leading to death or a serious health hazard.

**■ When braking**

- When the brakes are wet, drive more cautiously. Braking distance increases when the brakes are wet, and this may cause one side of the vehicle to brake differently than the other side. Also, the parking brake may not securely hold the vehicle.

 **WARNING**

- If the brake booster device does not operate, do not follow other vehicles closely and avoid hills or sharp turns that require braking. In this case, braking is still possible, but the brake pedal should be depressed more firmly than usual. Also, the braking distance will increase. Have your brakes fixed immediately.
- Do not pump the brake pedal if the engine stalls. Each push on the brake pedal uses up the reserve for the power-assisted brakes.
- The brake system consists of 2 individual hydraulic systems; if one of the systems fails, the other will still operate. In this case, the brake pedal should be depressed more firmly than usual and the braking distance will increase. Have your brakes fixed immediately.

■ **If the vehicle becomes stuck**

Do not spin the wheels excessively when any of the tires is up in the air, or the vehicle is stuck in sand, mud, etc. This may damage the driveline components or propel the vehicle forward or backward, causing an accident.

 **NOTICE**

■ **Pre-driving check**

Trapping small animals in the cooling fan and belts of the engine may result in a malfunction. Check that no small animal enters the engine compartment and under the vehicle before starting the engine.

■ **When driving the vehicle (vehicles with an automatic transmission)**

- Do not depress the accelerator and brake pedals at the same time while driving, as this may restrain the engine output.
- Do not use the accelerator pedal or depress the accelerator and brake pedals at the same time to hold the vehicle on a hill.

■ **When driving the vehicle (vehicles with a manual transmission)**

- Do not depress the accelerator and brake pedals at the same time during driving, as this may restrain the engine output.
- Do not shift gears unless the clutch pedal is fully depressed. After shifting, do not release the clutch pedal abruptly. Doing so may damage the clutch, transmission and gears.
- Observe the following precautions. Failure to do so may cause excessive premature wear or damage to the clutch, eventually making it difficult to accelerate and start off from a stop. Have the vehicle inspected by your Toyota dealer.
- Do not rest your foot on the clutch pedal or depress it any time other than when shifting. Doing so may cause clutch trouble.
- Do not use any gear other than the 1st gear when starting off and moving forward. Doing so may damage the clutch.

 NOTICE

- Do not use the clutch pedal to adjust vehicle speed. Doing so may damage the clutch.
- Do not use the clutch to hold the vehicle when stopping on an uphill grade. Doing so may damage the clutch.
- When stopping the vehicle with the shift lever in a position other than N, make sure to fully depress the clutch pedal and stop the vehicle using the brakes.
- Do not shift the shift lever to R without the vehicle completely stopped. Doing so may damage the clutch, transmission and gears.
- Do not release the clutch pedal too quickly. Doing so may damage the transmission.
- **When parking the vehicle (vehicles with an automatic transmission)**  
Always set the parking brake and shift the shift lever to P. Failure to do so may cause the vehicle to move or the vehicle may accelerate suddenly if the accelerator pedal is accidentally depressed.
- **Avoiding damage to vehicle parts**
- Do not turn the steering wheel fully in either direction and hold it there for an extended period of time. Doing so may damage the power steering motor.
- When driving over bumps in the road, drive as slowly as possible to avoid damaging the wheels, underside of the vehicle, etc.

- Vehicles with an automatic transmission: Do not race the engine for more than 5 seconds in any position except the N or P position when the brake is applied or when chocks are used in the wheels. This may cause the transmission fluid to overheat.

 ■ **If you get a flat tire while driving**

A flat or damaged tire may cause the following situations. Hold the steering wheel firmly and gradually depress the brake pedal to slow down the vehicle.

- It may be difficult to control your vehicle.
- The vehicle will make abnormal sounds or vibrations.
- The vehicle will lean abnormally.

Information on what to do in case of a flat tire (→P.358)

 ■ **When encountering flooded roads or waterlogged roads**

Do not drive on a road that has flooded after heavy rain etc. Doing so may cause the following serious damage to the vehicle:

- Engine stalling
- Short in electrical components
- Engine damage caused by water immersion
- Rubber or mechanical part damage or poor lubrication due to grease being washed away, or grease becoming contaminated with mud or dirt

In the event that you drive on a flooded road and the vehicle is flooded, be sure to have your Toyota dealer check the following:



**NOTICE**

- Brake function
- Changes in quantity and quality of oil and fluid used for the engine, transmission, differential, etc.
- Lubricant condition for the propeller shaft, clutch fork, bearings and suspension joints (where possible), and the function of all joints, bearings, etc.

**Cargo and luggage**

**Take notice of the following information about storage precautions, cargo capacity and load:**

**Capacity and distribution**

Cargo capacity depends on the total weight of the occupants.

$$(\text{Cargo capacity}) = (\text{Total load capacity}) - (\text{Total weight of occupants})$$

Steps for Determining Correct Load Limit —

- (1) Locate the statement “The combined weight of occupants and cargo should never exceed XXX kg or XXX lbs.” on your vehicle’s placard.
- (2) Determine the combined weight of the driver and passengers that will be riding in your vehicle.
- (3) Subtract the combined weight of the driver and passengers from XXX kg or XXX lbs.
- (4) The resulting figure equals the available amount of cargo and luggage load capacity.

For example, if the “XXX” amount equals 1400 lbs. and there will be five 150 lb passengers in your vehicle, the amount of available cargo and luggage load capacity is 650 lbs. (1400 -

750 (5 × 150) = 650 lbs.)

(5) Determine the combined weight of luggage and cargo being loaded on the vehicle. That weight may not safely exceed the available cargo and luggage load capacity calculated in Step 4.

(6) If your vehicle will be towing a trailer, load from your trailer will be transferred to your vehicle. Consult this manual to determine how this reduces the available cargo and luggage load capacity of your vehicle. (→P.143)

Toyota does not recommend towing a trailer with your vehicle. Your vehicle is not designed for trailer towing.

**Calculation formula for your vehicle**

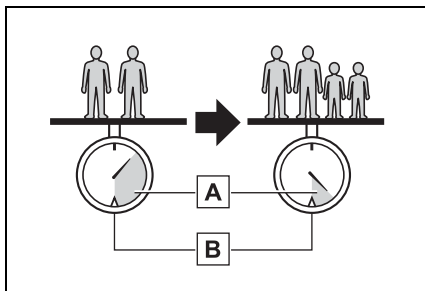

- A** Cargo capacity
- B** Total load capacity (vehicle capacity weight) (→P.380)

When 2 people with the combined weight of A lb. (kg) are riding in your vehicle, which has a

total load capacity (vehicle capacity weight) of B lb. (kg), the available amount of cargo and luggage load capacity will be C lb. (kg) as follows:

$$B^{*2} \text{ lb. (kg)} - A^{*1} \text{ lb. (kg)} = C^{*3} \text{ lb. (kg)}$$

\*1: A =Weight of people

\*2: B =Total load capacity

\*3: C =Available cargo and luggage load

In this condition, if 2 more passengers with the combined weight of D lb. (kg) get on, the available cargo and luggage load will be reduced E lb. (kg) as follows:

$$C \text{ lb. (kg)} - D^{*4} \text{ lb. (kg)} = E^{*5} \text{ lb. (kg)}$$

\*4: D =Additional weight of people

\*5: E =Available cargo and luggage load

As shown in the example above, if the number of occupants increases, the cargo and luggage load will be reduced by an amount that equals the increased weight due to the additional occupants. In other words, if an increase in the number of occupants causes an excess of the total load capacity (combined weight of occupants plus cargo and luggage load), you must reduce the cargo and luggage on your vehicle.

 **WARNING**

■ **Things that must not be carried in the trunk**

The following things may cause a fire if loaded in the trunk:

- Receptacles containing gasoline
- Aerosol cans

■ **Storage precautions**

Observe the following precautions.

Failure to do so may result in death or serious injury.

- Stow cargo and luggage in the trunk whenever possible.
- To prevent cargo and luggage from sliding forward during braking, do not stack anything in the enlarged trunk. Keep cargo and luggage low, as close to the floor as possible.
- When you fold down the rear seats, long items should not be placed directly behind the front seats.
- Never allow anyone to ride in the enlarged trunk. It is not designed for passengers. They should ride in their seats with their seat belts properly fastened. Otherwise, they are much more likely to suffer death or serious bodily injury, in the event of sudden braking, sudden swerving or an accident.

- Do not place cargo or luggage in or on the following locations as the item may get under the clutch (manual transmission), brake or accelerator pedal and prevent the pedals from being depressed properly, block the driver's vision, or hit the driver or passengers, causing an accident:

- At the feet of the driver
- On the front passenger or rear seats (when stacking items)
- On the package tray
- On the instrument panel
- On the dashboard

- Secure all items in the occupant compartment, as they may shift and injure someone during sudden braking, sudden swerving or an accident.

■ **Capacity and distribution**

- Do not exceed the maximum axle weight rating or the total vehicle weight rating.
- Even if the total load of occupant's weight and the cargo load is less than the total load capacity, do not apply the load unevenly. Improper loading may cause deterioration of steering or braking control which may cause death or serious injury.

**Vehicle load limits**

**Vehicle load limits include total load capacity, seating capacity, towing capacity and cargo capacity.**

- Total load capacity (vehicle capacity weight): →P.380

Total load capacity means the combined weight of occupants, cargo and luggage.

- Seating capacity: →P.380

Seating capacity means the maximum number of occupants whose estimated average weight is 150 lb. (68 kg) per person.

- Towing capacity

Toyota does not recommend towing a trailer with your vehicle.

- Cargo capacity

Cargo capacity may increase or decrease depending on the weight and the number of occupants.

■ **Total load capacity and seating capacity**

These details are also described on the tire and loading information label. (→P.323)

**⚠ WARNING**

■ **Overloading the vehicle**

Do not overload the vehicle. It may not only cause damage to the tires, but also degrade steering and braking ability, resulting in an accident.

**Trailer towing**

**Toyota does not recommend towing a trailer with your vehicle. Toyota also does not recommend the installation of a tow hitch or the use of a tow hitch carrier for a wheelchair, scooter, bicycle, etc. Your vehicle is not designed for trailer towing or for the use of tow hitch mounted carriers.**

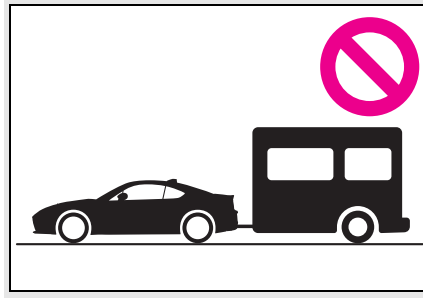

### Dinghy towing

Your vehicle is not designed to be dinghy towed (with 4 wheels on the ground) behind a motor home.

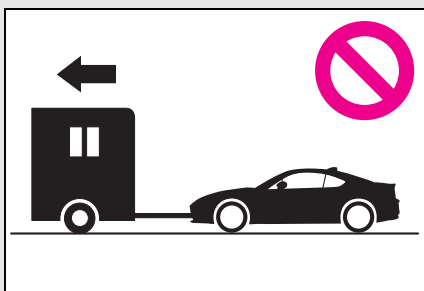

 NOTICE

■ **To avoid serious damage to your vehicle**

Do not tow your vehicle with the four wheels on the ground.



## Engine (ignition) switch

Performing the following operations when carrying the electronic key on your person starts the engine or changes engine switch modes.

### Starting the engine

- 1 Check that the parking brake is set.
- 2 Check that the shift lever is in P (automatic transmission) or N (manual transmission).
- 3 Firmly depress the brake pedal (automatic transmission) or clutch pedal (manual transmission).

 and a message will be displayed on the multi-information display.

If it is not displayed, the engine cannot be started.

- 4 Press the engine switch shortly and firmly.

When operating the engine switch, one short, firm press is enough. It is not necessary to press and hold the switch.

The engine will crank until it starts or for up to 10 seconds, whichever is less.

Continue depressing the brake pedal (automatic transmission) or clutch pedal (manual transmission) until the engine is completely started.

The engine can be started from any

engine switch mode.

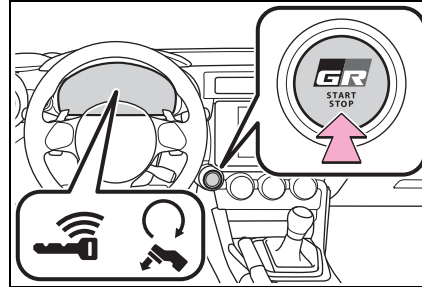

#### ■ If the engine does not start

- The engine immobilizer system may not have been deactivated. (→P.80)  
Contact your Toyota dealer.
- If a message related to start-up is shown on the multi-information display, read the message and follow the instructions.

#### ■ If the battery is discharged

The engine cannot be started using the smart key system. Refer to P.372 to restart the engine.

#### ■ Electronic key battery depletion

→P.102

#### ■ Conditions affecting operation

→P.112

#### ■ Notes for the entry function

→P.113

#### ■ Steering lock function

- After turning the engine switch off and opening and closing the doors, the steering wheel will be locked due to the steering lock function. Operating the engine switch again automatically cancels the steering lock.
- When the steering lock cannot be released, "Locked. Push Ignition Switch While Turning Steering Wheel" will be displayed on the multi-information display. Check that the shift lever is in P (automatic transmission) or N (manual transmission). Press the

engine switch while turning the steering wheel left and right.

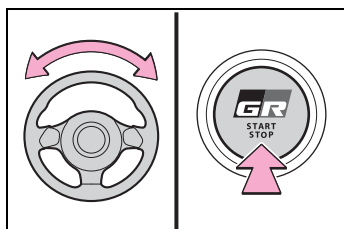

- To prevent the steering lock motor from overheating, operation of the motor may be suspended if the engine is turned on and off repeatedly in a short period of time. In this case, refrain from operating the engine switch. After about 10 seconds, the steering lock motor will resume functioning.

■ **When “Keyless Access System Disabled Check Owner’s Manual” is displayed on the multi-information display**

The system may be malfunctioning. Have the vehicle inspected by your Toyota dealer immediately.

■ **Electronic key battery**

→P.328

■ **Operation of the engine switch**

- If the switch is not pressed shortly and firmly, the engine switch mode may not change or the engine may not start.
- If attempting to restart the engine immediately after turning the engine switch off, the engine may not start in some cases. After turning the engine switch off, please wait more than 10 seconds before restarting the engine.

■ **If the smart key system has been disabled**

If the smart key system has been disabled, refer to P.370.

■ **Immediately after reconnecting the battery terminals due to replacing the battery and so forth**

The engine may not start. If this occurs, turn the engine switch to ON, and start the engine after waiting at least 10 seconds. Idling may be unstable immediately after the engine starts, however, this is not a malfunction.

**WARNING**

■ **When starting the engine**

Always start the engine while sitting in the driver’s seat. Do not depress the accelerator pedal while starting the engine under any circumstances.

Doing so may cause an accident resulting in death or serious injury.

■ **Caution while driving**

If engine failure occurs while the vehicle is moving, do not lock or open the doors until the vehicle reaches a safe and complete stop. Activation of the steering lock in this circumstance may lead to an accident, resulting in death or serious injury.

**NOTICE**

■ **When starting the engine**

- Do not race a cold engine.
- If the engine becomes difficult to start or stalls frequently, have your vehicle checked by your Toyota dealer immediately.
- Vehicles with an automatic transmission: Do not shift the shift lever while the starter is operating.

 NOTICE**■ Symptoms indicating a malfunction with the engine switch**

If the engine switch seems to be operating somewhat differently than usual, such as the switch sticking slightly, there may be a malfunction. Contact your Toyota dealer immediately.

**Stopping the engine**

## ▶ Automatic transmission

- 1 Stop the vehicle completely.
- 2 Set the parking brake (→P.156), and shift the shift lever to P.

Check the parking brake indicator is illuminated.

- 3 Press the engine switch.

The engine will stop, and the meter display will be extinguished.

- 4 Release the brake pedal and check that “ACCESSORY” or “IGNITION ON” is not shown on the meters.

## ▶ Manual transmission

- 1 Stop the vehicle completely.
- 2 Set the parking brake. (→P.156)

Check the parking brake indicator is illuminated.

- 3 Shift the shift lever to N. (→P.153)

- 4 Press the engine switch.

The engine will stop, and the meter display will be extinguished.

- 5 Release the brake pedal and check that “ACCESSORY” or “IGNITION ON” is not shown on the meters.

 WARNING**■ Stopping the engine in an emergency**

If you want to stop the engine in an emergency while driving the vehicle, press and hold the engine switch for more than 2 seconds, or press it briefly 3 times or more in succession. (→P.338)

However, do not touch the engine switch while driving except in an emergency. Turning the engine off while driving will not cause loss of steering or braking control, but the power assist to these systems will be lost. This will make it more difficult to steer and brake, so you should pull over and stop the vehicle as soon as it is safe to do so.

- If the engine switch is operated while the vehicle is running, a warning message will be shown on the multi-information display and a buzzer sounds.
- Vehicles with an automatic transmission: To restart the engine after performing an emergency shutdown, shift the shift lever to N and then press the engine switch.
- Vehicles with a manual transmission: To restart the engine after performing an emergency shutdown, depress the clutch pedal and then press the engine switch.

**Changing engine switch modes**

Modes can be changed by

pressing the engine switch with brake pedal (automatic transmission) or clutch pedal (manual transmission) released. (The mode changes each time the switch is pressed.)

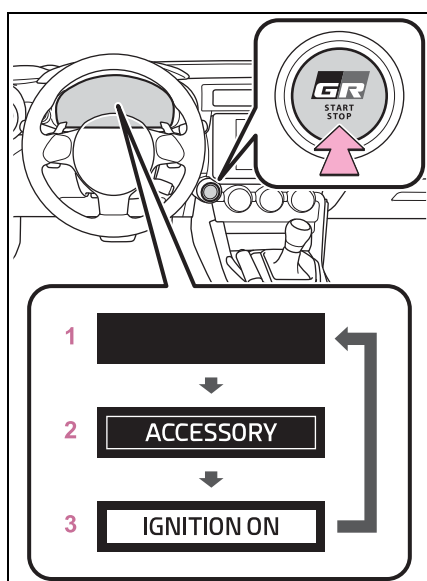

**1 OFF\***

The emergency flashers can be used.

**2 ACC**

Some electrical components such as the audio system can be used. "ACCESSORY" will be displayed on the meters.

**3 ON**

All electrical components can be used. "IGNITION ON" will be displayed on the meters.

\*: Vehicles with an automatic transmission: If the shift lever is in a position other than P when turning off the engine, the engine

switch will be turned to ACC, not to off.

**Auto power off function**

Automatic transmission: If the vehicle is left in ACC for more than 20 minutes or ON (the engine is not running) for more than an hour with the shift lever in P, the engine switch will automatically turn off. However, this function cannot entirely prevent battery discharge. Do not leave the vehicle with the engine switch in ACC or ON for long periods of time when the engine is not running.

Manual transmission: If the vehicle is left in ACC for more than 20 minutes or ON (the engine is not running) for more than an hour, the engine switch will automatically turn off. However, this function cannot entirely prevent battery discharge. Do not leave the vehicle with the engine switch in ACC or ON for long periods of time when the engine is not running.

**NOTICE**

**To prevent battery discharge**

- Do not leave the engine switch in ACC or ON for long periods of time without the engine running.
- If "ACCESSORY" or "IGNITION ON" is displayed on the meters while the engine is not running, the engine switch is not off. Exit the vehicle after turning the engine switch off.

**When stopping the engine with the shift lever in a position other than P (vehicles with an automatic transmission)**

If the engine is stopped with the shift lever in a position other

than P, the engine switch will not be turned off but instead be turned to ACC. Perform the following procedure to turn the switch off:

- 1 Check that the parking brake is set.
- 2 Shift the shift lever to P.
- 3 Check that "ACCESSORY" is displayed on the meters and press the engine switch shortly and firmly.
- 4 Check that "ACCESSORY" or "IGNITION ON" on the meters are off.

	<b>NOTICE</b>
<p><b>■ To prevent battery discharge</b></p> <p>Do not stop the engine when the shift lever is in a position other than P. If the engine is stopped in another shift lever position, the engine switch will not be turned off but instead be turned to ACC mode. If the vehicle is left in ACC, battery discharge may occur.</p>	

### Automatic transmission\*

\*: If equipped

**Select the shift position depending on your purpose and situation.**

### Shift position purpose and functions

Shift position	Objective or function
P	Parking the vehicle/starting the engine
R	Reversing
N	Neutral (Condition in which the power is not transmitted)
D	Normal driving* <sup>1</sup>
	Temporary manual mode driving (→P.151)
M	Manual mode driving* <sup>2</sup> (→P.152)

\*<sup>1</sup>: To improve fuel efficiency and reduce noise, shift the shift lever to D for normal driving.

\*<sup>2</sup>: Any gear range can be fixed when driving in Manual mode.

### ■ To protect the automatic transmission

If the automatic transmission fluid temperature is high, "Transmission Oil Temperature Check Owner's Manual" will be displayed on the multi-information display and the

vehicle will go into transmission protection mode automatically. Have the vehicle inspected by your Toyota dealer.

■ **When driving with Adaptive Cruise Control or Conventional Cruise Control activated**

Downshifting can be performed even when using Adaptive Cruise Control or Conventional Cruise Control. After downshifting, the set speed continues. (→P.151, 152)

■ **Automatic gear selection when the vehicle is stopped**

When the vehicle is idling at high rpm in order to warm up, and the vehicle is on a slippery road, the transmission may automatically shift to 2nd gear for stopping and starting off.

■ **AI-SHIFT**

- The AI-SHIFT automatically selects the suitable gear according to driver performance and driving conditions. The AI-SHIFT automatically operates when the shift lever is in D. (Shifting the shift lever to the M position cancels the function.)
- G AI-SHIFT automatically selects a suitable gear for sporty driving according to driver's input and driving conditions. G AI-SHIFT operates automatically when the shift lever is in D and sport mode is selected for the driving mode. (Selecting normal mode with the driving mode select switch or shifting the shift lever to the M position cancels this function.)

■ **After recharging/reconnecting the battery**

→P.373

**! WARNING**

■ **When driving on slippery road surfaces**

Be careful of downshifting and sudden acceleration, as this could result in the vehicle skidding to the side or spinning.

**Shifting the shift lever**

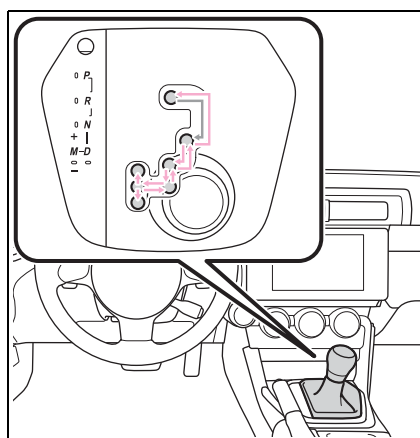

← While the engine switch is in ON, move the shift lever with the brake pedal depressed.

When shifting the shift lever between P and D, make sure that the vehicle is completely stopped.

■ **Shift lock system**

The shift lock system is a system to prevent accidental operation of the shift lever in starting. The shift lever can be shifted from P only when the engine switch is in ON and the brake pedal is being depressed.

■ **If the shift lever cannot be shifted from P**

First, check whether the brake pedal is being depressed.

If the shift lever cannot be shifted

with your foot on the brake pedal, there may be a problem with the shift lock system. Have the vehicle inspected by your Toyota dealer immediately.

The following steps may be used as an emergency measure to ensure that the shift lever can be shifted.

Releasing the shift lock:

- 1 Set the parking brake.
- 2 Turn the engine switch off.
- 3 Depress the brake pedal.
- 4 Pry the cover up with a flathead screwdriver or equivalent tool.

To prevent damage to the cover, cover the tip of the screwdriver with a rag.

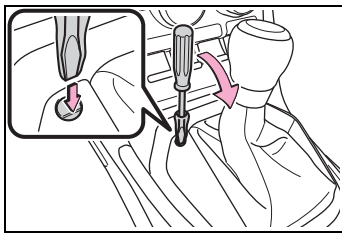

- 5 Press the shift lock override button.

The shift lever can be shifted while the button is pressed.

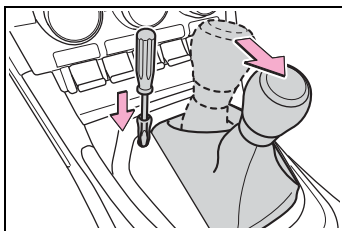

**! WARNING**

**■ To prevent an accident when releasing the shift lock**

Before pressing the shift lock override button, make sure to set the parking brake and depress the brake pedal.

If the accelerator pedal is accidentally depressed instead of the brake pedal when the shift lock override button is pressed and the shift lever is shifted out of P, the vehicle may suddenly start, possibly leading to an accident resulting in death or serious injury.

**Selecting the driving mode**

→P.258

**Temporary manual mode driving**

Temporary manual mode driving can be changed to by operating the paddle shift switches while the shift lever is in the D position.

When this occurs, the selected gear and “M” are displayed on the shift position and shift range indicator.

(When engine speed rises close to the red zone, upshifting will be automatically performed.)

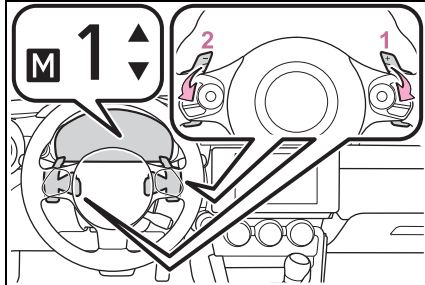

1 Upshifting

2 Downshifting

The selected shift range, from M1 to M6, will be displayed on the meter.

**Automatic deactivation of temporary manual mode driving in the D position**

Temporary manual mode driving in the D position will be deactivated in the following situations:

- When the vehicle speed is too low.
- When the accelerator pedal is depressed for more than a certain period of time.
- When the accelerator pedal is fully, or near-fully, depressed.
- When the shift lever is shifted to a position other than D.
- When the “+” paddle shift switch is operated for a certain amount of time continuously

**Downshifting restriction warning buzzer**

If downshifting operations are performed at a vehicle speed by which downshifting is not possible (when downshifting will cause the engine speed to enter the red zone), a buzzer will sound to warn the driver that downshifting cannot be performed.

**WARNING**

**To prevent incorrect operation**

Do not attach items such as accessories to the paddle shift switches. Doing so may unintentionally move the paddle shift switches.

**Manual mode driving**

To enter manual mode, shift the shift lever to the M position.

While the upshift/downshift indicator light is illuminated, gears can be selected by operating the shift lever or paddle shift switches, allowing you to drive in the gear of your choosing.

Even if upshifting operations are performed, if vehicle speed is too low for the requested gear, the gear will not change.

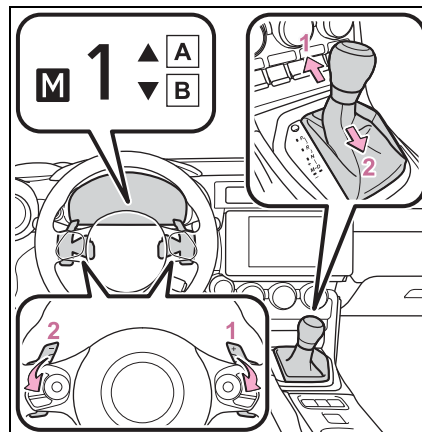

A Upshift indicator

B Downshift indicator

1 Upshifting (+)

2 Downshifting (-)



Each time the shift lever or paddle shift switches are operated, the gear changes up or down one gear and the selected gear, “1” through “6”, will be set.

The selected gear, from M1 to M6, will be fixed and displayed on the meter.

When in manual mode, the gear will not change unless the shift lever or paddle shift switches are operated.

However, even when in the manual mode, the gears will be automatically changed in the following situation:

- When vehicle speed drops (downshift only).
- When engine oil temperature is high and engine speed rises close to the red zone.

#### ■ Downshifting restriction warning buzzer

If downshifting operations are performed at a vehicle speed by which downshifting is not possible (when downshifting will cause the engine speed to enter the red zone), a buzzer will sound to warn the driver that downshifting cannot be performed.

#### **WARNING**

##### ■ To prevent incorrect operation

Do not attach items such as accessories to the paddle shift switches. Doing so may unintentionally move the paddle shift switches.

## Manual transmission\*

\*: If equipped

### Operating instructions

#### ■ Shifting the shift lever

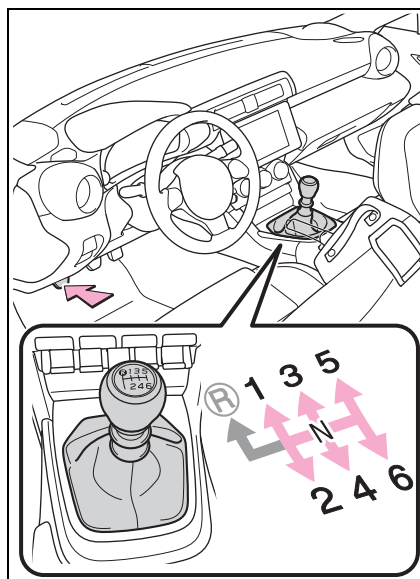

- 1 Depress the clutch pedal firmly.
- 2 Shift the shift lever to the desired gear.

Make sure to only shift gears sequentially.

- 3 Gradually release the clutch pedal.

If it is difficult to shift in R, shift the lever to N, release the clutch pedal momentarily, and then try again.

#### ■ Shifting the shift lever to R

Shift the shift lever to R while lifting up the ring section.

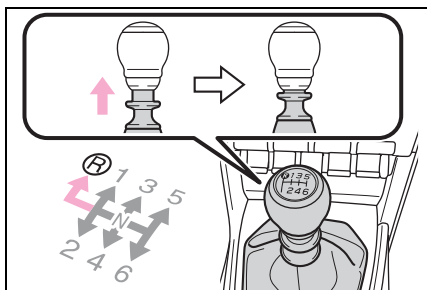

■ **Maximum allowable speeds**

Observe the following maximum allowable speeds in each gear when maximum acceleration is necessary.

Shift position	Maximum speed mph (km/h)
1	29 (46)
2	48 (76)
3	68 (108)
4	86 (138)
5	104 (167)
6	136 (218)

 **NOTICE**

■ **To prevent damage to the vehicle**

When shifting gears, observe the following precautions. Failure to do so may cause damage to the engine, manual transmission, and/or clutch.

- Do not shift the shift lever without depressing the clutch pedal.

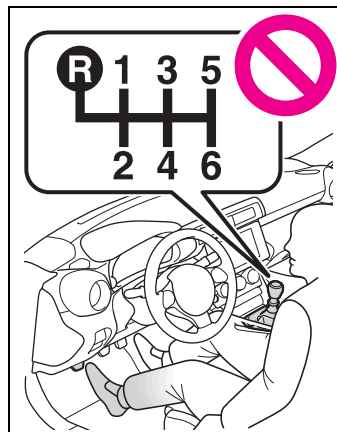

- Do not lift up the ring section except when shifting the lever to R.
- Shift the shift lever to R only when the vehicle is stationary.
- Do not rest your hand on or hold the shift lever any time other than when shifting.
- In order to not cause the engine to overrev, make sure to only shift gears sequentially.
- Do not release the clutch pedal suddenly.

**Shift position indicator**

The selected shift position will be displayed on the multi-information display.

The indicator can be turned on/off. (→P.400)

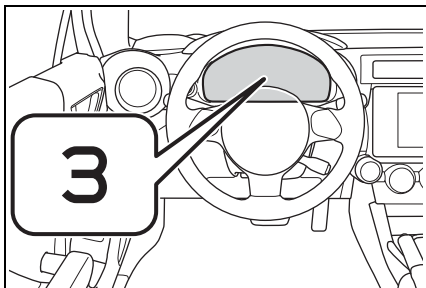

**Shift position indicator display**

The selected shift position will not appear in the following situations:

- When the shift lever is in N.
- When the vehicle speed is 6 mph (10 km/h) or less (except when the shift lever is in R).
- When the clutch pedal is depressed.

**Shift-up indicator**

To help enable fuel-efficient driving, shift-up indicator illuminate to indicate upshift timing.

The indicator can be turned on/off. (→P.400)

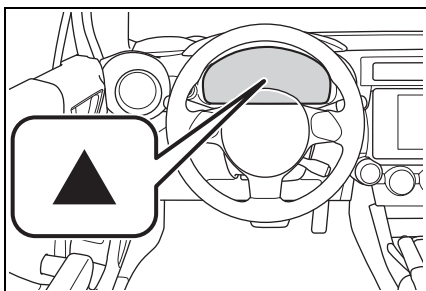

**Turn signal lever**

**Operating instructions**

The lever will return to its original position immediately after operation.

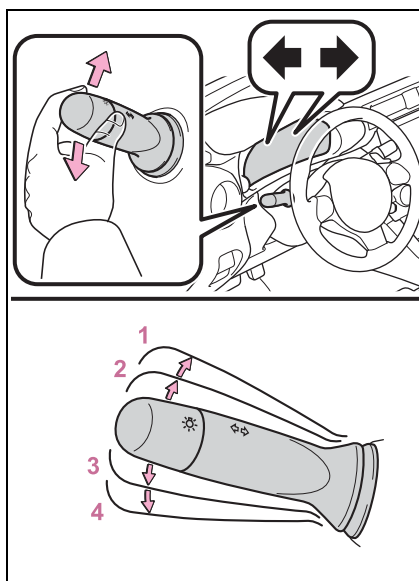

- 1 Right turn
- 2 Lane change to the right (move the lever partway and hold it\*)
- 3 Lane change to the left (move the lever partway and hold it\*)
- 4 Left turn

The right turn signal lights will blink until the lever is released.

The left turn signal lights will blink until the lever is released.

\*: When the turn signal lever is operated to position 2 or 3, if the lever is released immediately, the

turn signal lights will blink 3 times.

- **If the turn signals do not stop flashing after turning left or right, or if you want to stop them flashing**

Operate the lever in the opposite direction to either position 2 or 3. If you move the lever to either position 1 or 4, the selected turn signals will flash.

- **Turn signals can be operated when**

The engine switch is in ON.

- **If the indicator flashes faster than usual**

Check that a light bulb in the front or rear turn signal lights has not burned out.

- **If the turn signals stop flashing before a lane change has been performed**

Operate the lever again.

- **Customization**

Some functions can be customized. (→P.400)

## Parking brake

### Operating instructions

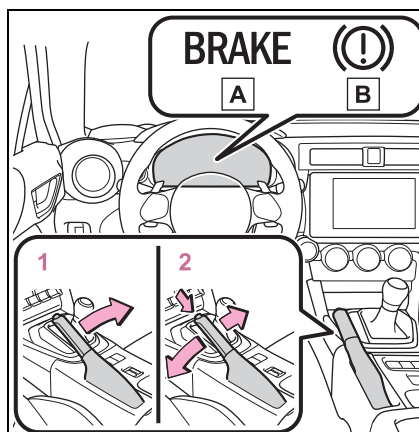

**A** U.S.A.

**B** Canada

- 1 To set the parking brake, fully pull the parking brake lever while depressing the brake pedal.
- 2 To release the parking brake, slightly raise the lever and lower it completely while pressing the button.

- **Parking the vehicle**

→P.132

- **If the brake system warning light comes on**

→P.348

- **Usage in winter time**

→P.266

**NOTICE****■ When parking the vehicle**

Before you leave the vehicle, set the parking brake, shift the shift lever to P (automatic transmission) or N (manual transmission) and make sure that the vehicle does not move.

**■ Before driving**

Fully release the parking brake. Driving the vehicle with the parking brake set will lead to brake components overheating, which may affect braking performance and increase brake wear.

**ASC (Active Sound Control)**

**The active sound control provides dynamic engine sounds. When driving with sport mode\* (→P.258) selected, the engine sounds will be particularly loud.**

\*: If equipped

**■ When changing the driving mode (vehicles with an automatic transmission)**

When the driving mode is changed, the sound of the active sound control will be stopped for approximately 1 second, this is not a malfunction.

**■ Customization**

Some functions can be customized. (→P.400)

### Headlight switch



The headlights can be operated manually or automatically.

### Operating instructions

Operating the  switch turns on the lights as follows:

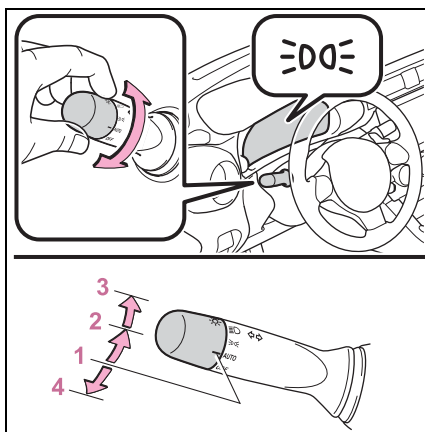
► For the U.S.A.







- 1  The headlights, parking/daytime running lights (→P.158) and all the lights listed above turn on and off automatically. (When the engine switch is in ON.)
- 2  The side marker, parking, tail, license plate, instrument panel lights and daytime running lights (→P.158) turn on.
- 3  The headlights and all lights listed above (except daytime running lights) turn

on.

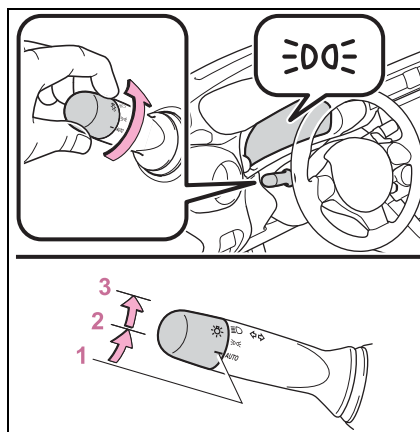
- 4  The daytime running lights turn on. (→P.158)

► For Canada



- 1  The headlights, parking/daytime running lights (→P.158) and all the lights listed above turn on and off automatically. (When the engine switch is in ON.)
- 2  The side marker, parking, tail, license plate, instrument panel lights and daytime running lights (→P.158) turn on.
- 3  The headlights and all lights listed above (except daytime running lights) turn on.

■ **AUTO mode can be used when**  
The engine switch is in ON.

■ **Daytime running light system**

- The daytime running lights illuminate using the same lights as the

parking lights and illuminate brighter than the parking lights.

- To make your vehicle more visible to other drivers during daytime driving, the daytime running lights turn on automatically when all of the following conditions are met. (The daytime running lights are not designed for use at night.)
  - The engine is running
  - The shift lever is shifted out of P (vehicles with an automatic transmission)
  - The parking brake is released
  - The headlight switch is in the OFF (U.S.A. only),  $\text{D}$  or  $\text{AUTO}^*$  position

\*: When the surroundings are bright  
The daytime running lights remain on after they illuminate, even if the parking brake is set again.

- When the turn signal indicators are flashing, the daytime running light on the side that the turn signals are flashing will turn off.
- When the emergency flashers are flashing, both daytime running lights will turn off.
- Compared to turning on the headlights, the daytime running light system offers greater durability and consumes less electricity, so it can help improve fuel economy.

■ **Headlight control sensor**

In the following situations, the automatic light control system may not operate correctly.

- When an object is placed on the sensor or something which blocks the sensor is affixed to the windshield
- When the surrounding area is lit by light other than natural light

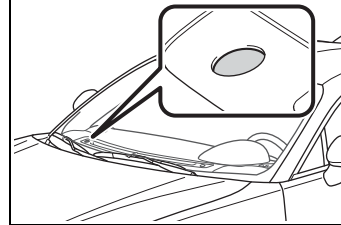

■ **Automatic light off system**

When the light switch is in  $\text{AUTO}$ : The headlights and tail lights turn off 30 seconds after a door is opened and closed if the engine switch is turned off. (The lights turn off immediately if  $\text{LOCK}$  on the key is pressed twice after both side doors are closed.)

To turn the lights on again, turn the engine switch to ON, or turn the light switch off once and then back to  $\text{D}$  or  $\text{D}$  (except for Canada).

■ **Light reminder buzzer**

A buzzer sounds when the engine switch is turned off and the driver's door is opened while the lights are turned on.

■ **Automatic headlight leveling system**

The level of the headlights is automatically adjusted according to the number of passengers and the loading condition of the vehicle to ensure that the headlights do not interfere with other road users.

■ **Windshield wiper linked headlight illumination**

When driving during daytime with the headlight switch turned to  $\text{AUTO}$ , if the windshield wipers are used, the headlights will turn on automatically after several seconds to help enhance the visibility of your vehicle.

■ **Battery-saving function**

In order to prevent the battery of the vehicle from discharging, if the headlights and/or tail lights are on

when the engine switch is turned off the battery saving function will operate and automatically turn off all the lights after approximately 20 minutes.

When any of the following are performed, the battery-saving function will be disabled.

- When the engine switch is turned to ACC or ON
- When the headlight switch is in the OFF position (U.S.A. only)
- When a door is opened or closed

■ **Welcome light illumination control**

The headlights and tail lights automatically turn on at night when the doors are unlocked using the wireless remote control if the light switch is in the AUTO position. The headlights and tail lights will turn off automatically after approximately 30 seconds.

■ **Customization**

Some functions can be customized. (→P.400)

	<b>NOTICE</b>
<p>■ <b>To prevent battery discharge</b></p> <p>Do not leave the lights on longer than necessary when the engine is not running.</p>	

**Turning on the high beam headlights**

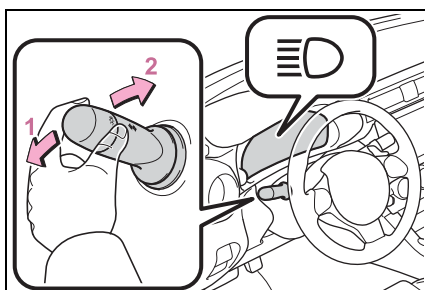

- 1 With the headlights on, push the lever away from you to turn on the high beams.

Vehicles without high beam assist: If the lever is pushed and released, the high beam headlights will turn on. Pull and release the lever to turn off the high beam headlights and turn on the low beam headlights.

Vehicles with high beam assist: If the lever is pushed and released with the headlight switch in AUTO position, the high beam assist will turn on. When the high beam assist is operating, the headlights will automatically change between the high beams and low beams according to the conditions. If the lever is pushed forward and released again, the high beam assist will turn off and the high beam headlights will turn on.

To manually turn the high beam headlights on, push and release the lever with the headlight switch in  position. If the lever is pulled and released, the high beam headlights will turn off and the low beam headlights will turn on.

- 2 Illuminate the high beam headlights while the lever is pulled

Even if the lights are off, the high beam headlights will illuminate. When the lever is released, the headlights will return to the low beam headlights or will turn off.



**SRH (Steering Responsive Headlights)\***

\*: If equipped

The SRH (Steering Responsive Headlights) is a function which, according to the steering wheel operation and vehicle speed when the vehicle is being driven forward, automatically adjusts the angle of the headlights to illuminate intersections and corners, improving visibility.

This function operates when the vehicle speed is 5 mph (8 km/h) or higher.

**■ Turning SRH off**

The SRH can be turned off through a setting on the meter. (→P.400)

When the SRH is off, the SRH OFF indicator will illuminate.

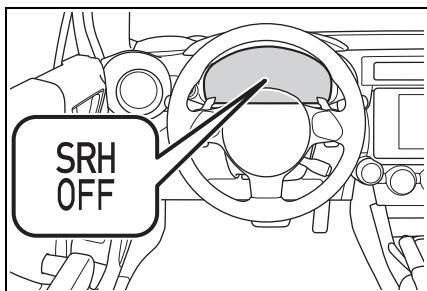
**■ SRH warning light**

If the SRH malfunctions, the SRH warning light will illuminate and a message will be displayed on the multi-information display. Have the vehicle inspected by your Toyota dealer as soon as possible. (→P.357)

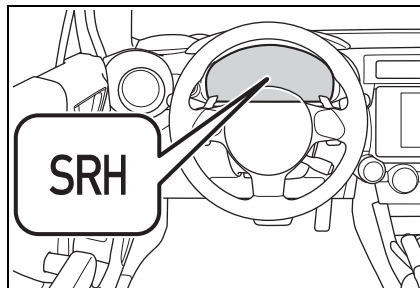
**■ Customization**

Some functions can be customized. (→P.400)

### High Beam Assist\*

\*: If equipped

The high beam assist uses the stereo camera located behind the upper portion of the windshield to assess the brightness of the lights of vehicles ahead, streetlights, etc., and automatically turns the high beams on or off as necessary.

#### WARNING

##### ■ Limitations of the high beam assist

Do not overly rely on the high beam assist. Always drive safely, taking care to observe your surroundings and turning the high beams on or off manually if necessary.

##### ■ To prevent incorrect operation of the high beam assist system

Do not overload the vehicle.

### Activating the high beam assist

Turn the headlight switch to **AUTO** position and push the lever forward.

After the lever is operated, it will immediately return to its original position.

The high beam assist will turn on and the high beam assist indicator will illuminate.

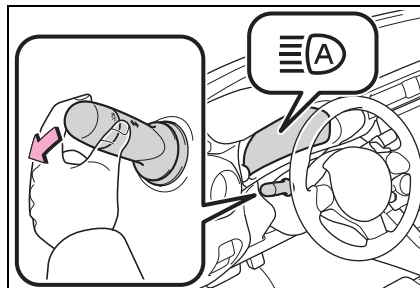

#### ■ Conditions to turn the high beams on/off automatically

- When all of the following conditions are met, the high beams will be turned on automatically (after approximately 1 second):
    - The vehicle speed is approximately 20 mph (32 km/h) or more.
    - The area ahead of the vehicle is dark.
    - There are no vehicles ahead with headlights or tail lights turned on.
    - There are few streetlights on the road ahead.
  - If any of the following conditions is met, the high beams will turn off automatically:
    - The vehicle speed is below approximately 10 mph (16 km/h).
    - The area ahead of the vehicle is not dark.
    - Vehicles ahead have their headlights or tail lights turned on.
    - There are many streetlights on the road ahead.
- #### ■ Stereo camera detection information
- If EyeSight is malfunctioning or temporarily disabled, the high beam assist will not operate, and the low beam headlights will turn on.
  - The high beams may not be automatically turned off in the following situations:
    - When a vehicle suddenly appears from around a curve
    - When the vehicle is cut in front of by another vehicle
    - When vehicles ahead cannot be

- detected due to repeated curves, road dividers or roadside trees
- When vehicles ahead appear in a faraway lane on a wide road
- When the lights of vehicles ahead are not on
- The high beams may be turned off if a vehicle ahead that is using fog lights without its headlights turned on is detected.
- House lights, street lights, traffic signals, and illuminated billboards or signs and other reflective objects may cause the high beams to change to the low beams, or the low beams to remain on.
- The following factors may affect the amount of time taken for the high beams to turn on or off:
  - The brightness of the headlights, fog lights, and tail lights of vehicles ahead
  - The movement and direction of vehicles ahead
  - When a vehicle ahead only has operational lights on one side
  - When a vehicle ahead is a two-wheeled vehicle
  - The condition of the road (gradient, curve, condition of the road surface, etc.)
  - The number of passengers and amount of luggage in the vehicle
  - When there is a lag in response due to the limitations of the detection range of the stereo camera
- The high beams may turn on or off unexpectedly.
- Bicycles or similar vehicles may not be detected.
- In the following situations the system may not be able to correctly detect the surrounding brightness level. This may cause the low beams to remain on or the high beams to flash or dazzle pedestrians or vehicles ahead. In such a case, it is necessary to manually switch between the high and low beams.
  - When driving in inclement weather (heavy rain, snow, fog, sandstorms, etc.)
  - When the windshield is obscured by fog, mist, ice, dirt, etc.
  - When the windshield is cracked or damaged
  - When the stereo camera is deformed or dirty
  - When the temperature of the stereo camera is extremely high
  - When the surrounding brightness level is equal to that of headlights, tail lights or fog lights
  - When headlights or tail lights of vehicles ahead are turned off, dirty, changing color, or not aimed properly
  - When the vehicle is hit by water, snow, dust, etc. from a preceding vehicle
  - When driving through an area of intermittently changing brightness and darkness
  - When frequently and repeatedly driving ascending/descending roads, or roads with rough, bumpy or uneven surfaces (such as stone-paved roads, gravel roads, etc.)
  - When frequently and repeatedly taking curves or driving on a winding road
  - When there is a highly reflective object ahead of the vehicle, such as a sign or mirror
  - When the back of a preceding vehicle is highly reflective, such as a container on a truck
  - When the vehicle's headlights are damaged or dirty, or are not aimed properly
  - When the vehicle is listing or titling due to a flat tire, a trailer being towed, etc.
  - Immediately after the engine is started
  - When the headlights are changed between the high beams and low beams repeatedly in an abnormal manner
  - When the driver believes that the high beams may be flashing or dazzling pedestrians or other drivers

**How to temporarily lower the sensitivity of the high beam assist function**

The sensitivity of the high beam assist function can be lowered by using the following operations.

- 1 After turning the engine switch to ON, turn the headlight switch to AUTO position and push the lever forward.
- 2 After the high beam assist indicator on the meter will illuminate, turn the engine switch off.
- 3 Turn the engine switch to ON and within approximately 15 seconds, press the  switch more than 10 times consecutively.

When the sensitivity of the high beam assist function is lowered, the high beam assist indicator on the meter will flash.

**■ The sensitivity of the high beam assist function**

- The sensitivity of the high beam assist function cannot be lowered in the following conditions:
  - Adaptive Cruise Control or Conventional Cruise Control indicator is illuminated.
  - The EyeSight warning light is illuminated.
- The sensitivity of the high beam assist function returns to normal level the next time the engine switch is turned off and the engine is restarted.

**Turning the high beams on/off manually**

**■ Switching to the low beams**

Turn the headlight switch to  position.

The high beam assist indicator will turn off.

To turn the high beam assist on again, turn the headlight switch to AUTO position.

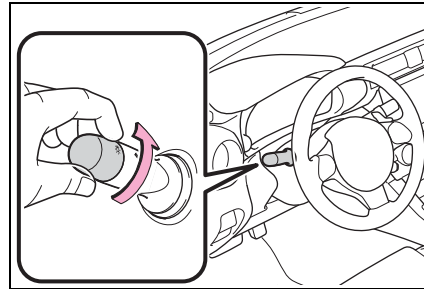

**■ Switching to the high beams**

Push the lever forward.

The high beam assist indicator will turn off and the high beam indicator will illuminate.

To turn the high beam assist on again, push the lever forward again.

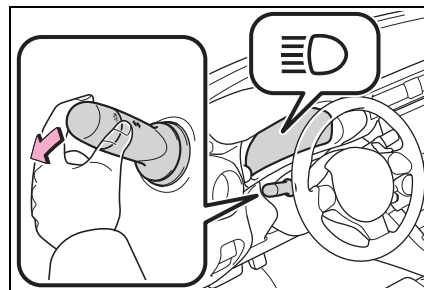



**Windshield wipers and washer**

**Operating the lever can use the windshield wipers or the washer.**

 NOTICE

**■ When the windshield is dry**  
Do not use the wipers, as they may damage the windshield.

**Operating the wiper lever**

Operating the  lever operates the wipers or washer as follows. When  is selected, the wipers will operate automatically in accordance with the vehicle speed.

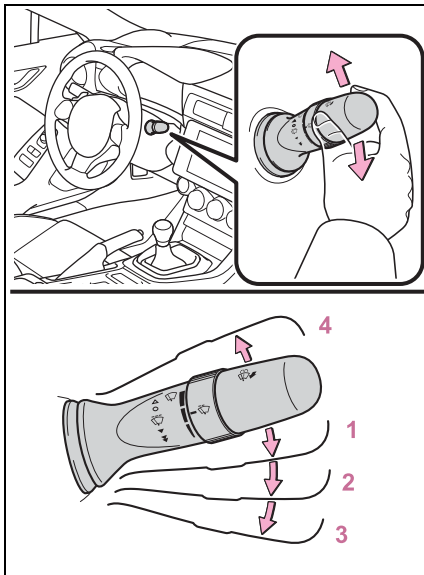

**1**  Intermittent windshield wiper operation

**2** ▼ Low speed windshield wiper operation

**3** ▼ High speed windshield wiper operation

**4** △ Temporary operation

Wiper intervals can be adjusted when intermittent operation is selected.

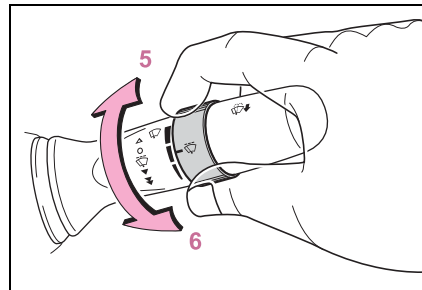

**5** Decreases the intermittent windshield wiper frequency

**6** Increases the intermittent windshield wiper frequency

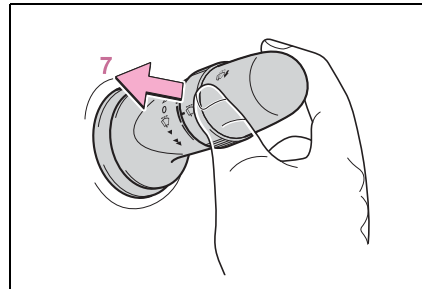

**7**  Washer/wiper dual operation

Pulling the lever operates the wipers and washer.

Wipers will automatically operate a couple of times after the washer squirts.

■ **The windshield wiper and washer can be operated when**

The engine switch is in ON.

■ **If no windshield washer fluid sprays**

Check that the washer nozzles are not blocked if there is washer fluid in the windshield washer fluid reservoir.

 **WARNING**

■ **Caution regarding the use of washer fluid**

When it is cold, do not use the washer fluid until the windshield becomes warm. The fluid may freeze on the windshield and cause low visibility. This may lead to an accident, resulting in death or serious injury.

 **NOTICE**

■ **When the washer fluid tank is empty**

Do not operate the switch continually as the washer fluid pump may overheat.

■ **When a nozzle becomes blocked**

In this case, contact your Toyota dealer. Do not try to clear it with a pin or other object. The nozzle will be damaged.

## Opening the fuel tank cap

Perform the following steps to open the fuel tank cap:

### Before refueling the vehicle

- Close both side doors and windows, and turn the engine switch off.
- Confirm the type of fuel.

#### ■ Fuel types

→P.388

#### ■ Fuel tank opening for unleaded gasoline

To help prevent incorrect fueling, your vehicle has a fuel tank opening that only accommodates the special nozzle on unleaded fuel pumps.

#### ■ If the malfunction indicator lamp illuminates

The malfunction indicator lamp may illuminate erroneously if refueling is performed repeatedly when the fuel tank is nearly full.

### WARNING

#### ■ When refueling the vehicle

Observe the following precautions while refueling the vehicle. Failure to do so may result in death or serious injury.

- Do not handle fuel indoors.

- After exiting the vehicle and before opening the fuel door, touch an unpainted metal surface to discharge any static electricity. It is important to discharge static electricity before refueling because sparks resulting from static electricity can cause fuel vapors to ignite while refueling.

- Always hold the grips on the fuel tank cap and turn it slowly to remove it. A whooshing sound may be heard when the fuel tank cap is loosened. Wait until the sound cannot be heard before fully removing the cap. In hot weather, pressurized fuel may spray out the filler neck and cause injury.

- Do not allow anyone that has not discharged static electricity from their body to come close to an open fuel tank.

- Do not allow anyone to approach the area of the vehicle near the fuel filler pipe while refueling is in progress.

- Do not inhale vaporized fuel. Fuel contains substances that are harmful if inhaled.

- Do not smoke while refueling the vehicle. Doing so may cause the fuel to ignite and cause a fire.

- Do not return to the vehicle or touch any person or object that is statically charged. This may cause static electricity to build up, resulting in a possible ignition hazard.

#### ■ When refueling

Observe the following precautions to prevent fuel overflowing from the fuel tank:

**⚠ WARNING**

- Securely insert the fuel nozzle into the fuel filler neck.
- Stop filling the tank after the fuel nozzle automatically clicks off.
- Do not top off the fuel tank.
- Turn the cap to the right until it clicks to ensure that it is fully tightened. If the cap is not securely tightened, fuel spillage could occur in the event of an accident, creating a fire hazard.

**⚠ NOTICE**

**■ Refueling**

- Do not spill fuel during refueling. Doing so may damage the vehicle, such as causing the emission control system to operate abnormally or damaging fuel system components or the vehicle's painted surface.
- Never add any cleaning agents to the fuel tank. The addition of a cleaning agent may cause damage to the fuel system.
- Immediately put fuel in the tank whenever the low fuel warning light illuminates. Engine misfires as a result of an empty tank could cause damage to the engine.

**Opening the fuel tank cap**

- 1 With the doors unlocked, press the center of the rear edge of the fuel filler door.

Push until you hear a click and take your hand away to slightly open the fuel filler door. Then open the door

fully by hand.

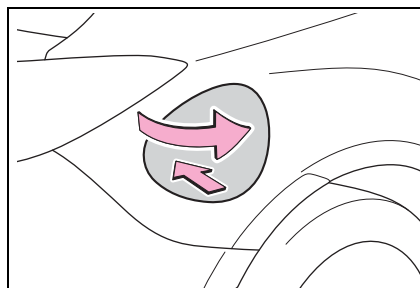

- 2 Turn the fuel tank cap slowly and remove it, then put it into the holder on the fuel filler door.

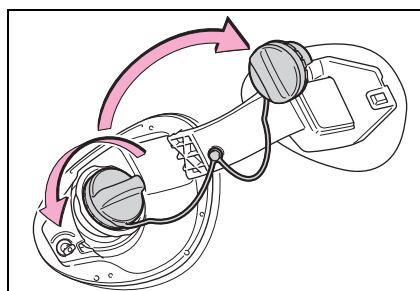

**■ When opening the fuel filler door**

The fuel filler door cannot be opened if the doors have been unlocked using a inside lock button.

Unlock the doors using the entry function, wireless remote control, or door lock switch. (→P.105, 106)

**■ If the fuel filler door cannot be opened**

→P.369

**Closing the fuel tank cap**

- 1 After refueling, turn the fuel tank cap until you hear a click. Once the cap is



released, it will turn slightly in the opposite direction.

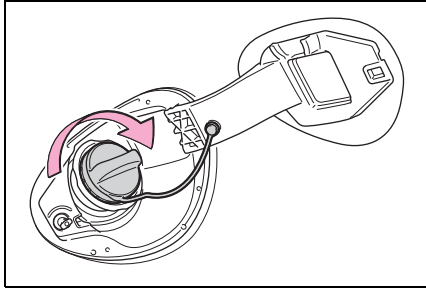

- 2** Close the fuel filler door, and press the center of the rear edge of the fuel filler door until you hear a click.

When you lock the doors, the fuel filler door will also lock.

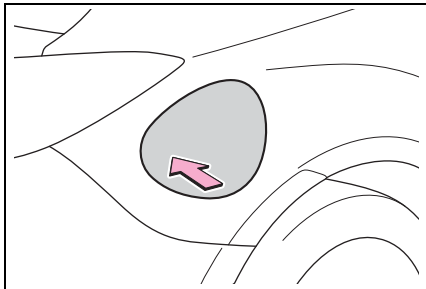

■ **When closing the fuel filler door**

Do not lock the doors before closing the fuel filler door, as the fuel filler door cannot be closed if the doors are locked. If the doors are locked and the fuel filler door cannot be closed, unlock the doors and then close the fuel filler door.

**! WARNING**

■ **When replacing the fuel tank cap**

Do not use anything but a genuine Toyota fuel tank cap designed for your vehicle. Doing so may cause a fire or other incident which may result in death or serious injury.

**EyeSight**<sup>\*1, 2</sup>

\*1: If equipped

\*2: EyeSight is a registered trademark of SUBARU CORPORATION.

**EyeSight is a driving support system that uses a range of functions to assist the driver in making decisions in order to provide for more safe and comfortable driving and to reduce driver fatigue. Making use of images created by the stereo camera, EyeSight detects vehicles, obstacles, traffic lanes and other items ahead.**

EyeSight records and stores the following data when Pre-Collision Braking System is operated. It does not record conversations or other audio data.

- Stereo camera image data
- Distance from the vehicle in front
- Vehicle speed
- Steering wheel turning angle
- Lateral movement with regards to the direction of travel
- Accelerator pedal operation status
- Brake pedal operation status
- Shift lever position
- Odometer reading
- Data related to ABS, VSC and TRAC

Toyota and third parties contracted by Toyota may acquire and use the recorded data for the purpose of vehicle research and development. Toyota and third parties contracted

by Toyota will not disclose or provide the acquired data to any other third party except under the following conditions.

- The vehicle owner has given his/her consent.
- The disclosure/provision is based on a court order or other legally enforceable request.
- Data that has been modified so that the user and vehicle cannot be identified is provided to a research institution for statistical processing or similar purposes.

 **WARNING**

Drivers are responsible for driving safely. Always comply with all traffic rules and regulations regardless of the fact that your vehicle is equipped with EyeSight. Always maintain a safe following distance between your vehicle and the vehicle in front of you, pay attention to your surroundings and driving conditions, and take necessary actions in order to maintain a safe following distance.

Never attempt to drive relying on EyeSight alone.

EyeSight is intended to assist the driver in making decisions in order to reduce the risk of accidents or damage and lessen the burden on the driver.

When an EyeSight warning is activated, pay attention to what is in front of you and to your surroundings, and take necessary actions. This system is not designed to support driving in poor visibility or in extreme weather conditions, or to protect against careless driving when the driver is not paying complete attention to the road ahead. It also cannot prevent collisions from occurring in all driving conditions.

**⚠ WARNING**

There are limits to the EyeSight recognition performance and control performance. Be sure to read the instructions for each function before using the system, and always use it properly. Improper use may lead to failure of control performance, which could cause an accident.

Refer to the following pages for each function:

- For Pre-Collision Braking System, refer to P.179.
- For Adaptive Cruise Control, refer to P.190.
- For Conventional Cruise Control, refer to P.207.
- For Pre-Collision Throttle Management, refer to P.215.
- For Lane Departure Warning, refer to P.220.
- For Lane Sway Warning, refer to P.222.
- For Lead Vehicle Start Alert, refer to P.224.

In left-hand drive vehicles, EyeSight is configured for driving on the right-hand side of the road. However, it can be reconfigured by changing the driving lane setting for driving on the left-hand side.\* (→P.400)

If the setting for the traffic lane (driving side of the road) does not match the traffic lane, full EyeSight performance may not be available.

\*: Characteristics and settings that are affected by specific differences between right-hand drive and left-hand drive vehicles cannot be changed.

- The system may not operate correctly under the conditions listed below. When these conditions occur, turn off Pre-Collision Braking System. Also, do not use Adaptive Cruise Control or Conventional Cruise Control.
  - The tire pressure is not correct.\*<sup>1</sup>
  - The temporary spare tire is installed.\*<sup>1</sup>
  - Tires that are unevenly worn or tires with uneven wear patterns are installed.\*<sup>1</sup>
  - Tires that are the wrong size are installed.\*<sup>1</sup>
  - A flat tire has been fixed temporarily with a tire repair kit.
  - The suspension has been modified (including a genuine Toyota suspension that has been modified).
  - An object that obstructs the stereo camera's view is installed on the vehicle.
  - Tire chains are installed.
  - The headlights are dirty or they have snow and ice or dirt on them. (Objects are not correctly illuminated and are difficult to detect.)
  - The optical axes are not aligned correctly. (Objects are not correctly illuminated and are difficult to detect.)

**⚠ WARNING**

- The lights including headlights and fog lights have been modified.
- Vehicle operation has become unstable due to an accident or malfunction.
- The brake system warning light is illuminated in red.<sup>\*2</sup>
- A heavy cargo is inside the vehicle.
- The maximum number of occupants is exceeded.
- The meter is not operating properly; such as when the lights do not illuminate, the beeps do not sound, the display is different from when it is normal, etc.<sup>\*3</sup>
- The system will not operate correctly in the following conditions. Do not use Adaptive Cruise Control or Conventional Cruise Control.
  - The wheels are out of balance (e.g., the balance weight is removed or misaligned).<sup>\*1</sup>
  - The wheels are out of alignment.<sup>\*1</sup>
  - A trailer or another vehicle, etc. is being towed.

<sup>\*1</sup>: The wheels and tires have functions that are critically important. Be sure to use the correct ones. (→P.386)

<sup>\*2</sup>: If the brake system warning light (red) does not turn off, immediately pull the vehicle over in a safe place and contact a Toyota dealer to have the system inspected.

<sup>\*3</sup>: For details about the meter, refer to P.88.

**⚠ NOTICE**

- The characteristics of the stereo camera are similar to those of human eyes. For this reason, conditions that make it difficult for the driver to see in the forward direction have the same effect on the stereo camera. They also make it difficult for the system to detect vehicles, obstacles, and traffic lanes.
- Detection by the EyeSight system is limited to objects that are within the range of the stereo camera's field of view. Also, after an object enters the range of the camera's field of view, it may take some time for the system to detect it as a controllable target and to warn the driver.

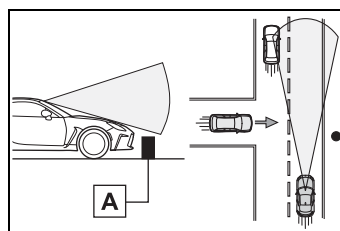

**A** Low objects surrounding the vehicle cannot be detected.



## NOTICE

- Under the conditions listed below, it will become more difficult for the system to detect the vehicle in front, motorcycles, bicycles, pedestrians and obstacles on the road, and lane markers. Also, EyeSight may temporarily stop operating. However, the temporary stop will be canceled once these conditions have improved and the vehicle is driven for a short period of time.
- Bad weather (for example heavy rain, a blizzard or thick fog). In particular, the system is more likely to temporarily stop operating when there is an oil film adhering to the windshield, a glass coating has been applied, or poorly performing wipers are used.
- Strong light is coming from the front (sunlight or headlight beams of oncoming traffic, etc.).
- The windshield washer is in use.
- Raindrops, water drops, or dirt on the windshield are not wiped off sufficiently.
- The windshield has become fogged, scratched or smeared, or snow, dirt, dust or frost has adhered to it, or it is otherwise affected. These will reduce the stereo camera's field of view. Also, light is reflecting off the dirt, etc.
- The vehicle is tilted at an extreme angle due to loaded cargo or other factors.
- Visibility is poor due to sand, smoke or water vapor blowing in the wind, or the front vision is obscured due to water splashes, snow, dirt or dust stirred up generated by the vehicle in front or oncoming traffic.
- The stereo camera's field of view is obstructed.
- Through the entrance or exit of a tunnel
- The rear aspect of the vehicle in front is low, small or irregular (for example a low bed trailer, etc.).
- The obstacle is a fence, a wall or a shutter, etc. with a uniform pattern (a striped pattern, brick, etc.) or with no pattern in front.
- The obstacle is a wall or door made of glass or a mirror in front.
- Driving at night or in a tunnel when there is a vehicle in front that does not have its taillights on
- Driving through a banner or flag, low branches on a tree or thick/tall vegetation
- On steep uphill or downhill grades
- The stereo camera is obstructed by a hand, etc. (If even one of the lenses is obstructed, the system does not operate properly.)
- It is completely dark and no objects are detected.
- The area around the vehicle has a uniform color (such as when completely covered in snow, etc.).

**NOTICE**

- Accurate detection is not possible due to reflections in the windshield.
- Under the conditions listed below, EyeSight may temporarily stop operating. If this occurs, EyeSight will resume operating when the conditions improve.
- The temperature inside the vehicle is high, such as after the vehicle was left in bright sunshine, or the temperature inside the vehicle is low, such as after the vehicle was left in an extremely cold environment.
- Immediately after the engine starts
- Under the conditions listed below, it is difficult to recognize vehicles in front, motorcycles, pedestrians, obstacles on the road, traffic lanes, etc. Also, the EyeSight system may temporarily stop operating. If the EyeSight system repeatedly stops operating several times, contact a Toyota dealer and have the system inspected.
- The stereo camera lenses are smeared such as from fingerprints.
- The stereo camera has become misaligned due to a strong impact.
- When there is a malfunction in the EyeSight system, turn off Pre-Collision Braking System (→P.189) and Lane Departure Warning (→P.221), and stop using Adaptive Cruise Control and Conventional Cruise Control. Contact a Toyota dealer and have the system inspected.

- When the slip indicator is illuminated, Pre-Collision Braking System may not operate properly. If the slip indicator is illuminated, turn off Pre-Collision Braking System. Also, do not use Adaptive Cruise Control or Conventional Cruise Control.

### Handling of the stereo camera

The stereo camera is located on the interior lights unit.

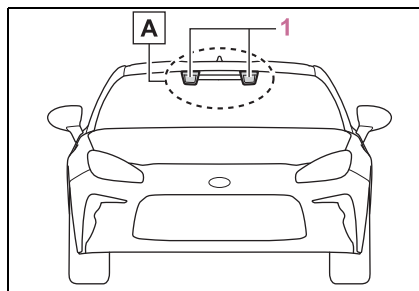

1 Stereo camera

 NOTICE

- The stereo camera monitors and detects smears or blurs on the front of the camera. However, detection is not 100% accurate. Under certain conditions, the function may fail to detect smears or blurs on the front of the stereo camera accurately. In addition, this function may not detect that there is snow or ice on the windshield close to the stereo camera. In such conditions, be sure to keep the windshield clean at all times (indicated by **A**). Otherwise the system may not operate correctly. When this function detects that the front of the stereo camera is smeared or blurred, no EyeSight functions can be activated except for Conventional Cruise Control.
- The stereo camera lenses are precision components. Always observe the following precautions especially when handling them.
  - Never touch the stereo camera lenses, and do not attempt to wipe or clean the lenses. Doing so could damage or soil the lens, and lead to improper system performance. If you ever touch a lens for any reason, be sure to contact your Toyota dealer.
  - When cleaning the windshield, cover the front of the camera casing with paper that does not collect dust, such as copy paper. Affix the paper to prevent glass cleaner from getting on the camera lenses. At this point, make sure that the tape's adhesive surface does not come in contact with the windshield or the lens. Be sure to remove the paper after cleaning.

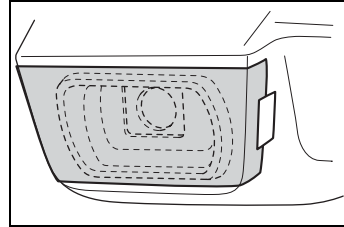

- When having the inside of windshield cleaned at a service station, etc., be sure to request that the attendant covers the camera covers before washing the vehicle.
- Do not subject the stereo camera to a strong impact.
- Do not remove or disassemble the stereo camera.
- Do not change the positions where the stereo camera is installed or modify any of the surrounding structures.
- Do not install an interior rearview mirror other than a genuine Toyota rearview mirror (such as a wide-type mirror) and the sun visor. Also, use the rearview mirror so that it does not obstruct the stereo camera. Failure to do so may affect the stereo camera's field of view and could prevent the EyeSight system from functioning properly.

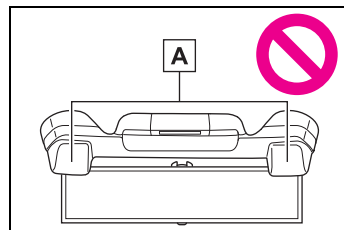

**A** Stereo camera

 NOTICE

- Do not install any accessories other than the ones designated by Toyota on the prohibited areas shown in the illustrations (grey zones).

Even if some accessories are installed on the outside of the prohibited areas, abnormal operation of EyeSight may occur due to the reflection of the light or any objects. In this situation, move the accessories. For details, contact your Toyota dealer.

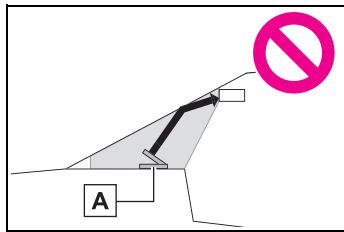
- Side view



**A** Monitors or other accessories

- Front view

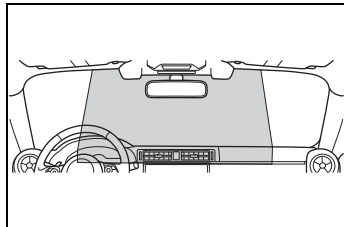

- Do not place any objects on top of the instrument panel. The stereo camera may not be able to detect objects accurately and the EyeSight system may not function properly due to reflections in the windshield. For details, contact your Toyota dealer.

- If the top of the instrument panel is polished with chemicals or other substances, the stereo camera may not be able to detect objects accurately and the EyeSight system may not operate properly due to reflections in the windshield.

- Do not install any wiper blades other than genuine Toyota wiper blades. Doing so may affect the stereo camera's field of view and could prevent the EyeSight system from functioning properly.

- Replace damaged wiper blades or worn wiper blade rubbers as soon as possible. Using damaged wiper blades or worn wiper blade rubbers may cause streaking on the windshield. The stereo camera may not be able to detect objects accurately and the EyeSight system may not function properly due to streaks or droplets remaining on the windshield.

- Do not install any accessories on the front side such as on the hood or the grille. It may affect the camera view and the system may not operate correctly.

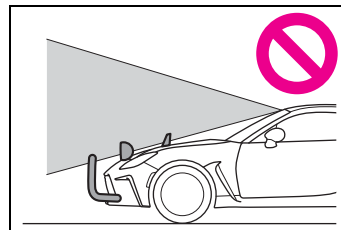

- Make sure that the stereo camera's field of view is not interfered. Obstructing the stereo camera's view may impair the system operation. For details, contact your Toyota dealer.



**NOTICE**

- Keep the windshield (outside and inside) clean at all times. When the windshield has become fogged, or it has a dirt or an oil film on it, the stereo camera may not detect objects accurately and the EyeSight system may not operate correctly. Never mount any device to the center air vent, as any air-flow change may impact EyeSight performance.
- Do not place any stickers or accessories on the windshield (outside or inside). If you have to do so (for example, legally required or electronic toll tag), avoid the area directly in front of the camera. Otherwise, it may adversely affect the field of view of the stereo camera and can cause improper operation of the system. For details, contact a Toyota dealer.
- Do not use any glass coating agents or similar substances on the windshield. Doing so may interfere with the proper operation of the system.
- Do not install any film or an additional layer of glass on the windshield. The system may not operate correctly.
- If there are scratches or cracks on the windshield, contact a Toyota dealer.
- To have the windshield replaced or repaired, contact a Toyota dealer. Do not install a windshield other than a genuine Toyota windshield. The stereo camera may not be able to detect objects accurately and the EyeSight system may not operate properly.

**EyeSight functions**

EyeSight includes the following functions.

**■ Pre-Collision Braking System**

This function uses a following distance warning feature to warn the driver to take evasive action when there is the possibility of a collision with a vehicle, pedestrian or obstacle in front of you. If the driver does not take evasive action, the brakes are applied automatically to help reduce vehicle collision damage or, if possible, help prevent a collision. (→P.179)

**■ Adaptive Cruise Control**

This function maintains the set vehicle speed and when there is a vehicle in front in the same traffic lane, it follows the speed of the vehicle in front up to the maximum of the set vehicle speed. (→P.190)

**■ Conventional Cruise Control**

In this mode, the system maintains a constant vehicle speed. It does not follow the vehicle in front. This function can be used even when the stereo camera has temporarily stopped operating (→P.229). This function is used by switching from Adaptive Cruise Control to Conventional Cruise Control. (→P.207)

### ■ Pre-Collision Throttle Management

This function reduces accidental forward movement caused by the shift lever being placed in the wrong position or the accelerator pedal being accidentally depressed, or depressed too strongly. (→P.215)

### ■ Lane Departure Warning

This function warns the driver when the vehicle is about to drift off the road. (→P.220)

### ■ Lane Sway Warning

This function warns the driver when it detects vehicle drifting caused by driver fatigue, failure to concentrate on the road, inattention, strong crosswinds or other factors. (→P.222)

### ■ Lead Vehicle Start Alert

This function notifies the driver when the vehicle stopped in front starts moving but the driver's vehicle remains stationary. (→P.224)

EyeSight does not operate when the engine is not running.

### Switch layout

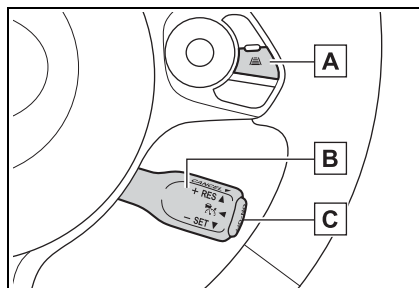

**A** (Following distance setting) switch

**B** Cruise control switch

**C** "ON-OFF" switch

### ■ Cruise control switch

- "ON-OFF" switch
  - Press this switch to turn cruise control\* on/off.
  - When the "ON-OFF" switch is pressed, appears on the meter display, and then appears by pressing and holding the (Following distance setting) switch for approximately 2 seconds. When or is shown on the meter display, this indicates that the main cruise control is on. (→P.196, 208)
- "- SET" (push the cruise control switch down)
  - Push this switch down to set cruise control\*. (→P.196, 208)
  - Push this switch down to reduce the set vehicle speed (when cruise control\* is currently set). (→P.201, 211)

- “+ RES” (push the cruise control switch up)
- Push this switch up to set cruise control\*. (→P.196, 208)
- After cruise control\* is canceled, push this switch up to resume the cruise control function at the vehicle speed that was previously set. (→P.205, 214)
- Push this switch up to increase the set vehicle speed (when cruise control\* is currently set). (→P.200, 211)
- “CANCEL” (pull the cruise control switch toward you)

Pull this switch to cancel cruise control\*. (→P.203, 212)

\*: Adaptive Cruise Control and Conventional Cruise Control

#### ■ (Following distance setting) switch

- Press this switch to select the set following distance in 4 stages (only when Adaptive Cruise Control is on). (→P.202)
- When the main cruise control is on, switching between Adaptive Cruise Control and Conventional Cruise Control is possible by pressing the  (Following distance setting)switch\*.

\*: To switch to Conventional Cruise Control, press and hold the switch for approximately 2 seconds or longer.

## Pre-Collision Braking System\*

\*: If equipped

**When there is the risk of a rear-end collision with an obstacle or pedestrian in front, the EyeSight system helps to prevent or minimize a collision by warning the driver. If the driver still does not take evasive action to avoid a collision, the brakes can be automatically applied just before the collision in order to reduce impact damage, or if possible, prevent the collision. If the driver takes evasive action to avoid a collision, Pre-Collision Braking Assist will operate in order to help the driver to prevent or minimize the collision.**

**This function can be activated when the shift lever is in the D, M or N position.**

Some unusual noises may be audible during automatic braking. This is caused by the braking control and is normal.

**WARNING**

- Never use Pre-Collision Braking System and Pre-Collision Braking Assist to stop your car or avoid a collision under ordinary conditions. These functions cannot prevent collisions under all conditions. If the driver relies only on Pre-Collision Braking System for Brake operation, collisions may occur.
  - When a warning is activated, pay attention to the front of the vehicle and its surroundings, and operate the brake pedal and/or take other actions if necessary.
  - The EyeSight Pre-Collision Braking System is primarily designed to prevent rear-end collisions with other vehicles when possible or to minimize damage and injuries in the event of a collision. In addition to other vehicles, things such as motorbikes, bicycles and pedestrians can also be treated as obstacles. However, there may be cases when detection is not possible depending on a variety of conditions<sup>\*2</sup>. For example, when a vehicle is viewed from the side, oncoming vehicle, vehicles approaching in reverse, small animals or children, or walls or doors are not likely to be detected.
  - Pre-Collision Braking System will operate at the point when it determines that a collision cannot be avoided and is designed to apply strong braking force just before a collision. The result of this varies depending on a variety of conditions<sup>\*2</sup>. Because of this, performance of this function will not always be the same.
- When Pre-Collision Braking System is activated, it will continue to operate even if the accelerator pedal is partially depressed. However, it will be canceled if the accelerator pedal is suddenly or fully depressed.
  - If the driver depresses the brake pedal or turns the steering wheel, the system may determine that this constitutes evasive action by the driver, and the automatic braking control may not activate in order to allow the driver full control.
  - When the difference in speed with the obstacle in front is the following figure<sup>\*1</sup> or more, it may not be possible to avoid a collision. Even if the speed difference is the following figure<sup>\*1</sup> or less, in cases such as when another vehicle cuts in front of you, or in other cases depending on visibility, the condition of road surface and other factors<sup>\*2</sup>, the function may be unable to stop the vehicle or may not activate. Pre-Collision Braking Assist also may not activate depending on the conditions<sup>\*2</sup> listed below.
- <sup>\*1</sup>: For vehicles: approximately 30 mph (50 km/h),  
For pedestrians: approximately 20 mph (35 km/h)
- <sup>\*2</sup>: Conditions in which Pre-Collision Braking System cannot detect obstacles:
- Distance to obstacle in front of you, speed difference, proximity conditions, lateral displacement (the amount of offset)
  - Vehicle conditions (amount of load, number of occupants, etc.)

**⚠ WARNING**

- Road conditions (grade, slipperiness, shape, bumps, etc.)
- Visibility ahead is poor (rain, snow, fog or smoke, etc.)
- The detected object is something other than a vehicle, motorcycle, bicycle or pedestrian.
  - A domestic animal or other animal (a dog or deer, etc.)
  - A guardrail, telephone pole, tree, fence or wall, etc.
- Even if the obstacle is a motorcycle, bicycle or pedestrian, depending on the brightness of the surroundings as well as the relative movement, and aspect or angle of the object, there may be cases when the system cannot detect it.
- The system determines that operation by the driver (based on accelerator pedal operation, braking, steering wheel angle, etc.) is intended as evasive action.
- Vehicle maintenance status (brake systems, tire wear, tire pressure, whether a temporary spare tire is being used, etc.)
- A trailer or another vehicle, etc. is being towed.
- The brakes are cold due to the outside temperature being low or just after starting the engine.
- The brakes are overheated on downhill grades (braking performance is reduced).
- In rain or after washing the vehicle (the brakes are wet and braking performance is reduced.)

- Recognition conditions of the stereo camera

In particular, the function may be unable to stop the vehicle or may not activate in the following cases.

- Bad weather (for example heavy rain, a blizzard or thick fog)
- Visibility is poor due to sand, smoke or water vapor blowing in the wind, or the front vision is obscured due to water splashes, snow, dirt or dust stir up generated by the vehicle in front or oncoming traffic.
- At night or in a tunnel without the headlights on
- At night or in a tunnel when there is a vehicle in front that does not have its taillights on
- Approaching a motorcycle, bicycle or pedestrian at night
- Ambient light is poor in the evening or early morning.
- A vehicle, motorcycle, bicycle or pedestrian is outside the area illuminated by the headlights.
- Strong light is coming from the front (for example, sunlight at dawn, sunset or headlight beams, etc.).
- The windshield has become fogged, scratched or smeared, or snow, dirt, dust or frost has adhered to it, or it is otherwise affected. These will reduce the stereo camera's field of view. Also, light is reflecting off the dirt, etc.

**⚠ WARNING**

— Fluid has not been fully wiped off the windshield during or after washer use.

— The target cannot be correctly recognized because the stereo camera's view is obstructed by water droplets from rain or the window washer, or by the wiper blades.

— The stereo camera's field of view is obstructed.

— The rear aspect of the vehicle in front is low, small or irregular (the system may recognize another part of the vehicle as its rear and will determine operation from that).

- There is an empty truck or trailer with no rear and/or side panels on the cargo bed.
- Vehicles that have cargo protruding from their back ends
- Non-standard shaped vehicles (vehicle transporters or vehicles with a sidecar fitted, etc.)
- The height of the vehicle is low, etc.

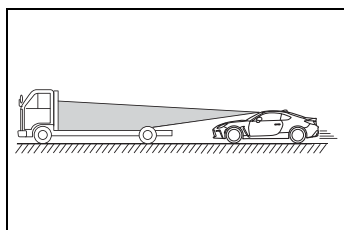

— There is a wall, etc. in front of a stopped vehicle.

— There is another object near the vehicle.

— A vehicle, etc. has its side facing you.

— With vehicles that are backing up or with oncoming vehicles, etc.

— The size and height of an obstacle is smaller than the limitations of the stereo camera's recognition capability.

- With small animals or children, etc.
- With pedestrians who are sitting or lying down

— The detected object is a fence or wall, etc. with a uniform pattern (a striped pattern or brick pattern, etc.).

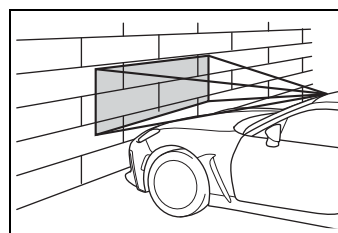

— There is a wall or door made of glass or a mirror in front.

— The vehicle in front suddenly swerves, accelerates, or decelerates.

— A vehicle, motorcycle, bicycle or pedestrian suddenly cuts in from the side or suddenly runs in front of you.

— Your vehicle is immediately behind an obstacle after changing lanes.

— There is a vehicle, motorcycle, bicycle or pedestrian in a location close to your vehicle's bumper.

**⚠ WARNING**

— The speed difference between your vehicle and an obstacle is 4 mph (5 km/h) or less (As braking is performed once the obstacle is in close proximity to your vehicle, depending on the shape and size of the obstacle, there may be some cases when the obstacle is outside the range of the camera's field of view.).

— On sharp curves, steep uphill grades or steep downhill grades

— On a bumpy or unpaved road

— There are changes in brightness, such as at a tunnel entrance or exit.

- Do not test Pre-Collision Braking System on its own. It may operate improperly and cause an accident.
- The system may not operate correctly under the conditions listed below. When these conditions occur, turn off Pre-Collision Braking System. (→P.189)
- The tire pressure is not correct.\*1
- The temporary spare tire is installed.\*1
- Tires that are unevenly worn or tires with uneven wear patterns are installed.\*1
- Tires that are the wrong size are installed.\*1
- A flat tire has been fixed temporarily with a tire repair kit.

- The suspension has been modified (including a genuine Toyota suspension that has been modified).
- An object that obstructs the stereo camera's view is installed on the vehicle.
- Tire chains are installed.
- The headlights are dirty or they have snow and ice or dirt on them. (Objects are not correctly illuminated and are difficult to detect.)
- The optical axes are not aligned correctly. (Objects are not correctly illuminated and are difficult to detect.)
- The lights including headlights and fog lights have been modified.
- Vehicle operation has become unstable due to an accident or malfunction.
- The brake system warning light is illuminated in red.\*2
- A heavy cargo is inside the vehicle.
- The maximum number of occupants is exceeded.
- The meter is not operating properly; such as when the lights do not illuminate, the beeps do not sound, the display is different from when it is normal, etc.\*3

\*1: The wheels and tires have functions that are critically important. Be sure to use the correct ones. (→P.386)

**⚠ WARNING**

\*2: If the brake system warning light (red) does not turn off, immediately pull the vehicle over in a safe place and contact a Toyota dealer to have the system inspected.

\*3: For details about the meter, refer to P.88.

**⚠ NOTICE**

In the following situations, turn off Pre-Collision Braking System. Otherwise Pre-Collision Braking System may activate unexpectedly.

- The vehicle is being towed.
- The vehicle is being loaded onto a carrier.
- A chassis dynamometer, free-rollers or similar equipment is being used.
- A mechanic lifts up the vehicle, starts the engine and spins the wheels freely.
- Passing hanging banners, flags or branches
- Thick/tall vegetation is touching the vehicle.
- Driving on a race track
- In a drive-through car wash

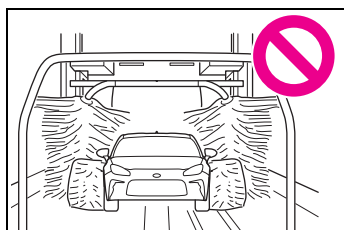

Pre-Collision Braking System may activate in the following situations. Therefore concentrate on safe driving.

- Passing through an automatic gate (opening and shutting)
- Driving close to the vehicle in front
- Driving in a location where the grade of the road changes rapidly

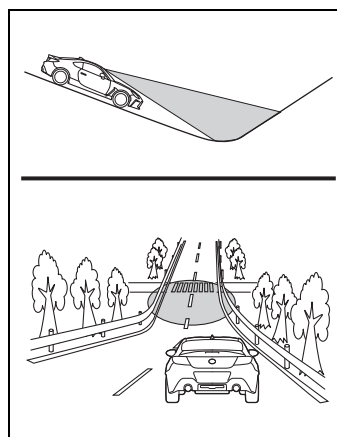

- Visibility is poor due to sand, smoke or water vapor blowing in the wind, or the front vision is obscured due to water splashes, snow, dirt or dust stir up generated by the vehicle in front or oncoming traffic.
- Passing through clouds of steam or smoke, etc.
- In adverse weather, such as heavy snow or snowstorms



 NOTICE

- The exhaust gas emitted by the vehicle in front is clearly visible in cold weather, etc.

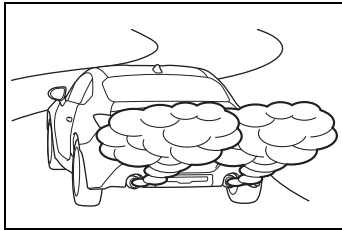

- There is an obstacle on a curve or intersection.

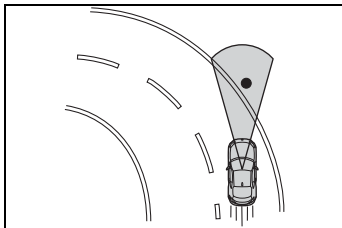

- A vehicle or an object is being narrowly passed.
- Stopping very close to a wall or a vehicle in front
- Passing through water spray from road sprinklers or snow clearing sprinklers on the road

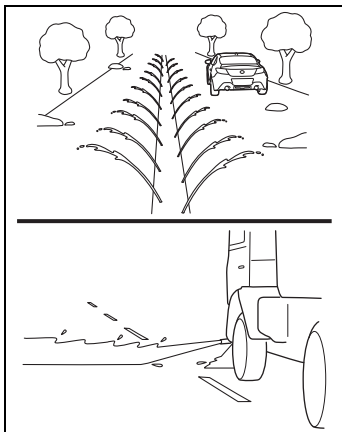

If there are installed accessories, etc. that are protruding beyond the edge of the front bumper, the vehicle's length will increase and the system may not be able to prevent a collision.

If the driver operates the brake pedal during automatic braking, the pedal may feel stiff; however, this is normal. By depressing the brake pedal further you can apply more braking force.

**Detection of pedestrians**

The EyeSight system can also detect pedestrians. The EyeSight system detects pedestrians from their size, shape and movement. The system detects a pedestrian when the contour of the head and shoulders are clear.

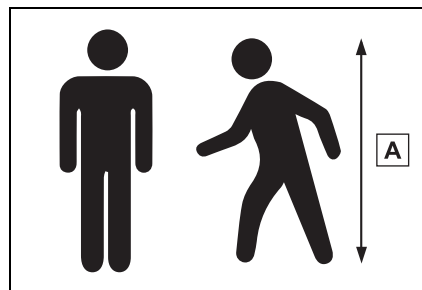

**A** Approx. 3 1/3 ft - 6 2/3 ft (1-2 m)

**⚠ WARNING**

The EyeSight system's Pre-Collision Braking function also identifies pedestrians as obstacles. However, depending on the conditions, there may be cases when the system cannot detect a pedestrian. In the following conditions, the possibility that the system may not be able to detect a pedestrian as an object is particularly high.

- Pedestrians are walking in a group.
- A pedestrian is next to a wall or other obstacle.

- A pedestrian is using an umbrella.
- A pedestrian is wearing clothes that are a similar color to the surrounding environment.
- A pedestrian is carrying bulky luggage.
- A pedestrian is bent over, crouching down or lying down.
- A pedestrian is in a dark location.
- A pedestrian suddenly crosses in front of you from the side or suddenly runs in front of you.

**Pre-Collision Braking System operation**

When there is an obstacle in front of you during driving, the system activates in the following sequence in order to warn the driver and to activate braking control and the stop lights.

**Following distance warning:**

When the system determines that there is a risk of collision, an alert sounds repeated short beeps and the indicators on the meter display illuminate to warn the driver.

The Following Distance Warning operates when Adaptive Cruise Control is not activated.

When the driver depresses the brake pedal to decelerate and achieves a suitable following distance, the warning is canceled.

**First braking and warning:**

When the system determines that there is a high risk of collision with an obstacle in front, an alert sounds repeated short beeps and the indicators on the meter display illuminate to warn the driver. Braking control may be activated and in some situations, engine output may also be controlled. If the system determines that the amount of evasive action (braking, steering, etc.) taken by the driver has reduced the risk of collision, braking activation is canceled.

**Secondary braking and warning:**

If the system then determines that the risk of collision is extremely high, the alert changes to a continuous beeping sound and stronger braking control is activated. Despite any evasive action taken by the driver, if the system subsequently determines that a collision is unavoidable, braking and engine output are controlled by the system.

When the vehicle is completely stopped by the automatic braking system, a short tone “3 intermittent beeps, 1 short beep and 1 long beep” will sound and braking will be gradually released and the vehicle will start creeping. To stop the vehicle completely, depress the brake pedal after the vehicle has stopped.

- Neither first braking nor secondary braking will operate in the following cases.
  - The vehicle speed is approximately 1 mph (1 km/h) or less (When the shift lever is in the N position and your vehicle speed is approximately 2 mph (4 km/h) or less) or 100 mph (160 km/h) or more.
  - VSC is active.
- If the system detects the stop lights of the vehicle in front, your vehicle will start decelerating earlier than if it does not.
- There are some cases where the first braking is applied for a longer period of time. One of the reasons for this is due to a large speed difference with an obstacle in front. In those cases, stronger or weaker braking control may be activated.

After the Pre-Collision Braking System operation, a message appears and stays on the meter display for a certain period of time.

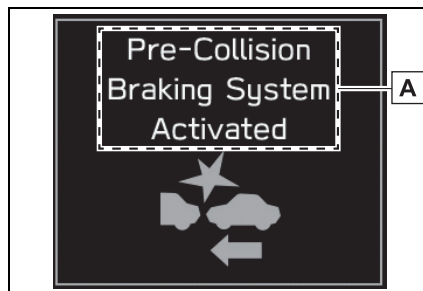

**A** “Pre-Collision Braking System Activated”

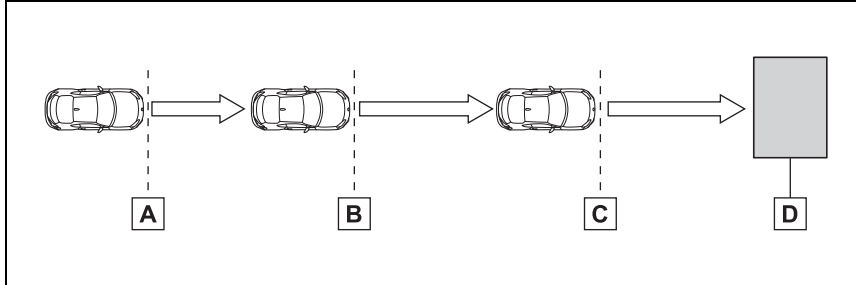

- A** Following distance warning  
Possible collision area
- B** First braking and warning  
Highly possible collision area
- C** Secondary braking and warning  
Extremely highly possible collision area
- D** Obstacle

Operating system	Strength of Auto-matic Braking	Indication on the multi-information display	Alert type
Following distance warning	Weak		Repeated short beeps
First braking	Moderate		Repeated short beeps
Secondary braking	Strong		Continuous beep

### Pre-Collision Braking Assist operation

When Pre-Collision Braking System is activated (when the system determines that there is a high risk of collision with an obstacle in front), if the driver depresses the brake pedal, the system determines that this is emergency braking and activates braking assist automati-

cally.

Pre-Collision Braking Assist function does not operate when the vehicle speed is approximately 7 mph (10 km/h) or less or 100 mph (160 km/h) or more.

**NOTICE**

If the driver depresses the brake pedal while following distance warning is activated, the Pre-Collision Braking Assist will not work. The vehicle decelerates with the normal braking force operated by the driver.

**Turning on/off Pre-Collision Braking System**

## ▶ Multimedia system screen

Operate the multimedia system screen to turn on/off Pre-Collision Braking System (including Pre-Collision Braking Assist). (→P.400)

## ▶ Multi-information display

Also you can turn on/off Pre-Collision Braking System (including Pre-Collision Braking Assist) using the meter operation switch. (→P.400)

If Pre-Collision Braking System is turned off, the Pre-Collision Braking System OFF indicator illuminates.

- The on/off setting for Pre-Collision Braking System operates in cooperation with Pre-Collision Throttle Management.
- Even when Pre-Collision Braking System is turned off, if the engine is turned off and then restarted, Pre-Collision Braking System will be turned on. The system default setting when the vehicle is restarted is on.

**Pre-Collision Braking System OFF indicator**

This indicator illuminates when the engine switch is turned to ON, and remains illuminated for approximately 7 seconds after the engine starts. It turns on when Pre-Collision Braking System and Pre-Collision Throttle Management are turned off. It also illuminates under the following conditions.

- TRAC and VSC system are set to OFF. (→P.263)
- The EyeSight system has a malfunction. (→P.228)
- The EyeSight system has stopped temporarily. (→P.229)

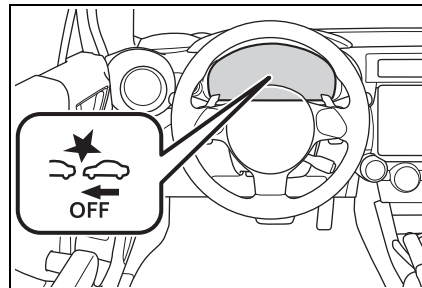

When the Pre-Collision Braking System OFF indicator is turned on, Pre-Collision Braking System (including the Pre-Collision Braking Assist function) and Pre-Collision Throttle Management do not operate.

## Adaptive Cruise Control\*

\*: If equipped

**Adaptive Cruise Control is a driving support system intended to allow more comfortable driving on expressways, freeways and interstate highways. The stereo camera detects vehicles in front that are driving in the same traffic lane, and your vehicle follows the vehicle in front (up to the maximum speed of the set vehicle speed). While following, your vehicle will automatically maintain a following distance that corresponds to the speed of the vehicle in front. The vehicle is capable of being controlled at a speed between 0 mph (0 km/h) and approximately 90 mph (145 km/h). Please remember that you should not exceed posted speed limits.**



### WARNING

- This system does not provide the driver with an automatic driving function that handles all traffic conditions.

- Do not rely excessively on Adaptive Cruise Control. This system is not intended to assist in driving when the driver is not paying full attention to what is ahead of him/her due to distractions or a lack of concentration while driving, or under conditions of poor visibility. It is not intended to prevent rear-end collisions.

Strive for safe driving at all times. Always maintain a safe following distance behind the vehicle in front of you, pay attention to your surroundings and the driving conditions, and operate the brake pedal and take other actions as necessary.

- When using Adaptive Cruise Control, always set the speed according to the speed limit, traffic flow, road conditions, and other conditions.
- Before using the system, perform a daily inspection and verify that there are no malfunctions of the tires or brakes.

→Refer to the separate “Owner’s Warranty Information Booklet” or “Owner’s Manual Supplement/Scheduled Maintenance Guide”.

- When you do not want to use Adaptive Cruise Control, be sure to turn it off by pressing the “ON-OFF” switch. If the switch is left on, cruise control may be accidentally engaged, possibly resulting in an accident.
- Before using Adaptive Cruise Control, be sure to fully verify the safety of the vehicle occupants and the area around the vehicle. Never operate the cruise control from outside the vehicle.

**⚠ WARNING**

- When the vehicle in front changes lanes, your vehicle will not follow. Always pay attention and take caution of the surrounding traffic condition.

The system may not operate correctly under the conditions listed below. When these conditions occur, do not use Adaptive Cruise Control.

- The tire pressure is not correct.<sup>\*1</sup>
- The temporary spare tire is installed.<sup>\*1</sup>
- Tires that are unevenly worn or tires with uneven wear patterns are installed.<sup>\*1</sup>
- Tires that are the wrong size are installed.<sup>\*1</sup>
- A flat tire has been fixed temporarily with a tire repair kit.
- The suspension has been modified (including a genuine Toyota suspension that has been modified).
- An object that obstructs the stereo camera's view is installed on the vehicle.
- Tire chains are installed.
- The headlights are dirty or they have snow and ice or dirt on them. (Objects are not correctly illuminated and are difficult to detect.)
- The optical axes are not aligned correctly. (Objects are not correctly illuminated and are difficult to detect.)
- The lights including headlights and fog lights have been modified.

- Vehicle operation has become unstable due to an accident or malfunction.
- The brake system warning light is illuminated in red.<sup>\*2</sup>
- A heavy cargo is inside the vehicle.
- The maximum number of occupants is exceeded.
- The meter is not operating properly; such as when the lights do not illuminate, the beeps do not sound, the display is different from when it is normal, etc.<sup>\*3</sup>

<sup>\*1</sup>: The wheels and tires have functions that are critically important. Be sure to use the correct ones. (→P.386)

<sup>\*2</sup>: If the brake system warning light (red) does not turn off, immediately pull the vehicle over in a safe place and contact a Toyota dealer to have the system inspected.

<sup>\*3</sup>: For details about the meter, refer to P.88.

Adaptive Cruise Control is designed for use on expressways, freeways, toll roads, interstate highways and similar limited access roads. It is not intended to be used in city traffic. In the following conditions, do not use Adaptive Cruise Control. Doing so may result in an accident.

 **WARNING**

- Ordinary roads (roads other than those mentioned above)
  - Depending on the driving environment (complexity of roads and other factors), the system may not be able to perform as the traffic conditions require, and that may result in an accident.
- Sharp curves or winding roads
- Frozen roads, snow-covered roads or other slippery road surfaces
  - The tires may spin, causing loss of control of the vehicle.
- Traffic conditions when frequent acceleration and deceleration make it difficult to maintain the following distance
  - It may not be possible for the system to perform as the traffic conditions require.
- Steep downhill grades
  - The set vehicle speed may be exceeded.
- On a steep continuous downhill grade
  - The brakes may overheat.
- Roads and overpasses with repeated steep uphill and downhill grades
  - Detection of the vehicle in front may be lost, or the road surface may be detected instead of the vehicle in front, making correct control impossible.
- Entering a sharp curve/turn into an interchange or junction, or a service area, parking area, toll booth or other facilities
  - Detection of the vehicle in front may not be possible.

- There are changes in brightness, such as at a tunnel entrance or exit.



**⚠ WARNING**

- Visibility is poor due to sand, smoke or water vapor blowing in the wind, or the front vision is obscured due to water splashes, snow, dirt, water spray from road sprinklers or snow clearing sprinklers on the road, or dust stir up generated by the vehicle in front or oncoming traffic.
- Detection of the vehicle in front may be lost, or water or other substances may be incorrectly detected instead, making correct control impossible.

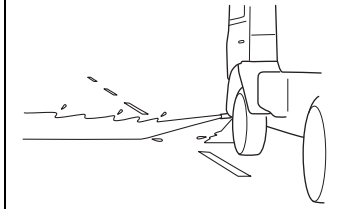
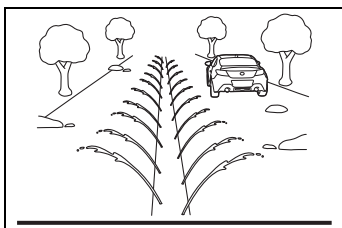
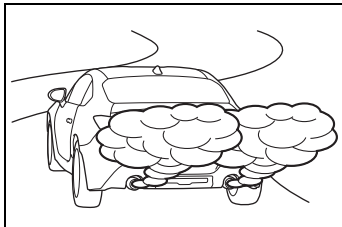
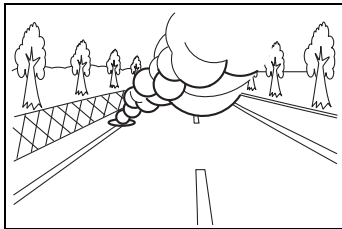

- In adverse weather, such as heavy snow or snowstorms
- The windshield has become fogged, scratched or smeared, or snow, dirt, dust or frost has adhered to it, or it is otherwise affected. These will reduce the stereo camera's field of view. Also, light is reflecting off the dirt, etc.
- Water droplets from rain or the window washer, or dirt has not been fully wiped off the windshield.
- It may not be possible to detect the vehicle in front, making correct control impossible.
- The stereo camera's field of view is obstructed.

The stereo camera may have difficulty detecting the following objects or conditions. Operate the brake pedal and take other actions as necessary.

- Vehicles at significantly different speeds (vehicles driving slowly, stopped or oncoming vehicles, etc.)
- Vehicles cutting into your lane
- Motorcycles, bicycles, pedestrians and animals, etc.
- Light is poor in the evening or early morning.
- At night or in a tunnel without the headlights on
- At night or in a tunnel when there is a vehicle in front that does not have its tail lights on
- Strong light is coming from the front (sunlight or headlight high beams, etc.).

**⚠ WARNING**

- Vehicles in front that have a rear aspect that is low, small or irregular (the system may recognize another part of the vehicle and will determine operation from that)
- An empty truck or trailer that has no tailgate or longbed
- Vehicles that have cargo protruding from their back ends
- Non-standard shaped vehicles (vehicle transporters or vehicles with a sidecar fitted, etc.)
- Vehicles that are low

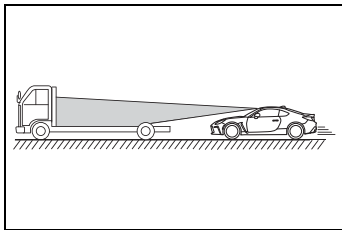

- Objects that are located close to the bumper of your vehicle

■ **Detection of the vehicle in front by the EyeSight stereo camera\***

- Under the following road conditions or conditions of your vehicle, detection of the vehicle in front may not be possible. Vehicles in neighboring traffic lanes or roadside objects may also be incorrectly detected. Under conditions such as these, do not use Adaptive Cruise Control. If cruise control is currently in use, operate the brake pedal and take other actions as necessary.

- Following begins from a short following distance, such as when the vehicle in front is a vehicle that cut into your lane.

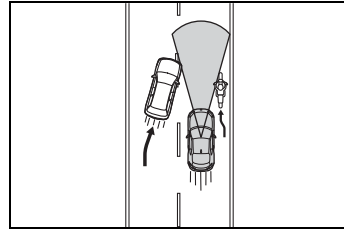

- On curved roads, at the start and end of a curve and on roads with continuous curves (These conditions make it difficult for the system to detect vehicles because they are outside the detectable area.)

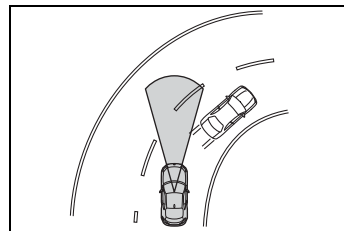

- On an on-ramp or off-ramp to a freeway, highway, or other restricted access road (EyeSight Adaptive Cruise Control is not designed for use in this kind of driving environment.)
- In an urban or suburban environment (Adaptive Cruise Control is not appropriate for use in these driving areas. Use Adaptive Cruise Control only on limited-access highways.)

**⚠ WARNING**

- The vehicle in front is not directly ahead of your vehicle and is shifted to one side.

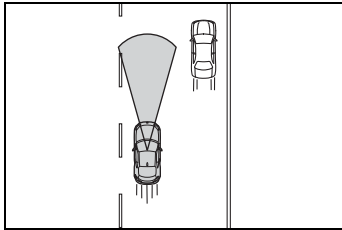

- There is an obstacle on the side of the road.

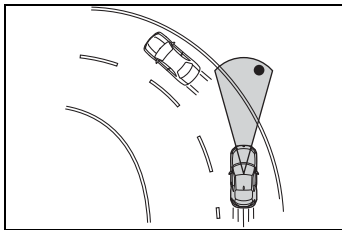

- The relative speed difference compared to the vehicle in front is large.
- A vehicle cuts into your lane in front of you.
- The distance between vehicles is extremely short.
- Your vehicle is drifting within the lane.
- On a bumpy or unpaved road surface.
- On a road with extremely narrow lanes, such as when traffic restrictions are in effect or in areas where construction work is taking place.
- Normal driving has become unstable due to an accident or malfunction.

- Extremely heavy cargo is loaded in the rear seat or trunk of your vehicle.

- There are limits to the situation judgment capabilities of the Adaptive Cruise Control system. Deceleration may not take place in time in the following situations. Apply the brake pedal to decelerate the vehicle if necessary.

- The speed difference with the vehicle in front is too large or the vehicle in front decelerates unexpectedly.

- The decelerating vehicle in front unexpectedly slows down or suddenly brakes.

- If the alert/notification sounds frequently, do not use Adaptive Cruise Control.

- Even when the following distance is short, the "Obstacle Detected" warning may not activate in the following situations.

- The difference in speed with the vehicle in front is small. The two vehicles are traveling at almost the same speed.

- The vehicle in front is traveling faster than your vehicle. The following distance is gradually increasing.

- Another vehicle cuts into your lane very close to your vehicle.

- The vehicle in front decelerates suddenly.

- There are repeated uphill and downhill grades.

\*: The recognition status of the lead vehicle using the stereo camera can be confirmed by the illumination status of the lead vehicle indicator. (→P.196)

 NOTICE

- After Adaptive Cruise Control has started, it maintains control continuously according to the behavior of the vehicle in front. When your vehicle comes to a stop because the vehicle in front has stopped, the automatic braking function will be canceled immediately after stopping and the vehicle will start creeping forward gradually (at the same time 3 intermittent beeps, 1 short beep and 1 long beep will sound). Be sure to depress the brake pedal and stop the vehicle completely. Note that the vehicle is not maintained at a standstill position and will not automatically start moving from a standstill position.
- Braking may not be sufficient depending on the following conditions. Depress the brake pedal and decelerate as necessary.
  - Vehicle conditions (amount of load, number of occupants, etc.)
  - Road conditions (grade, slipperiness, shape, bumps, etc.)
  - Vehicle maintenance condition (brake systems, tire wear, air pressure, temporary spare tire is being used, etc.)
  - The brakes are cold. (For example, just after the engine is started or the outside temperature is low.)
  - For a short period of time when driving after the engine is started until the engine has warmed-up
  - The brakes are overheated on downhill grades (braking performance may be reduced).

- In rain or after washing the vehicle (the brakes may become wet and braking performance may be reduced.)

### How to use Adaptive Cruise Control

#### ■ Setting Adaptive Cruise Control

##### 1 Setting Adaptive Cruise Control to standby status

Press the "ON-OFF" switch. At this time,  (white) and the following distance setting indicator are displayed on the meter display.

The set vehicle speed display will read "--- MPH (- - - km/h)".

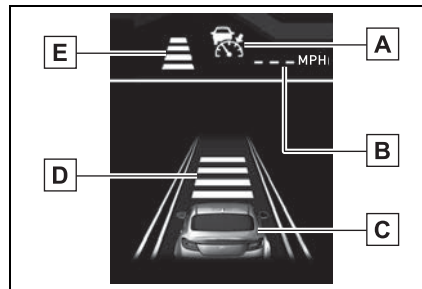
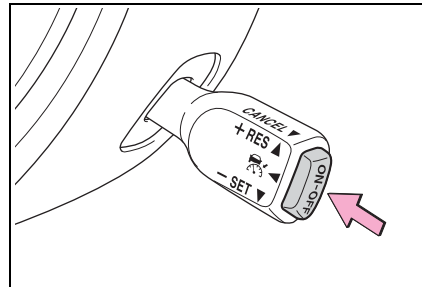

- A** Adaptive Cruise Control indicator
- B** Set vehicle speed
- C** Your vehicle indicator
- D** Following distance setting

indicator

**E** Following distance setting indicator (icon)

When the multi-information display is set to display content other than the driving support system information display, the following distance setting indicator is shown as an icon.

To set the ready status: Adaptive Cruise Control can be activated when all of the following conditions are met and “READY” indicator is displayed on the meter display.

- Both the driver's door and the front passenger's door are closed.
- The driver's seatbelt is fastened.
- The shift lever is in the D or M position.
- The brake pedal is not depressed.
- EyeSight operation is not temporarily stopped.  (white) is turned off. (→P.229)
- The road is not a steep slope.
- The steering wheel has not been turned significantly in either direction.
- The vehicle speed is between 0 mph (0 km/h) and approximately 90 mph (145 km/h).
- Parking brake is released.
- The driving mode is set to normal mode or sport mode. (→P.258)
- Pre-Collision Braking System

is not turned off during TRACK mode. (→P.189, 263)

- TRAC and VSC system are not set to off. (→P.263)

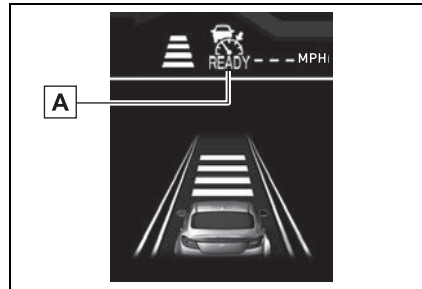

**A** “READY” indicator

2 Setting Adaptive Cruise Control

Push the cruise control switch to the “- SET” side or the “+ RES” side.

Adaptive Cruise Control is activated and control starts, using the vehicle speed at the time when the switch was pushed as the set vehicle speed.

If no vehicle in front has been detected, the vehicle drives at the constant set vehicle speed.

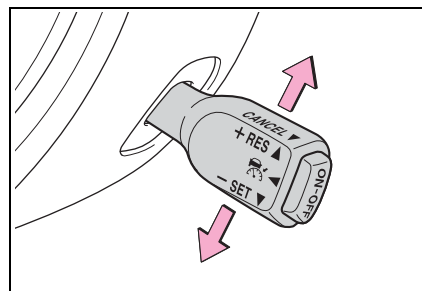

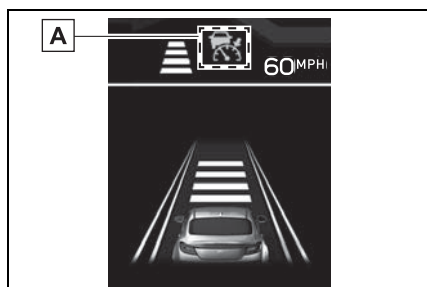

When Adaptive Cruise Control is activated, “READY” indicator turns off, the set vehicle speed is displayed, and  changes

from white to green.



A Green



- The set vehicle speed can be set between 20 mph (30 km/h) and 90 mph (145 km/h).
- If the vehicle speed is approximately 20 mph (30 km/h) or less when the vehicle speed is set, the set vehicle speed is set to 20 mph (30 km/h).
- When driving on a curve, the vehicle may not accelerate, or may decelerate, even if the set vehicle speed is higher than the current vehicle speed.
- If  does not illuminate, even when the "ON-OFF" switch is pressed, Adaptive Cruise Control will not operate.
- If  does not illuminate, even when the "ON-OFF" switch is pressed and this occurs frequently, there may be a malfunction in the system. Contact a Toyota dealer and have the system inspected.

**! WARNING**

When using Adaptive Cruise Control, always set the speed according to the speed limit, traffic flow, road conditions, and other conditions.

When a vehicle in front is

detected, a notification sounds 1 short beep and the lead vehicle indicator will illuminate.

The vehicle follows the lead vehicle in front and maintains the selected following distance. At this time, the cruise speed is adjusted to and will not exceed the set vehicle speed. If the vehicle in front is no longer detected, a notification sounds 1 short beep and the lead vehicle indicator turns off. While the driver accelerates the vehicle by depressing the accelerator pedal,  will turn from green to white. When acceleration has stopped,  will turn from white to green.

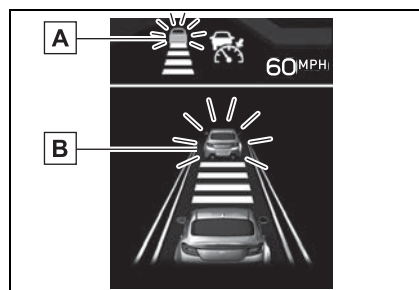

A Lead vehicle indicator (icon)

B Lead vehicle indicator

- When the multi-information display is set to display content other than the driving support system information display, the lead vehicle indicator is shown as an icon. (→P.93)
- The notification sound (lead vehicle acquisition sound) that occurs when a vehicle in front is detected or no longer detected while Adap-

tive Cruise Control is activated can be turned off by customization. (→P.400)

■ **Operation of Adaptive Cruise Control**

- When no vehicle in front is detected

The vehicle drives constantly and correspondingly to the set vehicle speed between 20 mph (30 km/h) and 90 mph (145 km/h).

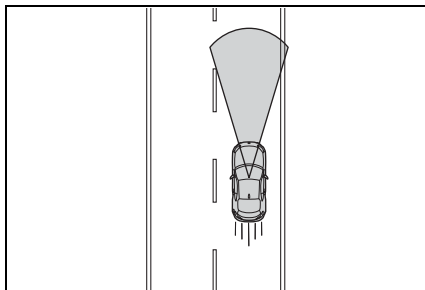

- When a vehicle in front is detected

The vehicle follows the lead vehicle in front, and will maintain the chosen following distance (there are four settings), up to the set vehicle speed between 20 mph (30 km/h) and 90 mph (145 km/h).

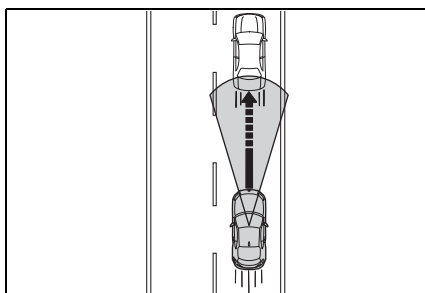

- If your vehicle no longer detects the vehicle in front

The vehicle gradually accelerates back to the set vehicle speed and

will drive at that constant speed.

If a vehicle in front is detected while accelerating to the set vehicle speed, vehicle following will be started again.

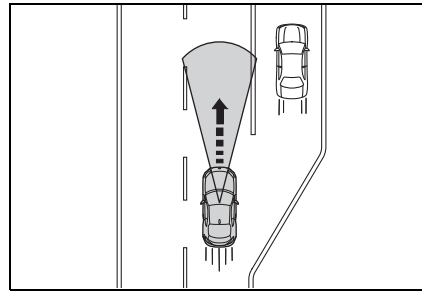

- When the brakes are applied by Adaptive Cruise Control, the vehicle's stop lights will illuminate.
- Even if there is no lead vehicle present, on a downhill grade, the Adaptive Cruise Control's automatic brake may operate in order to maintain the set vehicle speed.
- Some noises may be audible during automatic braking. This is caused by the braking control and does not indicate a malfunction.
- To temporarily accelerate quickly, use the accelerator pedal. After accelerating, the vehicle will gradually return to the set vehicle speed shown in the set vehicle speed display.
- If the vehicle in front is no longer detected while your vehicle is still controlled by the automatic braking operation, the brake will be automatically released gradually. Depress the accelerator pedal if necessary.
- The lead-vehicle following function has the following characteristics:
  - If the lead vehicle's stop lights are detected, deceleration will start earlier than without detection.
  - If the vehicle moves to the fast lane while traveling more than

approximately 37 mph (60 km/h), the system starts acceleration to the set vehicle speed more quickly because it is linked with the turn signal.

- If the setting of driving lane is different from the actual driving direction, the vehicle may start to accelerate faster than usual when the driver signals a lane change to move from the passing lane to the driving lane. (→P.400)
- Cruise control acceleration characteristics can be set to one of four levels. (→P.400)



**NOTICE**

If the driver operates the brake pedal during automatic braking, the pedal may feel stiff; however, this is not a malfunction. By depressing the brake pedal further you can apply more braking force. When the brake pedal is released it will return to its original condition.

■ **Increasing the set vehicle speed**

- ▶ Using the cruise control switch
- Push to the “+ RES” side briefly.

Every time the switch is pushed, the set vehicle speed will increase in increments of 1 mph (1 km/h) increment.

- Push to the “+ RES” side continuously.

While the switch is being pushed, the set vehicle speed will increase in increments of 5 mph (5 km/h).

When operating the switch, the set vehicle speed changes on the meter display.

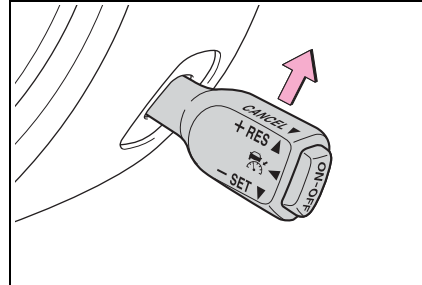

▶ Using the accelerator pedal

- 1 Depress the accelerator pedal to increase vehicle speed.
- 2 When the desired speed is reached, push the cruise control switch to the “- SET” side.

The speed at the time of pushing the switch will be set as the new set vehicle speed, and it appears on the meter display.

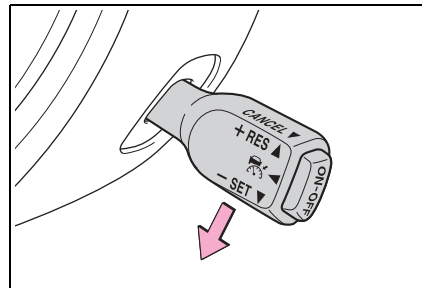



**NOTICE**

- When the vehicle is following the lead vehicle, the actual vehicle speed is controlled according to the lead vehicle. Therefore, if the cruise control switch is pushed to the “+ RES” side and set to a speed higher than the speed of the lead vehicle, the vehicle will not accelerate; it will maintain a safe following distance as the first priority. However, because doing so changed the set vehicle speed, when the lead vehicle is no longer detected (for example, if you change to a freeway lane with no vehicles in front), the vehicle will accelerate to that new set vehicle speed. Change the set vehicle speed while briefly checking the value shown in the set vehicle speed display on the meter display.
- When the accelerator pedal is depressed with Adaptive Cruise Control on, automatic braking control and warnings by Adaptive Cruise Control will not occur. However, if there is a high risk of collision with an obstacle in front of the vehicle at this time, the warning and braking control of Pre-Collision Braking System may activate.

**Decreasing the set vehicle speed**

- ▶ Using the cruise control switch
- Push to the “- SET” side briefly.

Every time the switch is pushed, the set vehicle speed will decrease in decrements of 1 mph (1 km/h) decrement.

- Push to the “- SET” side con-

tinuously.

While the switch is being pushed, the set vehicle speed will decrease in decrements of 5 mph (5 km/h).

When operating the switch, the set vehicle speed changes on the meter display.

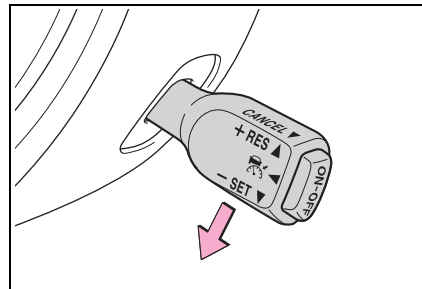

- ▶ Using the brake pedal

- 1 Depress the brake pedal to decrease the vehicle speed.

Adaptive Cruise Control will be canceled and  (Adaptive Cruise Control indicator) changes from green to white.

- 2 When the desired speed is reached, push the cruise control switch to the “- SET” side.



The speed at the time of pushing the switch will be set as the new set vehicle speed, and it appears on the meter display.

**Accelerating temporarily**

Depress the accelerator pedal to accelerate temporarily.

When the accelerator pedal is released, the vehicle returns to the set vehicle speed.

When the driver accelerates the vehicle by depressing the accel-

erator pedal while Adaptive Cruise Control is operating,  turns white. When the acceleration is completed,  returns to green.

■ **Decelerating temporarily**

Depress the brake pedal to decelerate temporarily. When the brake pedal is depressed, Adaptive Cruise Control will be canceled.  changes from green to white while the set vehicle speed remains displayed on the meter display.

Release the brake pedal and push the cruise control switch to the “+ RES” side to reset the set vehicle speed.

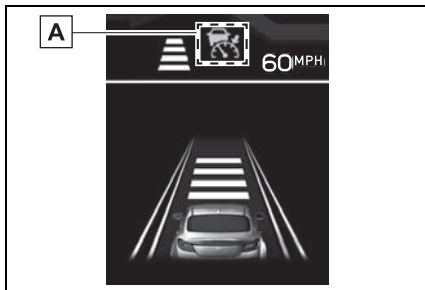

A White

 NOTICE

Ordinarily, while the vehicle is following the lead vehicle, acceleration and deceleration are performed automatically in accordance with the speed of the lead vehicle. However, when your vehicle approaches a lead vehicle, for example if it is necessary to accelerate for a lane change or other reason, and if the vehicle in front suddenly decelerates, or if another vehicle cuts into your path, operate the accelerator pedal or brake pedal to accelerate or decelerate as appropriate for the existing conditions.

■ **Changing the following distance from the vehicle in front**

The following distance from the vehicle in front setting can be changed in 4 stages.

Each time the  (Following distance setting) switch is pressed, the distance from the vehicle in front changes.

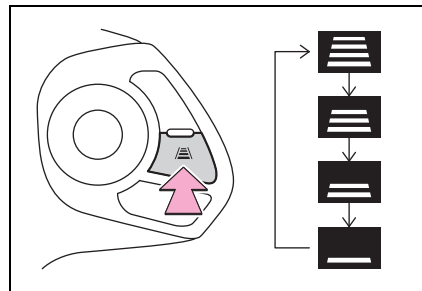

- The following distance changes corresponding with the vehicle speed. The faster the vehicle travels, the greater the following distance.

**Approximate guide to following distances**

Following distance indicator	When your vehicle speed is 25 mph (40 km/h)	When your vehicle speed is 60 mph (100 km/h)
	Approx. 100 ft (30 m)	Approx. 200 ft (60 m)
	Approx. 80 ft (25 m)	Approx. 160 ft (50 m)
	Approx. 65 ft (20 m)	Approx. 130 ft (40 m)
	Approx. 50 ft (15 m)	Approx. 100 ft (30 m)

- The following distance previously set is restored when you turn back on Adaptive Cruise Control by pressing the “ON-OFF” switch.

### Canceling Adaptive Cruise Control

#### ■ Canceling by driver operation

Any of the following operations will cancel Adaptive Cruise Control.

- Depress the brake pedal.
- changes from green to white while the set vehicle speed remains displayed on the meter display.

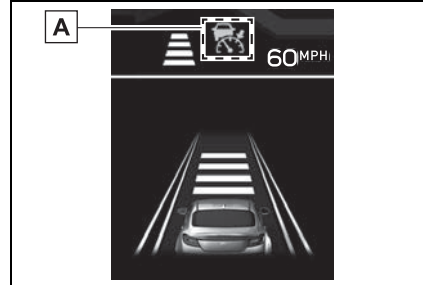

**A** White

- Pull the cruise control switch to the “CANCEL” side.

changes from green to white while the set vehicle speed remains displayed on the meter display.

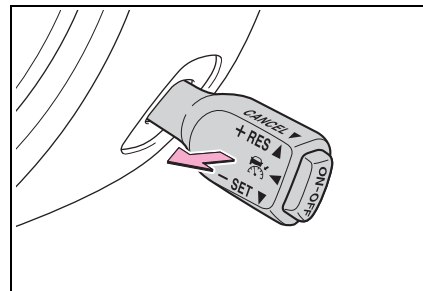

#### ■ Automatic cancellation by the system

When the Adaptive Cruise Control system brings your vehicle to a complete stop, 3 intermittent beeps, 1 short beep and 1 long beep will sound, and the Adaptive Cruise Control system will release control of your vehicle.

 NOTICE

When the vehicle has stopped, the automatic braking function will be gradually released and the vehicle will start creeping. Make sure to stop the vehicle completely by depressing the brake pedal after the vehicle has stopped.

In the following cases, a notification will sound 1 short beep and 1 long beep and Adaptive Cruise Control is automatically canceled.  changes from green to white. Also, the Adaptive Cruise Control cancellation message is displayed on the multi-information display.

- The grade of the road is very steep.
- TRAC or VSC is activated.
- The vehicle speed has exceeded approximately 100 mph (160 km/h) while cruise control is activated.
- The steering wheel is turned significantly in either direction.
- The shift lever is moved to a position other than D or M.
- Adaptive Cruise Control can be resumed after the shift lever is returned to the D or M position.
- Either the driver's door or the front passenger's door is opened.
- The driver's seatbelt is unfastened.
- The EyeSight system has a

malfunction. (  :yellow) (→P.228)

- The EyeSight system has stopped temporarily. (  :white) (→P.229)
- The Pre-Collision secondary braking is activated.
- Parking brake is applied.
- The engine revolutions approached the red zone.
- The driving mode is set to snow mode. (→P.258)
- Pre-Collision Braking System is turned off during TRACK mode. (→P.189, 263)
- TRAC and VSC system are off. (→P.263)
- The driving wheels spin on a slippery road.



- If EyeSight is malfunctioning,  (yellow) is displayed on the meter display, and the Pre-Collision Braking System OFF indicator and Lane Departure Warning OFF indicator illuminate. If this occurs, stop the vehicle in a safe location and then turn off the engine and restart it. If the indicators remain illuminated after restarting the engine, Adaptive Cruise Control

cannot be used. This will not interfere with ordinary driving. However, contact a Toyota dealer and have the system inspected. (→P.228)

- If the EyeSight operation has temporarily stopped, the Pre-Collision Braking System OFF indicator and Lane Departure Warning OFF indicator illuminate, and  (white) is displayed on the meter display. (→P.229)
- When the operation of Adaptive Cruise Control has been automatically canceled, perform the Adaptive Cruise Control setting operation again after the condition that caused the cancellation has been corrected. If the Adaptive Cruise Control function cannot be activated even after the condition has been corrected, EyeSight may be malfunctioning. This will not interfere with ordinary driving. However, contact a Toyota dealer and have the system inspected.

 **WARNING**

Do not use Adaptive Cruise Control on slippery roads. Doing so may result in an accident.

 **NOTICE**

When shifting the shift lever to the N position, Adaptive Cruise Control will be automatically canceled. Do not shift the lever to the N position unless in an emergency. Otherwise the engine brake may not operate, which could cause an accident.

**Restoring the previously set vehicle speed**

The previously set vehicle speed is stored in memory. To

restore that vehicle speed, push the cruise control switch to the “+ RES” side.  changes from white to green.

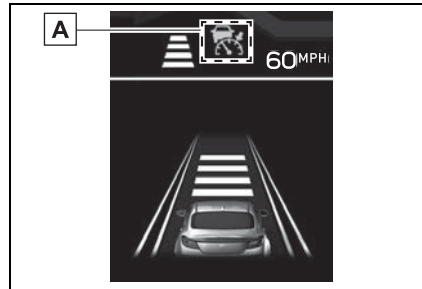
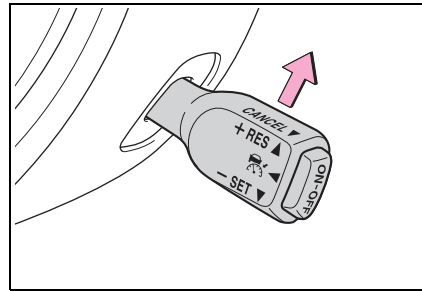

**A** Green

- The vehicle speed stored in memory is erased in the following circumstances:
  - The cruise control is turned off by pressing the “ON-OFF” switch.
  - The VSC or the TRAC is activated.
  - The cruise control mode was switched from Adaptive Cruise Control to Conventional Cruise Control.
- If there is no vehicle speed stored in memory (previous vehicle speed), the current vehicle speed is set when the cruise control switch is pushed to the “+RES” side. (→P.196)

### Turning off Adaptive Cruise Control

Press the “ON-OFF” switch.

 turns off on the meter display and Adaptive Cruise Control turns off.

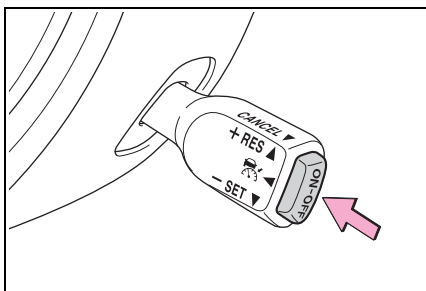

### Other functions

#### ■ “Obstacle Detected” warning

The “Obstacle Detected” warning is activated while Adaptive Cruise Control is following a lead vehicle. This function warns the driver when it determines that the current level of deceleration by automatic braking control is insufficient.

- When the system determines that the vehicle speed needs to be reduced manually by the driver, an alert will sound repeated short beeps and a pop-up display will be displayed.
- When this function activates, depress the brake pedal to decelerate and maintain an

optimal following distance.

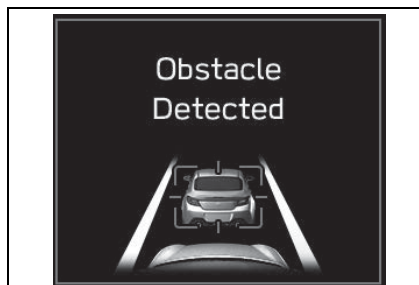

Vehicles in front in the same traffic lane are detected by the stereo camera within a distance of approximately 360 ft (110 m) in the forward direction. However the detection distance may be reduced depending on the traffic environment, driving conditions, and conditions of the vehicle in front.

#### WARNING

- If the alert/notification sounds frequently, do not use Adaptive Cruise Control.
- The “Obstacle Detected” warning will not activate in the following situations.
  - The accelerator pedal is depressed.
  - The brake pedal is depressed.
- Even when the following distance is short, the “Obstacle Detected” warning may not activate in the following situations.
  - The difference in speed with the vehicle in front is small. The two vehicles are traveling at almost the same speed.
  - The vehicle in front is traveling faster than your vehicle. The following distance is gradually increasing.

**⚠ WARNING**

- Another vehicle cuts into your lane very close to your vehicle.
- The vehicle in front decelerates suddenly.
- There are repeated uphill and downhill grades.
- The “Obstacle Detected” warning may not activate in time in the case of a vehicle that is stopped at the end of a line at a toll gate, at a stop light or intersection or in traffic congestion, or a vehicle that is moving much slower than your vehicle. EyeSight requires a speed differential in order to recognize a potential obstacle and react to it.

**Conventional Cruise Control\***

\* : If equipped

**Conventional Cruise Control is a driving support system intended to allow more comfortable driving on expressways, freeways and interstate highways. It can be used to travel at a constant speed by maintaining the vehicle speed set by the driver. Please remember that you should not exceed posted speed limits.**



- When the main cruise control is off and the “ON-OFF” switch is pressed, Adaptive Cruise Control is activated.
- When the main cruise control is on, switching between Adaptive Cruise Control and Conventional Cruise Control is possible by pressing the  (Following distance setting) switch\*.
- \* : To switch to Conventional Cruise Control, press and hold the switch for approximately 2 seconds or longer.
- Conventional Cruise Control can be used even when EyeSight is temporarily stopped.

**⚠ WARNING**

- When Conventional Cruise Control is functioning, the system does not perform the following control to maintain a following distance, as when using Adaptive Cruise Control. Strive for safe driving and depress the brake pedal to decelerate the vehicle as necessary in order to ensure a safe following distance from the vehicle in front.
- Under the following conditions, do not use Conventional Cruise Control. Doing so may result in an accident.
  - Roads with heavy traffic or roads with sharp curves
    - Maintaining an appropriate speed for such road conditions may be difficult.
  - Frozen roads, snow-covered roads or slippery road surfaces
    - The tires may spin, causing your vehicle to lose control.
  - Steep downhill grades
    - The set vehicle speed may be exceeded.
  - On a steep continuous downhill grade
    - The brakes may overheat.
- When using Conventional Cruise Control, always set the speed according to the speed limit, traffic flow, road conditions, and other conditions.

**⚠ NOTICE**

When using Cruise Control, be sure to check the meter display to confirm which Cruise Control mode is selected: Adaptive Cruise Control or Conventional Cruise Control.

- If Adaptive Cruise Control is selected,  illuminates.
- If Conventional Cruise Control is selected,  illuminates.

**How to use Conventional Cruise Control****■ Setting Conventional Cruise Control**

- 1 Setting Adaptive Cruise Control to standby status.

Press the “ON-OFF” switch. At this time,  (white) and the following distance setting indicator are displayed on the meter display.

The set vehicle speed display will read “- - - MPH (- - - km/h)”.

When the “ON-OFF” switch is pressed, the initial cruise control mode is always Adaptive Cruise



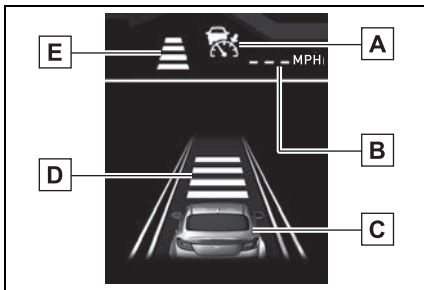
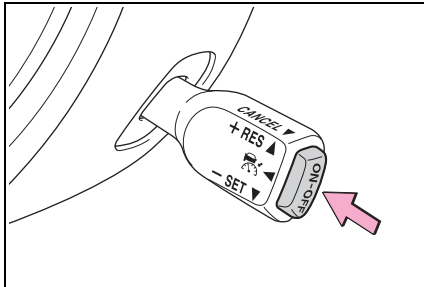

Control.



- A** Adaptive Cruise Control indicator
- B** Set vehicle speed
- C** Your vehicle indicator
- D** Following distance setting indicator
- E** Following distance setting indicator (icon)

2 Switch to Conventional Cruise Control.

Press and hold the  (Following distance setting) switch for approximately 2 seconds or longer to switch from Adaptive Cruise Control to Conventional Cruise Control. A notification sounds 1 short beep.

At this time, the following distance setting indicator on the meter display turns off and  (white) is displayed.

played.

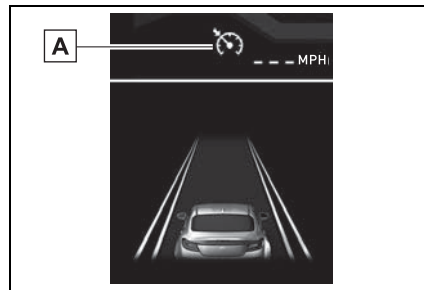
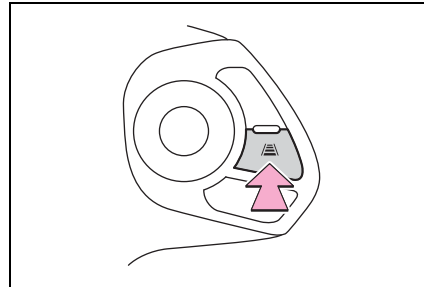

- A** Conventional Cruise Control indicator (White)

To set the ready status: Conventional Cruise Control can be activated when all of the following conditions are met and “READY” indicator is displayed on the meter display.

- Both the driver's door and the front passenger's door are closed.
- The driver's seatbelt is fastened.
- The shift lever is in the D or M position.
- The brake pedal is not depressed.
- The road is not on a steep slope.
- The steering wheel has not been turned significantly in either direction.

- The vehicle speed is between approximately 20 mph (30 km/h) and 90 mph (145 km/h).
- Parking brake is released.
- The driving mode is set to normal mode or sport mode. (→P.258)
- Pre-Collision Braking System is not turned off during TRACK mode. (→P.189, 263)
- TRAC and VSC system are not set to off. (→P.263)

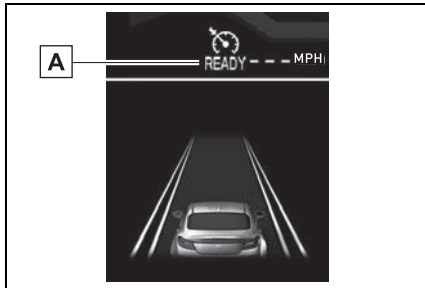

**A** “READY” indicator

- Control the accelerator pedal to reach the desired speed.
- When the vehicle reaches the desired speed, push the cruise control switch to the “+ RES” side or the “- SET” side. The vehicle speed at the time when the switch is pushed will become the set vehicle speed, and constant speed driving will initiate.

When Conventional Cruise Control is activated, “READY” indicator turns off, the set vehicle speed is displayed and  changes from

white to green.

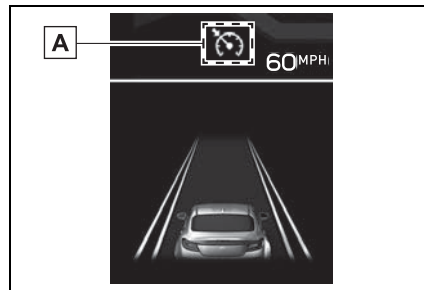
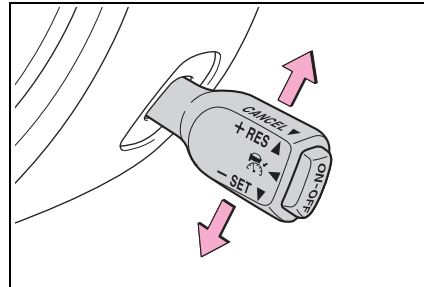

**A** Green

- On a downhill grade, automatic braking may operate in order to maintain the set vehicle speed.
- When driving on a curve, the vehicle may not accelerate, or may decelerate, even if the set vehicle speed is higher than the current vehicle speed.
- To return to Adaptive Cruise Control use, cancel Conventional Cruise Control and then briefly press the  (Following distance setting) switch. A notification will sound (1 short beep) when switching to Adaptive Cruise Control.
- Cruise control acceleration characteristics can be set to one of four levels. (→P.400)

**⚠ WARNING**

- The “Obstacle Detected” warning will not activate while Conventional Cruise Control is functioning.
- When using Conventional Cruise Control, always set the speed according to the speed limit, traffic flow, road conditions, and other conditions.

**⚠ NOTICE**

During Conventional Cruise Control use, accelerator and brake control to follow the vehicle in front is not performed. Operate the accelerator and brake pedals as necessary.

- **Increasing the set vehicle speed**
    - ▶ Using the cruise control switch
      - Push to the “+ RES” side briefly.
- Every time the switch is pushed, the set vehicle speed will increase in increments of 1 mph (1 km/h).
- Push to the “+ RES” side continuously.
- While the switch is being pushed, the set vehicle speed will increase in increments of 5 mph (5 km/h).
- When operating the switch, the set vehicle speed changes on the meter display.

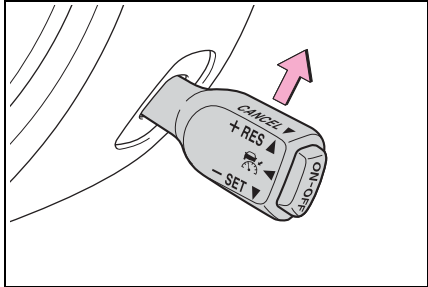

- ▶ Using the accelerator pedal
  - 1 Depress the accelerator pedal to increase vehicle speed.
  - 2 When the desired speed is reached, push the cruise control switch to the “- SET” side.

The speed at the time of pushing the switch will be set as the new set vehicle speed, and it appears on the meter display.

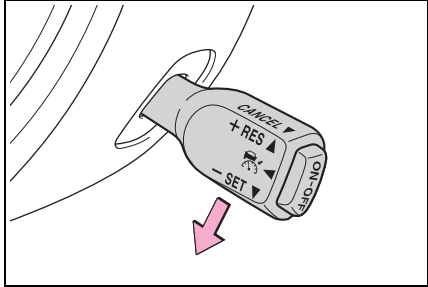

- **Decreasing the set vehicle speed**
    - ▶ Using the cruise control switch
      - Push to the “- SET” side briefly.
- Every time the switch is pushed, the set vehicle speed will decrease in decrements of 1 mph (1 km/h).
- Push to the “- SET” side con-

tinuously.

While the switch is being pushed, the set vehicle speed will decrease in decrements of 5 mph (5 km/h).

When operating the switch, the set vehicle speed changes on the meter display.

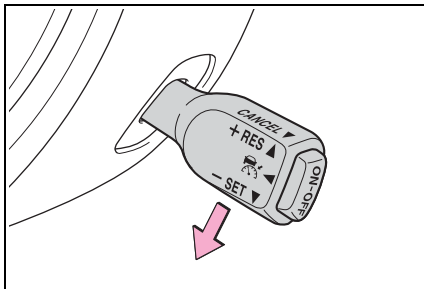

► Using the brake pedal

- 1 Depress the brake pedal to decrease the vehicle speed.

Conventional Cruise Control will be canceled and  changes from green to white.

- 2 When the desired speed is reached, push the cruise control switch to the “- SET” side.

The speed at the time of pushing the switch will be set as the new set vehicle speed, and it appears on the meter display.

■ **Accelerating temporarily**

Depress the accelerator pedal to accelerate temporarily.

When the accelerator pedal is released, the vehicle returns to the set vehicle speed.

■ **Decelerating temporarily**

Depress the brake pedal to decelerate temporarily. When

the brake pedal is depressed, Conventional Cruise Control will be canceled. While the set vehicle speed remains displayed on the meter display,  changes from green to white.

Release the brake pedal and push the cruise control switch to the “+ RES” side to reset the set vehicle speed.

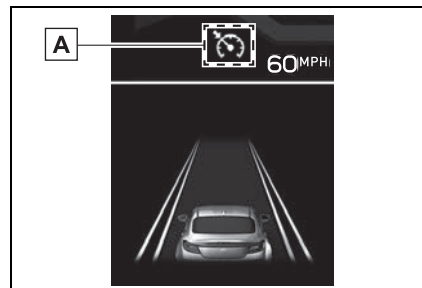

A White

### Canceling Conventional Cruise Control

■ **Canceling by driver operation**

Any of the following operations will cancel Conventional Cruise Control.

- Depress the brake pedal.
- Pull the cruise control switch to the “CANCEL” side.

 changes from green to white while the set vehicle speed remains displayed on the meter display.

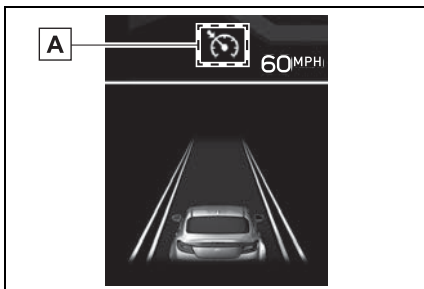
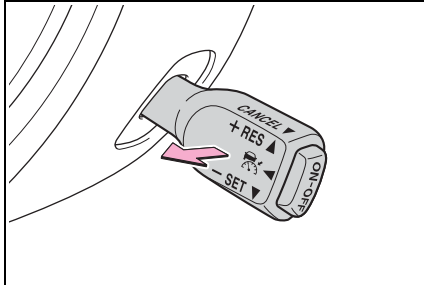

**A** White

**Automatic cancellation by the system**

In the following cases, a notification sounds 1 short beep and 1 long beep and the cruise control function is automatically canceled.  changes from green to white. Also, the Conventional Cruise Control cancellation message is displayed on the multi-information display.

After the conditions listed below have been resolved, perform the cruise control set operation again to reactivate cruise control.

- The shift lever is moved to a position other than D or M.
- Conventional Cruise Control can be resumed after the shift lever is

returned to the D or M position.

- Vehicle speed drops to approximately 16 mph (25 km/h) or less (due to a steep uphill grade or some other reason).
- Vehicle speed increases to approximately 100 mph (160 km/h) or more.
- TRAC or VSC is activated.
- Either the driver's door or the front passenger's door is opened.
- The driver's seatbelt is unfastened.
- The EyeSight system has a malfunction. (  :Yellow) (→P.228)
- The steering wheel is turned significantly in either direction.
- The grade of the road is steep.
- The Pre-Collision secondary braking is activated.
- Parking brake is applied.
- The engine revolutions approached the red zone.
- The driving mode is set to snow mode. (→P.258)
- Pre-Collision Braking System is turned off during TRACK mode. (→P.189, 263)
- TRAC and VSC system are off. (→P.263)
- The driving wheels spin on a

slippery road.

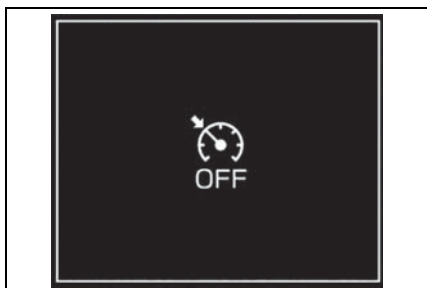

- If EyeSight is malfunctioning,  (yellow) is displayed on the meter display, and the Pre-Collision Braking System OFF indicator and Lane Departure Warning OFF indicator will also illuminate. If this occurs, stop the vehicle in a safe location and then turn off the engine and restart it. If the indicators remain illuminated after restarting the engine, Conventional Cruise Control cannot be used. This will not interfere with ordinary driving. However, contact a Toyota dealer and have the system inspected. (→P.228)
- When operation of Conventional Cruise Control has been automatically canceled, perform the set operation again after the condition that caused the cancellation has been resolved. If cruise control cannot be activated even after the condition has been corrected, EyeSight may be malfunctioning. This will not interfere with ordinary driving. However, contact a Toyota dealer and have the system inspected.

**! WARNING**

Do not use Conventional Cruise Control on slippery roads. Doing so may result in an accident.

**! NOTICE**

When shifting the shift lever to the N position, Conventional Cruise Control will be automatically canceled. Do not shift the lever to the N position unless in an emergency. Otherwise the engine brake may not operate, which could cause an accident.

**■ Restoring the previously set vehicle speed**

The previously set vehicle speed is stored in memory. To restore that vehicle speed, push the cruise control switch to the “+ RES” side.  changes from white to green.

You can restore the set vehicle speed when the previously set vehicle speed has been stored and the current vehicle speed is approximately 20 mph (30 km/h) or more.

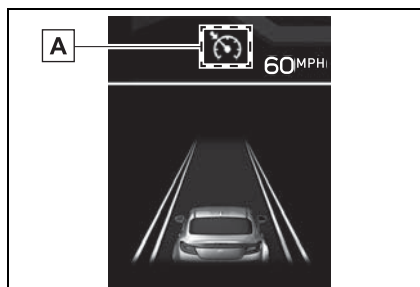
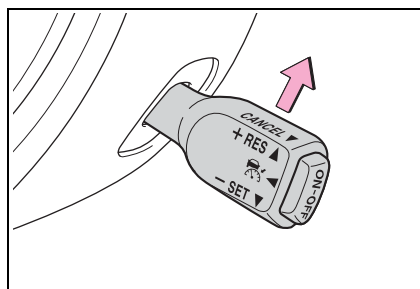

**A** Green

- The vehicle speed stored in memory is erased in the following circumstances:
  - The cruise control is turned off by pressing the “ON-OFF” switch.
  - TRAC or VSC is activated.
  - The cruise control mode was switched from Conventional Cruise Control to Adaptive Cruise Control.
- The vehicle drives constantly and correspondingly to the set vehicle speed between 20 mph (30 km/h) and 90 mph (145 km/h).
- If there is no vehicle speed stored in memory (previous vehicle speed), the current vehicle speed is set when the cruise control switch is pushed to the “+ RES” side. (→P.208)

**Turning off Conventional Cruise Control**

Press the “ON-OFF” switch.

 turns off on the meter display and Conventional Cruise Control turns off.

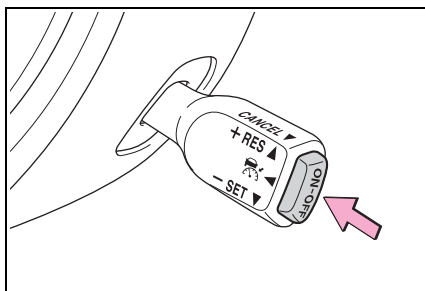

**Pre-Collision Throttle Management\***

\*: If equipped

**When an obstacle is detected in front of the vehicle, and the vehicle is stopped or traveling very slowly, if the system determines that the accelerator pedal has been depressed by more than the necessary amount (due to driver error), it greatly restricts engine output and ensures that vehicle forward movement is slower than normal in order to give the driver additional time to brake or react.**

During system operation, an alert will sound repeated short beeps and a pop-up display will be displayed.

This function only activates when the shift lever is in the D or M position.

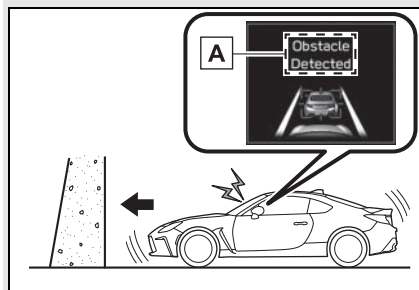

**A** “Obstacle Detected”

- When the accelerator pedal is depressed for approximately 3

seconds, Pre-Collision Throttle Management will be released gradually.

- When Pre-Collision Braking System is turned off, Pre-Collision Throttle Management is also turned off. (→P.219)

 **WARNING**

Do not rely excessively on Pre-Collision Throttle Management. Pre-Collision Throttle Management is not designed to help you avoid collisions in all situations. Always check the shift lever and pedal positions as well as the surrounding environment before starting and operating the vehicle. Relying only on Pre-Collision Throttle Management could result in an accident.

- Pre-Collision Throttle Management is not designed to maintain the vehicle in a stopped condition.
- Pre-Collision Throttle Management will not reduce acceleration under all conditions. It is also not designed to prevent collisions.
- Pre-Collision Throttle Management will operate when an obstacle is detected in front. However, this function will not reduce acceleration in cases where no obstacle is detected (for example when approaching a cliff, etc.).
- Do not intentionally depress the accelerator pedal excessively when there are obstacles nearby. If the driver relies only on Pre-Collision Throttle Management to control acceleration, collisions may occur.

- If your vehicle is trapped on a railroad crossing and you are trying to escape by driving through the crossing gate, the stereo camera may recognize the crossing gate as an obstacle and Pre-Collision Throttle Management system may activate. In this case, remain calm and either continue to depress the accelerator pedal or turn off the Pre-Collision Throttle Management system. (→P.219)

Pre-Collision Throttle Management may not activate depending on the following conditions:

- The distance between your vehicle and the obstacle, speed difference, and horizontal offset
- Recognition status of the stereo camera

In particular, the function may not activate in the following cases:

- Bad weather (for example heavy rain, a blizzard or thick fog)
- Visibility is poor due to sand or smoke in the air.
- Light is poor in the evening, early morning, or at night.
- In a dark area (indoor parking area, etc.)
- There is an obstacle outside the area illuminated by the headlights.
- Strong light is coming from the front (for example sunlight at sunrise or sunset headlight beams, etc.).



**⚠ WARNING**

- The windshield has become fogged, scratched or smeared, or snow, dirt, dust or frost has adhered to it, or it is otherwise affected. These will reduce the stereo camera's field of view. Also, light is reflecting off the dirt, etc.
- Fluid has not been fully wiped off the windshield during or after use of the window washer.
- Obstacles cannot be correctly recognized due to water droplets from rain or the washer, or the wiper blades obstructing the stereo camera's field of view.
- The stereo camera's field of view is obstructed.
- With low obstacles (low wall, crash barrier, low vehicle, etc.)
- The size and height of an obstacle is smaller than the limitations of the stereo camera's recognition capability. (Small animals, children, pedestrians who are sitting or lying down, etc.)
- The rear portion nearest your vehicle is too small or too close (such as a trailer or oncoming vehicle). The system may not recognize the part of that vehicle which is closest to you.

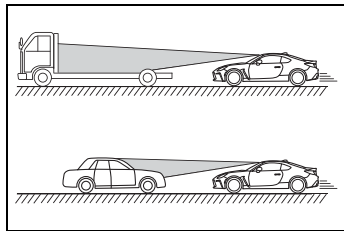

- There is a fence or wall, etc., with a uniform pattern (striped pattern, brick, etc.) or with no pattern in front.

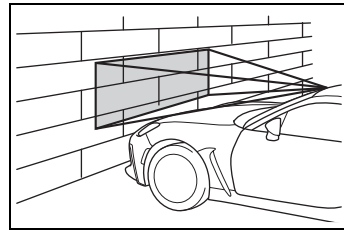

- There is a wall or door made of glass or a mirror in front.
- An obstacle (another vehicle, motorcycle, bicycle, pedestrian, animal or child, etc.) cuts in from the side or jumps out suddenly.
- Your vehicle is immediately behind an obstacle after changing lanes.
- On sharp curves, steep uphill grades or steep downhill grades
- The system determines that steering operation by the driver is intended as evasive action.
- For your safety, do not test Pre-Collision Throttle Management on its own. It may operate improperly and cause an accident.

**⚠ NOTICE**

In the following situations, turn off Pre-Collision Throttle Management. Otherwise Pre-Collision Throttle Management may activate unexpectedly.

- The vehicle is being towed.
- The vehicle is being loaded onto a carrier.

 NOTICE

- A chassis dynamometer, free-rollers or similar equipment is being used.
- A mechanic lifts up the vehicle, starts the engine and allows the wheels to spin freely.
- Driving on a race track
- Passing hanging banners, flags or branches
- Thick/tall vegetation is touching the vehicle.

Pre-Collision Throttle Management may activate in the following situations. Therefore concentrate on safe driving.

- Your vehicle is close to the vehicle in front.
- Passing through an automatic gate
- Your vehicle is in a location where the grade of the road changes rapidly.

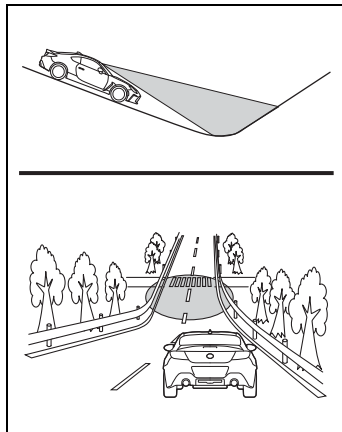

- Passing through clouds of steam or smoke

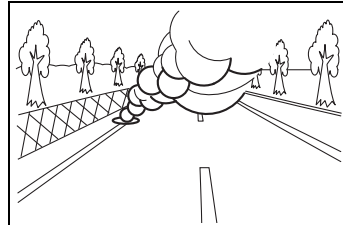

- Passing through water spray from road sprinklers or snow clearing sprinklers on the road

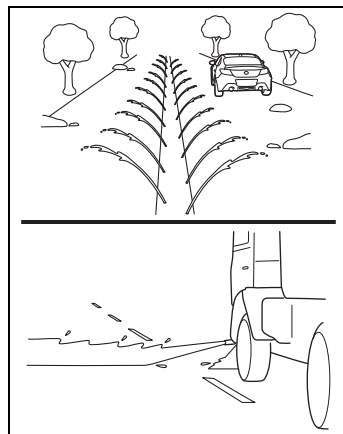

- In adverse weather, such as heavy snow or snowstorms
- There is an obstacle on a curve or intersection.

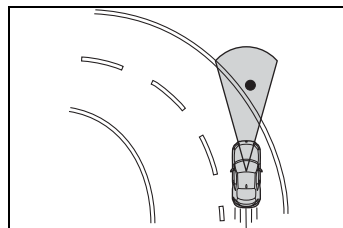

- A vehicle or an object is being narrowly passed.
- Stopping very close to a wall or a vehicle in front

### Turning on/off Pre-Collision Throttle Management

#### ▶ Multimedia system screen

Operate the multimedia system screen to turn on/off Pre-Collision Throttle Management. (→P.400)

#### ▶ Multi-information display

Also you can turn on/off Pre-Collision Throttle Management using the meter operation switch. (→P.400)

If Pre-Collision Throttle Management is turned off, the Pre-Collision Braking System OFF indicator illuminates.

- The on/off setting for Pre-Collision Throttle Management operates in cooperation with Pre-Collision Braking System.
- Even when Pre-Collision Throttle Management is turned off, if the engine switch is turned off and then restarted, Pre-Collision Throttle Management will be turned on. The system default setting when the vehicle is restarted is on.

#### ■ Pre-Collision Braking System OFF indicator

This indicator illuminates when the engine switch is turned to ON, and remains illuminated for approximately 7 seconds after the engine starts. It turns on when Pre-Collision Braking System and Pre-Collision Throttle Management are turned off. It also illuminates under the fol-

lowing conditions.

- TRAC and VSC system are set to off. (→P.263)
- The EyeSight system has a malfunction. (→P.228)
- The EyeSight system has stopped temporarily. (→P.229)

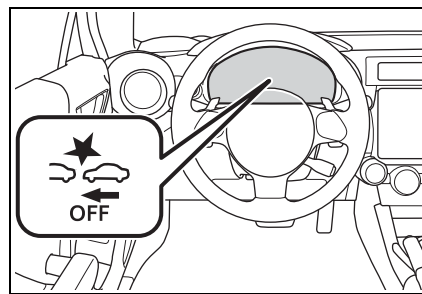

When the Pre-Collision Braking System OFF indicator is turned on, Pre-Collision Braking System (including the Pre-Collision Braking Assist function) and Pre-Collision Throttle Management do not operate.

## Lane Departure Warning\*

\*: If equipped

**When vehicle speed is approximately 30 mph (50 km/h) or more, this function warns the driver if the system detects that the vehicle is likely to depart the traffic lane.**

**When Lane Departure Warning activates, an alert sounds 3 short beeps and a pop-up display will be displayed.**

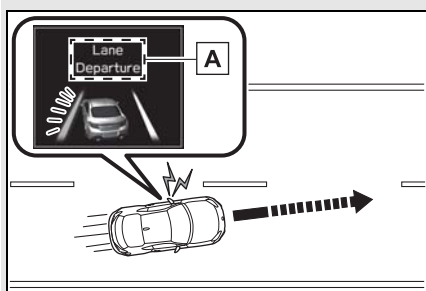

A "Lane Departure"

- The following situations may cause incorrect lane detection and a faulty Lane Departure Warning to occur.
  - There are tire tracks on a wet road or snow-covered road.
  - There are boundaries between snow and asphalt, or marks from road repair, etc.
  - There are the shadows of guardrails.
  - Lane markings are drawn in double.
  - There are some lane markings left from roadwork or markings from the previous road.

- When the Lane Departure Warning OFF indicator is illuminated, Lane Departure Warning is inactive. (→P.221)

### ⚠ WARNING

Lane Departure Warning will not operate in all conditions. It also will not automatically return the vehicle to the original lane. If the driver relies only on Lane Departure Warning to keep the vehicle in the lane, lane departure may occur, resulting in an accident.

Lane Departure Warning activates when it detects lane markings. However, it is not a function which can detect the edge of a road (shoulders or side ditches, etc.) and warn the driver.

### ⚠ NOTICE

In the following situations, Lane Departure Warning may not activate:

- Vehicle speed is approximately 30 mph (50 km/h) or less.
- The steering wheel is turned significantly to either side.
- The vehicle is driving around a curve whose radius is 0.18 miles (300 m) or smaller.
- The brake pedal is depressed or immediately after it is depressed.
- The following distance behind a vehicle in front is short.
- The turn signal is operating.
- For approximately 4 seconds after the turn signal lever has returned to its original position.

 NOTICE

- The vehicle has not returned to the inside of the lane after Lane Departure Warning has activated.
- The lane is narrow.
- It is difficult for the camera to detect lane markings.
  - There are no lane markings or they are very worn.
  - The lane markings are yellow.
  - The lane markings are similar in color to the road surface.
  - The lane markings are narrow.

### Turning on/off Lane Departure Warning

- ▶ Multimedia system screen  
Operate the multimedia system screen to turn on/off Lane Departure Warning. (→P.400)
- ▶ Multi-information display  
Also you can turn on/off Lane Departure Warning using the meter operation switch. (→P.400)

If Lane Departure Warning is turned off, the Lane Departure Warning OFF indicator illuminates.

- The on/off setting for Lane Departure Warning operates in cooperation with Lane Sway Warning.
- The on/off status of Lane Departure Warning is restored when you restart the engine.

### ■ Lane Departure Warning OFF indicator

This indicator illuminates when the engine switch is turned to ON, and then approximately 7 seconds after the engine starts, it turns off or remains illuminated depending on the current status (on or off). It turns on when Lane Departure Warning and Lane Sway Warning are turned off. It also illuminates under the following conditions.

- Pre-Collision Braking System is turned off during TRACK mode. (→P.189, 263)
- TRAC and VSC system are off. (→P.263)
- The EyeSight system has a malfunction. (→P.228)
- The EyeSight system has stopped temporarily. (→P.229)

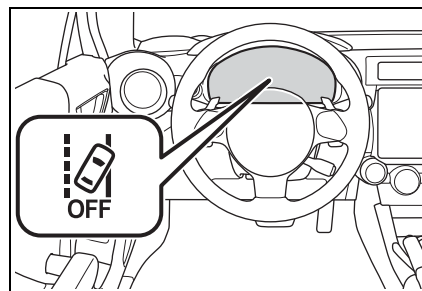

### Lane Sway Warning\*

\*: If equipped

**This function detects swaying or drifting within a lane, and warns the driver. When Lane Sway Warning activates, an alert sounds 3 short beeps and a pop-up display will be displayed.**

**This function activates when the vehicle speed exceeds approximately 37 mph (60 km/h) and deactivates when the vehicle speed falls below approximately 25 mph (40 km/h). The function will reactivate when the vehicle speed is increased to exceed approximately 37 mph (60 km/h).**

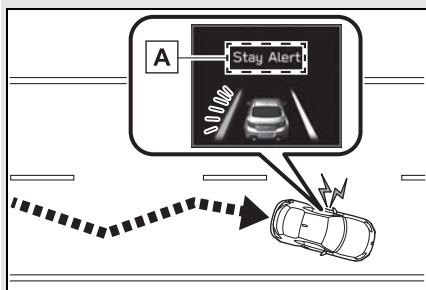

A "Stay Alert"

- Swaying detection is based on several minutes of prior driving data. Swaying will not be detected immediately after the vehicle starts to sway. In addition, the warning may continue for some time even after swaying stops.
- Lane Sway Warning is just a function that warns the driver. When

the driver is tired, not concentrating on the road or not paying adequate attention to driving, be sure to take rest breaks as often as needed.

- When the Lane Departure Warning OFF indicator is illuminated, Lane Sway Warning will not operate. (→P.223)

#### ! WARNING

Lane Sway Warning will not operate in all conditions. It also will not automatically correct swaying. If the driver relies only on Lane Sway Warning to prevent the vehicle from swaying, an accident may occur.

#### ! NOTICE

Under the following conditions, Lane Sway Warning may not operate.

- On a winding road
- The vehicle speed changes greatly.
- Immediately after a lane change
- It is difficult for the EyeSight stereo camera to detect lane markings.
  - There are no lane markings or they are the very worn.
  - The lane markings are yellow.
  - The lane markings are similar in color to the road surface.
  - The lane markings are narrow.

### Turning on/off Lane Sway Warning

- ▶ Multimedia system screen

Operate the multimedia system

screen to turn on/off Lane Sway Warning. (→P.400)

▶ Multi-information display

Also you can turn on/off Lane Sway Warning using the meter operation switch. (→P.400)

If Lane Sway Warning is turned off, the Lane Departure Warning OFF indicator illuminates.

(→P.229)

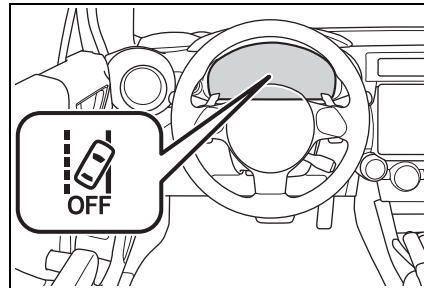

- The on/off setting for Lane Sway Warning operates in cooperation with Lane Departure Warning.
- The on/off status of Lane Sway Warning is restored when you restart the engine.

■ **Lane Departure Warning OFF indicator**

This indicator illuminates when the engine switch is turned to ON, and then approximately 7 seconds after the engine starts, it turns off or remains illuminated depending on the current status (on or off). It turns on when Lane Departure Warning and Lane Sway Warning are turned off. It also illuminates under the following conditions.

- Pre-Collision Braking System is turned off during TRACK mode. (→P.189, 263)
- TRAC and VSC system are off. (→P.263)
- The EyeSight system has a malfunction. (→P.228)
- The EyeSight system has stopped temporarily.

## Lead Vehicle Start Alert\*

\*: If equipped

When the vehicle stopped in front starts to move, Lead Vehicle Start Alert notifies the driver by indicator on the meter display and notification. When the vehicle in front remains stopped continuously (within a following distance of approximately 32 ft (10 m) and the driver's vehicle remains stopped for several seconds or longer), the system continues to detect the vehicle in front and this alarm activates if the vehicle in front advances approximately 10 ft (3 m) or more while the driver's vehicle remains stationary.

This function only activates when the shift lever is in the D, M or N position. When Lead Vehicle Start Alert activates, a notification sounds a two-tone beep and a pop-up display will be displayed.

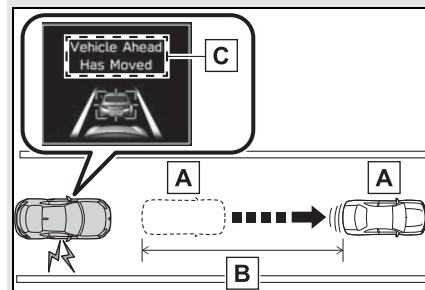

- A** Lead vehicle
- B** 10 ft (3 m) or more
- C** "Vehicle Ahead Has Moved"

- The Lead Vehicle Start Alert setting can be turned on or off. (→P.400)
- Under the following conditions, Lead Vehicle Start Alert may activate even when the vehicle in front has not started to move, or may not activate even after the vehicle in front has started to move:
  - A motorcycle or similar object cuts in between your vehicle and the stopped vehicle in front.
  - Weather or road conditions may interfere with the detection of the vehicle in front.
  - The EyeSight stereo camera loses detection of the vehicle in front.
- Under the following conditions, Lead Vehicle Start Alert will not activate.
  - Pre-Collision Braking System is turned off during TRACK mode. (→P.189, 263)
  - TRAC and VSC system are off. (→P.263)
  - The EyeSight system has a malfunction. (→P.228)
  - The EyeSight system has stopped temporarily. (→P.229)



 **WARNING**

Even after alerts are given audibly and through the display of an indicator, be sure to carefully check the area surrounding the vehicle before pulling away. Relying solely on Lead Vehicle Start Alert may result in an accident.

## List of alert/notification sounds

## List of alert/notification sounds

Alert/notification sound	Status	Reference page
Single continuous beep	Pre-Collision Braking System: Secondary Braking is active.	→P.186
1 short beep and 1 long beep	Adaptive Cruise Control or Conventional Cruise Control is canceled automatically.	→P.203, 213
Repeated short beeps	Pre-Collision Braking System: First Braking is active.	→P.186
	Pre-Collision Braking System: The following distance warning is active.	
	The "Obstacle Detected" warning from Adaptive Cruise Control is active.	→P.206
3 short beeps	Pre-Collision Throttle Management is active.	→P.215
	Lane Departure Warning is active.	→P.220
3 intermittent beeps, 1 short beep and 1 long beep	Lane Sway Warning is active.	→P.222
	Pre-Collision Braking System: Just before the automatic brake is slowly released by the system after the vehicle is stopped by the pre-collision braking.	→P.186
	Adaptive Cruise Control system: Just before the automatic brake is released by the system after the vehicle is stopped by the Adaptive Cruise Control system. Adaptive Cruise Control system will stop the vehicle according to the lead vehicle stops.	→P.203

Alert/notification sound	Status	Reference page
1 short beep	Either of the following occurs while Adaptive Cruise Control is activated. <ul style="list-style-type: none"> <li>• A vehicle in front is detected* .</li> <li>• A vehicle in front is no longer detected* .</li> </ul>	→P.189
	The cruise control mode (Adaptive Cruise Control/Conventional Cruise Control) is changed.	→P.208
	EyeSight is malfunctioning.	→P.228
	EyeSight operation is temporarily stopped.	→P.229
Two-tone beep	Lead Vehicle Start Alert is active* .	→P.224

\* : The notification that indicates when a lead vehicle is detected or when it is no longer detected (Lead Vehicle Acquisition Sound), as well as Lead Vehicle Start Alert can be turned on or off. (→P.400)

EyeSight malfunction and temporary stop

If a malfunction is detected in the EyeSight system, the indicators in the instrument panel and the meter display inform the driver of the malfunction. Check the displayed contents and take the appropriate action.

Malfunction (including position/angle misalignment of stereo camera)

The alert sounds 1 short beep and  (yellow) blinks or illuminates. At the same time, the Pre-Collision Braking System OFF indicator and the Lane Departure Warning OFF indicator will illuminate. A message will also be displayed on the meter display.

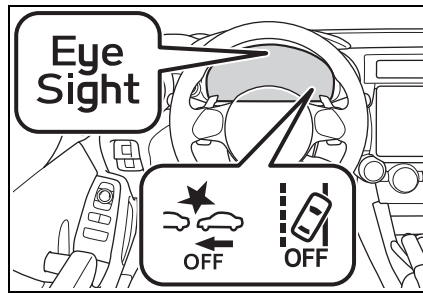



Warning message	Cause	Action
"EyeSight OFF Check Manual"	An EyeSight malfunction or position/angle misalignment of the stereo camera has occurred.	Inspection and adjustment is necessary. Contact your Toyota dealer.

- If  (yellow) is illuminating or blinking, stop the vehicle in a safe location, turn off the engine and then restart it.
- If the indicator continues illuminating or flashing even after the engine has been restarted, the EyeSight system has a malfunction. In this case, all EyeSight functions will be stopped. Normal driving will still be possible. How-

ever, contact a Toyota dealer for an inspection.

- If  (yellow) illuminates or flashes, the Reverse Automatic Braking (RAB) system will not operate.

 NOTICE

If both  (yellow) and the malfunction indicator lamp illuminate at the same time while driving, have your vehicle checked/repaired by a Toyota dealer as soon as possible. EyeSight cannot be used if there is an abnormality with the engine, etc.

**Temporary stop**

The alert will sound 1 short beep, and the EyeSight temporary stop indicator  (white), the Pre-Collision Braking System OFF indicator and the Lane Departure Warning OFF indicator will illuminate at the same time.

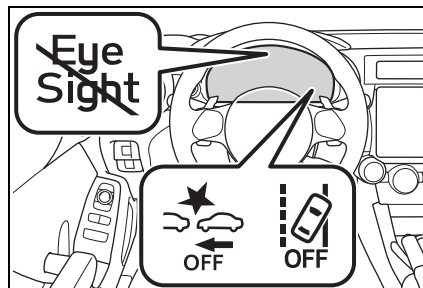

A message will also be displayed on the meter display. When the cause has been resolved, temporary stop will be canceled and the EyeSight system will automatically restart.



---

Warning message	Cause	Action
"EyeSight Disabled No Camera View"	It is difficult for the stereo camera to detect objects in front. <ul style="list-style-type: none"><li>• The windshield is dirty or fogged up.</li><li>• Poor weather conditions</li><li>• Strong light from the front</li></ul>	<ul style="list-style-type: none"><li>• Clean the windshield.</li><li>• In poor weather conditions or if there is strong light from the front, the EyeSight system will restart once you have driven your vehicle for a period of time and the conditions affecting the system have improved. If the system does not restart, even after the conditions have improved and a period of time has elapsed, contact your Toyota dealer for an inspection.</li></ul>

Warning message	Cause	Action
“EyeSight Disabled Temp Range”	In low or high temperatures	The system will restart once the temperature is within the operational range of the EyeSight system. If the system does not restart, even when the temperature inside the vehicle is within the operational range, contact your Toyota dealer for an inspection.
“EyeSight Disabled Check Manual”	<ul style="list-style-type: none"> <li>• The EyeSight system is starting up.</li> <li>• The system has determined that the vehicle is extremely inclined.</li> <li>• The Pre-Collision secondary braking has operated 3 times after the engine was started.</li> <li>• The engine has stopped.</li> </ul>	The system will restart once the cause has been resolved. At this time, it may take some time for the system to restart. If the system does not restart, even after the conditions have improved and a period of time has elapsed, contact your Toyota dealer for an inspection.

- When  (white) is illuminated, no EyeSight functions can be used except for Conventional Cruise Control.
- When  (white) is illuminated, the Reverse Automatic Braking (RAB) system may not operate.

**BSD/RCTA\***

\*: If equipped

**The BSD/RCTA consists of rear corner radars with Blind Spot Detection, Lane Change Assist and Rear Cross Traffic Alert.**

**These functions of BSD/RCTA are the systems that detect objects and vehicles to the rear and draw attention to the driver when changing a lane or when driving in reverse.**

**⚠ WARNING**

The driver is responsible for driving safely. Always be sure to check the surroundings with your eyes when changing lanes or reversing the vehicle.

The system is designed to assist the driver in changing lanes or reversing safely by monitoring the rear and side areas of the vehicle. However, you cannot rely on this system alone in assuring the safety during a lane change or reversing. Overconfidence in this system could result in an accident and lead to serious injury or death. Since the system operation has various limitations, the flashing or illumination of the BSD/RCTA approach indicator may be delayed or it may not operate at all even when a vehicle is present in a neighboring lane or approaching from either side.

The driver is responsible for paying attention to the rear and side areas of the vehicle.

**System features**

BSD/RCTA consists of the following functions.

- To detect a vehicle in a blind spot on an adjacent lane or a vehicle approaching at high speed while driving the vehicle (Blind Spot Detection)
- To detect a vehicle approaching from the right or left while reversing the vehicle (Rear Cross Traffic Alert)

The system uses radar sensors for the following features.

The BSD/RCTA radar sensor has been certified by the radio wave related laws of the U.S. and other FCC compliant countries and Canada. When driving in other countries, certification of the country where the vehicle is driven must be obtained. For certification in the U.S. and other FCC compliant countries and Canada, refer to P.440.

**■ Blind Spot Detection (BSD)**

The system notifies the driver of the presence of vehicles in its blind spot.

- If the system detects a vehicle in its blind spot, it warns the driver by illuminating the BSD/RCTA approach indicator(s) on the outside mirror(s).
- If the driver operates the turn signal lever in the direction where the BSD/RCTA approach indicator is illuminating, the system warns the



driver of dangers by flashing the BSD/RCTA approach indicator.

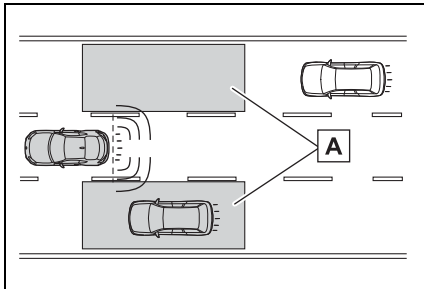

A Operating range

■ Lane Change Assist (LCA)

The system notifies the driver of vehicles approaching at a high speed in the neighboring lanes.

- If the system detects a vehicle approaching at a high speed in the neighboring lanes, it warns the driver of dangers by illuminating the BSD/RCTA approach indicator(s) on the outside mirror(s).
- If the driver operates the turn signal lever in the direction where the BSD/RCTA approach indicator is illuminating, the system warns the driver of dangers by flashing the BSD/RCTA approach indicator.

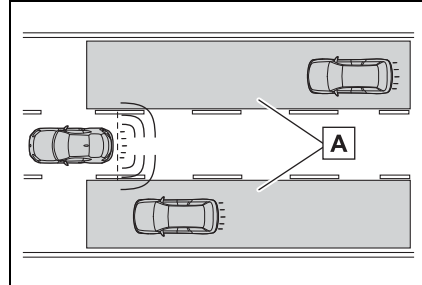

A Operating range

■ Rear Cross Traffic Alert (RCTA)

The system notifies the driver of another vehicle approaching from either side when driving in reverse. This feature helps the driver check the rear and side areas of the vehicle when moving backward.

If the system detects a vehicle approaching from either side while moving backward, it warns the driver of dangers in the following way.

- The BSD/RCTA approach indicator(s) on the outside mirror(s) flashes.
- A warning buzzer sounds.
- An icon appears on the multimedia system screen.

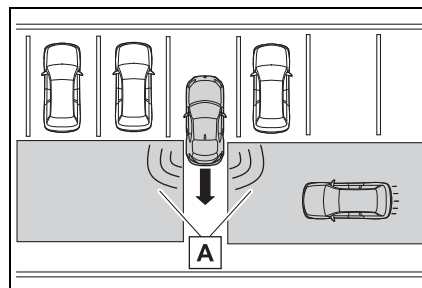

**A** Operating range

- Limitations of the detectability of RCTA

Since the detectability of RCTA is limited, the RCTA may not operate properly in angled parking.

Example 1

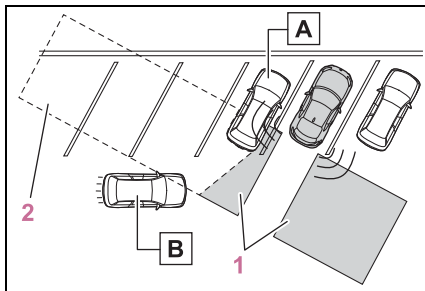

- 1 The detection range of the radar sensors
- 2 Area out of detection range of the radar sensors

- A** Parked vehicle
- B** Vehicle that may not be detected

**! WARNING**

An approaching vehicle **B** may not be detected because the detection range is limited by the parked vehicle **A**. Always be sure to check the surroundings with your eyes when reversing the vehicle.

Example 2

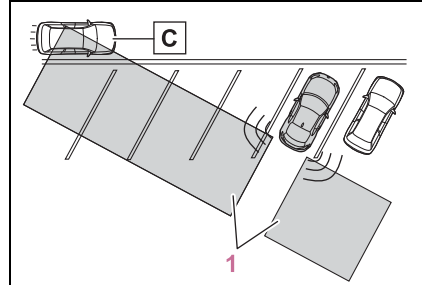

- 1 The detection range of the radar sensors

- C** Vehicle that may be detected

The system may detect that a vehicle **C** is passing in front of your vehicle. Always be sure to check the surroundings with your eyes when reversing the vehicle.

**System operation**

■ **Operating conditions**

The BSD/RCTA will operate when all of the following conditions are met.

- The engine switch is in ON.
- The BSD/RCTA warning light and BSD/RCTA OFF indicator are turned off.
- The vehicle is driven at speeds above 7 mph (12 km/h) (except when reversing).
- The shift lever is in R. (RCTA only)

The BSD/RCTA will not operate in the following situations.

- The BSD/RCTA OFF indicator appears.

- The vehicle speed is below 6 mph (10 km/h) even when the BSD/RCTA OFF indicator does not appear (except when reversing).
- 
- In the following cases, the BSD/RCTA will stop operating and the BSD/RCTA warning light will appear.
    - When a malfunction occurs in the system, including the BSD/RCTA approach indicator
  - If the BSD/RCTA warning light appears, exercise proper caution. (→P.238)
  - In the following cases, the BSD/RCTA will temporarily stop operating (or may stop operating) and the BSD/RCTA OFF indicator will appear.
    - When the radar sensor becomes significantly misaligned (If the orientation of the radar sensor is shifted for any reason, readjustment is required. Have the sensor adjusted at a Toyota dealer.)
    - When a large amount of snow or ice sticks to the rear bumper surface around the radar sensors
    - When the vehicle is driven on a snow-covered road or in an environment in which there are no objects around (such as in a desert) for a prolonged period of time
    - When the temperature around the radar sensors increases excessively due to long driving on uphill grades in the summer, etc.
    - When the temperature around the radar sensors becomes extremely low
    - When the vehicle battery voltage lowers
    - When the vehicle voltage exceeds the battery voltage rating
  - The BSD/RCTA will resume operation once these conditions are corrected, and the BSD/RCTA OFF indicator will disappear. However, if the BSD/RCTA OFF indicator appears for a prolonged period of time, have the system inspected at a Toyota dealer as soon as possible.
  - The detectability of the radar sensors is restricted. The BSD/RCTA detection may be impaired and the system may not operate properly under the following conditions.
    - When the rear bumper around the radar sensors is distorted
    - When ice, snow or mud adheres to the rear bumper surface around the radar sensors
    - When stickers, etc. are affixed on the areas of the radar sensors on the rear bumper
    - During adverse weather conditions such as rain, snow or fog
    - When driving on wet roads such as snow-covered roads and through puddles
  - The radar sensors may not detect or may have difficulty detecting the following vehicles and objects.
    - Small motorcycles, bicycles, pedestrians, stationary objects on the road or road side, etc.
    - Vehicles with body shapes that the radar may not reflect (vehicles with lower body height such as a trailer with no cargo and sports cars)
    - Vehicles that are not approaching your vehicle even though they are in the detection area (either on a neighboring lane to the rear or beside your vehicle when reversing) (The system determines the presence of approaching vehicles based on data detected by the radar sensors.)
    - Vehicles traveling at significantly different speeds
    - Vehicles driving in parallel at almost the same speed as your vehicle for a prolonged time
    - Oncoming vehicles
    - Vehicles in a lane beyond the neighboring lane
    - Vehicles travelling at a significantly lower speed than you are

trying to overtake

- On a road with extremely narrow lanes, the system may detect vehicles driving in a lane next to the neighboring lane.

### BSD/RCTA approach indicator/warning buzzer

While the BSD/RCTA is active, the following item(s) will operate to alert the driver:

- The BSD/RCTA approach indicator (when there are vehicles in the neighboring lanes).
- The BSD/RCTA approach indicator and warning buzzer (when a vehicle is approaching from the left or right side while your vehicle is reversing)

#### ■ BSD/RCTA approach indicator

It is mounted on each side of the outside mirrors.

The indicator will illuminate when a vehicle approaching from behind is detected.

The indicator will flash to warn the driver of dangers under the following conditions.

- While the indicator is illuminating, if the turn signal lever is operated toward the side in which this indicator turned on
- When reversing the vehicle while the system detects a vehicle approaching from

either side

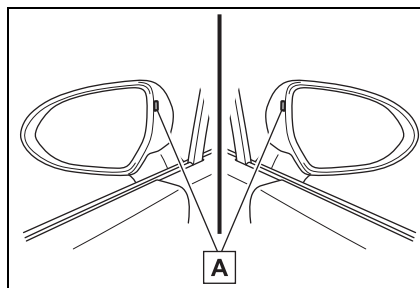

**A** BSD/RCTA approach indicator

- ▶ BSD/RCTA approach indicator dimming function

When the headlights are turned on, the brightness of the BSD/RCTA approach indicator will be reduced.

- You may have difficulty seeing the BSD/RCTA approach indicator under the following conditions.
  - When sunlight shines directly on it
  - When the headlight beams from a vehicle traveling behind shines directly on it
- While the illumination brightness control dial is in the fully upward position, even if the headlights are turned on, the brightness of the BSD/RCTA approach indicator will not be reduced. For details about the illumination brightness control dial, refer to P.91.

#### ■ BSD/RCTA approach warning buzzer (only when reversing)

A warning buzzer sounds along with flashing of the BSD/RCTA approach indicator to warn the driver of dangers. The setting of the warning buzzer volume can

be changed by operating the multimedia system screen.  
(→P.400)

■ **Safety tips regarding the BSD/RCTA approach indicator/warning buzzer**

- In the following cases, operation of the BSD/RCTA approach indicator and the warning buzzer may be delayed or the system may fail to issue these warnings.
  - When a vehicle moves to the neighboring lane from a lane next to the neighboring lane
  - When driving on a steep incline or on repeated sharp uphill and downhill grades
  - When going beyond a pass
  - When both your vehicle and a vehicle driving on a neighboring lane are driving on the far side of each lane.
  - When several narrowly-spaced vehicles are approaching in a row
  - In low radius bends (tight bends or when making turns at an intersection)
  - When there is a difference in height between your lane and the neighboring lane
  - Immediately after the BSD/RCTA is activated by touching "BSD/RCTA"
  - Immediately after the shift lever is shifted to R
  - When extremely heavy cargo is loaded in the trunk
  - During reversing, operation of

the BSD/RCTA approach indicator and the warning buzzer may be delayed or the system may fail to issue these warnings under the following conditions.

- When backing out of an angled parking space
- When a large-sized vehicle is parked next to your vehicle (That vehicle prevents the propagation of radar waves.)
- When reversing on sloped roads
- When reversing at a high speed
- The BSD/RCTA approach indicator may illuminate when driving close to solid objects on the road or road side (such as guardrails, tunnels and sidewalls).

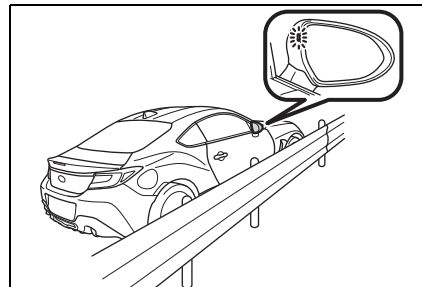

- When turning at an intersection in urban areas, or a multi-lane intersection, the BSD/RCTA approach indicator may flash.
- If a building or a wall exists in the reversing direction, the BSD/RCTA approach indicator may flash and the warning buzzer may sound.

- In the following cases, the system may detect a vehicle driving two lanes away from your vehicle.
- When your vehicle drives on the near side of its lane from the corresponding vehicle
- When the vehicle driving two lanes away drives on the near side of its lane from your vehicle

**BSD/RCTA OFF indicator**

■ **System temporary stops**

This display appears when the system is used at extremely high or low temperatures or when abnormal voltage exists. Once these conditions are corrected, the system will recover from the temporary stop condition and the indicator will disappear.

If the indicator remains displayed for a prolonged time, have the system inspected at a Toyota dealer.

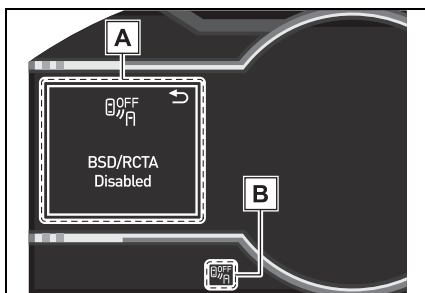

- A "BSD/RCTA Disabled"
- B BSD/RCTA OFF indicator

■ **System temporary stops due to reduced radar sensitivity**

This display appears when the detectability of the radar sensors is reduced. Once the condition is corrected, the system will recover from the temporary stop condition and the indicator will disappear.

If the indicator remains displayed for a prolonged time, have the system inspected at a Toyota dealer.

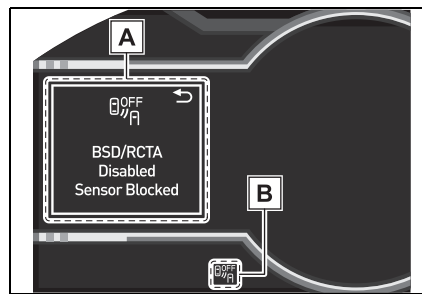

- A "BSD/RCTA Disabled Sensor Blocked"
- B BSD/RCTA OFF indicator

**BSD/RCTA warning light**

■ **System malfunction**

This display appears when a malfunction occurs in the system. Contact a Toyota dealer and have the system inspected.

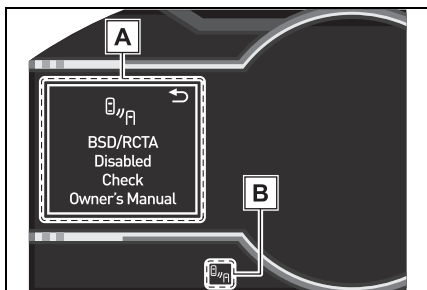

**A** “BSD/RCTA Disabled Check Owner's Manual”

**B** BSD/RCTA warning light

### To turn on/off the BSD/RCTA

To turn the BSD/RCTA system on and off, operate the multi-information display (→P.400) or multimedia system screen (Refer to “MULTIMEDIA OWNER'S MANUAL”).

When the BSD/RCTA system is turned OFF, the BSD/RCTA OFF indicator on the multi-information display will illuminate.

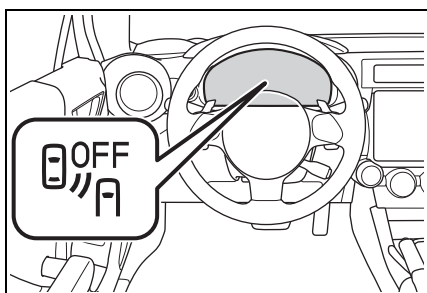

- In the following cases, turn off the BSD/RCTA system. The system may not operate properly due to blocked radar waves.
  - When towing the vehicle
  - When a bicycle carrier or other

item is fitted to the rear of the vehicle

- When using a chassis dynamometer or free roller device, etc.
- When running the engine and making the wheels rotate while lifting up the vehicle
- If the engine switch is turned to OFF, the last known status of the system is maintained. For example, if the engine switch is turned to OFF with the BSD/RCTA deactivated, the BSD/RCTA remains deactivated the next time the engine switch is turned to ON.

### Handling of radar sensors

The radar sensors, one on each side of the vehicle, are mounted inside the rear bumper.

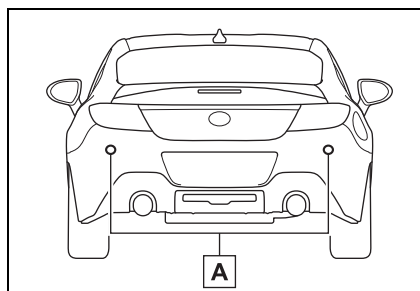

**A** Radar sensors

If the radar sensors require repair or replacement, or the bumper area around the radar sensors requires repair, paintwork or replacement, contact your Toyota dealer for assistance.

#### NOTICE

To ensure correct operation of the BSD/RCTA, observe the following precautions.

 NOTICE

- Always keep the bumper surface near the radar sensors clean.
- Do not affix any stickers or other items on the bumper surface near the radar sensors. For details, consult your Toyota dealer.

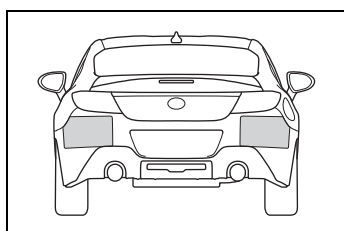

- Do not modify the bumper near the radar sensors.
- Do not paint the bumper near the radar sensors.
- Do not expose the bumper near the radar sensors to strong impacts. If a sensor becomes misaligned, a system malfunction may occur, including the inability to detect vehicles entering the detection areas. If any strong shock is applied to the bumper, be sure to contact your Toyota dealer for inspection.
- Do not disassemble the radar sensors.

**Reverse Automatic Braking (RAB) system \***

\*: If equipped

**Reverse Automatic Braking (RAB) is a system designed to help avoid collisions or reduce collision damage when reversing the vehicle. If a wall or an obstacle is detected in the reversing direction, the system will notify the driver with a warning sound and may activate the vehicle's brakes automatically.**

The Reverse Automatic Braking (RAB) system records and stores the following data when automatic braking operates. It does not record conversations, personal information or other audio data.

- Distance from the object
- Vehicle speed
- Accelerator pedal operation status
- Brake pedal operation status
- Shift lever position
- Outside temperature
- The sensitivity setting of the sonar sensors

Toyota and third parties contracted by Toyota may acquire and use the recorded data for the purpose of vehicle research and development. Toyota and third parties contracted by Toyota will not disclose or provide the acquired data to any other third party except under the following conditions.

- The vehicle owner has given his/her consent.
- The disclosure/provision is based



on a court order or other legally enforceable request.

- Data that has been modified so that the user and vehicle cannot be identified is provided to a research institution for statistical processing or similar purposes.

**⚠ WARNING**

- Reverse Automatic Braking (RAB) is not a system intended to replace the driver's responsibility to check their surroundings for vehicles or obstacles to avoid a collision.
- The driver is responsible for driving safely. Before reversing, be sure to first depress the brake pedal and visually check the surroundings.
- There are some cases in which the vehicle cannot avoid collision, because the system operation has limitations. The warning sound or automatic braking may be delayed or may not operate at all even when an obstacle is present.
- Make sure to set the Automatic Braking to OFF when the vehicle is on the free roller or on the chassis dynamometer. Otherwise, the vehicle may move and it may cause an accident.
- Make sure to set the Automatic Braking to OFF when towing the vehicle. Otherwise, the vehicle may move and it may cause an accident.
- The system is not designed to detect people (including children), animals or other moving objects.

- Depending on the vehicle condition or the surrounding environment, the sonar sensor's ability to detect objects may become unstable.

**Reverse Automatic Braking (RAB) system overview**

The Reverse Automatic Braking (RAB) system will operate the following 2 functions using 4 sonar sensors.

● **Sonar Audible Alarm**

The Reverse Automatic Braking (RAB) system detects objects rearward and warns the driver by warning message on the multimedia system screen and warning beeps.

● **Automatic Braking**

The automatic braking detects objects rearward and if there is a high risk of a collision, the system decelerates the vehicle and controls the braking to reduce damage.

▶ **When reversing**

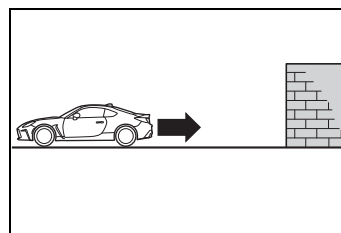

▶ **When either strong automatic braking or torque control is applied to prevent collision (in**

this case, short warning beeps or continuous warning beeps will sound)

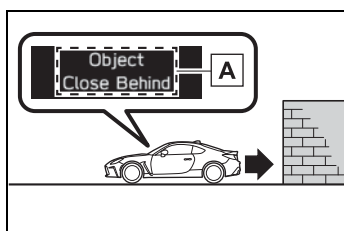

A "Object Close Behind"

- ▶ When the vehicle is stopped by the system (in this case, the continuous beep will remain sounding)

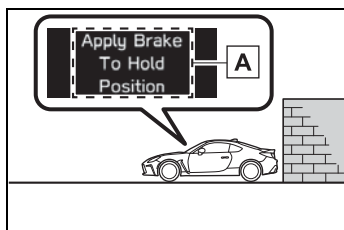

A "Apply Brake To Hold Position"

**⚠ WARNING**

If your vehicle is trapped on a railroad crossing and you are trying to escape by reversing through the crossing gate, the system may recognize the crossing gate as an obstacle and brake may activate. In this case, remain calm and either continue to depress the accelerator pedal or cancel the system. (→P.248)

**Operating conditions**

The Reverse Automatic Braking (RAB) system will operate when all of the following conditions are

met.

- The engine switch is in ON.
- The EyeSight warning light is off.
- The RAB warning light is off.
- The RAB OFF indicator is off.
- The shift lever is in the R.

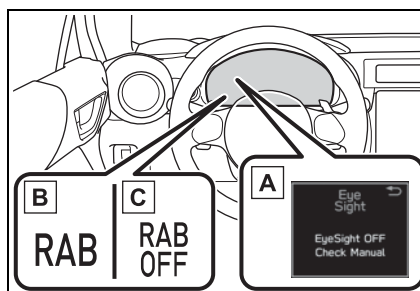

A EyeSight warning light

B RAB warning light

C RAB OFF indicator

- ▶ Sonar Audible Alarm
  - The Sonar Audible Alarm is set to "ON".
  - The vehicle speed is from 0 to 9 mph (0 to 15 km/h).
- ▶ Automatic Braking
  - The Automatic Braking is set to "ON".
  - The vehicle speed is from 1 to 9 mph (1.5 to 15 km/h).

- In the following cases, the Reverse Automatic Braking (RAB) system will not operate. Promptly contact a Toyota dealer to have the system inspected.
  - The EyeSight warning light is illuminated.
  - The RAB warning light is illuminated.

nated.

- In the following cases, the Reverse Automatic Braking (RAB) system cannot be operated.
  - The RAB OFF indicator is illuminated.
- In the following cases, the functions may not be able to properly work. Promptly contact a Toyota dealer to have the system inspected.
  - A sticker, paint, or a chemical is applied to the sonar sensors or the rear bumper near the sonar sensor.
  - The rear bumper is modified.
  - The rear bumper has been removed and attached.
  - The ground clearance is changed due to the vehicle's loading condition or modification.
  - There is damage to the sonar sensors or the rear bumper near the sonar sensor.
  - The rear bumper is exposed to strong impact, or the rear bumper is deformed.
- On a steep hill, the system's automatic braking ability will be reduced.
- The system is designed to avoid collisions by automatic hard braking when the vehicle's reversing speed is less than approximately 3 mph (5 km/h). However, the system does not guarantee that the vehicle will be able to avoid collisions in any situation.
- If the vehicle is reversed at an extremely slow speed, the driver's operation may be prioritized. In this case, automatic braking will not operate.
- The system may not be able to detect and apply the brake with the following objects.
  - Sharp or thin objects such as poles, fences and ropes which may not reflect the sound wave emitted from the sonar sensor.
  - Objects that are too close to the rear bumper when the shift lever is

set to R.

- Objects with a surface which may not reflect the sound wave emitted from the sonar sensor such as a chain link fence.
- Objects the system is not designed to detect and apply brake.
  - Pedestrians.
  - Moving objects including moving vehicles.
  - Objects which absorbs sound waves such as cloth or snow.
  - Objects whose surface has a diagonal angle.
  - Objects that are low to the ground such as parking blocks.
  - Objects that are high above the ground such as objects hanging from above.
  - Objects that are out of range of the center of the vehicle in the horizontal direction.
  - Objects that are not in a vertical direction.
  - Objects which are not perpendicular to the ground.
  - Objects which are not directly in the traveling direction of the vehicle.
  - Objects which are uneven or wavy.
- When reversing the vehicle, the functions may not be able to work properly or may cause a system malfunction if the following conditions exist.

High frequency sound from other sources are nearby:

- Horn sound from another vehicle.
- Engine sound from other vehicles.
- Sound of an air brake.
- Vehicle detection equipment or a sonar from another vehicle.
- A sound wave with a frequency similar to the vehicle's system is transmitted near by.
- A vehicle equipped with the same system is reversing toward your reversing direction.
- Weather conditions:
  - Extremely high or extremely low

temperatures in which the area near the sonar sensor becomes too hot or too cold to operate.

- The sonar sensors or the rear bumper near the sonar sensors are exposed to heavy rain or a significant amount of water.
- Fog, snow or sandstorm, etc.
- Air is moving rapidly such as when a strong wind is blowing.
- Parts attached to the rear bumper near the sonar sensor:
  - Commercial electronic parts (fog light, fender pole, radio antenna) or commercial attachment parts (trailer hitch, bicycle carrier, bumper guard) are attached.
  - Parts that emit high frequency sound, such as a horn or speaker, are attached.
- Vehicle conditions:
  - Ice, snow or mud is adhered to the sonar sensors or the rear bumper near the sonar sensor.
  - The vehicle is significantly inclined.
  - The ground clearance is significantly reduced due to the vehicle's loading condition, etc.
  - When the sonar sensor is misaligned due to a collision or an accident.
- Surrounding environment:
  - A cloth banner, flag, hanging branch or railroad crossing bars are present in the reversing direction.
  - When reversing on a gravel or grassy area.
  - When reversing in an area where objects or walls are adjacent to the vehicle such as narrow tunnels, narrow bridges, narrow roads or narrow garages.
  - Wheel track or hole is present in the ground of the reversing direction.
  - When reversing over a drainage cover (grating cover).
  - The path of the reversing direction is inclined such as on a steep uphill.

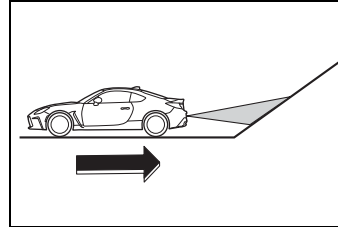

- When reversing downhill.

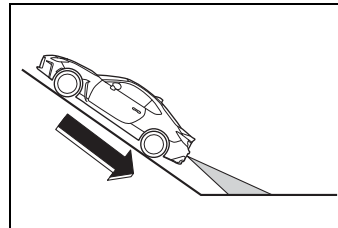

- Reversing in a garage with a low ceiling or a tunnel.
- A curb or step is present in the reversing direction.

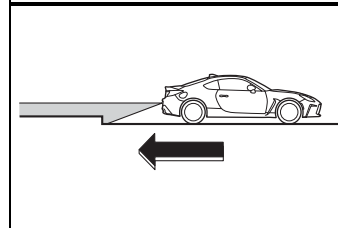
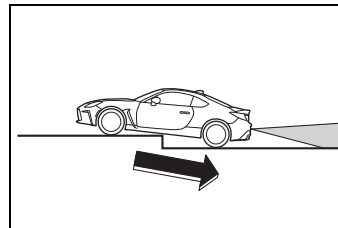

- There is a patch of snow rearward.
- There is a puddle of water.
- There is an obstacle that is next to an object.
- Going back along a wall.
- The area where the road starts touching dirt and snow.
- When reversing on an uneven road.

- In circumstances such as the following, it may not be possible to avoid a collision even when the system operates normally.
  - Roads are slippery.
  - The tire air pressure is not correct.
  - The tires have become worn.
  - Tire chains are installed.
  - Tires which are not the designated size are installed.
- Emergency repairs were performed using a puncture repair kit.
- The suspension was modified.
- Vehicle driving is unstable due to accident or malfunction.
- The brake system warning light is illuminated.

### Sonar Audible Alarm

When Reverse Automatic Braking (RAB) system is in operation, an audible warning beeps will sound in 3 levels to warn the driver of a potential collision.

It may take time to display the wall and sound warning beeps after the object was recognized by the Sonar Audible Alarm.

Alert level	Range of detected object*	Distance indicator	Alarm pattern
Long proximity (object detected)	35 in (90cm) or more	Green	No warning sound
Medium proximity alert (approaching the object)	28 to 35 in (70 to 90cm)	Yellow	Short beeps
Short proximity alert (approaching closer to the object)	20 to 28 in (50 to 70cm)	Orange	Rapid short beeps
Closest proximity alert (too close to the object)	20 in (50cm) or less	Red	Continuous beep

\*: Range of detection may vary depending on the environmental condition.

#### ■ Obstacle detected and alert level

When an object is detected in the reversing direction, the range of detected object will be shown on the multimedia system screen.

A warning alarm will sound and, depending on the speed, either torque control to generate engine braking or automatic braking will be applied.

- ▶ Long proximity alert (object detected)

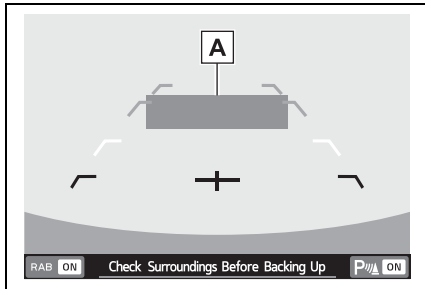

**A** Green: 35 in (90 cm) or more

- ▶ Medium proximity alert (approaching the object)

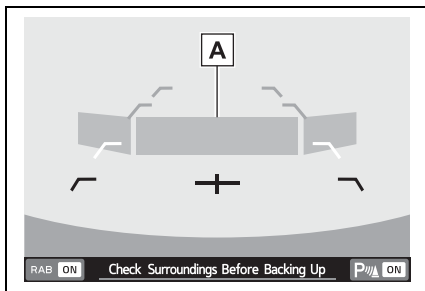

**A** Yellow: 28 to 35 in (70 to 90 cm)

- ▶ Short proximity alert (approaching closer to the object)

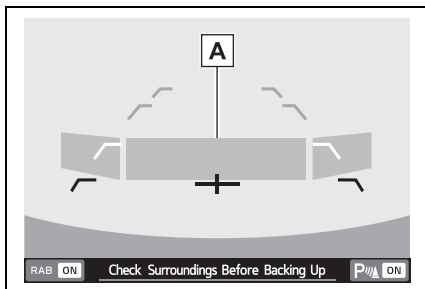

**A** Orange: 20 to 28 in (50 to 70 cm)

- ▶ Closest proximity alert (too close to the object)

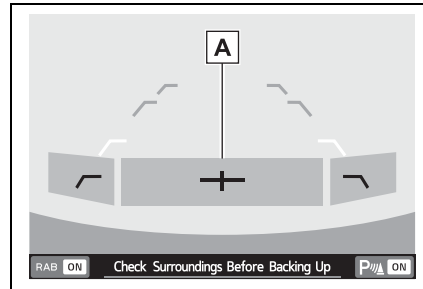

**A** Red: 20 in (50 cm) or less

### Automatic Braking operation

#### ■ Object close behind warning

If the system determine the risk of collision with the object. Short warning beeps or continuous warning beeps will sound and either strong automatic braking or torque control will be applied to prevent collision.

At this time, a warning message is also displayed on the multi-information display.

- ▶ Automatic braking warning

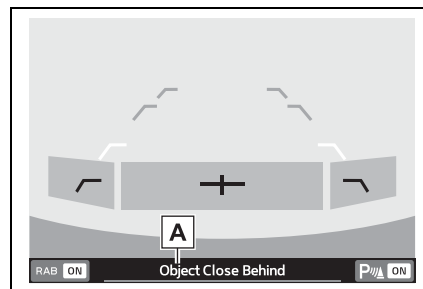

**A** "Object Close Behind"

Make sure to depress the brake pedal once the vehicle has been stopped by automatic braking. Until the brake pedal is depressed, a message will be displayed on the multimedia system screen and the continuous beep will remain sounding. At this time, a warning message is also displayed on the multi-information display.

► Depress brake pedal warning

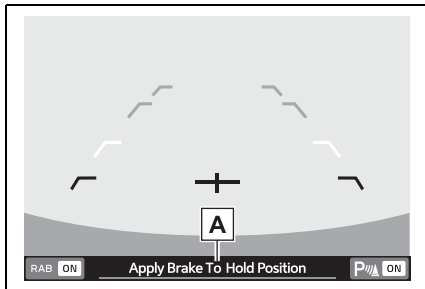

**A** “Apply Brake To Hold Position”

The Sonar Audible Alarm and Automatic Braking are different in operation conditions. Therefore there are cases in which only one of these functions will activate.

**⚠ WARNING**

Depress the brake pedal immediately after the system stops the vehicle by automatic braking. Depending on the conditions of the road surface and tires, the vehicle may not remain stopped, possibly leading to an accident.

■ **After the vehicle is stopped by the system**

After the brake pedal is

depressed, the RAB OFF indicator will illuminate and the system will temporarily stop operating. The RAB OFF indicator will turn off when the shift lever is shifted to a position other than R.

The system will operate again the next time the shift lever is shifted to R.

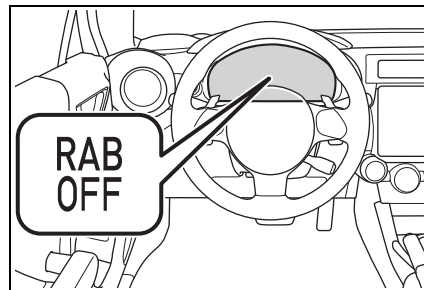

- The Reverse Automatic Braking (RAB) system will be disabled in the following situations.
  - When 3 seconds pass after the vehicle is stopped
  - When any door is opened
  - When the RAB warning light is illuminated
  - When the RAB OFF indicator is illuminated
- The Reverse Automatic Braking (RAB) system may stop operating temporarily in the following cases and the RAB OFF indicator will illuminate.
  - Ice, snow or mud is adhered to the sonar sensors or the rear bumper near the sonar sensor
  - Objects are too close to the rear bumper when the shift lever is set to R
  - The system detects sounds of a similar frequency to the RAB sonar
  - When the TRAC and VSC mode are turned off
  - When in TRACK mode and the

Pre-Collision Braking System has been turned off

### Canceling the Reverse Automatic Braking (RAB) system operation

The Reverse Automatic Braking (RAB) system can be temporarily canceled by any of the following operation.

- While the vehicle is stopped by the operation of automatic braking, the brake pedal is depressed.
- While the vehicle is stopped by the operation of automatic braking, the accelerator pedal is depressed.
- The accelerator pedal is depressed continuously (In this case, limited acceleration will be canceled and the vehicle will continue reversing.)
- The shift lever is shifted to a position other than R.

The system will be canceled if the object is no longer detected.

### Reverse Automatic Braking (RAB) system ON/OFF setting

While the shift lever is shifted to R, the below functions of the Reverse Automatic Braking (RAB) system can be set by operating the multimedia system screen.

When the ON setting key is shown, the corresponding setting is ON. Touch the ON setting key to turn the setting OFF.

When the OFF setting is shown, the corresponding setting is OFF. Touch the OFF setting key to turn the setting ON.

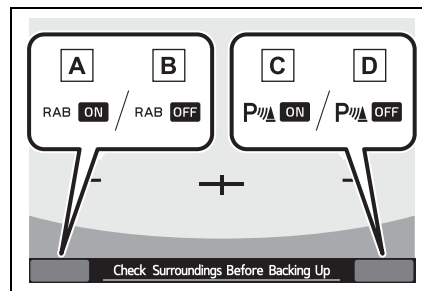

- A** ON setting key of Automatic Braking
- B** OFF setting key of Automatic Braking
- C** ON setting key of the Sonar Audible Alarm
- D** OFF setting key of the Sonar Audible Alarm

When the Automatic Braking are turned OFF, the following indicator(s) will illuminate.

The RAB OFF indicator will turn off when the corresponding function is turned ON.

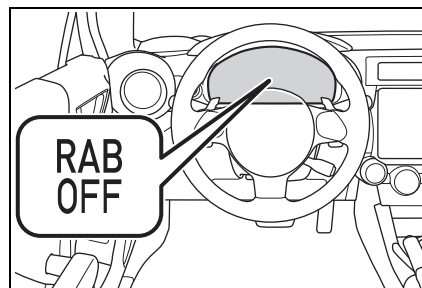



When the settings cannot be changed, the ON/OFF setting key will be grayed out.

Also, the following settings can be changed by operating the multimedia system screen. (→P.400)

- Warning Volume
- Sonar Audible Alarm
- Automatic Braking

### RAB warning light

If the Reverse Automatic Braking (RAB) system malfunctions, the above indicator illuminates on the meter. Contact the nearest Toyota dealer for details.

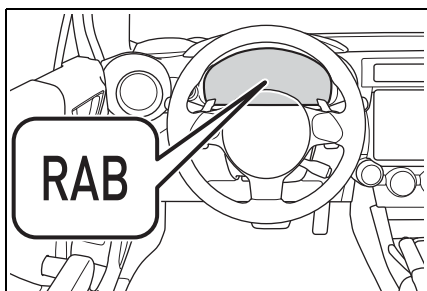

### Handling of the Sonar Sensors

The 4 sonar sensors are located in the rear bumper. To ensure the proper operation of the Reverse Automatic Braking (RAB) system, observe the following precautions.

- Do not affix any stickers or other items on the sonar sensor or the bumper surface near the sonar sensors.
- Always keep the sonar sensor

and the rear bumper surface near the sonar sensors clean.

- Do not modify rear bumper.
- Do not paint the bumper near the sonar sensors.
- Do not apply high pressure water to the sonar sensors with a high pressure car-washing machine.
- Do not apply strong impacts to the rear bumper near the sonar sensors. If a sensor becomes misaligned, a system malfunction may occur, including inability to detect objects in the reversing direction. If any strong impact is applied to the rear bumper, contact a Toyota dealer to have the system inspected.
- Do not disassemble the sonar sensors.

If the sonar sensors require repair or replacement, or if the area of the rear bumper near the sonar sensors requires repair, paintwork or replacement, contact your Toyota dealer for assistance.

### Rear view camera

**A rear view camera is attached to the trunk lid. When the engine switch is in ON and the shift lever is set to R, the rear view camera automatically displays the rear view image behind the vehicle on the multimedia system screen.**

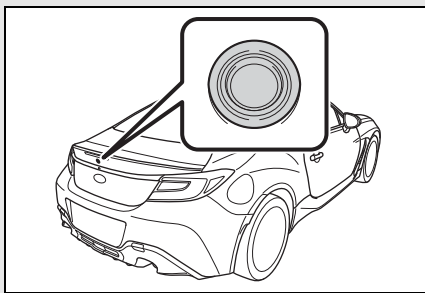

- Do not wipe the camera with alcohol, benzine or paint thinner. Otherwise, discoloration may occur. To remove contamination, wipe the camera with a cloth moistened with a diluted neutral detergent. Then wipe it with a soft, dry cloth.
- When waxing the vehicle, be careful not to apply the wax to the camera. If it comes in contact with the camera, moisten a clean cloth with a diluted neutral detergent to remove the wax.
- The camera lens has a hard coating to help prevent scratches. However, when washing the vehicle or cleaning the camera lens, be careful not to scratch the camera lens. Do not use a washing brush directly on the camera lens. The image quality of the rear view camera may deteriorate.
- Strong light shined on the camera

lens may develop vertical lines around the light source. This is not a malfunction.

- Under the fluorescent light, the display may flicker. However, this is not a malfunction.
- The image of the rear view camera may be slightly different from the actual color of the objects.
- If there is a malfunction on the multimedia system screen, refer to "MULTIMEDIA OWNER'S MANUAL".

#### **! WARNING**

- Since the rear view camera uses a wide-angle lens, the image on the monitor is different from the actual view in terms of distance.
- Since the range of the image on the monitor is limited, always check the rear view and the surrounding area with your eyes and mirrors, and move backward at a slow speed. Moving backward only by checking the rear view image from the camera could cause an accident.
- Do not disassemble or modify the camera, switch or wiring. If smoke comes out or you smell a strange odor, stop using the rear view camera immediately. Contact your Toyota dealer for an inspection. Continued use may result in accident, fire or electric shock.

#### **! NOTICE**

- When washing your vehicle with a high-pressure washer, do not allow water to touch the camera directly. Entry of water in the camera lens may result in condensation, malfunction, fire or electric shock.

**NOTICE**

- Since the camera is a precision device, do not subject it to strong impacts. Otherwise, malfunction, fire or electric shock may occur.
- If mud or snow sticks to or is frozen on the camera, you must be very careful when removing it. Otherwise, damage to the camera may cause a fire or electric shock. Pour water or lukewarm water over the camera to remove mud and ice, and wipe it with a soft, dry cloth.
- Do not put a flame close to the camera or wiring. Otherwise, damage or fire may occur.
- When replacing the fuse, be sure to use a fuse with the specified rating. Use of a fuse with a different rating may result in a malfunction.
- If you use the rear view camera for a long time while the engine is not operated, the battery may become completely discharged.

**How to use the rear view camera**

When the shift lever is set to R, the rear view camera automatically displays the rear view image from the vehicle. When the lever is set to other positions, the image before setting to R is displayed.

- 1 Set the engine switch to ON.
- 2 Set the shift lever to R.

- The image of the rear view camera is horizontally reversed as is the case with the vehicle inside

mirror or the outside mirror.

- When “Rear Camera Delay Control” is on, the rear view image from the rear view camera will be displayed on the multimedia system screen for a certain amount of time after the shift lever is shifted from R to another position. When any of the following conditions are met, the rear view image will be canceled:
  - The shift lever is shifted to P (vehicles with an automatic transmission)
  - The vehicle speed becomes approximately 5 mph (8 km/h) or more
  - The parking brake is engaged
  - 9 seconds have elapsed since the shift lever was shifted from R to another position

To turn the function on and off, refer to “MULTIMEDIA OWNER’S MANUAL”.

- It may be difficult to see the image of the rear view camera in the following cases. This is not a malfunction of the camera.
  - The vehicle is in a dark place (at night, in a tunnel, etc.).
  - The vehicle is in an extremely hot or cold place.
  - An object (such as raindrops, snow, dirt, etc.) that disturbs the view of the rear view camera sticks to the lens of the camera.
  - Strong light is shining directly on the camera lens (occasionally, there are vertical lines on the screen).

**Viewing range on the screen**

The area from the rear end of the bumper can be viewed. Areas at both ends of the bumper and areas just under the bumper cannot be viewed.

Also, the image from the rear view camera looks shorter than the actual distance.

► Range of view

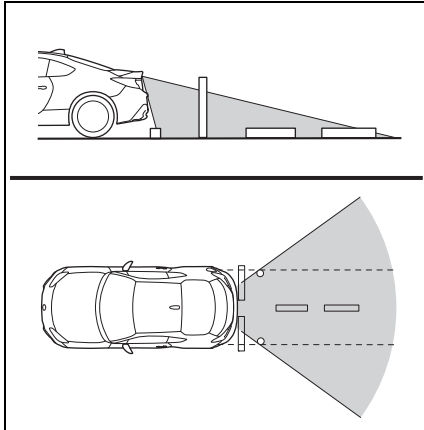

► Image from camera

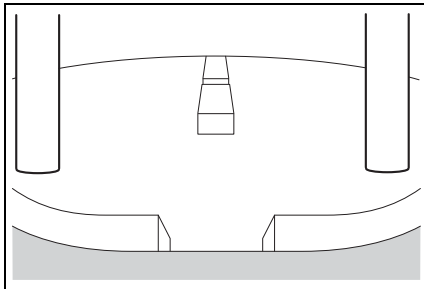

The area above the camera cannot be viewed. If there is an object that has a wide projection on its upper part such as a sign pole behind the vehicle, the projection cannot be seen on the screen.

► Range of view

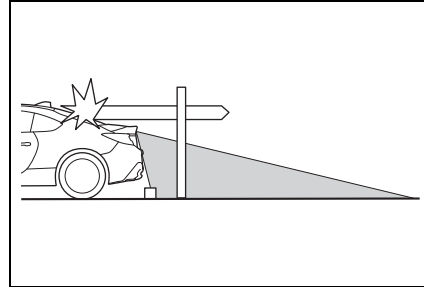

► Image from camera

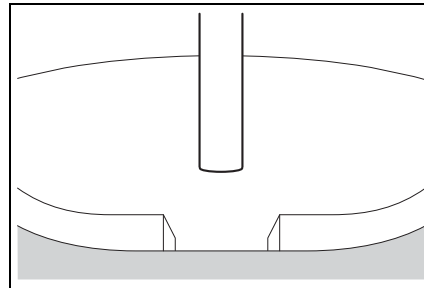

**! WARNING**

The range that can be viewed with the rear view camera is limited. Always be sure to check with your eyes when moving backward and proceed slowly. Otherwise, it may cause an accident or injury.

**Help lines**

The help lines are a guide to help you realize the actual distance from the screen image.

► Help lines

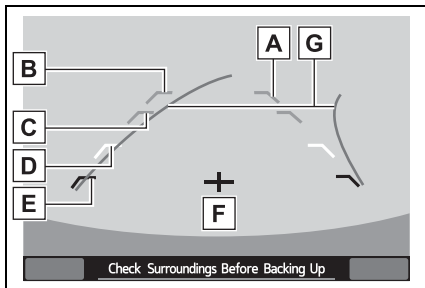

- A** Vehicle width line (oblique vertical line)
- B** Approx. 10 ft (3 m) from the bumper (green horizontal line)
- C** Approx. 6 ft (2 m) from the bumper (green horizontal line)
- D** Approx. 3 ft (1 m) from the bumper (yellow horizontal line)
- E** Approx. 1.5 ft (0.5 m) from the bumper (red horizontal line)
- F** Vehicle centerline
- G** Dynamic guidelines

When the shift lever is set to R, the multimedia system screen the help lines together with the rear view image.

If you shift to the R range within several seconds after turning on the engine switch, the warning message may not be displayed. Wait for several seconds after turning on the engine switch before shifting to the R range. Then, the warning message will be displayed.

**! WARNING**

- When moving backward, always check the back with your eyes without relying on the help lines. Otherwise, it may cause an accident or injury.
- The actual position may be different from the indication of the help lines.
- Differences may occur due to the number of passengers or the loaded cargo.
- When the vehicle is on a slope or inclined against the road, the indication is different from the actual position.

When “Steering Angle Lines” is off, the dynamic guidelines will be disappear on the multimedia system screen. To turn the dynamic guidelines on and off, refer to “MULTIMEDIA OWNER’S MANUAL”.

■ **Difference between screen image and actual road**

The distance markers show the distance for a level road when the vehicle is not loaded. It may be different from the actual distance depending on the loading conditions or road conditions.

- When there is an upward slope at the back

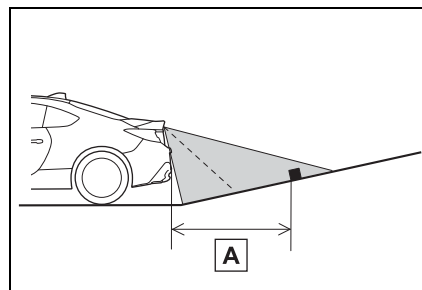

**A** 3 ft (1 m)

The distance on the screen looks farther than the actual distance.

- ▶ When there is a downward slope at the back

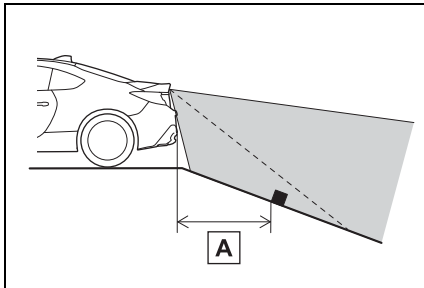

behind, distance cannot be correctly displayed.

**A** 3 ft (1 m)

The distance on the screen looks nearer than the actual distance.

When cargo is loaded, the rear view distance on the screen looks farther than the actual distance as in an upward slope.

■ Feature of distance marker

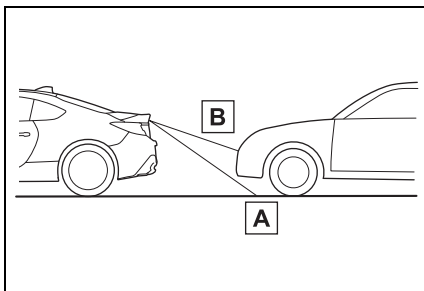

**A** 3 ft (1 m) line

**B** 10 ft (3 m) line

The distance marker shows the distance on the road. If there is a car or another object close

**Conventional Cruise Control (vehicles without the EyeSight)**

**Conventional Cruise Control is a driving support system intended to allow more comfortable driving on expressways, freeways and interstate highways. It can be used to travel at a constant speed by maintaining the vehicle speed set by the driver. Please remember that you should not exceed posted speed limits.**

- Conventional Cruise Control enables you to maintain a constant vehicle speed without holding your foot on the accelerator pedal and it is operative when the vehicle speed is 20 mph (30 km/h) or more.
- Make sure the Conventional Cruise Control system is turned off when the Conventional Cruise Control is not in use to avoid unintentionally setting of the Conventional Cruise Control.

**⚠ WARNING**

- Do not use the Conventional Cruise Control under any of the following conditions. These may cause loss of vehicle control.
  - In heavy traffic
  - On roads with sharp bends
  - On winding roads
  - On slippery roads, such as those covered with rain, ice or snow

- On steep hills
- Vehicle speed may exceed the set speed when driving down a steep hill.
- During emergency towing
- When using the Conventional Cruise Control, always set the speed appropriately according to the speed limit, traffic flow, road conditions, and other conditions.

**To set Conventional Cruise Control**

- 1** After the engine has started, press the “ON-OFF” switch of the cruise control switch.

The Conventional Cruise Control indicator (white) on the meter will illuminate.

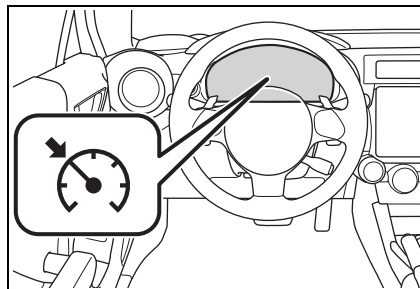
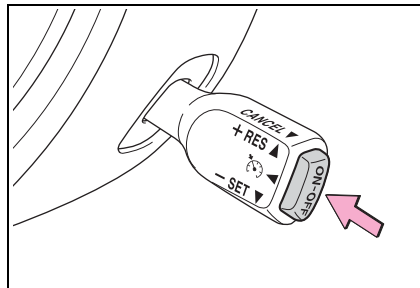

- 2** Depress the accelerator pedal until the vehicle reaches the desired speed.

- 3 When the vehicle reaches the desired speed, push the cruise control switch to the “+ RES” side or the “- SET” side. The vehicle speed at the time when the switch is pushed will become the set vehicle speed, and constant speed driving will initiate.

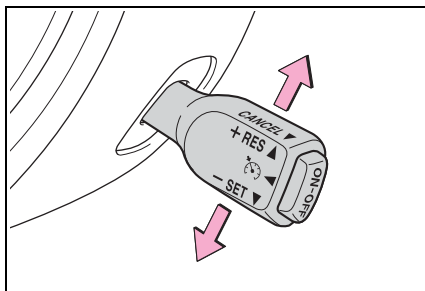

At this time, the Conventional Cruise Control indicator (green) is illuminated in the meter. The set speed will be shown on the meter. You can change the displayed units by operating the meter display. (→P.400)

The vehicle will maintain the desired speed.

Vehicle speed can be temporarily increased while driving with the Conventional Cruise Control activated. Simply depress the accelerator pedal to accelerate the vehicle. When the accelerator pedal is released, the vehicle will return to and maintain the previous cruising speed.

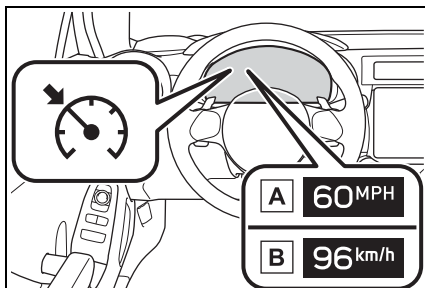

- A When setting the displayed unit as “MPH”
- B When setting the displayed unit as “km/h”

### To temporarily cancel the Conventional Cruise Control

The Conventional Cruise Control can be temporarily canceled in the following ways.

When the Conventional Cruise Control is cancelled, the Conventional Cruise Control indicator in the meter will change from green to white.

- Pulling the cruise control switch.
- Depress the brake pedal.
- Depress the clutch pedal.

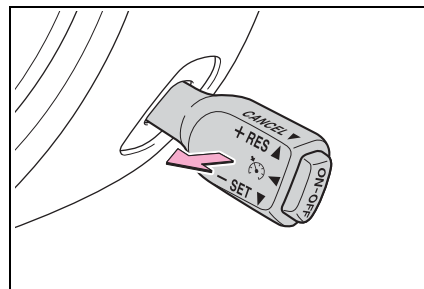

To resume the Conventional Cruise Control after it has been temporarily canceled and with vehicle speed of approximately 20 mph (30 km/h) or more, push the lever up to return to the original cruising speed automatically.

At this time, the Conventional



Cruise Control indicator in the meter will change from white to green.

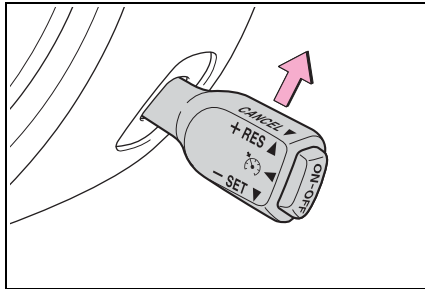

**To turn off the Conventional Cruise Control**

There are two ways to turn off the Conventional Cruise Control:

- Press the “ON-OFF” switch of the cruise control switch again.
- Turn the engine switch to the ACC or OFF (but only when the vehicle is completely stopped).

**To change the cruising speed**

■ **To increase the speed (by the cruise control switch)**

Push the cruise control switch to the “+RES” side and hold it until the vehicle reaches the desired speed. Then, release the switch. The vehicle speed at that moment will be memorized and treated as the new set speed.

- ▶ When setting the displayed unit as “MPH”:

The set speed can be increased 1 mph (1.6 km/h) each time by pushing the cruise control switch to the “+RES” side.

- ▶ When setting the displayed unit as “km/h”:

The set speed can be increased 1 km/h (0.6 mph) each time by pushing the cruise control switch to the “+RES” side.

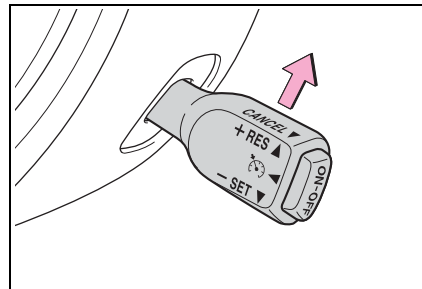

■ **To increase the speed (by accelerator pedal)**

- 1 Depress the accelerator pedal to accelerate the vehicle to the desired speed.
- 2 Push the cruise control switch to the “-SET” side once. Now the desired speed is set and the vehicle will keep running at that speed without depressing the accelerator pedal.

■ **To decrease the speed (by the cruise control switch)**

Push the cruise control switch to the “-SET” side and hold it until the vehicle reaches the desired

speed. Then, release the switch. The vehicle speed at that moment will be memorized and treated as the new set speed.

- ▶ When setting the displayed unit as “MPH”:

The set speed can be decreased 1 mph (1.6 km/h) each time by pushing the cruise control switch to the “-SET” side.

- ▶ When setting the displayed unit as “km/h”:

The set speed can be decreased 1 km/h (0.6 mph) each time by pushing the cruise control switch to the “-SET” side.

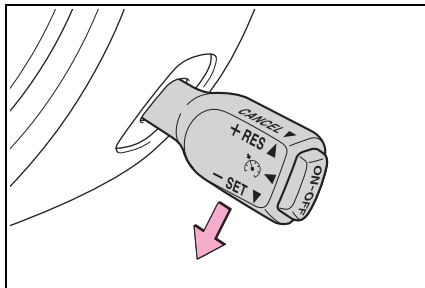

■ **To decrease the speed (by brake pedal)**

- 1 Depress the brake pedal to release Conventional Cruise Control temporarily.
- 2 When the speed decreases to the desired speed, push the cruise control switch to the “-SET” side once. Now the desired speed is set and the vehicle will keep running at that speed without depressing the accelerator pedal.

**Driving mode select switch\***

\*: If equipped

**The driving modes can be selected to suit driving condition.**

**Selecting a drive mode**

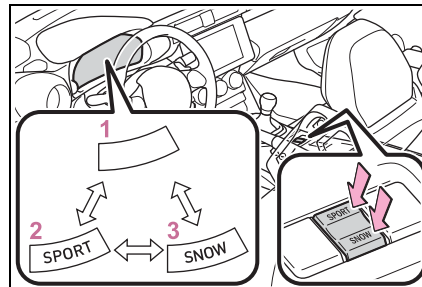

Press the sport mode switch or snow mode switch to change between normal mode and sport mode or snow mode respectively. To cancel sport mode or snow mode, press the same switch again.

**1 Normal mode**

Provides an optimal balance of fuel economy, quietness, and dynamic performance. Suitable for normal driving.

**2 Sport mode**

Use sport mode for sporty driving or when driving in mountainous regions with lots of curves.

The “SPORT” indicator comes on.

Also, if the mode is changed to sport mode while driving with the shift lever in the D position, the selected gear, from “D1” to “D6”, will be displayed on the meter.

**3 Snow mode**

Use snow mode for accelerating and driving on slippery road surfaces such as snow.

The snow mode indicator comes on.

■ **Sport mode**

- In sport mode, lower gears are used and gears change at a higher engine speed.
- In the following situations, it may not be possible to change to sport mode. When the mode cannot be changed to sport mode, a buzzer will sound and a message will be displayed on the multi-information display.
  - When the Adaptive Cruise Control or Conventional Cruise Control is operating
  - When the engine is cold

■ **Snow mode**

To prevent slipping, 1st gear cannot be selected when in snow mode.

■ **Automatic deactivation of sport mode and snow mode**

In the following situations, the driving mode is automatically deactivated:

- When the engine is turned off after driving in sport mode or snow mode.
- When the Adaptive Cruise Control or Conventional Cruise Control is activated while driving in sport mode.
- When in sport mode and stopping/starting off is automatically performed in second gear. (→P.150)

Hill-start assist control

**Hill-start assist control helps to maintain braking force to assist starting off forward while facing uphill or starting off backward while facing downhill.**

Hill-start assist control ON indicator

When the engine switch is turned to ON, the hill-start assist control ON indicator will illuminate.

When the hill-start assist control operates, the indicator will flash.

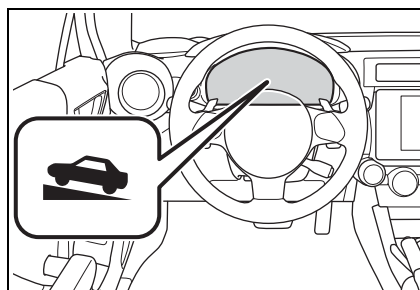

Disabling hill-start assist control

- 1 Park your vehicle in a flat, safe location.



Make sure that the parking brake is securely engaged.

- 2 Stop the engine by turning the engine switch off.

- 3 Start the engine and check that the ABS warning light and slip indicator are off.
- 4 Press and hold the  switch for approximately 30 seconds.

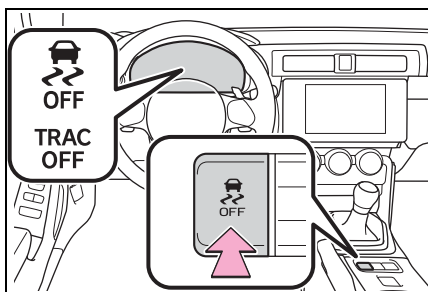
Check that the TRAC OFF and VSC OFF indicators illuminate and then turn off.



- 5 Within 5 seconds after the indicator lights turn off, release the  switch. Then, press the  switch again within 2 seconds of releasing it.



The hill-start assist control ON indicator will turn off and then illuminate.

- 6 Turn the engine switch off.
- 7 Start the engine again and check that the hill-start assist control ON indicator turns off.

Hill-start assist control will be disabled.

To enable hill-start assist control, perform steps 1 through 7 again.

#### ■ When enabling the hill-start assist control

- If the hill-start assist control ON indicator does not turn off or a mistake was made during the procedure, turn the engine switch off and start the procedure from step 4 again.
- If the  switch is pressed and held for 30 seconds or more, the TRAC OFF indicator and VSC OFF indicator will turn off and the switch will become inoperable. In this case, the VSC will operate in normal mode. (→P.263) If the engine switch is turned off and then the engine is started again, operation of the  switch will become possible.

#### ■ Operating conditions of hill-start assist control

When the following conditions are met, the hill-start assist control will operate:

- Vehicles with an automatic transmission: The shift lever is in D or M (when starting off forward while facing uphill) or in R (when starting off backward while facing downhill).
- Vehicles with a manual transmission: The shift lever is in a position other than R (when starting off forward while facing uphill) or in R (when starting off backward while facing downhill).
- The vehicle is stopped.
- The accelerator pedal is not depressed.
- The parking brake is not engaged.

#### ■ Hill-start assist control will not operate when

Hill-start assist control will not operate when any of the following conditions are met:

- Vehicles with an automatic trans-

mission: The shift lever is in a position other than D or M (when facing uphill) or in a position other than R (when facing downhill).

- Vehicles with a manual transmission: The shift lever is in R (when facing uphill) or in a position other than R (when facing downhill).
- Vehicles with an automatic transmission: The accelerator pedal is depressed.
- The parking brake is applied.
- Vehicles with a manual transmission: The clutch is engaged.
- Approximately 2 seconds have elapsed since the brake pedal was released.
- The hill-start assist control ON indicator is not illuminated.
- The engine switch is turned to ACC or OFF.

■ **Notes for hill-start assist control**

- A slight jolt may be felt when starting off backward with the shift lever in R and then moving forward.
- If the braking power of hill-start assist control is insufficient, depress the brake pedal.
- While the vehicle is stopped, make sure to depress the brake pedal.

■ **The system may be malfunctioning when**

In the following situations, the system may be malfunctioning. Have the vehicle inspected by your Toyota dealer.

- The slip indicator is illuminated.
- The hill-start assist control ON indicator turns off and a buzzer sounds.

 **WARNING**

■ **Hill-start assist control precautions**

- Do not overly rely on hill-start assist control. Hill-start assist control may not operate effectively on steep inclines and roads covered with ice.
- Unlike the parking brake, hill-start assist control is not intended to hold the vehicle stationary for an extended period of time. Do not attempt to use hill-start assist control to hold the vehicle on an incline, as doing so may lead to an accident.
- Do not stop the engine while hill-start assist control is operating, as hill-start assist control will stop operating, possibly leading to an accident.

**Driving assist systems**

**To help enhance driving safety and performance, the following systems operate automatically in response to various driving situations. Be aware, however, that these systems are supplementary and should not be relied upon too heavily when operating the vehicle.**

**Summary of the driving assist systems**

■ **ABS (Anti-lock Brake System)**

Helps to prevent wheel lock when the brakes are applied suddenly, or if the brakes are applied while driving on a slippery road surface

■ **Brake assist**

Generates an increased level of braking force after the brake pedal is depressed when the system detects a panic stop situation

■ **VSC (Vehicle Stability Control)**

Helps the driver to control skidding when swerving suddenly or turning on slippery road surfaces

■ **TRAC (Traction Control)**

Helps to maintain drive power

and prevent the drive wheels from spinning when starting the vehicle or accelerating on slippery roads

The TRAC system is also equipped with the brake LSD function.

■ **Hill-start assist control**

→P.259

■ **EPS (Electric Power Steering)**

Employs an electric motor to reduce the amount of effort needed to turn the steering wheel

■ **When the TRAC/VSC systems are operating**

The slip indicator will flash while the TRAC (including brake LSD function)/VSC systems are operating.

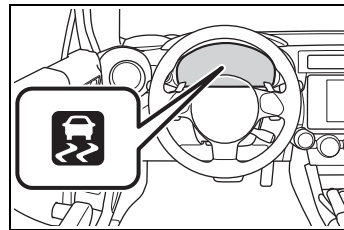

■ **Disabling the TRAC system**

If the vehicle gets stuck in mud, dirt or snow, the TRAC system may reduce power from the engine to the wheels. Pressing  switch to turn the system off may make it easier for you to rock the vehicle in order to free it.

In this case, the brake LSD function remains on.

To turn the TRAC system off, quickly press and release  switch.

The TRAC OFF indicator will come on.

Press  switch again to turn the system back on.

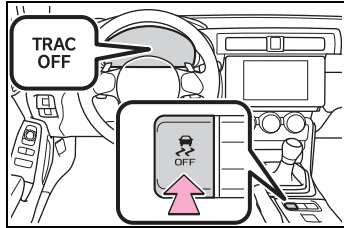

■ “TRACK” mode

Your vehicle is equipped with two types of control modes to accommodate various driving preferences. The control modes can be selected with the “TRACK” switch. Normal mode allows secure and smooth normal driving. When the switch is pressed and held for 1 second or more, “TRACK” mode is activated. When “TRACK” mode is selected, the control characteristics of VSC, TRAC, etc. will be changed and sportier than normal driving will be possible.

When “TRACK” mode is selected, the multi-information display will change to the “TRACK” mode dis-

play and the “TRACK” indicator and VSC OFF indicator will illuminate.

To change back to normal mode while in “TRACK” mode, press  switch or the “TRACK” switch.

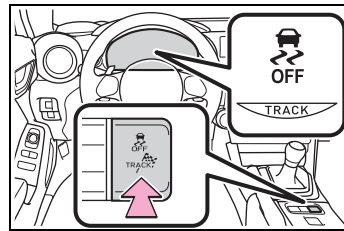

■ Turning off both TRAC and VSC systems

To turn the TRAC and VSC systems off, press and hold  switch for more than 3 seconds while the vehicle is stopped.

The TRAC OFF indicator and the VSC OFF indicator will come on.



However, on vehicles with an automatic transmission, the brake LSD function will remain on.

Press  switch again to turn the systems back on.

■ Selecting TRAC mode and VSC mode

Modes can be selected to suit your driving conditions as follows:

Driving conditions	TRAC modes	VSC modes	Brake LSD function	Indicators
Normal roads	Normal mode	Normal mode	Normal mode	—
Rough roads	OFF	Normal mode	Normal mode	TRAC OFF

Driving conditions	TRAC modes	VSC modes	Brake LSD function	Indicators
Sport driving	"TRACK" mode	"TRACK" mode	"TRACK" mode	 
	OFF	OFF	"TRACK" mode *1 OFF *2	

\*1: Vehicles with an automatic transmission

\*2: Vehicles with a manual transmission

■ **Sounds and vibrations caused by the ABS, brake assist, TRAC and VSC systems**

- A sound may be heard from the engine compartment when the brake pedal is depressed repeatedly, when the engine is started or just after the vehicle begins to move. This sound does not indicate that a malfunction has occurred in any of these systems.
- Any of the following conditions may occur when the above systems are operating. None of these indicates that a malfunction has occurred.
  - Vibrations may be felt through the vehicle body and steering.
  - A motor sound may be heard after the vehicle comes to a stop.
  - The brake pedal may pulsate slightly after the ABS is activated.
  - The brake pedal may move down slightly after the ABS is activated.

■ **EPS operation sound**

When the steering wheel is operated, a motor sound (whirring sound) may be heard. This does not indicate a malfunction.

■ **Automatic reactivation of TRAC and VSC systems**

After turning the TRAC and VSC systems off, the systems will be

automatically reactivated in the following situations:

- When the engine switch is turned off.
- If only the TRAC system is turned off, the TRAC will turn on when vehicle speed is more than approximately 31 mph (50 km/h). If both the TRAC and VSC systems are turned off, automatic reactivation will not occur when vehicle speed increases.

■ **Reduced effectiveness of the EPS system**

The effectiveness of the EPS system is reduced to prevent the system from overheating when there is frequent steering input over an extended period of time. The steering wheel may feel heavy as a result. Should this occur, refrain from excessive steering input or stop the vehicle and turn the engine off. The EPS system should return to normal after a little while.

■ **Automatic deactivation of "TRACK" mode**

When the engine switch is turned off after driving in "TRACK" mode, the mode is automatically deactivated.



**⚠ WARNING****■ The ABS does not operate effectively when**

- The limits of tire gripping performance have been exceeded (such as excessively worn tires on a snow covered road).
- The vehicle hydroplanes while driving at high speed on wet or slick roads.

**■ Stopping distance when the ABS is operating may exceed that of normal conditions**

The ABS is not designed to shorten the vehicle's stopping distance. Always maintain a safe distance from the vehicle in front of you, especially in the following situations:

- When driving on dirt, gravel or snow-covered roads
- When driving with tire chains
- When driving over bumps in the road
- When driving over roads with potholes or uneven surfaces

**■ TRAC may not operate effectively when**

Directional control and power may not be achievable while driving on slippery road surfaces, even if the TRAC system is operating. Do not drive the vehicle in conditions where stability and power may be lost.

**■ When the VSC and/or brake LSD function is activated**

The slip indicator flashes. Always drive carefully. Reckless driving may cause an accident. Exercise particular care when the indicator flashes.

**■ When the TRAC/VSC systems are turned off**

Be especially careful and drive at a speed appropriate to the road conditions. As these are the systems to help ensure vehicle stability and driving force, do not turn the TRAC/VSC systems off unless necessary.

**■ Replacing tires**

Make sure that all tires are of the specified size, brand, tread pattern and total load capacity. In addition, make sure that the tires are inflated to the recommended tire inflation pressure level.

The ABS, TRAC and VSC systems will not function correctly if different tires are installed on the vehicle.

Contact your Toyota dealer for further information when replacing tires or wheels.

**■ Handling of tires and the suspension**

Using tires with any kind of problem or modifying the suspension will affect the driving assist systems, and may cause a system to malfunction.

### Winter driving tips

**Carry out the necessary preparations and inspections before driving the vehicle in winter. Always drive the vehicle in a manner appropriate to the prevailing weather conditions.**

#### Preparation for winter

- Use fluids that are appropriate to the prevailing outside temperatures.
  - Engine oil
  - Engine coolant
  - Washer fluid
- Have a service technician inspect the condition of the battery.
- Have the vehicle fitted with four snow tires.

Make sure to install 4 tires that are of the specified size, and that all 4 tires are the same size, same maker, same brand and tread pattern.

#### WARNING

##### ■ Driving with snow tires

Observe the following precautions to reduce the risk of accidents. Failure to do so may result in a loss of vehicle control and cause death or serious injury.

- Use tires of the specified size, and that are the same size, same maker, same brand and tread pattern.

- Maintain the recommended level of air pressure.
- Do not drive in excess of 75 mph (120 km/h), regardless of the type of snow tires being used.
- Use snow tires on all, not just some wheels.

#### NOTICE

##### ■ Repairing or replacing snow tires

Request repairs or replacement of snow tires from Toyota dealers or legitimate tire retailers. This is because the removal and attachment of snow tires affects the operation of the tire pressure warning valves and transmitters.

#### Before driving the vehicle

Perform the following according to the driving conditions:

- Do not try to forcibly open a window or move a wiper that is frozen. Pour warm water over the frozen area to melt the ice. Wipe away the water immediately to prevent it from freezing.
- To ensure proper operation of the climate control system fan, remove any snow that has accumulated on the air inlet vents in front of the windshield.
- Check for and remove any excess ice or snow that may have accumulated on the exterior lights, vehicle's roof,

chassis, around the tires or on the brakes.

- Remove any snow or mud from the bottom of your shoes before getting in the vehicle.
- If a door is opened and closed when its side window is frozen, the window safety device will operate and the side window open/close function linked to door operation may not operate correctly. If this occurs, perform the following after the ice has melted.
  - 1 Open the window to the approximately half open position with the door closed.
  - 2 Press and hold the power window switch in the one-touch opening position. After the window is fully opened, continue pressing the switch for approximately 1 second.
  - 3 Pull and hold the power window switch in the one-touch closing position. After the window is fully closed, continue pulling the switch for approximately 1 second.

The window position will be reset and the operation of the window safety device will be canceled.

### When driving the vehicle

Accelerate the vehicle slowly, keep a safe distance between

you and the vehicle ahead, and drive at a reduced speed suitable to road conditions.

### When parking the vehicle

- Park the vehicle and shift the shift lever to P (automatic transmission), or 1 or R (manual transmission) without setting the parking brake. The parking brake may freeze up, preventing it from being released. If the vehicle is parked without setting the parking brake, make sure to block the wheels. Failure to do so may be dangerous because it may cause the vehicle to move unexpectedly, possibly leading to an accident.
- Vehicles with an automatic transmission: If the vehicle is parked without setting the parking brake, confirm that the shift lever cannot be moved out of P\*.

\*: The shift lever will be locked if it is attempted to be shifted from P to any other position without depressing the brake pedal. If the shift lever can be shifted from P, there may be a problem with the shift lock system. Have the vehicle inspected by your Toyota dealer immediately.

### **Tire chains**

Tire chains cannot be used on your vehicle because of the lack of clearance between the tires and vehicle body.

When tire chains cannot be used, use of another type of traction device (such as spring chains) may be acceptable if use on your vehicle is recommended by the device manufacturer, taking into account tire size and road conditions. Follow the device manufacturer's instructions, especially regarding maximum vehicle speed.

To help avoid damage to your vehicle, drive slowly, readjust or remove the device if it is contacting your vehicle, and do not spin your wheels. Damage caused to your vehicle by use of a traction device is not covered under warranty.

Make certain that any traction device you use is an SAE class "S" device, and use it on the rear wheels only. Always use the utmost care when driving with a traction device. Overconfidence because you are using a traction device could easily lead to a serious accident.

### **Selecting tire chains**

We recommend that you consult your Toyota dealer for informa-

tion about the chains that you can use.

**Interior features**

**5**

**5-1. Using the air conditioning system**

Automatic air conditioning system..... 270

Seat heaters..... 276

**5-2. Using the interior lights**

Interior lights list ..... 277

**5-3. Using the storage features**

List of storage features ..... 279

Trunk features ..... 282

**5-4. Using the other interior features**

Other interior features . 283

**5**

Interior features

## Automatic air conditioning system

Air outlets are automatically selected and fan speed is automatically adjusted according to the set temperature setting.

### Air conditioning controls

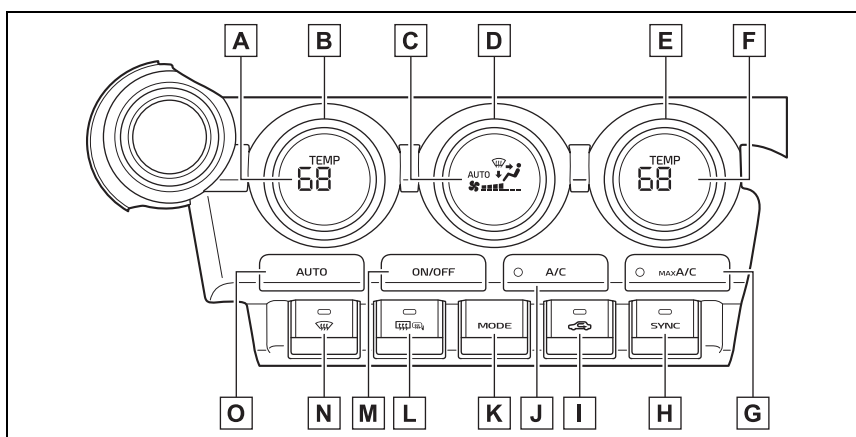

- A** Left-hand side temperature setting display
- B** Left-hand side temperature control switch
- C** Climate control mode display
- D** Fan speed control switch
- E** Right-hand side temperature control switch
- F** Right-hand side temperature setting display
- G** "MAX A/C" switch
- H** "SYNC" switch
- I** Outside/recirculated air mode switch
- J** "A/C" switch
- K** Airflow mode control switch
- L** Rear window defogger and outside rear view mirror defoggers switch
- M** "ON/OFF" switch
- N** Windshield defogger switch
- O** Automatic mode switch

■ **Adjusting the temperature setting**

To adjust the temperature setting, turn the temperature control switch clockwise (warm) or counterclockwise (cool).

If “A/C” switch is not pressed, the system will blow ambient temperature air or heated air.

The air conditioning system switches between individual and synchronized modes each time “SYNC” switch is pressed.

Synchronized modes (indicator on):

The left-hand side temperature control switch can be used to adjust the temperature for the driver’s and front passenger’s side. At this time, operate the right-hand side temperature control switch to enter individual mode.

Individual modes (indicator off):

The temperature for the driver’s and front passenger’s side can be adjusted separately.

■ **Setting the fan speed**

To adjust the fan speed, turn the fan speed control switch clockwise (increase) or counterclockwise (decrease).

Pressing the “ON/OFF” switch to turns off the fan.

■ **Change the airflow mode**

Press the airflow mode control switch.

The airflow mode changes as follows each time the switch is pressed.

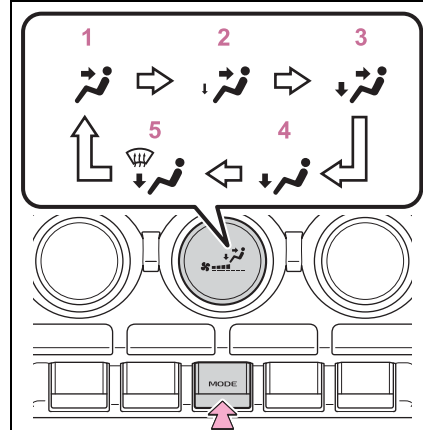

- 1 Upper body
- 2 Upper body and slightly to the feet
- 3 Upper body and feet
- 4 Feet
- 5 Feet and the windshield defogger operates

■ **Switching between outside air and recirculated air modes**

Press the outside/recirculated air mode switch.

The mode switches between outside air mode and recirculated air mode each time the switch is operated.

When recirculated air mode is selected, the indicator illuminates on the outside/recirculated air mode switch.

■ **Set cooling and dehumidification function**

Press the “A/C” switch.

When the function is on, the indicator illuminates on the “A/C” switch.

■ **Fast cooling function**

Press the “MAX A/C” switch.

When the switch is turned on, the air conditioning will turn on, the temperature will be set to LO, the fan speed will be set to MAX, the air outlets will be set to upper body, and the air mode will change to recirculated air mode automatically.

To turn off fast cooling function and return the previous setting, press the “MAX A/C” switch again.

■ **Suspend function**

Press the “ON/OFF” switch.

While the air conditioning system is being used, when the “ON/OFF” switch is pressed, the air conditioning system will stop and the temperature setting display, etc. will turn off.

If the “ON/OFF” switch is pushed and turned on, the air conditioning system will operate in the operating state it was in when turned off.

However, if the fast cooling function was operating when the air conditioning system was turned off, it will operate in the operating state it was in before the fast cooling function was turned on.

■ **Defogging the windshield**

Defoggers are used to defog the windshield and front side windows.

Press the windshield defogger switch.

Set the outside/recirculated air mode switch to outside air mode if the recirculated air mode is used. (Changes automatically)

To defog the windshield and the side windows quickly, turn the air flow and temperature up.

To return to the previous mode, press the windshield defogger switch again when the windshield is defogged.

When the windshield defogger switch is on, the indicator illuminates on the windshield defogger switch.

■ **Defogging the rear window and outside rear view mirrors**

Defoggers are used to defog the rear window, and to remove raindrops, dew and frost from the outside rear view mirrors.

Press the rear window and outside rear view mirror defoggers switch.

The defoggers will automatically turn off after approximately 15 minutes.

When the rear window and outside rear view mirror defoggers switch is on, the indicator illuminates on the rear window and outside rear view mirror defoggers switch.

■ **Fogging up of the windows**

- The windows will easily fog up when the humidity in the vehicle is high. Turning “A/C” on will dehumidify the air from the outlets and defog the windshield effectively.
- If you turn “A/C” off, the windows may fog up more easily.
- The windows may fog up if the recirculated air mode is used.



■ **When driving on dusty roads**

Close all windows. If dust thrown up by the vehicle is still drawn into the vehicle after closing the windows, it is recommended that the air intake mode be set to outside air mode and the fan speed to any setting except off.

■ **Outside/recirculated air mode**

- Setting to the recirculated air mode temporarily is recommended in preventing dirty air from entering the vehicle interior and helping to cool the vehicle when the outside air temperature is high.
- Outside/recirculated air mode may automatically switch depending on the temperature setting or the inside temperature.

■ **When the outside temperature falls to nearly 32°F (0°C)**

The dehumidification function may not operate even when "A/C" switch is pressed.

■ **Ventilation and air conditioning odors**

- To let fresh air in, set the air conditioning system to the outside air mode.
- During use, various odors from inside and outside the vehicle may enter into and accumulate in the air conditioning system. This may then cause odor to be emitted from the vents.
- To reduce potential odors from occurring:
  - It is recommended that the air conditioning system be set to outside air mode prior to turning the vehicle off.
  - The start timing of the blower may be delayed for a short period of time immediately after the air conditioning system is started in automatic mode.
- When the engine switch is changed to the OFF or ACC posi-

tion from ON, the air inlet mode will automatically change to the outside air mode regardless of whether it is the auto mode or manual mode.

■ **Air conditioning filter**

→P.327

■ **Air conditioning system refrigerant**

- A label regarding the refrigerant of the air conditioning system is attached to the hood at the location shown in the following illustration.

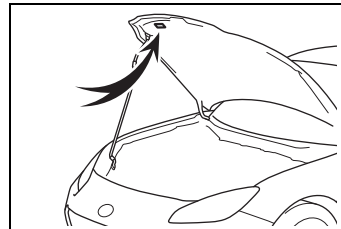

- The meaning of each symbol on the label are as follows:

	Caution
	Air conditioning system
	Air conditioning system lubricant type
	Requires registered technician to service air conditioning system
	Flammable refrigerant

■ **When continuous operation is set**

During continuous operation, the defogger stops operating for 2 minutes after every 15 minutes of continual operation. Even during the 2 minutes that operation stops, the

operating light remains illuminated. The rear window defogger will continue to operate in this cycle until it is turned off.

■ **Customization**

Some functions can be customized. (→P.400)

**⚠ WARNING**

■ **To prevent the windshield from fogging up**

Do not use the windshield defogger switch during cool air operation in extremely humid weather. The difference between the temperature of the outside air and that of the windshield can cause the outer surface of the windshield to fog up, blocking your vision.

■ **When the outside rear view mirror defoggers are operating**

Do not touch the outside rear view mirror surfaces, as they can become very hot and burn you.

**⚠ NOTICE**

■ **To prevent battery discharge**

Do not leave the air conditioning system on longer than necessary when the engine is off.

■ **When repairing/replacing parts of the air conditioning system**

Have repair/replacement performed by your Toyota dealer. When a part of the air conditioning system, such as the evaporator, is to be replaced, it must be replaced with a new one.

**Using automatic mode**

- 1 Press the automatic mode switch.
- 2 Adjust the temperature setting.
- 3 To stop the operation, press the "ON/OFF" switch.

If the fan speed setting or air flow modes are operated, the automatic mode indicator goes off. However, automatic mode for functions other than that operated is maintained.

■ **Using automatic mode**

Fan speed is adjusted automatically according to the temperature setting and the ambient conditions.

Therefore, the fan may stop for a while until warm or cool air is ready to flow immediately after the automatic mode switch pressed.

**Air outlet layout and operations**

■ **Location of air outlets**

The air outlets and air volume changes according to the selected air flow mode.

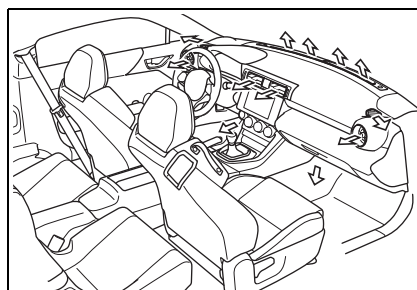

■ **Adjusting the position of and opening and closing the air outlets**

► Center

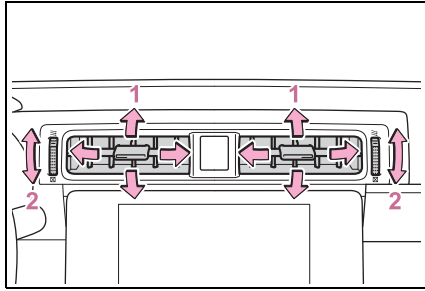

- 1** Direct air flow to the left or right, up or down
- 2** Turn the knob to open or close the vent

► Side

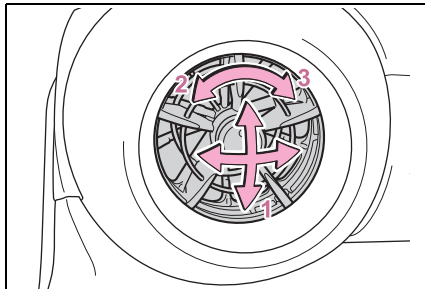

- 1** Direct air flow to the left or right, up or down
- 2** Open the vent
- 3** Close the vent

**! WARNING**

■ **To prevent the windshield defogger from operating improperly**

Do not place anything on the instrument panel which may cover the air outlets. Otherwise, air flow may be obstructed, preventing the windshield defoggers from defogging.

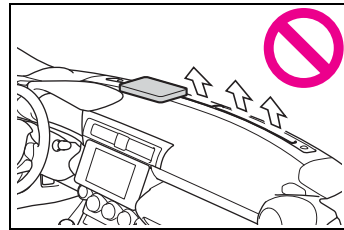

**Seat heaters\***

\*: If equipped

**Warm up the seat upholstery.**

**⚠ WARNING**

**■ To prevent minor burn injuries**

Care should be taken if anyone in the following categories comes in contact with the seats when the heater is on:

- Babies, small children, the elderly, the sick and the physically challenged
- Persons with sensitive skin
- Persons who are fatigued
- Persons who have taken alcohol or drugs that induce sleep (sleeping drugs, cold remedies, etc.)

**⚠ NOTICE**

**■ To prevent damage to the seat heaters**

Do not put heavy objects that have an uneven surface on the seat and do not stick sharp objects (needles, nails, etc.) into the seat.

**■ To prevent battery discharge**

Do not use the functions when the engine is off.

**Operation instructions**

**■ Seat heaters**

Press the switch to warm the seats.

The indicator light comes on when

a seat heater is turned on.

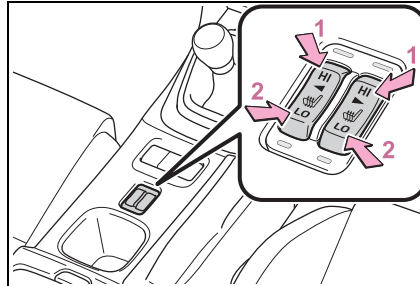

**1** Rapid heating

**2** Normal heating

When not in use, put the switch in the neutral position. The indicator will turn off.

**■ The seat heaters can be used when**

The engine switch is in ON.

**■ When not in use**

Turn the seat heater off. The indicator light goes off.

**⚠ WARNING**

**■ To prevent overheating and minor burn injuries**

Observe the following precautions when using the seat heaters.

- Do not cover the seat with a blanket or cushion when using the seat heater.
- Do not use seat heater more than necessary.

Interior lights list

Location of the interior lights

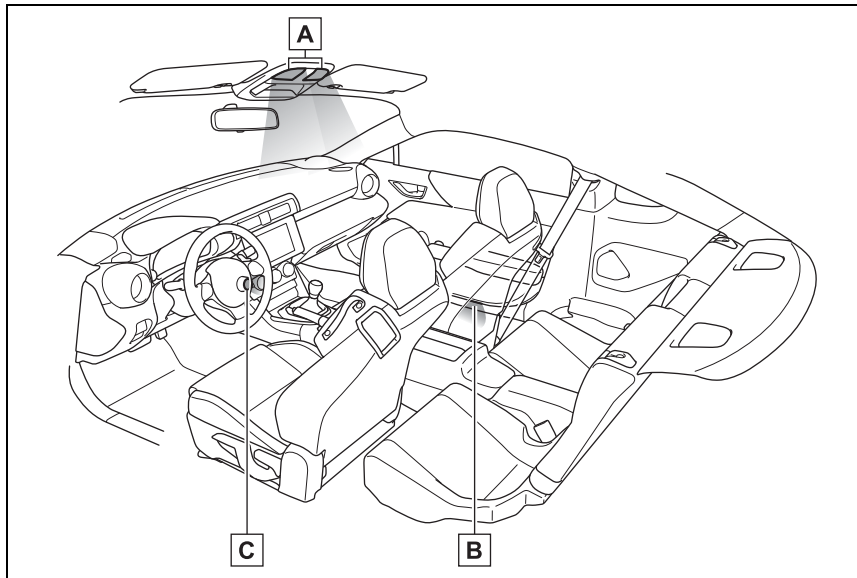

- A** Interior lights (→P.277)
- B** Door courtesy lights (if equipped)
- C** Engine switch light

Operating the interior lights

Turns the light on/off

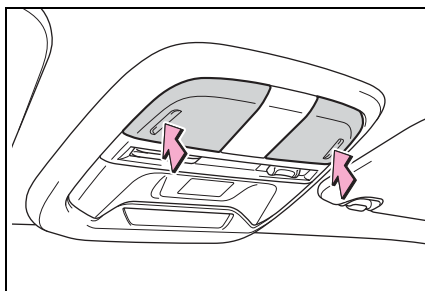

Turns the door position on/off

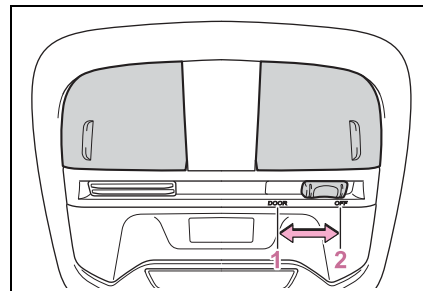

- 1 On
- 2 Off

■ Illuminated entry system

When the door position is on, the lights will automatically turn on/off according to the presence of an

electronic key, locking/unlocking and opening/closing of the doors, and the engine switch mode.

■ **To prevent the battery from being discharged**

When the door position is on, if the engine switch is turned off with a door not fully closed and the interior lights remain illuminated, they will automatically be turned off after approximately 20 minutes. However, if a light lens has been pushed to illuminate the interior light, it will not turn off automatically.

■ **Customization**

Some functions can be customized. (→P.400)



**NOTICE**

■ **To prevent battery discharge**

Do not leave the lights on longer than necessary when the engine is not running.

**List of storage features**

**Location of the storage features**

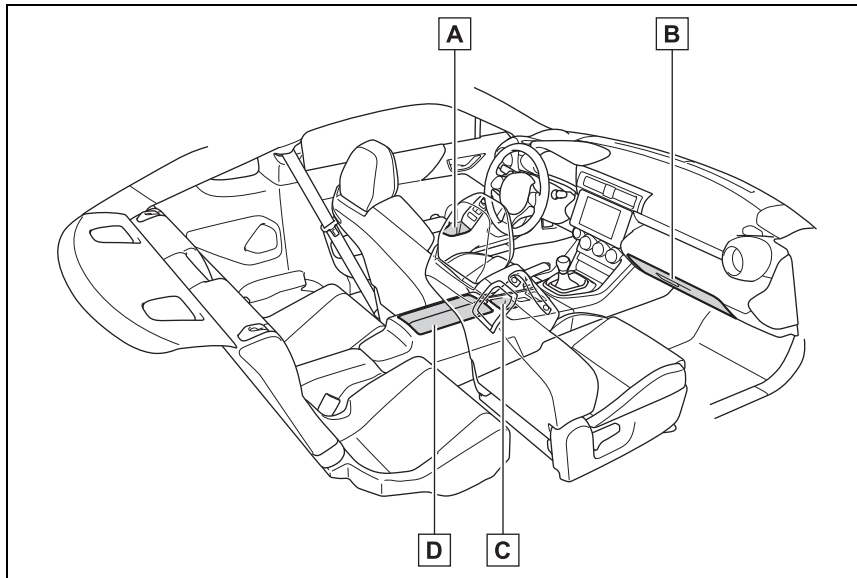

- A** Bottle holders (→P.280)
- B** Glove box (→P.279)
- C** Cup holders/Auxiliary boxes (if equipped) (→P.281)
- D** Console box (→P.280)

**⚠ WARNING**

**■ Items that should not be left in the storage spaces**

Do not leave glasses, lighters or spray cans in the storage spaces, as this may cause the following when cabin temperature becomes high:

- Glasses may be deformed by heat or cracked if they come into contact with other stored items.

- Lighters or spray cans may explode. If they come into contact with other stored items, the lighter may catch fire or the spray can may release gas, causing a fire hazard.

**Glove box**

Pull up the lever to open the glove box.

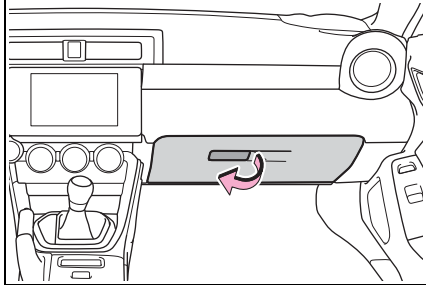

**⚠ WARNING**

■ **Caution while driving**

Keep the glove box closed. In the event of sudden braking or sudden swerving, an accident may occur due to an occupant being struck by the open glove box or the items stored inside.

**⚠ WARNING**

■ **Items unsuitable for the bottle holders**

Do not place anything other than a bottle in the bottle holders. Other items may be thrown out of the holders in the event of an accident or sudden braking and cause injury.

**⚠ NOTICE**

■ **Items unsuitable for the bottle holder**

Put the cap on before stowing a bottle. Do not place open bottles in the bottle holders, or glasses and paper cups containing liquid. The contents may spill and glasses may break.

**Bottle holders**

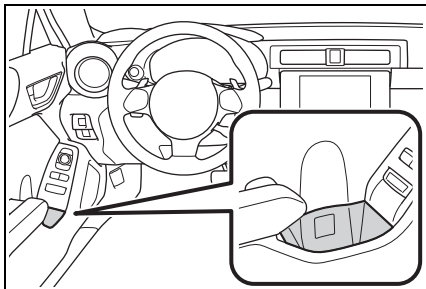

- **Bottle holders**
- When storing a bottle, close the cap.
  - The bottle may not be stored depending on its size or shape.

**Console box**

■ **Opening the lid**

Push the button

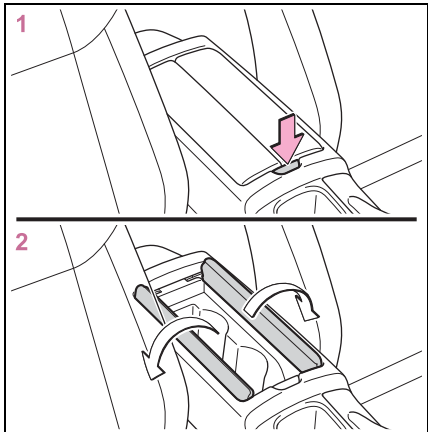

■ **Closing the lid**

Push the lid toward the center

If one side is pushed, the opposite side will move simultaneously.



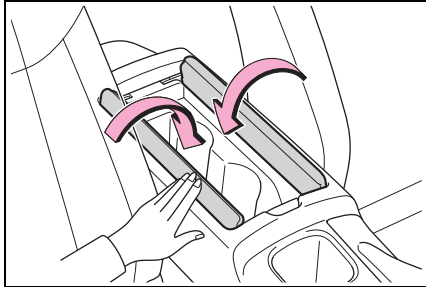

**⚠ WARNING**

**■ When the console box is not in use**

Keep the console box closed when it is not being used. If left open, in the event of sudden braking, etc., stowed items may fly out, possibly leading to an accident.

**Cup holders/Auxiliary boxes (if equipped)**

- ▶ Center console (vehicles with an automatic transmission)

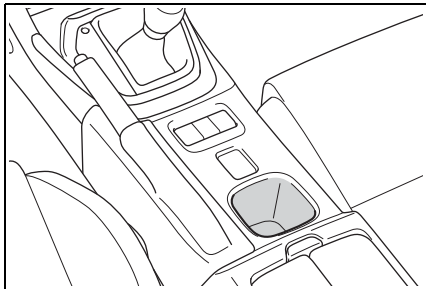

- ▶ Console box

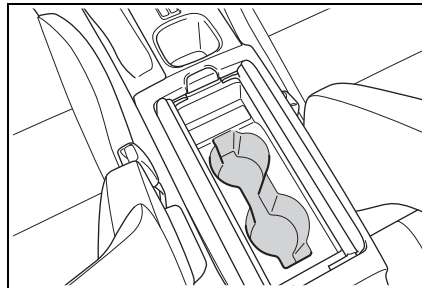

**⚠ WARNING**

**■ Caution while driving**

If possible, cover hot drinks to prevent burns.

Observe the following precautions when putting items. Failure to do so may cause items to be thrown out in the event of sudden braking or steering. In these cases, the items may interfere with pedal operation or cause driver distraction, resulting in an accident.

- Do not store items that can easily shift or roll out.
- Do not stack items higher than the edge.
- Do not put items that may protrude over the edge.

### Trunk features

#### Auxiliary box

Lift the luggage mat.

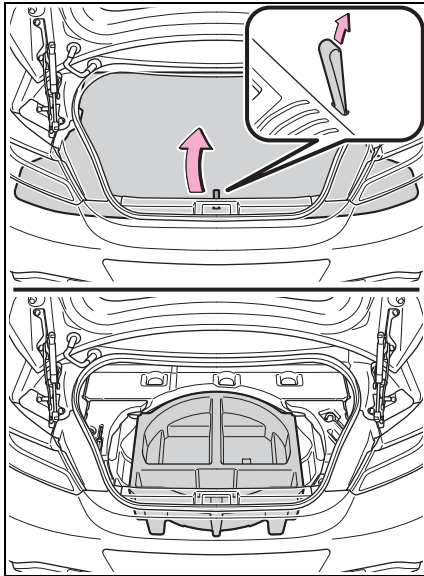

#### Warning reflector storage box

The warning reflector can be stored.

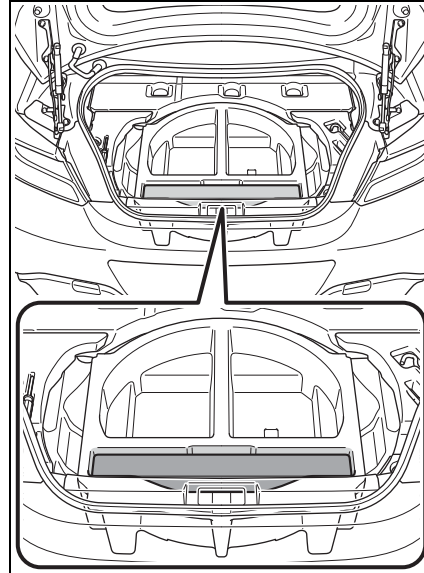

#### Warning reflector storage box

Depending on the size and shape of the warning reflector case, it may not be able to be stored.

#### WARNING

##### ■ When storing a warning reflector

Make sure that the warning reflector is stored securely. Failure to do so may cause it jump out of position in the event of sudden braking, etc., causing an accident.

**Other interior features****USB charging ports**

Use the USB terminal to use or charge an electronic device. The USB charging ports can be used to supply 2.1 A of electricity at 5 V to external devices. Depending on the external device, it may not charge properly. Refer to the manual included with the device before using a USB charging port.

■ **Using the USB charging ports**

Open the console box lid.

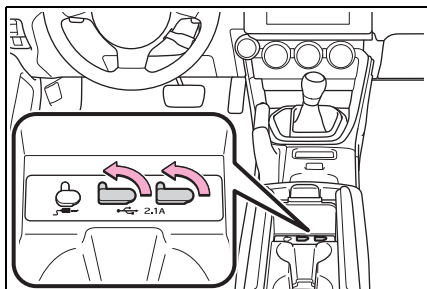

■ **The USB charging ports can be used when**

The engine switch is in ACC or ON.

■ **Situations in which the USB charging ports may not operate correctly**

- If a device which consumes more than 2.1 A at 5 V is connected
- If a device designed to communicate with a personal computer, such as a USB memory device, is connected
- If the connected external device is turned off (depending on device)
- If the temperature inside the vehi-

cle is high, such as after the vehicle has been parked in the sun

■ **About connected external device**

Depending on the connected external device, charging may occasionally be suspended and then start again. This is not a malfunction.

 **NOTICE**

■ **To prevent damage to the USB charging ports**

- Do not insert foreign objects into the ports.
- Do not spill water or other liquids into the ports.
- When the USB charging ports are not in use, close the lids. If a foreign object or liquid enters a port may cause a short circuit.
- Do not apply excessive force to or impact the USB charging ports.
- Do not disassemble or modify the USB charging ports.

■ **To prevent damage to external devices**

- Do not leave external devices in the vehicle. The temperature inside the vehicle may become high, resulting in damage to an external device.
- Do not push down on or apply unnecessary force to an external device or the cable of an external device while it is connected.

■ **To prevent battery discharge**

Do not use the USB charging ports for a long period of time with the engine stopped.

**Power outlet**

The power outlet can be used for 12 V accessories that run on 10 A or less.

Open the glove box lid and open the lid.

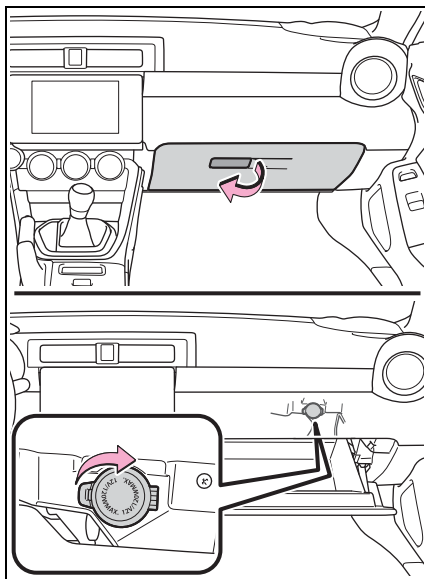

■ **The power outlet can be used when**

The engine switch is in ACC or ON.

■ **When turning the engine switch off**

Disconnect electrical devices with charging functions, such as mobile battery packs. If such devices are left connected, the engine switch may not be turned off normally.

 **NOTICE**

■ **To prevent the fuse from being blown**

Do not use an accessory that uses more than 12 V 10 A.

■ **To avoid damaging the power outlet**

Close the power outlet lid when the power outlet is not in use. Foreign objects or liquids that enter the power outlet may cause a short circuit.

■ **To prevent the battery from being discharged**

Do not use the power outlet longer than necessary when the engine is not running.

**Sun visors**

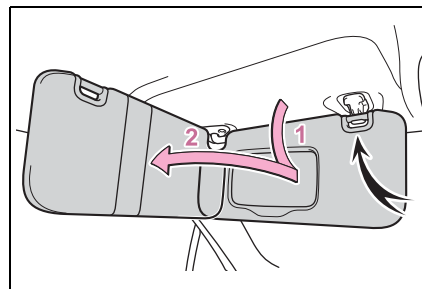

1 To set the visor in the forward position, flip it down.

2 To set the visor in the side position, flip down, unhook, and swing it to the side.

**Vanity mirrors**

Open the cover to use.

The vanity light turns on. (if equipped)

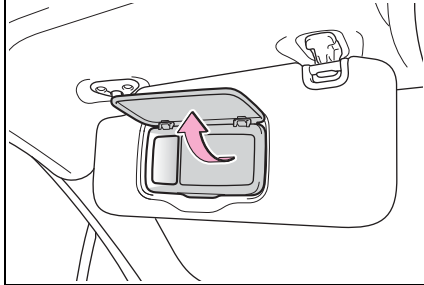

**NOTICE**

**■ To prevent the battery from being discharged**

Do not leave the vanity lights on for extended periods while the engine is stopped.



**Maintenance and care****6****6-1. Maintenance and care**

- Cleaning and protecting the vehicle exterior ..... 288
- Cleaning and protecting the vehicle interior ..... 291
- Cleaning and protecting the Ultrasuede® area ..... 293

Light bulbs ..... 333

**6-2. Maintenance**

- Maintenance requirements ..... 295
- General maintenance.. 296
- Emission inspection and maintenance (I/M) programs ..... 299

**6-3. Do-it-yourself maintenance**

- Do-it-yourself service precautions ..... 300
- Hood ..... 302
- Positioning a floor jack ..... 303
- Engine compartment... 305
- Tires ..... 312
- Replacing the tire ..... 319
- Tire inflation pressure.. 323
- Wheels ..... 325
- Air conditioning filter.... 327
- Electronic key battery.. 328
- Checking and replacing fuses..... 330
- Headlight aim ..... 332

## Cleaning and protecting the vehicle exterior

**Perform cleaning in a manner appropriate to each component and its material.**

### Cleaning instructions

- Working from top to bottom, liberally apply water to the vehicle body, wheel wells and underside of the vehicle to remove any dirt and dust.
- Wash the vehicle body using a sponge or soft cloth, such as a chamois.
- If very dirty, use a car wash soap that does not contain abrasives and then thoroughly rinse with water.
- Wipe away any water.
- Wax the vehicle when the waterproof coating deteriorates.

If water does not bead on a clean surface, apply wax when the vehicle body is cool.

#### ■ Automatic car washes

- Fold the mirrors before washing the vehicle. Start washing from the front of the vehicle. Make sure to extend the mirrors before driving.
- Brushes used in automatic car washes may scratch the vehicle surface, parts (wheel, etc.) and harm your vehicle's paint.

#### ■ High pressure car washes

As water may enter the cabin, do not bring the nozzle tip near the gaps around the doors or perimeter of the windows, or spray these areas continuously.

#### ■ When using a car wash

If the door handle becomes wet while the electronic key is within the effective range, the door may lock and unlock repeatedly. In that case, follow the following correction procedures to wash the vehicle:

- Place the key in a position 6 ft. (2 m) or more separate from the vehicle while the vehicle is being washed. (Take care to ensure that the key is not stolen.)
- Set the electronic key to battery-saving mode to disable the smart key system. (→P.111)

#### ■ Wheels and wheel ornaments (vehicles without matte painted wheels)

- Remove any dirt immediately by using a neutral detergent.
- Wash detergent off with water immediately after use.
- To protect the paint from damage, make sure to observe the following precautions.
  - Do not use acidic, alkaline or abrasive detergent
  - Do not use hard brushes
  - Do not use detergent on the wheels when they are hot, such as after driving or parking in hot weather

#### ■ Wheels and wheel ornaments (vehicles with matte painted wheels)

As matte painted wheels require different cleaning methods than conventional wheels, be sure to observe the following. For details, consult your Toyota dealer.

- Remove dirt using water. If the wheels are excessively dirty, use a sponge or soft cloth dampened



with a diluted neutral detergent to remove the dirt.

- To protect the matte paint from damage, make sure to observe the following precautions.
- Do not scrub or polish the wheels using a brush or dry cloth
- Do not use any wheel coatings or abrasive detergents

■ **Brake pads and calipers**

Rust may form if the vehicle is parked with wet brake pads or disc rotors, causing them to stick. Before parking the vehicle after it is washed, drive slowly and apply the brakes several times to dry the parts.

■ **Bumpers**

Do not scrub with abrasive cleaners.

■ **Plated portions**

If dirt cannot be removed, clean the parts as follows:

- Use a soft cloth dampened with an approximately 5% solution of neutral detergent and water to clean the dirt off.
- Wipe the surface with a dry, soft cloth to remove any remaining moisture.
- To remove oily deposits, use alcohol wet wipes or a similar product.

 **WARNING**

■ **When washing the vehicle**  
Do not apply water to the inside of the engine compartment. Doing so may cause the electrical components, etc. to catch fire.

■ **Precautions regarding the exhaust pipes**

Exhaust gasses cause the exhaust pipes and rear bumper diffusers to become quite hot. When washing the vehicle, be careful not to touch the pipes and diffusers until they have cooled sufficiently, as touching hot exhaust pipes and rear bumper diffusers can cause burns.

■ **Precaution regarding the rear bumper**

If the paint of the rear bumper is chipped or scratched, the following systems may not function correctly. If this occurs, consult your Toyota dealer.

- BSD/RCTA (if equipped)
- RAB (if equipped)

 **NOTICE**

■ **To prevent paint deterioration and corrosion on the body and components (aluminum wheels, etc.)**

● Wash the vehicle immediately in the following cases:

- After driving near the sea coast
- After driving on salted roads
- If coal tar or tree sap is present on the paint surface
- If dead insects, insect droppings or bird droppings are present on the paint surface
- After driving in an area contaminated with soot, oily smoke, mine dust, iron powder or chemical substances
- If the vehicle becomes heavily soiled with dust or mud



**NOTICE**

- If liquids such as benzene and gasoline are spilled on the paint surface
- If the paint is chipped or scratched, have it repaired immediately.
- To prevent the wheels from corroding, remove any dirt and store in a place with low humidity when storing the wheels.

■ **Protective film for side sill plates (if equipped)**

Make sure to remove the protective film. Failure to do so may cause rust, depending on conditions.

■ **Cleaning the exterior lights**

- Wash carefully. Do not use organic substances or scrub with a hard brush. This may damage the surfaces of the lights.
- Do not apply wax to the surfaces of the lights. Wax may cause damage to the lenses.

■ **To prevent damage to the windshield wiper arms**

When lifting the wiper arms away from the windshield, pull the driver side wiper arm upward first, and repeat for the passenger side. When returning the wipers to their original position, do so from the passenger side first.

■ **When using a high pressure car wash**

- When washing the vehicle, do not spray the camera or its surrounding area directly with a high pressure washer. Shock applied from high pressure water may cause the device to not operate normally.

- Do not bring the nozzle tip close to boots (rubber or resin manufactured cover), connectors or the following parts. The parts may be damaged if they come into contact with high-pressure water.
  - Traction related parts
  - Suspension parts
  - Steering parts
  - Brake parts
- Keep the cleaning nozzle at least 11.9 in. (30 cm) away from the vehicle body. Otherwise resin section, such as moldings and bumpers, may be deformed and damaged.

Also, do not continuously hold the nozzle in the same place.

- Do not spray the lower part of the windshield continuously.

If water enters the air conditioning system intake located near the lower part of the windshield, the air conditioning system may not operate correctly.

- Do not wash the underside of the vehicle using a high pressure car washer.

## Cleaning and protecting the vehicle interior

Perform cleaning in a manner appropriate to each component and its material.

### Protecting the vehicle interior

- Remove dirt and dust using a vacuum cleaner. Wipe dirty surfaces with a cloth dampened with lukewarm water.
- If dirt cannot be removed, wipe it off with a soft cloth dampened with neutral detergent diluted to approximately 1%.

Wring out any excess water from the cloth and thoroughly wipe off remaining traces of detergent and water.

#### ■ Shampooing the carpets

There are several commercial foaming-type cleaners available. Use a sponge or brush to apply the foam. Rub in overlapping circles. Do not use water. Wipe dirty surfaces and let them dry. Excellent results are obtained by keeping the carpet as dry as possible.

#### ■ Handling the seat belts

Clean with mild soap and lukewarm water using a cloth or sponge. Also check the belts periodically for excessive wear, fraying or cuts.

#### ■ Meter visor

Do not place anything on top of meter visor. The color of the meter visor may transfer.

### WARNING

#### ■ Water in the vehicle

- Do not splash or spill liquid in the vehicle.

Doing so may cause electrical components, etc. to malfunction or catch fire.

- Do not get any of the SRS components or wiring in the vehicle interior wet. (→P.29)

An electrical malfunction may cause the airbags to deploy or not function properly, resulting in death or serious injury.

#### ■ Cleaning the interior (especially instrument panel)

Do not use polish wax or polish cleaner. The instrument panel may reflect off the windshield, obstructing the driver's view and leading to an accident, resulting in death or serious injury.

### NOTICE

#### ■ Cleaning detergents

- Do not use the following types of detergent, as they may discolor the vehicle interior or cause streaks or damage to painted surfaces:

- Non-seat portions: Organic substances such as benzene or gasoline, alkaline or acidic solutions, dye, and bleach
- Seats: Alkaline or acidic solutions, such as thinner, benzene, and alcohol
- Do not use polish wax or polish cleaner. The instrument panel's or other interior part's painted surface may be damaged.



**NOTICE**

- Do not use a chemical agent containing silicone (highly-polymerized silicon compound) when cleaning any of the electrical appliances such as the air conditioning, all switches and their surrounding areas.  
If silicon (highly-polymerized silicon compound) contacts these components, it may cause the electrical appliances to malfunction.

■ **Preventing damage to leather surfaces**

Observe the following precautions to avoid damage to and deterioration of leather surfaces:

- Remove any dust or dirt from leather surfaces immediately.
- Do not expose the vehicle to direct sunlight for extended periods of time. Park the vehicle in the shade, especially during summer.
- Do not place items made of vinyl, plastic, or containing wax on the upholstery, as they may stick to the leather surface if the vehicle interior heats up significantly.

■ **Water on the floor**

Do not wash the vehicle floor with water.

Vehicle systems such as the audio system may be damaged if water comes into contact with electrical components such as the audio system above or under the floor of the vehicle. Water may also cause the body to rust.

■ **When cleaning the inside of the windshield**

Do not allow glass cleaner to contact the lens. Also, do not touch the lens. (→P.174)

■ **Cleaning the inside of the rear window**

- Do not use glass cleaner to clean the rear window, as this may cause damage to the rear window defogger heater wires. Use a cloth dampened with lukewarm water to gently wipe the window clean. Wipe the window in strokes running parallel to the heater wires.

- Be careful not to scratch or damage the heater wires.

■ **When cleaning the instrument panel**

When small grains of sand and so forth have gotten into instrument panel's surface and cannot be wiped away using a cloth, use a clay bar without adding water. Forcibly trying to wipe the surface clean with a brush or sponge may scratch the surface or fragments of the cloth may be left in the surface.

**Cleaning the leather areas**

- Remove dirt and dust using a vacuum cleaner.
- Wipe off any excess dirt and dust with a soft cloth dampened with diluted detergent.

Use a diluted water solution of approximately 5% neutral wool detergent.

- Wring out any excess water from the cloth and thoroughly wipe off all remaining traces

of detergent.

- Wipe the surface with a dry, soft cloth to remove any remaining moisture. Allow the leather to dry in a shaded and ventilated area.

#### ■ Caring for leather areas

Toyota recommends cleaning the interior of the vehicle at least twice a year to maintain the quality of the vehicle's interior.

#### Cleaning the synthetic leather areas

- Remove dirt and dust using a vacuum cleaner.
- Wipe it off with a soft cloth dampened with neutral detergent diluted to approximately 1%.
- Wring out any excess water from the cloth and thoroughly wipe off remaining traces of detergent and water.

#### Cleaning and protecting the Ultrasuede® area\*

\*: If equipped

\*: Ultrasuede® is a registered trademark of Toray Industries, Inc.

#### Perform cleaning in a manner appropriate to each component and its material.

#### Day-to-day cleaning

- Periodic cleaning once a month is recommended.
- 1 Wipe the entire Ultrasuede® area with a soft cloth that has been dampened with lukewarm water (approximately 104°F [40°C]) and squeezed out.

Do not wipe too hard. Doing so may make the Ultrasuede® upholstery surface become uneven. Also, only use a clean cloth.

- 2 Once dry, brush the area with a soft brush.



#### NOTICE

#### ■ When cleaning the Ultrasuede® surfaces

As Ultrasuede® is a suede-like product, do not brush it strongly. Doing so may cause fluff or pilling.

#### ■ Removing stuck-on dirt

If fluff is attached to your clothes, etc. remove it by brushing it off with a soft brush. If this does not remove the fluff, remove it using adhesive

tape.

### Liquid stains

- If liquid is spilled, lightly pat the area with a tissue paper or similar to soak up the liquid.
- When mud, coffee, etc., has dried on the Ultrasuede<sup>®</sup> upholstery, remove it by lightly brushing the area with a soft brush or similar.

We recommend using a vacuum cleaner to clean up the area after the above has been performed.

When a stain cannot be removed using the above procedures, remove it by performing the following:

- 1 Lightly wipe the stained area from the outside to the inside from multiple angles with a soft cloth that has been dampened with lukewarm water (approximately 104°F [40°C]) and squeezed out.

Do not wipe too hard. Doing so may make the Ultrasuede<sup>®</sup> upholstery surface become uneven. Also, only use a clean cloth.

- 2 If the Ultrasuede<sup>®</sup> upholstery surface becomes uneven, lightly brush it with a soft brush.
- 3 Allow the surface to dry completely.

### NOTICE

#### ■ When soaking up spilled liquids

Do not press down too firmly with the cloth, tissue paper etc., as doing so may cause the liquid to further penetrate the material, making soaking up the liquid more difficult.

### Oily stains

You will need the following items:

- A cloth that has been dampened with benzene
  - A dry cloth
- 1 Using a dry cloth or tissue paper, wipe away as much of the oil as possible to prevent the stained area from expanding.
  - 2 After patting the area from the outside to the inside from multiple angles using the cloth dampened with benzene, soak up the oil and benzene that floats up by patting the area with a dry cloth.
  - 3 If the Ultrasuede<sup>®</sup> upholstery surface becomes uneven, lightly brush it with a soft brush.

**Maintenance requirements**

**To ensure safe and economical driving, day-to-day care and regular maintenance are essential. It is the owner's responsibility to perform regular checks. Toyota recommends the maintenance below.**

**■ Repair and replacement**

It is recommended that genuine Toyota parts be used for repairs to ensure performance of each system. If non-Toyota parts are used in replacement or if a repair shop other than a Toyota dealer performs repairs, confirm the warranty coverage.

**■ Allow inspection and repairs to be performed by a Toyota dealer**

- Toyota technicians are well-trained specialists and are kept up to date with the latest service information. They are well informed about the operation of all systems on your vehicle.
- Keep a copy of the repair order. It proves that the maintenance that has been performed is under warranty coverage. If any problem should arise while your vehicle is under warranty, your Toyota dealer will promptly take care of it.

**⚠ WARNING**

**■ If your vehicle is not properly maintained**

Improper maintenance could result in serious damage to the vehicle and possible death or serious injury.

**■ Handling of the battery**

- Engine exhaust, some of its constituents, and a wide variety of automobile components contain or emit chemicals known to the State of California to cause cancer and birth defects and other reproductive harm. Work in a well ventilated area.
- Oils, fuels and fluids contained in vehicles as well as waste produced by component wear contain or emit chemicals known to the State of California to cause cancer and birth defects or other reproductive harm. Avoid exposure and wash any affected area immediately.
- Battery posts, terminals and related accessories contain lead and lead compounds which are known to cause brain damage. Wash your hands after handling. (→P.309)

**General maintenance**

General maintenance should be performed on a daily basis. This can be done by yourself or by a Toyota dealer.

**Scheduled maintenance**

Scheduled maintenance should be performed at specified intervals according to the maintenance schedule.

For details about maintenance items and schedules, refer to the "Scheduled Maintenance Guide" or "Owner's Manual Supplement".

### Do-it-yourself maintenance

You can perform some maintenance procedures by yourself. Please be aware that do-it-yourself maintenance may affect warranty coverage.

The use of Toyota repair manuals is recommended.

For details about warranty coverage, refer to the separate "Owner's Warranty Information Booklet" or "Owner's Manual Supplement".

### General maintenance

Listed below are the general maintenance items that should be performed at the intervals specified in the "Owner's Warranty Information Booklet" or "Owner's Manual Supplement/Scheduled Maintenance Guide". It is recommended that any problem you notice should be brought to the attention of your Toyota dealer or qualified service shop for advice.

#### WARNING

**■ If the engine is running**

Turn the engine off and ensure that there is adequate ventilation before performing maintenance checks.

### Engine compartment

Items	Check points
Battery	Check the connections. (→P.309)
Brake fluid/Clutch fluid	Is the brake fluid and clutch fluid at the correct level? (→P.308)
Engine coolant	Is the engine coolant at the correct level? (→P.307)
Engine oil	Is the engine oil at the correct level? (→P.305)



Items	Check points
Exhaust system	There should not be any fumes or strange sounds.
Radiator/condenser	The radiator and condenser should be free from foreign objects. (→P.308)
Washer fluid	Is there sufficient washer fluid? (→P.311)

**Vehicle interior**

Items	Check points
Accelerator pedal	<ul style="list-style-type: none"> <li>The accelerator pedal should move smoothly (without uneven pedal effort or catching).</li> </ul>
Automatic transmission "Park" mechanism	<ul style="list-style-type: none"> <li>When parked on a slope and the shift lever is in P, is the vehicle securely stopped?</li> </ul>
Brake pedal	<ul style="list-style-type: none"> <li>Does the brake pedal move smoothly?</li> <li>Does the brake pedal have appropriate clearance from the floor?</li> <li>Does the brake pedal have the correct amount of free play?</li> </ul>

Items	Check points
Brakes	<ul style="list-style-type: none"> <li>The vehicle should not pull to one side when the brakes are applied.</li> <li>The brakes should work effectively.</li> <li>The brake pedal should not feel spongy.</li> <li>The brake pedal should not get too close to the floor when the brakes are applied.</li> </ul>
Clutch pedal	<ul style="list-style-type: none"> <li>Does the clutch pedal move smoothly?</li> <li>Does the clutch pedal have appropriate clearance from the floor?</li> <li>Does the clutch pedal have the correct amount of free play?</li> </ul>
Head restraints	<ul style="list-style-type: none"> <li>Do the head restraints move smoothly and lock securely?</li> </ul>
Indicators/buzzers	<ul style="list-style-type: none"> <li>Do the indicators and buzzers function properly?</li> </ul>
Lights	<ul style="list-style-type: none"> <li>Do all the lights come on?</li> </ul>

Items	Check points
Parking brake	<ul style="list-style-type: none"> <li>• Does the parking brake move smoothly?</li> <li>• When parked on a slope and the parking brake is on, is the vehicle securely stopped?</li> </ul>
Seat belts	<ul style="list-style-type: none"> <li>• Do the seat belts operate smoothly?</li> <li>• The seat belts should not be damaged.</li> </ul>
Seats	<ul style="list-style-type: none"> <li>• Do the seat controls operate properly?</li> </ul>
Steering wheel	<ul style="list-style-type: none"> <li>• Does the steering wheel rotate smoothly?</li> <li>• Does the steering wheel have the correct amount of free play?</li> <li>• There should not be any strange sounds coming from the steering wheel.</li> </ul>

**Vehicle exterior**

Items	Check points
Doors/trunk	<ul style="list-style-type: none"> <li>• Do the doors/trunk operate smoothly?</li> </ul>
Engine hood	<ul style="list-style-type: none"> <li>• Does the engine hood lock system work properly?</li> </ul>
Fluid leaks	<ul style="list-style-type: none"> <li>• There should not be any signs of fluid leakage after the vehicle has been parked.</li> </ul>
Tires	<ul style="list-style-type: none"> <li>• Is the tire inflation pressure correct?</li> <li>• The tires should not be damaged or excessively worn.</li> <li>• Have the tires been rotated according to the maintenance schedule?</li> <li>• The wheel nuts should not be loose.</li> </ul>
Windshield wipers	<ul style="list-style-type: none"> <li>• The wiper blades should not show any signs of cracking, splitting, wear, contamination or deformation.</li> <li>• The wiper blades should clear the windshield without streaking or skipping.</li> </ul>

### Emission inspection and maintenance (I/M) programs

**Some states have vehicle emission inspection programs which include OBD (On Board Diagnostics) checks. The OBD system monitors the operation of the emission control system.**

#### If the malfunction indicator lamp comes on

The OBD system determines that a problem exists somewhere in the emission control system. Your vehicle may not pass the I/M test and may need to be repaired. Contact your Toyota dealer to service the vehicle.

#### Your vehicle may not pass the I/M test in the following situations:

- When the battery is disconnected or discharged

Readiness codes that are set during ordinary driving are erased. Also, depending on your driving habits, the readiness codes may not be completely set.

- When the fuel tank cap is loose

The malfunction indicator lamp comes on indicating a temporary malfunction and your vehicle may not pass the I/M test.

#### When the malfunction indicator lamp still remains on after several driving trips

The error code in the OBD system will not be cleared unless the vehicle is driven 40 or more times.

#### If your vehicle does not pass the I/M test

Contact your Toyota dealer to prepare the vehicle for re-testing.

**Do-it-yourself service precautions**

**If you perform maintenance by yourself, be sure to follow the correct procedure as given in these sections.**

**Maintenance**

Items	Parts and tools
Battery condition (→P.309)	<ul style="list-style-type: none"> <li>• Warm water</li> <li>• Baking soda</li> <li>• Grease</li> <li>• Conventional wrench (for terminal clamp bolts)</li> </ul>
Brake fluid and Clutch fluid level (→P.308)	<ul style="list-style-type: none"> <li>• SAE J1703 or FMVSS No.116 DOT 3 brake fluid</li> <li>• Rag or paper towel</li> <li>• Funnel (used only for adding brake fluid and clutch fluid)</li> </ul>

Items	Parts and tools
Engine coolant level(→P.307)	<ul style="list-style-type: none"> <li>• “TOYOTA Genuine 50/50 Pre-mixed Super Long Life Coolant BLUE” or a similar high quality ethylene glycol-based non-silicate, non-amine, non-nitrite and non-borate coolant with long-life hybrid organic acid technology.</li> <li>• For the U.S.A.: “TOYOTA Genuine 50/50 Pre-mixed Super Long Life Coolant BLUE” is pre-mixed with 50% coolant and 50% deionized water.</li> <li>• For Canada: “TOYOTA Genuine 50/50 Pre-mixed Super Long Life Coolant BLUE” is pre-mixed with 55% coolant and 45% deionized water.</li> <li>• Funnel (used only for adding coolant)</li> </ul>

Items	Parts and tools
Engine oil level (→P.305)	<ul style="list-style-type: none"> <li>• “Toyota Genuine Motor Oil” or equivalent</li> <li>• Rag or paper towel</li> <li>• Funnel (used only for adding engine oil)</li> </ul>
Fuses (→P.330)	<ul style="list-style-type: none"> <li>• Fuse with same amperage rating as original</li> </ul>
Light bulbs (→P.333)	<ul style="list-style-type: none"> <li>• Bulb with same number and wattage rating as original</li> <li>• Phillips-head screwdriver</li> <li>• Flathead screwdriver</li> </ul>
Radiator and condenser (→P.308)	—
Tire inflation pressure (→P.323)	<ul style="list-style-type: none"> <li>• Tire pressure gauge</li> <li>• Compressed air source</li> </ul>
Washer fluid (→P.311)	<ul style="list-style-type: none"> <li>• Water or washer fluid containing antifreeze (for winter use)</li> <li>• Funnel (used only for adding water or washer fluid)</li> </ul>

**⚠ WARNING**

The engine compartment contains many mechanisms and fluids that may move suddenly, become hot, or become electrically energized. To avoid death or serious injury, observe the following precautions.

**■ When working on the engine compartment**

- Keep hands, clothing and tools away from the moving fans and engine drive belt.
- Be careful not to touch the engine, radiator, exhaust manifold, etc. right after driving as they may be hot. Oil and other fluids may also be hot.
- Do not leave anything that may burn easily, such as paper and rags, in the engine compartment.
- Do not smoke, cause sparks or expose an open flame to fuel or the battery. Fuel and battery fumes are flammable.
- Be extremely cautious when working on the battery. It contains poisonous and corrosive sulfuric acid.

**■ When working near the electric cooling fans or radiator grille**

Be sure the engine switch is off. With the engine switch in ON, the electric cooling fans may automatically start to run if the air conditioning is on and/or the coolant temperature is high. (→P.308)

**■ Safety glasses**

Wear safety glasses to prevent flying or falling material, fluid spray, etc. from getting in your eyes.



NOTICE

**■ If you remove the air cleaner filter**

Driving with the air cleaner filter removed may cause excessive engine wear due to dirt in the air.

## Hood

### Opening the hood

- 1 Pull the hood lock release lever.

The hood will pop up slightly.

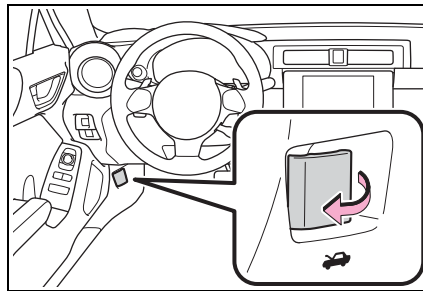

- 2 Push the auxiliary catch lever to the left and lift the hood.

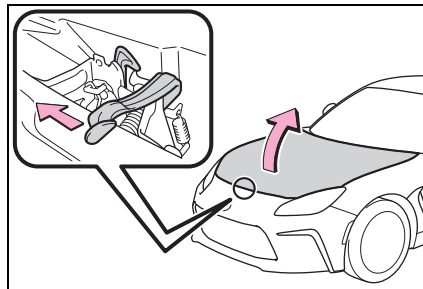

- 3 Hold the hood open by inserting the support rod into the slot.

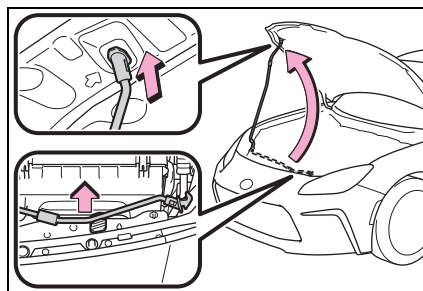

**⚠ WARNING****■ Pre-driving check**

Check that the hood is fully closed and locked.

If the hood is not locked properly, it may open while the vehicle is in motion and cause an accident, which may result in death or serious injury.

**⚠ NOTICE****■ When opening the hood**

- Do not lift up or operate the wipers. Doing so may cause the hood and wipers to contact, scratching the hood.
- Use caution when opening the hood in windy weather as it may close suddenly in strong wind.
- Do not attach any accessories other than genuine Toyota products to the hood. Such additional weight on the hood may cause it to be too heavy to be supported by the supporting rod when opened.

**■ When closing the hood**

Do not apply excessive weight or force when closing the hood as doing so may result in damage.

**Positioning a floor jack**

**When using a floor jack, follow the instructions in the manual provided with the jack and perform the operation safely.**

**When raising your vehicle with a floor jack, position the jack correctly. Improper placement may damage your vehicle or cause injury.**

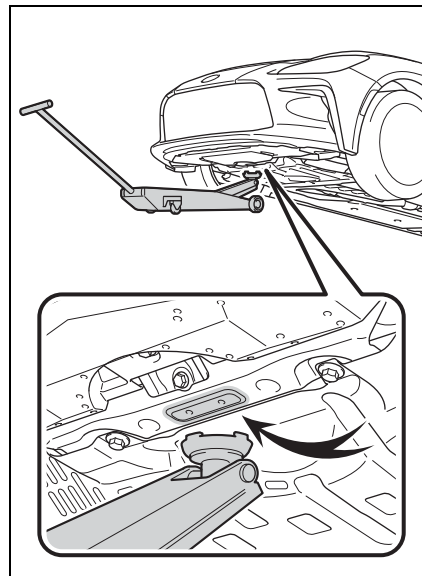
**Location of the jack point****■ Front**

■ Rear

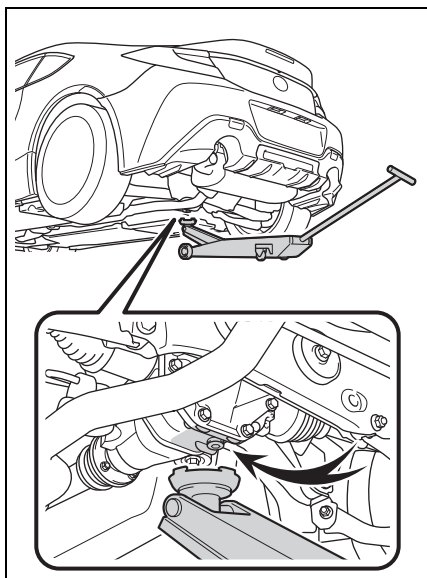



## Engine compartment

## Components

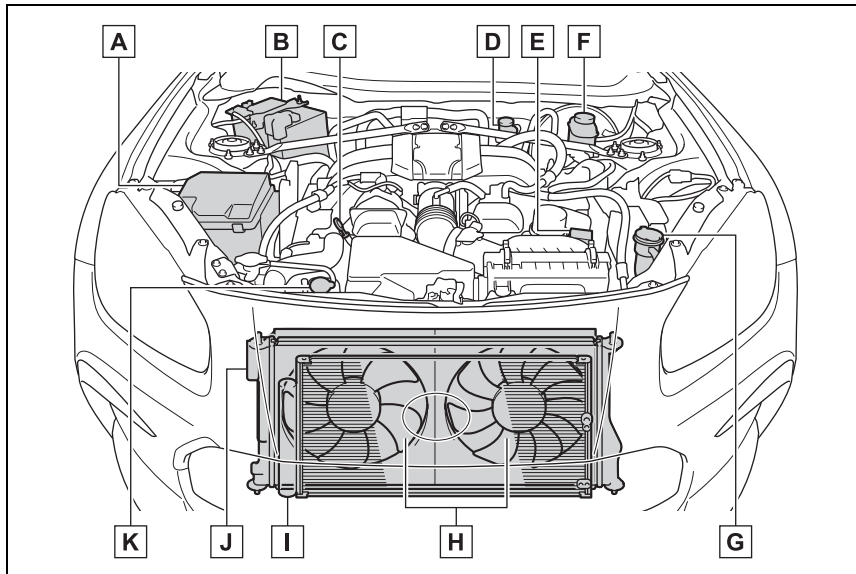

- A** Fuse boxes (→P.330)
- B** Battery (→P.309)
- C** Engine oil level dipstick (→P.305)
- D** Clutch fluid reservoir (→P.308)
- E** Engine oil filler cap (→P.305)
- F** Brake fluid reservoir (→P.308)
- G** Washer fluid tank (→P.311)
- H** Electric cooling fans
- I** Condenser (→P.308)
- J** Radiator (→P.308)
- K** Engine coolant reservoir (→P.307)

**Checking and adding the engine oil**

With the engine at operating

temperature and turned off, check the oil level on the dipstick.

■ **Checking the engine oil**

- 1 Park the vehicle on level ground. After warming up the engine and turning it off, wait more than 5 minutes for the oil to drain back into the bottom of the engine.
- 2 Holding a rag under the end, pull the dipstick out.

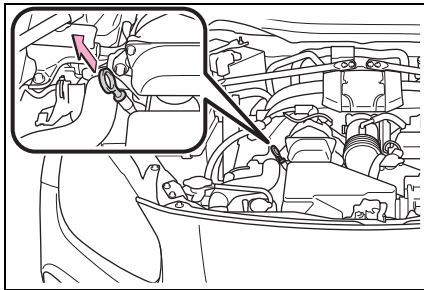

- 3 Wipe the dipstick clean.
- 4 Reinsert the dipstick fully.
- 5 Holding a rag under the end, pull the dipstick out and check the oil level.

When checking the oil, look at both sides of the dipstick and use the lower measurement to determine the level of oil.

- 6 Wipe the dipstick and reinsert it fully.

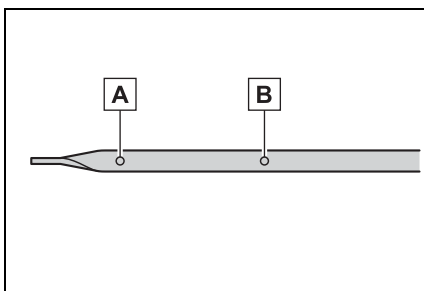

**A** Low

**B** Full

■ **Checking the oil type and preparing the item needed**

Make sure to check the oil type and prepare the items needed before adding oil.

- Engine oil selection  
→P.382
- Oil quantity (Low → Full)  
1.1 qt. (1.0 L, 0.9 Imp. qt.)
- Item  
Clean funnel

■ **Adding engine oil**

If the oil level is below or near the low level mark, add engine oil of the same type as that already in the engine.

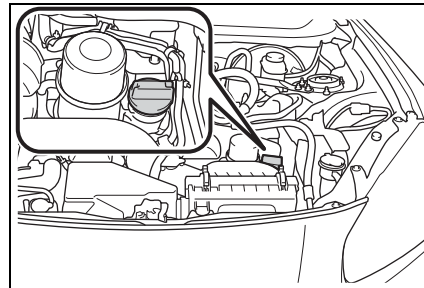

- 1 Remove the oil filler cap by turning it counterclockwise.
- 2 Add engine oil slowly, checking the dipstick.
- 3 Install the oil filler cap by turning it clockwise.

■ **Engine oil consumption**

A certain amount of engine oil will be consumed while driving. In the following situations, oil consumption may increase, and engine oil

may need to be refilled in between oil maintenance intervals.

- When the engine is new, for example directly after purchasing the vehicle or after replacing the engine
- If low quality oil or oil of an inappropriate viscosity is used
- When driving at high engine speeds or with a heavy load, or when driving while accelerating or decelerating frequently
- When leaving the engine idling for a long time, or when driving frequently through heavy traffic

**⚠ WARNING**

■ **Used engine oil**

- Used engine oil contains potentially harmful contaminants which may cause skin disorders such as inflammation and skin cancer, so care should be taken to avoid prolonged and repeated contact. To remove used engine oil from your skin, wash thoroughly with soap and water.
- Dispose of used oil and filters only in a safe and acceptable manner. Do not dispose of used oil and filters in household trash, in sewers or onto the ground. Call your Toyota dealer, service station or auto parts store for information concerning recycling or disposal.
- Do not leave used engine oil within the reach of children.

**⚠ NOTICE**

■ **To prevent serious engine damage**

Check the oil level on a regular basis.

■ **When replacing the engine oil**

- Be careful not to spill engine oil on the vehicle components.
- Avoid overfilling, or the engine could be damaged.
- Check the oil level on the dipstick every time you refill the vehicle.
- Be sure the engine oil filler cap is properly tightened.

**Checking the coolant**

The coolant level is satisfactory if it is between the “FULL” and “LOW” lines on the reservoir when the engine is cold.

■ **Engine coolant reservoir**

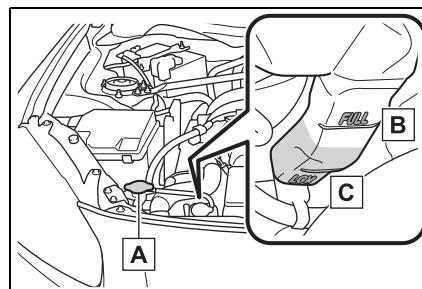

**A** Reservoir cap

**B** “FULL” line

**C** “LOW” line

If the level is on or below the “LOW” line, add coolant up to the “FULL” line. (→P.375)

■ **Coolant selection**

Only use “TOYOTA Genuine 50/50 Pre-mixed Super Long Life Coolant BLUE” or a similar high quality ethylene glycol based non-silicate, non-amine, non-nitrite, and non-borate coolant with long-life

hybrid organic acid technology.

U.S.A.:

“TOYOTA Genuine 50/50 Pre-mixed Super Long Life Coolant BLUE” is a mixture of 50% coolant and 50% deionized water. (Minimum temperature: -31°F [-35°C])

Canada:

“TOYOTA Genuine 50/50 Pre-mixed Super Long Life Coolant BLUE” is a mixture of 55% coolant and 45% deionized water. (Minimum temperature: -44°F [-42°C])

For more details about coolant, contact your Toyota dealer.

■ **If the coolant level drops within a short time of replenishing**

Visually check the radiator, hoses, engine coolant reservoir caps, drain cock and water pump.

If you cannot find a leak, have your Toyota dealer test the cap and check for leaks in the cooling system.

 **WARNING**

■ **When the engine is hot**

Do not remove the engine coolant reservoir cap. (→P.376)

The cooling system may be under pressure and may spray hot coolant if the cap is removed, causing serious injuries, such as burns.

 **NOTICE**

■ **When adding coolant**

Coolant is neither plain water nor straight antifreeze. The correct mixture of water and antifreeze must be used to provide proper lubrication, corrosion protection and cooling. Be sure to read the antifreeze or coolant label.

■ **If you spill coolant**

Be sure to wash it off with water to prevent it from damaging parts or paint.

**Checking the radiator and condenser**

Check the radiator and condenser and clear away any foreign objects.

If either of the above parts is extremely dirty or you are not sure of their condition, have your vehicle inspected by your Toyota dealer.

 **WARNING**

■ **When the engine is hot**

Do not touch the radiator or condenser as they may be hot and cause serious injuries, such as burns.

**Checking and adding the brake fluid and clutch fluid**

■ **Checking fluid level**

The brake fluid and clutch fluid level should be between the “MAX” and “MIN” lines on the tank.

► Brake fluid

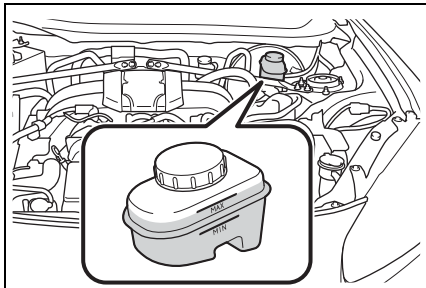

► Clutch fluid

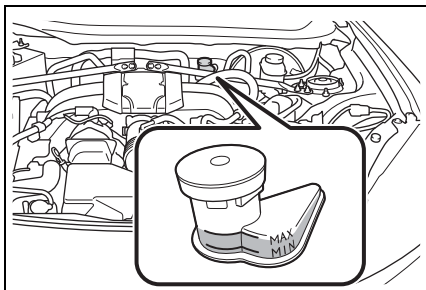

■ Adding fluid

Make sure to check the fluid type and prepare the necessary item.

- Fluid type  
SAE J1703 or FMVSS No.116 DOT 3
- Item  
Clean funnel

■ Brake fluid can absorb moisture from the air

Excess moisture in the brake fluid can cause a dangerous loss of braking efficiency. Use only newly opened brake fluid.

**! WARNING**

■ When filling the reservoir

Take care as brake fluid and clutch fluid can harm your hands and eyes and damage painted surfaces. If fluid gets on your hands or in your eyes, flush the affected area with clean water immediately.

If you still experience discomfort, see a doctor.

**! NOTICE**

■ If the fluid level is low or high

It is normal for the brake fluid level to go down slightly as the brake pads wear out or when the fluid level in the accumulator is high.

If the reservoir needs frequent refilling, there may be a serious problem.

**Battery**

Check the battery as follows.

■ Battery exterior

Make sure that the battery terminals are not corroded and that there are no loose connections, cracks, or loose clamps.

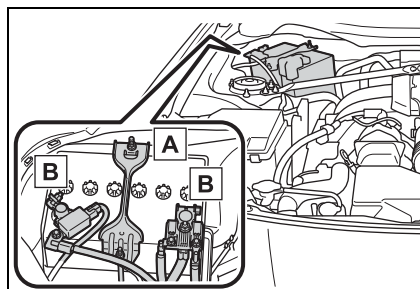

**A** Hold-down clamp

**B** Terminals

### ■ Checking battery fluid

Check that the level is between the “UPPER LEVEL” and “LOWER LEVEL” lines.

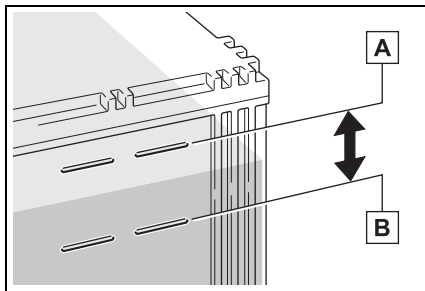

**A** “UPPER LEVEL” line

**B** “LOWER LEVEL” line

If the fluid level is at or below the “LOWER LEVEL” line, add distilled water.

### ■ Adding distilled water

- 1 Remove the vent plug.
- 2 Add distilled water.

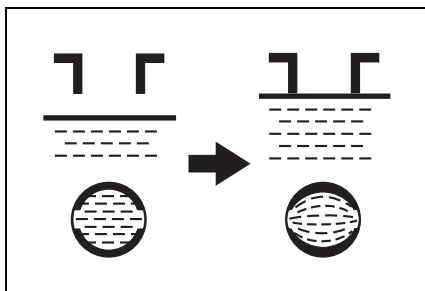

If the “UPPER LEVEL” line cannot be seen, check the fluid level by looking directly at the cell.

- 3 Put the vent plug back on and close it securely.

### ■ Before recharging

When recharging, the battery produces hydrogen gas which is flammable and explosive. Therefore,

observe the following before recharging:

- If recharging with the battery installed on the vehicle, be sure to disconnect the ground cable.
- Make sure the power switch on the charger is off when connecting and disconnecting the charger cables to the battery.

### ■ After recharging/reconnecting the battery

The engine may not start. Follow the procedure below to initialize the system.

- 1 Shift the shift lever to P (automatic transmission) or depress the brake pedal with the shift lever in N (manual transmission).
  - 2 Open and close either door.
  - 3 Restart the engine.
- Unlocking the doors using the smart key system may not be possible immediately after reconnecting the battery. If this happens, use the wireless remote control or the mechanical key to lock/unlock the doors.
  - Start the engine with the engine switch in ACC. The engine may not start with the engine switch turned off. However, the engine will operate normally from the second attempt.
  - The engine switch mode is recorded by the vehicle. If the battery is disconnected and reconnected, the vehicle will return the engine switch mode to the status it was in before the battery was disconnected. Make sure to turn off the engine before disconnecting the battery. Take extra care when connecting the battery if the engine switch mode prior to the battery being disconnected is unknown.

If the system will not start even after multiple attempts, contact your Toyota dealer.

**⚠ WARNING****■ Chemicals in the battery**

Batteries contain poisonous and corrosive sulfuric acid and may produce hydrogen gas which is flammable and explosive. To reduce the risk of death or serious injury, take the following precautions while working on or near the battery:

- Do not cause sparks by touching the battery terminals with tools.
- Do not smoke or light a match near the battery.
- Avoid contact with eyes, skin and clothes.
- Never inhale or swallow electrolyte.
- Wear protective safety glasses when working near the battery.
- Keep children away from the battery.

**■ Where to safely charge the battery**

Always charge the battery in an open area. Do not charge the battery in a garage or closed room where there is insufficient ventilation.

**■ Emergency measures regarding electrolyte**

- If electrolyte gets in your eyes  
Flush your eyes with clean water for at least 15 minutes and get immediate medical attention. If possible, continue to apply water with a sponge or cloth while traveling to the nearest medical facility.

- If electrolyte gets on your skin

Wash the affected area thoroughly. If you feel pain or burning, get medical attention immediately.

- If electrolyte gets on your clothes

It can soak through clothing on to your skin. Immediately take off the clothing and follow the procedure above if necessary.

- If you accidentally swallow electrolyte

Drink a large quantity of water or milk. Get emergency medical attention immediately.

**⚠ NOTICE****■ When recharging the battery**

Never recharge the battery while the engine is running. Also, be sure all accessories are turned off.

**■ When adding distilled water**

Avoid overfilling. Water spilled during battery recharging may cause corrosion.

**Adding the washer fluid**

If the washer fluid level is at "LOW", add washer fluid.

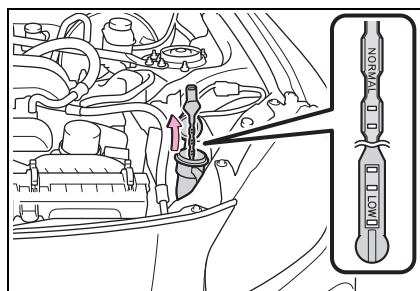

■ Using the gauge

The washer fluid level can be checked by observing the position of the level on the liquid-covered holes in the gauge. If the level falls below the second hole from the bottom (the “LOW” position), refill the washer fluid.

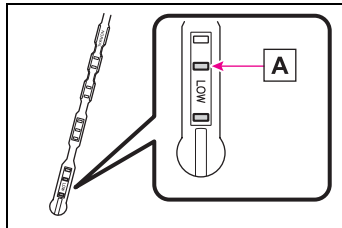

A Current fluid level

**⚠ WARNING**

■ When adding washer fluid

Do not add washer fluid when the engine is hot or running as washer fluid contains alcohol and may catch fire if spilled on the engine, etc.

**⚠ NOTICE**

■ Do not use any fluid other than washer fluid

Do not use soapy water or engine antifreeze instead of washer fluid.

Doing so may cause streaking on the vehicle’s painted surfaces, as well as damaging the pump leading to problems of the washer fluid not spraying.

■ Diluting washer fluid

Dilute washer fluid with water as necessary.

Refer to the freezing temperatures listed on the label of the washer fluid bottle.

**Tires**

**Replace or rotate tires in accordance with maintenance schedules and treadwear.**

**Checking tires**

Check if the treadwear indicators are showing on the tires. Also check the tires for uneven wear, such as excessive wear on one side of the tread.

Check the spare tire condition and pressure if not rotated.

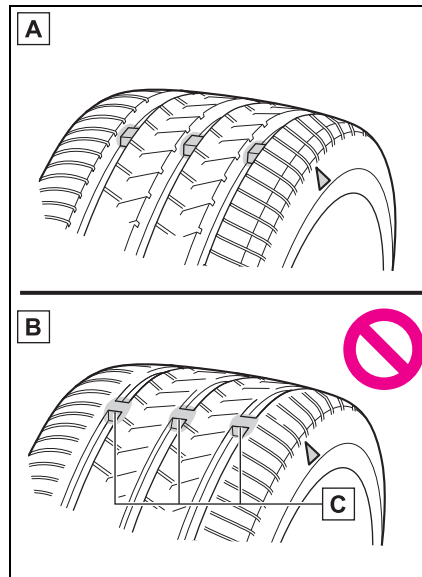

A New tread

B Worn tread

C Treadwear indicator

The location of treadwear indicators is shown by a “TWI” or “△” mark,



etc., molded into the sidewall of each tire. Replace the tires if the treadwear indicators are showing on a tire.

#### ■ When to replace your vehicle's tires

Tires should be replaced if:

- The treadwear indicators are showing on a tire.
- You have tire damage such as cuts, splits, cracks deep enough to expose the fabric, and bulges indicating internal damage
- A tire goes flat repeatedly or cannot be properly repaired due to the size or location of a cut or other damage

If you are not sure, consult your Toyota dealer.

#### ■ Tire life

Any tire over 6 years old must be checked by a qualified technician even if it has seldom or never been used or damage is not obvious.

#### ■ Low profile tires

Generally, low profile tires will wear more rapidly and tire grip performance will be reduced on snowy and/or icy roads when compared to standard tires. Be sure to use snow tires or tire chains on snowy and/or icy roads and drive carefully at a speed appropriate for road and weather conditions.

#### ■ Maximum load of tire

Check that the maximum load of the replacement tire is greater than 1/2 of the Gross Axle Weight Ratings (GAWR) of either the front axle or the rear axle, whichever is greater.

For the GAWR, see the Certification Label. For the maximum load of the tire, see the load limit at maximum cold tire inflation pressure mentioned on the sidewall of the tire. (→P.390)

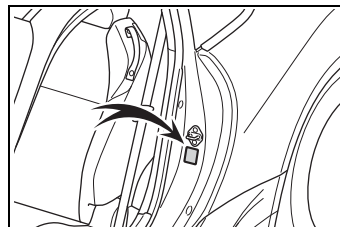

#### ■ Tire types

##### ● Summer tires

Summer tires are high-speed performance tires best suited to highway driving under dry conditions. Since summer tires do not have the same traction performance as snow tires, summer tires are inadequate for driving on snow-covered or icy roads. For driving on snow-covered roads or icy roads, the use of snow tires is recommended. When installing snow tires, be sure to replace all four tires.

##### ● All season tires

All season tires are designed to provide better traction in snow and to be adequate for driving in most winter conditions as well as for use year-round. All season tires, however, do not have adequate traction performance compared with snow tires in heavy or loose snow. Also, all season tires fall short in acceleration and handling performance compared with summer tires in highway driving.

##### ● Snow tires

For driving on snow-covered roads or icy roads, we recommend using snow tires. If you need snow tires, select tires of the same size, construction and load capacity as the originally installed tires. Since your vehicle has radial tires as original equipment, make sure your snow

tires also have radial construction. Do not install studded tires without first checking local regulations for possible restrictions. Snow tires should be installed on all wheels. (→P.266)

**■ If the tread on snow tires wears down below 0.16 in. (4 mm)**

The effectiveness of the tires as snow tires is lost.

 **WARNING**

**■ When inspecting or replacing tires**

Observe the following precautions to prevent accidents. Failure to do so may cause damage to parts of the drive train as well as dangerous handling characteristics, which may lead to an accident resulting in death or serious injury.

- Make sure to install 4 tires that are of the specified size, and that all 4 tires are the same size, same maker, same brand and tread pattern.
- Do not use tire sizes other than those recommended by Toyota.
- Only use radial tires.
- Do not mix summer, all season and snow tires.
- Do not use tires that have been used on another vehicle. Do not use tires if you do not know how they were used previously.

 **NOTICE**

**■ Low profile tires**

Low profile tires may cause greater damage than usual to the tire wheel when sustaining impact from the road surface. Therefore, pay attention to the following:

- Be sure to use proper tire inflation pressure. If tires are under-inflated, they may be damaged more severely.
- Avoid potholes, uneven pavement, curbs and other road hazards. Failure to do so may lead to severe tire and wheel damage.

**■ If tire inflation pressure of each tire becomes low while driving**

Do not continue driving, or your tires and/or wheels may be ruined.

**■ Driving on rough roads**

Take particular care when driving on roads with loose surfaces or potholes. These conditions may cause losses in tire inflation pressure, reducing the cushioning ability of the tires. In addition, driving on rough roads may cause damage to the tires themselves, as well as the vehicle's wheels and body.

**Tire rotation**

Rotate the tires in the order shown.

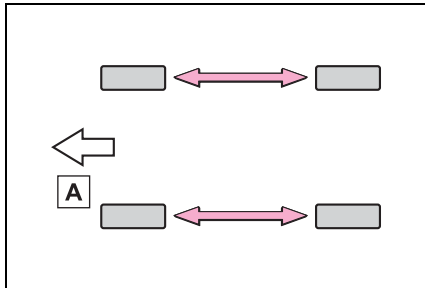

**A** Front

To equalize tire wear and extend tire life, Toyota recommends that tire rotation is carried out at the same interval as tire inspection.

### Tire pressure warning system

Your vehicle is equipped with a tire pressure warning system that uses tire pressure warning valves and transmitters to detect low tire inflation pressure before serious problems arise.

- The tire pressure detected by the tire pressure warning system can be displayed on the multi-information display.

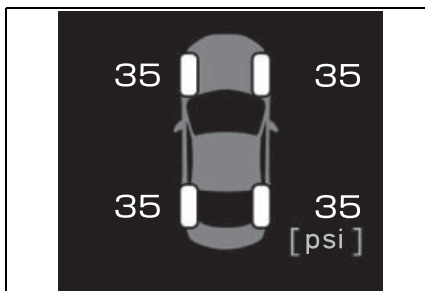

- If the tire pressure drops below a predetermined level, the driver is warned by a

screen display and a warning light. (→P.354)

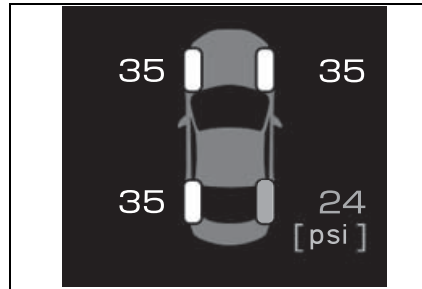

### Routine tire inflation pressure checks

The tire pressure warning system does not replace routine tire inflation pressure checks. Make sure to check tire inflation pressure as part of your routine of daily vehicle checks.

### Tire inflation pressure

- It may take a few minutes to display the tire inflation pressure after the engine switch is turned ON. It may also take a few minutes to display the tire inflation pressure after inflation pressure has been adjusted.
- Tire inflation pressure changes with temperature. The displayed values may also be different from the values measured using a tire pressure gauge.

### Situations in which the tire pressure warning system may not operate properly

- In the following cases, the tire pressure warning system may not operate properly.
  - If non-genuine Toyota wheels are used.
  - A tire has been replaced with a tire that is not an OE (Original Equipment) tire.
  - A tire has been replaced with a tire that is not of the specified size.
  - Tire chains, etc. are equipped.
  - An auxiliary-supported run-flat tire

is equipped.

- If a window tint that affects the radio wave signals is installed.
- If there is a lot of snow or ice on the vehicle, particularly around the wheels or wheel housings.
- If the tire inflation pressure is extremely higher than the specified level.
- If tires not equipped with tire pressure warning valves and transmitters are used.
- If the ID code on the tire pressure warning valves and transmitters is not registered in the tire pressure warning computer.
- Performance may be affected in the following situations.
  - When driving near a TV tower, electric power plant, gas station, radio station, large display, airport or other facility that generates strong radio waves or electrical noise
  - When carrying a portable radio, cellular phone, cordless phone or other wireless communication device

If tire position information is not correctly displayed due to the radio wave conditions, the display may be corrected by driving and changing the radio wave conditions.

- When the vehicle is parked, the time taken for the warning to start or go off could be extended.
- When tire inflation pressure declines rapidly for example when a tire has burst, the warning may not function.

■ **Warning performance of the tire pressure warning system**

The warning of the tire pressure warning system will change in accordance with driving conditions. For this reason, the system may give a warning even if the tire pressure does not reach a low enough level, or if the pressure is higher than the pressure that was adjusted to when the system was initialized.

**Installing tire pressure warning valves and transmitters**

When replacing tires or wheels, tire pressure warning valves and transmitters must also be installed.

When new tire pressure warning valves and transmitters are installed, new ID codes must be registered in the tire pressure warning computer and the tire pressure warning system must be initialized. Have tire pressure warning valve and transmitter ID codes registered by your Toyota dealer. (→P.318)

■ **Replacing tires and wheels**

If the ID code of the tire pressure warning valve and transmitter is not registered, the tire pressure warning system will not work properly. After driving for about 20 minutes, the tire pressure warning light blinks for 1 minute and stays on to indicate a system malfunction.

	<p><b>NOTICE</b></p> <p>■ <b>Repairing or replacing tires, wheels, tire pressure warning valves, transmitters and tire valve caps</b></p> <p>● When removing or fitting the wheels, tires or the tire pressure warning valves and transmitters, contact your Toyota dealer as the tire pressure warning valves and transmitters may be damaged if not handled correctly.</p>
---	--

 NOTICE

- Make sure to install the tire valve caps. If the tire valve caps are not installed, water could enter the tire pressure warning valves and the tire pressure warning valves could be bound.
- When replacing tire valve caps, do not use tire valve caps other than those specified. The cap may become stuck.

■ **To avoid damage to the tire pressure warning valves and transmitters**

When a tire is repaired with liquid sealants, the tire pressure warning valve and transmitter may not operate properly. If a liquid sealant is used, contact your Toyota dealer or other qualified service shop as soon as possible. After use of liquid sealant, make sure to replace the tire pressure warning valve and transmitter when repairing or replacing the tire. (→P.316)

### Initializing the tire pressure warning system

■ **The tire pressure warning system must be initialized in the following circumstances:**

- When rotating the tires.
- When the tire inflation pressure is changed such as when changing traveling speed.
- When changing the tire size.

When the tire pressure warning system is initialized, the current tire inflation pressure is set as the benchmark pressure.

■ **How to initialize the tire pressure warning system**

- 1 Park the vehicle in a safe place and turn the engine switch off.

Initialization cannot be performed while the vehicle is moving.

- 2 Adjust the tire inflation pressure to the specified cold tire inflation pressure level.

Make sure to adjust the tire pressure to the specified cold tire inflation pressure level. The tire pressure warning system will operate based on this pressure level.

- 3 Turn the engine switch to ON.
- 4 Press and hold the tire pressure warning reset switch until the tire pressure warning light blinks slowly 3 times.

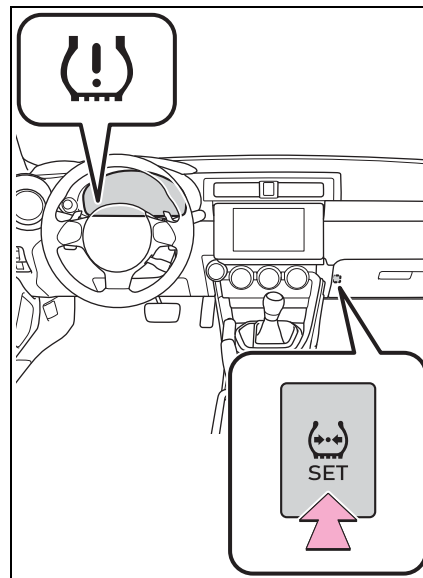

- 5 Wait for a few minutes with the engine switch ON and

then turn the engine switch off.

stays on after driving for 20 minutes.

■ **If you press the tire pressure warning reset switch accidentally**

If initialization is performed, adjust the tire inflation pressure to the specified level and initialize the tire pressure warning system again.

■ **Initialization procedure**

- Make sure to carry out initialization after adjusting the tire inflation pressure. Also, make sure the tires are cold before carrying out initialization or tire inflation pressure adjustment.
- If you have accidentally turned the engine switch off during initialization, it is not necessary to press the reset switch again as initialization will restart automatically when the engine switch has been turned to ON for the next time.
- If you accidentally press the reset switch when initialization is not necessary, adjust the tire inflation pressure to the specified level when the tires are cold, and conduct initialization again.

■ **When initialization of the tire pressure warning system has failed**

Initialization can be completed in a few minutes. However, in the following cases, the settings have not been recorded and the system will not operate properly. If repeated attempts to record tire inflation pressure settings are unsuccessful, have the vehicle inspected by your Toyota dealer.

- When operating the tire pressure warning reset switch, tire pressure warning light does not blink 3 times.
- After carrying out the initialization procedure, the tire pressure warning light blinks for 1 minute then

 **WARNING**

■ **When initializing the tire pressure warning system**

Do not operate the tire pressure warning reset switch without first adjusting the tire inflation pressure to the specified level. Otherwise, the tire pressure warning light may not come on even if the tire inflation pressure is low, or it may come on when the tire inflation pressure is actually normal.

**Registering ID codes**

The tire pressure warning valve and transmitter is equipped with a unique ID code. When replacing a tire pressure warning valve and transmitter, it is necessary to register the ID code. Have the ID code registered by your Toyota dealer.

■ **Registering ID codes**

The ID codes of the tire pressure warning valve and transmitters for two sets of wheels can be registered.

It is not necessary to register the ID codes when replacing normal tires with snow tires, if the ID codes for the wheels of both normal tires and snow tires are registered beforehand.

In addition to the set of tire pressure warning system sensor ID codes initially registered to the vehicle, a second set of ID codes can be registered.

A second set of tire pressure warning system sensor ID codes can be registered at your Toyota dealer.

When 2 sets of ID codes have been registered, either ID code set can be selected.

### Changing the ID code set

- 1 Park the vehicle in a safe place and turn the engine switch to ON.
- 2 Press the tire pressure warning reset switch 3 times within 3 seconds.
- 3 The tire pressure warning light will illuminate for 3 seconds and then blink 3 times.
- 4 The tire pressure warning light will blink for 1 minute and then illuminate.
- 5 When the ID code change has completed, the tire pressure warning light will turn off.

Check that tire pressures are displayed on the multi-information display.

### Replacing the tire

**When raising your vehicle with a jack, position the jack correctly.**

**Improper placement may damage your vehicle or cause injury.**

**If necessary tire replacement seems difficult to perform, contact your Toyota dealer.**

### Before jacking up the vehicle

- Stop the vehicle in a safe place on a hard, flat surface.
- Set the parking brake.
- Shift the shift lever to P (automatic transmission) or R (manual transmission).
- Stop the engine.

### ■ Jack and Jack handle

As your vehicle is equipped with an emergency tire puncture repair kit, a jack and jack handle for replacing a tire are not included with your vehicle. To purchase a jack and jack handle, contact your Toyota dealer.

- Jack
- Jack handle

**Location of the jack and tools**

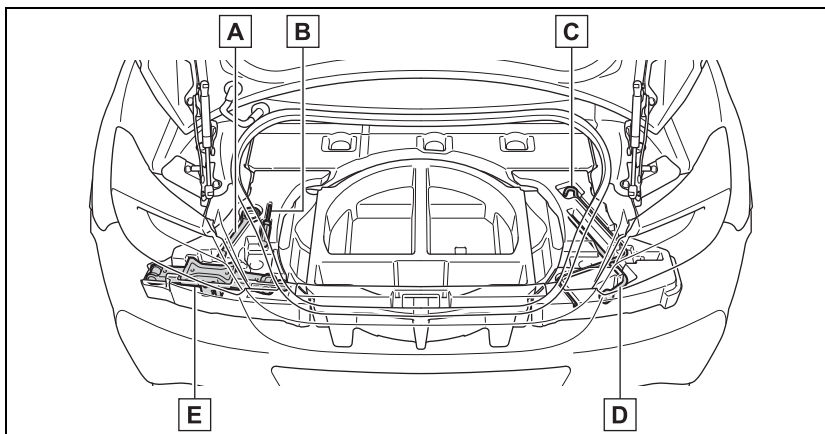

- A** Towing eyelet
- B** Screwdriver
- C** Jack handle (if equipped)
- D** Wheel nut wrench
- E** Jack (if equipped)

**⚠ WARNING**

**■ Using the tire jack**

Observe the following precautions. Improper use of the tire jack may cause the vehicle to suddenly fall off the jack, leading to death or serious injury.

- Do not use the tire jack for any purpose other than replacing tires or installing and removing tire chains.
- Do not use other tire jacks for replacing tires on this vehicle.
- Always check that the tire jack is securely set to the jack point.
- Do not put any part of your body under the vehicle while it is supported by the jack.

- Do not start the engine or drive the vehicle while the vehicle is supported by the jack.
- Do not raise the vehicle while someone is inside.
- When raising the vehicle, do not put an object on or under the jack.
- Do not raise the vehicle to a height greater than that required to replace the tire.
- Use a jack stand if it is necessary to get under the vehicle.
- When lowering the vehicle, make sure that there is no-one near the vehicle. If there are people nearby, warn them vocally before lowering.



**Removing a tire**

1 Check the tires.

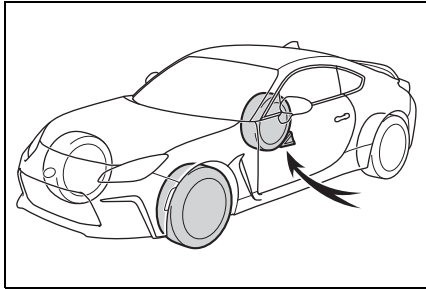

Flat tire	Wheel chock positions
Front left-hand side	Behind the rear right-hand side tire
Front right-hand side	Behind the rear left-hand side tire
Rear left-hand side	In front of the front right-hand side tire
Rear right-hand side	In front of the front left-hand side tire

2 Slightly loosen the wheel nuts (one turn).

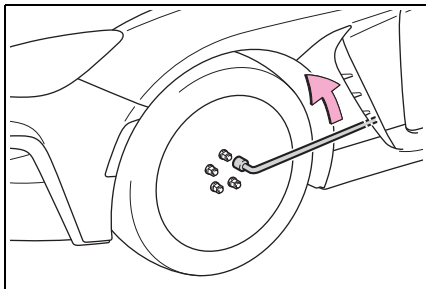

3 Turn the tire jack portion **A** by hand until the notch of the

jack is in contact with the jack point.

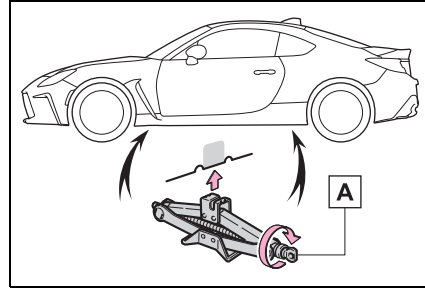

4 Raise the vehicle until the tire is slightly raised off the ground.

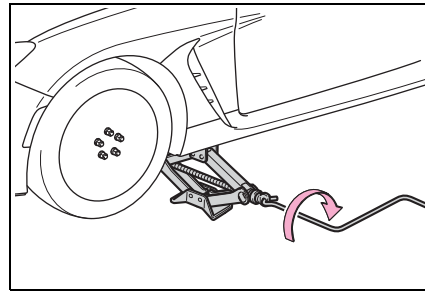

5 Remove all the wheel nuts and the tire.

When resting the tire on the ground, place the tire so that the wheel design faces up to avoid scratching the wheel surface.

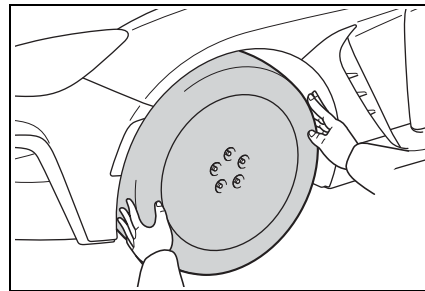

**⚠ WARNING**

■ **Replacing a flat tire**

Do not touch the disc wheels or the area around the brakes immediately after the vehicle has been driven.

After the vehicle has been driven the disc wheels and the area around the brakes will be extremely hot. Touching these areas with hands, feet or other body parts while changing a tire, etc. may result in burns.

**Installing the tire**

- 1 Remove any dirt or foreign matter from the wheel contact surface.

If foreign matter is on the wheel contact surface, the wheel nuts may loosen while the vehicle is in motion, causing the tire to come off.

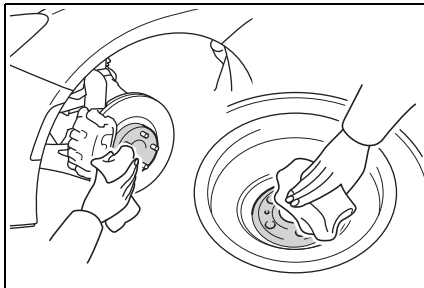

- 2 Install the tire and loosely tighten each wheel nut by hand by approximately the same amount.

Turn the wheel nuts until the washers come into contact with the disc

wheel.

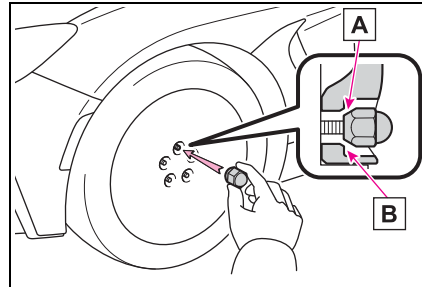

**A** Tapered portion

**B** Disc wheel

- 3 Lower the vehicle.

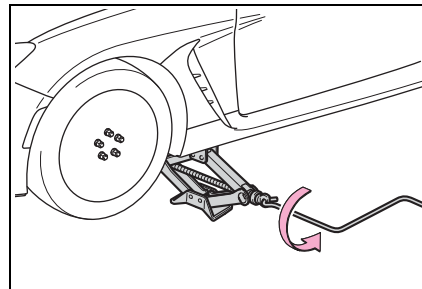

- 4 Firmly tighten each wheel nut two or three times in the order shown in the illustration.

Tightening torque:  
89 ft•lbf (120 N•m, 12.2 kgf•m)

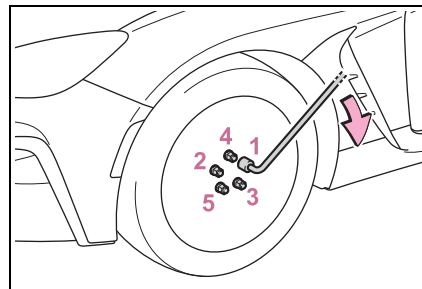

- 5 Stow the jack and all tools.

**⚠ WARNING****■ When installing the tire**

Failure to follow these precautions could cause the wheel nuts to loosen and the tire to fall off, resulting in death or serious injury.

- Never use oil or grease on the wheel bolts or wheel nuts.

Oil and grease may cause the wheel nuts to be excessively tightened, leading to bolt or disc wheel damage. In addition, the oil or grease can cause the wheel nuts to loosen and the wheel may fall off, causing a serious accident. Remove any oil or grease from the wheel bolts or wheel nuts.

- Have the wheel nuts tightened with a torque wrench to 89 ft•lbf (120 N•m, 12.2 kgf•m) as soon as possible after changing wheels.
- Do not attach a heavily damaged wheel ornament, as it may fly off the wheel while the vehicle is moving.
- When installing a tire, only use wheel nuts that have been specifically designed for that wheel.
- If there are any cracks or deformations in the bolt screws, nut threads or bolt holes of the wheel, have the vehicle inspected by your Toyota dealer.

**Tire inflation pressure****Checking the specified tire inflation pressure**

The recommended cold tire inflation pressure and tire size are displayed on the tire and loading information label. (→P.386)

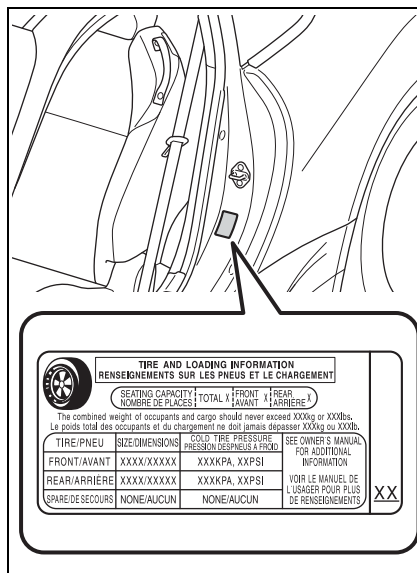
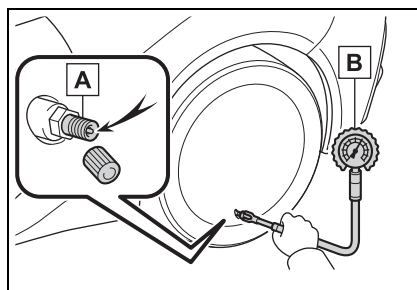
**Inspection and adjustment procedure****A** Tire valve

**B** Tire pressure gauge

- 1** Remove the tire valve cap.
- 2** Press the tip of the tire pressure gauge onto the tire valve.
- 3** Read the pressure using the gauge gradations.
- 4** If the tire inflation pressure is not at the recommended level, adjust the pressure. If you add too much air, press the center of the valve to deflate.
- 5** After completing the tire inflation pressure measurement and adjustment, apply soapy water to the valve and check for leakage.
- 6** Put the tire valve cap back on.

**■ Tire inflation pressure check interval**

You should check tire inflation pressure every two weeks, or at least once a month.

**■ Effects of incorrect tire inflation pressure**

Driving with incorrect tire inflation pressure may result in the following:

- Reduced fuel economy
- Reduced driving comfort and poor handling
- Reduced tire life due to wear
- Reduced safety
- Damage to the drivetrain

If a tire needs frequent inflating, have it checked by your Toyota dealer.

**■ Instructions for checking tire inflation pressure**

When checking tire inflation pressure, observe the following:

- Check only when the tires are cold. If your vehicle has been parked for at least 3 hours or has not been driven for more than 1 mile or 1.5 km, you will get an accurate cold tire inflation pressure reading.
- Always use a tire pressure gauge. It is difficult to judge if a tire is properly inflated based only on its appearance.
- It is normal for the tire inflation pressure to be higher after driving as heat is generated in the tire. Do not reduce tire inflation pressure after driving.
- Never exceed the vehicle capacity weight. Passengers and luggage weight should be placed so that the vehicle is balanced.

 **WARNING**

**■ Proper inflation is critical to save tire performance**

Keep your tires properly inflated. If the tires are not properly inflated, the following conditions may occur which could lead to an accident resulting in death or serious injury:

- Excessive wear
- Uneven wear
- Poor handling
- Possibility of blowouts resulting from overheated tires
- Air leaking from between tire and wheel
- Wheel deformation and/or tire damage

**⚠ WARNING**

- Greater possibility of tire damage while driving (due to road hazards, expansion joints, sharp edges in the road, etc.)

**⚠ NOTICE**

■ **When inspecting and adjusting tire inflation pressure**

Be sure to put the tire valve caps back on.  
If a valve cap is not installed, dirt or moisture may get into the valve and cause an air leak, resulting in decreased tire inflation pressure.

**Wheels**

**If a wheel is bent, cracked or heavily corroded, it should be replaced. Otherwise, the tire may separate from the wheel or cause a loss of handling control.**

**Wheel selection**

When replacing wheels, care should be taken to ensure that they are equivalent to those removed in load capacity, diameter, rim width and inset\*.

Replacement wheels are available at your Toyota dealer.

\*: Conventionally referred to as offset.

Toyota does not recommend using the following:

- Wheels of different sizes or types
- Used wheels
- Bent wheels that have been straightened

■ **When replacing wheels**

The wheels of your vehicle are equipped with tire pressure warning valves and transmitters that allow the tire pressure warning system to provide advance warning in the event of a loss in tire inflation pressure. Whenever wheels are replaced, tire pressure warning valves and transmitters must be installed. (→P.316)

 **WARNING****■ When replacing wheels**

- Do not use wheels that are a different size from those recommended in the Owner's Manual, as this may result in a loss of handling control.
- Never use an inner tube in a leaking wheel which is designed for a tubeless tire. Doing so may result in an accident, causing death or serious injury.

**■ When installing the wheel nuts**

Never use oil or grease on the wheel bolts or wheel nuts. Oil and grease may cause the wheel nuts to be excessively tightened, leading to bolt or disc wheel damage. In addition, the oil or grease can cause the wheel nuts to loosen and the wheel may fall off, causing an accident and resulting in death or serious injury. Remove any oil or grease from the wheel bolts or wheel nuts.

**■ Use of defective wheels prohibited**

Do not use cracked or deformed wheels. Doing so could cause the tire to leak air during driving, possibly causing an accident.

- Ensure that only genuine Toyota wheels are used on your vehicle. Tire pressure warning valves and transmitters may not work properly with non-genuine wheels.

**Aluminum wheel precautions**

- Use only Toyota wheel nuts and wrenches designed for use with your aluminum wheels.
- When rotating, repairing or changing your tires, check that the wheel nuts are still tight after driving 1000 miles (1600 km).
- Be careful not to damage the aluminum wheels when using tire chains.
- Use only Toyota genuine balance weights or equivalent and a plastic or rubber hammer when balancing your wheels.

 **NOTICE****■ Replacing tire pressure warning valves and transmitters**

- Because tire repair or replacement may affect the tire pressure warning valves and transmitters, make sure to have tires serviced by your Toyota dealer or other qualified service shop. In addition, make sure to purchase your tire pressure warning valves and transmitters at your Toyota dealer.

**Air conditioning filter**

**The air conditioning filter must be changed regularly to maintain air conditioning efficiency.**

**Removing the air conditioning filter**

- 1 Turn the engine switch off.
- 2 Open the glove box. Slide off the damper.

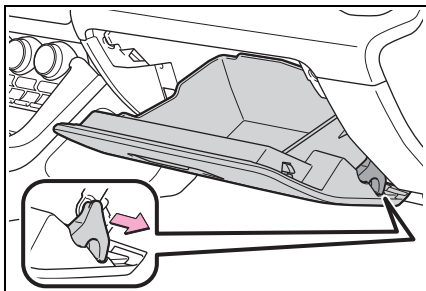

- 3 Push in each side of the glove box and pull the glove box toward you to disconnect the claws.

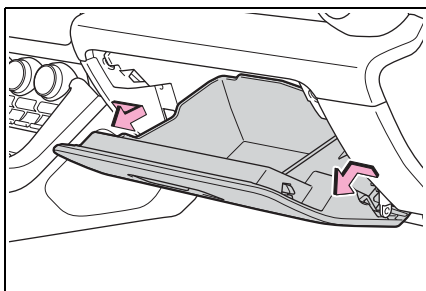

- 4 Lower the glove box slowly until surface (A) is horizontal with the floor, then pull it out. (Simply pulling with gentle

force will disengage the lower claws.)

Do not forcibly pull the glove box. Otherwise, the lower claws (B) or the lower claw engagement points (C) may be deformed, making it difficult to reinstall or close the glove box.

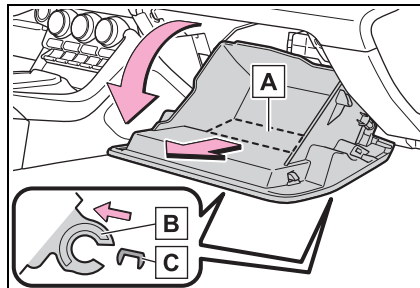

- 5 Remove the filter cover.

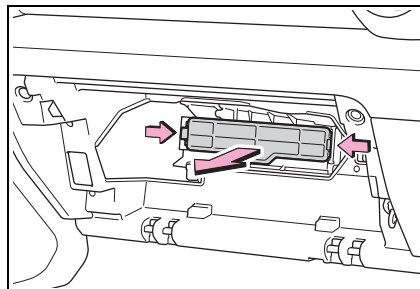

- 6 Remove the air conditioning filter and replace it with a new one.

The “↑ UP” marks shown on the filter and the filter case should be pointing up.

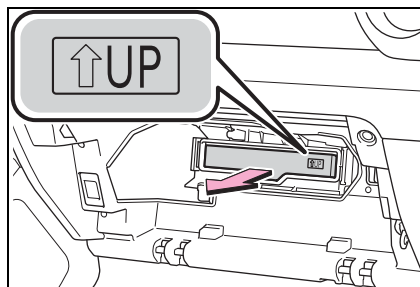

- 7 When installing, reverse the steps listed.

■ **Checking interval**

Inspect and replace the air conditioning filter according to the maintenance schedule. In dusty areas or areas with heavy traffic flow, early replacement may be required. (For scheduled maintenance information, please refer to the “Owner’s Manual Supplement” or “Scheduled Maintenance”.)

■ **If air flow from the vents decreases dramatically**

The filter may be clogged. Check the filter and replace if necessary.



**NOTICE**

■ **When removing the glove box**

Do not forcibly pull the glove box. Otherwise, the lower claws or the lower claw engagement points may be deformed, making it difficult to reinstall or close the glove box.

■ **When using the air conditioning system**

Make sure that a filter is always installed. Using the air conditioning system without a filter may cause damage to the system.

**Electronic key battery**

**Replace the battery with a new one if it is depleted. As the key may be damaged if the following procedure is not performed properly, it is recommended that key battery replacement be performed by your Toyota dealer.**

■ **If the electronic key battery is depleted**

The following symptoms may occur:

- The smart key system and wireless remote control will not function properly.
- The operational range will be reduced.

**Items to prepare**

- Flathead screwdriver
- Lithium battery CR2032

■ **Use a CR2032 lithium battery**

- Batteries can be purchased at your Toyota dealer, local electrical appliance shops or camera stores.
- Replace only with the same or equivalent type recommended by the manufacturer.
- Dispose of used batteries according to local laws.



**Replacing the battery**

**1** Take out the mechanical key.

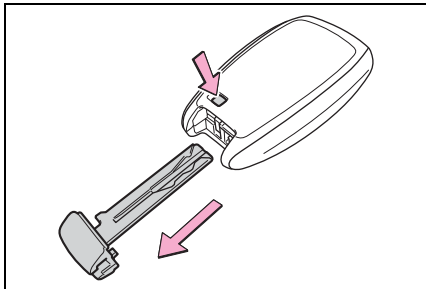

**2** Insert the tip of a flathead screwdriver into the groove (A) and remove the cover.

To prevent damage to the key, cover the tip of the flathead screwdriver with a rag.

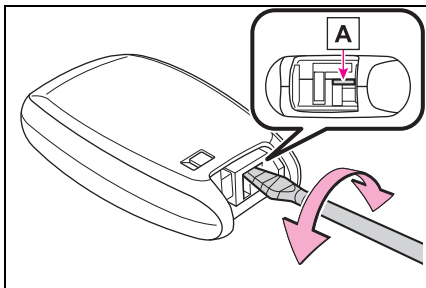

**3** Remove the depleted battery.

To prevent damage to the key, cover the tip of the flathead screwdriver with a rag.

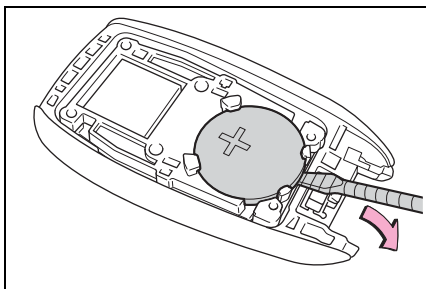

**4** Install a new battery with the “+” terminal facing up, as shown in the illustration.

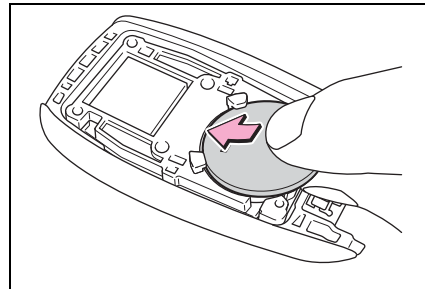

**5** Align the protruding part with the slot and install the cover.

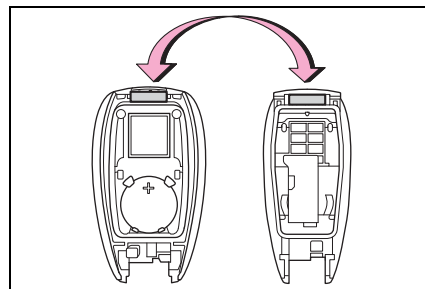

**⚠ WARNING**

**■ Battery precautions**

Observe the following precautions. Failure to do so may result in death or serious injury.

- Do not swallow the battery. Doing so may cause chemical burns.
- A coin battery or button battery is used in the electronic key. If a battery is swallowed, it may cause severe chemical burns in as little as 2 hours and may result in death or serious injury.
- Keep away new and removed batteries from children.

**⚠ WARNING**

- If the cover cannot be firmly closed, stop using the electronic key and stow the key in the place where children cannot reach, and then contact your Toyota dealer.
- If you accidentally swallow a battery or put a battery into a part of your body, get emergency medical attention immediately.
- **To prevent battery explosion or leakage of flammable liquid or gas**
- Replace the battery with a new battery of the same type. If a wrong type of battery is used, it may explode.
- Do not expose batteries to extremely low pressure due to high altitude or extremely high temperatures.
- Do not burn, break or cut a battery.

**⚠ NOTICE**

- **For normal operation after replacing the battery**
- Observe the following precautions to prevent accidents:
- Always work with dry hands. Moisture may cause the battery to rust.
- Do not touch or move any other component inside the remote control.
- Do not bend either of the battery terminals.

**Checking and replacing fuses**

**If any of the electrical components do not operate, a fuse may have blown. If this happens, check and replace the fuses as necessary.**

**Checking and replacing fuses**

- 1 Turn the engine switch off.
- 2 Open the fuse box cover.
  - ▶ Engine compartment

Push the tab in and lift the lid off.

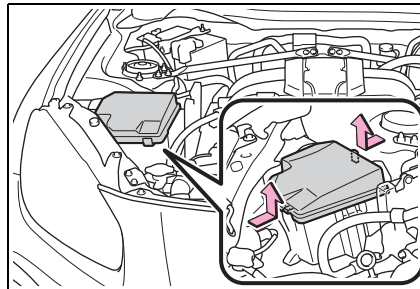

- ▶ Instrument panel
- Remove the lid.

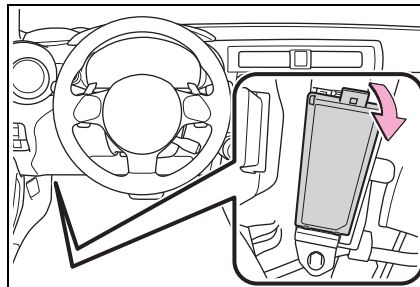

- 3 Remove the fuse with the pullout tool.

Only type A fuses can be removed

using the pullout tool.

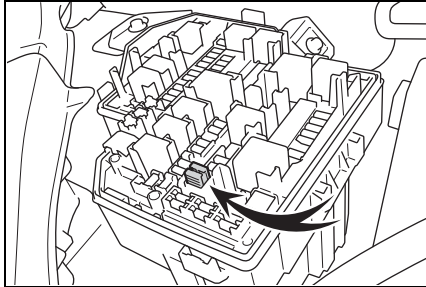

4 Check if the fuse is blown.

Type A and B:

Replace the blown fuse with a new fuse of an appropriate amperage rating. The amperage rating can be found on the fuse box lid.

Type C:

Contact your Toyota dealer.

► Type A

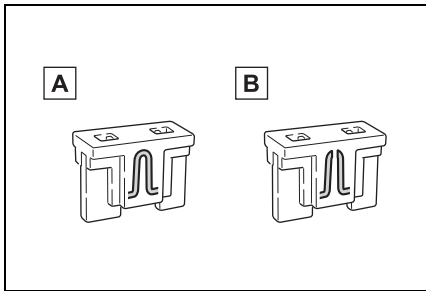

A Normal fuse

B Blown fuse

► Type B

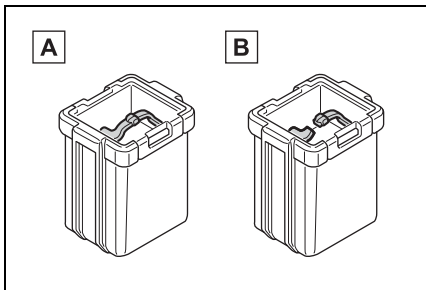

A Normal fuse

B Blown fuse

► Type C

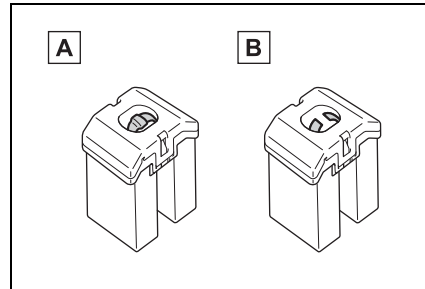

A Normal fuse

B Blown fuse

■ After a fuse is replaced

- If the lights do not turn on even after the fuse has been replaced, a bulb may need replacement.
- If the replaced fuse blows again, have the vehicle inspected by your Toyota dealer.

■ If there is an overload in a circuit

The fuses are designed to blow, protecting the wiring harness from damage.

■ When replacing light bulbs

Toyota recommends that you use genuine Toyota products designed for this vehicle.

Because certain bulbs are connected to circuits designed to prevent overload, non-genuine parts or parts not designed for this vehicle may be unusable.

**⚠ WARNING**

■ **To prevent system breakdowns and vehicle fire**

Observe the following precautions.  
Failure to do so may cause damage to the vehicle, and possibly a fire or injury.

- Never use a fuse of a higher amperage rating than that indicated, or use any other object in place of a fuse.
- Always use a genuine Toyota fuse or equivalent. Never replace a fuse with a wire, even as a temporary fix.
- Do not modify the fuses or fuse boxes.

**⚠ NOTICE**

■ **Before replacing fuses**

Have the cause of electrical overload determined and repaired by your Toyota dealer as soon as possible.

**Headlight aim**

**Vertical movement adjusting bolts**

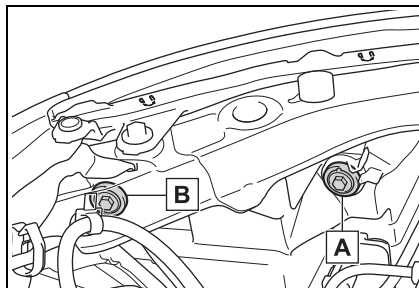

- A** Adjustment bolt A
- B** Adjustment bolt B

**Before checking the headlight aim**

- Make sure the vehicle has a full tank of gasoline and the area around the headlight is not deformed.
- Park the vehicle on level ground.
- Make sure the tire inflation pressure is at the specified level.
- Have someone sit in the driver's seat.
- Bounce the vehicle several times.

### Adjusting the headlight aim

- 1 Using a Phillips-head screwdriver, turn bolt A in either direction.

Remember the turning direction and the number of turns.

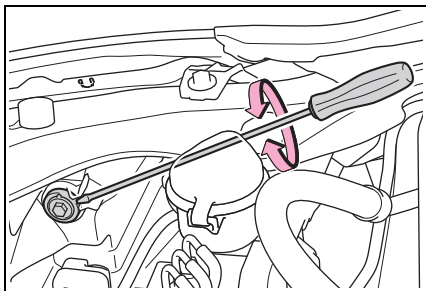

- 2 Turn bolt B the same number of turns and in the same direction as step 1.

If the headlight cannot be adjusted using this procedure, take the vehicle to your Toyota dealer to adjust the headlight aim.

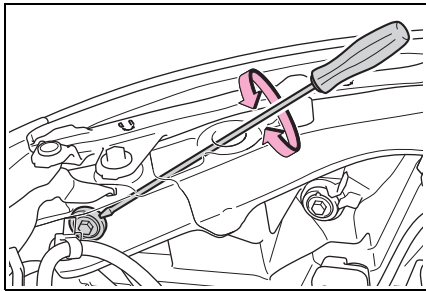

### Light bulbs

You may replace the following bulbs by yourself. The difficulty level of replacement varies depending on the bulb. If necessary bulb replacement seems difficult to perform, contact your Toyota dealer.

### Preparing for light bulb replacement

Check the wattage of the light bulb to be replaced. (→P.387)

### Bulb locations

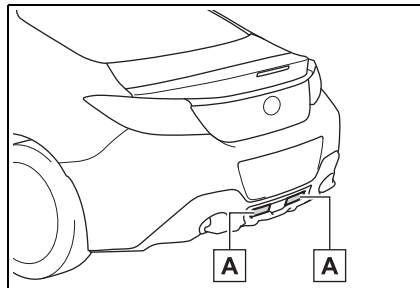

**A** Back-up light

### ■ Bulbs that need to be replaced by your Toyota dealer

- Headlights
- Parking lights/daytime running lights
- Front turn signal lights
- Side marker lights
- Stop/tail lights

- Rear turn signal lights
- High mounted stoplight
- License plate lights
- Door courtesy lights (if equipped)

■ **LED light bulbs**

The lights other than the back-up light each consist of a number of LEDs. If any of the LEDs burn out, take your vehicle to your Toyota dealer to have the light replaced.

■ **Condensation build-up on the inside of the lens**

Temporary condensation build-up on the inside of the headlight lens does not indicate a malfunction. Contact your Toyota dealer for more information in the following situations:

- Large drops of water have built up on the inside of the lens.
- Water has built up inside the headlight.

■ **When replacing light bulbs**

→P.331

**Replacing light bulbs**

■ **Back-up light**

- 1 Remove the clips.

To prevent damage to the vehicle, cover the tip of the screwdriver with a rag.

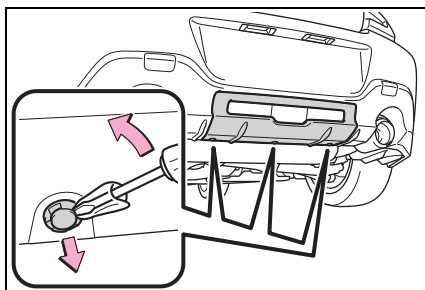

- 2 Pull the cover to disengage each claw and remove it.

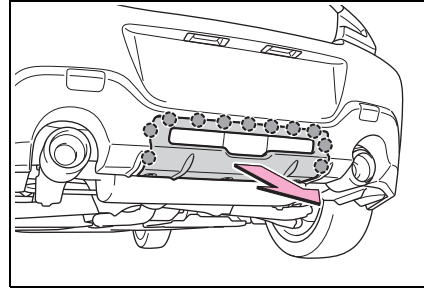

- 3 Turn the bulb base counter-clockwise.

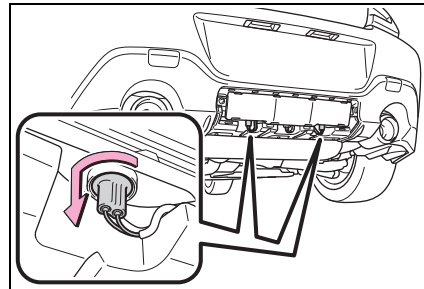

- 4 Remove the light bulb.

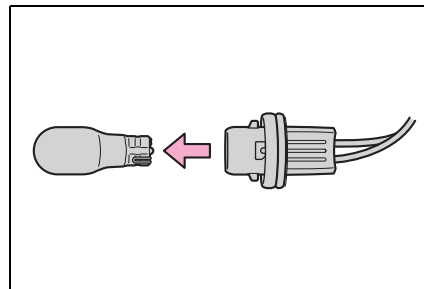

- 5 Install a new light bulb then install the bulb base to the light unit by inserting it and

turning the bulb base clockwise.

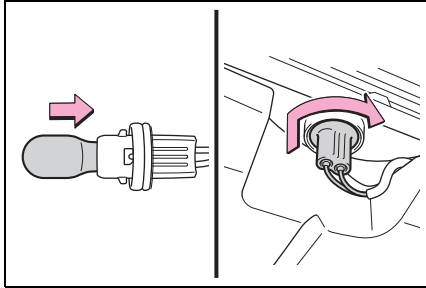

**6** Install the cover.

Align the cover with the claws on the vehicle and push the cover toward the front of the vehicle to engage each claw and install it.

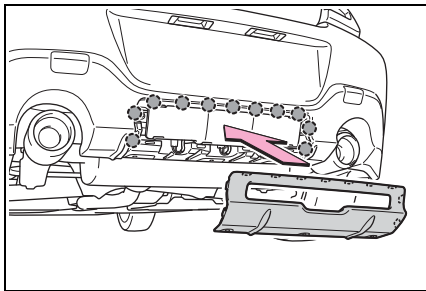

**7** Install the clips.

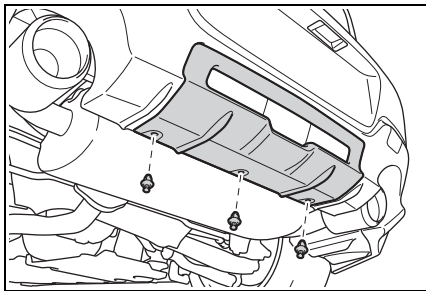

**! WARNING**

**■ Replacing light bulbs**

- Turn off the lights. Do not attempt to replace the bulb immediately after turning off the lights. The bulbs become very hot and may cause burns.
- Do not touch the glass portion of the light bulb with bare hands. When it is unavoidable to hold the glass portion, use and hold with a clean dry cloth to avoid getting moisture and oils on the bulb. Also, if the bulb is scratched or dropped, it may blow out or crack.
- Fully install light bulbs and any parts used to secure them. Failure to do so may result in heat damage, fire, or water entering the light unit. This may damage the lights or cause condensation to build up on the lens.

**■ When changing the back-up lights**

- Stop the engine and wait until the exhaust pipes and surrounding parts have cooled down sufficiently. The lights are located near the exhaust pipe and touching a hot exhaust pipe and surrounding parts can cause burns.

**■ To prevent damage or fire**

- Make sure bulbs are fully seated and locked.
- Check the wattage of the bulb before installing to prevent heat damage.





**When trouble arises****7****7-1. Essential information**

Emergency flashers .... 338

If your vehicle has to be  
stopped in an emergency  
..... 338If the vehicle is submerged  
or water on the road is ris-  
ing ..... 339**7-2. Steps to take in an emer-  
gency**If your vehicle needs to be  
towed..... 341If you think something is  
wrong ..... 346Fuel pump shut off system  
..... 347If a warning light turns on or  
a warning buzzer sounds  
..... 348If a warning message is dis-  
played..... 357

If you have a flat tire.... 358

If the engine will not start  
..... 367

If you lose your keys ... 369

If the fuel filler door cannot  
be opened ..... 369If the electronic key does  
not operate properly.. 370If the vehicle battery is dis-  
charged ..... 372If your vehicle overheats  
..... 375If the vehicle becomes stuck  
..... 377

### Emergency flashers

The emergency flashers are used to warn other drivers when the vehicle has to be stopped on the road due to a breakdown, etc.

### Operating instructions

Press the switch.

All the turn signal lights will flash.

To turn them off, press the switch once again.

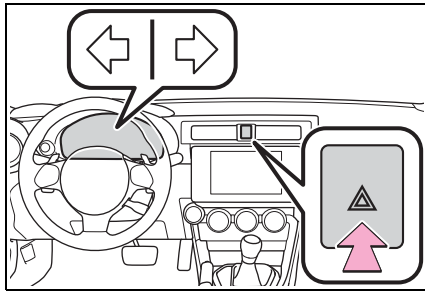

### ■ Emergency flashers

If the emergency flashers are used for a long time while the engine is not operating, the battery may discharge.

### If your vehicle has to be stopped in an emergency

Only in an emergency, such as if it becomes impossible to stop the vehicle in the normal way, stop the vehicle using the following procedure:

### Stopping the vehicle

- 1 Steadily step on the brake pedal with both feet and firmly depress it.

Do not pump the brake pedal repeatedly as this will increase the effort required to slow the vehicle.

- 2 Shift the shift lever to N.
  - ▶ If the shift lever is shifted to N
- 3 After slowing down, stop the vehicle in a safe place by the road.
- 4 Stop the engine.
  - ▶ If the shift lever cannot be shifted to N
- 3 Keep depressing the brake pedal with both feet to reduce vehicle speed as much as possible.
- 4 To stop the engine, press and hold the engine switch for 2 consecutive seconds or

more, or press it briefly 3 times or more in succession.

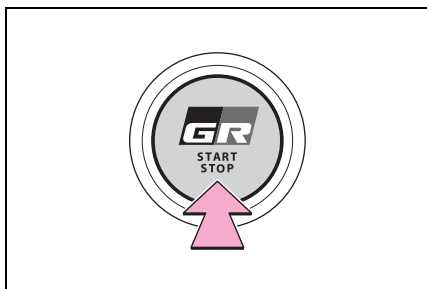

- 5 Stop the vehicle in a safe place by the road.

**⚠ WARNING**

■ **If the engine has to be turned off while driving**

Power assist for the brakes and steering wheel will be lost, making the brake pedal harder to depress and the steering wheel heavier to turn. Decelerate as much as possible before turning off the engine.

**If the vehicle is submerged or water on the road is rising**

This vehicle is not designed to be able to drive on roads that are deeply flooded with water. Do not drive on roads where the roads may be submerged or the water may be rising. It is dangerous to remain in the vehicle, if it anticipated that the vehicle will be flooded or set a drift. Remain calm and follow the following.

- If the door can be opened, open the door and exit the vehicle.
- If the door cannot be opened, open the window using the power window switch and ensure an escape route.
- If the window can be opened, exit the vehicle through the window.
- If the door and window cannot be opened due to the rising water, remain calm, wait until the water level inside the vehicle rises to the point that the water pressure inside of the vehicle equals the water pressure outside of the vehicle and then open the door after waiting for the rising water to enter the vehicle, and exit the vehicle. When the

## 340 7-1. Essential information

---

outside water level exceeds half the height of the door, the door cannot be opened from the inside due to water pressure.

### ■ Water level exceeds the floor

When the water level exceeds the floor and time has passed, the electrical equipment will get damaged, the power windows will not operate, the engine stop, and the vehicle may not be able to get moving.

### ■ Using an emergency escape hammer\*

Laminated glass is used in the windshield on this vehicle.  
Laminated glass cannot be shattered with an emergency hammer\*.  
Tempered glass is used in the windows on this vehicle.

\*: Contact your Toyota dealer or aftermarket accessory manufacturer for further information about an emergency hammer.



### WARNING

#### ■ Caution while driving

Do not drive on roads where the roads may be submerged or the water may be rising. Otherwise the vehicle may be damaged and cannot move, as well as become flooded and set a drift, which may lead to death.

**If your vehicle needs to be towed**

If towing is necessary, we recommend having your vehicle towed by your Toyota dealer or commercial towing service, using a wheel-lift type truck or flatbed truck.

Use a safety chain system for all towing, and abide by all state/provincial and local laws.

If towing your vehicle with a wheel-lift type truck from the front, the vehicle's rear wheels and axles must be in good conditions. (→P.342)

If they are damaged, use a towing dolly or flatbed truck.

**⚠ WARNING**

Observe the following precautions. Failure to do so may result in death or serious injury.

**■ When towing the vehicle**

Be sure to transport the vehicle with all four wheels raised off the ground. If the vehicle is towed with the tires contacting the ground, the drivetrain and related parts may be damaged or an accident may occur due to a change in direction of the vehicle.

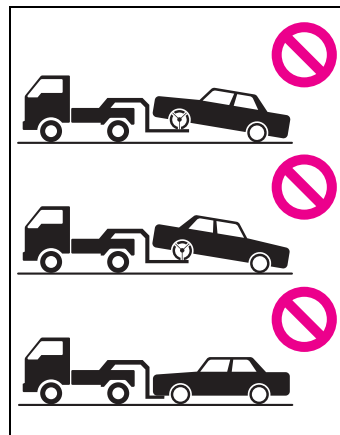
**■ While towing**

- When towing using cables or chains, avoid sudden starts, etc. which place excessive stress on the towing eyelets, cables or chains. The towing eyelets, cables or chains may become damaged, broken debris may hit people, and cause serious damage.

- Do not turn the engine switch off. There is a possibility that the steering wheel is locked and cannot be operated.

**■ Installing towing eyelets to the vehicle**

Make sure that towing eyelets are installed securely. If not securely installed, towing eyelets may come loose during towing.

**⚠ WARNING**

■ **After towing**

Make sure to remove the towing eyelet. If not removed, the SRS airbags may not deploy correctly if the vehicle is involved in a frontal collision, or the fuel pump shutoff system may not operate correctly if involved in a rear collision.

**⚠ NOTICE**

■ **To prevent damage to the vehicle when towing using a wheel-lift type truck**

● Do not tow the vehicle from the rear when the engine switch is off. The steering lock mechanism is not strong enough to hold the front wheels straight.

● When raising the vehicle, ensure adequate ground clearance for towing at the opposite end of the raised vehicle. Without adequate clearance, the vehicle could be damaged while being towed.

■ **To prevent damage to the vehicle when towing with a sling-type truck**

Do not tow with a sling-type truck, either from the front or rear.

■ **To prevent damage to the vehicle during emergency towing**

Do not secure cables or chains to the suspension components.

■ **When towing down a long slope**

Use a wheel lift-type or flat bed truck. If a wheel lift-type or flat bed truck is not used, the brakes may overheat, leading to poor brake performance.

**Situations when it is necessary to contact dealers before towing**

The following may indicate a problem with your transmission. Contact your Toyota dealer or commercial towing service before towing.

- The engine is running but the vehicle does not move.
- The vehicle makes an abnormal sound.

**Towing with a wheel-lift type truck**

► From the front

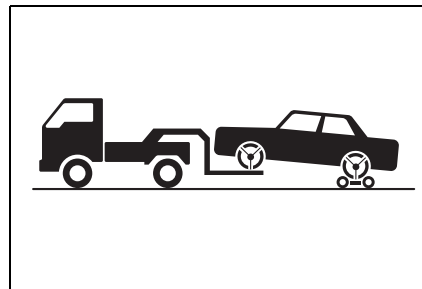

Use a towing dolly under the rear wheels.

► From the rear

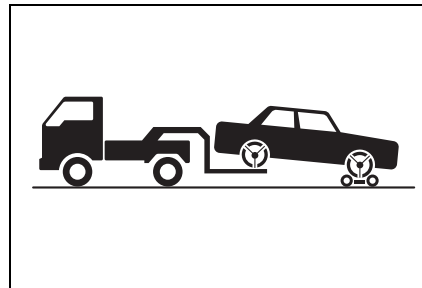

Use a towing dolly under the front wheels.

 **NOTICE**

■ **Towing with a sling-type truck**  
Do not tow with a sling-type truck to prevent body damage.

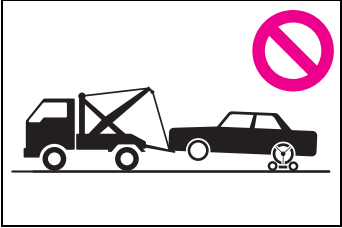

### Using a flatbed truck

When using a flat-bed truck to transport the vehicle, use tire strapping belts. Refer to the owner's manual of the flat-bed truck for the tire strapping method.

In order to suppress vehicle movement during transportation, set the parking brake and turn the engine switch off.

### Emergency towing

If a tow truck is not available in an emergency, your vehicle may be temporarily towed using cables or chains secured to the emergency towing eyelets. This should only be attempted on hard surfaced roads for at most 19 miles (30 km) at under 18 mph (30 km/h).

A driver must be in the vehicle to

steer and operate the brakes. The vehicle's wheels, drive train, axles, steering and brakes must be in good condition.

For vehicles with an automatic transmission, only the front towing eyelets may be used.

### Emergency towing procedure

To have your vehicle towed by another vehicle, the towing eyelet must be installed to your vehicle. Install the towing eyelet using the following procedure.

- 1 Take out the wheel nut wrench, flathead screwdriver and towing eyelet. (→P.359)
- 2 Remove the eyelet cover using a flathead screwdriver.

To protect the bodywork, place a rag between the screwdriver and the vehicle body as shown in the

illustration.

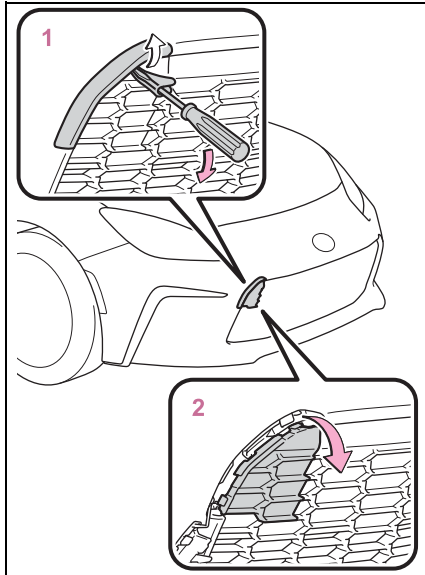

- 3 Remove the upper cover from the bumper.

When removing the cover, pull it toward the center of the vehicle to remove it.

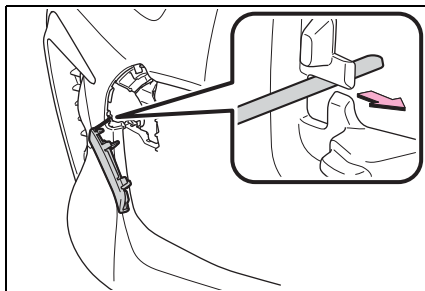

- 4 Remove the lower cover from the bumper.

When removing the cover, pull it upward and then outward to

remove it.

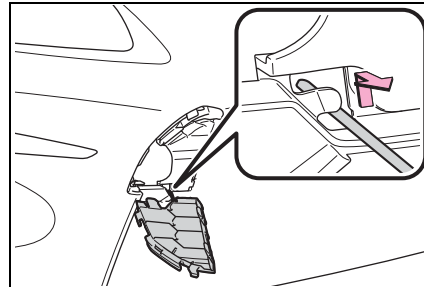

- 5 Insert the towing eyelet into the hole and tighten partially by hand.

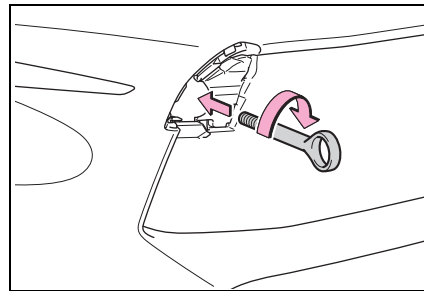

- 6 Tighten down the towing eyelet securely using a wheel nut wrench or hard metal bar.

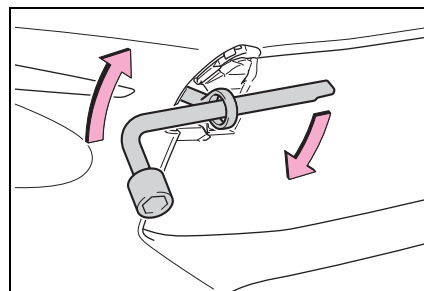

- 7 Securely attach cables or chains to the towing eyelet.

Take care not to damage the vehicle body.

- 8 Enter the vehicle being towed and start the engine.

If the engine does not start, turn the



engine switch to ON.

- 9 Shift the shift lever to N and release the parking brake.

Vehicles with an automatic transmission: When the shift lever cannot be shifted: →P.150

**■ Towing eyelet purpose**

The towing eyelet is to be used to tow your vehicle, not to tow other vehicles.

**■ While towing**

If the engine is not running, the power assist for the brakes and steering will not function, making steering and braking more difficult.

**■ Wheel nut wrench**

Wheel nut wrench is installed in trunk. (→P.359)

**■ Rear towing eyelet**

If the towing eyelet is installed to the rear, it can be used in an emergency to tow a vehicle lighter than your vehicle on a normal road, using a rope.

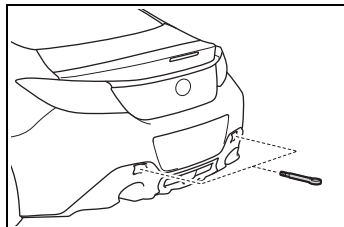

**■ When towing another vehicle**

For vehicles with BSD/RCTA, make sure to turn BSD/RCTA off. As the radar waves will be blocked by the towed vehicle, this system will not operate properly.

**■ When installing a towing eyelet to the rear**

When installing a towing eyelet to the rear, install it using the following procedure.

- 1 Take out the wheel nut wrench, flathead screwdriver and towing eyelet. (→P.359)
- 2 Remove the eyelet cover using a flathead screwdriver.

To protect the bodywork, place a rag between the screwdriver and the vehicle body as shown in the illustration.

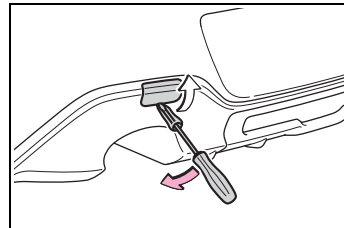

- 3 Remove the cover from the bumper.

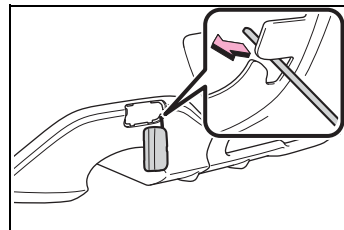

- 4 Insert the towing eyelet into the hole and tighten partially by hand.
- 5 Tighten down the towing eyelet securely using a wheel nut wrench or hard metal bar.

**If you think something is wrong**

**If you notice any of the following symptoms, your vehicle probably needs adjustment or repair. Contact your Toyota dealer as soon as possible.**

**Visible symptoms**

- Fluid leaks under the vehicle. (Water dripping from the air conditioning after use is normal.)
- Flat-looking tires or uneven tire wear
- Engine coolant temperature gauge continually points higher than normal.

**Audible symptoms**

- Changes in exhaust sound
- Excessive tire squeal when cornering
- Strange noises related to the suspension system
- Pinging or other noises related to the engine

**Operational symptoms**

- Engine missing, stumbling or running roughly
- Appreciable loss of power
- Vehicle pulls heavily to one

side when braking

- Vehicle pulls heavily to one side when driving on a level road
- Loss of brake effectiveness, spongy feeling, pedal almost touches the floor

**Fuel pump shut off system**

**When the vehicle sustains an impact in an accident, etc., the fuel pump shut off system operates to stop supplying fuel in order to minimize fuel leakage.**

**Restarting the engine**

Follow the procedure below to restart the engine after the system is activated.

- 1 Turn the engine switch to ACC or OFF.
- 2 Restart the engine.

**NOTICE****■ Before starting the engine**



Inspect the ground under the vehicle.  
If you find that fuel has leaked onto the ground, the fuel system has been damaged and is in need of repair. Do not restart the engine.

## If a warning light turns on or a warning buzzer sounds

**Calmly perform the following actions if any of the warning lights comes on or flashes. If a light comes on or flashes, but then goes off, this does not necessarily indicate a malfunction in the system. However, if this continues to occur, have the vehicle inspected by your Toyota dealer.**

### Actions to the warning lights or warning buzzers

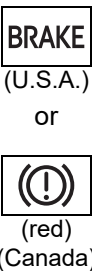
#### ■ Brake system warning light (warning buzzer)

Warning light	Details/Actions
 <p><b>BRAKE</b> (U.S.A.) or  (red) (Canada)</p>	<p>Indicates that:</p> <ul style="list-style-type: none"> <li>● The brake fluid level is low;</li> <li>● The vacuum pressure system is malfunctioning; or</li> <li>● The brake system is malfunctioning</li> </ul> <p>This light also comes on when the parking brake is not released. If the light turns off after the parking brake is fully released the system is operating normally.</p> <p>→ <b>Immediately stop the vehicle in a safe place and contact your Toyota dealer. Continuing to drive the vehicle may be dangerous.</b></p>

#### ■ High coolant temperature warning light (warning buzzer)

Warning light	Details/Actions
	<p>Indicates that the engine coolant temperature is too high</p> <p>→ <b>Immediately stop the vehicle in a safe place.</b> <b>Handling method (→P.375)</b></p>



#### ■ Charging system warning light

Warning light	Details/Actions
	<p>Indicates a malfunction in the vehicle's charging system</p> <p>→ <b>Immediately stop the vehicle in a safe place and contact your Toyota dealer.</b></p>

■ **Low engine oil pressure warning light**

Warning light	Details/Actions
	Indicates that the engine oil pressure is too low → <b>Immediately stop the vehicle in a safe place and contact your Toyota dealer.</b>



■ **Malfunction indicator lamp**

Warning light	Details/Actions
 (U.S.A.) or  (Canada)	Indicates a malfunction in: <ul style="list-style-type: none"> <li>● The electronic engine control system;</li> <li>● The electronic throttle control system; or</li> <li>● The electronic automatic transmission control system (if equipped)</li> </ul> → <b>Have the vehicle inspected by your Toyota dealer immediately.</b>

■ **SRS warning light (warning buzzer)**

Warning light	Details/Actions
	Indicates a malfunction in: <ul style="list-style-type: none"> <li>● The SRS airbag system; or</li> <li>● The seat belt pretensioner system</li> </ul> → <b>P.54</b>

■ **ABS warning light (warning buzzer)**

Warning light	Details/Actions
 (U.S.A.) or  (Canada)	Indicates a malfunction in: <ul style="list-style-type: none"> <li>● The ABS; or</li> <li>● The brake assist system</li> </ul> → <b>Have the vehicle inspected by your Toyota dealer immediately.</b>

■ **Electric power steering system warning light (warning buzzer)**

Warning light	Details/Actions
	<p>Indicates a malfunction in the EPS (Electric Power Steering) system</p> <p>→ <b>Have the vehicle inspected by your Toyota dealer immediately.</b></p>

■ **Slip indicator (warning buzzer)**

Warning light	Details/Actions
	<p>When illuminated, indicates:</p> <ul style="list-style-type: none"> <li>● Malfunction of the VSC (Vehicle Stability Control) system;</li> <li>● Malfunction of the TRAC (Traction Control) system; or</li> <li>● Malfunction of the hill-start assist control system</li> </ul> <p>Depending on the situation, the light may illuminate even when there is no malfunction. It does not indicate a malfunction if the light turns off after a short time.</p> <p>→ <b>Have the vehicle inspected by your Toyota dealer immediately.</b></p> <p>When flashing, indicates:</p> <p>→ <b>Indicates that the TRAC, VSC or brake LSD function is operating. Always drive safely. Driving recklessly may lead to an accident. Drive with extra care when the indicator is flashing.</b></p>

■ **Automatic transmission fluid temperature warning light (warning buzzer) (if equipped)**

Warning light	Details/Actions
	<p>Indicates that the automatic transmission fluid temperature is too high</p> <p>→ <b>Stop the vehicle in a safe place and shift the shift lever to P. If the light goes off after a little while, the vehicle can be driven. If the light does not go off, contact your Toyota dealer.</b></p>

### ■ Open door warning light

Warning light	Details/Actions
	Indicates that a door or the trunk is not fully closed → <b>Check that both side doors and the trunk are closed.</b>

### ■ Low fuel level warning light (warning buzzer)

Warning light	Details/Actions
	Indicates that remaining fuel is approximately 1.8 gal. (7.0 L, 1.5 Imp. gal.) or less → <b>Refuel the vehicle.</b>

### ■ Driver's and front passenger's seat belt reminder light (warning buzzer)<sup>\*1, 2</sup>

Warning light	Details/Actions
	Warns the driver and/or front passenger to fasten their seat belts → <b>Fasten the seat belt.</b> <b>If the front passenger's seat is occupied, the front passenger's seat belt also needs to be fastened to make the warning light (warning buzzer) turn off.</b>

<sup>\*1</sup>: The front passenger's seat belt reminder light is located on the overhead console.

<sup>\*2</sup>: Driver's seat belt warning buzzer:

The driver's seat belt warning buzzer sounds to alert the driver that his or her seat belt is not fastened. Once the engine switch is turned to ON, the buzzer sounds. If the seat belt is still unfastened, the buzzer sounds intermittently for a certain period of time after the vehicle reaches a certain speed.

Front passenger's seat belt warning buzzer:

The front passenger's seat belt warning buzzer sounds to alert the front passenger that his or her seat belt is not fastened. If the seat belt is unfastened, the buzzer sounds intermittently for a certain period of time after the vehicle reaches a certain speed.

■ **Rear passengers' seat belt reminder lights (warning buzzer)**<sup>\*1, 2</sup>

Warning light	Details/Actions
	Warns the rear passengers to fasten their seat belts → <b>Fasten the seat belt.</b> <b>If the rear passenger's seat is occupied, the rear passenger's seat belt also needs to be fastened to make the warning light (warning buzzer) turn off.</b>

\*1: This light illuminates on the overhead console.

\*2: Rear passengers' seat belt warning buzzer:

The rear passengers' seat belt warning buzzer sounds to alert the rear passenger that his or her seat belt is not fastened. If the seat belt is unfastened, the buzzer sounds intermittently for a certain period of time, after the vehicle reaches a certain speed.

■ **Conventional cruise control indicator (if equipped)**

Warning light	Details/Actions
 (yellow)	Indicates a malfunction in the conventional cruise control system → <b>Have the vehicle inspected by your Toyota dealer immediately.</b>

■ **BSD/RCTA warning light (if equipped) (warning buzzer)**

Warning light	Details/Actions
	Indicates a malfunction in the BSD/RCTA system → <b>Have the vehicle inspected by your Toyota dealer immediately.</b>

■ **SRH warning light (if equipped) (warning buzzer)**

Warning light	Details/Actions
	Indicates a malfunction in the SRH function → <b>Have the vehicle inspected by your Toyota dealer immediately.</b>



■ **RAB warning light (if equipped) (warning buzzer)**

Warning light	Details/Actions
	Indicates a malfunction in the RAB system → <b>Have the vehicle inspected by your Toyota dealer immediately.</b>

■ **LED headlight warning light (warning buzzer)**

Warning light	Details/Actions
	Indicates a malfunction in the LED headlights → <b>Have the vehicle inspected by your Toyota dealer immediately.</b>

■ **Automatic headlight leveling system warning light (warning buzzer)**

Warning light	Details/Actions
	Indicates a malfunction in the automatic headlight leveling system → <b>Have the vehicle inspected by your Toyota dealer immediately.</b>

■ **Master warning light (warning buzzer)**

Warning light	Details/Actions
	A buzzer sounds and the warning light comes on and flashes to indicate that the master warning system has detected a malfunction. → <b>P.357</b>

■ **EyeSight warning light (if equipped) (warning buzzer)**

Warning light	Details/Actions
	Indicates a malfunction in the EyeSight → <b>Have the vehicle inspected by your Toyota dealer immediately.</b>

■ **Tire pressure warning light (warning buzzer)**

Warning light	Details/Actions
	<p>When the light comes on:</p> <p>Low tire inflation pressure such as</p> <ul style="list-style-type: none"> <li>● Natural causes (→P.354)</li> <li>● Flat tire (→P.358)</li> </ul> <p>→ <b>Adjust the tire inflation pressure to the specified level. The light will turn off after a few minutes. In case the light does not turn off even if the tire inflation pressure is adjusted, have the system checked by your Toyota dealer.</b></p> <p>When the light comes on after blinking for 1 minute:</p> <p>Malfunction in the tire pressure warning system</p> <p>→ <b>Have the system checked by your Toyota dealer.</b></p>

■ **Front passenger detection sensor, seat belt reminder and warning buzzer**

- If luggage is placed on the front passenger seat, the front passenger detection sensor may cause the warning light to flash and the warning buzzer to sound even if a passenger is not sitting in the seat.
- If a cushion is placed on the seat, the sensor may not detect a passenger, and the warning light may not operate properly.

■ **If the malfunction indicator lamp comes on while driving**

First check the following:

- Is the fuel tank empty?  
If it is, fill the fuel tank immediately.
- Is the fuel tank cap loose?  
If it is, tighten it securely.

The light will go off after several driving trips.

If the light does not go off even after several trips, contact your Toyota dealer as soon as possible.

■ **Electric power steering system warning light (warning buzzer)**

When the battery charge becomes insufficient or the voltage temporarily drops, the electric power steering system warning light may come on and the warning buzzer may sound.

■ **When the tire pressure warning light comes on**

Check the tire inflation pressure and adjust to the appropriate level. Pushing the tire pressure warning reset switch will not turn off the tire pressure warning light.

■ **The tire pressure warning light may come on due to natural causes**

The tire pressure warning light may come on due to natural causes such as natural air leaks and tire inflation pressure changes caused by temperature. In this case, adjusting the tire inflation pressure will turn off the warning light (after a few minutes).

■ **Conditions that the tire pressure warning system may not function properly**

→P.315

■ **If the tire pressure warning light frequently comes on after blinking for 1 minute**

If the tire pressure warning light frequently comes on after blinking for 1 minute when the engine switch is turned to ON, have it checked by your Toyota dealer.

■ **Warning buzzer**

In some cases, the buzzer may not be heard due to being in a noisy location or audio sound.

 **WARNING**

■ **If both the ABS and the brake system warning lights remain on**

Stop your vehicle in a safe place immediately and contact your Toyota dealer. The vehicle will become extremely unstable during braking, and the ABS system may fail, which could cause an accident resulting in death or serious injury.

■ **When the electric power steering system warning light comes on**

The steering wheel may become extremely heavy. When steering wheel operations are heavier than usual, grip the steering wheel firmly and operate it using more force than usual.

■ **If the tire pressure warning light comes on**

Be sure to observe the following precautions. Failure to do so could cause a loss of vehicle control and result in death or serious injury.

- Stop your vehicle in a safe place as soon as possible. Adjust the tire inflation pressure immediately.

- If the tire pressure warning light comes on even after tire inflation pressure adjustment, it is probable that you have a flat tire. Check the tires. If a tire is flat, repair the flat tire by using emergency tire puncture repair kit.

- Avoid abrupt maneuvering and braking. If the vehicle tires deteriorate, you could lose control of the steering wheel or the brakes.

■ **If a blowout or sudden air leakage should occur**

The tire pressure warning system may not activate immediately.

■ **Maintenance of the tires**

Each tire, including the spare (if provided), should be checked monthly when cold and inflated to the inflation pressure recommended by the vehicle manufacturer on the vehicle placard or tire inflation pressure label (tire and load information label). (If your vehicle has tires of a different size than the size indicated on the vehicle placard or tire inflation pressure label [tire and load information label], you should determine the proper tire inflation pressure for those tires.)

 **WARNING**

As an added safety feature, your vehicle has been equipped with a tire pressure monitoring system (TPMS-tire pressure warning system) that illuminates a low tire pressure telltale (tire pressure warning light) when one or more of your tires is significantly under-inflated. Accordingly, when the low tire pressure telltale (tire pressure warning light) illuminates, you should stop and check your tires as soon as possible, and inflate them to the proper pressure. Driving on a significantly under-inflated tire causes the tire to overheat and can lead to tire failure. Under-inflation also reduces fuel efficiency and tire tread life, and may affect the vehicle's handling and stopping ability.

Please note that the TPMS (tire pressure warning system) is not a substitute for proper tire maintenance, and it is the driver's responsibility to maintain correct tire pressure, even if under-inflation has not reached the level to trigger illumination of the TPMS low tire pressure telltale (tire pressure warning light).

Your vehicle has also been equipped with a TPMS (tire pressure warning system) malfunction indicator to indicate when the system is not operating properly. The TPMS (tire pressure warning system) malfunction indicator is combined with the low tire pressure telltale (tire pressure warning light). When the system detects a malfunction, the telltale will flash for approximately one minute and then remain continuously illuminated. This sequence will continue upon subsequent vehicle start-ups as long as the malfunction exists. When the malfunction indicator is illuminated, the system may not be able to detect or signal low tire pressure as intended.

TPMS (tire pressure warning system) malfunctions may occur for a variety of reasons, including the installation of replacement or alternate tires or wheels on the vehicle that prevent the TPMS (tire pressure warning system) from functioning properly. Always check the TPMS (tire pressure warning system) malfunction telltale after replacing one or more tires or wheels on your vehicle to ensure that the replacement or alternate tires and wheels allow the TPMS (tire pressure warning system) to continue to function properly.

 **NOTICE**

■ **To ensure the tire pressure warning system operates properly**

Do not install tires with different specifications or makers, as the tire pressure warning system may not operate properly.

### If a warning message is displayed

The multi-information display shows warnings of system malfunctions, incorrectly performed operations, and messages that indicate a need for maintenance. When a message is shown, perform the correction procedure appropriate to the message.

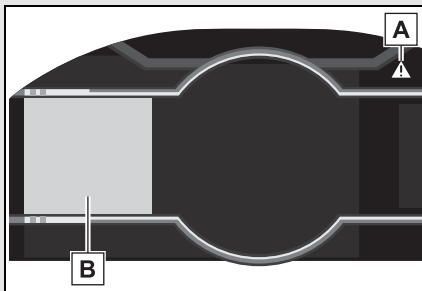

#### A Master warning light

The master warning light also comes on or flashes in order to indicate that a message is currently being displayed on the multi-information display.

#### B Multi-information display

Follow the instructions of the message on the multi-information display.

#### Warning messages

The warning messages explained below may differ from the actual messages according to operation conditions and vehicle specifications.

#### Warning buzzer

In some cases, the buzzer may not be heard due to being in a noisy location or audio sound.

#### If "Check Owner's Manual" is displayed

- If the following messages are shown, following the instructions, accordingly.
  - "High Coolant Temperature" (→P.375)
  - "Transmission Oil Temperature" (→P.149)
- If any of the following messages are shown on the multi-information display, it may indicate a malfunction. Have the vehicle inspected by your Toyota dealer immediately.
  - "EyeSight OFF"
  - "Headlights Disabled"
  - "ABS"
  - "Steering System"
  - "Vehicle Stability Control"
  - "Transmission"
  - "Low Tire Pressure"
  - "RAB Disabled"
  - "BSD/RCTA Disabled"
  - "Keyless Access System Disabled"
  - "Auto Headlight Leveler Disabled"
  - "SRH Disabled"
- If any of the following messages are shown on the multi-information display, it may indicate a malfunction. Immediately stop the vehicle and contact your Toyota dealer.
  - "Brake System"
  - "Check Engine"
  - "SRS Airbag System"

**If you have a flat tire**

**Your vehicle is not equipped with a spare tire, but instead is equipped with an emergency tire puncture repair kit.**

**A puncture caused by a nail or screw passing through the tire tread can be repaired temporarily with the emergency tire puncture repair kit.**

**⚠ WARNING**

**■ If you have a flat tire**

Do not continue driving with a flat tire. Driving even a short distance with a flat tire can damage the tire and the wheel beyond repair. Driving with a flat tire may cause a circumferential groove on the sidewall. In such a case, the tire may explode when using the emergency tire puncture repair kit, resulting in death or serious injury.

**Before repairing the vehicle**

- Stop the vehicle in a safe place on a hard, flat surface.
- Set the parking brake.
- Shift the shift lever to P (automatic transmission) or R (manual transmission).
- Stop the engine.
- Turn on the emergency flashers. (→P.338)
- Check the degree of the tire

damage.

A tire should only be repaired with the emergency tire puncture repair kit if the damage is caused by a nail or screw passing through the tire tread.

- Do not remove the nail or screw from the tire. Removing the object may widen the opening and disenable emergency repair with the kit.
- To avoid sealant leakage, move the vehicle until the area of the puncture, if known, is positioned at the top of the tire.

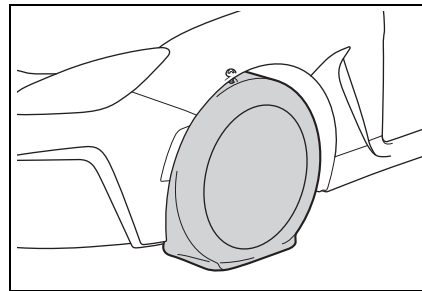

**■ A flat tire that cannot be repaired with the emergency tire puncture repair kit**

In the following cases, the tire cannot be repaired with the emergency tire puncture repair kit. Contact your Toyota dealer.

- When the tire is damaged due to driving without sufficient air pressure
- When the tire lost air pressure due to a crack or damage in the tire sidewall
- When the tire is visibly separated from the wheel
- When the cut or damage to the tread is 0.16 in. (4 mm) long or

- more
- When the wheel is damaged
- When 2 or more sharp objects, such as nails or screws, have passed through the tread on a single tire
- When there is more than one hole or cut in the damaged tire
- When the sealant has expired

**Location of the emergency tire puncture repair kit and tools**

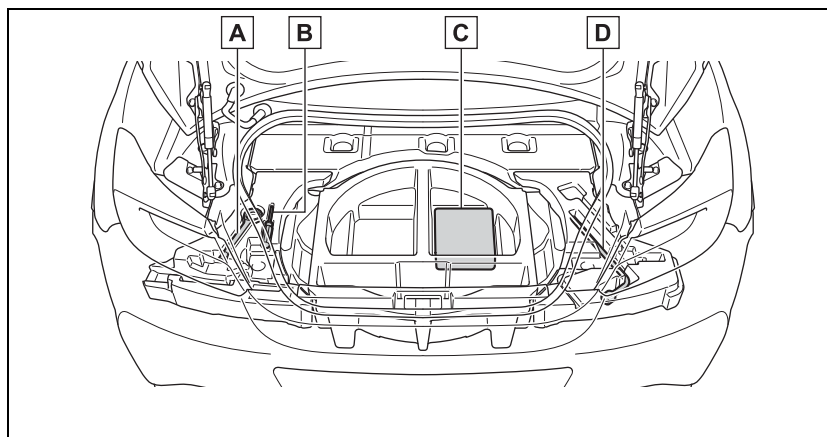

- A** Towing eyelet
- B** Screwdriver
- C** Emergency tire puncture repair kits
- D** Wheel nut wrench

**Emergency tire puncture repair kit components**

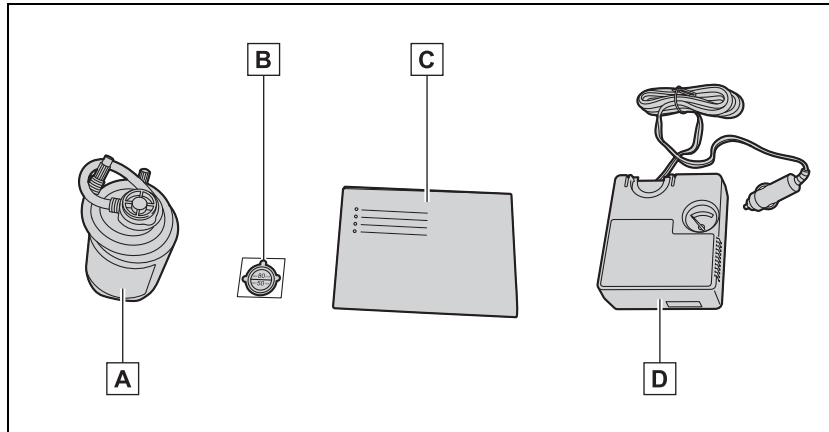

- A** Sealant
- B** Sticker
- C** Quick reference
- D** Compressor
- ▶ Compressor

▶ Sealant

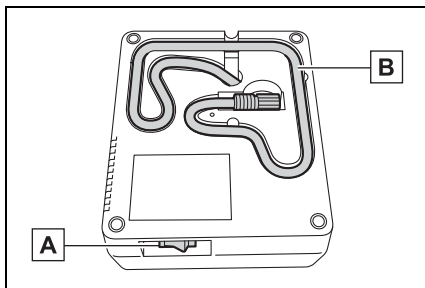

- A** Compressor switch
- B** Hose

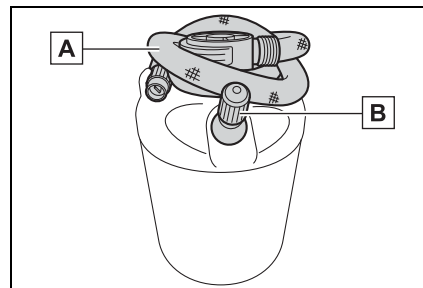

- A** Hose
- B** Valve

■ **Emergency tire puncture repair kit**

- The sealant has a limited lifespan. The expiry date is marked on the bottle. The sealant should be replaced before the expiry date. Contact your Toyota dealer for replacement.
- The sealant stored in the emer-



gency tire puncture repair kit can be used only once to temporarily repair a single tire. If the sealant has been used and needs to be purchased, contact your Toyota dealer. The compressor is reusable.

- The sealant can be used when the outside temperature is from -22°F (-30°C) to 140°F (60°C).
- The kit is exclusively designed for size and type of tires originally installed on your vehicle. Do not use it for tires that a different size than the original ones, or for any other purposes.
- If the sealant gets on your clothes, it may stain.
- If the sealant adheres to a wheel or the surface of the vehicle body, the stain may not be removable if it is not cleaned at once. Immediately wipe away the sealant with a wet cloth.
- During operation of the kit, a loud operation noise is produced. This does not indicate a malfunction.
- Do not use the emergency tire puncture repair kit to check or to adjust the tire pressure.
- In extremely low temperatures -22°F to -4°F (-30°C to -20°C), the viscosity of the sealant increases and the sealant will flow more slowly. In such temperatures, bring the sealant into the vehicle to warm it up before use.

■ **Note for checking the emergency tire puncture repair kit**

Check the sealant expiry date occasionally.

The expiry date is shown on the bottle. Do not use sealant whose expiry date has already passed. Otherwise, repairs conducted using the emergency tire puncture repair kit may not be performed properly.

 **WARNING**

■ **Caution while driving**

- Store the repair kit in the trunk. Injuries may result in the event of an accident or sudden braking.
- The repair kit is exclusively only for your vehicle. Do not use repair kit on other vehicles, which could lead to an accident causing death or serious injury.
- Do not use repair kit for tires that are different size than the original ones, or for any other purpose. If the tires have not been completely repaired, it could lead to an accident causing death or serious injury.

■ **Precautions for use of the sealant**

- Ingesting the sealant is hazardous to your health. If you ingest sealant, consume as much water as possible, then immediately consult a doctor.
- If sealant gets in eyes or adheres to skin, immediately wash it off with water. If discomfort persists, consult a doctor.
- If a person who is allergic to natural rubber comes in contact the sealant, allergy symptoms may occur.

**Taking out the emergency tire puncture repair kits**

- 1 Remove the luggage mat.

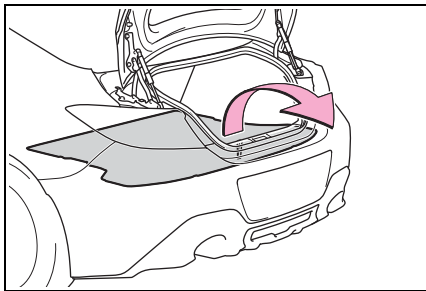

- 2 Take out the emergency tire puncture repair kits. (→P.359)

**Emergency repair method**

- 1 Shake the sealant bottle up and down several times and loosen the hose.

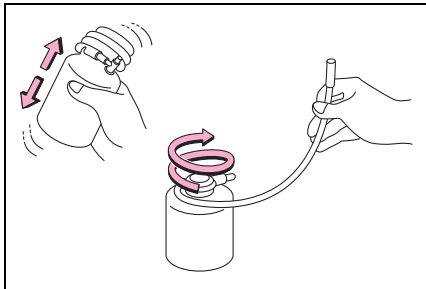

- 2 Connect the air compressor hose to the valve on the bottle.

The sealant may leak if the fitting is

not tight enough.

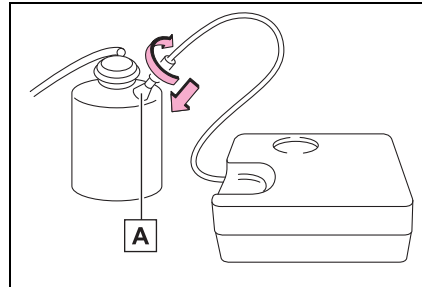

**A** Valve

- 3 Remove the valve cap from the valve of the punctured tire.

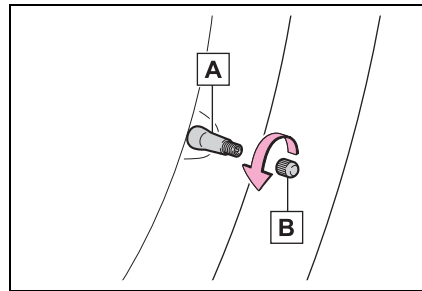

**A** Valve

**B** Cap

- 4 Connect the sealant bottle hose by threading it on the valve.

The sealant may leak if the fitting is not tight enough.

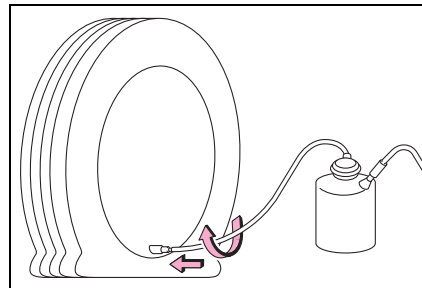

- 5 Turn the bottle upside down and tilt the bottle cap into the bottle holder of the air compressor.

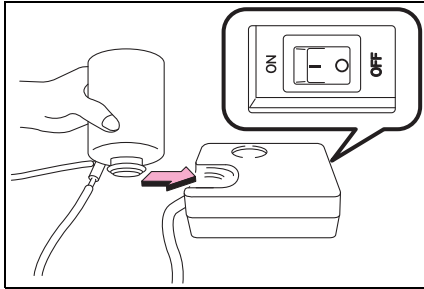

- 6 Make sure that the air compressor switch is off.

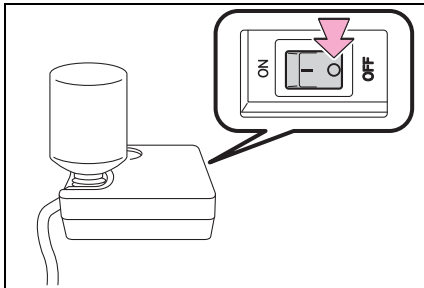

- 7 Connect the compressor power plug to the power outlet.

The engine switch must be in ACC.

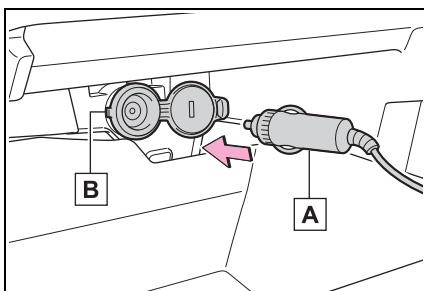

- A Power plug
- B Power outlet

- 8 To inject the sealant and inflate the tire, turn the compressor switch on.

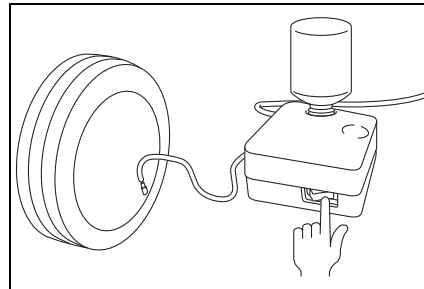

- 9 Adjust the air pressure to the appropriate level (green zone of the air gauge).

After the compressor starts to operate, the air pressure will temporarily rise to 44 psi (300 kPa, 3.0kgf/cm<sup>2</sup> or bar) or higher. After about 30 seconds when all of the sealant is inside the tire, the air pressure will lower, representing the air pressure in the tire.

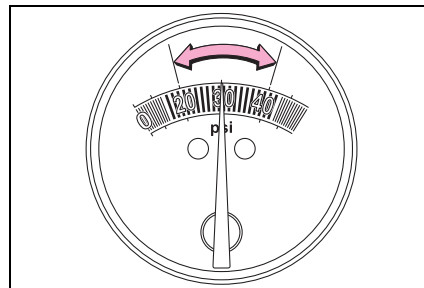

- 10 While filling the tire with air, attach the speed limit label

on the position shown in the illustration.

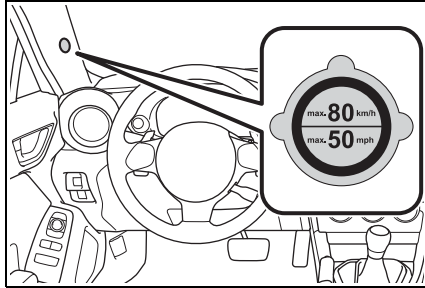

- 11 Turn the air compressor power switch off when the air pressure reaches the green zone of the air gauge. Remove the power plug from the accessory power socket.

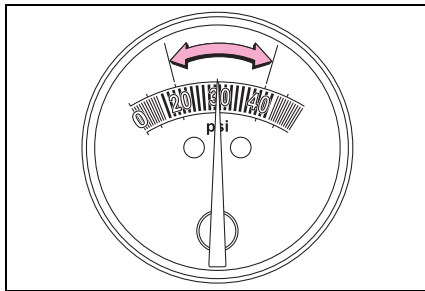

- 12 With the compressor switch off, disconnect the hose from the valve on the tire and then pull out the power plug from the power outlet socket.

Some sealant may leak when the

hose is removed.

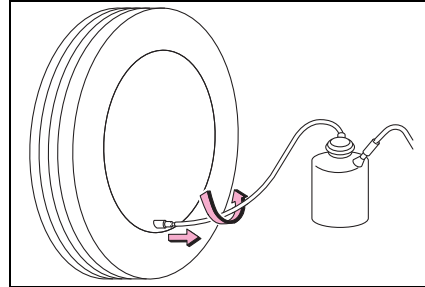

- 13 Install the valve cap onto the valve of the emergency repaired tire.
- 14 Connect the hose of the bottle to the valve of the bottle in a circular fashion to avoid leakage of the remaining sealant.

The sealant may stain clothing.

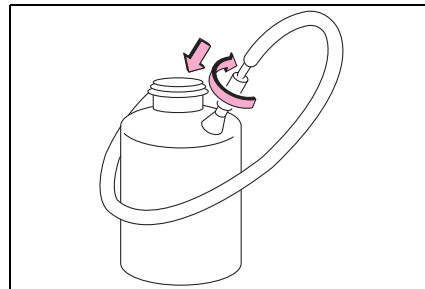

- 15 Stow the kit back in the vehicle and drive your vehicle immediately for 10 minutes or 3 miles (5 km).
- 16 After driving for 10 minutes or 3 miles (5 km), pull your vehi-

cle over in a safe place and reconnect the compressor.

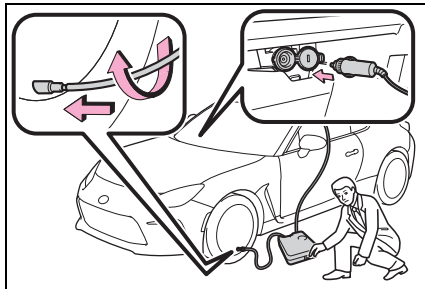

**17** Turn the compressor switch on and wait for several seconds, then turn it off. Check the tire inflation pressure.

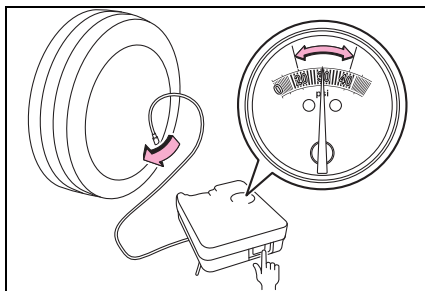

**18** If the air pressure is in red zone of the air gauge, the kit did not successfully seal the puncture. In this case, please stop driving and contact your Toyota dealer.

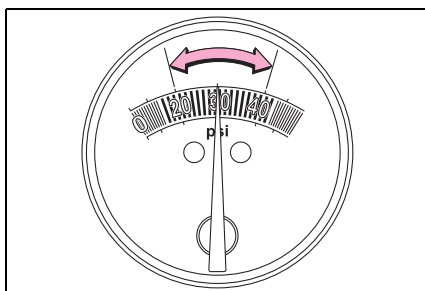

**19** Taking precautions to avoid sudden braking, sudden

acceleration and sharp turns, drive carefully at under 50 mph (80 km/h) to the nearest Toyota dealer that is less than 124 miles (200 km) away for tire repair or replacement.

■ **After a tire is repaired with the emergency tire puncture repair kit**

- The tire pressure warning valve and transmitter should be replaced.
- Even if the tire inflation pressure is at the recommended level, the tire pressure warning light may come on/flash.

**⚠ WARNING**

■ **Do not drive the vehicle with a flat tire**

Do not continue driving with a flat tire.

Driving even a short distance with a flat tire can damage the tire and the wheel beyond repair. Driving with a flat tire may cause a circumferential groove on the side wall. In such a case, the tire may explode when using a repair kit.

■ **When fixing the flat tire**

- Stop your vehicle in a safe and flat area.
- Do not touch the wheels or the area around the brakes immediately after the vehicle has been driven. After the vehicle has been driven, the wheels and the area around the brakes may be extremely hot. Touching these areas with hands, feet or other body parts may result in burns.

 **WARNING**

- Connect the valve and hose securely with the tire installed on the vehicle.
- If the hose is not properly connected to the valve, air leakage may occur or sealant may be sprayed out.
- If the hose comes off the valve while inflating the tire, there is a risk that the hose will move abruptly due to air pressure.
- After inflation of the tire has completed, the sealant may splatter when the hose is disconnected or some air is let out of the tire.
- Follow the operation procedure to repair the tire. If the procedure is not followed, the sealant may spray out.
- Keep back from the tire while it is being repaired, as there is a chance of it bursting while the repair operation is being performed. If you notice any cracks or deformation of the tire, turn off the compressor switch and stop the repair operation immediately.
- The kit may overheat if operated for a long period of time. Do not operate the compressor continuously for more than 10 minutes.
- Parts of the kit become hot during operation. Be careful handling the kit during and after operation. Do not touch the metal part around the connecting area between the bottle and compressor. It will be extremely hot.

- Do not attach the vehicle speed warning sticker to an area other than the one indicated. If the sticker is attached to an area where an SRS airbag is located, such as the pad of the steering wheel, it may prevent the SRS airbag from operating properly.

■ **Driving to spread the liquid sealant evenly**

Observe the following precautions to reduce the risk of accidents. Failing to do so may result in a loss of vehicle control and cause death or serious injury.

- Drive the vehicle carefully at a low speed. Be especially careful when turning and cornering.
- If the vehicle does not drive straight or you feel a pull through the steering wheel, stop the vehicle and check the tire. The tire may have separated from the wheel.

 **NOTICE**

■ **When performing an emergency repair**

- Perform the emergency repair without removing the nail or screw that has punctured the tread of the tire. If the object that has punctured the tire is removed, repair by the emergency tire puncture repair kit may not be possible.
- The kit is not waterproof. Make sure that the kit is not exposed to water, such as when it is being used in the rain.
- Do not put the kit directly onto dusty ground such as sand at the side of the road. If the kit vacuums up dust etc., a malfunction may occur.

 NOTICE

- Make sure to stand the kit with the bottle vertical. The kit cannot work properly if it is laid on its side.
  - **Handling the emergency tire puncture repair kit**
  - The compressor power source should be 12 V DC suitable for vehicle use. Do not connect the compressor to any other source.
  - If gasoline splatters on the kit, the kit may deteriorate. Take care not to allow gasoline to contact it.
  - Store the emergency tire puncture repair kit in the trunk. The kit may be thrown around during sudden braking and so forth, damaging the kit.
- Place the repair kit in a storage to prevent it from being exposed to dirt or water.
- Store the kit in its assigned place out of reach of children.
  - Do not disassemble or modify the kit. Do not subject parts such as the air pressure indicator to impacts. This may cause a malfunction.
  - **To avoid damage to the tire pressure warning valves and transmitters**

When a tire is repaired with liquid sealants, the tire pressure warning valve and transmitter may not operate properly. If a liquid sealant is used, contact your Toyota dealer as soon as possible. After use of liquid sealant, make sure to replace the tire pressure warning valve and transmitter when repairing or replacing the tire. (→P.316)

**If the engine will not start**

**If the engine will not start even though correct starting procedures are being followed (→P.145), consider each of the following points:**

**The engine will not start even though the starter motor operates normally.**

One of the following may be the cause of the problem:

- There may not be sufficient fuel in the vehicle's tank. Refuel the vehicle.
- The engine may be flooded. Try to restart the engine again following correct starting procedures. (→P.145)
- There may be a malfunction in the engine immobilizer system. (→P.80)

**The starter motor turns over slowly, the interior lights and headlights are dim, or the horn does not sound or sounds at a low volume.**

One of the following may be the cause of the problem:

- The battery may be discharged. (→P.372)

- The battery terminal connections may be loose or corroded. (→P.309)

### **The starter motor does not turn over**

The engine starting system may be malfunctioning due to an electrical problem such as electronic key battery depletion or a blown fuse. However, an interim measure is available to start the engine. (→P.368)

### **The starter motor does not turn over, the interior lights and headlights do not turn on, or the horn does not sound.**

One of the following may be the cause of the problem:

- One or both of the battery terminals may be disconnected. (→P.309)
- The battery may be discharged. (→P.372)
- There may be a malfunction in the steering lock system.

Contact your Toyota dealer if the problem cannot be repaired, or if repair procedures are unknown.

### **Emergency start function**

When the engine does not start, the following steps can be used as an interim measure to start

the engine if the engine switch is functioning normally:

- 1 Set the parking brake.
- 2 Shift the shift lever to P (automatic transmission) or N (manual transmission).
- 3 Turn the engine switch to ACC.
- 4 Press and hold the engine switch for about 10 seconds while depressing the brake pedal (automatic transmission) or clutch pedal (manual transmission) firmly.

Even if the engine can be started using the above steps, the system may be malfunctioning. Have the vehicle inspected by your Toyota dealer.



**If you lose your keys**

New genuine mechanical keys can be made by your Toyota dealer using another mechanical key and the key number stamped on your key number stamped on your key number plate.

Keep the plate in a safe place such as your wallet, not in the vehicle.

 NOTICE

■ **When an electronic key is lost**

If the electronic key remains lost, the risk of vehicle theft increases significantly. Visit your Toyota dealer immediately with all remaining electronic keys that were provided with your vehicle.

**If the fuel filler door cannot be opened**

If the fuel filler door cannot be opened by pressing the center of the rear edge of the fuel filler door with the doors unlocked, the following procedure can be used to open the fuel filler door.

**Opening the fuel filler door**

Remove the access cover at the rightside of the trunk trim.

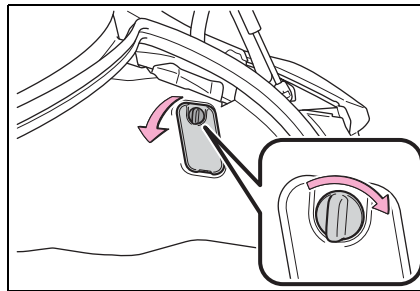

Push the yellow lever to unlock the fuel filler lid.

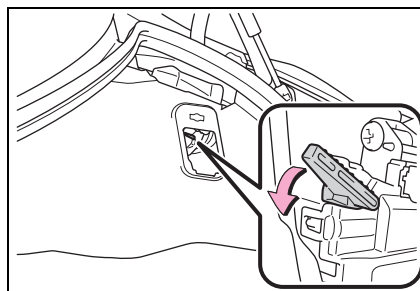

**If the electronic key does not operate properly**

If communication between the electronic key and vehicle is interrupted (→P.112) or the electronic key cannot be used because the battery is depleted, the smart key system and wireless remote control cannot be used. In such cases, the doors can be opened and the engine can be started by following the procedure below.

**■ When the electronic key does not work properly**

- Make sure that the smart key system has not been deactivated in the customization setting. If it is off, turn the function on.
- Check if battery-saving mode is set. If it is set, cancel the function. (→P.112)

 NOTICE

**■ In case of a smart key system malfunction or other key-related problems**

Take your vehicle with all the electronic keys provided with your vehicle to your Toyota dealer.

**Locking and unlocking the doors**

**■ Unlocking the door**

Use the mechanical key (→P.102) in order to perform the

following operations:

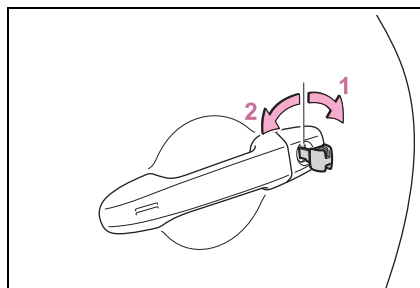

- 1 Unlocks driver's door
- 2 Locks driver's door

**Starting the engine**

- 1 Vehicles with an automatic transmission: Ensure that the shift lever is in P and depress the brake pedal.  
Vehicles with a manual transmission: Shift the shift lever to N and depress the clutch pedal.
- 2 Touch the area behind the lock button and unlock button on the electronic key to the engine switch.

When the electronic key is detected, a buzzer sounds and the engine switch will turn to ON.

When the smart key system is deactivated in customization setting, the engine switch will turn to

ACC.

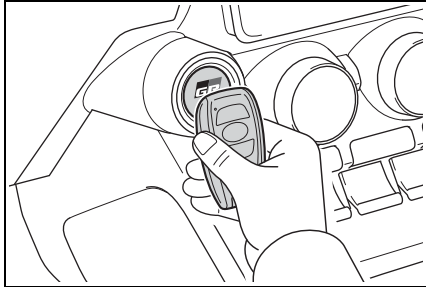

- 3 Firmly depress the brake pedal (automatic transmission) or clutch pedal (manual transmission) and check that  is shown on the multi-information display.
- 4 Press the engine switch.

In the event that the engine still cannot be started, contact your Toyota dealer.

#### ■ Stopping the engine

Vehicles with an automatic transmission: Shift the shift lever to P and press the engine switch as you normally do when stopping the engine.  
Vehicles with a manual transmission: Shift the shift lever to N and press the engine switch as you normally do when stopping the engine.

#### ■ Electronic key battery

As the above procedure is a temporary measure, it is recommended that the electronic key battery be replaced immediately when the battery is depleted. (→P.328)

#### ■ Alarm

Using the mechanical key to lock the doors will not set the alarm system.

If a door is unlocked using the mechanical key when the alarm system is set, the alarm may be triggered.

#### ■ Changing engine switch modes

Release the brake pedal (automatic transmission) or clutch pedal (manual transmission) and press the engine switch in step 3 above. The engine does not start and modes will be changed each time the switch is pressed. (→P.147)

### If the vehicle battery is discharged

The following procedures may be used to start the engine if the vehicle's battery is discharged. You can also call your Toyota dealer or a qualified repair shop.

### Restarting the engine

If you have a set of jumper (or booster) cables and a second vehicle with a 12-volt battery, you can jump start your vehicle

by following the steps below.

- 1 Confirm that the electronic key is being carried.

When connecting the jumper (or booster) cables, depending on the situation, the alarm may activate and doors locked.

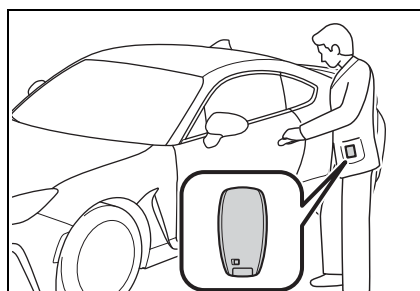

- 2 Open the hood. (→P.302)

- 3 Connect a positive jumper cable clamp to **A** on your vehicle and connect the clamp on the other end of the positive cable to **B** on the second vehicle. Then, connect a negative cable clamp to **C** on the second vehicle and connect the clamp at the other end of the negative cable to **D**.

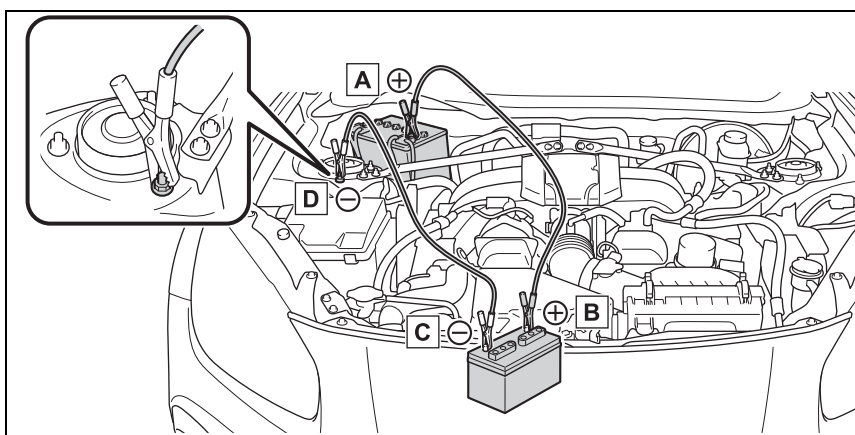

- A** Positive (+) battery terminal (your vehicle)
- B** Positive (+) battery terminal (second vehicle)
- C** Negative (-) battery terminal (second vehicle)

**D** Connect the jumper cable to ground on your vehicle as shown in the illustration.

- 4 Start the engine of the second vehicle. Increase the engine speed slightly and maintain at that level for approximately 5 minutes to recharge the battery of your vehicle.
- 5 Open and close any of the door of your vehicle with the engine switch off.
- 6 Maintain the engine speed of the second vehicle and start the engine of your vehicle by turning the engine switch to ON.
- 7 Once the vehicle's engine has started, remove the jumper cables in the exact reverse order from which they were connected.

Once the engine starts, have the vehicle inspected at your Toyota dealer as soon as possible.

#### ■ Starting the engine when the battery is discharged

The engine cannot be started by push-starting.

#### ■ To prevent battery discharge

- Turn off the headlights and the audio system while the engine is off.
- Turn off any unnecessary electrical components when the vehicle is running at a low speed for an extended period, such as in heavy traffic.

#### ■ When the battery is removed or discharged

Information stored in the ECU is cleared. When the battery is depleted, have the vehicle inspected at your Toyota dealer.

#### ■ When removing the battery terminals

When the battery terminals are removed, the information stored in the ECU is cleared. Before removing the battery terminals, contact your Toyota dealer.

#### ■ Charging the battery

The electricity stored in the battery will discharge gradually even when the vehicle is not in use, due to natural discharge and the draining effects of certain electrical appliances. If the vehicle is left for a long time, the battery may discharge, and the engine may be unable to start. (The battery recharges automatically during driving.)

#### ■ When recharging or replacing the battery

- In some cases, it may not be possible to unlock the doors using the smart key system when the battery is discharged. Use the wireless remote control or the mechanical key to lock or unlock the doors.
- The engine may not start on the first attempt after the battery has recharged but will start normally after the second attempt. This is not a malfunction.
- The engine switch mode is memorized by the vehicle. When the battery is reconnected, the system will return to the mode it was in before the battery was discharged. Before disconnecting the battery, turn the engine switch off. If you are unsure what mode the engine switch was in before the

battery discharged, be especially careful when reconnecting the battery.

 **WARNING**

■ **When removing the battery terminals**

Always remove the negative (-) terminal first. If the positive (+) terminal contacts any metal in the surrounding area when the positive (+) terminal is removed, a spark may occur, leading to a fire in addition to electrical shocks and death or serious injury.

■ **Avoiding battery fires or explosions**

Observe the following precautions to prevent accidentally igniting the flammable gas that may be emitted from the battery:

- Make sure each jumper cable is connected to the correct terminal and that it is not unintentionally in contact with any other than the intended terminal.
- Do not allow the + and - clamps of the jumper cables to come into contact with each other.
- Do not smoke, use matches, cigarette lighters or allow open flame near the battery.

■ **Battery precautions**

The battery contains poisonous and corrosive acidic electrolyte, while related parts contain lead and lead compounds. Observe the following precautions when handling the battery:

- When working with the battery, always wear safety glasses and take care not to allow any battery fluids (acid) to come into contact with skin, clothing or the vehicle body.
- Do not lean over the battery.

- In the event that battery fluid comes into contact with the skin or eyes, immediately wash the affected area with water and seek medical attention. Place a wet sponge or cloth over the affected area until medical attention can be received.

- Always wash your hands after handling the battery support, terminals, and other battery-related parts.

- Do not allow children near the battery.

■ **To prevent damage to the vehicle**

Do not pull- or push-start the vehicle as the three-way catalytic converter may overheat and become a fire hazard.

 **NOTICE**

■ **When handling jumper cables**

Be careful that the jumper cables do not become tangled in the cooling fans or any of the belts when connecting or disconnecting them.

■ **When closing the doors**

While pushing the door glass towards the inside of the vehicle, slowly close the door. Because the side window open/close function linked to door operation will not operate, the window may interfere with the vehicle body, possibly scratching both the vehicle body and window, or even shattering the window.

### If your vehicle overheats

The following may indicate that your vehicle is overheating.

- The engine coolant temperature gauge (→P.88) is in the red zone or a loss of engine power is experienced. (For example, the vehicle speed does not increase.)
- “High Coolant Temperature Check Owner’s Manual” is shown on the multi-information display.
- Steam comes out from under the hood.

### Correction procedures

- 1 Stop the vehicle in a safe place and turn off the air conditioning system, and then stop the engine.
- 2 If you see steam: Carefully lift the hood after the steam subsides.  
If you do not see steam: Carefully lift the hood.
- 3 After the engine has cooled down sufficiently, inspect the

hoses and radiator core (radiator) for any leaks.

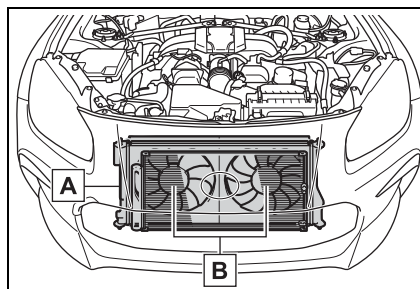

**A** Radiators

**B** Cooling fans

If a large amount of coolant leaks, immediately contact your Toyota dealer.

- 4 The coolant level is satisfactory if it is between the “FULL” and “LOW” lines on the reservoir.

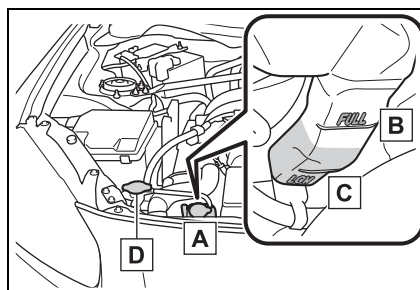

**A** Reservoir

**B** “FULL” line

**C** “LOW” line

**D** Radiator cap

- 5 Add engine coolant if necessary.

Water can be used in an emergency if engine coolant is unavail-

able.

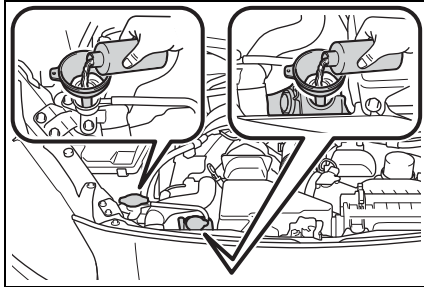

- 6 Start the engine and turn the air conditioning system on to check that the radiator cooling fans operate and to check for coolant leaks from the radiator or hoses.

The fans operate when the air conditioning system is turned on immediately after a cold start. Confirm that the fans are operating by checking the fan sound and air flow. If it is difficult to check these, turn the air conditioning system on and off repeatedly. (The fans may not operate in freezing temperatures.)

- 7 If the fans are not operating: Stop the engine immediately and contact your Toyota dealer.  
If the fans are operating: Have the vehicle inspected at the nearest Toyota dealer.

**⚠ WARNING**

■ **When inspecting under the hood of your vehicle**

Observe the following precautions. Failure to do so may result in serious injury such as burns.

- If steam is seen coming from under the hood, do not open the hood until the steam has subsided. The engine compartment may be very hot.
- Keep hands and clothing (especially a tie, a scarf or a muffler) away from the fans and belts. Failure to do so may cause the hands or clothing to be caught, resulting in serious injury.
- Do not loosen the coolant reservoir caps while the engine and radiator are hot. High temperature steam or coolant could spray out.

**⚠ NOTICE**

■ **When adding engine coolant**

Add coolant slowly after the engine has cooled down sufficiently. Adding cool coolant to a hot engine too quickly can cause damage to the engine.

■ **To prevent damage to the cooling system**

Observe the following precautions:

- Avoid contaminating the coolant with foreign matter (such as sand or dust etc.).
- Do not use any coolant additive.



**If the vehicle becomes stuck**

Carry out the following procedures if the tires spin or the vehicle becomes stuck in mud, dirt or snow:

**Recovering procedure**

- 1** Stop the engine. Set the parking brake and shift the shift lever to P (automatic transmission) or N (manual transmission).
- 2** Remove the mud, snow or sand from around the rear wheels.
- 3** Place wood, stones or some other material under the rear wheels to help provide traction.
- 4** Restart the engine.
- 5** Shift the shift lever to D or R (automatic transmission) or 1 or R (manual transmission) and release the parking brake. Then, while exercising caution, depress the accelerator pedal.

**When it is difficult to free the vehicle**

Press the  switch to turn off TRAC.

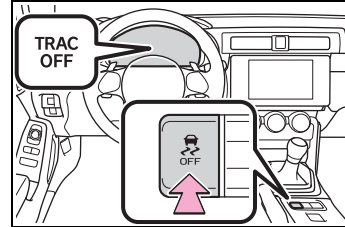
**WARNING****When attempting to free a stuck vehicle**

If you choose to push the vehicle back and forth to free it, make sure the surrounding area is clear to avoid striking other vehicles, objects or people. The vehicle may also lunge forward or lunge back suddenly as it becomes free. Use extreme caution.

**When shifting the shift lever (vehicles with an automatic transmission)**

Be careful not to shift the shift lever with the accelerator pedal depressed. This may lead to unexpected rapid acceleration of the vehicle that may cause an accident resulting in death or serious injury.

**NOTICE****To avoid damaging the transmission and other components**

- Avoid spinning the rear wheels and depressing the accelerator pedal more than necessary.
- If the vehicle remains stuck even after these procedures are performed, the vehicle may require towing to be freed.



**Vehicle specifications**

**8**

379

**8-1. Specifications**

- Maintenance data (fuel, oil level, etc.)..... 380
- Fuel information ..... 388
- Tire information ..... 390

**8-2. Customization**

- Customizable features ..... 400

**8**

Vehicle specifications

## Maintenance data (fuel, oil level, etc.)

## Dimensions and weight

Overall length	167.9 in. (4265 mm)	
Overall width	69.9 in. (1775 mm)	
Overall height*	51.6 in. (1310 mm)	
Wheelbase	101.4 in. (2575 mm)	
Tread	Front	59.8 in. (1520 mm)
	Rear	61.0 in. (1550 mm)
Vehicle capacity weight (Occupants + luggage)	Details are described on the tire and loading information label. (→P.323)	

\*: Unladen vehicle

## Seating capacity

Seating capacity	4 (Front 2, Rear 2)
------------------	---------------------

## Vehicle identification

### ■ Vehicle identification number

The vehicle identification number (VIN) is the legal identifier for your vehicle. This is the primary identification number for your Toyota. It is used in registering the ownership of your vehicle.

This number is stamped under the right-hand front seat.

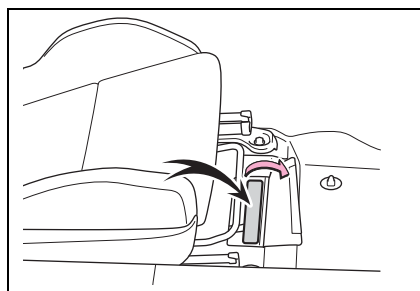

This number is located on the top left of the body panel.

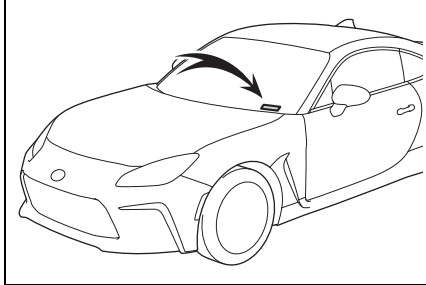

This number is also on the Certification Label.

The vehicle model type, vehicle identification number, etc. are on the manufacturer's label.



■ **Engine number**

The engine number is stamped on the engine block as shown.

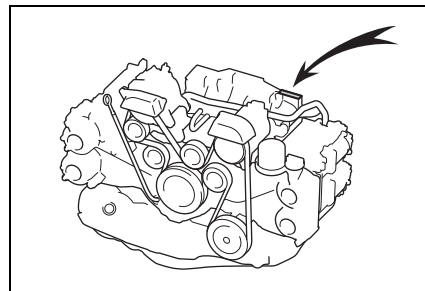

**Engine**

Model	FA24
Type	Horizontally opposed, liquid cooled 4 cylinder, 4-stroke gasoline
Bore and stroke	3.70 × 3.39 in. (94.0 × 86.0 mm)
Displacement	146 cu. in. (2387 cm <sup>3</sup> )
Drive belt tension	Automatic adjustment

**Fuel**

Fuel type	Unleaded gasoline only
Octane Rating	93 (Research octane number 98) or higher*
Fuel tank capacity (Reference)	13.2 gal. (50.0 L, 11.0 Imp. gal.)

\*: If unleaded gasoline with an octane rating of 93 (98 RON) is not available,

unleaded gasoline with an octane rating of 91 (95 RON) may be used with no detriment to engine durability or driveability.

## Lubrication system

### ■ Oil capacity (Drain and refill [Reference\*])

With filter	5.3 qt. (5.0 L, 4.4 Imp. qt.)
Without filter	5.1 qt. (4.8 L, 4.2 Imp. qt.)

\*: The engine oil capacity is a reference quantity to be used when changing the engine oil. Warm up and turn off the engine, wait more than 5 minutes, and check the oil level on the dipstick.

### ■ Engine oil selection

“Toyota Genuine Motor Oil” is used in your Toyota vehicle. Use Toyota approved “Toyota Genuine Motor Oil” or equivalent to satisfy the following grade and viscosity.

Oil grade: ILSAC GF-6A multi-grade engine oil

Recommended viscosity: SAE 0W-20

SAE 0W-20 is the best choice for good fuel economy and good starting in cold weather.

If SAE 0W-20 is not available, SAE 5W-20 oil may be used. However, it must be replaced with SAE 0W-20 at the next oil change.

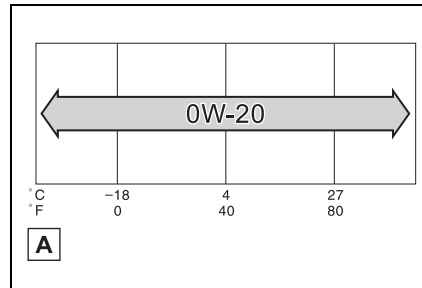

#### A Outside temperature

Oil viscosity (0W-20 is explained here as an example):

- The 0W in 0W-20 indicates the characteristic of the oil which allows cold startability. Oils with a lower value before the W allow for easier starting of the engine in cold weather.
- The 20 in 0W-20 indicates the viscosity characteristic of the oil when the oil is at high temperature. An oil with a higher viscosity (one with a higher value) may be better suited if the vehicle is operated at high speeds, or under extreme load conditions.

How to read oil container label:

The International Lubricant Specification Advisory Committee (ILSAC) Certification Mark is added to some oil containers to help you select the oil you should use.



**Cooling system**

Capacity	<ul style="list-style-type: none"> <li>▶ Vehicles with an automatic transmission 8.1 qt. (7.7 L, 6.8 Imp. qt.)</li> <li>▶ Vehicles with a manual transmission 7.8 qt. (7.4 L, 6.5 Imp. qt.)</li> </ul>
Coolant type	<p>Use either of the following.</p> <ul style="list-style-type: none"> <li>• “TOYOTA Genuine 50/50 Pre-mixed Super Long Life Coolant BLUE”</li> <li>• Similar high-quality ethylene glycol-based non-silicate, non-amine, non-nitrite, and non-borate coolant with long-life hybrid organic acid technology</li> </ul> <p>Do not use plain water alone.</p>

**Ignition system (spark plug)**

Make	DENSO ZXE27HBR8
Gap	0.031 in. (0.8 mm)

 NOTICE
<p><b>■ Iridium-tipped spark plugs</b></p> <p>Use only iridium-tipped spark plugs. Do not adjust gap when tuning engine.</p>

### Electrical system

Battery Specific gravity reading at 68°F (20°C):	1.250—1.290 Fully charged 1.160—1.200 Half charged 1.060—1.100 Discharged
Charging rates	
Quick charge	15 A max.
Slow charge	5 A max.

### Differential

Oil capacity (Reference)	1.22 qt. (1.15 L, 1.01 Imp. qt.)
Oil type and viscosity*	<ul style="list-style-type: none"> <li>• Toyota Genuine Differential Gear Oil LX</li> <li>• Other LSD gear oil that meets API GL-5 and SAE 75W-85</li> </ul>

\*: Your Toyota vehicle is filled with “Toyota Genuine Differential Gear Oil LX” at the factory. Use Toyota approved “Toyota Genuine Differential Gear Oil LX” or an equivalent of matching quality to satisfy the above specification. Please contact your Toyota dealer for further details.



#### NOTICE

#### ■ Differential gear oil type

Using a differential gear oil other than “Toyota Genuine Differential Gear Oil LX” may cause occurrences of noises, vibrations and poor fuel consumption. Never use different brands together.

### Automatic transmission

Fluid capacity*	7.9 qt. (7.5 L, 6.6 Imp. qt.)
Fluid type	Toyota Genuine ATF WS

\*: The fluid capacity is provided as a reference.  
If replacement is necessary, contact your Toyota dealer.



 **NOTICE**

**Transmission fluid type**

Using automatic transmission fluid other than “TOYOTA Genuine ATF WS” may cause deterioration in shift quality, locking up of your transmission accompanied by vibration, and ultimately damage the automatic transmission of your vehicle.

**Manual transmission**

Fluid capacity *	2.3 qt. (2.2 L, 1.9 Imp. qt.)
Fluid type	Use either of the following: <ul style="list-style-type: none"> <li>• “MT GEAR OIL LV 75W”</li> <li>• Other gear oil that meets API GL-4* and SAE 75W specifications</li> </ul>

\*: The recommended oil grade is API GL-4. However, API GL-3 can also be used.

 **NOTICE**

**Transmission fluid type**

If oil other than “MT GEAR OIL LV 75W” is used, the following may be experienced:

- The overall performance and function of the transmission may be adversely affected.
- Rattling noises may occur during idling and fuel consumption may increase.

Never use different brands together.

**Clutch**

Pedal free play	0.17—0.65 in. (4.3—16.4 mm)
Fluid type	SAE J1703 or FMVSS No.116 DOT 3

**Brakes**

Pedal clearance <sup>*1</sup>	2.91 in. (74 mm) Min.
Pedal free play	0.020—0.059 in. (0.5—1.5 mm)

Brake pad wear limit	Front	0.06 in. (1.5 mm)
	Rear	0.06 in. (1.5 mm)
Parking brake lining wear limit		0.06 in. (1.5 mm)
Parking brake lever travel <sup>*2</sup>		7 - 8 clicks
Fluid type		SAE J1703 or FMVSS No.116 DOT 3

<sup>\*1</sup>: Minimum pedal clearance when depressed with a force of 67 lbf (300 N, 30 kgf) while the engine is running.

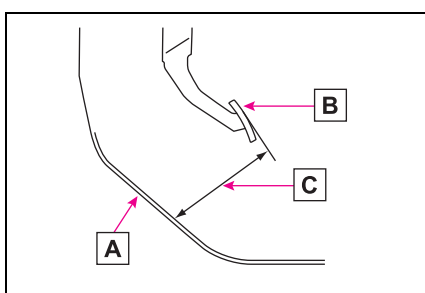

- A** Carpet
- B** Brake pedal
- C** Pedal clearance

<sup>\*2</sup>: Parking brake lever travel when pulled up with a force of 45.0 lbf (200 N, 20.4 kgf).

### Steering

Free play	Less than 1.2 in. (30 mm)
-----------	---------------------------

### Tires and wheels

► Type A

Tire size	215/45R17 87W
Tire inflation pressure (Recommended cold tire inflation pressure)	Front: 35 psi (240 kPa, 2.4 kgf/cm <sup>2</sup> or bar) Rear: 35 psi (240 kPa, 2.4 kgf/cm <sup>2</sup> or bar)
Wheel size	17 × 7 1/2 J
Wheel nut torque	89 ft•lbf (120 N•m, 12.2 kgf•m)

► Type B

Tire size	215/40R18 85Y
Tire inflation pressure (Recommended cold tire inflation pressure)	Driving under normal conditions Front: 35 psi (240 kPa, 2.4 kgf/cm <sup>2</sup> or bar) Rear: 35 psi (240 kPa, 2.4 kgf/cm <sup>2</sup> or bar)
Wheel size	18 × 7 1/2 J
Wheel nut torque	89 ft•lbf (120 N•m, 12.2 kgf•m)

**Light bulbs**

	Light bulbs	Bulb No.	W	Type
Exterior	Back-up lights	W16W	16	A
Interior	Vanity lights (if equipped)	—	2	B
	Interior light	—	8	A
	Door courtesy lights (if equipped)	W5W	5	A
	Trunk light	#194	3.8	A

A: Wedge base bulbs (clear)

B: Double end bulbs

## Fuel information

**You must only use unleaded gasoline.**

**The engine is designed to operate at maximum performance using unleaded gasoline with an octane rating of 93 (98 RON) or higher. If an octane rating of 93 (98 RON) fuel is not readily available in your area, unleaded gasoline with an octane rating of 91 (95 RON) may be used with no detriment to engine durability or driveability. However, you may notice a slight decrease in maximum engine performance and you may hear some knocking (pinging) of an engine while using an octane rating of 91 (95 RON) fuel.**

**If the octane rating is less than 91, damage to the engine may occur and may void the vehicle warranty.**

**At minimum, the gasoline you use should meet the specifications of ASTM D4814 in the U.S.A..**

### ■ Gasoline quality

In very few cases, driveability problems may be caused by the brand of gasoline you are using. If driveability problems persist, try changing the brand of gasoline. If this does not correct the problem, consult your

Toyota dealer.

### ■ Recommendation of the use of gasoline containing detergent additives

- Toyota recommends the use of gasoline that contains detergent additives to avoid the build-up of engine deposits.
- All gasoline sold in the U.S.A. contains minimum detergent additives to clean and/or keep clean intake systems, per EPA's lowest additives concentration program.
- Toyota strongly recommends the use of Top Tier Detergent Gasoline. For more information on Top Tier Detergent Gasoline and a list of marketers, please go to the official website [www.toptiergas.com](http://www.toptiergas.com).

### ■ Recommendation of the use of low emissions gasoline

Gasolines containing oxygenates such as ethers and ethanol, as well as reformulated gasolines, are available in some cities. These fuels are typically acceptable for use, providing they meet other fuel requirements.

Toyota recommends these fuels, since the formulations allow for reduced vehicle emissions.

### ■ Non-recommendation of the use of blended gasoline

- Use only gasoline containing up to 15% ethanol. DO NOT use any flex-fuel or gasoline that could contain more than 15% ethanol, including from any pump labeled E30 (30% ethanol [A]), E50 (50% ethanol [B]), E85 (85% ethanol [C]) (which are only some examples of fuel containing more than 15% ethanol).

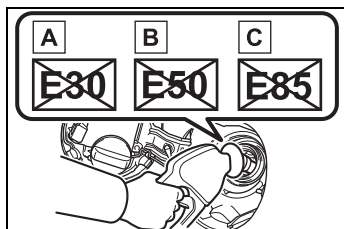

- If you use gasohol in your vehicle, be sure that it has an octane rating no lower than 91.
- Toyota does not recommend the use of gasoline containing methanol.

#### ■ Non-recommendation of the use of gasoline containing MMT

Some gasoline contains an octane enhancing additive called MMT (Methylcyclopentadienyl Manganese Tricarbonyl).

Toyota does not recommend the use of gasoline that contains MMT. If fuel containing MMT is used, your emission control system may be adversely affected.

The malfunction indicator lamp on the instrument cluster may come on. If this happens, contact your Toyota dealer for service.

#### ■ If your engine knocks

- Consult your Toyota dealer.
- You may occasionally notice light knocking for a short time while accelerating or driving uphill. This is normal and there is no need for concern.



#### NOTICE

##### ■ Notice on fuel quality

- Do not use improper fuels. If improper fuels are used, the engine will be damaged.

- Do not use leaded gasoline. Leaded gasoline can cause damage to your vehicle's three-way catalytic converters causing the emission control system to malfunction.
- Do not use gasohol other than the type previously stated. Other gasohol may cause fuel system damage or vehicle performance problems.
- Using unleaded gasoline with an octane number or rating lower than the level previously stated may cause persistent heavy knocking. At worst, this may lead to engine damage and will void the vehicle warranty.

#### ■ When refueling with gasohol

Take care not to spill gasohol. It can damage your vehicle's paint.

#### ■ Fuel-related poor driveability

If poor driveability (poor hot starting, vaporization, engine knocking, etc.) is encountered after using a different type of fuel, discontinue the use of that type of fuel.

## Tire information

## Typical tire symbols

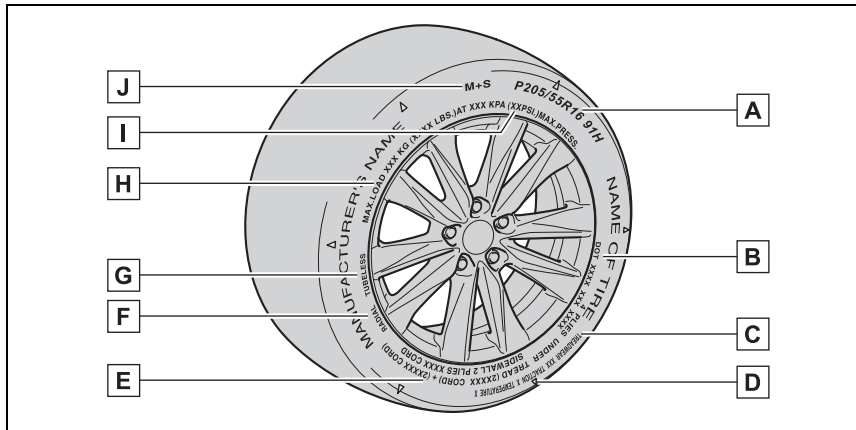

**A** Tire size (→P.391)

**B** DOT and Tire Identification Number (TIN) (→P.391)

**C** Uniform tire quality grading

For details, see “Uniform Tire Quality Grading” that follows.

**D** Location of treadwear indicators (→P.312)

**E** Tire ply composition and materials

Plies are layers of rubber-coated parallel cords. Cords are the strands which form the plies in a tire.

**F** Radial tires or bias-ply tires

A radial tire has “RADIAL” on the sidewall. A tire not marked “RADIAL” is a bias-ply tire.

**G** TUBELESS or TUBE TYPE

A tubeless tire does not have a tube and air is directly put into the tire. A tube type tire has a tube inside the tire and the tube maintains the air pressure.

**H** Load limit at maximum cold tire inflation pressure (→P.393)

**I** Maximum cold tire inflation pressure (→P.393)

This means the pressure to which a tire may be inflated.

**J** Summer tires or all season tires (→P.313)

An all season tire has “M+S” on the sidewall. A tire not marked “M+S” is a summer tire.

**Typical DOT and Tire Identification Number (TIN)**

► Type A

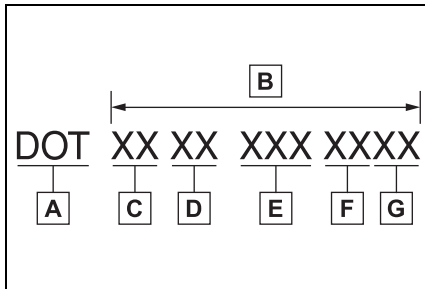

- A DOT symbol\*
- B Tire Identification Number (TIN)
- C Tire manufacturer's identification mark
- D Tire size code
- E Manufacturer's optional tire type code (3 or 4 letters)
- F Manufacturing week
- G Manufacturing year

\*: The DOT symbol certifies that the tire conforms to applicable Federal Motor Vehicle Safety Standards.

► Type B

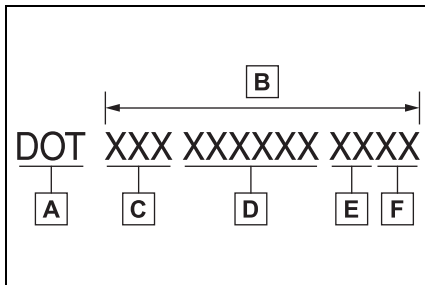

- A DOT symbol\*
- B Tire Identification Number (TIN)
- C Tire manufacturer's identification mark
- D Manufacturer's code
- E Manufacturing week
- F Manufacturing year

\*: The DOT symbol certifies that the tire conforms to applicable Federal Motor Vehicle Safety Standards.

**Tire size**

■ Typical tire size information

The illustration indicates typical tire size.

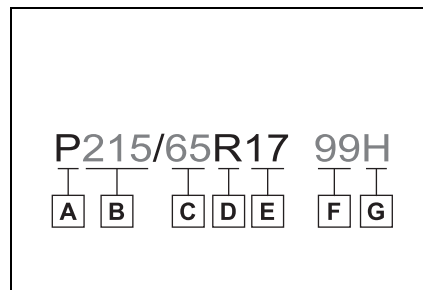

- A Tire use (P = Passenger car, T = Temporary use)
- B Section width (millimeters)
- C Aspect ratio (tire height to section width)
- D Tire construction code (R = Radial, D = Diagonal)
- E Wheel diameter (inches)
- F Load index (2 digits or 3 digits)

**G** Speed symbol (alphabet with one letter)

**K** Chafer

■ **Tire dimensions**

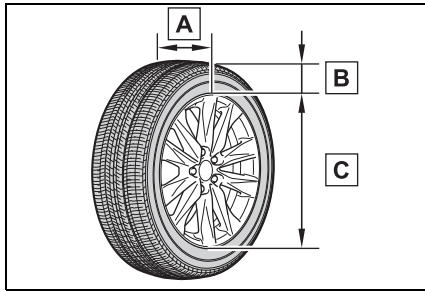

**A** Section width

**B** Tire height

**C** Wheel diameter

■ **Tire section names**

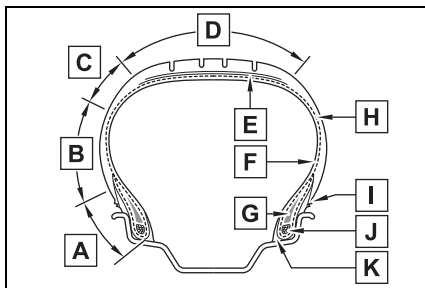

**A** Bead

**B** Sidewall

**C** Shoulder

**D** Tread

**E** Belt

**F** Inner liner

**G** Reinforcing rubber

**H** Carcass

**I** Rim lines

**J** Bead wires

**Uniform Tire Quality Grading**

This information has been prepared in accordance with regulations issued by the National Highway Traffic Safety Administration of the U.S. Department of Transportation.

It provides the purchasers and/or prospective purchasers of Toyota vehicles with information on uniform tire quality grading.

Your Toyota dealer will help answer any questions you may have as you read this information.

■ **DOT quality grades**

All passenger vehicle tires must conform to Federal Safety Requirements in addition to these grades. Quality grades can be found where applicable on the tire sidewall between tread shoulder and maximum section width.

For example: Treadwear 200 Traction AA Temperature A

■ **Treadwear**

The treadwear grade is a comparative rating based on the wear rate of the tire when tested under controlled conditions on a specified government test course.

For example, a tire graded 150



would wear one and a half (1 - 1/2) times as well on the government course as a tire graded 100. The relative performance of tires depends upon the actual conditions of their use. Performance may differ significantly from the norm due to variations in driving habits, service practices and differences in road characteristics and climate.

■ **Traction AA, A, B, C**

The traction grades, from highest to lowest, are AA, A, B and C, and they represent the tire's ability to stop on wet pavement as measured under controlled conditions on specified government test surfaces of asphalt and concrete.

A tire marked C may have poor traction performance.

Warning: The traction grade assigned to this tire is based on braking (straight ahead) traction tests and does not include cornering (turning) traction.

■ **Temperature A, B, C**

The temperature grades are A

(the highest), B, and C, representing the tire's resistance to the generation of heat and its ability to dissipate heat when tested under controlled conditions on a specified indoor laboratory test wheel.

Sustained high temperature can cause the material of the tire to degenerate and reduce tire life, and excessive temperature can lead to sudden tire failure.

Grade C corresponds to a level of performance which all passenger car tires must meet under the Federal Motor Vehicle Safety Standard No. 109.

Grades B and A represent higher levels of performance on the laboratory test wheel than the minimum required by law.

Warning: The temperature grades of a tire assume that it is properly inflated and not overloaded. Excessive speed, underinflation, or excessive loading, either separately or in combination, can cause heat buildup and possible tire failure.

**Glossary of tire terminology**

Tire related term	Meaning
Cold tire inflation pressure	Tire pressure when the vehicle has been parked for three hours or more, or has not been driven more than 1 mile or 1.5 km under that condition
Maximum inflation pressure	The maximum cold inflated pressure to which a tire may be inflated, shown on the sidewall of the tire

Tire related term	Meaning
Recommended inflation pressure	Cold tire inflation pressure recommended by a manufacturer
Accessory weight	The combined weight (in excess of those standard items which may be replaced) of automatic transmission, power steering, power brakes, power windows, power seats, radio and heater, to the extent that these items are available as factory-installed equipment (whether installed or not)
Curb weight	The weight of a motor vehicle with standard equipment, including the maximum capacity of fuel, oil and coolant, and if so equipped, air conditioning and additional weight optional engine
Maximum loaded vehicle weight	The sum of: (a) Curb weight (b) Accessory weight (c) Vehicle capacity weight (d) Production options weight
Normal occupant weight	150 lb. (68 kg) times the number of occupants specified in the second column of Table 1* that follows
Occupant distribution	Distribution of occupants in a vehicle as specified in the third column of Table 1* below
Production options weight	The combined weight of installed regular production options weighing over 5 lb. (2.3 kg) in excess of the standard items which they replace, not previously considered in curb weight or accessory weight, including heavy duty brakes, ride levelers, roof rack, heavy duty battery, and special trim
Rim	A metal support for a tire or a tire and tube assembly upon which the tire beads are seated

Tire related term	Meaning
Rim diameter (Wheel diameter)	Nominal diameter of the bead seat
Rim size designation	Rim diameter and width
Rim type designation	The industry manufacturer's designation for a rim by style or code
Rim width	Nominal distance between rim flanges
Vehicle capacity weight (Total load capacity)	The rated cargo and luggage load plus 150 lb. (68 kg) times the vehicle's designated seating capacity
Vehicle maximum load on the tire	The load on an individual tire that is determined by distributing to each axle its share of the maximum loaded vehicle weight, and dividing by two
Vehicle normal load on the tire	The load on an individual tire that is determined by distributing to each axle its share of curb weight, accessory weight, and normal occupant weight (distributed in accordance with Table 1 <sup>*</sup> below), and dividing by two
Weather side	The surface area of the rim not covered by the inflated tire
Bead	The part of the tire that is made of steel wires, wrapped or reinforced by ply cords and that is shaped to fit the rim
Bead separation	A breakdown of the bond between components in the bead
Bias ply tire	A pneumatic tire in which the ply cords that extend to the beads are laid at alternate angles substantially less than 90 degrees to the centerline of the tread
Carcass	The tire structure, except tread and sidewall rubber which, when inflated, bears the load
Chunking	The breaking away of pieces of the tread or sidewall
Cord	The strands forming the plies in the tire

Tire related term	Meaning
Cord separation	The parting of cords from adjacent rubber compounds
Cracking	Any parting within the tread, sidewall, or innerliner of the tire extending to cord material
CT	A pneumatic tire with an inverted flange tire and rim system in which the rim is designed with rim flanges pointed radially inward and the tire is designed to fit on the underside of the rim in a manner that encloses the rim flanges inside the air cavity of the tire
Extra load tire	A tire designed to operate at higher loads and at higher inflation pressures than the corresponding standard tire
Groove	The space between two adjacent tread ribs
Innerliner	The layer(s) forming the inside surface of a tubeless tire that contains the inflating medium within the tire
Innerliner separation	The parting of the innerliner from cord material in the carcass
Intended outboard sidewall	(a) The sidewall that contains a whitewall, bears white lettering, or bears manufacturer, brand, and/or model name molding that is higher or deeper than the same molding on the other sidewall of the tire, or (b) The outward facing sidewall of an asymmetrical tire that has a particular side that must always face outward when mounted on a vehicle
Light truck (LT) tire	A tire designated by its manufacturer as primarily intended for use on lightweight trucks or multipurpose passenger vehicles
Load rating	The maximum load that a tire is rated to carry for a given inflation pressure
Maximum load rating	The load rating for a tire at the maximum permissible inflation pressure for that tire

Tire related term	Meaning
Maximum permissible inflation pressure	The maximum cold inflation pressure to which a tire may be inflated
Measuring rim	The rim on which a tire is fitted for physical dimension requirements
Open splice	Any parting at any junction of tread, sidewall, or innerliner that extends to cord material
Outer diameter	The overall diameter of an inflated new tire
Overall width	The linear distance between the exteriors of the sidewalls of an inflated tire, including elevations due to labeling, decorations, or protective bands or ribs
Passenger car tire	A tire intended for use on passenger cars, multipurpose passenger vehicles, and trucks, that have a gross vehicle weight rating (GVWR) of 10,000 lb. or less.
Ply	A layer of rubber-coated parallel cords
Ply separation	A parting of rubber compound between adjacent plies
Pneumatic tire	A mechanical device made of rubber, chemicals, fabric and steel or other materials, that, when mounted on an automotive wheel, provides the traction and contains the gas or fluid that sustains the load
Radial ply tire	A pneumatic tire in which the ply cords that extend to the beads are laid at substantially 90 degrees to the centerline of the tread
Reinforced tire	A tire designed to operate at higher loads and at higher inflation pressures than the corresponding standard tire
Section width	The linear distance between the exteriors of the sidewalls of an inflated tire, excluding elevations due to labeling, decoration, or protective bands
Sidewall	That portion of a tire between the tread and bead

Tire related term	Meaning
Sidewall separation	The parting of the rubber compound from the cord material in the sidewall
Snow tire	A tire that attains a traction index equal to or greater than 110, compared to the ASTM E-1136 Standard Reference Test Tire, when using the snow traction test as described in ASTM F-1805-00, Standard Test Method for Single Wheel Driving Traction in a Straight Line on Snow-and Ice-Covered Surfaces, and which is marked with an Alpine Symbol (  ) on at least one sidewall
Test rim	The rim on which a tire is fitted for testing, and may be any rim listed as appropriate for use with that tire
Tread	That portion of a tire that comes into contact with the road
Tread rib	A tread section running circumferentially around a tire
Tread separation	Pulling away of the tread from the tire carcass
Treadwear indicators (TWI)	The projections within the principal grooves designed to give a visual indication of the degrees of wear of the tread
Wheel-holding fixture	The fixture used to hold the wheel and tire assembly securely during testing

\* : Table 1 - Occupant loading and distribution for vehicle normal load for various designated seating capacities

Designated seating capacity, Number of occupants	Vehicle normal load, Number of occupants	Occupant distribution in a normally loaded vehicle
2 through 4	2	2 in front
5 through 10	3	2 in front, 1 in second seat





Designated seating capacity, Number of occupants	Vehicle normal load, Number of occupants	Occupant distribution in a normally loaded vehicle
11 through 15	5	2 in front, 1 in second seat, 1 in third seat, 1 in fourth seat
16 through 20	7	2 in front, 2 in second seat, 2 in third seat, 1 in fourth seat

### Customizable features

Your vehicle includes a variety of electronic features that can be personalized to suit your preferences. The settings of these features can be changed using the multi-information display, the multimedia system screen or at your Toyota dealer.







### Customizing vehicle features

#### ■ Changing by using the multimedia system screen

- 1 Press .
- 2 Select  or .
- ▶ If the select .
- 3 Select "General" or "Car".
- 4 Select the preferred menu.

For details on the multimedia system, refer to the "MULTIMEDIA OWNER'S MANUAL".

#### ■ Changing by using the meter control switches

- 1 Press  or  of the meter control switch to select  or .
- 2 Press  or  of the meter control switch to select the desired item to be customized.
- 3 Press .

#### WARNING

##### ■ During customization

As the engine needs to be running during customization, ensure that the vehicle is parked in a place with adequate ventilation. In a closed area such as a garage, exhaust gases including harmful carbon monoxide (CO) may collect and enter the vehicle. This may lead to death or a serious health hazard.

#### NOTICE

##### ■ During customization

To prevent battery discharge, ensure that the engine is running while customizing features.

### Customizable features

Some function settings are changed simultaneously with other functions being customized. Contact your Toyota dealer for further details.

- A** Settings that can be changed using the multimedia system screen
- B** Settings that can be changed using the meter control switches
- C** Settings that can be changed by your Toyota dealer

Definition of symbols: O = Available, — = Not available



### ■ Alarm (→P.81)

Function	Default setting	Customized setting	A	B	C
Operation when doors are unlocked using the mechanical key	Off	On	—	—	O

### ■ Gauges, meters and multi-information display (→P.84, 88, 93)

Function <sup>*1</sup>	Default setting	Customized setting	A	B	C
Language	English	French	O	—	—
		Spanish	—	—	—
Units <sup>*2</sup>	miles, MPH, MPG	km, km/h, l/100 km	O	O	—
Clock	12H	24H	O	—	—
Startup screen	On	Off	O	O	—
GSI (Gear Shift Indicator) <sup>*3</sup>	On	Off	O	O	—
REV. (Indicator)	Off	On	O	O	—
REV. (rpm)	Off (2000 rpm)	2000 rpm—7400 rpm	O	O	—
REV. (Buzzer)	Off	On	O	O	—
Warning Volume <sup>*4</sup>	Mid	Min	O	O	—
		Max	—	—	—
Auto dimmer cancel	3	Off	—	—	O
		1 to 5	—	—	—

\*1: For details about each function: →P.98

\*2: The default setting varies according to country.

\*3: Vehicles with manual transmission

\*4: If equipped

■ **Smart key system and wireless remote control (→P.105, 107, 111)**

Function	Default setting	Customized setting	A	B	C
Operation buzzer	On	Off	<input type="radio"/>	<input type="radio"/>	<input type="radio"/>
Operation buzzer volume	5	Off	<input type="checkbox"/>	<input type="checkbox"/>	<input type="radio"/>
		1 to 7	<input type="checkbox"/>	<input type="checkbox"/>	<input type="radio"/>
Operation signal (Emergency flashers)	On	Off	<input type="radio"/>	<input type="radio"/>	<input type="radio"/>
Open door warning buzzer	On	Off	<input type="checkbox"/>	<input type="checkbox"/>	<input type="radio"/>
Open door battery discharge prevention function	On	Off	<input type="checkbox"/>	<input type="checkbox"/>	<input type="radio"/>

■ **Smart key system (→P.105, 107, 111)**

Function	Default setting	Customized setting	A	B	C
Door lock prevention function	On	Off	<input type="checkbox"/>	<input type="checkbox"/>	<input type="radio"/>
The doors that are unlocked using the smart key system can be selected	Driver's door	All the doors	<input type="radio"/>	<input type="radio"/>	<input type="radio"/>

■ **Wireless remote control (→P.102, 105, 107)**

Function	Default setting	Customized setting	A	B	C
Wireless remote control	On	Off	<input type="checkbox"/>	<input type="checkbox"/>	<input type="radio"/>
Trunk unlocking operation	Press and hold (short)	One short press	<input type="checkbox"/>	<input type="checkbox"/>	<input type="radio"/>
		Push twice	<input type="checkbox"/>	<input type="checkbox"/>	<input type="radio"/>
		Press and hold (long)	<input type="checkbox"/>	<input type="checkbox"/>	<input type="radio"/>
Panic function	On	Off	<input type="checkbox"/>	<input type="checkbox"/>	<input type="radio"/>
Vehicle finder function	On	Off	<input type="checkbox"/>	<input type="checkbox"/>	<input type="radio"/>

■ Trunk (→P.107)

Function	Default setting	Customized setting	A	B	C
Opening the trunk without an electronic key	On	Off	—	—	○

■ Turn signal lever (→P.155)

Function	Default setting	Customized setting	A	B	C
One-touch lane change function	On	Off	○	○	○

■ ASC (Active Sound Control) (→P.157)

Function	Default setting	Customized setting	A	B	C
ASC (Active Sound Control)	On	Off	—	—	○

■ Automatic light control system (→P.158)

Function	Default setting	Customized setting	A	B	C
Light sensor sensitivity	Mid	Min	○	○	○
		Low			
		High			
		Max			
Time that the welcome lighting system operates (when entering the vehicle)	30 seconds	60 seconds	○	○	○
		90 seconds			
		Off			
Time that the welcome lighting system operates (when exiting the vehicle)	30 seconds	60 seconds	○	○	○
		90 seconds			
		Off			
Windshield wiper linked headlight illumination	On	Off	○	○	○

### ■ Lights (→P.158)

Function	Default setting	Customized setting	A	B	C
Daytime running lights* <sup>1</sup>	On	Off	—	—	○
SRH (Steering Responsive Headlights)* <sup>2</sup>	On	Off	○	○	○

\*<sup>1</sup>: Except for Canada

\*<sup>2</sup>: If equipped

### ■ High Beam Assist\* (→P.162)

Function	Default setting	Customized setting	A	B	C
High Beam Assist	On	Off	—	—	○

\*: If equipped

### ■ EyeSight\* (→P.170)

Function	Default setting	Customized setting	A	B	C
Driving lane	Right lane	Left lane	○	○	—

\*: If equipped

### ■ Pre-Collision Braking System\* (→P.179)

Function	Default setting	Customized setting	A	B	C
PCB (Pre-Collision Braking System)	On	Off	○	○	—

\*: If equipped

### ■ Adaptive Cruise Control\* (→P.190)

Function	Default setting	Customized setting	A	B	C
Lead vehicle acquisition sound	On	Off	○	○	—

Function	Default setting	Customized setting	A	B	C
Cruise control acceleration level	Lv.3 (Standard)	Lv.1 (Eco)			
		Lv.2 (Comfort)	O	O	—
		Lv.4 (Dynamic)			

\*: If equipped

■ **LDW (Lane Departure Warning)\* (→P.220)**

Function	Default setting	Customized setting	A	B	C
LDW (Lane Departure Warning)	On	Off	O	O	—

\*: If equipped

■ **Lead Vehicle Start Alert\* (→P.224)**

Function	Default setting	Customized setting	A	B	C
Lead Vehicle Start Alert	On	Off	O	O	—

\*: If equipped

■ **Reverse Automatic Braking (RAB)\* (→P.240)**

Function	Default setting	Customized setting	A	B	C
Automatic Braking	On	Off	O	O	—
 (Sonar Audible Alarm)	On	Off	O	O	—

\*: If equipped

■ **BSD/RCTA\* (→P.232)**

Function	Default setting	Customized setting	A	B	C
BSD/RCTA	On	Off	O	O	—

\*: If equipped

### ■ Automatic air conditioning system (→P.270)

Function	Default setting	Customized setting	A	B	C
Time elapsed before the rear window defogger turn off	15 minutes	Continue	<input type="radio"/>	<input type="radio"/>	<input type="radio"/>

### ■ Illumination (→P.277)

Function	Default setting	Customized setting	A	B	C
Time elapsed before the interior lights turn off	15 seconds	7.5 seconds	<input type="radio"/>	<input type="radio"/>	<input type="radio"/>
		30 seconds			
Operation after the engine switch is turned off	On	Off	—	—	<input type="radio"/>
Operation when the doors are unlocked	On	Off	—	—	<input type="radio"/>
Operation when you approach the vehicle with the electronic key on your person	On	Off	—	—	<input type="radio"/>
Interior light illumination	On	Off	—	—	<input type="radio"/>

### ■ Vehicle customization

When the doors remain closed after unlocking the doors and the automatic door lock function is activated, the signals will be generated in accordance with the operation signal (buzzer) and the operation signal (emergency flashers) settings.

#### ■ In the following situations, customize mode in which the settings can be changed through the multi-information display will automatically be turned off

- A warning message appears after the customize mode screen is displayed
- The engine switch is turned off.
- The vehicle begins to move while

the customize mode screen is displayed.

**9-1. For owners**

- Reporting safety defects for U.S. owners..... 408
- Reporting safety defects for Canadian owners ..... 409
- Seat belt instructions for Canadian owners (in French)..... 409
- SRS airbag instructions for Canadian owners (in French)..... 411
- Headlight aim instructions for Canadian owners (in French)..... 422

**Reporting safety defects for U.S. owners**

**If you believe that your vehicle has a defect which could cause a crash or could cause injury or death, you should immediately inform the National Highway Traffic Safety Administration (NHTSA) in addition to notifying Toyota Motor Sales, U.S.A., Inc. (Toll-free: 1-800-331-4331).**

**If NHTSA receives similar complaints, it may open an investigation, and if it finds that a safety defect exists in a group of vehicles, it may order a recall and remedy campaign. However, NHTSA cannot become involved in individual problems between you, your dealer, or Toyota Motor Sales, U.S.A., Inc.**

**To contact NHTSA, you may call the Vehicle Safety Hotline toll-free at 1-888-327-4236 (TTY: 1-800-424-9153); go to <http://www.safercar.gov> ; or write to: Administrator, NHTSA, 1200 New Jersey Ave. SE., Washington, DC 20590. You can also obtain other information about motor vehicle safety from <http://www.safercar.gov>.**



### Reporting safety defects for Canadian owners

Canadian customers who wish to report a safety-related defect to Transport Canada, Defects Investigations and Recalls, may telephone the toll-free hotline 1-800-333-0510, mail Transport Canada - ASFAD, 330 Sparks Street, Ottawa, ON, K1A 0N5, or complete the online form at <https://www.tc.gc.ca/recalls>.

### Seat belt instructions for Canadian owners (in French)

**The following is a French explanation of seat belt instructions extracted from the seat belt section in this manual.**

**See the seat belt section for more detailed seat belt instructions in English.**

### Utilisation correcte des ceintures de sécurité

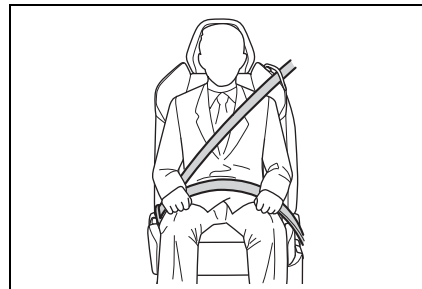

- Déroulez la sangle diagonale de telle sorte qu'elle passe bien sur l'épaule, sans pour autant être en contact avec le cou ou glisser de l'épaule.
- Placez la sangle abdominale le plus bas possible sur les hanches.
- Réglez la position du dossier de siège. Asseyez-vous le dos droit et calez-vous bien dans le siège.
- Ne vrillez pas la ceinture de

sécurité.

### **Entretien et soin**

#### **■ Traitement des ceintures de sécurité**

Nettoyez avec un chiffon ou une éponge humidifiés avec de l'eau savonneuse tiède. Vérifiez régulièrement que les ceintures ne sont pas usées, effilochées ou entaillées excessivement.

#### **AVERTISSEMENT**

##### **■ Détérioration et usure des ceintures de sécurité**

Inspectez le système de ceintures de sécurité régulièrement. Contrôlez l'absence de coupures, d'effilochages et de pièces desserrées. N'utilisez pas une ceinture de sécurité endommagée avant qu'elle ne soit remplacée. Une ceinture de sécurité endommagée ne permet pas de protéger un occupant de blessures graves ou mortelles.

## SRS airbag instructions for Canadian owners (in French)

The following is a French explanation of SRS airbag instructions extracted from the SRS airbag section in this manual.

See the SRS airbag section for more detailed SRS airbag instructions in English.

### Composants

#### ■ Emplacement des coussins gonflables SRS

Les coussins gonflables SRS se trouvent aux emplacements suivants.

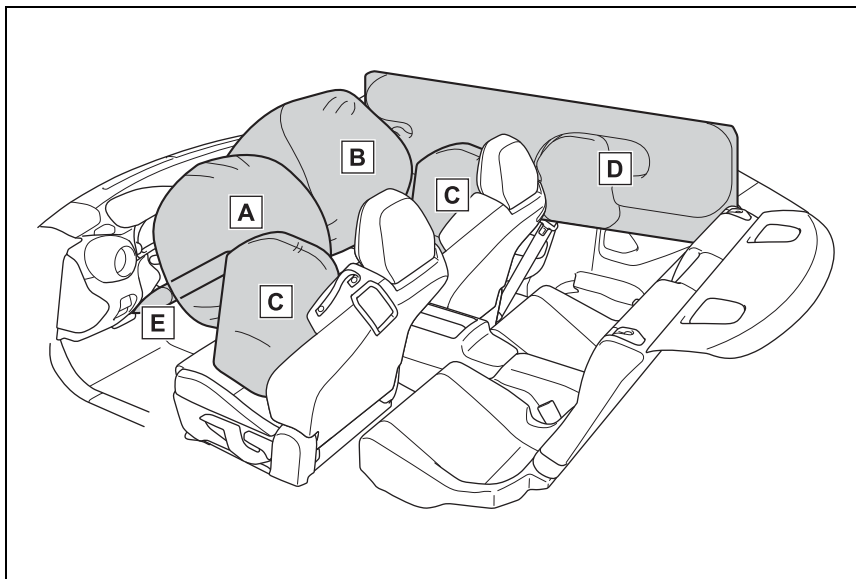

**A** Coussin gonflable frontal SRS du conducteur: dans la partie centrale du volant

Une inscription "SRS AIRBAG" est apposée sur la garniture du coussin gonflable.

**B** Coussin gonflable frontal SRS du passager avant: près du haut côté droit du tableau de bord

Une inscription "SRS AIRBAG" se trouve sur l'angle droit du tableau de bord.

- C** Coussin gonflable latéral SRS: dans le côté porte de chaque dossier de siège avant

Des marquages "SRS AIRBAG" sont apposés sur le côté porte de chaque assise de siège avant.

- D** Coussin gonflable rideau SRS: du côté toit (entre le montant avant et un point au-dessus du siège arrière)

Des marquages "SRS AIRBAG" sont apposés en haut de chaque montant central.

- E** Coussin gonflable de genoux SRS: sous la colonne de direction

Une inscription "SRS AIRBAG" est apposée au niveau du couvercle du coussin gonflable.

■ **Composants du système de coussins gonflables SRS**

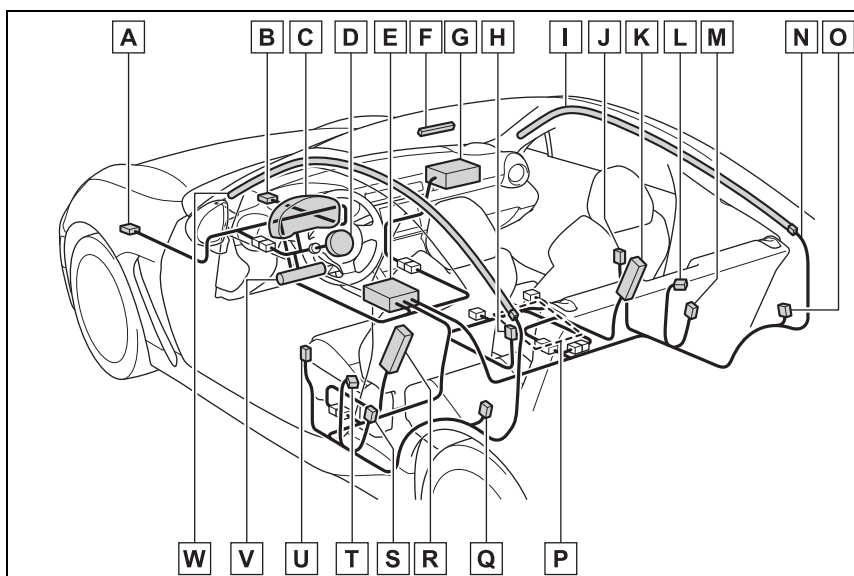

- A** Capteur d'impact avant (côté gauche)
- B** Capteur d'impact avant (côté droit)
- C** Témoin d'avertissement SRS
- D** Module de coussin gonflable frontal (côté conducteur)
- E** Module de commande de coussin gonflable (y compris capteur d'impact et capteur de retournement)
- F** Témoins ON et OFF du coussin gonflable frontal du passager avant
- G** Module de coussin gonflable frontal (côté passager avant)

- H** Contact de boucle de ceinture de sécurité (côté passager avant)
- I** Module de coussin gonflable rideau (côté droit)
- J** Capteur d'impact latéral (porte côté droit)
- K** Module de coussin gonflable latéral (côté passager avant)
- L** Prétensionneur de ceinture de sécurité et limiteur de force adaptatif (côté passager avant)
- M** Capteur d'impact latéral (côté droit du montant central)
- N** Câblage des coussins gonflables
- O** Capteur d'impact latéral (côté droit du passage de roue arrière)
- P** Capteur du système de détection de l'occupant du siège passager avant
- Q** Capteur d'impact latéral (côté gauche du passage de roue arrière)
- R** Module de coussin gonflable latéral (côté conducteur)
- S** Capteur d'impact latéral (côté gauche du montant central)
- T** Prétensionneur de ceinture de sécurité (côté conducteur)
- U** Capteur d'impact latéral (porte côté gauche)
- V** Module de coussin gonflable de genoux (côté conducteur)
- W** Module de coussin gonflable rideau (côté gauche)

**⚠ AVERTISSEMENT**

■ **Précautions générales concernant le système de coussins gonflables SRS**

- Pour obtenir une protection maximale en cas d'accident, le conducteur et tous les passagers doivent toujours porter leur ceinture de sécurité lorsqu'ils sont dans le véhicule. Les coussins gonflables SRS ne sont conçus que comme compléments à la protection première fournie par les ceintures de sécurité. Ils ne dispensent pas de la nécessité du port des ceintures de sécurité. En complément du port des ceintures de sécurité, ils offrent la meilleure protection en cas d'accident grave.

Ne pas porter la ceinture de sécurité augmente les risques de blessures graves ou mortelles lors d'un accident, même lorsque le véhicule est équipé de coussins gonflables SRS.

Pour les instructions d'utilisation et les précautions à prendre au sujet du système de ceintures de sécurité, reportez-vous à "ceintures de sécurité".

- Les coussins gonflables latéraux SRS et les coussins gonflables rideaux SRS ne sont conçus que comme compléments à la protection première fournie par la ceinture de sécurité. Ils ne suppriment pas la nécessité du port des ceintures de sécurité. Il est également important de porter une ceinture de sécurité pour prévenir les blessures qui peuvent survenir lorsqu'un occupant n'est pas assis dans une position droite correcte.

- Les coussins gonflables SRS se déploient à une vitesse et avec une puissance considérables. Les occupants qui sont mal assis lorsque le coussin gonflable SRS se déploie peuvent subir des blessures graves. Parce que le coussin gonflable SRS a besoin d'un espace suffisant pour son déploiement, le conducteur doit toujours se tenir droit et bien enfoncé dans le siège, le plus loin possible du volant, tout en conservant le contrôle complet du véhicule, et le passager avant doit déplacer son siège vers l'arrière aussi loin que possible, se tenir droit et bien en arrière dans le siège.

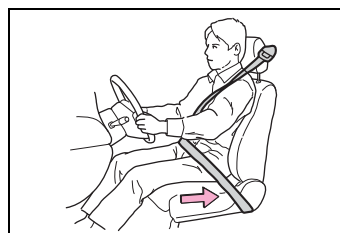

- Ne vous asseyez pas ou ne vous penchez pas près des portes. Les coussins gonflables latéraux SRS sont logés dans les deux dossiers des sièges avant à côté de la porte. Ils assurent leur protection en se déployant rapidement en cas de collision par le côté. Toutefois, la force de déploiement d'un coussin gonflable latéral SRS peut blesser un passager dont le corps est trop près du coussin gonflable SRS.



**⚠ AVERTISSEMENT**

- Votre véhicule étant équipé de coussins gonflables rideaux SRS, ne vous asseyez pas ou ne vous penchez pas près des portes. Ne passez pas de parties de votre corps par la vitre. Les coussins gonflables rideaux SRS des deux côtés de l'habitacle sont logés dans la partie latérale du toit (entre le montant avant et un point situé derrière la vitre de custode arrière). Ils assurent une protection en se déployant rapidement en cas de choc latéral, de retournement ou de collision frontale décalée. Toutefois, leur force de déploiement peut blesser un passager dont le corps est trop près du coussin gonflable SRS.
- Ne vous asseyez pas et ne vous penchez pas inutilement près des coussins gonflables SRS. Parce que les coussins gonflables SRS se déploient à une vitesse considérable et avec une puissance conçue pour vous protéger lors de collisions à haute vitesse, la puissance de déploiement d'un coussin gonflable peut blesser un occupant dont le corps en est trop proche. Il est également important de porter votre ceinture de sécurité pour prévenir les blessures qui peuvent survenir lorsque le coussin gonflable SRS entre en contact avec un occupant qui ne serait pas assis dans la position adéquate. Même en étant correctement positionné, il n'est pas impossible que l'occupant subisse des blessures mineures, telles que des brûlures et des ecchymoses sur le visage ou les bras, en raison de la puissance de déploiement des coussins gonflables SRS.

- Gardez les bras loin des portes ou de leur garniture interne. Ils pourraient être blessés en cas de déploiement d'un coussin gonflable latéral SRS.



- Ne placez pas d'objets au-dessus ou à proximité du cache du coussin gonflable SRS ou entre vous et le coussin gonflable SRS. En cas de déploiement du coussin gonflable SRS, ces objets pourraient interférer avec son fonctionnement correct et pourraient être propulsés à l'intérieur du véhicule et causer des blessures.

**■ En cas de déploiement d'un coussin gonflable SRS**

- Lorsque le coussin gonflable SRS se déploie, un peu de fumée est relâchée. Cette fumée peut causer des problèmes respiratoires pour les personnes ayant des antécédents d'asthme ou des difficultés à respirer. Si vous ou vos passagers éprouvez une difficulté à respirer après le déploiement du coussin gonflable SRS, prenez ou faites-leur prendre l'air rapidement.
- Un coussin gonflable SRS qui se déploie libère un gaz chaud. Les occupants pourraient se brûler s'ils entrent en contact direct avec le gaz chaud.

**⚠ AVERTISSEMENT**

**■ Précautions générales concernant le système de coussins gonflables SRS et les accessoires et objets de toute sorte**

- Ne mettez rien (notamment des sangles ou des cordons) sur le rembourrage du volant, le couvercle de la colonne ou le tableau de bord.
- Ils peuvent s’emmêler dans le volant et empêcher le bon fonctionnement du coussin gonflable frontal SRS, etc.
- Si le coussin gonflable frontal SRS se déploie, ces objets peuvent être projetés à l’intérieur du véhicule et provoquer des blessures.

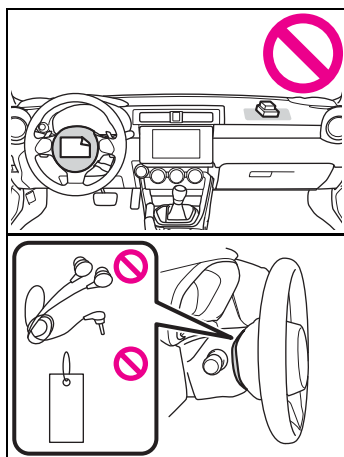

- Ne placez aucun objet sous le côté conducteur du tableau de bord. En cas de déploiement du coussin gonflable de genoux SRS, ces objets pourraient interférer avec son fonctionnement correct et pourraient être propulsés à l’intérieur du véhicule et causer des blessures.

- Ne fixez pas d’accessoires sur le pare-brise et ne placez pas de miroir extra-large sur le rétroviseur intérieur. Si le coussin gonflable SRS se déploie, ces objets peuvent devenir des projectiles susceptibles de blesser gravement les occupants du véhicule.

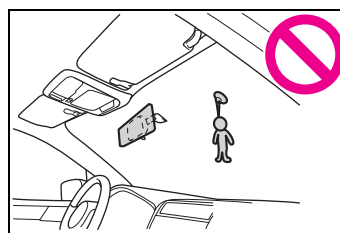

- Ne fixez pas d’accessoires sur la garniture de la porte ou à proximité des coussins gonflables latéraux SRS et ne placez pas d’objets à proximité des coussins gonflables latéraux SRS. En cas de déploiement des coussins gonflables latéraux SRS, ils pourraient être projetés dangereusement vers les occupants du véhicule et causer des blessures.

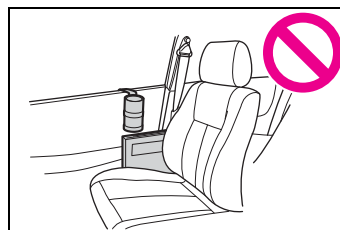



**⚠ AVERTISSEMENT**

- Ne fixez pas de microphone mains libres ou tout autre accessoire sur un montant avant, un montant central, un montant arrière, le pare-brise, une vitre latérale ou toute autre surface de l'habitacle qui se trouverait à proximité d'un coussin gonflable rideau SRS qui se déploie. Un microphone mains libres ou un autre accessoire placé à un tel endroit pourrait être propulsé à travers l'habitacle avec une grande force par le coussin gonflable rideau, ou pourrait empêcher le déploiement correct du coussin gonflable rideau. Dans les deux cas, le résultat peut être des blessures graves.
- Ne posez pas de vêtements ou d'autres objets sur le dossier du siège avant et ne collez pas d'étiquettes ou d'autocollants sur la surface du siège avant sur ou près de coussin gonflable latéral SRS. Ils pourraient empêcher le déploiement correct du coussin gonflable latéral SRS, réduisant ainsi la protection offerte à l'occupant du siège avant.

- N'installez pas de housse de siège sauf s'il s'agit d'une housse de siège d'origine Toyota exclusivement conçue pour être utilisée avec le coussin gonflable SRS. Même en utilisant une housse de siège d'origine Toyota, le système de coussin gonflable latéral SRS peut ne pas fonctionner normalement si la housse de siège n'est pas installée correctement.

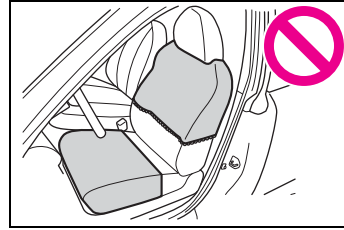

**⚠ AVERTISSEMENT**

■ **Précautions générales concernant le système de coussins gonflables SRS et les enfants**

- Placez les enfants sur le siège arrière en les attachant correctement à tout moment. Le coussin gonflable SRS se déploie à une vitesse et avec une force considérables et peut blesser ou même tuer des enfants, surtout s'ils ne sont pas ou mal attachés. Parce que les enfants sont plus légers et plus faibles que les adultes, le risque qu'ils courent d'être blessés par le déploiement est plus grand. Pour cette raison, nous recommandons fortement que TOUS les enfants (y compris ceux qui sont dans des sièges enfant) s'assoient sur le siège ARRIÈRE en étant correctement attachés tout le temps dans un siège de sécurité enfant ou avec une ceinture de sécurité, selon ce qui est approprié pour l'âge, la taille et le poids de l'enfant.

Attachez TOUS les types de sièges enfant (y compris les sièges enfants type face à la route) sur les sièges ARRIÈRE, en toutes circonstances.

Les statistiques relatives aux accidents prouvent que les enfants sont mieux protégés lorsqu'ils sont attachés correctement à l'arrière plutôt qu'à l'avant.

Pour les instructions d'utilisation et les précautions à prendre au sujet du siège enfant, reportez-vous à "Sièges de sécurité enfant".

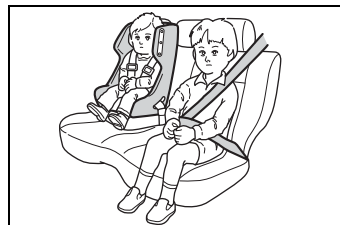

- **N'INSTALLEZ JAMAIS UN SIÈGE ENFANT SUR LE SIÈGE AVANT. NÉGLIGER CECI REVIENT À FAIRE COURIR LE RISQUE À L'ENFANT DE SUBIR DE GRAVES BLESSURES, VOIRE LA MORT, EN PLAÇANT LA TÊTE DE L'ENFANT TROP PRÈS DES COUSSINS GONFLABLES SRS.**

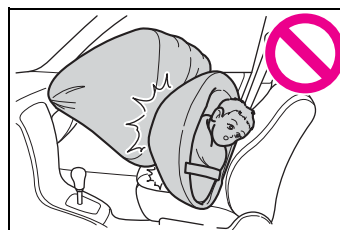

- **Ne laissez jamais un enfant se mettre debout ou à genoux sur le siège passager avant. Le coussin gonflable SRS se déploie avec une force considérable et peut blesser ou tuer l'enfant.**

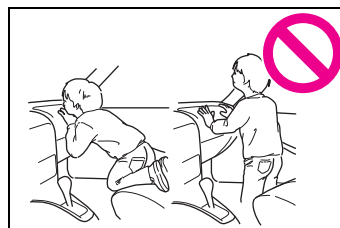

**⚠ AVERTISSEMENT**

- Ne tenez jamais un enfant sur vos genoux ou dans vos bras. Le coussin gonflable SRS se déploie avec une force considérable et peut blesser ou tuer l'enfant.

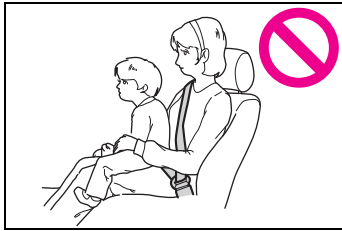

- Ne laissez jamais un enfant faire ce qui suit.
- S'agenouiller sur n'importe quel siège de passager face à la fenêtre latérale
- Enrouler ses bras autour du dossier du siège avant
- Mettre sa tête, ses bras ou d'autres parties de son corps hors de la fenêtre

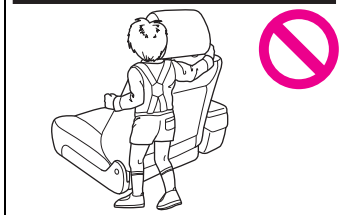

En cas d'accident, la force de déploiement du coussin gonflable latéral SRS et/ou du coussin gonflable rideau SRS peut blesser gravement l'enfant parce que sa tête, ses bras ou d'autres parties de son corps sont trop proches du coussin gonflable latéral SRS et/ou du coussin gonflable rideau SRS.

- Comme votre véhicule est également équipé d'un coussin gonflable frontal SRS du passager avant, les enfants doivent être placés sur le siège arrière et doivent être correctement attachés en permanence.

**■ Entretien du système de coussins gonflables SRS**

Le coussin gonflable SRS ne comporte aucune pièce réparable par l'utilisateur. N'utilisez pas d'équipement de test électrique sur un circuit lié au système de coussin gonflable SRS. Pour l'entretien requis du coussin gonflable SRS, consultez votre concessionnaire Toyota le plus proche. L'altération ou la déconnexion du câblage du système peut entraîner le gonflage accidentel d'un coussin gonflable SRS ou rendre le système inopérant, ce qui peut entraîner des blessures graves.

**■ Précautions relatives aux modifications du véhicule**

- Afin d'éviter le déclenchement accidentel du système ou de rendre le système inopérant, ce qui peut entraîner des blessures graves, aucune modification ne doit être apportée aux composants ou au câblage du système de coussins gonflables SRS. Cela inclut les modifications suivantes.

 **AVERTISSEMENT**

- Installation de volants personnalisés
- Fixation de matériaux de garniture supplémentaires au tableau de bord
- Installation de sièges personnalisés
- Remplacement du tissu ou du cuir de siège
- Installation de tissu ou de cuir supplémentaire sur le siège avant
- Ne fixez pas un microphone mains libres ou de tout autre accessoire sur un montant avant, un montant central, un montant arrière, le pare-brise, une vitre latérale, une poignée d'assistance ou toute autre surface de l'habitacle qui se trouverait à proximité d'un coussin gonflable rideau SRS qui se déploie.
- Il est déconseillé d'installer un équipement électrique/électronique supplémentaire, tel qu'une radio mobile bidirectionnelle, sur ou à proximité des composants et/ou du câblage du système de coussins gonflables SRS. Cela pourrait nuire au bon fonctionnement du système de coussins gonflables SRS.
- Modifications sur ou à l'intérieur des panneaux de porte en vue du remplacement d'un haut-parleur ou de l'isolation acoustique

- Les capteurs d'impact, qui détectent la pression d'un impact, sont situés dans les portes. Ne modifiez aucun élément des portes ou des garnitures de porte, comme l'ajout de haut-parleurs de porte par exemple. Toute modification des portes entraîne un risque de dysfonctionnement du système de coussins gonflables ou de déploiement involontaire de coussins gonflables.
- N'effectuez pas l'une des opérations suivantes. De telles modifications peuvent nuire au bon fonctionnement du système de coussins gonflables SRS.
- Fixation d'un équipement (barre d'appui, treuils, chasse-neige, plaque de protection, etc.) autre que des pièces accessoires Toyota d'origine sur le train avant.
- Modification du système de suspension ou de la structure avant.
- Installation d'un pneu de taille et de construction différentes des pneus spécifiés sur la plaque d'identification du véhicule fixée au montant central du conducteur ou spécifiés pour les modèles de véhicules individuels dans ce Manuel du propriétaire.
- Fixation de tout équipement (marchepieds latéraux ou protections de bas de caisse, etc.) autre que des pièces accessoires d'origine Toyota sur la carrosserie latérale.

Consultez toujours votre concessionnaire Toyota si vous souhaitez installer des pièces accessoires sur votre véhicule.

### Moniteurs du système de coussins gonflables SRS

Un système de diagnostic contrôle en permanence l'état de préparation du système de coussins gonflables SRS (y compris les prétensionneurs de ceintures de sécurité) lorsque le contact du moteur est sur ON. Le témoin d'avertissement du système SRS indique le fonctionnement normal du système en s'allumant pendant environ 6 secondes lorsque vous placez le contact du moteur sur ON.

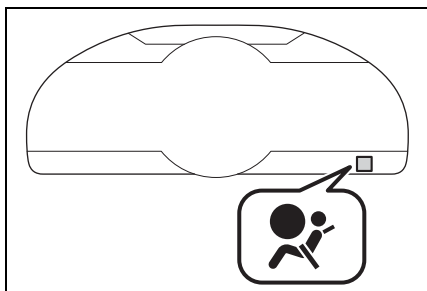

Les composants suivants sont contrôlés par le témoin:

- Capteur d'impact avant
  - Côté droit
  - Côté gauche
- Module de commande de coussin gonflable (y compris capteur d'impact et capteur de retournement)
- Module de coussin gonflable frontal
  - Côté conducteur
- Côté passager avant
- Module de coussin gonflable de genoux
- Côté conducteur
- Capteur d'impact latéral
- Montant central côté gauche
- Montant central côté droit
- Passage de roue arrière côté gauche avant ou arrière
- Passage de roue arrière côté droit avant ou arrière
- Porte côté gauche
- Porte côté droit
- Module de coussin gonflable latéral
- Côté conducteur
- Côté passager avant
- Module de coussins gonflables rideaux
- Côté droit
- Côté gauche
- Prétensionneur de ceinture de sécurité
- Côté conducteur
- Prétensionneur de ceinture de sécurité et limiteur de force adaptatif
- Côté passager avant
- Contact de boucle de ceinture de sécurité
- Côté passager avant
- Capteurs du système de détection de l'occupant du siège passager avant
- Témoins ON et OFF du coussin

sin gonflable frontal du passager avant

- Tous les câblages associés

**⚠ AVERTISSEMENT**

■ **Témoin d'avertissement SRS**

Si le témoin d'avertissement présente l'une des conditions suivantes, arrêtez immédiatement le véhicule dans un lieu sûr et consultez un concessionnaire Toyota. Si un technicien ne vérifie pas et ne répare pas le système si nécessaire, les prétensionneurs de ceinture de sécurité et/ou le coussin gonflable SRS peuvent ne pas fonctionner correctement en cas de collision, ce qui peut entraîner des blessures.

- Clignotement du témoin d'avertissement
- Le témoin d'avertissement ne s'allume pas lorsque le contact du moteur est d'abord placé sur ON
- Le témoin d'avertissement reste allumé en permanence
- Le témoin d'avertissement s'allume pendant la conduite

**Headlight aim instructions for Canadian owners (in French)**

The following is a French explanation of headlight aim instructions from the headlight aim section in this manual.

**Boulons de réglage du mouvement vertical**

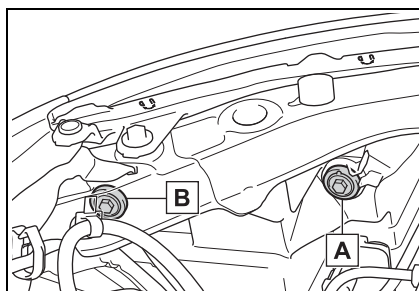

- A** Boulon de réglage A
- B** Boulon de réglage B

**Avant de vérifier le réglage des phares**

- Vérifiez que le réservoir de carburant du véhicule est plein et que la zone autour des phares n'est pas déformée.
- Stationnez le véhicule sur une surface plane.
- Assurez-vous que la pression de gonflage des pneus est au niveau recommandé.

- Faites asseoir quelqu'un dans le siège conducteur.
- Balancez le véhicule plusieurs fois.

### Réglage du faisceau des phares

- 1 À l'aide d'un tournevis cruciforme, tournez le boulon A dans n'importe quel sens.

Mémorisez le sens dans lequel vous avez tourné et le nombre de tours.

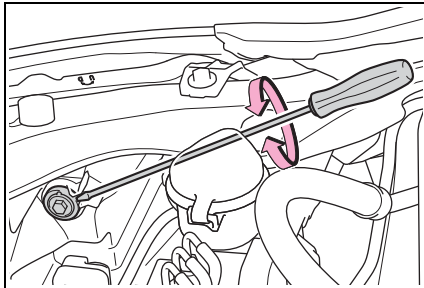

- 2 Tournez le boulon B du même nombre de tours dans le même sens qu'à l'étape 1.

Si vous n'arrivez pas à régler le phare en procédant de la sorte, confiez le véhicule à votre concessionnaire Toyota pour qu'il règle le faisceau des phares.

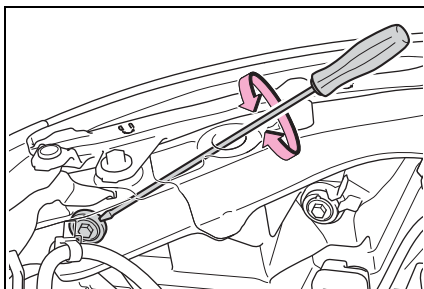





**Index**

425

What to do if... (Trouble-  
shooting) ..... 426  
Alphabetical Index..... 429

## What to do if... (Troubleshooting)

**If you have a problem, check the following before contacting your Toyota dealer.**

**The doors cannot be locked, unlocked, opened or closed**



**You lose your keys**

- If you lose your mechanical keys, new genuine mechanical keys can be made by your Toyota dealer. (→P.369)
- If you lose your electronic keys, the risk of vehicle theft increases significantly. Contact your Toyota dealer immediately. (→P.369)



**The electronic key does not operate properly**

- Is the electronic key battery weak or depleted? (→P.328)



**The doors cannot be locked or unlocked**

- Is the engine switch in ON?
- When locking the doors, turn the engine switch off. (→P.147)
- Is the electronic key left inside the vehicle?

When locking the doors, make sure that you have the electronic key on your person.

- The function may not operate properly due to the condition of the radio wave. (→P.112)



**The trunk lid is closed with the electronic key left inside**

- The function to prevent the electronic key from being left inside the trunk will operate and you can open the trunk as usual. Take the key out from the trunk. (→P.110)

**If you think something is wrong**



**The engine does not start**

- Automatic transmission: Did you press the engine switch while firmly depressing the brake pedal? (→P.145)
- Manual transmission: Did you press the engine switch while firmly depressing the clutch pedal? (→P.145)
- Automatic transmission: Is the shift lever in P? (→P.145)
- Is the electronic key anywhere detectable inside the vehicle? (→P.111)

- Is the steering wheel unlocked? (→P.145)
- Is the electronic key battery weak or depleted?

In this case, the engine can be started in a temporary way. (→P.370)

- Is the battery discharged? (→P.372)



**The shift lever cannot be shifted from P even if you depress the brake pedal (Automatic transmission)**

- Is the engine switch in ON?

If you cannot release the shift lever by depressing the brake pedal with the engine switch in ON. (→P.150)



**The steering wheel cannot be turned after the engine is stopped**

- It is locked automatically to prevent theft of the vehicle. (→P.145)



**The windows do not open or close by operating the power window switches**

- Is the window lock switch pressed?

The power window except for the one at the driver's seat cannot be operated if the window lock switch is pressed. (→P.130)



**The engine switch is turned off automatically**

- The auto power off function will be operated if the vehicle is left in ACC or ON (the engine is not running) for a period of time. (→P.148)



**A warning buzzer sounds during driving**

- The seat belt reminder light is flashing

Are the driver and the passenger wearing the seat belts? (→P.351)

- The brake system warning light is on

Is the parking brake released? (→P.156)

Depending on the situation, other types of warning buzzer may also sound. (→P.348, 357)



**An alarm is activated and the horn sounds**

- Did anyone inside the vehicle open a door during setting the alarm?

The sensor detects it and the alarm sounds. (→P.81)

Do one of the following to deactivate or stop the alarm:

- Unlock the doors or open the trunk using the entry function or wireless remote control.
- Open the trunk using the entry function or wireless remote control.

- Turn the engine switch to ACC or ON, or start the engine.



**A warning buzzer sounds when leaving the vehicle**

- Is the message displayed on the multi-information display?

Check the message on the multi-information display. (→P.357)



**A warning light turns on or a warning message is displayed**

- When a warning light turns on or a warning message is displayed, refer to P.348, 357.

**When a problem has occurred**



**If you have a flat tire**

- Stop the vehicle in a safe place and repair the flat tire temporarily with the emergency tire puncture repair kit. (→P.358)



**The vehicle becomes stuck**

- Try the procedure for when the vehicle becomes stuck in mud, dirt, or snow. (→P.377)

## Alphabetical Index

### A

<b>A/C</b>	
Air conditioning filter .....	327
Automatic air conditioning system .....	270
<b>ABS (Anti-lock Brake System)</b>	
.....	262
Warning light .....	349
<b>Active Sound Control (ASC)..</b>	157
<b>Adaptive Cruise Control .....</b>	190
Warning message .....	357
<b>Air conditioning filter .....</b>	327
<b>Air conditioning system</b>	
Air conditioning filter .....	327
Automatic air conditioning system .....	270
<b>Airbags</b>	
Correct driving posture .....	23
Front passenger occupant classification system .....	56
Locations of airbags .....	29
SRS airbags .....	29
SRS warning light.....	349
<b>Alarm .....</b>	81
Warning buzzer .....	348
<b>Anchor brackets .....</b>	66, 73
<b>Antennas (smart key system)</b>	111
<b>Anti-lock Brake System (ABS)</b>	
.....	262
Warning light .....	349
<b>ASC (Active Sound Control)..</b>	157
<b>Audio system-linked display... </b>	98
<b>Automatic air conditioning system .....</b>	270
<b>Automatic headlight leveling system.....</b>	159
<b>Automatic light control system .....</b>	159
<b>Automatic transmission .....</b>	149
Manual mode .....	152
Paddle shift switches....	151, 152

<b>Auxiliary box .....</b>	282
<b>Auxiliary boxes .....</b>	281
<b>Average fuel consumption .....</b>	94
<b>Average vehicle speed .....</b>	94

### B

<b>Back-up light</b>	
Replacing light bulbs .....	334
Wattage .....	387
<b>Battery</b>	
Battery checking .....	309
If the battery is discharged ...	372
Preparing and checking before winter .....	266
Warning light.....	348
<b>Blind Spot Detection (BSD) ...</b>	232
<b>Bottle holders .....</b>	280
<b>Brake</b>	
Fluid.....	385
Parking brake .....	156
Warning light.....	348
<b>Brake assist .....</b>	262
<b>Break-in tips.....</b>	133
<b>Brightness control</b>	
Instrument panel light control .	91
<b>BSD (Blind Spot Detection) ...</b>	232

### C

<b>Camera</b>	
High Beam Assist system .....	162
<b>Care</b>	
Exterior .....	288
Interior .....	291, 293
Seat belts .....	291
Ultrasuede® .....	293
Wheels and wheel ornaments .....	288
<b>Cargo capacity .....</b>	143
<b>Chains.....</b>	268
<b>Child restraint system</b>	
Fixed with a LATCH system ...	71

Fixed with a seat belt ..... 67  
 Front passenger occupant clas-  
 sification system..... 56  
 Points to remember..... 64  
 Riding with children ..... 63  
 Types of child restraint system  
 installation method ..... 66  
 Using an anchor bracket ..... 73

**Child safety**  
 Battery precautions ..... 311, 374  
 Child restraint system..... 66  
 How your child should wear the  
 seat belt..... 26  
 Power window lock switch.... 130  
 Removed electronic key battery  
 precautions..... 329  
 Seat belt precautions ..... 63  
 Seat heater precautions ..... 276  
 Trunk precautions..... 107

**Cleaning**  
 Exterior ..... 288  
 Interior ..... 291, 293  
 Seat belts ..... 291  
 Wheels and wheel ornaments  
 ..... 288

**Clock** ..... **88, 91**  
**Condenser** ..... **308**  
**Console box**..... **280**  
**Conventional Cruise Control** **207,**  
**255**  
**Cooling system** ..... **307**  
 Engine overheating ..... 375

**Cruise control**  
 Adaptive Cruise Control ..... 190  
 Conventional Cruise Control **207,**  
**255**

**Cup holders** ..... **281**  
**Current fuel consumption** ..... **94**  
**Curtain shield airbags** ..... **29**  
**Customizable features** ..... **400**

**D**

**Daytime running light system** **158**  
**Daytime running lights**  
 Replacing light bulbs ..... 334

**Defogger**  
 Outside rear view mirrors ..... 272  
 Rear window ..... 272  
 Windshield ..... 272

**Dimension** ..... **380**  
**Dinghy towing** ..... **144**

**Display**  
 Driving information ..... 94  
 Multi-information display ..... 93

**Display change button** ..... **90**  
**Do-it-yourself maintenance** ... **296**  
**Door courtesy lights**..... **277**

**Door lock**  
 Doors ..... 105  
 Smart key system ..... 111  
 Wireless remote control ..... 103

**Doors**  
 Door glasses ..... 129  
 Door lock ..... 105  
 Open door warning buzzer ... 106  
 Open door warning light ..... 351  
 Outside rear view mirrors ..... 127

**Driving**  
 Break-in tips ..... 133  
 Correct driving posture ..... 23  
 Driving mode select switch ... 258  
 Procedures ..... 132  
 Winter drive tips ..... 266

**Driving distance**..... **94**  
**Driving information** ..... **94**  
**Driving information display** ..... **94**  
**Driving range** ..... **94**  
**Driving time**..... **94**

**E**

**EDR (Event data recorder)**..... **7**

<b>Electric Power Steering (EPS)</b>	
.....	<b>262</b>
Warning light .....	350
<b>Electronic key</b> .....	<b>102</b>
Battery-saving function.....	112
If the electronic key does not operate properly .....	370
Replacing the battery .....	328
<b>Emergency flashers</b> .....	<b>338</b>
<b>Emergency tire puncture</b> .....	<b>358</b>
<b>Emergency, in case of</b>	
If a warning buzzer sounds ..	348
If a warning light turns on ....	348
If a warning message is dis- played.....	357
If the battery is discharged ...	372
If the electronic key does not operate properly .....	370
If the engine will not start ....	367
If the fuel filler door cannot be opened .....	369
If the vehicle is submerged or water on the road is rising ..	339
If you have a flat tire .....	358
If you lose your keys .....	369
If you think something is wrong .....	346
If your vehicle becomes stuck .....	377
If your vehicle has to be stopped in an emergency.....	338
If your vehicle needs to be towed .....	341
If your vehicle overheats .....	375
<b>Engine</b>	
ACCESSORY mode.....	147
Compartment .....	305
Engine switch .....	145
Fuel pump shut off system ...	347
Hood.....	302
How to start the engine .....	145
Identification number.....	381
If the engine will not start.....	367
If your vehicle has to be stopped in an emergency.....	338
Ignition switch (engine switch) .....	145
Overheating .....	375
Tachometer.....	88
<b>Engine coolant</b>	
Capacity .....	383
Checking .....	307
Preparing and checking before winter.....	266
<b>Engine coolant temperature gauge</b> .....	<b>88</b>
<b>Engine immobilizer system</b> .....	<b>80</b>
<b>Engine oil</b>	
Capacity .....	382
Checking .....	305
Preparing and checking before winter.....	266
Warning light.....	349
<b>Engine oil temperature gauge</b> ..	<b>94</b>
<b>Engine switch</b> .....	<b>145</b>
Auto power off function.....	148
Changing the engine switch modes.....	147
If your vehicle has to be stopped in an emergency.....	338
<b>EPS (Electric Power Steering)</b> .....	<b>262</b>
Warning light.....	350
<b>Event data recorder (EDR)</b> .....	<b>7</b>
<b>EyeSight</b> .....	<b>170</b>
Adaptive Cruise Control .....	190
Conventional Cruise Control	207
Lane Departure Warning .....	220
Lane Sway Warning .....	222
Lead Vehicle Start Alert .....	224
Malfunction .....	228
Pre-Collision Braking System .....	179

Pre-Collision Throttle Management .....215  
 Temporary stop .....228

**F****Flat tire**

Tire pressure warning system .....315  
 Vehicles without a spare tire 358

**Floor mats .....22**

**Fluid**

Automatic transmission .....384  
 Brake .....308, 385  
 Clutch .....308  
 Manual transmission .....385  
 Washer .....311

**Front passenger occupant classification system .....56**

**Front position lights**

Wattage .....387

**Front seats**

Adjustment .....119  
 Cleaning .....291, 293  
 Correct driving posture .....23  
 Head restraints .....123  
 Seat heaters .....276

**Front side marker light**

Light switch .....158

**Front turn signal lights**

Replacing light bulbs .....334  
 Turn signal lever .....155  
 Wattage .....387

**Fuel**

Capacity .....381  
 Fuel gauge .....88  
 Fuel pump shut off system ...347  
 Information .....388  
 Refueling .....167  
 Type .....381  
 Warning light .....351

**Fuel filler door**

If the fuel filler door cannot be opened .....369  
 Refueling .....167

**Fuel gauge .....88**

**Fuel pump shut off system ....347**

**Fuses .....330**

**G**

**Gauges .....88**

**G-force .....96**

**Glove box .....279**

**H**

**Head restraints .....123**

**Headlight aim .....332**

**Headlights**

High Beam Assist system ....162  
 Light switch .....158  
 Replacing light bulbs .....334  
 Wattage .....387

**Heaters**

Automatic air conditioning system .....270  
 Outside rear view mirrors ....272  
 Seat heaters .....276

**High Beam Assist .....162**

**High mounted stoplight**

Replacing light bulbs .....334

**Hill-start assist control .....262**

**Hood**

Open .....302

**Hooks**

Retaining hooks (floor mat) ....22

**Horn .....125**

**I**

**I/M test .....299**

**Identification**

Engine .....381



Vehicle.....380

**Ignition switch (engine switch)**  
..... 145

Auto power off function ..... 148

Changing the engine switch  
modes ..... 147

If your vehicle has to be stopped  
in an emergency.....338

**Illuminated entry system** .....277

**Indicators** .....85

**Initialization**

Power windows ..... 129

Tire pressure warning system  
.....317

**Inside rear view mirror**..... 126

**Instrument panel light control**.91

**Interior lights** .....277

**J**

**Jack**

Positioning a floor jack ..... 303

Vehicle-equipped jack ..... 359

**Jack handle**..... 359

**Jam protection function**

Power windows ..... 129

**K**

**Keyless entry**

Smart key system..... 111

Wireless remote control ..... 103

**Keys**

Battery-saving function..... 112

Electronic key ..... 102

Engine switch ..... 145

If the electronic key does not  
operate properly ..... 370

If you lose your keys ..... 369

Key number plate ..... 102

Keyless entry..... 105, 111

Mechanical key ..... 102

Replacing the battery ..... 328

Warning buzzer ..... 111

Wireless remote control.....103

**Knee airbags**.....29

**L**

**Lane Departure Warning** .....220

**Lane Sway Warning**.....222

**Language (multi-information display)** .....98

**LATCH anchors**.....71

**Lead Vehicle Start Alert** .....224

**Lever**

Auxiliary catch lever .....302

Hood lock release lever .....302

Shift lever ..... 149, 153

Turn signal lever .....155

Wiper lever ..... 165

**License plate lights**

Light switch.....158

Replacing light bulbs .....334

**Light**

Wattage .....387

**Light bulbs**

Replacing .....333

**Lights**

Headlight switch .....158

High Beam Assist system.....162

Interior lights .....277

Interior lights list .....277

Replacing light bulbs .....334

Trunk light..... 110

Turn signal lever .....155

Vanity lights .....284

Wattage .....387

Welcome light illumination control .....160

**Lock steering column** .....145

**M**

**Maintenance**

Do-it-yourself maintenance ..300

General maintenance .....	296
Maintenance date.....	380
Maintenance requirements...	295
<b>Malfunction indicator lamp....</b>	<b>349</b>
<b>Manual transmission .....</b>	<b>153</b>
<b>Master warning light .....</b>	<b>353</b>
<b>Menu icons .....</b>	<b>93</b>
<b>Meter</b>	
Clock .....	88
Indicators.....	85
Instrument panel light control .	91
Meters .....	88
Multi-information display .....	93
Settings .....	98
Warning lights.....	348
Warning messages.....	357
<b>Mirrors</b>	
Inside rear view mirror.....	126
Outside rear view mirror defog-	
gers .....	272
Outside rear view mirrors .....	127
Vanity mirrors .....	284
<b>Multi-information display.....</b>	<b>93</b>
Audio system-linked display...	98
Driving information .....	94
Menu icons.....	93
Meter control switches .....	94
Navigation system-linked display	
.....	98
Pop-up display .....	93
Settings .....	98
Sport information.....	96
Tire pressure .....	315
Warning messages.....	357

**N**

<b>Navigation system-linked display</b>	<b>98</b>
<b>Noise from under vehicle .....</b>	<b>5</b>

**O**

<b>Odometer.....</b>	<b>90</b>
<b>Odometer and trip meter display</b>	
Display change button .....	90
Display items .....	91
<b>Oil</b>	
Engine oil.....	382
<b>Opener</b>	
Fuel filler door.....	167
Hood.....	302
Trunk .....	109
<b>Outside rear view mirrors</b>	
Adjustment .....	127
BSD (Blind Spot Detection) ..	232
Folding.....	127
Outside rear view mirror defog-	
gers .....	272
RCTA function.....	232
<b>Outside temperature .....</b>	<b>88</b>
<b>Overheating.....</b>	<b>375</b>

**P**

<b>Paddle shift switches .....</b>	<b>151, 152</b>
<b>Panic mode .....</b>	<b>103</b>
<b>Parking brake</b>	
Operation.....	156
<b>Parking lights</b>	
Light switch.....	158
Replacing light bulbs .....	334
<b>Power and torque curve.....</b>	<b>96</b>
<b>Power outlets .....</b>	<b>284</b>
<b>Power steering (Electric power</b>	
<b>steering system).....</b>	<b>262</b>
Warning light.....	350
<b>Power windows</b>	
Jam protection function .....	129
Operation.....	129
Window lock switch .....	130
<b>Pre-Collision Braking System</b>	<b>179</b>
Function.....	179
Warning message.....	357

**Pre-Collision Throttle Management.....215**

**R**

**RAB (Reverse Automatic Braking).....240**

**Radiator.....308**

**RCTA**

Function .....232

**RCTA (Rear Cross Traffic Alert).....232**

**Rear seats .....121**

**Rear side marker lights**

Light switch .....158

**Rear turn signal lights**

Replacing light bulbs .....334

Turn signal lever.....155

Wattage.....387

**Rear view camera.....250**

**Rear view mirror**

Inside rear view mirror.....126

Outside rear view mirrors ....127

**Rear window defogger.....272**

**Refueling**

Capacity .....381

Fuel types.....381

If the fuel filler door cannot be opened .....369

Opening the fuel tank cap ....167

**Replacing**

Electronic key battery.....328

Fuses .....330

Light bulbs.....333

Tires .....319

**REV indicator.....89**

**Reverse Automatic Braking**

(RAB).....240

**S**

**Safety Connect .....75**

**Seat belt reminder light .351, 352**

**Seat belts.....25**

Automatic Locking Retractor ..27

Child restraint system installation .....66

Cleaning and maintaining the seat belt.....291

Emergency Locking Retractor 27

How to wear your seat belt.....26

How your child should wear the seat belt.....26

Pregnant women, proper seat belt use .....25

Reminder light and buzzer .351, 352

Seat belt pretensioners .....27

SRS warning light.....349

**Seat heaters .....276**

**Seating capacity .....143**

**Seats**

Adjustment .....119

Child seats/child restraint system installation .....64

Cleaning .....291, 293

Head restraints .....123

Properly sitting in the seat .....23

Seat heaters .....276

**Sensor**

Automatic headlight system .159

BSD (Blind Spot Detection) ..232

**Shift lever**

Automatic transmission .....149

Manual transmission .....153

**Side airbags .....29**

**Side marker lights**

Light switch.....158

Replacing light bulbs .....334

**Side mirrors**

Adjustment .....127

BSD (Blind Spot Detection) ..232

Folding.....127

RCTA function.....232

- Side turn signal lights**
  - Turn signal lever..... 155
  - Wattage.....387
- Side windows ..... 129**
- Smart key system**
  - Antenna location ..... 111
  - Entry functions ..... 105
  - Starting the engine ..... 145
  - Warning message ..... 357
- Snow tires ..... 266**
- Specifications ..... 380**
- Speedometer ..... 88**
- Steering lock**
  - Column lock release..... 145
  - Steering lock system warning message..... 145
- Steering wheel**
  - Adjustment ..... 125
  - Meter control switches ..... 94
- Stop lights**
  - Replacing light bulbs ..... 334
  - Wattage ..... 387
- Stopwatch ..... 96**
- Storage features ..... 279**
- Stuck**
  - If the vehicle becomes stuck 377
- Sun visors ..... 284**
- Switch**
  - Meter control switches ..... 94
- Switches**
  - Display change button..... 90
  - Door lock switches ..... 106
  - Driving mode select switch... 258
  - Emergency flashers switch .. 338
  - Engine switch ..... 145
  - Ignition switch..... 145
  - Instrument panel light control switches ..... 91
  - Light switches..... 158
  - Outside rear view mirror switches ..... 127
  - Paddle shift switches.... 151, 152
  - Power door lock switch..... 106
  - Power window switches ..... 129
  - Rear window and outside rear view mirror defoggers switch ..... 270
  - Seat heater switches ..... 276
  - “SOS” button ..... 75
  - Tilt and telescopic steering control switch ..... 125
  - Tire pressure warning reset switch ..... 317
  - Trunk opener switch ..... 109
  - VSC OFF switch..... 262
  - Window lock switch ..... 130
  - Windshield wiper and washer switch ..... 165

**T**

- Tachometer ..... 88**
  - REV indicator ..... 89
- Tail lights**
  - Light switch..... 158
  - Replacing light bulbs ..... 334
  - Wattage ..... 387
- Theft deterrent system**
  - Alarm ..... 81
  - Engine immobilizer system.... 80
- Tire inflation pressure**
  - Maintenance data ..... 386
  - Tire inflation pressure display function..... 315
  - Warning light..... 354
- Tire information ..... 390**
  - Glossary ..... 393
  - Size ..... 391
  - Tire identification number ..... 391
  - Uniform Tire Quality Grading 392
- Tire pressure display ..... 315**
- Tire pressure warning system**
  - Function..... 315
  - Initializing..... 317

Installing tire pressure warning valves and transmitters ..... 316  
 Registering ID codes ..... 318  
 Warning light ..... 354

**Tires**

Chains ..... 268  
 Checking ..... 312  
 Emergency tire puncture repair kit ..... 358  
 If you have a flat tire ..... 358  
 Inflation pressure ..... 323  
 Information ..... 390  
 Replacing ..... 319  
 Rotating tires ..... 314  
 Size ..... 386  
 Snow tires ..... 266  
 Tire inflation pressure display function ..... 315  
 Tire pressure warning system ..... 315  
 Warning light ..... 354

**Tools** ..... 359

**Top tether strap** ..... 73

**Total load capacity** ..... 380

**Towing**

Dinghy towing ..... 144  
 Emergency towing ..... 341  
 Towing eyelet ..... 343  
 Trailer towing ..... 143

**TRAC (Traction Control)** ..... 262

**Traction Control (TRAC)** ..... 262

**Trailer towing** ..... 143

**Transmission**

Automatic transmission ..... 149  
 Driving mode select switch ..... 258  
 Manual mode ..... 152  
 Manual transmission ..... 153  
 Paddle shift switches ..... 151, 152

**Trip meters** ..... 90

**Trunk** ..... 107

Smart key system ..... 109  
 Trunk features ..... 282

Trunk light ..... 110  
 Trunk opener switch ..... 109  
 Wireless remote control ..... 110

**Trunk light** ..... 110

**Turn signal lights**

Replacing light bulbs ..... 334  
 Turn signal lever ..... 155  
 Wattage ..... 387

**U**

**USB charging port** ..... 283

**V**

**Vanity lights** ..... 284

**Vanity mirrors** ..... 284

**Vehicle data recording** ..... 6

**Vehicle identification number** 380

**Vehicle Stability Control (VSC)** ..... 262

**Voltmeter** ..... 94

**VSC (Vehicle Stability Control)** ..... 262

**W**

**Warning buzzers**

Downshifting ..... 152, 153  
 Electric power steering ..... 350  
 High coolant temperature ..... 348  
 Low engine oil pressure ..... 349  
 Open door ..... 106  
 Seat belt ..... 351, 352

**Warning lights** ..... 348

ABS ..... 349  
 Automatic headlight leveling system warning light ..... 353  
 Automatic transmission fluid temperature ..... 350  
 Brake system ..... 348  
 BSD/RCTA warning light ..... 352  
 Charging system ..... 348

Conventional cruise control indicator .....	352	Locking/Unlocking .....	103
Electric power steering .....	350	Replacing the battery .....	328
EyeSight warning light.....	353		
High coolant temperature .....	348		
LED headlight warning light ..	353		
Low engine oil pressure .....	349		
Low fuel level .....	351		
Malfunction indicator lamp ...	349		
Master warning light .....	353		
Open door warning.....	351		
RAB warning light.....	353		
Seat belt reminder light 351, 352			
Slip indicator.....	350		
SRH warning light .....	352		
SRS .....	349		
Tire pressure .....	354		
<b>Warning messages.....</b>	<b>357</b>		
<b>Warning reflector storage box</b>			
.....	<b>282</b>		
<b>Washer</b>			
Checking .....	311		
Preparing and checking before			
winter.....	266		
Switch.....	165		
<b>Washing and waxing.....</b>	<b>288</b>		
<b>Weight</b>			
Cargo capacity .....	143		
Load limits .....	143		
Weight .....	380		
<b>Wheels</b>			
Replacing wheels .....	319		
Size .....	386		
<b>Window lock switch .....</b>	<b>130</b>		
<b>Windows</b>			
Power windows .....	129		
Rear window defogger .....	272		
Washer.....	165		
<b>Windshield wipers.....</b>	<b>165</b>		
<b>Winter driving tips.....</b>	<b>266</b>		
<b>Wireless remote control</b>			
Battery-Saving Function .....	112		



---

## Certifications

### ► Engine immobilizer system

FCC ID: Y8PSSPIMB03

This device complies with part 15 of the FCC Rules. Operation is subject to the following two conditions: (1) This device may not cause harmful interference, and (2) this device must accept any interference received, including interference that may cause undesired operation.

Changes or modifications not expressly approved by the party responsible for compliance could void the user's authority to operate the equipment.

This device complies with Industry Canada's licence-exempt RSSs. Operation is subject to the following two conditions: (1) This device may not cause interference; and (2) This device must accept any interference, including interference that may cause undesired operation of the device.

Le présent appareil est conforme aux CNR d'Industrie Canada applicables aux appareils radio exempts de licence. L'exploitation est autorisée aux deux conditions suivantes : (1) l'appareil ne doit pas produire de brouillage; (2) l'utilisateur de l'appareil doit accepter tout brouillage radioélectrique subi, même si le brouillage est susceptible d'en compromettre le fonctionnement.



---

► Smart key system

FCC ID:HYQ14AHK

US

**NOTE:**

This device complies with part 15 of the FCC Rules. Operation is subject to the following two conditions: (1) This device may not cause harmful interference, and (2) this device must accept any interference received, including interference that may cause undesired operation.

**FCC WARNING:**

Changes or modifications not expressly approved by the party responsible for compliance could void the user's authority to operate the equipment.

00

CA

**NOTE:**

This device contains licence-exempt transmitter(s)/receiver(s) that comply with Innovation, Science and Economic Development Canada's licence-exempt RSS(s).

Operation is subject to the following two conditions:

- (1) This device may not cause interference.
- (2) This device must accept any interference, including interference that may cause undesired operation of the device.

02

**NOTE:**

L'émetteur/récepteur exempt de licence contenu dans le présent appareil est conforme aux CNR d'Innovation, Sciences et Développement économique Canada applicables aux appareils radio exempts de licence.

L'exploitation est autorisée aux deux conditions suivantes :

- (1) L'appareil ne doit pas produire de brouillage;
- (2) L'appareil doit accepter tout brouillage radioélectrique subi, même si le brouillage est susceptible d'en compromettre le fonctionnement.

FCC ID: Y8PSU19S-3

**NOTE**

This device complies with part 15 of the FCC Rules. Operation is subject to the following two conditions: (1) This device may not cause harmful interference, and (2) this device must accept any interference received, including interference that may cause undesired operation.

**FCC WARNING**

Changes or modifications not expressly approved by the party responsible for compliance could void the user's authority to operate the equipment.

**NOTE**

This device contains licence-exempt transmitter(s)/receiver(s) that comply with Innovation, Science and Economic Development Canada's licence-exempt RSS(s). Operation is subject to the following two conditions:

- (1) This device may not cause interference.
- (2) This device must accept any interference, including interference that may cause undesired operation of the device.

**NOTE**

L'émetteur/récepteur exempt de licence contenu dans le présent appareil est conforme aux CNR d'Innovation, Sciences et Développement économique Canada applicables aux appareils radio exempts de licence. L'exploitation est autorisée aux deux conditions suivantes:

- (1) L'appareil ne doit pas produire de brouillage;
- (2) L'appareil doit accepter tout brouillage radioélectrique subi, même si le brouillage est susceptible d'en compromettre le fonctionnement.

► **BSD/RCTA**

FCC ID : OAYSRR3A

This device complies with part 15 of the FCC Rules. Operation is subject to the following two conditions:

- (1) This device may not cause harmful interference, and
- (2) this device must accept any interference received, including interference that may cause undesired operation.

**FCC Warning**

Changes or modifications not expressly approved by the party responsible for compliance could void the user's authority to operate the equipment.

This device contains licence-exempt transmitter(s)/receiver(s) that comply with Innovation, Science and Economic Development Canada's licence-exempt RSS(s). Operation is subject to the following two conditions:

1. This device may not cause interference.
2. This device must accept any interference, including interference that may cause undesired operation of the device.

**Radiofrequency radiation exposure information:**

This equipment complies with radiation exposure limits set forth for an uncontrolled environment. This equipment should be installed and operated with minimum distance of 20 cm between the radiator and your body.

L'émetteur/récepteur exempt de licence contenu dans le présent appareil est conforme aux CNR d'Innovation, Sciences et Développement économique Canada applicables aux appareils radio exempts de licence. L'exploitation est autorisée aux deux conditions suivantes:

1. L'appareil ne doit pas produire de brouillage;
2. L'appareil doit accepter tout brouillage radioélectrique subi, même si le brouillage est susceptible d'en compromettre le fonctionnement.

Informations sur l'exposition aux rayonnements radiofréquences:

Cet équipement est conforme aux limites d'exposition aux rayonnements définies pour un environnement non contrôlé. Cet équipement doit être installé et utilisé avec un minimum de 20 cm de distance entre la source de rayonnement et votre corps.

► Tire pressure warning system

US

FCC ID:HYQ23ABG

**NOTE:**

This device complies with part 15 of the FCC Rules. Operation is subject to the following two conditions: (1) This device may not cause harmful interference, and (2) this device must accept any interference received, including interference that may cause undesired operation.

**FCC WARNING:**

Changes or modifications not expressly approved by the party responsible for compliance could void the user's authority to operate the equipment.

00

FCC ID: PAXPMVE000

**NOTE**

This device complies with part 15 of the FCC Rules. Operation is subject to the following two conditions:  
(1) This device may not cause harmful interference, and  
(2) this device must accept any interference received, including interference that may cause undesired operation.

**FCC WARNING**

Changes or modifications not expressly approved by the party responsible for compliance could void the user's authority to operate the equipment.

Model: PMV-E000

**NOTE**

This device complies with Industry Canada licence-exempt RSS standard(s). Operation is subject to the following two conditions: (1) this device may not cause interference, and (2) this device must accept any interference, including interference that may cause undesired operation of the device.

**NOTE**

Le présent appareil est conforme aux CNR d'Industrie Canada applicables aux appareils radio exempts de licence. L'exploitation est autorisée aux deux conditions suivantes : (1) l'appareil ne doit pas produire de brouillage, et (2) l'utilisateur de l'appareil doit accepter tout brouillage radioélectrique subi, même si le brouillage est susceptible d'en compromettre le fonctionnement.

► **Safety Connect**

Cellular  
FCC ID: LHJ-BL28NA003  
IC: 2807E-BL28NA003

Wi-Fi  
FCC ID: LHJ-STRLNK2P  
IC: 2807E-STRLNK2P

This device complies with Part 15, Part 22(H), Part 24(E) and Part 27 of the FCC Rules. The FCC ID for this device is LHJ-STRLNK2P. It also contains a certified module with FCC ID: LHJ-BL28NA003.

**FCC CAUTION**

Changes or modifications not expressly approved by the party responsible for compliance could void the user's authority to operate the equipment.

**NOTE**

This device complies with part 15 of the FCC Rules. Operation is subject to the following two conditions: (1) This device may not cause harmful interference, and (2) this device must accept any interference received, including interference that may cause undesired operation.

**NOTE**

This equipment has been tested and found to comply with the limits for a Class B digital device, pursuant to part 15 of the FCC Rules. These limits are designed to provide reasonable protection against harmful interference in a residential installation. This equipment generates, uses and can radiate radio frequency energy and, if not installed and used in accordance with the instructions, may cause harmful interference to radio communications. However, there is no guarantee that interference will not occur in a particular installation. If this equipment does cause harmful interference to radio or television reception, which can be determined by turning the equipment off and on, the user is encouraged to try to correct the interference by one or more of the following measures:

- Reorient or relocate the receiving antenna.
- Increase the separation between the equipment and receiver.
- Connect the equipment into an outlet on a circuit different from that to which the receiver is connected.
- Consult the dealer or an experienced radio/TV technician for help.

**NOTE**

You are cautioned that changes or modifications not expressly approved by the part responsible for compliance could void the user's authority to operate the equipment.

**FCC RF Radiation Exposure Statement:**

1. This Transmitter must not be co-located or operating in conjunction with any other antenna or transmitter.
2. This equipment complies with FCC RF radiation exposure limits set forth for an uncontrolled environment. This equipment should be installed and operated with a minimum distance of 20 centimeters between the radiator and your body.

**NOTE**

This device contains licence-exempt transmitter(s)/receiver(s) that comply with Innovation, Science and Economic Development Canada's licence-exempt RSS(s). Operation is subject to the following two conditions:

1. This device may not cause interference, and
2. This device must accept any interference, including interference that may cause undesired operation of the device.

**REMARQUE**

L'émetteur/récepteur exempt de licence contenu dans le présent appareil est conforme aux CNR d'Innovation, Sciences et Développement économique Canada applicables aux appareils radio exempts de licence. L'exploitation est autorisée aux deux conditions suivantes :

1. l'appareil ne doit pas produire de brouillage, et, and
2. l'utilisateur de l'appareil doit accepter tout brouillage radioélectrique subi, même si le brouillage est susceptible d'en compromettre le fonctionnement.

**Caution: Exposure to Radio Frequency Radiation**

1. To comply with the Canadian RF exposure compliance requirements, this device and its antenna must not be co-located or operating in conjunction with any other antenna or transmitter.
2. To comply with RSS 102 RF exposure compliance requirements, a separation distance of at least 20 cm must be maintained between the antenna of this device and all persons.

**Attention: exposition au rayonnement radiofréquence**

1. Pour se conformer aux exigences de conformité RF canadienne l'exposition, cet appareil et son antenne ne doivent pas être co-localisés ou fonctionnant en conjonction avec une autre antenne ou transmetteur.
2. Pour se conformer aux exigences de conformité CNR 102 RF exposition, une distance de séparation d'au moins 20 cm doit être maintenue entre l'antenne de cet appareil et toutes les personnes.





## GAS STATION INFORMATION

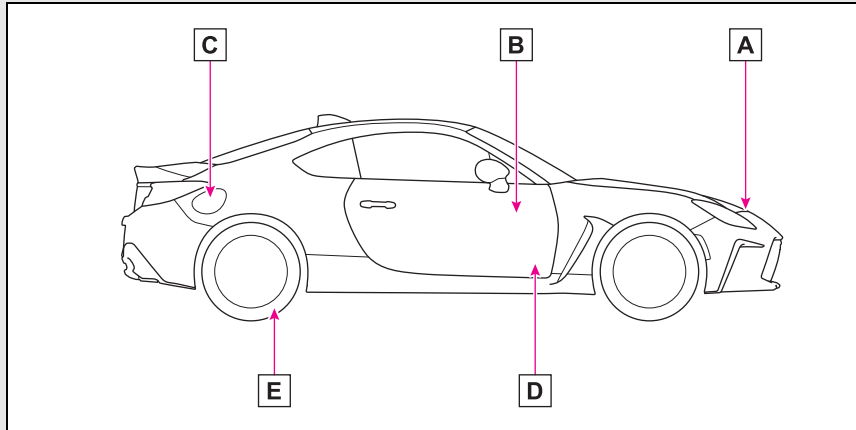

- A** Auxiliary catch lever (→P.302)
- B** Trunk opener (→P.109)
- C** Fuel filler door (→P.168)
- D** Hood lock release lever (→P.302)
- E** Tire inflation pressure (→P.386)

Fuel tank capacity (Reference)	13.2 gal. (50 L, 11.0 Imp. gal.)	
Fuel type	Unleaded gasoline only	P.381 P.388
Cold tire inflation pressure		P.386
Engine oil capacity (Drain and refill — reference)		P.382
Engine oil type		P.382

For details, refer to the page listed in the “OWNER’S MANUAL”.