

Owner's Manual

2022 ODYSSEY

⚠️ WARNING

California Proposition 65 Warning

Operating, servicing and maintaining a passenger vehicle or off-highway motor vehicle can expose you to chemicals including engine exhaust, carbon monoxide, phthalates, and lead, which are known to the State of California to cause cancer and birth defects or other reproductive harm. To minimize exposure, avoid breathing exhaust, do not idle the engine except as necessary, service your vehicle in a well-ventilated area and wear gloves or wash your hands frequently when servicing your vehicle. For more information go to www.P65Warnings.ca.gov/passenger-vehicle.

Event Data Recorders

This vehicle is equipped with an event data recorder (EDR).

The main purpose of an EDR is to record, in certain crash or near crash-like situations, such as an air bag deployment or hitting a road obstacle, data that will assist in understanding how a vehicle's systems performed. **The EDR is designed to record data related to vehicle dynamics and safety systems for a short period of time, typically 30 seconds or less. The EDR in this vehicle is designed to record such data as:**

- **How various systems in your vehicle were operating;**
- **Whether or not the driver and passenger safety belts were buckled/fastened;**
- **How far (if at all) the driver was depressing the accelerator and/or brake pedal; and,**
- **How fast the vehicle was traveling.**

These data can help provide a better understanding of the circumstances in which crashes and injuries occur. NOTE: EDR data are recorded by your vehicle only if a non-trivial crash situation occurs; no data are recorded by the EDR under normal driving conditions and no personal data (e.g., name, gender, age, and crash location) are recorded. However, other parties, such as law enforcement, could combine the EDR data with the type of personally identifying data routinely acquired during a crash investigation.

To read data recorded by an EDR, special equipment is required, and access to the vehicle or the EDR is needed. In addition to the vehicle manufacturer, other parties, such as law enforcement, that have the special equipment, can read the information if they have access to the vehicle or the EDR.

The data belongs to the vehicle owner and may not be accessed by anyone else except as legally required or with the permission of the vehicle owner.

Service Diagnostic Recorders

This vehicle is equipped with service-related devices that record information about powertrain performance. The data can be used to verify emissions law requirements and/or help technicians diagnose and solve service problems. It may also be combined with data from other sources for research purposes, but it remains confidential. Some diagnostic and maintenance information is uploaded to Honda upon vehicle start up.

California Perchlorate Contamination Prevention Act

The airbags, seat belt tensioners, and CR type batteries in this vehicle may contain perchlorate materials - special handling may apply. See www.dtsc.ca.gov/hazardouswaste/perchlorate/

As you read this manual, you will find information that is preceded by a **NOTICE** symbol. This information is intended to help you avoid damage to your vehicle, other property, or the environment.

Software End User License Agreement

Your vehicle comes equipped with software, which is governed by the End User License Agreement in Owner's Manual, and which contains a binding arbitration clause. Please refer to the End User License Agreement for the terms and conditions governing your use of the installed software, as well as the applications, services, functions, and content provided through the software. Your use of the installed software will serve as your consent to the terms and conditions of the End User License Agreement.

You may opt out within 30 days of your initial use of the Software by sending a signed, written notice to HONDA at American Honda Motor Co., Inc., Honda Automobile Customer Services Mail Stop CHI-5, 1919 Torrance Blvd., Torrance, CA 90501-2746.

Privacy Notice

This vehicle may share location and usage information. To manage this setting, visit www.hondalink.com/vehicle-data-choices.

To learn more about how we collect and use Personal Information, please read our Privacy Policy, accessible at www.honda.com.

A Few Words About Safety

Your safety, and the safety of others, is very important. And operating this vehicle safely is an important responsibility.

To help you make informed decisions about safety, we have provided operating procedures and other information on labels and in this manual. This information alerts you to potential hazards that could hurt you or others.

Of course, it is not practical or possible to warn you about all the hazards associated with operating or maintaining your vehicle. You must use your own good judgment.

You will find this important safety information in a variety of forms, including:

- **Safety Labels** - on the vehicle.
- **Safety Messages** - preceded by a safety alert symbol  and one of three signal words: **DANGER**, **WARNING**, or **CAUTION**. These signal words mean:

DANGER

You **WILL** be **KILLED** or **SERIOUSLY HURT** if you don't follow instructions.

WARNING

You **CAN** be **KILLED** or **SERIOUSLY HURT** if you don't follow instructions.

CAUTION

You **CAN** be **HURT** if you don't follow instructions.

- **Safety Headings** - such as Important Safety Precautions.
- **Safety Section** - such as Safe Driving.
- **Instructions** - how to use this vehicle correctly and safely.

This entire book is filled with important safety information - please read it carefully.

This owner's manual should be considered a permanent part of the vehicle and should remain with the vehicle when it is sold.

The Navigation Manual is available online at *owners.honda.com* (U.S.) or *honda.ca* (Canada). **If you are the first registered owner of your vehicle, you may request a complimentary printed copy of the Navigation Manual within the first six months of vehicle purchase.** To request a copy, visit *owners.honda.com*. In Canada, please request a copy from your Honda dealer.

This owner's manual covers all models of your vehicle. You may find descriptions of equipment and features that are not on your particular model.

Images throughout this owner's manual (including the front cover) represent features and equipment that are available on some, but not all, models. Your particular model may not have some of these features.

This owner's manual is for vehicles sold in the United States and Canada.

The information and specifications included in this publication were in effect at the time of approval for printing. Honda Motor Co., Ltd. reserves the right, however, to discontinue or change specifications or design at any time without notice and without incurring any obligation.

➤ Safe Driving P. 35

For Safe Driving P. 36 Seat Belts P. 40 Airbags P. 49

➤ Instrument Panel P. 87

Indicators P. 88 Gauges and Driver Information Interface P. 127

➤ Controls P. 153

Clock P. 154 Locking and Unlocking the Doors P. 156
Security System P. 191 Windows P. 194
Mirrors P. 219 Seats P. 222

➤ Features P. 273

Audio System P. 274 Audio System Basic Operation P. 282, 300
Blu-ray/DVD Rear Entertainment System* P. 409
CabinWatch®* P. 535 CabinTalk®* P. 536

➤ Driving P. 537

Before Driving P. 538 Towing a Trailer P. 544
Parking Your Vehicle P. 646 Multi-View Rear Camera P. 657

➤ Maintenance P. 663

Before Performing Maintenance P. 664 Maintenance Minder™ P. 667
Checking and Maintaining Wiper Blades P. 693
Remote Control and Wireless Headphone Care* P. 709

➤ Handling the Unexpected P. 721

Tools P. 722 If a Tire Goes Flat P. 723
Indicator, Coming On/Blinking P. 739 Fuses P. 745
If You Cannot Open the Tailgate P. 754

➤ Information P. 759

Specifications P. 760 Identification Numbers P. 762
Warranty Coverages P. 767 Authorized Manuals P. 770

Contents

Child Safety P. 67	Exhaust Gas Hazard P. 85	Safety Labels P. 86
Tailgate P. 171	Sliding Doors P. 182	
Moonroof* P. 197	Operating the Switches Around the Steering Wheel P. 198	
Interior Convenience Items P. 239	Climate Control System P. 260, 265	
Audio Error Messages P. 380	General Information on the Audio System P. 385	
Customized Features P. 457, 463	HomeLink® Universal Transceiver* P. 482	Bluetooth® HandsFreeLink® P. 485, 510
When Driving P. 550	Honda Sensing® P. 586	Braking P. 638
Refueling P. 659	Fuel Economy and CO ₂ Emissions P. 662	
Maintenance Under the Hood P. 673	Replacing Light Bulbs P. 686	
Checking and Maintaining Tires P. 697	Battery P. 706	Remote Transmitter Care P. 708
Climate Control System Maintenance P. 711	Cleaning P. 712	Accessories and Modifications P. 718
Engine Does Not Start P. 732	If the Battery Is Dead P. 735	Overheating P. 737
Emergency Towing P. 752	If You Cannot Unlock the Fuel Fill Door P. 753	
When You Cannot Close the Power Sliding Doors* P. 756		Refueling P. 757
Devices that Emit Radio Waves P. 763	Reporting Safety Defects P. 764	Emissions Testing P. 765
Customer Service Information P. 771		

Quick Reference Guide P. 6

Safe Driving P. 35

Instrument Panel P. 87

Controls P. 153

Features P. 273

Driving P. 537

Maintenance P. 663

Handling the Unexpected P. 721

Information P. 759

Index P. 772

Visual Index

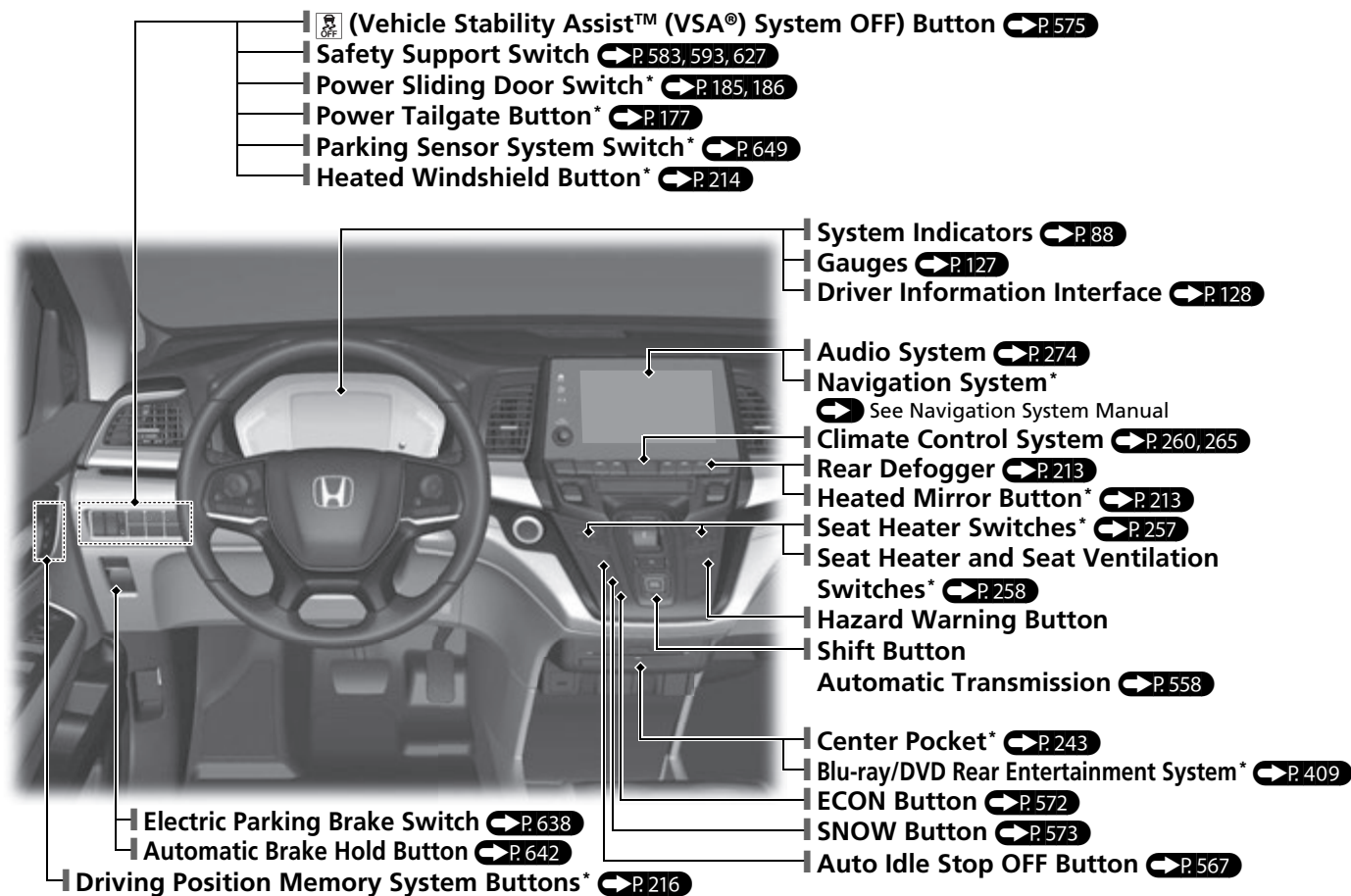

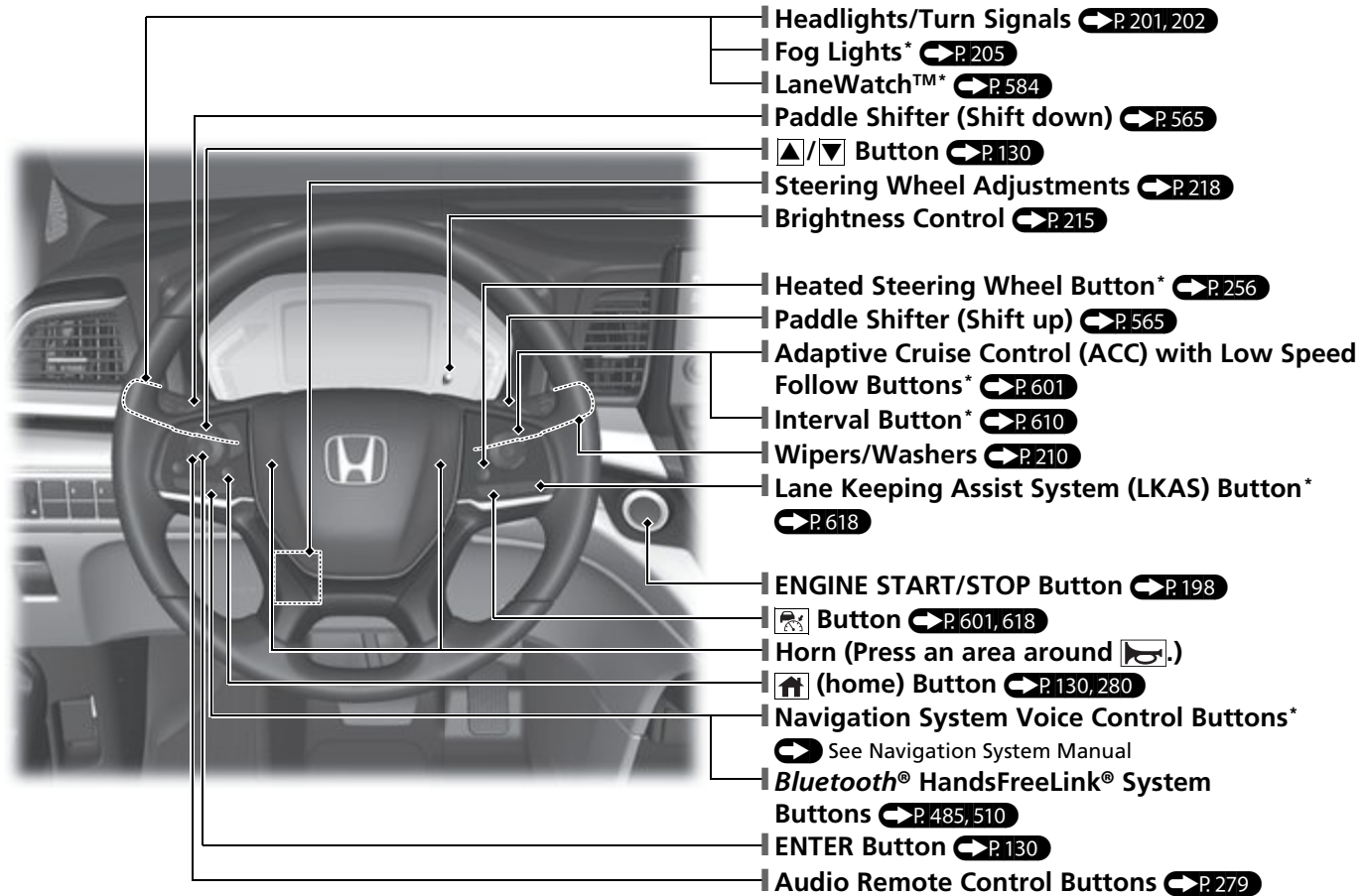

Visual Index

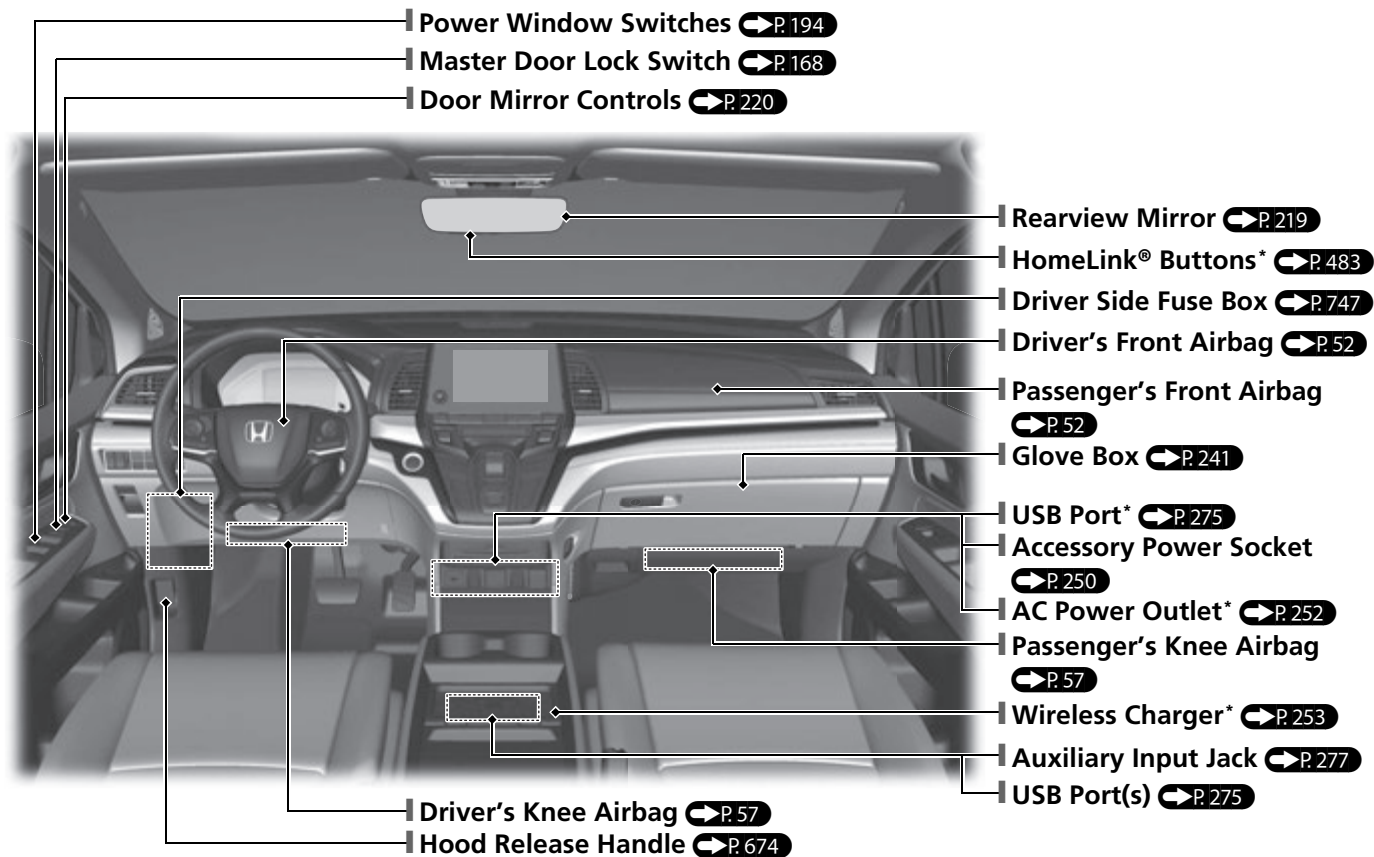

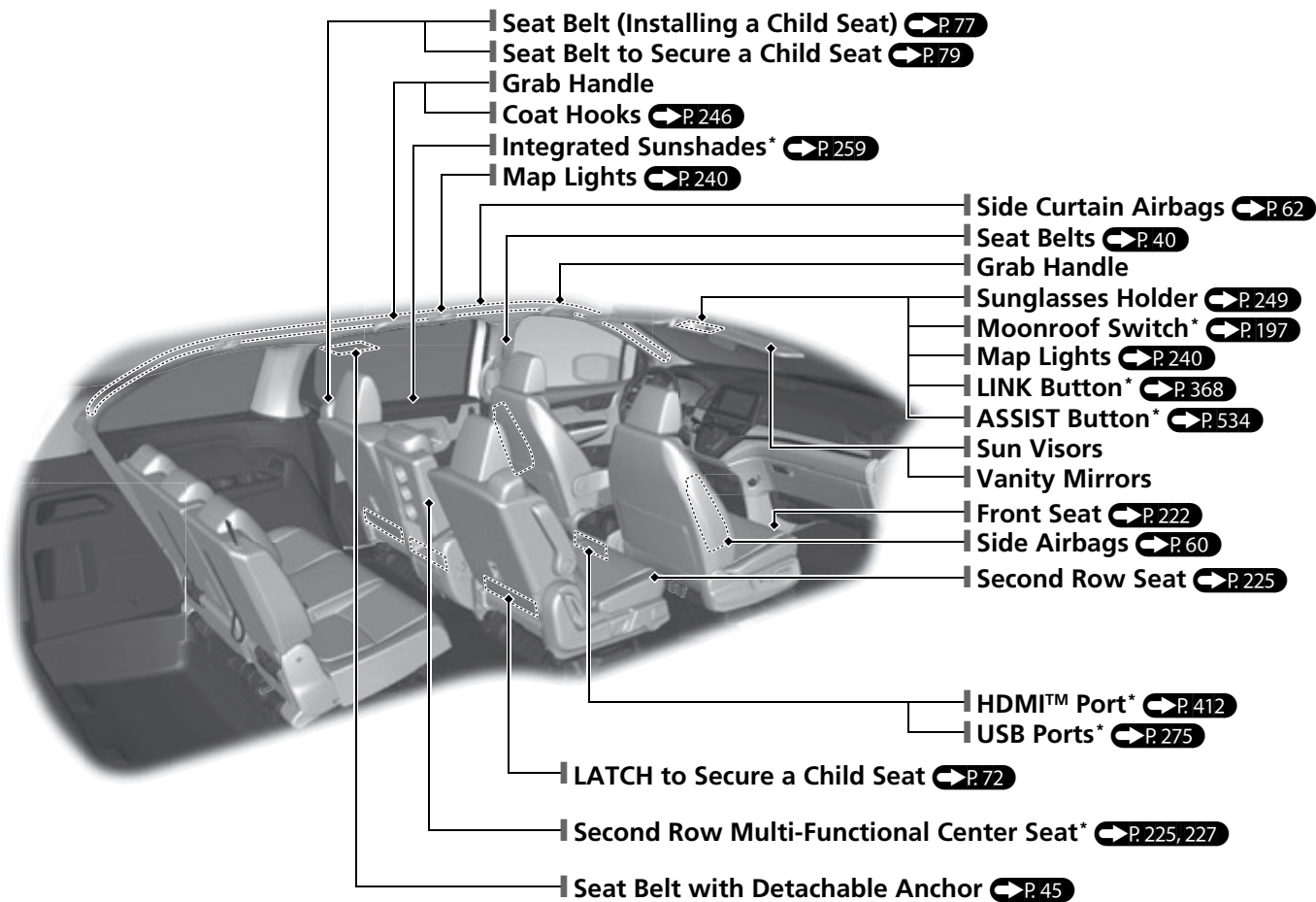



* Not available on all models

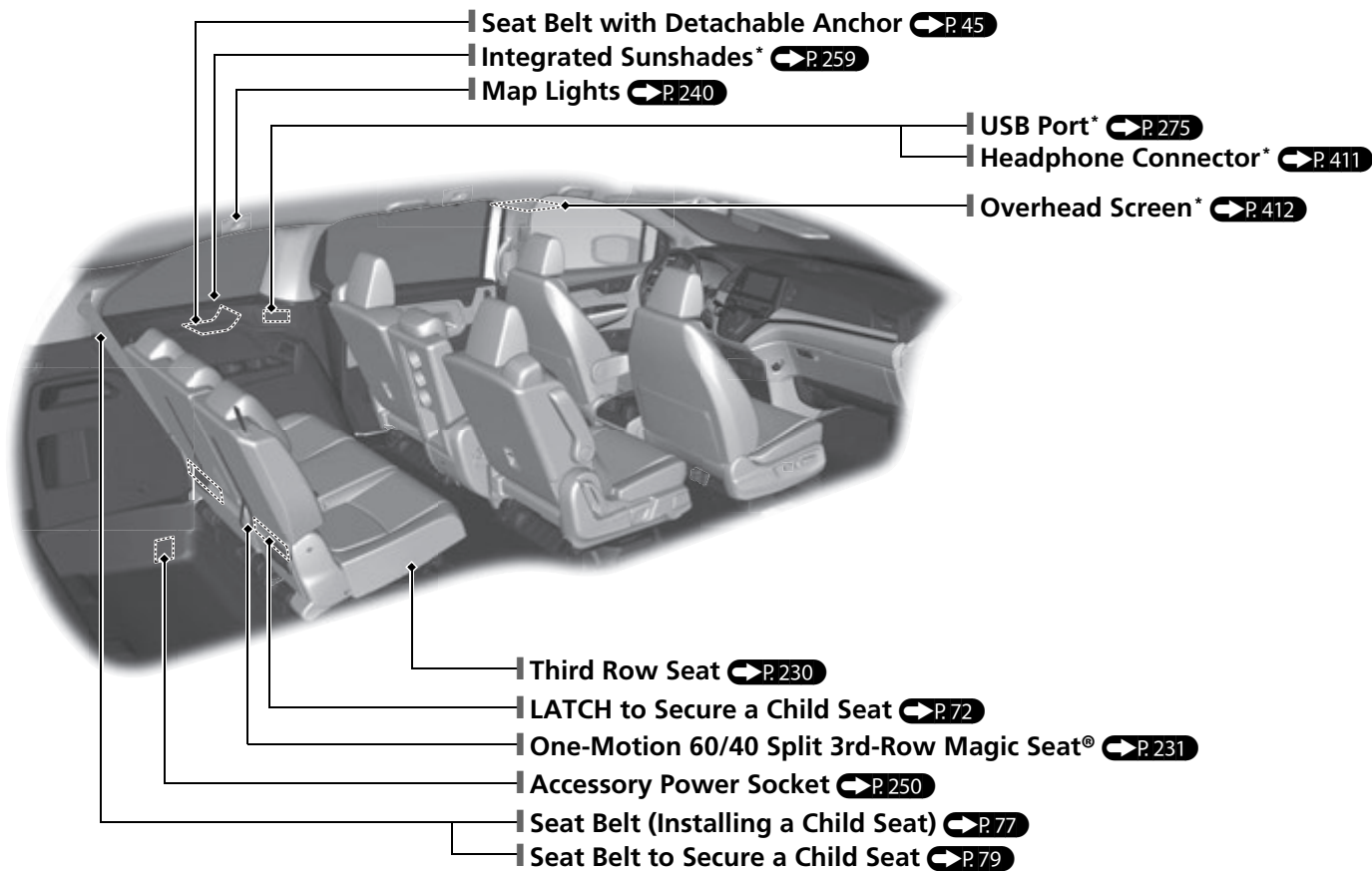

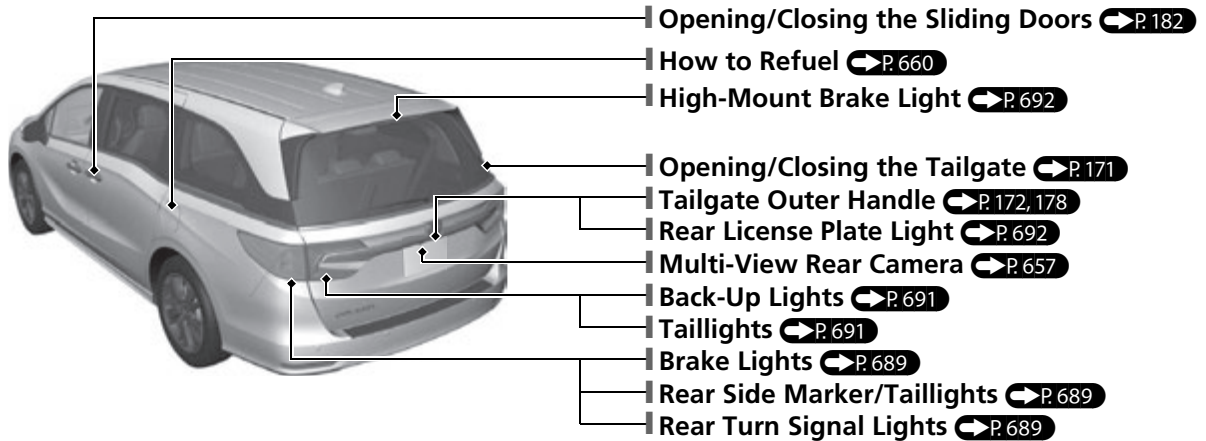
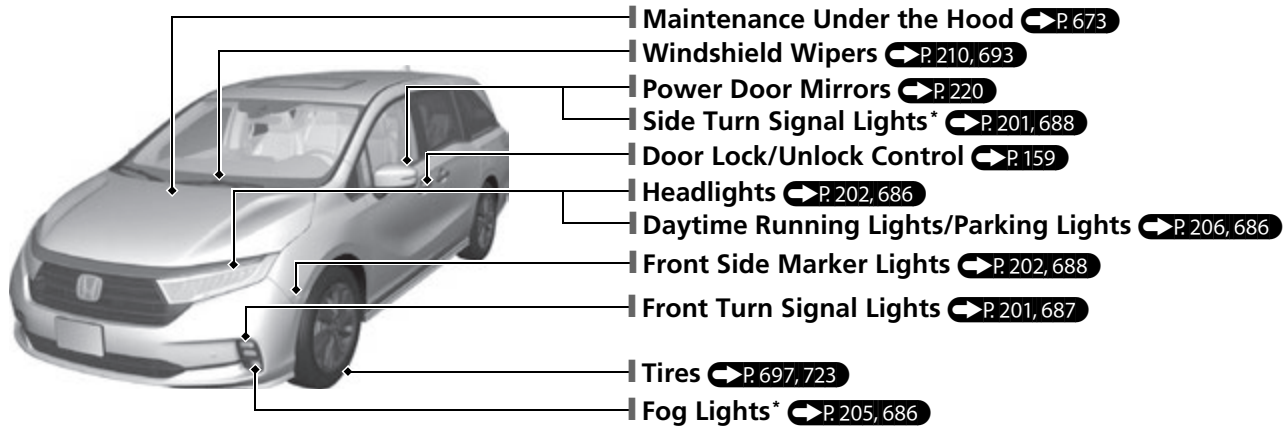



Visual Index



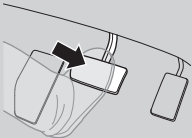
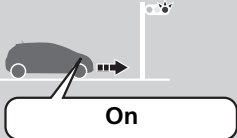

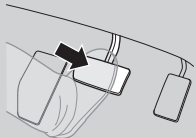
Auto Idle Stop Function

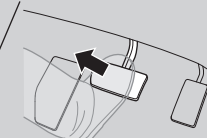
To improve fuel economy, the engine stops and then restarts as detailed below. When Auto Idle Stop is on, the Auto Idle Stop indicator (green) comes on.  P. 566

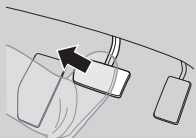
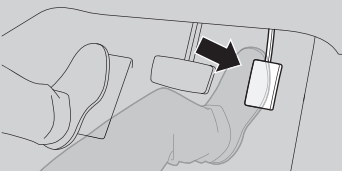
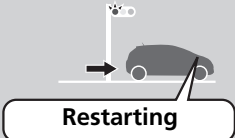
At	Automatic transmission	Engine status
<p>Deceleration</p> 	 <p>Stop the vehicle and depress the brake pedal.</p>	
<p>Stop</p> 	 <p>Keep the brake pedal depressed.</p> <div style="display: flex; justify-content: space-around; align-items: center;"> <div style="text-align: center;"> <p>U.S.</p>  </div> <div style="text-align: center;"> <p>Canada</p>  </div>  </div> <p>With the automatic brake hold system activated, you can release the brake pedal when the (A) indicator comes on.</p>	
<p>Start-up</p>	 <p>Release the brake pedal.</p>  <p>With the automatic brake hold system activated, depress the accelerator pedal.</p>	

Eco Assist[®] System P. 572

Ambient Meter

The color of the ambient meter changes to green to indicate that the vehicle is being driven in a fuel efficient manner.

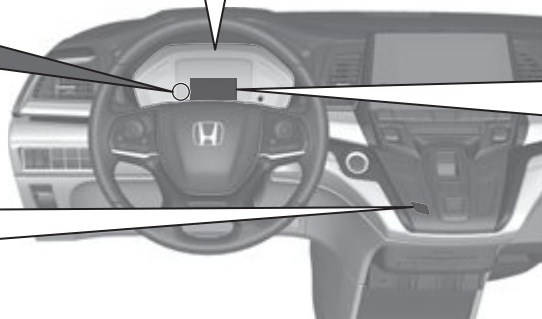

ECON Button P. 572

Helps maximize fuel economy.

ECON Mode Indicator P. 99

Comes on when the ECON button is pressed.

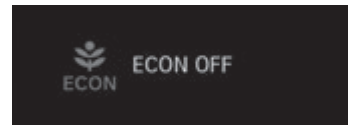
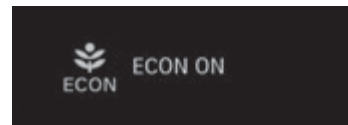

The message is displayed for a few seconds when the ECON button is pressed.

Safe Driving

➔ P.35

Airbags

➔ P.49

- Your vehicle is fitted with airbags to help protect you and your passengers during a moderate-to-severe collision.

Child Safety

➔ P.67

- All children 12 and younger should be seated in the rear seat.
- Smaller children should be properly restrained in a forward-facing child seat.
- Infants must be properly restrained in a rear-facing child seat.

Exhaust Gas Hazard

➔ P.85

- Your vehicle emits dangerous exhaust gases that contain carbon monoxide. Do not run the engine in confined spaces where carbon monoxide gas can accumulate.

Seat Belts

➔ P.40

- Fasten your seat belt and sit upright well back in the seat.
- Check that your passengers are wearing their seat belts correctly.

Before Driving Checklist

➔ P.39

- Before driving, check that the front seats, head restraints, steering wheel, and mirrors have been properly adjusted.















Fasten your lap belt as low as possible.

Instrument Panel P.87

Indicators P.88 / Driver Information Interface P.128 /

Gauges P.127

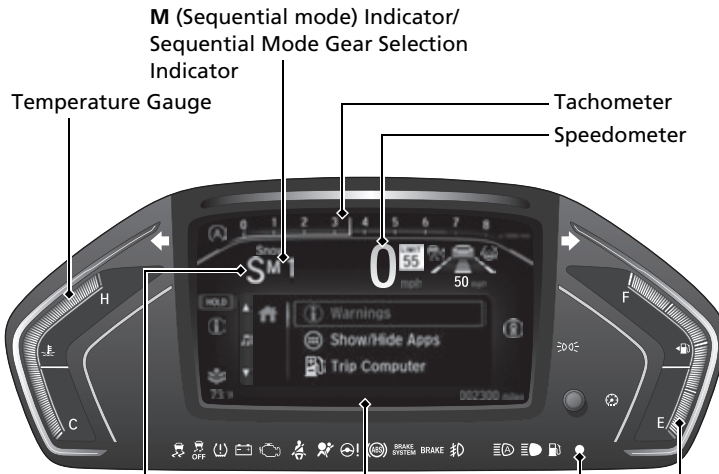

System Indicators

-  Malfunction Indicator Lamp
-  Charging System Indicator
-  Electric Power Steering (EPS) System Indicator
-  Low Fuel Indicator
-  Vehicle Stability Assist™ (VSA®) System Indicator
-  VSA® OFF Indicator
-  Automatic Brake Hold System Indicator
-  U.S. Automatic Brake Hold Indicator
-  Canada Automatic Brake Hold Indicator
-  BRAKE SYSTEM U.S. Parking Brake and Brake System Indicator (Amber)
-  Canada Parking Brake and Brake System Indicator (Amber)
-  Anti-lock Brake System (ABS) Indicator
-  Cruise Mode Indicator (White/Green)





- Gear Position Indicator/ Transmission System Indicator
- Driver Information Interface
- Immobilizer System Indicator/ Security System Alarm Indicator
- Fuel Gauge















System Indicators

-  Lane Keeping Assist System (LKAS) Indicator (Green/Amber/White)
-  Adaptive Cruise Control (ACC) with Low Speed Follow Indicator (Green/Amber/White)

Lights Indicators

-  Lights On Indicator
-  High Beam Indicator
-  Fog Light Indicator*
-  Auto High-Beam Indicator

System Indicators

-  Turn Signal and Hazard Warning Indicators
-  Low Tire Pressure/TPMS Indicator
-  BRAKE U.S. Parking Brake and Brake System Indicator (Red)
-  Canada Parking Brake and Brake System Indicator (Red)
-  Seat Belt Reminder Indicator
-  Supplemental Restraint System Indicator
-  Econ Mode Indicator
-  Auto Idle Stop System Indicator (Amber)/ Auto Idle Stop Indicator (Green)
-  Auto Idle Stop OFF Indicator
-  Auto Idle Stop Suspend Indicator
-  Snow Mode Indicator
-  Normal Mode Indicator
-  System Message Indicator
-  Safety Support Indicator (Green/Amber/Gray)





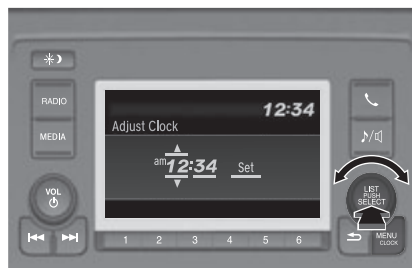

* Not available on all models

Controls P. 153

Clock P. 154

Models with color audio system



- 1 Press and hold the **MENU/CLOCK** button for two seconds.
- 2 Select **Adjust Clock**, then press .
- 3 Rotate  to adjust the hours.
- 4 Press  to switch to minute adjustment.
- 5 Rotate  to adjust the minutes.
- 6 Press  to switch to **Set**.
- 7 Press  to complete clock adjustment.

Models with Display Audio



To adjust time



To adjust date



- 1 Select , then select **Settings**.
- 2 Select **System**, then **Date & Time**.
- 3 Select **Set Date & Time**.
- 4 Select **Automatic Date & Time**, then select **OFF**.

- 5 Select **Set Date** or **Set Time**.
- 6 Adjust the dates, hours and minutes by selecting /.
- 7 Select **Save** to set the time.

Models with navigation system

The navigation system receives signals from GPS satellites, updating the clock automatically.

ENGINE START/STOP Button P. 198

Press the button to change the vehicle's power mode.

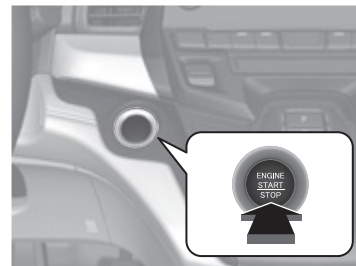

Turn Signals P.201

Turn Signal Control Lever

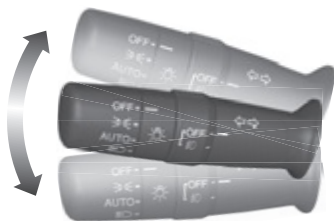

Lights P.202

Light Control Switches

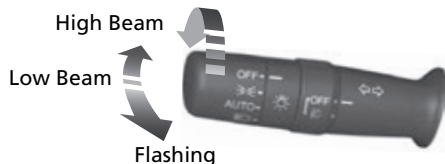





Wipers and Washers

 P.210

Wiper/Washer Control Lever

Adjustment Ring

- : Low sensitivity*¹
- : Lower speed, fewer sweeps*²
- : High sensitivity*¹
- : Higher speed, more sweeps*²

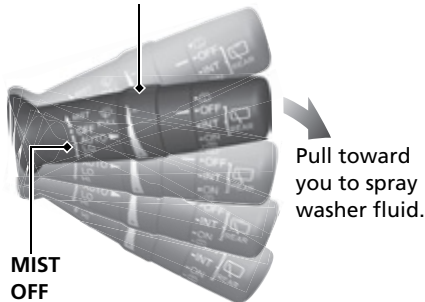

Pull toward you to spray washer fluid.

MIST
OFF

AUTO*¹: Wiper speed varies automatically
INT*²: Low speed with intermittent
LO: Low speed wipe
HI: High speed wipe

*1: Models with automatic intermittent wipers

*2: Models without automatic intermittent wipers

Models with automatic intermittent wipers

AUTO should always be turned **OFF** before the following situation in order to prevent severe damage to the wiper system:

- Cleaning the windshield
- Driving through a car wash
- No rain present

Steering Wheel P.218

To adjust, push the adjustment lever down, adjust to the desired position, then pull up the lever back in place.

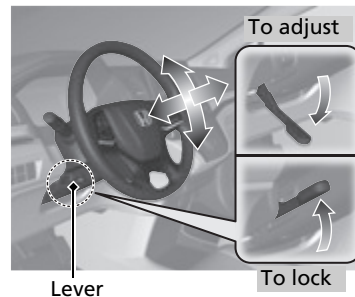

Unlocking the Front Doors from the Inside

➔ P.167

Pull either front door inner handle to unlock and open it at the same time.

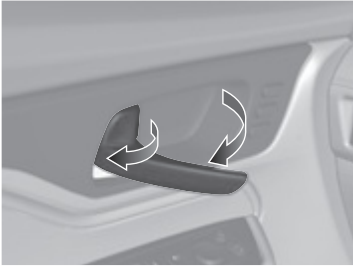

Power Sliding Door*

➔ P.184

When the main switch is **ON**, the power sliding door opens and closes automatically when you press **OPEN** or **CLOSE** side of the  switch.

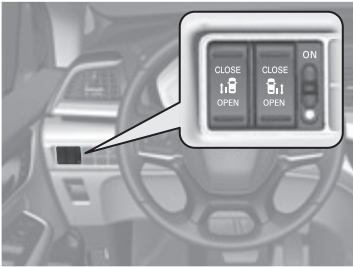

Tailgate ➔ P.171

Models with Hands Free Access

With the keyless remote on you, raise and lower your foot (in a kicking motion) under the center of the rear bumper to open or close the tailgate.

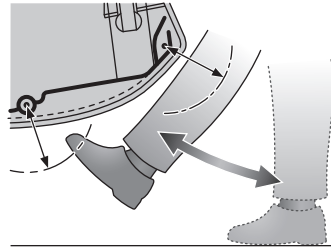
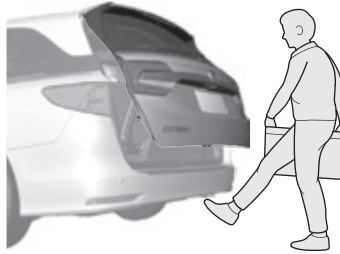

Models without keyless access system

- With all the doors unlocked, press the tailgate outer handle and lift open the tailgate.

Models with keyless access system

- Press the tailgate outer handle to unlock and open the tailgate when you carry the keyless remote.

Models with the power tailgate

- Press the power tailgate button on the instrument panel or the keyless remote to open and close the power tailgate.
- Press the tailgate inner button to close the power tailgate.

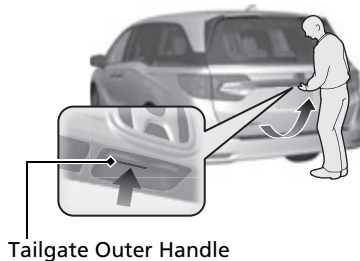

Tailgate Outer Handle

Power Door Mirrors

➔ P. 220

- With the power mode in ON, move the selector switch to L or R.
- Push the appropriate edge of the adjustment switch to adjust the mirror.
- Press the folding button* to fold the door mirrors in and out.

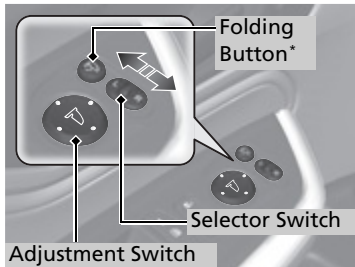

Models with driving position memory system



- Place the selector switch in the L or R position to use the reverse tilt door mirror feature.

Power Windows ➔ P. 194

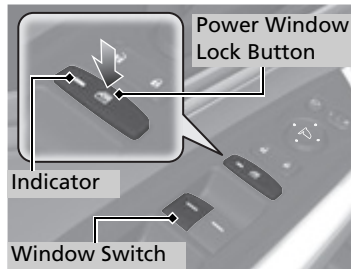
- With the power mode in ON, open and close the power windows.
- If the power window lock button is in the off position, each passenger's window can be opened and closed with its own switch.
- If the power window lock button is in the on position (indicator is on), each passenger's window switch is disabled.





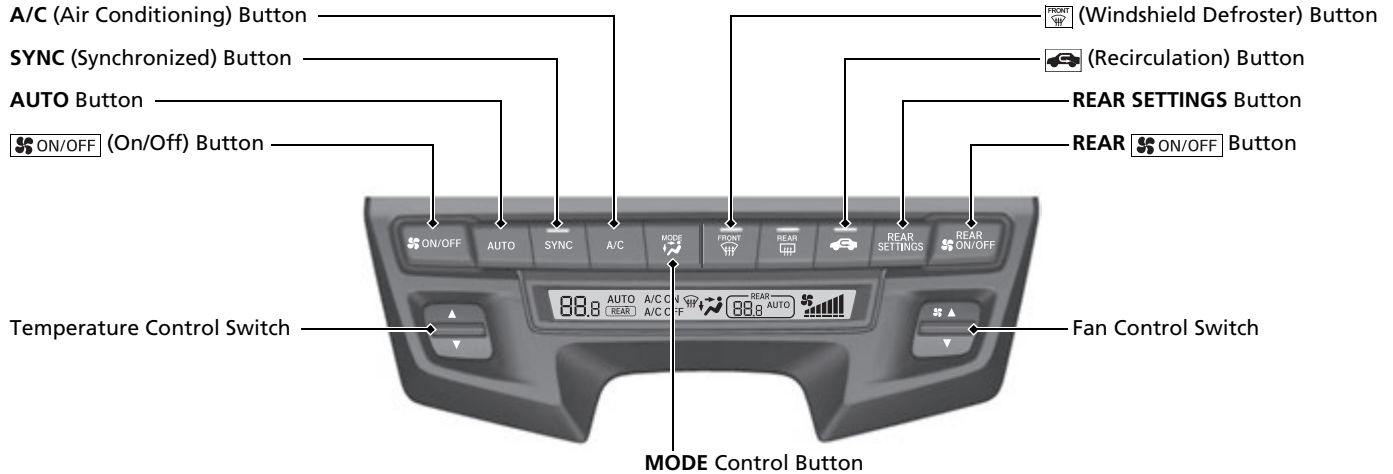

Climate Control System P.260, 265

- Press the **AUTO** button to activate the climate control system.
- Press the  **ON/OFF** button to turn the system on or off.
- Press the  button to defrost the windshield.

Dual-zone climate control system



-  Air flows from floor and windshield defroster vents.
-  Air flows from floor vents.
-  Air flows from floor and dashboard vents.
-  Air flows from dashboard vents.

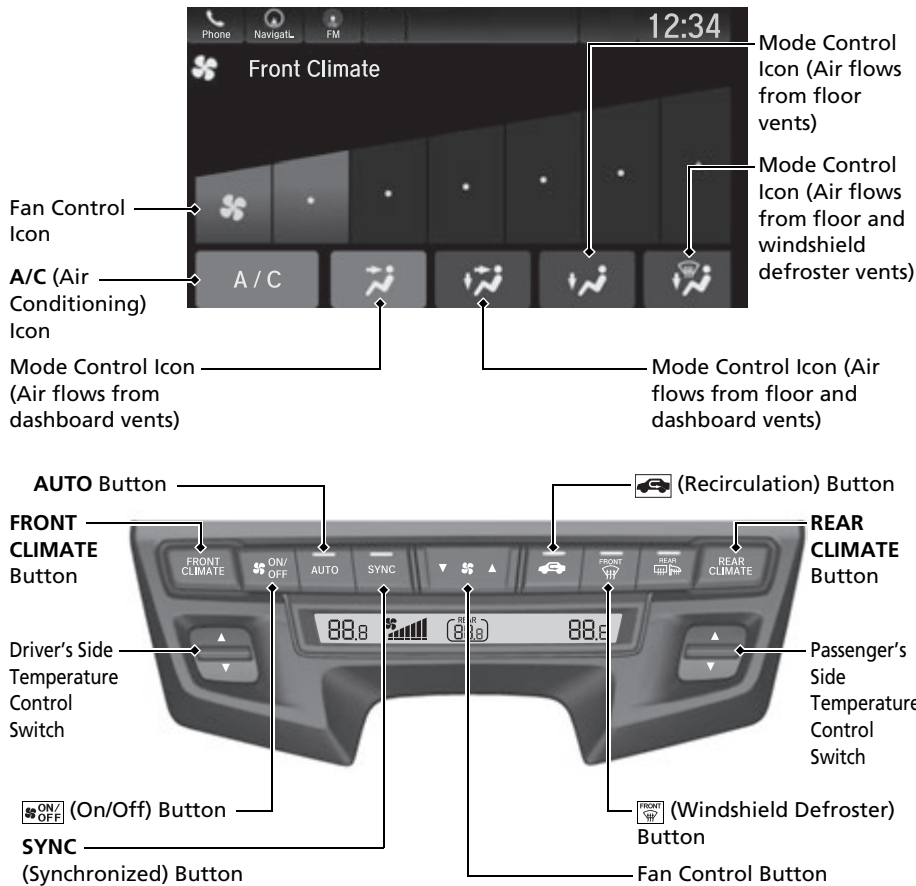

Rear Climate Control Panel*

- Press the **AUTO** button to activate the rear climate control system.
- Press the **ON/OFF** button to turn the system on or off.

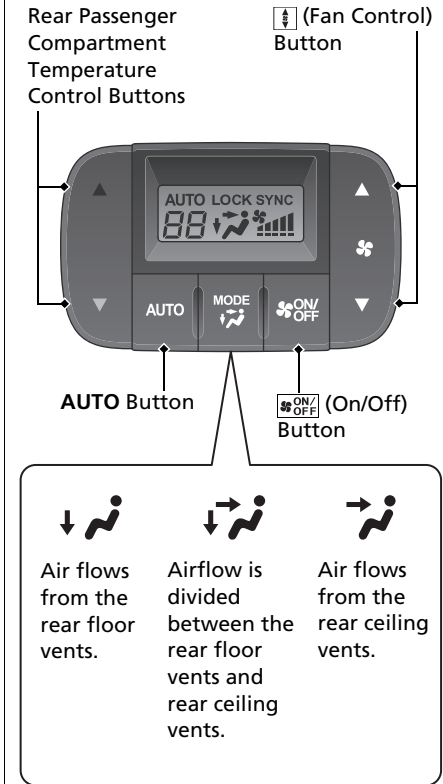

* Not available on all models

Features P. 273

Audio System P. 274

Models with color audio system  P. 282

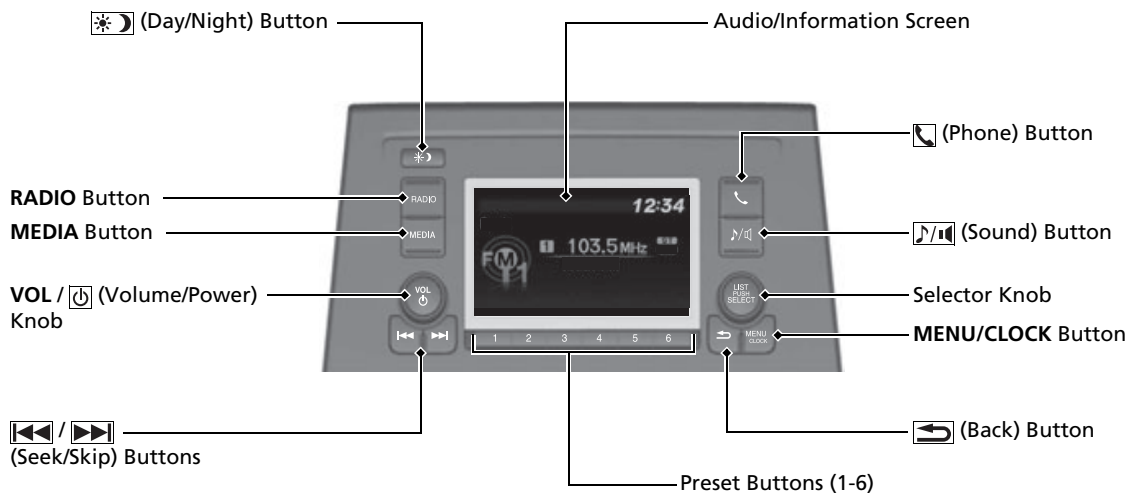

Models with Display Audio  P. 300

For navigation system operation  See the Navigation System Manual

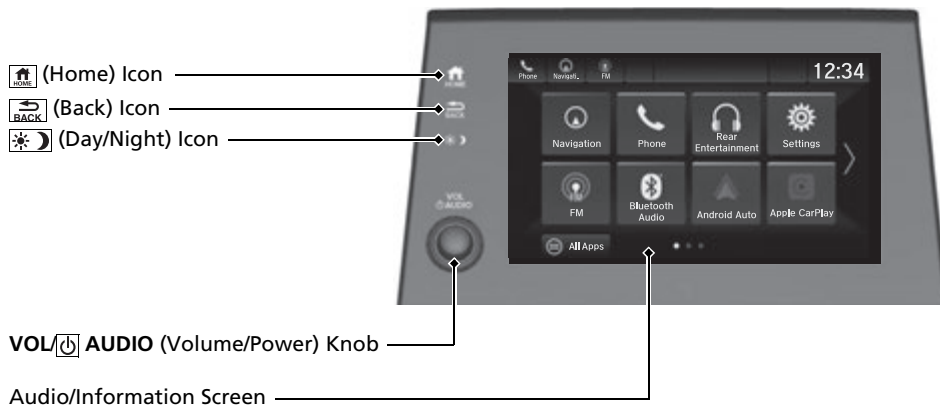

Models with Blu-ray™ or CD player

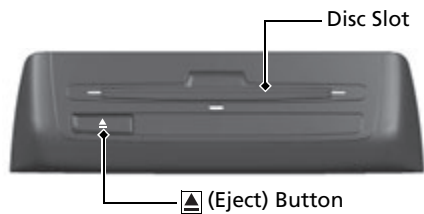

Audio Remote Controls

➔ P. 279

Models with color audio system

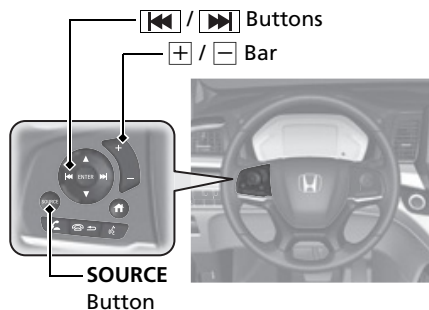

- + / - Bar
Press to adjust the volume up/down.
- **SOURCE** Button
Press to change the audio mode:
FM1/FM2/AM/USB/iPod/
Bluetooth[®] Audio/AUX
- ◀ / ▶ Buttons
Radio: Press to change the preset station.
Press and hold to select the next or previous strong station.
USB device/*Bluetooth*[®] Audio:
Press to skip to the beginning of the next song or return to the beginning of the current song.
Press and hold to change a folder.

Models with Display Audio

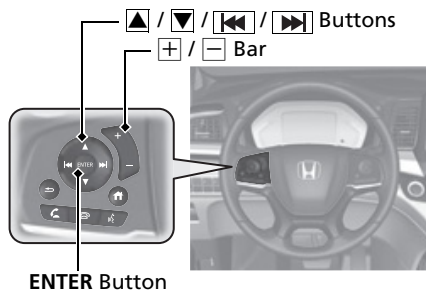

- + / - Bar
Press to adjust the volume up/down.
- ▲ / ▼ / ◀ / ▶ / ENTER Buttons
Press ▲ or ▼ to select **Now Playing** on the home screen of the driver information interface, and then press the **ENTER** button.

Press ▲ or ▼ to cycle through the audio mode as follows:
Android Auto/Apple CarPlay/SiriusXM[®]*/
Rear Entertainment*/AUX Input/AM/
Bluetooth[®] Audio/Social Playlist/FM/My
Honda Music/USB/iPod/CD*

Radio: Press ◀ / ▶ to change the preset station.

CD*/USB device/My Honda Music/
Bluetooth[®] Audio:

Press ◀ / ▶ to skip to the beginning of the next song or return to the beginning of the current song.

Driving P. 537

Automatic Transmission P. 558

- Always depress the brake pedal before selecting **P** or changing the gear position from **P**.
- Select **P** and depress the brake pedal when starting the engine.
- Gear selection

Gear Position Indicator

The gear position indicator and the shift button indicator indicate the current gear selection.



Gear Position Indicator



Shift Button Indicator



P

Park

Press the **P** button.

Used when parking or before turn off or start the engine.
Transmission is locked.

R

Reverse

Pull back the **R** button.

Used when reversing.

N

Neutral

Press the **N** button.

Transmission is not locked.

D/S

Drive/S Position

Each time you press the **D/S** button, the mode switches between Drive and S Position mode.

Drive

- Normal driving (gears change between 1st and 10th automatically)
- Temporarily driving in the sequential mode

S Position

- Automatically changing gears between 1st and 8th (8th gear is used only at high speed)
- Driving in the sequential mode

Paddle Shifters P. 565

- Paddle shifters allow you to shift gears much like a manual transmission (1st through 10th). This is useful for engine braking.

Gear Position Indicator

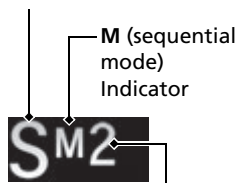

Sequential Mode Gear Selection Indicator

- D-paddle shift mode: The transmission will shift back to automatic mode once the system detects that the vehicle is cruising.
- Sequential mode gear selection: Holds the selected gear, and the **M** (sequential mode) indicator comes on.
- The sequential mode gear selection is shown in the instrument panel.

Shift Down 
Paddle Shifter



Shift Up 
Paddle Shifter



VSA® On and Off P. 575

- The Vehicle Stability Assist™ (VSA®) system helps stabilize the vehicle during cornering, and helps maintain traction while accelerating on loose or slippery road surfaces.
- VSA® comes on automatically every time you start the engine.
- To partially disable or fully restore VSA® function, press and hold the button until you hear a beep.

CMBS™ On and Off

 P. 593



- When a possible frontal collision is likely unavoidable, the CMBS™ can help you to reduce the vehicle speed and the severity of the collision.
- The CMBS™ is turned on every time you start the engine.
- To turn the CMBS™ on or off, use the safety support switch.

Tire Pressure Monitoring System (TPMS) with Tire Fill Assist P. 577, 743

- The TPMS monitors tire pressure.
- TPMS is turned on automatically every time you start the engine.
- TPMS fill assist provides audible and visual guidance during tire pressure adjustment.

Refueling P. 659

Fuel recommendation: Unleaded gasoline, pump octane number 87 or higher
Fuel tank capacity: 19.5 US gal (73.8 L)

- 1 Unlock the driver's door.
 **Locking/Unlocking the Doors from the Inside**  P. 166
- 2 Press firmly and then release the area indicated by the arrow to release the fuel filler door.
- 3 After refueling, wait for about five seconds before removing the filler nozzle.

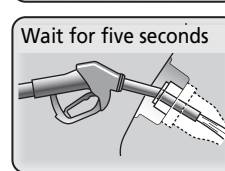

Honda Sensing®

➔ P. 586

Honda Sensing® is a driver support system which employs the use of two distinctly different kinds of sensors, a radar sensor located in the front grille and a front sensor camera mounted to the interior side of the windshield, behind the rear view mirror.

The camera is located behind the rearview mirror.

Front Sensor Camera

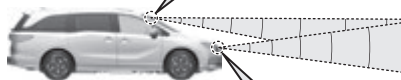
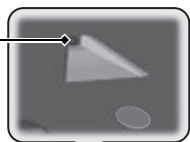

Radar Sensor

The radar sensor is in the front grille.



Collision Mitigation Braking System™ (CMBS™)

➔ P. 589

The system can assist you when it determines there is a possibility of your vehicle colliding with a vehicle or a pedestrian detected in front of your vehicle. The CMBS™ is designed to alert you when the potential for a collision is determined, as well as to reduce your vehicle speed to help minimize collision severity when a collision is deemed unavoidable.

Adaptive Cruise Control (ACC) with Low Speed Follow

➔ P. 600

Helps maintain a constant vehicle speed and a set following-interval behind a vehicle detected ahead of yours and, if the detected vehicle comes to a stop, can decelerate and stop your vehicle, without you having to keep your foot on the brake or the accelerator.

Lane Keeping Assist System (LKAS)

➔ P. 616

Provides steering input to help keep the vehicle in the middle of a detected lane and provides tactile and visual alerts if the vehicle is detected drifting out of its lane.

Road Departure Mitigation (RDM) System

➔ P. 625

Alerts and helps to assist you when the system detects a possibility of your vehicle unintentionally crossing over detected lane markings.

Traffic Sign Recognition System

➔ P. 630

Reminds you of road sign information, such as the current speed limit, your vehicle has just passed through, showing it on the driver information interface.

Maintenance P.663

Under the Hood P.673

- Check engine oil, engine coolant, and windshield washer fluid. Add when necessary.
- Check brake fluid.
- Check the battery condition monthly.

- 1 Pull the hood release handle under the corner of the dashboard.

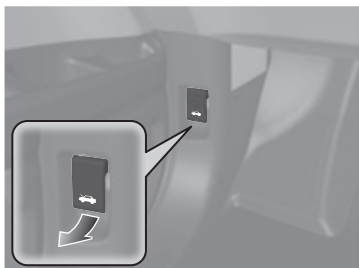

- 2 Locate the hood latch lever, pull it up, and then raise the hood. Once you have raised the hood slightly, you can release the lever.

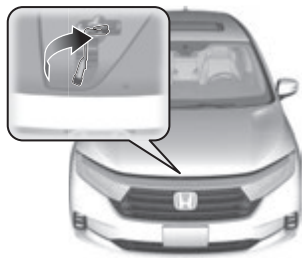

- 3 When finished, close the hood and make sure it is firmly locked in place.

Wiper Blades P.693

- Replace blades if they leave streaks across the windshield or become noisy.

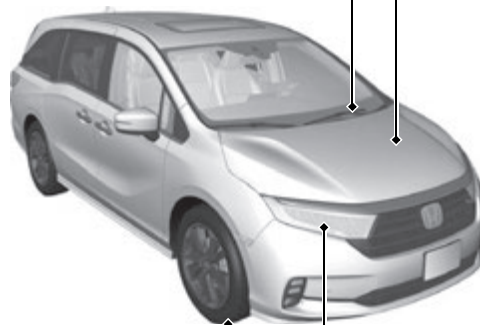

Tires P.697

- Inspect tires and wheels regularly.
- Check tire pressures regularly.
- Install snow tires for winter driving.

Lights P.686

- Inspect all lights regularly.

Handling the Unexpected P.721

Flat Tire P.723

- Park in a safe location and replace the flat tire with the compact spare tire under the floor between the front seats and the second row seats.



Engine Won't Start P.732

- If the battery is dead, jump start using a booster battery.



Overheating P.737

- Park in a safe location. If you do not see steam under the hood, open the hood, and let the engine cool down.



Indicators Come On

 P. 739

- Identify the indicator and consult the owner's manual.



Blown Fuse P.745

- Check for a blown fuse if an electrical device does not operate.

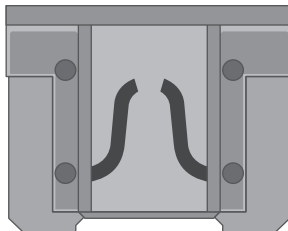

Emergency Towing P.752

- Call a professional towing service if you need to tow your vehicle.



What to Do If

Q **Canadian models**
The power mode does not change from **VEHICLE OFF (LOCK)** to **ACCESSORY**. Why?

A

- The steering wheel may be locked.
- Move the steering wheel left and right after pressing the **ENGINE START/STOP** button.



Q Why does the brake pedal pulsate slightly when applying the brakes?

A This can occur when the ABS activates and does not indicate a problem. Apply firm, steady pressure on the brake pedal. Never pump the brake pedal.

➤ Anti-lock Brake System (ABS) ➔ P 644

Q The rear door cannot be opened from inside the vehicle. Why?

A Check if the childproof lock is in the lock position. If so, open the rear door with the outside door handle. To cancel this function, slide the lever up to the unlock position.

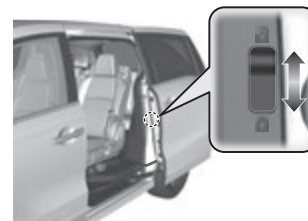

Q Why do the doors lock after I unlocked the doors?

A If you do not open the doors within 30 seconds, the doors are relocked automatically for security.

Q Why does the beeper sound when I open the driver's door?

A The beeper sounds when:

- The power mode is in ACCESSORY.
- The exterior lights are left on.
- The Auto Idle Stop is in operation.

Q **Models with keyless access system**
Why does a beeper sound when I walk away from the vehicle after I close the door?

A The buzzer sounds if you move outside the walk away auto door lock operating range before the door completely closes.

➤ Locking the doors and tailgate (Walk away auto lock®) ➔ P.161

Q Why does the beeper sound when I start driving?

A The beeper sounds when the driver and/or front passenger are not wearing their seat belts.

Q Why do I hear a screeching sound when I apply the brake pedal?

A The brake pads may need to be replaced. Have your vehicle inspected by a dealer.

Q Pulling the electric parking brake switch does not release the parking brake. Why?

A Pull the electric parking brake switch with the brake pedal depressed.

Q Depressing the accelerator pedal does not release the parking brake automatically. Why?

A

- Fasten the driver's seat belt.
- Check if the transmission is in **P** or **N**. If so, select any other position.

Q Why does the gear position automatically change to **P** when I open the driver's door to check for parking space lines when reversing?

A

- Fasten the driver's seat belt.
- Close the driver's door and manually change the gear position.
 ➤ When opening the driver's door ➔ **P. 561**

Q I'm seeing an amber indicator of a tire with an exclamation point. What is that?

A The Tire Pressure Monitoring System (TPMS) needs attention. Check tire pressure.
 ➤ Tire Pressure Monitoring System (TPMS) with Tire Fill Assist ➔ **P. 577, 743**

Safe Driving

You can find many safety recommendations throughout this chapter, and throughout this manual.

For Safe Driving

Important Safety Precautions.....	36
Your Vehicle's Safety Features.....	38
Safety Checklist.....	39

Seat Belts

About Your Seat Belts.....	40
Fastening a Seat Belt.....	43
Seat Belt Inspection.....	48

Airbags

Airbag System Components.....	49
Types of Airbags.....	52
Front Airbags (SRS).....	52

Knee Airbags.....	57
Side Airbags.....	60
Side Curtain Airbags.....	62
Airbag System Indicators.....	63
Airbag Care.....	66

Child Safety

Protecting Child Passengers.....	67
Safety of Infants and Small Children...	69
Safety of Larger Children.....	83

Exhaust Gas Hazard

Carbon Monoxide Gas.....	85
--------------------------	----

Safety Labels

Label Locations.....	86
----------------------	----

The following pages explain your vehicle's safety features and how to use them properly. The safety precautions below are ones that we consider to be among the most important.

Important Safety Precautions

■ Always wear your seat belt

A seat belt is your best protection in all types of collisions. Airbags are designed to supplement seat belts, not replace them. So even though your vehicle is equipped with airbags, make sure you and your passengers always wear your seat belts, and wear them properly.

■ Restrain all children

Children ages 12 and under should ride properly restrained in a back seat, not the front seat. Infants and small children should be restrained in a child seat. Larger children should use a booster seat and a lap/shoulder seat belt until they can use the belt properly without a booster seat.

■ Be aware of airbag hazards

While airbags can save lives, they can cause serious or fatal injuries to occupants who sit too close to them, or are not properly restrained. Infants, young children, and short adults are at the greatest risk. Be sure to follow all instructions and warnings in this manual.

■ Don't drink and drive

Alcohol and driving don't mix. Even one drink can reduce your ability to respond to changing conditions, and your reaction time gets worse with every additional drink. So don't drink and drive, and don't let your friends drink and drive, either.

▣ Important Safety Precautions

Some states, provinces and territories prohibit the use of cell phones other than hands-free devices by the driver while driving.

■ Pay appropriate attention to the task of driving safely

Engaging in cell phone conversation or other activities that keep you from paying close attention to the road, other vehicles, and pedestrians could lead to a crash. Remember, situations can change quickly, and only you can decide when it is safe to divert some attention away from driving.

■ Control your speed

Excessive speed is a major factor in crash injuries and deaths. Generally, the higher the speed, the greater the risk, but serious injuries can also occur at lower speeds. Never drive faster than is safe for current conditions, regardless of the maximum speed posted.

■ Keep your vehicle in safe condition

Having a tire blowout or a mechanical failure can be extremely hazardous. To reduce the possibility of such problems, check your tire pressures and condition frequently, and perform all regularly scheduled maintenance.

■ Do not leave children unattended in the vehicle

Children, pets and people needing assistance left unattended in the vehicle may be injured if they activate one or more of the vehicle controls. They may also cause the vehicle to move, resulting in a crash in which they and/or another person(s) can be injured or killed. Also, depending on the ambient temperature, the temperature of the interior may reach extreme levels, which can result in harm or death. Even if the climate control system is on, never leave them in the vehicle unattended as the climate control system can shut off at any time.

Your Vehicle's Safety Features

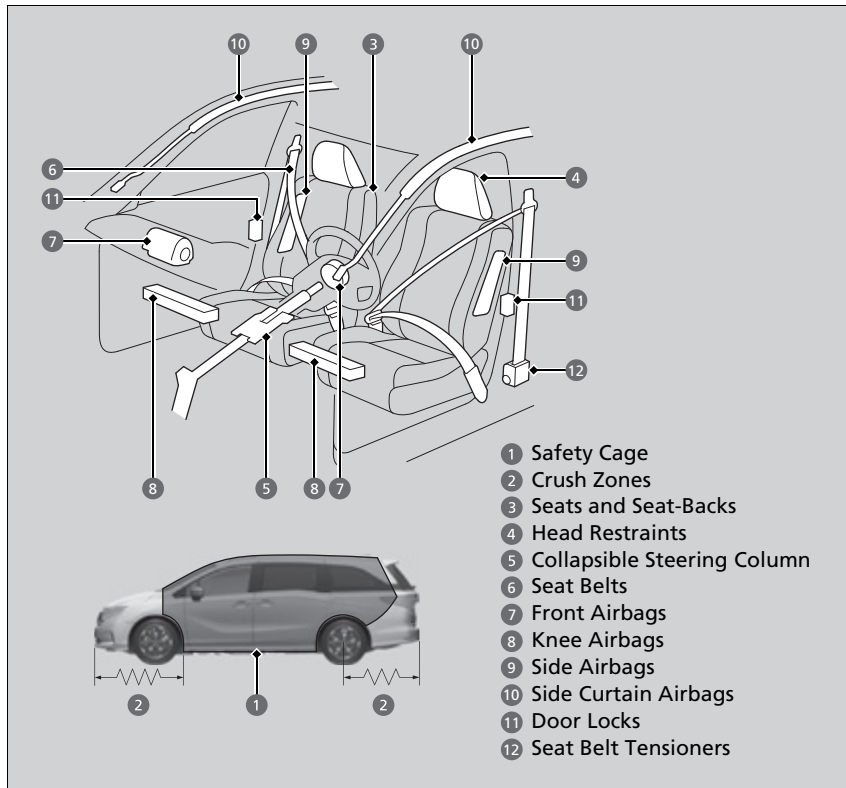

The following checklist will help you take an active role in protecting yourself and your passengers.

► Your Vehicle's Safety Features

Your vehicle is equipped with many features that work together to help protect you and your passengers during a crash.

Some features do not require any action on your part. These include a strong steel framework that forms a safety cage around the passenger compartment, front and rear crush zones, a collapsible steering column, and tensioners that tighten the front seat belts in a sufficient crash.

However, you and your passengers cannot take full advantage of these features unless you remain seated in the correct position and always wear your seat belts. In fact, some safety features can contribute to injuries if they are not used properly.

Safety Checklist

For the safety of you and your passengers, make a habit of checking these items each time before you drive.

- After everyone has entered the vehicle, be sure all doors and the tailgate are closed and locked. Locking the doors and the tailgate helps prevent an occupant from being ejected and an outsider from unexpectedly opening a door or the tailgate.
 - **Locking/Unlocking the Doors from the Inside** P. 166
- Adjust your seat to a position suitable for driving. Be sure the front seats are adjusted as far to the rear as possible while allowing the driver to control the vehicle. Sitting too close to a front airbag can result in serious or fatal injury in a crash.
 - **Seats** P. 222
- Adjust head restraints to the proper position. Head restraints are most effective when the center of the head restraint aligns with the center of your head. Taller persons should adjust their head restraint to the highest position.
 - **Adjusting the Front and Second Row Outer and Third Row Outer Head Restraints Positions** P. 235
- Always wear your seat belt, and make sure you wear it properly. Confirm that any passengers are properly belted as well.
 - **Fastening a Seat Belt** P. 43
- Protect children by using seat belts or child seats according to a child's age, height and weight.
 - **Child Safety** P. 67

☒ Safety Checklist

If the door and/or tailgate open message appears on the driver information interface, a door and/or the tailgate is not completely closed. Close all doors and the tailgate tightly until the message disappears.

➤ **Driver Information Interface Warning and Information Messages** P. 108

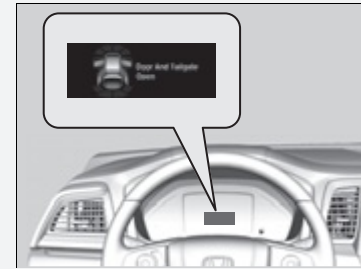

About Your Seat Belts

Seat belts are the single most effective safety device because they keep you connected to the vehicle so that you can take advantage of many built-in safety features. They also help keep you from being thrown against the inside of the vehicle, against any passengers, or out of the vehicle. When worn properly, seat belts also keep your body properly positioned in a crash so that you can take full advantage of the additional protection provided by the airbags.

In addition, seat belts help protect you in almost every type of crash, including:

- frontal impacts
- side impacts
- rear impacts
- rollovers

■ Lap/shoulder seat belts

All seven or eight seating positions are equipped with lap/shoulder seat belts with emergency locking retractors. In normal driving the retractor lets you move freely while keeping some tension on the belt.

During a collision or sudden stop the retractor locks to restrain your body. The front, second, and third row passenger's seat belts also have a lockable retractor for use with child seats.

➤ **Installing a Child Seat with a Lap/Shoulder Seat Belt** P. 77

>About Your Seat Belts

WARNING

Not wearing a seat belt properly increases the chance of serious injury or death in a crash, even though your vehicle has airbags.

Be sure you and your passengers always wear seat belts and wear them properly.

Seat belts cannot completely protect you in every crash. But in most cases, seat belts can reduce your risk of serious injury.

Most states and all Canadian provinces and territories require you to wear seat belts.

If you extend the seat belt too quickly, it will lock in place. If this happens, slightly retract the seat belt, then extend it slowly.

■ Proper use of seat belts

Follow these guidelines for proper use:

- All occupants should sit upright, well back in the seat, and remain in that position for the duration of the trip. Slouching and leaning reduce the effectiveness of the belt and can increase the chance of serious injury in a crash.
- Never place the shoulder part of a lap/shoulder seat belt under your arm or behind your back. This could cause very serious injuries in a crash.
- Two people should never use the same seat belt. If they do, they could be very seriously injured in a crash.
- Do not put any accessories on the seat belts. Devices intended to improve comfort or reposition the shoulder part of a seat belt can reduce the protective capability and increase the chance of serious injury in a crash.

■ Seat Belt Reminder



The seat belt system includes an indicator on the instrument panel to remind the driver or a front passenger or both to fasten their seat belts.

If you set the power mode to ON and a seat belt is not fastened, a beeper will sound and the indicator will blink. After a few seconds, the beeper will stop and the indicator will come on and remain illuminated until the seat belt is fastened.

The beeper will periodically sound and the indicator will blink while the vehicle is moving until the seat belt is fastened.

▣ About Your Seat Belts

If a rear seat passenger moves around and extends the seat belt, the lockable retractor may activate. If this happens, release the retractor by unfastening the seat belt and allow the belt to retract completely. Then, refasten the belt.

▣ Seat Belt Reminder

The indicator will also come on if a front passenger does not fasten their seat belt within six seconds after the power mode is set to ON. When no one is sitting in the front passenger's seat, the indicator will not come on and the beeper will not sound. The indicator also may not come on and the beeper may not sound when the occupant is not heavy enough to trigger the weight sensor. Such occupants (e.g., infants and smaller children) should be moved to the rear seat as a deploying front airbag likely will injure or kill them.

▣ **Protecting Child Passengers** P. 67

■ Automatic Seat Belt Tensioners

The front seats are equipped with automatic seat belt tensioners to enhance safety.

The tensioners automatically tighten the front seat belts during a moderate-to-severe frontal collision, sometimes even if the collision is not severe enough to inflate the front airbags or the knee airbags.

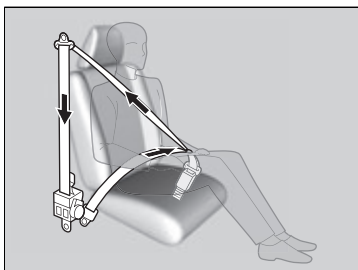

▶ Automatic Seat Belt Tensioners

The seat belt tensioners can only operate once. If a tensioner is activated, the SRS indicator will come on. Have a dealer replace the tensioner and thoroughly inspect the seat belt system as it may not offer protection in a subsequent crash.

During a moderate-to-severe side impact, the tensioner on that side of the vehicle also activates.

Fastening a Seat Belt

After adjusting a front seat to the proper position, and while sitting upright and well back in the seat:

➤ **Seats** P. 222

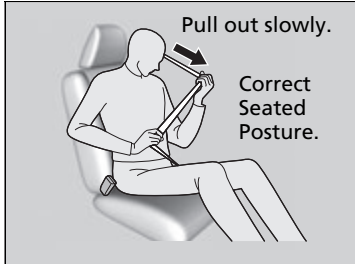

1. Pull the seat belt out slowly.

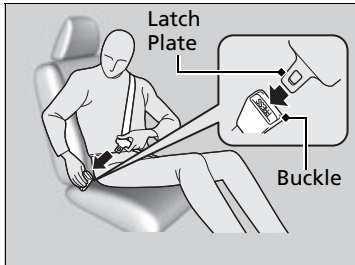

2. Insert the latch plate into the buckle, then tug on the belt to make sure the buckle is secure.

▶ Make sure that the belt is not twisted or caught on anything.

Fastening a Seat Belt

No one should sit in a seat with an inoperative seat belt or one that does not appear to be working correctly. Using a seat belt that is not working properly may not protect the occupant in a crash. Have a dealer check the belt as soon as possible.

Never insert any foreign objects into the buckle or retractor mechanism.

If the seat belt appears to be locked in a fully retracted position, firmly pull out on the shoulder belt once, then push it back in.

Then, smoothly pull it out of the retractor and fasten. If you are unable to release the seat belt from a fully retracted position, do not allow anyone to sit in the seat, and take your vehicle to a dealer for repair.

➤ **About Your Seat Belts** P. 40

➤ **Seat Belt Inspection** P. 48

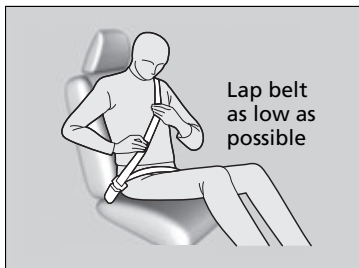

3. Position the lap part of the belt as low as possible across your hips, then pull up on the shoulder part of the belt so the lap part fits snugly. This lets your strong pelvic bones take the force of a crash and reduces the chance of internal injuries.
4. If necessary, pull up on the belt again to remove any slack, then check that the belt rests across the center of your chest and over your shoulder. This spreads the forces of a crash over the strongest bones in your upper body.

▶▶ Fastening a Seat Belt

⚠ WARNING

Improperly positioning the seat belts can cause serious injury or death in a crash.

Make sure all seat belts are properly positioned before driving.

To release the belt, push the red **PRESS** button and then guide the belt by hand until it has retracted completely.

When exiting the vehicle, be sure the belt is properly stowed so that it will not get caught in the closing door.

▶▶ Adjusting the Shoulder Anchor

The shoulder anchor height can be adjusted to four levels. If the belt contacts your neck, lower the height one level at a time.

After an adjustment, make sure that the shoulder anchor position is secure.

■ Adjusting the Shoulder Anchor

The front seats have adjustable shoulder anchors to accommodate taller and shorter occupants.

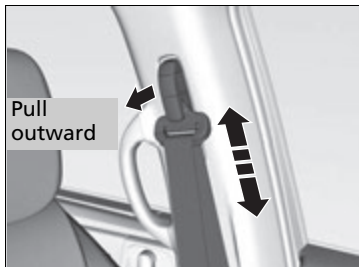

1. Move the anchor up and down while pulling the shoulder anchor outward.
2. Position the anchor so that the belt rests across the center of your chest and over your shoulder.

Seat Belt with Detachable Anchor

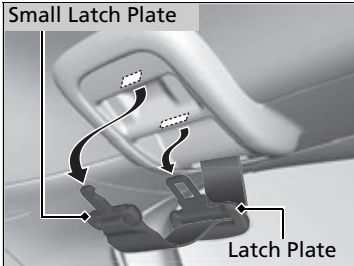

1. Pull out the seat belt's small latch plate and the latch plate from each holding slot in the ceiling.

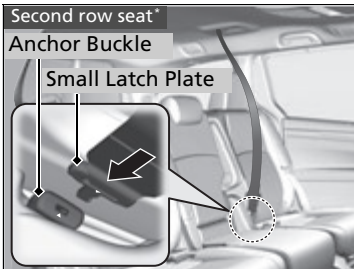

2. Line up the triangle marks on the small latch plate and anchor buckle. Make sure the seat belt is not twisted. Attach the belt to the anchor buckle.

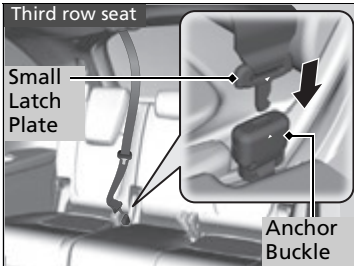

Seat Belt with Detachable Anchor

⚠ WARNING

Using the seat belt with the detachable anchor unlatched increases the chance of serious injury or death in a crash.

Before using the seat belt, make sure the detachable anchor is correctly latched.

* Not available on all models

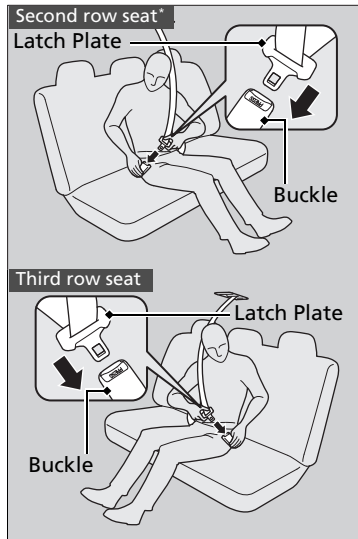

3. Insert the latch plate into the buckle. Properly fasten the seat belt the same way you fasten the lap/shoulder seat belt.

▶▶ Seat Belt with Detachable Anchor

To unlatch the detachable anchor, insert the latch plate into the slot on the side of the anchor buckle.

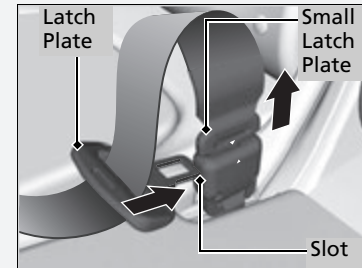

▶▶ Second row center seat*

Pivot down the anchor buckle forward. Insert the latch plate into the slot on the back of the anchor buckle.

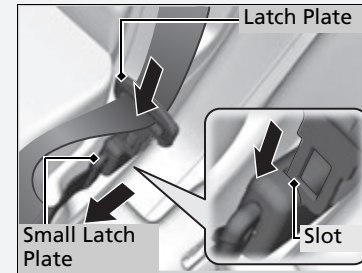

Advice for Pregnant Women

If you are pregnant, the best way to protect yourself and your unborn child when driving or riding in a vehicle is to always wear a seat belt and keep the lap part of the belt as low as possible across the hips.

Wear the shoulder belt across the chest avoiding the abdomen.



Wear the lap part of the belt as low as possible across the hips.

Advice for Pregnant Women

Each time you have a checkup, ask your doctor if it is okay for you to drive.

To reduce the risk of injuries to both you and your unborn child that can be caused by an inflating front airbag:

- When driving, sit upright and adjust the seat as far back as possible while allowing full control of the vehicle.
- When sitting in the front passenger's seat, adjust the seat as far back as possible.

Seat Belt Inspection

Regularly check the condition of your seat belts as follows:

- Pull each belt out fully, and look for frays, cuts, burns, and wear.
- Check that the latch plates and buckles work smoothly and the belts retract easily.
 - ▶ If a belt does not retract easily, cleaning the belt may correct the problem. Only use a mild soap and warm water. Do not use bleach or cleaning solvents. Make sure the belt is completely dry before allowing it to retract.

Any belt that is not in good condition or working properly will not provide proper protection and should be replaced as soon as possible.

A belt that has been worn during a crash may not provide the same level of protection in a subsequent crash. Have your seat belts inspected by a dealer after any collision.

▶▶ Seat Belt Inspection

WARNING

Not checking or maintaining seat belts can result in serious injury or death if the seat belts do not work properly when needed.

Check your seat belts regularly and have any problem corrected as soon as possible.

Airbag System Components

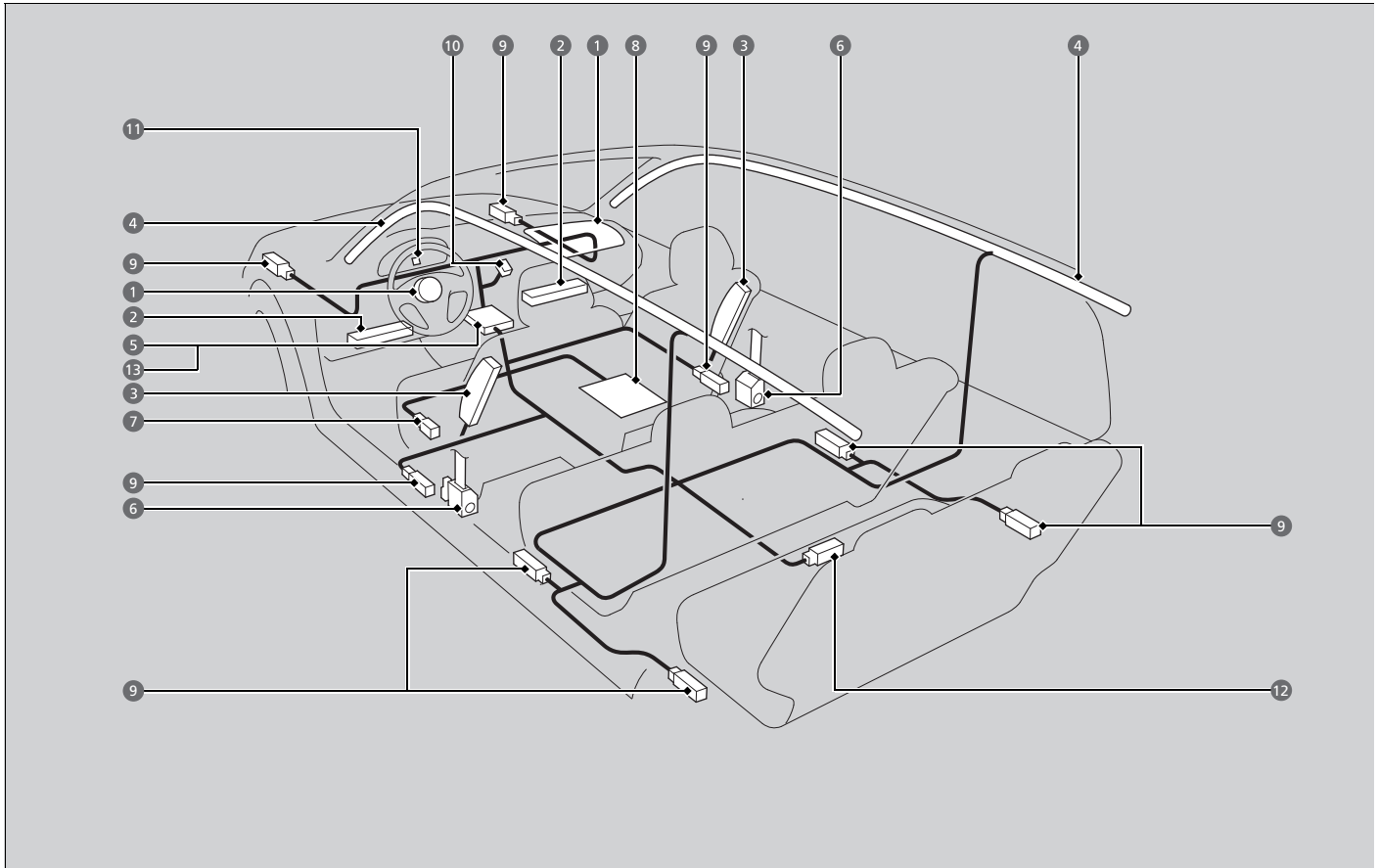

The front, driver's knee, front passenger's knee, side, and side curtain airbags are deployed according to the direction and severity of impact. Both side curtain airbags are deployed in a rollover. The airbag system includes:

- 1 Two SRS (Supplemental Restraint System) front airbags. The driver's airbag is stored in the center of the steering wheel; the front passenger's airbag is stored in the dashboard. Both are marked **SRS AIRBAG**.
- 2 Two knee airbags. The driver's knee airbag is stored under the steering column; the front passenger's knee airbag is stored under the glove box. Both are marked **SRS AIRBAG**.
- 3 Two side airbags, one for the driver and one for the front passenger. The airbags are stored in the outer edges of the seat-backs. Both are marked **SIDE AIRBAG**.
- 4 Two side curtain airbags, one for each side of the vehicle. The airbags are stored in the ceiling, above the side windows.

The front and rear pillars are marked **SIDE CURTAIN AIRBAG**.

- 5 An electronic control unit that, when the vehicle is on, continually monitors information about the various impact sensors, seat and buckle sensors, rollover sensor, airbag activators, seat belt tensioners, and other vehicle information. During a crash event the unit can record such information.
- 6 Automatic front seat belt tensioners. In addition, the driver's and front passenger's seat belt buckles incorporate sensors that detect whether or not the belts are fastened.
- 7 Driver's seat position sensor. This sensor detects the driver's seat slide position to help determine the optimal deployment of the driver's airbag.
- 8 Weight sensors in the front passenger's seat. The sensors are used for occupant classification to activate or deactivate the front passenger's airbag.

- 9 Impact sensors that can detect a moderate-to-severe front or side impact.
- 10 An indicator on the dashboard that alerts you that the front passenger's front airbag has been turned off.
- 11 An indicator on the instrument panel that alerts you to a possible problem with your airbag system or seat belt tensioners.
- 12 Safing Sensor
- 13 A rollover sensor that can detect if your vehicle is about to roll over and signal the control unit to deploy both side curtain airbags.

■ Important facts about your airbags

Airbags can pose serious hazards. To do their job, airbags must inflate with tremendous force. So, while airbags help save lives, they can cause burns, bruises, and other minor injuries, sometimes even fatal ones if occupants are not wearing their seat belts properly and sitting correctly.

What you should do: Always wear your seat belt properly and sit upright and as far back from the steering wheel as possible while allowing full control of the vehicle. A front passenger should move their seat as far back from the dashboard as possible.

Remember, however, that no safety system can prevent all injuries or deaths that can occur in a severe crash, even when seat belts are properly worn and the airbags deploy.

Do not place hard or sharp objects between yourself and a front airbag.

Carrying hard or sharp objects on your lap, or driving with a pipe or other sharp object in your mouth, can result in injuries if your front airbag inflates.

Do not attach or place objects on the front, driver's knee and front passenger's knee airbag covers. Objects on the covers marked **SRS AIRBAG** could interfere with the proper operation of the airbags or be propelled inside the vehicle and hurt someone if the airbags inflate.

▣ Important facts about your airbags

Do not attempt to deactivate your airbags. Together, airbags and seat belts provide the best protection.

When driving, keep hands and arms out of the deployment path of the front airbag by holding each side of the steering wheel. Do not cross an arm over the airbag cover.

Types of Airbags

Your vehicle is equipped with four types of airbags:

- **Front airbags:** Airbags in front of the driver's and front passenger's seats.
- **Knee airbags:** Airbags under the steering column and under the glove box.
- **Side airbags:** Airbags in the driver's and front passenger's seat-backs.
- **Side curtain airbags:** Airbags above the side windows.

Each is discussed in the following pages.

Front Airbags (SRS)

The front SRS airbags inflate in a moderate-to-severe frontal collision to help protect the head and chest of the driver and/or front passenger.

SRS (Supplemental Restraint System) indicates that the airbags are designed to supplement seat belts, not replace them. Seat belts are the occupant's primary restraint system.

Housing Locations

The front airbags are housed in the center of the steering wheel for the driver, and in the dashboard for the front passenger. Both airbags are marked **SRS AIRBAG**.

Types of Airbags

The airbags can inflate whenever the power mode is in ON.

After an airbag inflates in a crash, you may see a small amount of smoke. This is from the combustion process of the inflator material and is not harmful. People with respiratory problems may experience some temporary discomfort. If this occurs, get out of the vehicle as soon as it is safe to do so.

Front Airbags (SRS)

During a frontal crash severe enough to cause one or both front airbags to deploy, the airbags can inflate at different rates, depending on the severity of the crash, whether or not the seat belts are latched, and/or other factors. Frontal airbags are designed to supplement the seat belts to help reduce the likelihood of head and chest injuries in frontal crashes.

■ Operation

Front airbags are designed to inflate during moderate-to-severe frontal collisions. When the vehicle decelerates suddenly, the sensors send information to the control unit which signals one or both front airbags to inflate.

A frontal collision can be either head-on or angled between two vehicles, or when a vehicle crashes into a stationary object, such as a concrete wall.

■ How the Front Airbags Work

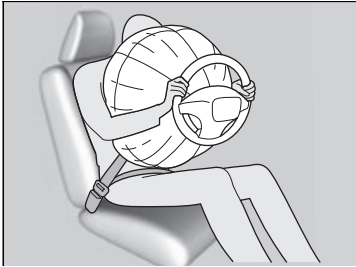

While your seat belt restrains your torso, the front airbag provides supplemental protection for your head and chest.

The front airbags deflate immediately so that they won't interfere with the driver's visibility or the ability to steer or operate other controls.

The total time for inflation and deflation is so fast that most occupants are not aware that the airbags deployed until they see them lying in front of them.

▣ How the Front Airbags Work

Although the driver's and front passenger's airbags normally inflate within a split second of each other, it is possible for only one airbag to deploy. This can happen if the severity of a collision is at the margin, or threshold, that determines whether or not the airbags will deploy. In such cases, the seat belt will provide sufficient protection, and the supplemental protection offered by the airbag would be minimal.

■ When front airbags should not deploy

Minor frontal crashes: Front airbags were designed to supplement seat belts and help save lives, not to prevent minor scrapes, or even broken bones that might occur during a less than moderate-to-severe frontal crash.

Side impacts: Front airbags can provide protection when a sudden deceleration causes a driver or front passenger to move toward the front of the vehicle. Side airbags and side curtain airbags have been specifically designed to help reduce the severity of injuries that can occur during a moderate-to-severe side impact which can cause the driver or passenger to move toward the side of the vehicle.

Rear impacts: Head restraints and seat belts are your best protection during a rear impact. Front airbags cannot provide any significant protection and are not designed to deploy in such collisions.

Rollovers: In a rollover, your best form of protection is a seat belt or, if your vehicle is equipped with a rollover sensor, both a seat belt and a side curtain airbag. Front airbags, however, are not designed to deploy in a rollover as they would provide little if any protection.

■ When front airbags deploy with little or no visible damage

Because the airbag system senses sudden deceleration, a strong impact to the vehicle framework or suspension might cause one or more of the airbags to deploy. Examples include running into a curb, the edge of a hole, or other low fixed object that causes a sudden deceleration in the vehicle chassis. Since the impact is underneath the vehicle, damage may not be readily apparent.

■ When front airbags may not deploy, even though exterior damage appears severe

Since crushable body parts absorb crash energy during an impact, the amount of visible damage does not always indicate proper airbag operation. In fact, some collisions can result in severe damage but no airbag deployment because the airbags would not have been needed or would not have provided protection even if they had deployed.

Advanced Airbags

The airbags have advanced features to help reduce the likelihood of airbag related injuries to smaller occupants.

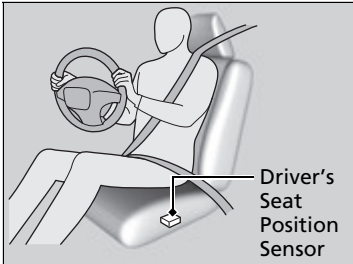

The driver's advanced airbag system includes a seat position sensor.

Based on information from this sensor and the severity of the impact, the advanced airbag system determines the optimal deployment of the driver's airbag.

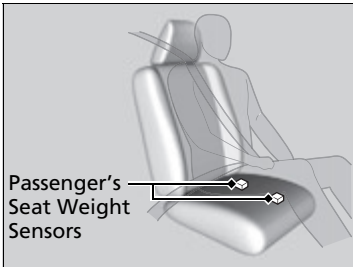

The front passenger's advanced airbag system has weight sensors. The sensors are used for occupant classification to activate or deactivate the front passenger's airbag.

For adult size occupants, the system will automatically activate the front passenger's airbag. If a small adult sits in the front passenger seat and the system does not recognize him/her as an adult, see

▶ **Passenger Airbag Off Indicator** P. 64

Advanced Airbags

If there is a problem with the driver's seat position sensor or the passenger's seat weight sensors, the SRS indicator will come on, and in the event of a crash, the airbag will deploy (regardless of the driver's seating position or passenger's occupant classification) with a force corresponding to the severity of the impact.

▶ Supplemental Restraint System (SRS) Indicator P. 63

For the advanced front airbags to work properly, confirm that:

- The occupant is sitting in an upright position, wearing the seat belt properly and the seat back is not excessively reclined.
- The occupant is not leaning against the door or center console.
- The occupant's feet are placed on the floor in front of them.
- There are no objects hanging from the front passenger's seat.
- Only small, lightweight objects are in the seat back pocket.
- The steering wheel and passenger's side dashboard are not obstructed by any object.
- No liquid has been spilled on or under the seat.
- There is no child seat or other object pressing against the rear of the seat or seat back.
- There is no rear passenger pushing or pulling on the back of the front passenger's seat.

We advise against allowing a child age 12 or under to ride in the front passenger's seat. However, if you do allow a small child or infant to ride in the front passenger's seat, the system is designed to automatically deactivate the front passenger's airbag. Do not let a small child or infant ride in the front passenger's seat if the airbag does not automatically deactivate.

Advanced Airbags

- There are no objects placed under or beside the front passenger's seat. Improperly positioned objects can interfere with the advanced airbag sensors.
- The head restraint is not contacting the roof.
 - **Passenger Airbag Off Indicator** P. 64
- The floor mat behind the front passenger's seat is hooked to the floor mat anchor. An improperly placed mat can interfere with the advanced airbag sensors.
 - **Floor Mats** P. 713

Knee Airbags

The knee SRS airbags inflate in a moderate-to-severe frontal collision to help keep the driver and/or front passenger in the proper position and to help maximize the benefit provided by the vehicle's other safety features.

SRS (Supplemental Restraint System) indicates that the airbag is designed to supplement seat belts, not replace them. Seat belts are the occupant's primary restraint system.

Housing Locations

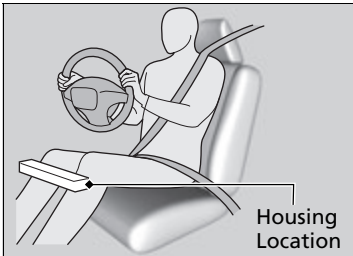

The knee airbag for the driver and the one for the front passenger are housed under the steering column and the glove box respectively.

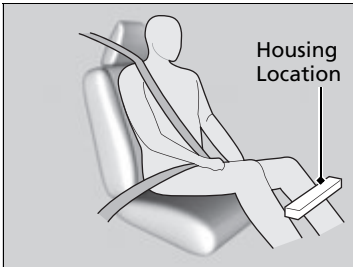

Both are marked **SRS AIRBAG**.

⚠ Knee Airbags

Do not attach accessories on or near a knee airbag as they can interfere with the proper operation of the airbag, or even hurt someone if the airbag inflates.

The driver and front passenger should not store any items under the seat or behind their feet. The items can interfere with proper airbag deployment in the event of a moderate to severe frontal collision and may result in inadequate protection.

■ Operation

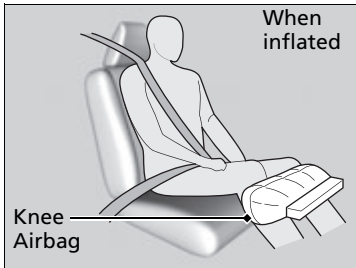
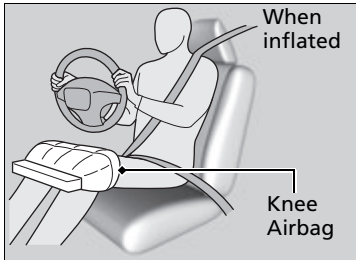

The driver's and front passenger's knee airbag deploy at the same time as the driver's and front passenger's airbag respectively.

Even if the collision is not severe enough to deploy the front airbag, the knee airbag may inflate alone.

■ When a knee airbag deploys with little or no visible damage

Because the airbag system senses sudden deceleration, a strong impact to the vehicle framework or suspension might cause one or more of the airbags to deploy. Examples include running into a curb, the edge of a hole, or other low fixed object that causes a sudden deceleration in the vehicle chassis. Since the impact is underneath the vehicle, damage may not be readily apparent.

■ When a knee airbag may not deploy, even though exterior damage appears severe

Since crushable body parts absorb crash energy during an impact, the amount of visible damage does not always indicate proper airbag operation. In fact, some collisions can result in severe damage but no airbag deployment because the airbags would not have been needed or would not have provided protection even if they had deployed.

Side Airbags

The side airbags help protect the torso and pelvis of the driver or a front passenger during a moderate-to-severe side impact.

Housing Locations

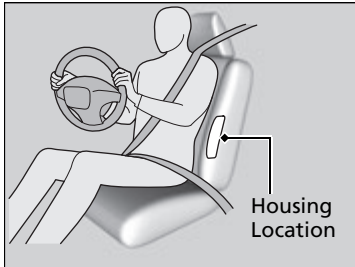

The side airbags are housed in the outside edge of the driver's and passenger's seat-backs.

Both are marked **SIDE AIRBAG**.

Operation

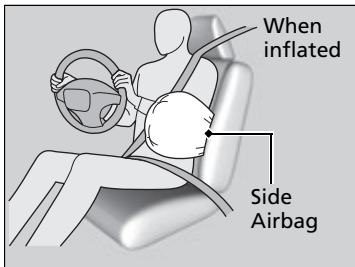

When the sensors detect a moderate-to-severe side impact, the control unit signals the side airbag on the impact side to immediately inflate.

Side Airbags

Make sure you and your front seat passenger always sit upright. Leaning into the path of a side airbag can prevent the airbag from deploying properly and increases your risk of serious injury.

Do not attach accessories on or near the side airbags. They can interfere with the proper operation of the airbags, or hurt someone if an airbag inflates.

Do not cover or replace the front seat-back covers without consulting a dealer. Improperly replacing or covering front seat-back covers can prevent your side airbags from properly deploying during a side impact.

■ When a side airbag deploys with little or no visible damage

Because the airbag system senses sudden acceleration, a strong impact to the side of the vehicle's framework can cause a side airbag to deploy. In such cases, there may be little or no damage, but the side impact sensors detected a severe enough impact to deploy the airbag.

■ When a side airbag may not deploy, even though visible damage appears severe

It is possible for a side airbag not to deploy during an impact that results in apparently severe damage. This can occur when the point of impact was toward the far front or rear of the vehicle, or when the vehicle's crushable body parts absorbed most of the crash energy. In either case, the side airbag would not have been needed nor provided protection even if it had deployed.

Side Curtain Airbags

The side curtain airbags help protect the heads of the driver and passengers in the outer seating positions during a moderate-to-severe side impact. The side curtain airbags equipped in this vehicle are also designed to help reduce the likelihood of partial and complete ejection of vehicle occupants through side windows in crashes, particularly rollover crashes.

Housing Locations

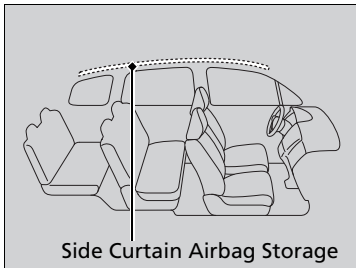

The side curtain airbags are located in the ceiling above the side windows on both sides of the vehicle.

Operation

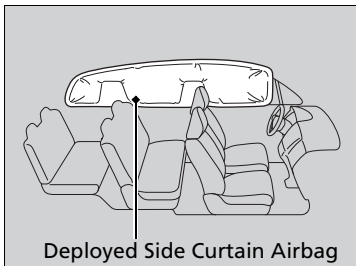

The side curtain airbag is designed to deploy in a rollover or a moderate-to-severe side impact.

Side Curtain Airbags

If the SRS control unit senses that your vehicle is about to rollover, it immediately deploys both side curtain airbags and activates both front seat belt tensioners.

If the impact is on the passenger's side, the passenger's side curtain airbag deploys even if there are no occupants on that side of the vehicle.

To get the best protection from the side curtain airbags, occupants should wear their seat belts properly and sit upright and well back in their seats.

Do not attach any objects to the side windows or roof pillars as they can interfere with the proper operation of the side curtain airbags.

■ When side curtain airbags deploy in a frontal collision

One or both side curtain airbags may also inflate in a moderate-to-severe angled frontal collision.

Airbag System Indicators

If a problem occurs in the airbag system, the SRS indicator will come on and a message appears on the driver information interface.

■ Supplemental Restraint System (SRS) Indicator



■ When the power mode is set to ON.

The indicator comes on for a few seconds, then goes off. This tells you the system is working properly.

If the indicator comes on at any other time, or does not come on at all, have the system checked by a dealer as soon as possible. If you don't, your airbags and seat belt tensioners may not work properly when they are needed.

⊠ Supplemental Restraint System (SRS) Indicator

⚠ WARNING

Ignoring the SRS indicator can result in serious injury or death if the airbag systems or tensioners do not work properly.

Have your vehicle checked by a dealer as soon as possible if the SRS indicator alerts you to a possible problem.

Continued

■ Passenger Airbag Off Indicator

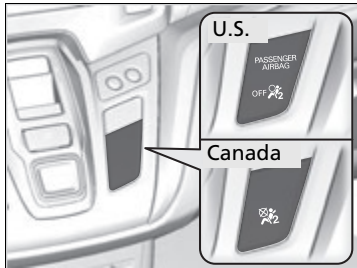

■ When the passenger airbag off indicator comes on

The indicator comes on to alert you that the passenger's airbag has been turned off. This occurs if the seat is empty or when the weight sensors determine that a small child or infant is on the passenger seat.

Children age 12 or under should always ride properly restrained in a back seat.

➤ **Child Safety** P. 67

If the indicator is on in the event of a crash, the passenger's airbag will not deploy. The passenger's knee airbag will not deploy, either.

☒ Passenger Airbag Off Indicator

To ensure the passenger is detected properly, confirm that:

- The occupant is sitting in an upright position, wearing the seat belt properly and the seat back is not excessively reclined.
- The occupant is not leaning against the door or center console.
- The occupant's feet are placed on the floor in front of them.
- There are no objects hanging from the front passenger's seat.
- Only small, lightweight objects are in the seat back pocket.
- No liquid has been spilled on or under the seat.
- There is no child seat or other object pressing against the rear of the seat or seat back.
- There is no rear passenger pushing or pulling on the back of the front passenger's seat.
- There are no objects placed under or beside the front passenger's seat. Improperly positioned objects can interfere with the advanced airbag sensors.
- The floor mat behind the front passenger's seat is hooked to the floor mat anchor. An improperly placed mat can interfere with the advanced airbag sensors.
- The head restraint is not contacting the roof.

Passenger Airbag Off Indicator

The passenger airbag off indicator may come on and go off periodically if the total weight on the seat is near the airbag cutoff threshold. For a small adult, depending on physique and posture, the system may not recognize him/her as an adult and thus deactivate the passenger's airbag.

If this occurs, please confirm that the conditions set forth in the above bullet points on the previous page are met.

If the above conditions are met and the indicator is still on, then with the transmission in park, turn the ignition off and back on.

Have your vehicle checked by a dealer as soon as possible if:

- All of the above conditions are met, and the indicator comes on with an adult seated in the front passenger seat.
- The seat is empty and the indicator is off.

Do not allow an adult passenger to ride in the front seat when the indicator is on.

Airbag Care

You do not need to, and should not, perform any maintenance on or replace any airbag system components yourself. However, you should have your vehicle inspected by a dealer in the following situations:

■ When the airbags have deployed

If an airbag has inflated, the control unit and other related parts must be replaced. Similarly, once an automatic seat belt tensioner has been activated, it must be replaced.

■ When the vehicle has been in a moderate-to-severe collision

Even if the airbags did not inflate, have your dealer inspect the following: the driver's seat position sensor, weight sensors in the passenger's seat, front seat belt tensioners, and each seat belt that was worn during the crash.

■ Do not remove or modify a front seat without consulting a dealer

This would likely disable or affect the proper operation of the driver's seat position sensor or the weight sensors in the passenger's seat. If it is necessary to remove or modify a front seat to accommodate a person with disabilities, contact a Honda dealer, or for U.S. vehicles, American Honda Automobile Customer Service at 1-800-999-1009 and for Canadian vehicles, Honda Canada Customer Relations at 1-888-9-HONDA-9.

✎ Airbag Care

We recommend against the use of salvaged airbag system components, including the airbag, tensioners, sensors, and control unit.

Protecting Child Passengers

Each year, many children are injured or killed in vehicle crashes because they are either unrestrained or not properly restrained. In fact, vehicle crashes are the number one cause of death of children ages 12 and under.

To reduce the number of child deaths and injuries, every state, Canadian province and territory requires that infants and children be properly restrained when they ride in a vehicle.

Children should sit properly restrained in a rear seat. This is because:

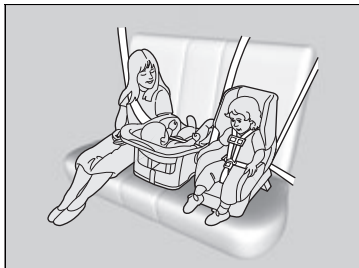

- An inflating front airbag can injure or kill a child sitting in the front seat.
- A child in the front seat is more likely to interfere with the driver's ability to safely control the vehicle.
- Statistics show that children of all sizes and ages are safer when they are properly restrained in a rear seat.

Protecting Child Passengers

⚠ WARNING

Children who are unrestrained or improperly restrained can be seriously injured or killed in a crash.

Any child too small for a seat belt should be properly restrained in a child seat. A larger child should be properly restrained with a seat belt, using a booster seat if necessary.

The National Highway Traffic Safety Administration and Transport Canada recommend that all children ages 12 and under be properly restrained in a rear seat. Some states or provinces/territories have laws restricting where children may ride.

- Any child who is too small to wear a seat belt correctly must be restrained in an approved child seat that is properly secured to the vehicle using either the seat belt or the lower anchors of the LATCH system.
- Never hold a child on your lap because it is impossible to protect them in the event of a collision.
- Never put a seat belt over yourself and a child. During a crash, the belt would likely press deep into the child and cause serious or fatal injuries.
- Never let two children use the same seat belt. Both children could be very seriously injured in a crash.
- Do not allow children to operate the doors, windows or seat adjustments.
- Do not leave children in the vehicle unattended, especially in hot weather when the inside of the vehicle can get hot enough to kill them. They could also activate vehicle controls causing it to move unexpectedly.

► Protecting Child Passengers

⚠ WARNING

Allowing a child to play with a seat belt or wrap one around their neck can result in serious injury or death.

Instruct children not to play with any seat belt and make sure any unused seat belt a child can reach is buckled, fully retracted, and locked.

To deactivate a lockable retractor, release the buckle and allow the seat belt to wind up all the way.

To remind you of the passenger's front airbag hazards and child safety, your vehicle has warning labels on the dashboard (U.S. models) and on the front visors. Please read and follow the instructions on these labels.

➤ Safety Labels P. 86

Safety of Infants and Small Children

■ Protecting Infants

An infant must be properly restrained in a rear-facing child seat until the infant reaches the seat manufacturer's weight or height limit for the seat.

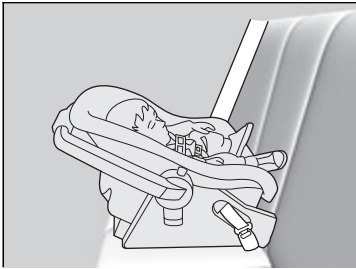

■ Positioning a rear-facing child seat
Child seats must be placed and secured in a rear seating position.

When properly installed, a rear-facing child seat may prevent the driver or a front passenger from moving their seat all the way back, or from locking their seat-back in the desired position. Make sure that there is no contact between the child seat and the seat in front of it.

It can also interfere with proper operation of the passenger's advanced front airbag system.

➤ **Airbags** P. 49

If this occurs, we recommend that you install the child seat directly behind the front passenger's seat, move the seat as far forward as needed, and leave it unoccupied. Or, you may wish to get a smaller rear-facing child seat.

☒ Protecting Infants

⚠ WARNING

Placing a rear-facing child seat in the front seat can result in serious injury or death during a crash.

Always place a rear-facing child seat in the rear seat, not the front.

Experts recommend use of a rear-facing seat for a child so long as the child's height and weight are appropriate for a rear-facing seat.

Infants should never be seated in a forward-facing position.

Always refer to the child seat manufacturer's instructions before installation.

Do not allow a front seat to rest against a child seat installed in a rear seating position. The weight sensor in the front seat may not correctly detect the actual weight of the occupant.

■ Protecting Smaller Children

If a child has exceeded the weight and height limitations of a rearward-facing child seat, the child should be properly restrained in a firmly secured forward-facing child seat until they exceed the weight and height limitations for the forward-facing child seat.

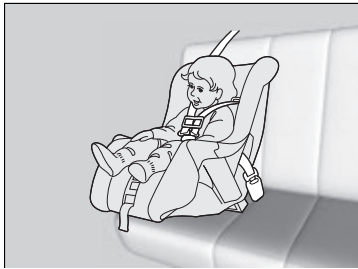

■ Forward-facing child seat placement

We strongly recommend placing a forward-facing child seat in a rear seating position.

Placing a forward-facing child seat in the front seat can be hazardous, even with advanced front airbags that automatically turn the passenger's front airbag off. A rear seat is the safest place for a child.

▶▶ Protecting Smaller Children

⚠ WARNING

Placing a forward-facing child seat in the front seat can result in serious injury or death if the front airbag inflates.

If you must place a forward-facing child seat in front, move the vehicle seat as far back as possible, and properly restrain the child.

Educate yourself about the laws and regulations regarding child seat use where you are driving, and follow the child seat manufacturer's instructions.

■ Selecting a Child Seat

Most child seats are LATCH-compatible (Lower Anchors and Tethers for Children). Some have a rigid-type connector while others have a flexible-type connector. Both are equally easy to use. Some existing and previously owned child seats can only be installed using the seat belt. Whichever type you choose, follow the child seat manufacturer's use and care instructions including recommended expiration dates as well as the instructions in this manual. Proper installation is key to maximizing your child's safety.

In seating positions and vehicles not equipped with LATCH, a LATCH-compatible child seat can be installed using the seat belt and a top tether for added security. This is because all child seats are required to be designed so that they can be secured with a lap belt or the lap part of a lap/shoulder belt. In addition, the child seat manufacturer may advise that a seat belt be used to attach a LATCH-compatible seat once a child reaches a specified weight. Please read the child seat owner's manual for proper installation instructions.

■ Important consideration when selecting a child seat

Make sure the child seat meets the following three requirements:

- The child seat is the correct type and size for the child.
- The child seat is the correct type for the seating position.
- The child seat is compliant with Federal Motor Vehicle Safety Standard 213 or Canadian Motor Vehicle Safety Standard 213.

☒ Selecting a Child Seat

Installation of a LATCH-compatible child seat is simple.

LATCH-compatible child seats have been developed to simplify the installation process and reduce the likelihood of injuries caused by incorrect installation.

■ Installing a LATCH-Compatible Child Seat

A LATCH-compatible child seat can be installed in each of the second and third row seats except for the third row center. A child seat is attached to the lower anchors with either the rigid or flexible type of connectors.

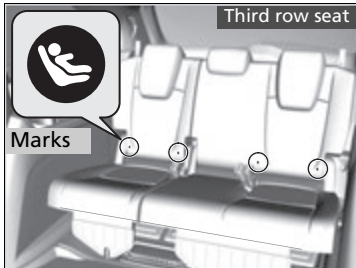
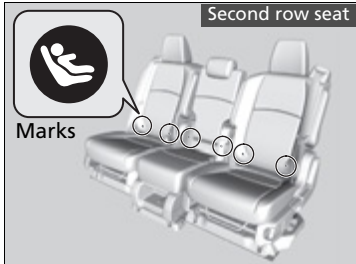

1. Locate the lower anchors under the marks.

►► Installing a LATCH-Compatible Child Seat

⚠ WARNING

Never attach two child seats to the same anchor. In a collision, one anchor may not be strong enough to hold two child seat attachments and may break, causing serious injury or death.

For your child's safety, when using a child seat installed using the LATCH system, make sure that the child seat is properly secured to the vehicle. A child seat that is not properly secured will not adequately protect a child in a crash and may cause injury to the child or other vehicle occupants.

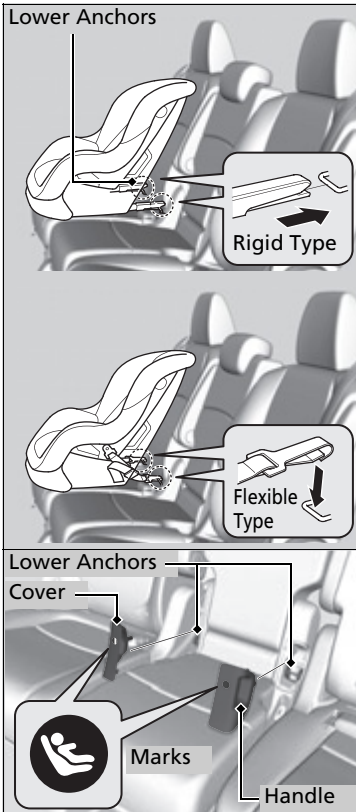

2. Place the child seat on the vehicle seat, then attach the child seat to the lower anchors according to the instructions that came with the child seat.

▶ When installing the child seat, make sure that the lower anchors are not obstructed by the seat belt or any other object.

Second row center seat*

To install a LATCH-compatible child seat in the second row center seat, remove the covers on each lower end of the seat-back by pulling on the handles.

▶▶ Installing a LATCH-Compatible Child Seat

⚠ WARNING

Use the outer third row seats' inner anchors to secure a LATCH-compatible child seat in the third row center seating position may result in failure of the child seat, causing injury or death.

Only use the outer third row seats' inner anchors to install a child seat in the third row center seating position if the manufacturer's instructions expressly permit.

* Not available on all models

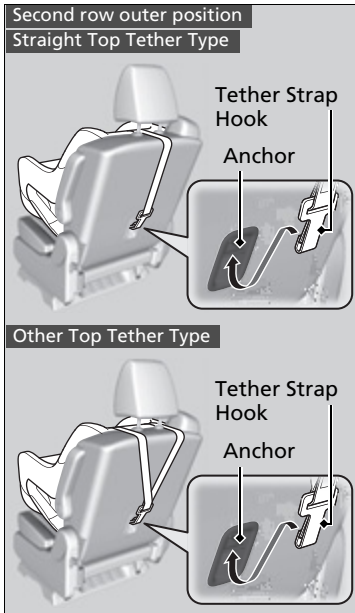

3. Put the head restraint to its upper-most position, then route the tether strap outside/between the head restraint legs, and secure the tether strap hook to the anchor.
4. Tighten the tether strap as instructed by the child seat manufacturer.

▶▶ Installing a LATCH-Compatible Child Seat

Installing a LATCH-compatible child seat in the third row center seat

Each outer third row seat is equipped with a pair of lower anchors which are used to secure a LATCH-compatible child seat. The third row center seat, however, is not equipped with anchors of any kind. The inner and outer anchors are spaced apart at a standard distance of 11 inches (280 mm). The distance between the two inner anchors is 16.0 inches (406.2 mm).

LATCH-compatible restraint systems that are fitted with rigid-type attachments cannot be installed in the third row center seat. However, a system fitted with flexible-type attachments can be installed in the third row center seat, provided that the manufacturer's instructions for that system permit the use of the inner anchors with the stated spacing.

Before seating a child, make sure that the system is properly attached to both the lower anchors and tether anchors.

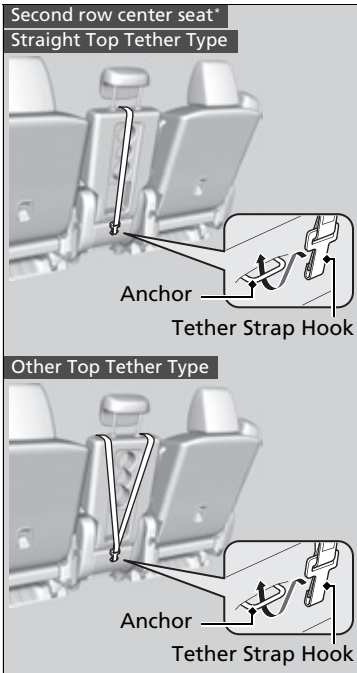

5. Make sure the child seat is firmly secured by rocking it forward and back and side to side; little movement should be felt.

* Not available on all models

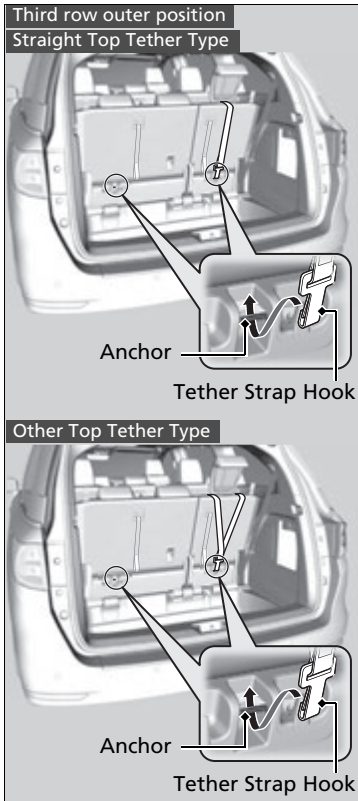

6. Make sure any unused seat belt that a child can reach is buckled, the lockable retractor is activated, and the belt is fully retracted and locked.

▶ **Protecting Child Passengers** P. 67

■ Installing a Child Seat with a Lap/Shoulder Seat Belt

A child seat can be installed with a lap/shoulder belt in any rear seat or, if absolutely necessary, the front passenger seat.

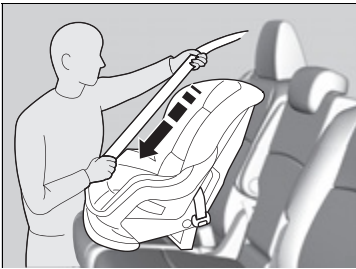

1. Place the child seat on the vehicle seat.
2. Route the seat belt through the child seat according to the seat manufacturer's instructions, and insert the latch plate into the buckle.
 - Insert the latch plate fully until it clicks.
3. Slowly pull the shoulder part of the belt all the way out until it stops. This activates the lockable retractor.
4. Let the seat belt retract a few inches and check that the retractor has switched modes by pulling on the webbing. It should not pull out again until it is reset by removing the latch plate from the buckle.
 - If you are able to pull the shoulder belt out, the lockable retractor is not activated. Slowly pull the seat belt all the way out, and repeat steps 3 – 4.

▣ Installing a Child Seat with a Lap/Shoulder Seat Belt

A child seat that is not properly secured will not adequately protect a child in a crash and may cause injury to the child or other vehicle occupants.

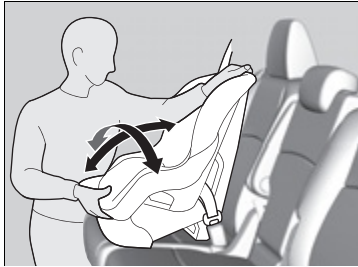

5. Grab the shoulder part of the seat belt near the buckle, and pull up to remove any slack from the lap part of the belt.

▶ When doing this, place your weight on the child seat and push it into the vehicle seat.

6. Make sure the child seat is firmly secured by rocking it forward and back and side to side; less than one inch of movement should occur near the seat belt.

7. Make sure any unused seat belt that a child can reach is buckled, the lockable retractor is activated, and the belt is fully retracted and locked.

▶▶ Installing a Child Seat with a Lap/Shoulder Seat Belt

To deactivate a lockable retractor, release the buckle and allow the seat belt to wind up all the way.

■ Adding Security with a Tether

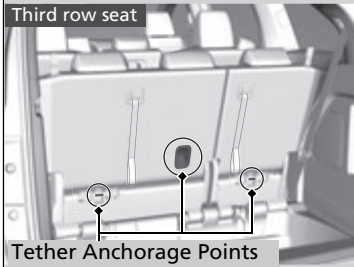
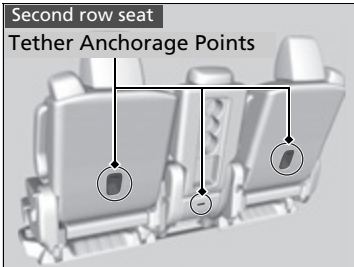

A tether anchorage point is provided behind each second and third row seating position. If you have a child seat that comes with a tether but can be installed with a seat belt, the tether may be used for additional security.

1. Locate the appropriate tether anchorage point.

▣ Adding Security with a Tether

Always use a tether for forward-facing child seats whether using the seat belt or lower anchors.

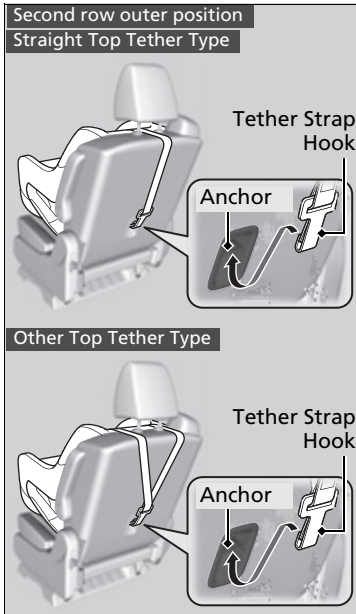

2. Put the head restraint to its upper-most position, then route the tether strap outside/through the head restraint legs. Make sure the strap is not twisted.

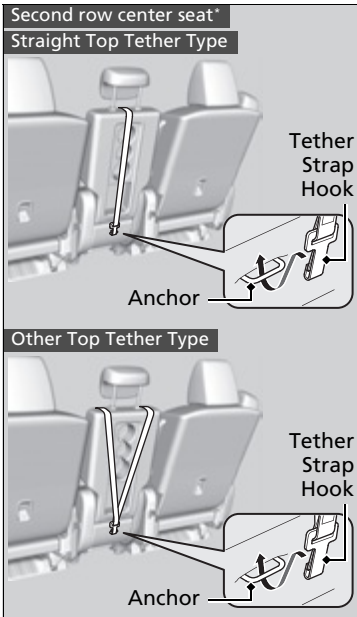

3. Secure the tether strap hook to the anchor.

* Not available on all models

Continued

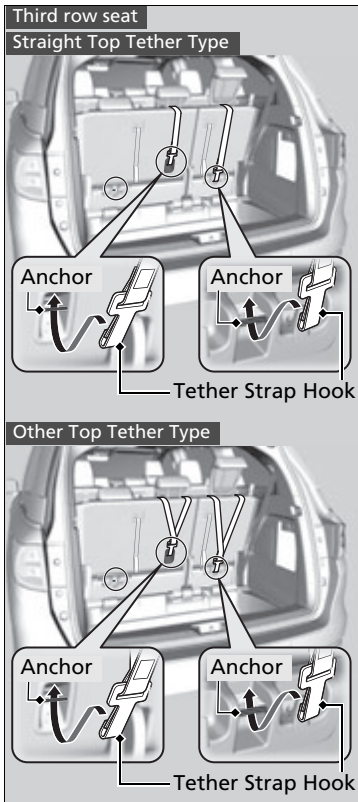

4. Tighten the tether strap as instructed by the child seat manufacturer.

Safety of Larger Children

■ Protecting Larger Children

The following pages give instructions on how to check proper seat belt fit, what kind of booster seat to use if one is needed, and important precautions for a child who must sit in front.

■ Checking Seat Belt Fit

When a child is too big for a child seat, secure the child in a rear seat using the lap/shoulder seat belt. Have the child sit upright and all the way back, then answer the following questions.

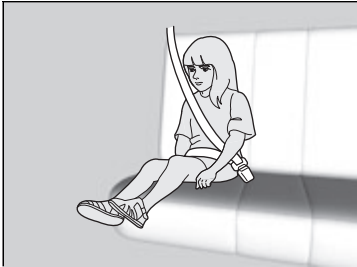

■ Checklist

- Do the child's knees bend comfortably over the edge of the seat?
- Does the shoulder belt cross between the child's neck and arm?
- Is the lap part of the seat belt as low as possible, touching the child's thighs?
- Will the child be able to stay seated like this for the whole trip?

If you answer yes to all these questions, the child is ready to wear the lap/shoulder seat belt correctly. If you answer no to any question, the child needs to ride on a booster seat until the seat belt fits properly without a booster seat.

▶▶ Safety of Larger Children

⚠ WARNING

Allowing a child age 12 or under to sit in front can result in injury or death if the passenger's front airbag inflates.

If a larger child must ride in front, move the vehicle seat as far to the rear as possible, have the child sit up properly and wear the seat belt properly, using a booster seat if needed.

■ Booster Seats

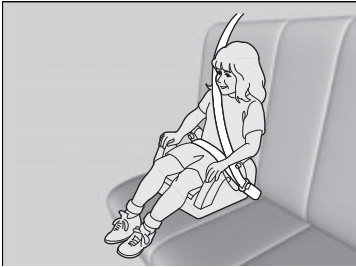

If a lap/shoulder seat belt cannot be used properly, position the child in a booster seat in the rear seat. For the child's safety, check that the child meets the booster seat manufacturer's recommendations.

▣ Booster Seats

When installing a booster seat, make sure to read the instructions that came with it, and install the seat accordingly.

There are high- and low-type booster seats. Choose a booster seat that allows the child to wear the seat belt correctly.

Some U.S. states and Canadian provinces and territories require children to use a booster seat until they reach a given age or weight (e.g. 6 years or 60 lbs). Be sure to check current laws in the state or province, or territory where you intend to drive.

■ Protecting Larger Children - Final Checks

Your vehicle has a rear seat where children can be properly restrained. If you ever have to carry a group of children, and a child must ride in front:

- Make sure you read and fully understand the instructions and safety information in this manual.
- Move the front passenger seat as far back as possible.
- Have the child sit upright and well back in the seat.
- Check that the seat belt is properly positioned so that the child is secure in the seat.

■ Monitoring child passengers

We strongly recommend that you keep an eye on child passengers. Even older, more mature children sometimes need to be reminded to fasten their seat belts and sit up properly.

Carbon Monoxide Gas

The engine exhaust from this vehicle contains carbon monoxide, a colorless, odorless, and highly toxic gas. As long as you properly maintain your vehicle, carbon monoxide gas will not get into the interior.

■ Have the exhaust system inspected for leaks whenever

- The exhaust system is making an unusual noise.
- The exhaust system may have been damaged.
- The vehicle is raised for an oil change.

When you operate a vehicle with the tailgate open, airflow can pull exhaust gas into the interior and create a hazardous condition. If you must drive with the tailgate open, open all the windows and set the climate control system as shown below.

1. Select the fresh air mode.
2. Select the  mode.
3. Set the fan speed to high.
4. Set the temperature control to a comfortable setting.

Adjust the climate control system in the same manner if you sit in your parked vehicle with the engine running.

ⓘ Carbon Monoxide Gas

⚠ WARNING

Carbon monoxide gas is toxic.

Breathing it can cause unconsciousness and even kill you.

Avoid any enclosed areas or activities that expose you to carbon monoxide.



An enclosed area such as a garage can quickly fill up with carbon monoxide gas. Do not run the engine with the garage door closed. Even when the garage door is open, drive out of the garage immediately after starting the engine.



Instrument Panel

This chapter describes the buttons, indicators, and gauges that are used while driving.



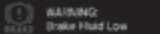
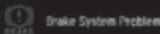

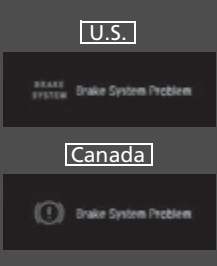
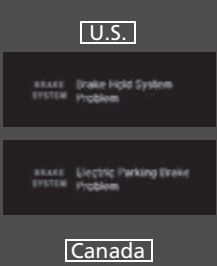

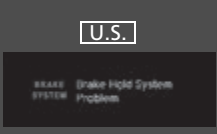
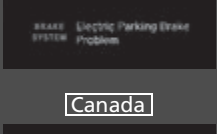

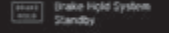

Indicators	88
Driver Information Interface Warning and Information Messages.....	108
Gauges and Driver Information Interface	
Gauges.....	127
Driver Information Interface	128

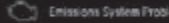

Indicator	Name	On/Blinking	Explanation	Message
<div style="text-align: center;"> <div style="border: 1px solid black; padding: 2px; display: inline-block;">U.S.</div> BRAKE <div style="border: 1px solid black; padding: 2px; display: inline-block;">Canada</div>  (Red) </div>	Parking Brake and Brake System Indicator (Red)	<ul style="list-style-type: none"> • Comes on for a few seconds when you set the power mode to ON, then goes off if the parking brake has been released. • Comes on when the parking brake is applied, and goes off when it is released. • Comes on when the brake fluid level is low. • Comes on if there is a problem with the brake system. • The beeper sounds and the indicator comes on if you drive with the parking brake applied. • Comes on for about 15 seconds when you push the electric parking brake switch with the power mode in OFF. • Stays on for about 15 seconds when you set the power mode to OFF while the electric parking brake is set. 	<ul style="list-style-type: none"> • Comes on while driving - Make sure the parking brake is released. Check the brake fluid level. <ul style="list-style-type: none"> ➤ What to do when the indicator comes on while driving P. 741 • Comes on along with the Parking Brake and Brake System Indicator (amber) - Immediately stop in a safe place. Contact a dealer for repair. The brake pedal becomes harder to operate. Depress the pedal further than you normally do. <ul style="list-style-type: none"> ➤ If the Brake System Indicator (Red) Comes On or Blinks at the Same Time When the Brake System Indicator (Amber) Comes On P. 742 • Comes on along with the ABS indicator - Have your vehicle checked by a dealer. <ul style="list-style-type: none"> ➤ If the Brake System Indicator (Red) Comes On or Blinks P. 741 • Blinks and the Parking Brake and Brake System Indicator (amber) comes on at the same time - There is a problem with the electric parking brake system. The parking brake may not be set. Avoid using the parking brake and have your vehicle checked by a dealer immediately. <ul style="list-style-type: none"> ➤ If the Brake System Indicator (Red) Comes On or Blinks at the Same Time When the Brake System Indicator (Amber) Comes On P. 742 	<div style="text-align: center;">    </div>



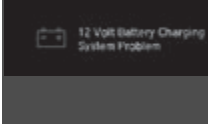



Indicator	Name	On/Blinking	Explanation	Message
	Parking Brake and Brake System Indicator (Amber)	<ul style="list-style-type: none"> Comes on for a few seconds when you set the power mode to ON, then goes off. Comes on if there is a problem with a system related to braking other than the conventional brake system. 	<ul style="list-style-type: none"> Comes on while driving - Avoid high speeds and sudden braking. Take the vehicle to a dealer immediately. 	 
	Parking Brake and Brake System Indicator (Amber)	<ul style="list-style-type: none"> Comes on if there is a problem with the electric parking brake system and/or the automatic brake hold system. 	<ul style="list-style-type: none"> Stays on constantly - Avoid using the parking brake and have your vehicle checked by a dealer immediately. 	 

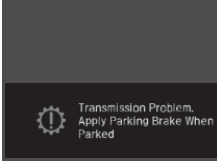





Indicator	Name	On/Blinking	Explanation	Message
<p>The indicator panel shows the text 'U.S.' in a box, 'BRAKE SYSTEM' in large bold letters, 'Canada' in a box, a circular warning symbol with an exclamation mark, and '(Amber)' below it.</p>	<p>Parking Brake and Brake System Indicator (Amber)</p>	<ul style="list-style-type: none"> • Comes on if there is a problem with the radar sensor. • Indicator may come on temporarily when the Maximum Load Limit is exceeded. 	<ul style="list-style-type: none"> • Make sure the total load is within the Maximum Load Limit. <ul style="list-style-type: none"> ▶ Maximum Load Limit P. 541 • Stays on constantly - Have your vehicle checked by a dealer. 	<p>—</p>





Indicator	Name	On/Blinking	Explanation	Message
	Automatic Brake Hold System Indicator	<ul style="list-style-type: none"> Comes on when the automatic brake hold system is on. 	<ul style="list-style-type: none"> ➤ Automatic Brake Hold P. 642 	
	Automatic Brake Hold Indicator	<ul style="list-style-type: none"> Comes on when the automatic brake hold is activated. 	<ul style="list-style-type: none"> ➤ Automatic Brake Hold P. 642 	
	Malfunction Indicator Lamp	<ul style="list-style-type: none"> Comes on when you set the power mode to ON, and goes off when the engine starts, or after several seconds if the engine did not start. If “readiness codes” have not been set, it blinks five times before it goes off. Comes on if there is a problem with the emissions control system. Blinks when a misfire in the engine’s cylinders is detected. 	<ul style="list-style-type: none"> Readiness codes are part of the on board diagnostics for the emissions control systems. <ul style="list-style-type: none"> ➤ Testing of Readiness Codes P. 765 Comes on while driving - Have your vehicle checked by a dealer. Blinks while driving - Stop in a safe place where there are no flammable objects. Stop the engine for 10 minutes or more, and wait for it to cool down. Then, take your vehicle to a dealer. <ul style="list-style-type: none"> ➤ If the Malfunction Indicator Lamp Comes On or Blinks P. 740 	



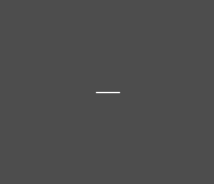

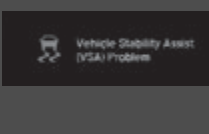

Indicator	Name	On/Blinking	Explanation	Message
	Charging System Indicator	<ul style="list-style-type: none"> Comes on when you set the power mode to ON, and goes off when the engine starts. Comes on when the battery is not charging. 	<ul style="list-style-type: none"> Comes on while driving - Turn off the climate control system and rear defogger in order to reduce electricity consumption. <ul style="list-style-type: none"> ➤ If the Charging System Indicator Comes On P. 740 	
	Gear Position Indicator	<ul style="list-style-type: none"> Indicates the current gear selection. 	<ul style="list-style-type: none"> ➤ Shifting P. 558 	—
	M (sequential mode) Indicator/ Sequential Mode Gear Selection Indicator	<ul style="list-style-type: none"> Comes on when the manual sequential shift mode is applied. 	<ul style="list-style-type: none"> ➤ Sequential Mode P. 564 	—

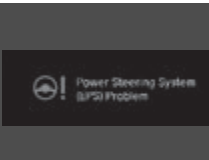
Indicator	Name	On/Blinking	Explanation	Message
	Transmission System Indicator	<ul style="list-style-type: none"> All the gear positions may light for several seconds, and go off. 	<ul style="list-style-type: none"> When all the gear positions light, immediately stop your vehicle in a safe place. Indicators go off if there is no problem. However, even if they go off, take your vehicle to a dealer for inspection. 	
		<ul style="list-style-type: none"> The indicated current gear selection blinks if there is a problem with the transmission system. 	<ul style="list-style-type: none"> Avoid sudden start and acceleration, and stop in a safe place immediately. Have your vehicle checked by a dealer. 	
		<ul style="list-style-type: none"> The current gear position or all the gear positions blink if there is a problem with the transmission system and the vehicle will no longer move. 	<ul style="list-style-type: none"> Immediately stop in a safe place. <ul style="list-style-type: none"> ➤ Emergency Towing P. 752 Have your vehicle checked by a dealer. 	
		<ul style="list-style-type: none"> The current gear position or all the gear positions blink if you cannot select P due to a transmission system failure. 	<ul style="list-style-type: none"> The engine can be activated as a temporary measure. <ul style="list-style-type: none"> ➤ If the Transmission System Indicator Blinks along with the Warning Message P. 744 Set the parking brake when parking. Have your vehicle checked by a dealer immediately. 	

Indicator	Name	On/Blinking	Explanation	Message
	Seat Belt Reminder Indicator	<ul style="list-style-type: none"> • Comes on and the beeper sounds if you are not wearing a seat belt when you set the power mode to ON. • If the front passenger is not wearing a seat belt, the indicator comes on a few seconds later. • Blinks while driving if either you and/or the front passenger has not fastened a seat belt. The beeper sounds and the indicator blinks at regular intervals. 	<ul style="list-style-type: none"> • The beeper stops and the indicator goes off when you and the front passenger fasten their seat belts. • Stays on after you and/or the front passenger has fastened the seat belt(s) - A detection error may have occurred in the sensor. Have your vehicle checked by a dealer. <ul style="list-style-type: none"> ➤ Seat Belt Reminder P. 41 	 
	Low Fuel Indicator	<ul style="list-style-type: none"> • Comes on when the fuel reserve is running low (approximately 2.9 U.S. gal/11.0 Liter left). • Blinks if there is a problem with the fuel gauge. 	<ul style="list-style-type: none"> • Comes on - Refuel your vehicle as soon as possible. • Blinks - Have your vehicle checked by a dealer. 	 











Indicator	Name	On/Blinking	Explanation	Message
	Anti-lock Brake System (ABS) Indicator	<ul style="list-style-type: none"> • Comes on for a few seconds when you set the power mode to ON, then goes off. • If it comes on at any other time, there is a problem with the ABS. 	<ul style="list-style-type: none"> • Stays on constantly - Have your vehicle checked by a dealer. With this indicator on, your vehicle still has normal braking ability but no anti-lock function.  Anti-lock Brake System (ABS) P. 644 	
	Supplemental Restraint System Indicator	<ul style="list-style-type: none"> • Comes on for a few seconds when you set the power mode to ON, then goes off. • Comes on if a problem with any of the following is detected: <ul style="list-style-type: none"> - Supplemental restraint system - Knee airbag system - Side airbag system - Side curtain airbag system - Seat belt tensioner 	<ul style="list-style-type: none"> • Stays on constantly or does not come on at all - Have your vehicle checked by a dealer. 	
	Auto High-Beam Indicator	<ul style="list-style-type: none"> • Comes on for a few seconds when you set the power mode to ON, then goes off. • Comes on when all the operating conditions of the Auto high-beam are met. 	 Auto High-Beam P. 207	

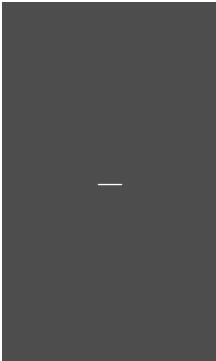

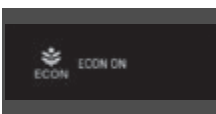

Indicator	Name	On/Blinking	Explanation	Message
	Vehicle Stability Assist™ (VSA®) System Indicator	<ul style="list-style-type: none"> • Comes on for a few seconds when you set the power mode to ON, then goes off. • Blinks when VSA® is active. • Comes on if there is a problem with the VSA®, hill start assist, brake assist or brake lighting system. 	<ul style="list-style-type: none"> • Stays on constantly - Have your vehicle checked by a dealer. <ul style="list-style-type: none"> ➤ Vehicle Stability Assist™ (VSA®), aka Electronic Stability Control (ESC), System P. 574 ➤ Hill start assist system P. 555 	 
	Vehicle Stability Assist™ (VSA®) OFF Indicator	<ul style="list-style-type: none"> • Comes on for a few seconds when you set the power mode to ON, then goes off. • Comes on when you partially disable VSA®. 	<ul style="list-style-type: none"> ➤ VSA® On and Off P. 575 	—
	Electric Power Steering (EPS) System Indicator	<ul style="list-style-type: none"> • Comes on when you set the power mode to ON, and goes off when the engine starts. • Comes on if there is a problem with the EPS system. 	<ul style="list-style-type: none"> • Stays on constantly - Have your vehicle checked by a dealer. <ul style="list-style-type: none"> ➤ If the Electric Power Steering (EPS) System Indicator Comes On P. 743 	



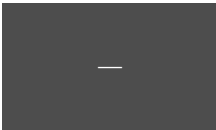





Indicator	Name	On/Blinking	Explanation	Message
	Low Tire Pressure/TPMS Indicator	<ul style="list-style-type: none"> • Comes on for a few seconds when you set the power mode to ON, then goes off. • Comes on if the tire pressure of any of the tires becomes significantly low. 	<ul style="list-style-type: none"> • Comes on while driving - Stop in a safe place, check tire pressures, and inflate the tire(s) if necessary. 	
		<ul style="list-style-type: none"> • Blinks for about one minute, and then stays on if there is a problem with the TPMS with Tire Fill Assist, or when a compact spare tire is temporarily installed. 	<ul style="list-style-type: none"> • Blinks and remains on - Have your vehicle checked by a dealer. If the vehicle is fitted with a compact spare, get your regular tire repaired or replaced and put back on your vehicle as soon as you can. 	
	Turn Signal and Hazard Warning Indicators	<ul style="list-style-type: none"> • Blinks when you operate the turn signal lever. • Blink along with all turn signals when you press the hazard warning button. 	<ul style="list-style-type: none"> • Does not blink or blinks rapidly  Replacing Light Bulbs P. 687, 689 	—
	High Beam Indicator	<ul style="list-style-type: none"> • Comes on when the high beam headlights are on. 	—	—





Indicator	Name	On/Blinking	Explanation	Message
	Lights On Indicator	<ul style="list-style-type: none"> Comes on whenever the light switch is on, or in AUTO when the exterior lights are on. 	<ul style="list-style-type: none"> If you set the power mode to ACCESSORY or VEHICLE OFF while the exterior lights are on, a chime sounds when the driver's door is opened. 	—
	Fog Light Indicator*	<ul style="list-style-type: none"> Comes on when the fog lights are on. 	<p>➤ Fog Lights * P. 205</p>	—
<p>Indicator</p>	Immobilizer System Indicator	<ul style="list-style-type: none"> Comes on briefly when you set the power mode to ON, then goes off. Comes on if the immobilizer system cannot recognize the key information. 	<ul style="list-style-type: none"> Blinks - You cannot start the engine. Set the power mode to VEHICLE OFF*¹, then select the ON mode again. Repeatedly blinks - The system may be malfunctioning. Have your vehicle checked by a dealer. Do not attempt to alter this system or add other devices to it. Electrical problems can occur. 	
<p>Indicator</p>	Security System Alarm Indicator	<ul style="list-style-type: none"> Comes on briefly when you set the power mode to ON, then goes off. Blinks when the security system alarm has been set. 	<p>➤ Security System Alarm P. 191</p>	—





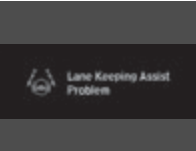

*1: Canadian models only: Apply and hold the brake pedal before selecting the ON mode.





Indicator	Name	On/Blinking	Explanation	Message
	System Message Indicator	<ul style="list-style-type: none"> Comes on along with a beep when a problem is detected. A system message on the driver information interface appears at the same time. 	<ul style="list-style-type: none"> While the indicator is on, press the  (home) button, select Warnings, then press the ENTER button to see the message again. Refer to the Indicators information in this chapter when a system message appears on the driver information interface. Take the appropriate action for the message. The driver information interface does not return to the normal screen unless the warning is canceled, or the ENTER button is pressed repeatedly. 	
	Econ Mode Indicator	<ul style="list-style-type: none"> Comes on when you press the ECON button. 	 ECON Button P. 572	
	Snow Mode Indicator	<ul style="list-style-type: none"> Comes on when you press the SNOW button and snow mode is selected. 	 Intelligent Traction Management P. 573	
	Normal Mode Indicator	<ul style="list-style-type: none"> Comes on for a few seconds when Snow mode is selected, and the vehicle is powered off, then restarted. 	 Intelligent Traction Management P. 573	



Indicator	Name	On/Blinking	Explanation	Message
	Auto Idle Stop Indicator (Green)	<ul style="list-style-type: none"> Comes on when Auto Idle Stop is in operation. The engine automatically shuts off. 	<ul style="list-style-type: none"> ➤ Auto Idle Stop P. 566 	—
	Auto Idle Stop OFF Indicator	<ul style="list-style-type: none"> Comes on when the Auto Idle Stop system has been turned off by the Auto Idle Stop OFF Button. 	<ul style="list-style-type: none"> ➤ Auto Idle Stop System ON/OFF P. 567 	
	Auto Idle Stop System Indicator (Amber)	<ul style="list-style-type: none"> Comes on for a few seconds when you set the power mode to ON, then goes off. Blinks if there is a problem with the Auto Idle Stop system. 	<ul style="list-style-type: none"> • Blinks - Have your vehicle checked by a dealer. 	—
				

Indicator	Name	On/Blinking	Explanation	Message
	Auto Idle Stop Suspend Indicator	<ul style="list-style-type: none"> Comes on while Auto Idle Stop is temporarily suspended in the following situations. 	—	—
		<ul style="list-style-type: none"> Brake pedal is not fully pressed. 	<ul style="list-style-type: none"> Depress the brake pedal firmly. 	
		<ul style="list-style-type: none"> The transmission is in a position other than D. 	<p> Auto Idle Stop P. 566</p>	
		<ul style="list-style-type: none"> System charging is prioritized. 		
		<ul style="list-style-type: none"> Climate control system is prioritized. 		
		<ul style="list-style-type: none"> Engine coolant temperature is not in operating range. 		
		<ul style="list-style-type: none"> The Intelligent Traction Management is set to Snow. 		
		<ul style="list-style-type: none"> Auto Idle Stop does not activate for some reason. 		



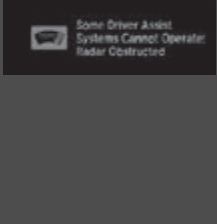
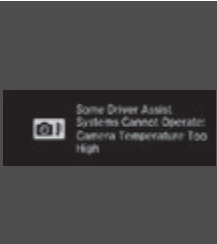

Indicator	Name	On/Blinking	Explanation	Message
	Auto Idle Stop Suspend Indicator	—	<ul style="list-style-type: none"> If you press and hold the Auto Idle Stop OFF button, you can select whether to display the status messages or not. 	
	Lane Keeping Assist System (LKAS) Indicator (Amber)	<ul style="list-style-type: none"> Comes on for a few seconds when you set the power mode to ON, then goes off. Comes on if there is a problem with the LKAS. 	<ul style="list-style-type: none"> Stays on constantly - Have your vehicle checked by a dealer. 	
	Lane Keeping Assist System (LKAS) Indicator (White/Green)	<ul style="list-style-type: none"> Lights up in white when you press the LKAS button. Lights up in green when the LKAS is in operation. 	<p>▣ Lane Keeping Assist System (LKAS) P. 616</p>	—

Indicator	Name	On/Blinking	Explanation	Message
	Adaptive Cruise Control (ACC) with Low Speed Follow Indicator (Amber)	<ul style="list-style-type: none"> • Comes on for a few seconds when you set the power mode to ON, then goes off. • Comes on if there is a problem with ACC with Low Speed Follow. • Indicator may come on temporarily when the Maximum Load Limit is exceeded. • ACC with Low Speed Follow has been automatically canceled. 	<ul style="list-style-type: none"> • Comes on while driving - Have your vehicle checked by a dealer. • Make sure the total load is within the Maximum Load Limit.  Maximum Load Limit P. 541 • Stays on constantly - Have your vehicle checked by a dealer. 	
	Adaptive Cruise Control (ACC) with Low Speed Follow Indicator (White/Green)	<ul style="list-style-type: none"> • Lights up in white when you press the  button. • Lights up in green when you press the RES/+ button or -/SET button. 	 Adaptive Cruise Control (ACC) with Low Speed Follow P. 600	—

Indicator	Name	On/Blinking	Explanation	Message
	Cruise Mode Indicator (White/Green)	<ul style="list-style-type: none"> Lights up in white when you change to cruise mode. Lights up in green when you have set a speed for cruise control. 	<ul style="list-style-type: none"> ➤ To Switch ACC with Low Speed Follow to Cruise Control P. 614 	
	Safety Support Indicator (Amber)	<ul style="list-style-type: none"> Comes on if there is a problem with RDM, CMBS™, or Blind spot information System*. Indicator may come on temporarily when the Maximum Load Limit is exceeded. 	<ul style="list-style-type: none"> Stays on constantly - Have your vehicle checked by a dealer. Make sure the total load is within the Maximum Load Limit. <ul style="list-style-type: none"> ➤ Maximum Load Limit P. 541 	 Road Departure Mitigation System Problem  Collision Mitigation System Problem  Blind Spot Info System Problem

Indicator	Name	On/Blinking	Explanation	Message
	<p>Safety Support Indicator (Amber)</p>	<ul style="list-style-type: none"> Comes on when RDM and/or CMBS™ shuts itself off. 	<ul style="list-style-type: none"> Indicator may come on temporarily when passing through an enclosed space, such as a tunnel. The area around the radar sensor is blocked by dirt, mud, etc. Stop your vehicle in a safe place and wipe the debris off with a soft cloth. Indicator may take some time to go off after the radar sensor is cleaned. Have your vehicle checked by a dealer if the indicator does not go off even after you have cleaned the radar sensor. <ul style="list-style-type: none">  Radar Sensor P. 637 Stays on - The temperature inside the camera is too high. Use the climate control system to cool down the camera. The system activates when the temperature inside the camera cools down. <ul style="list-style-type: none">  Front Sensor Camera P. 635 	 







Indicator	Name	On/Blinking	Explanation	Message
	<p>Safety Support Indicator (Amber)</p>	<ul style="list-style-type: none"> Comes on when RDM and/or CMBS™ shuts itself off. <p>Models with Blind spot information System</p> <ul style="list-style-type: none"> Comes on when mud, snow, or ice has accumulated in the vicinity of the Blind spot information System sensor. 	<ul style="list-style-type: none"> Stays on - The area around the camera is blocked by dirt, mud, etc. Stop your vehicle in a safe place and wipe the debris off with a soft cloth. Have your vehicle checked by a dealer if the indicator and message are still displayed even after you have cleaned the area around the camera. <ul style="list-style-type: none"> ➤ Front Sensor Camera P. 635 Comes on while driving - Something may be interfering with the Blind spot information System sensor. Check the vicinity of the Blind spot information System sensor and remove any obstacles. <ul style="list-style-type: none"> ➤ Blind spot information System* P. 581 	 



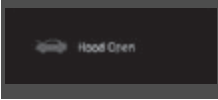

Indicator	Name	On/Blinking	Explanation	Message
	Safety Support Indicator (Green/Gray)	<ul style="list-style-type: none"> • Lights up in green when RDM, CMBS™, and Blind spot information System* are on. • Lights up in green and gray when RDM, CMBS™, or Blind spot information System* or any two of these systems are off. • Lights up in gray when RDM, CMBS™, and Blind spot information System* are off. 	<ul style="list-style-type: none"> ➤ RDM On and Off P. 627 ➤ CMBS™ On and Off P. 593 ➤ Blind spot information system on and off P. 583 	 Road Departure Mitigation OFF  Collision Mitigation Braking System OFF  Blind Spot Information System OFF





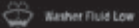

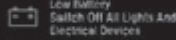
* Not available on all models



Driver Information Interface Warning and Information Messages



The following messages appear only on the driver information interface. Press the  (home) button, select **Warnings**, then press the **ENTER** button to see the message again with the system message indicator on.





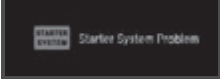
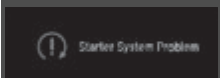

Message	Condition	Explanation
 Door Open  Tailgate Open  Door And Tailgate Open	<ul style="list-style-type: none"> • Appears if any door or the tailgate is not completely closed. 	<ul style="list-style-type: none"> • Goes off when all doors and the tailgate are closed.
 Hood Open	<ul style="list-style-type: none"> • Appears when the hood is opened. 	<ul style="list-style-type: none"> • Close the hood.
 Engine Oil Low	<ul style="list-style-type: none"> • Appears when the engine oil pressure is low. 	<ul style="list-style-type: none"> • Appears while driving - Immediately stop in a safe place.  If the Low Oil Pressure Warning Appears P. 739
 Shutter Grille Problem, Power Reduced	<ul style="list-style-type: none"> • Appears if there is a problem with the shutter grille, and the radiator coolant temperature is too high. 	<ul style="list-style-type: none"> • Power output will be reduced, so you may not be able to accelerate or maintain your current speed. Have your vehicle checked by a dealer.

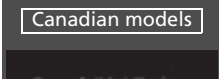
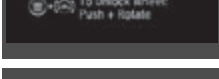

Message	Condition	Explanation
<p>Canadian models</p> 	<ul style="list-style-type: none"> Appears when the washer fluid is low. 	<ul style="list-style-type: none"> Refill the washer fluid. <ul style="list-style-type: none"> ▶ Refilling Window Washer Fluid P. 685
	<p>Models with color audio system</p> <ul style="list-style-type: none"> Appears while you are customizing the settings and the transmission is in other than P. 	<ul style="list-style-type: none"> ▶ Vehicle Customization P. 143
	<ul style="list-style-type: none"> Appears when the temperature of the transmission is starting to get too hot. The performance of the vehicle may be reduced. 	<ul style="list-style-type: none"> Until the message disappears, reduce your speed and allow the system to cool down.
	<ul style="list-style-type: none"> Appears if the battery charge becomes low. 	<ul style="list-style-type: none"> Charge the battery.
	<ul style="list-style-type: none"> Appears when the fuel fill door is opened. 	<ul style="list-style-type: none"> Close the fuel fill door.



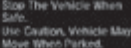

Message	Condition	Explanation
 Charging System Problem	<ul style="list-style-type: none"> Appears when there is a problem with the sensor on the battery. 	<ul style="list-style-type: none"> Have your vehicle checked by a dealer. <ul style="list-style-type: none"> ➤ Checking the Battery P. 706
 Maintenance Due Soon A12345	<ul style="list-style-type: none"> Appears when the scheduled maintenance is due soon. Consequently, Maintenance Due Now and Maintenance Past Due follow. 	<ul style="list-style-type: none"> ➤ Maintenance Minder Messages on the Driver Information Interface P. 669
<div style="border: 1px solid black; padding: 2px; display: inline-block;">U.S.</div>  Right Sliding Door Problem  Left Sliding Door Problem <div style="border: 1px solid black; padding: 2px; display: inline-block; margin-top: 10px;">Canada</div>  Right Sliding Door Problem  Left Sliding Door Problem	<div style="background-color: #cccccc; padding: 2px; margin-bottom: 5px;">Models with power sliding doors</div> <ul style="list-style-type: none"> Appears if there is a problem with the power sliding door system. 	<ul style="list-style-type: none"> Turn off the main switch and manually operate the power sliding doors. Have your vehicle checked by a dealer. <ul style="list-style-type: none"> ➤ Opening/Closing the Power Sliding Doors* P. 184

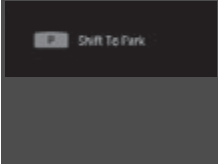
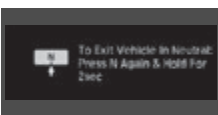
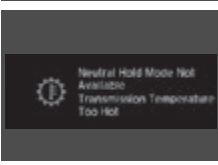
Message	Condition	Explanation
	<ul style="list-style-type: none"> • Appears when the engine coolant temperature gets abnormally high. 	<p>► Overheating P. 737</p>
<p>U.S.</p>  <p>Canada</p> 	<p>Models with power tailgate</p> <ul style="list-style-type: none"> • Appears when there is a problem with the power tailgate system. 	<ul style="list-style-type: none"> • Manually open or close the power tailgate. • Have your vehicle checked by a dealer.
<p>U.S.</p>  <p>Canada</p> 	<ul style="list-style-type: none"> • Appears when the starter system has a problem. 	<ul style="list-style-type: none"> • As a temporary measure, press and hold the ENGINE START/STOP button for up to 15 seconds while pressing the brake pedal and manually start the engine. • Have your vehicle checked by a dealer.



Message	Condition	Explanation
	<ul style="list-style-type: none"> Appears when you set the power mode to ACCESSORY or ON. 	<ul style="list-style-type: none"> ▶ Starting the Engine P. 550
	<ul style="list-style-type: none"> Appears when the engine does not restart automatically due to the following reason: The hood is open. There is a problem in the system that disables Auto Idle Stop. 	<ul style="list-style-type: none"> Follow the normal procedure to start the engine. ▶ Starting the Engine P. 550 Close the hood.
<div style="border: 1px solid black; padding: 2px; display: inline-block;">Canadian models</div> 	<ul style="list-style-type: none"> Appears when the steering wheel is locked. 	<ul style="list-style-type: none"> Move the steering wheel left and right while pressing the ENGINE START/STOP button.
	<ul style="list-style-type: none"> Appears when the power mode is in ACCESSORY. 	—
	<ul style="list-style-type: none"> Appears after the driver's door is opened when the power mode is in ACCESSORY. 	<ul style="list-style-type: none"> Change the power mode to VEHICLE OFF. ▶ ENGINE START/STOP Button P. 198

Message	Condition	Explanation
 Keyless Remote Not Detected	<ul style="list-style-type: none"> Appears when you close the door with the power mode in ON without the remote inside the vehicle. 	<ul style="list-style-type: none"> Disappears when you bring the remote back inside the vehicle and close the door. <ul style="list-style-type: none"> ➤ Keyless Remote Reminder P. 200
 Keyless Remote Battery Low	<ul style="list-style-type: none"> Appears when the remote battery becomes weak. 	<ul style="list-style-type: none"> Replace the battery as soon as possible. <ul style="list-style-type: none"> ➤ Replacing the Remote Battery P. 708
 To Start, Hold Remote Near Start Button	<ul style="list-style-type: none"> Appears if the remote battery is too weak to start the engine or the key is not within operating range to start the engine. A beeper sounds six times. 	<ul style="list-style-type: none"> Bring the remote in front of the ENGINE START/STOP button to be touched with. <ul style="list-style-type: none"> ➤ If the Remote Battery is Weak P. 733
 Pressing Button Again 2x Or Holding Will Cause Ignition Off & Power Loss	<ul style="list-style-type: none"> Appears if you press the ENGINE START/STOP button while the vehicle is moving. 	<ul style="list-style-type: none"> ➤ Emergency Engine Stop P. 734
 To Switch Vehicle Off: Push & Hold	<ul style="list-style-type: none"> Appears after the driver's door is opened when the power mode is in ACCESSORY. 	<ul style="list-style-type: none"> Press and hold the ENGINE START/STOP button with your foot off the brake pedal to change the power mode to VEHICLE OFF.
 To Shift From P, Engine Must Be Running	<ul style="list-style-type: none"> Appears when you attempt to change to another gear position with the transmission in P and the engine OFF. 	<ul style="list-style-type: none"> To select another gear position while in P, the engine must be ON.
 Stop The Vehicle When Safe. Use Caution, Vehicle May Move When Parked.	<ul style="list-style-type: none"> Appears when you set the power mode to OFF while driving. 	<ul style="list-style-type: none"> Immediately stop in a safe place, set the parking brake, then restart the engine. If the message disappears, continue driving.

Message	Condition	Explanation
	<ul style="list-style-type: none"> Appears when the vehicle is stopped with the driver's seat belt unfastened and there is a chance that the vehicle may roll unintentionally. 	<ul style="list-style-type: none"> Press the P button before release the brake pedal when idling, parking or exiting the vehicle. <ul style="list-style-type: none"> ➤ Shift Operation P. 560
	<ul style="list-style-type: none"> Appears when the engine stops without the transmission in P, and does not restart automatically. Appears if you open the hood while Auto Idle Stop activates. 	<ul style="list-style-type: none"> If you want to set the power mode to ON, change the gear position to P. If you want to start the engine, follow the normal procedure. <ul style="list-style-type: none"> ➤ Starting the Engine P. 550
	<ul style="list-style-type: none"> Appears when you change to N, then release the N button. 	<ul style="list-style-type: none"> ➤ If you want to keep the transmission in N position [car wash mode] P. 562
	<ul style="list-style-type: none"> Appears when car wash mode is not available due to hot transmission. 	<ul style="list-style-type: none"> When transmission is too hot, car wash mode may not be available. Let the engine idle and cool down transmission. <ul style="list-style-type: none"> ➤ If you want to keep the transmission in N position [car wash mode] P. 562
	<ul style="list-style-type: none"> Appears when you try to change the gear position without depressing the brake pedal. 	<ul style="list-style-type: none"> Depress the brake pedal, then select a shift button.

Message	Condition	Explanation
	<ul style="list-style-type: none"> • Appears when you try to change the gear position without releasing your foot off the accelerator pedal. 	<ul style="list-style-type: none"> • Release your foot off the accelerator pedal, then select a shift button.
	<ul style="list-style-type: none"> • Appears when the P button is pressed while the vehicle is moving. • Appears if you change the gear position to R while the vehicle is moving forward, or to D while the vehicle is reversing. 	<ul style="list-style-type: none"> • Make sure that the vehicle comes to a stop before operating the select button.
	<ul style="list-style-type: none"> • Appears when you set the power mode to ON without fastening the driver's seat belt. • Appears when you change the gear position after P has been automatically selected with the driver's door open, the driver's seat belt unfastened, then the brake pedal is released. 	<ul style="list-style-type: none"> • Fasten the seat belt properly before you start to drive. <ul style="list-style-type: none"> ► Shift Operation P. 560
	<ul style="list-style-type: none"> • Appears when you set the power mode to VEHICLE OFF, if the rear doors were opened shortly before or after the vehicle was powered on. 	<ul style="list-style-type: none"> • Check the rear seat for passengers or items before exiting the vehicle. <ul style="list-style-type: none"> ► Rear Seat Reminder P. 233
	<ul style="list-style-type: none"> • Appears when depressing the accelerator pedal while the gear position is in N. 	<ul style="list-style-type: none"> • Remove your foot from the accelerator pedal. When driving, depress the brake pedal and change the gear position.

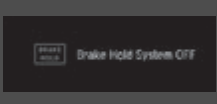
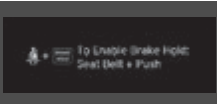

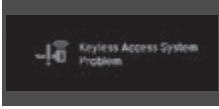
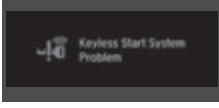
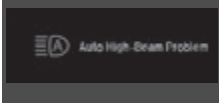

Message	Condition	Explanation
	<ul style="list-style-type: none"> Appears when you press and hold N button for more than two seconds. 	<ul style="list-style-type: none"> Disappears when you set the gear position to other than N. <ul style="list-style-type: none"> ► If you want to keep the transmission in N position [car wash mode] P. 562
	<ul style="list-style-type: none"> Appears if there is a problem with the cooling system. 	<ul style="list-style-type: none"> Drive slowly to prevent overheating and have your vehicle checked by a dealer as soon as possible.
	<ul style="list-style-type: none"> Appears if there is a problem with the headlights. 	<ul style="list-style-type: none"> Appears while driving - The headlights may not be on. When conditions allow you to drive safely, have your vehicle checked by a dealer as soon as possible.
	<p>Models with parking sensor system</p> <ul style="list-style-type: none"> Appears if there is a problem with the parking sensor system. 	<ul style="list-style-type: none"> Check if the area around the sensor(s) is covered with mud, ice, snow, etc. If the indicator(s) stays on or the beeper does not stop even after you clean the area, have the system checked by a dealer.

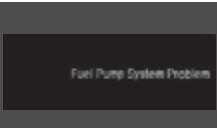
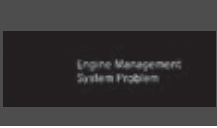
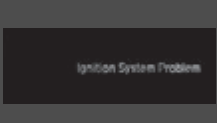
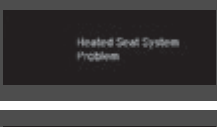
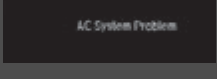

Message	Condition	Explanation
	<ul style="list-style-type: none"> Appears if the automatic brake hold is automatically canceled while it is in operation. 	<ul style="list-style-type: none"> Immediately depress the brake pedal.
	<ul style="list-style-type: none"> Appears when the automatic brake hold system is turned off. 	<ul style="list-style-type: none"> ➤ Automatic Brake Hold P. 642
	<ul style="list-style-type: none"> Appears when the automatic brake hold button is pressed without wearing the driver's seat belt. 	<ul style="list-style-type: none"> Fasten the driver's seat belt. ➤ Automatic Brake Hold P. 642
	<ul style="list-style-type: none"> Appears when the automatic brake hold button is pressed without depressing the brake pedal while the automatic brake hold is in operation. 	<ul style="list-style-type: none"> Press the automatic brake hold button with the brake pedal depressed. ➤ Automatic Brake Hold P. 642
	<ul style="list-style-type: none"> Appears when the parking brake is applied automatically while it is in operation. 	<ul style="list-style-type: none"> ➤ Automatic Brake Hold P. 642 ➤ Parking Brake P. 638

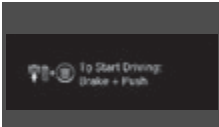

Message	Condition	Explanation
	<ul style="list-style-type: none"> Appears when you pull the electric parking brake switch without depressing the brake pedal. 	<ul style="list-style-type: none"> Depress the brake pedal to release the parking brake. <ul style="list-style-type: none"> ► Parking Brake P. 638
	<p>Models with keyless access system</p> <ul style="list-style-type: none"> Appears as soon as a problem is detected in the keyless access system. 	<ul style="list-style-type: none"> Appears constantly - Have your vehicle checked by a dealer.
	<ul style="list-style-type: none"> Appears as soon as a problem is detected in the push button starting system. 	<ul style="list-style-type: none"> Appears constantly - Have your vehicle checked by a dealer.
	<ul style="list-style-type: none"> Appears if there is a problem with the Auto high-beam. 	<ul style="list-style-type: none"> Manually operate the headlight switch. If you are driving with the high-beam headlights when this happens, the headlights are changed to low beams.



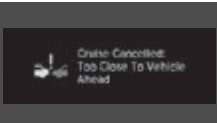
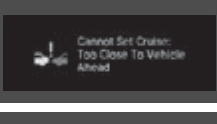
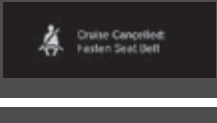
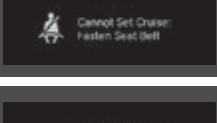

Message	Condition	Explanation
	<ul style="list-style-type: none"> Appears if there is a problem with the fuel pump system. 	<ul style="list-style-type: none"> Set the power mode to OFF for a while, then set the power mode to ON. The message disappears if there is no problem. If the message appears again, take your vehicle to a dealer.
	<ul style="list-style-type: none"> Appears if there is a problem with the engine management system. 	<ul style="list-style-type: none"> Set the power mode to OFF for a while, then set the power mode to ON. The message disappears if there is no problem. If the message appears again, take your vehicle to a dealer.
	<ul style="list-style-type: none"> Appears if there is a problem with the ignition system. 	<ul style="list-style-type: none"> Set the power mode to OFF for a while, then set the power mode to ON. The message disappears if there is no problem. If the message appears again, take your vehicle to a dealer.
	<ul style="list-style-type: none"> Appears if there is a problem with the seat heaters*. 	<ul style="list-style-type: none"> Turn off the seat heaters* until the message disappears. If the message appears again, take your vehicle to a dealer.
	<ul style="list-style-type: none"> Appears if there is a problem with the climate control system. 	<ul style="list-style-type: none"> Turn off the climate control system until the message disappears. If the message appears again, take your vehicle to a dealer.

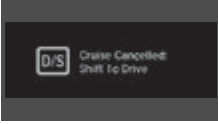
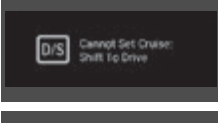

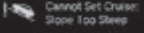
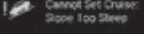

* Not available on all models

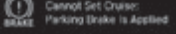

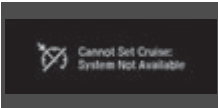
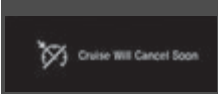

Message	Condition	Explanation
	<p>Models with remote engine starter</p> <ul style="list-style-type: none"> Appears when you unlock and open the driver's door while the engine is running by remote engine start. 	<ul style="list-style-type: none"> ➤ Remote Engine Start with Vehicle Feedback* P. 552
	<ul style="list-style-type: none"> Flashes when the system senses a likely collision with a vehicle in front of you. 	<ul style="list-style-type: none"> Take appropriate action to prevent a collision (apply the brakes, change lanes, etc.) <ul style="list-style-type: none"> ➤ Collision Mitigation Braking System™ (CMBS™) P. 589 ➤ Adaptive Cruise Control (ACC) with Low Speed Follow P. 600
	<ul style="list-style-type: none"> Appears when ACC with Low Speed Follow has been automatically canceled. 	<ul style="list-style-type: none"> You can resume the set speed after the condition that caused ACC with Low Speed Follow to cancel improves. Press the RES/+ button. <ul style="list-style-type: none"> ➤ Adaptive Cruise Control (ACC) with Low Speed Follow P. 600
	<ul style="list-style-type: none"> Appears when pressing the -/SET button while the vehicle is moving and the brake pedal is depressed. 	<ul style="list-style-type: none"> ACC with Low Speed Follow cannot be set. <ul style="list-style-type: none"> ➤ Adaptive Cruise Control (ACC) with Low Speed Follow P. 600
	<ul style="list-style-type: none"> Appears if the VSA® or traction control function operates while ACC with Low Speed Follow is in operation. 	<ul style="list-style-type: none"> ACC with Low Speed Follow has been automatically canceled. <ul style="list-style-type: none"> ➤ Adaptive Cruise Control (ACC) with Low Speed Follow P. 600

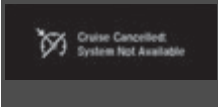
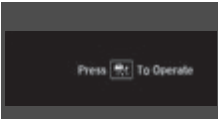

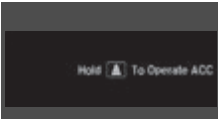

Message	Condition	Explanation
	<ul style="list-style-type: none"> Appears when the distance between your vehicle and the vehicle ahead of you is too close while ACC with Low Speed Follow is in operation. 	<ul style="list-style-type: none"> ACC with Low Speed Follow has been automatically canceled. <ul style="list-style-type: none"> ➤ Adaptive Cruise Control (ACC) with Low Speed Follow P. 600
	<ul style="list-style-type: none"> Appears when pressing the -/SET button while the distance between your vehicle and the vehicle ahead of you is too close. 	<ul style="list-style-type: none"> ACC with Low Speed Follow cannot be set. <ul style="list-style-type: none"> ➤ Adaptive Cruise Control (ACC) with Low Speed Follow P. 600
	<ul style="list-style-type: none"> Appears when the driver's seat belt is unfastened while your vehicle is automatically stopped by ACC with Low Speed Follow. 	<ul style="list-style-type: none"> ACC with Low Speed Follow has been automatically canceled. <ul style="list-style-type: none"> ➤ Adaptive Cruise Control (ACC) with Low Speed Follow P. 600
	<ul style="list-style-type: none"> Appears when pressing the -/SET button while the driver's seat belt is unfastened. 	<ul style="list-style-type: none"> ACC with Low Speed Follow cannot be set. <ul style="list-style-type: none"> ➤ Adaptive Cruise Control (ACC) with Low Speed Follow P. 600
	<ul style="list-style-type: none"> Appears when the speed of the vehicle is too high for you to set ACC. 	<ul style="list-style-type: none"> Reduce the speed, then set ACC. <ul style="list-style-type: none"> ➤ Adaptive Cruise Control (ACC) with Low Speed Follow P. 600
	<ul style="list-style-type: none"> Appears when ACC is canceled due to excessive high vehicle speed. 	<ul style="list-style-type: none"> Reduce the speed, then reset ACC. <ul style="list-style-type: none"> ➤ Adaptive Cruise Control (ACC) with Low Speed Follow P. 600

Message	Condition	Explanation
	<ul style="list-style-type: none"> Appears when the vehicle ahead of you resumes driving, after your vehicle has been stopped automatically by ACC with Low Speed Follow. 	<ul style="list-style-type: none"> Press the RES/+ button or -/SET button or depress the accelerator pedal to resume. <ul style="list-style-type: none"> ➤ Adaptive Cruise Control (ACC) with Low Speed Follow P. 600
	<ul style="list-style-type: none"> Appears when the shift position is changed to any position other than D/S while ACC with Low Speed Follow is in operation. 	<ul style="list-style-type: none"> ACC with Low Speed Follow has been automatically canceled. <ul style="list-style-type: none"> ➤ Adaptive Cruise Control (ACC) with Low Speed Follow P. 600
	<ul style="list-style-type: none"> Appears when pressing the -/SET button while the shift position is in any position other than D/S. 	<ul style="list-style-type: none"> ACC with Low Speed Follow cannot be set. <ul style="list-style-type: none"> ➤ Adaptive Cruise Control (ACC) with Low Speed Follow P. 600
	<ul style="list-style-type: none"> Appears when the vehicle is stopped on a very steep slope while ACC with Low Speed Follow is in operation. 	<ul style="list-style-type: none"> ACC with Low Speed Follow has been automatically canceled. <ul style="list-style-type: none"> ➤ Adaptive Cruise Control (ACC) with Low Speed Follow P. 600

Message	Condition	Explanation
 	<ul style="list-style-type: none"> Appears when pressing the –/SET button while the vehicle is stopped on a very steep slope. 	<ul style="list-style-type: none"> ACC with Low Speed Follow cannot be set. <ul style="list-style-type: none"> ➤ Adaptive Cruise Control (ACC) with Low Speed Follow P. 600
	<ul style="list-style-type: none"> Appears when the parking brake is applied automatically while ACC with Low Speed Follow is in operation. 	<ul style="list-style-type: none"> ACC with Low Speed Follow has been automatically canceled. <ul style="list-style-type: none"> ➤ Adaptive Cruise Control (ACC) with Low Speed Follow P. 600 ➤ Parking Brake P. 638
	<ul style="list-style-type: none"> Appears when pressing the –/SET button while the parking brake is applied. 	<ul style="list-style-type: none"> ACC with Low Speed Follow cannot be set. <ul style="list-style-type: none"> ➤ Adaptive Cruise Control (ACC) with Low Speed Follow P. 600 ➤ Parking Brake P. 638
	<ul style="list-style-type: none"> Appears if ACC with Low Speed Follow is canceled while your vehicle is automatically stopped by ACC with Low Speed Follow. 	<ul style="list-style-type: none"> Immediately depress the brake pedal.

Message	Condition	Explanation
	<ul style="list-style-type: none"> Appears if ACC with Low Speed Follow cannot be set due to repeated deceleration, driving on a long downward slope, or excess vehicle weight. 	<ul style="list-style-type: none"> Wait awhile, then reset ACC with Low Speed Follow. <ul style="list-style-type: none"> ▶ Adaptive Cruise Control (ACC) with Low Speed Follow P. 600
  	<ul style="list-style-type: none"> Appears just before the ACC with Low Speed Follow is automatically canceled due to repeated deceleration, driving on a long downward slope, or excess vehicle weight. (Will automatically open until the distance between your vehicle and the vehicle ahead is the maximum set in distance settings.) Appears when the ACC with Low Speed Follow has been automatically canceled. 	<ul style="list-style-type: none"> ▶ Adaptive Cruise Control (ACC) with Low Speed Follow P. 600
	<ul style="list-style-type: none"> Appears when -/SET, RES/+, CANCEL, or interval button is pressed while ACC with Low Speed Follow is off. 	<ul style="list-style-type: none"> After pressing the  button, press the -/SET, RES/+, CANCEL, or interval button. <ul style="list-style-type: none"> ▶ Adaptive Cruise Control (ACC) with Low Speed Follow P. 600
	<ul style="list-style-type: none"> Appears when interval button is pressed while Cruise mode is selected. 	<ul style="list-style-type: none"> After selecting ACC with Low Speed Follow, press the interval button. <ul style="list-style-type: none"> ▶ Adaptive Cruise Control (ACC) with Low Speed Follow P. 600

Message	Condition	Explanation
 	<p>Lane Keeping Assist System (LKAS)</p> <ul style="list-style-type: none"> • Appears when the vehicle is driving out of a detected lane. The steering wheel vibrates rapidly. <p>Road Departure Mitigation (RDM) System</p> <ul style="list-style-type: none"> • Appears when the vehicle is driving out of a detected lane. <p>When you selected Warning Only</p> <ul style="list-style-type: none"> - The steering wheel vibrates rapidly when the vehicle is drifting out of a detected lane. <p>When you selected Normal, Wide or Narrow</p> <ul style="list-style-type: none"> - The steering wheel vibrates rapidly when the vehicle is drifting out of a detected lane. The system also steers the vehicle to help you remain within your driving lane. 	<ul style="list-style-type: none"> • Keep the vehicle within the lane you are driving. <ul style="list-style-type: none"> ► Lane Keeping Assist System (LKAS) P. 616 • Keep the vehicle within the lane you are driving. <ul style="list-style-type: none"> ► Road Departure Mitigation (RDM) System P. 625 • You can change the setting for the road departure mitigation system. Normal, Wide, Warning Only and Narrow can be selected. <ul style="list-style-type: none"> ► Vehicle Customization P. 143 ► Customized Features P. 463
	<p>Road Departure Mitigation (RDM) System</p> <p>When you selected Narrow</p> <ul style="list-style-type: none"> • Appears when the vehicle is likely to drive out a detected lane. The RDM system also steers the vehicle to help you remain within your driving lane. 	<p>—</p>
	<ul style="list-style-type: none"> • Blinks when you fail to steer the vehicle. The beeper sounds simultaneously. 	<ul style="list-style-type: none"> • Operate the steering wheel to resume the LKAS.

Message	Condition	Explanation
 Lane Keeping Assist Cannot Operate	<ul style="list-style-type: none"> Appears when the LKAS is in operation, or the LKAS button is pressed, but there is a problem with a system related to the LKAS. The LKAS cancels automatically. The beeper sounds simultaneously if selected by customization. 	<ul style="list-style-type: none"> If any other system indicators come on, such as the VSA®, ABS and brake system, take appropriate action. <ul style="list-style-type: none"> ➤ Indicators P. 88
 Some Driver Assist Systems Cannot Operate Radar Obstructed	<ul style="list-style-type: none"> Appears if anything covers the radar sensor cover and prevents the sensor from detecting a vehicle in front. May appear when driving in bad weather (rain, snow, fog, etc.) 	<ul style="list-style-type: none"> When the radar sensor gets dirty, stop your vehicle in a safe place, and wipe off dirt using a soft cloth. The message may take some time to go off. Have your vehicle checked by a dealer if the message does not disappear even after you clean the sensor cover. <ul style="list-style-type: none"> ➤ Radar Sensor P. 637 ➤ Honda Sensing® P. 586
 Some Driver Assist Systems Cannot Operate Camera Temperature Too High	<ul style="list-style-type: none"> Appears if the temperature inside the front sensor camera is too high and some driver assist systems cannot be activated. 	<ul style="list-style-type: none"> Use the climate control system to cool down the camera. Disappears - The camera has been cooled down and the systems are activated normally. <ul style="list-style-type: none"> ➤ Front Sensor Camera P. 635 ➤ Honda Sensing® P. 586
 Some Driver Assist Systems Cannot Operate Clean Front Windshield	<ul style="list-style-type: none"> Appears if the area around the front sensor camera is blocked by dirt, mud, etc. and be prevented from detecting a vehicle in front. May appear when driving in bad weather (rain, snow, fog, etc.) 	<ul style="list-style-type: none"> When the front window gets dirty, stop your vehicle in a safe place, and wipe it off with a soft cloth. Have your vehicle checked by a dealer if the message does not disappear even after you cleaned the area around the camera. <ul style="list-style-type: none"> ➤ Front Sensor Camera P. 635 ➤ Honda Sensing® P. 586

Gauges

Gauges include the fuel gauge, temperature gauge, and related indicators. They are displayed when the power mode is set to ON.

Fuel Gauge

Displays the amount of fuel left in the fuel tank.

Temperature Gauge

Displays the temperature of the engine coolant.

⌘ Fuel Gauge

NOTICE

You should refuel when the reading approaches **E**. Running out of fuel can cause the engine to misfire, damaging the catalytic converter.

The actual amount of remaining fuel may differ from the fuel gauge reading.

⌘ Temperature Gauge

NOTICE

Driving with the temperature gauge pointer in the upper zone can cause serious engine damage. Pull safely to the side of the road and allow engine temperature to return to normal.

➔ **Overheating** P. 737

Driver Information Interface

The driver information interface displays the speedometer, tachometer, odometer, trip computer, outside temperature, and other gauges. It also displays important messages such as warnings and other helpful information.

■ Speedometer

Displays your driving speed in mph or km/h.

■ Tachometer

Shows the number of engine revolutions per minute.

☒ Speedometer

You can set the speedometer and the displayed measurements to read in either mph and km/h.

☒ **Units** P. 138

☒ Tachometer

You can turn on or off the tachometer display.

☒ **Show Tachometer** P. 142

■ Odometer

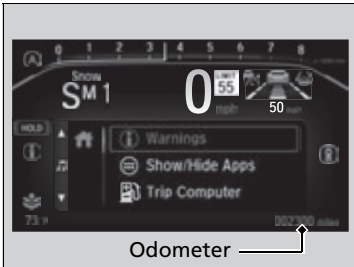

Shows the total number of miles or kilometers that your vehicle has accumulated.

■ Outside Temperature*

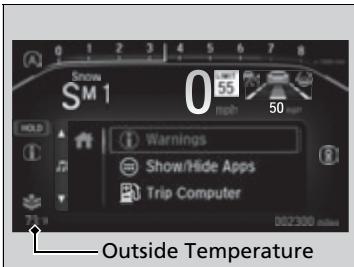

Shows the outside temperature in Fahrenheit (U.S.) or Celsius (Canada).

Adjusting the outside temperature display

Adjust the temperature reading by up to $\pm 5^{\circ}\text{F}$ or $\pm 3^{\circ}\text{C}$ if the temperature reading seems incorrect.

Use the audio/information screen to correct the temperature.

▶ **Customized Features** P. 463

▣ Outside Temperature*

The temperature sensor is in the front bumper. Road heat and exhaust from another vehicle can affect the temperature reading when your vehicle speed is less than 19 mph (30 km/h).

It may take several minutes for the display to be updated after the temperature reading has stabilized.



* Not available on all models

■ Traffic Sign Recognition System

Shows the traffic sign recognition system.

- **Traffic Sign Recognition System** P. 630

■ Accessing Content

Press the  (home) button, then press the  button to scroll to the content you want to see. Press **ENTER** to see detailed information.

*1: Models with color audio system

*2: Models with Display Audio

» Traffic Sign Recognition System

You can turn on or off the traffic sign recognition system.



Models with color audio system

- **Vehicle Customization** P. 143

Models with Display Audio

- **Customized Features** P. 463

» Accessing Content

To go back to the previous screen, press the  ^{*1} /  ^{*2} (back) button.

You can edit, add, or delete the meter contents using the driver information interface.

- **Arrange Apps** P. 141

- **Show/Hide Apps** P. 140

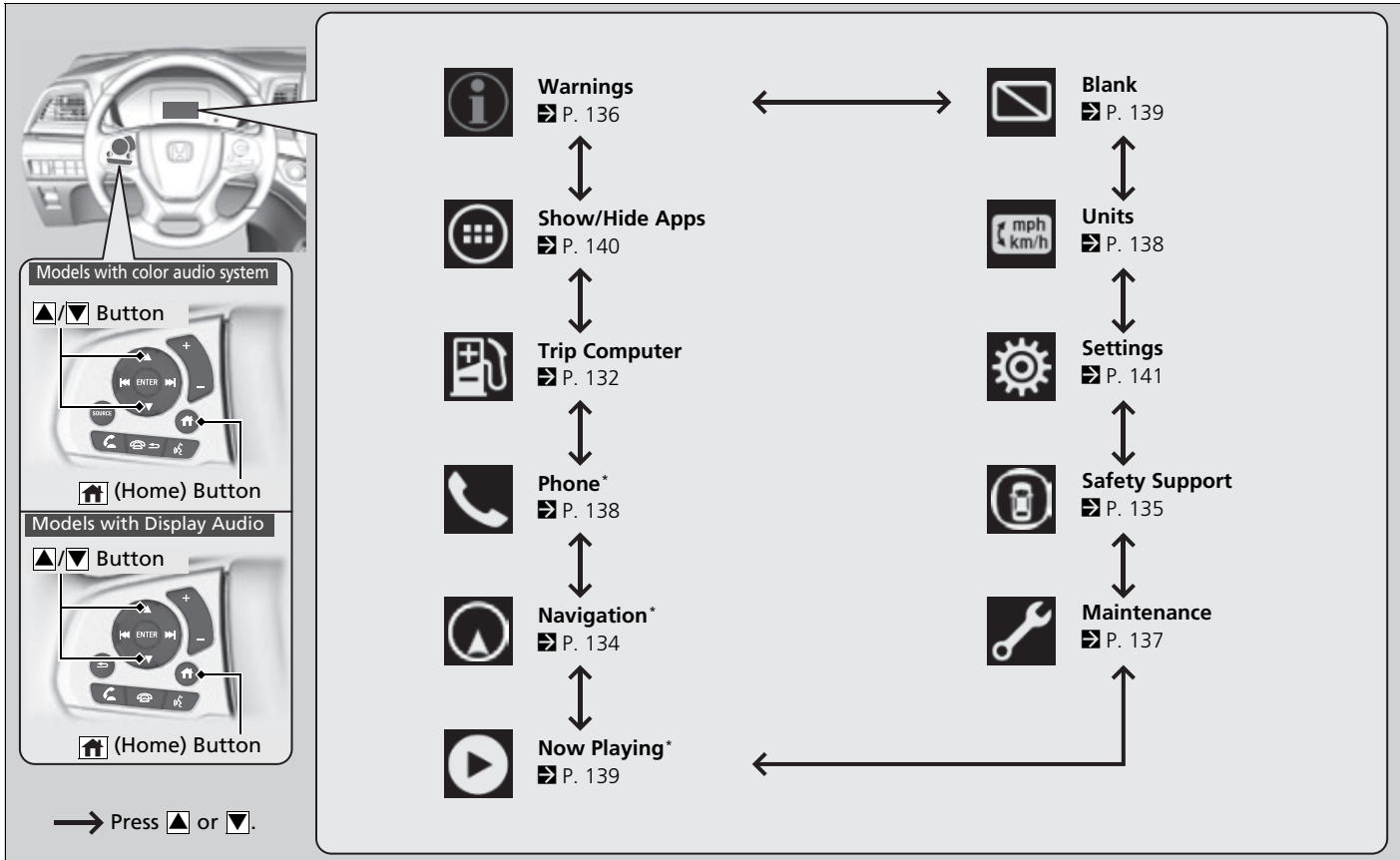

* Not available on all models

■ Trip Computer

Press the **ENTER** button to switch between trip computer A and trip computer B.

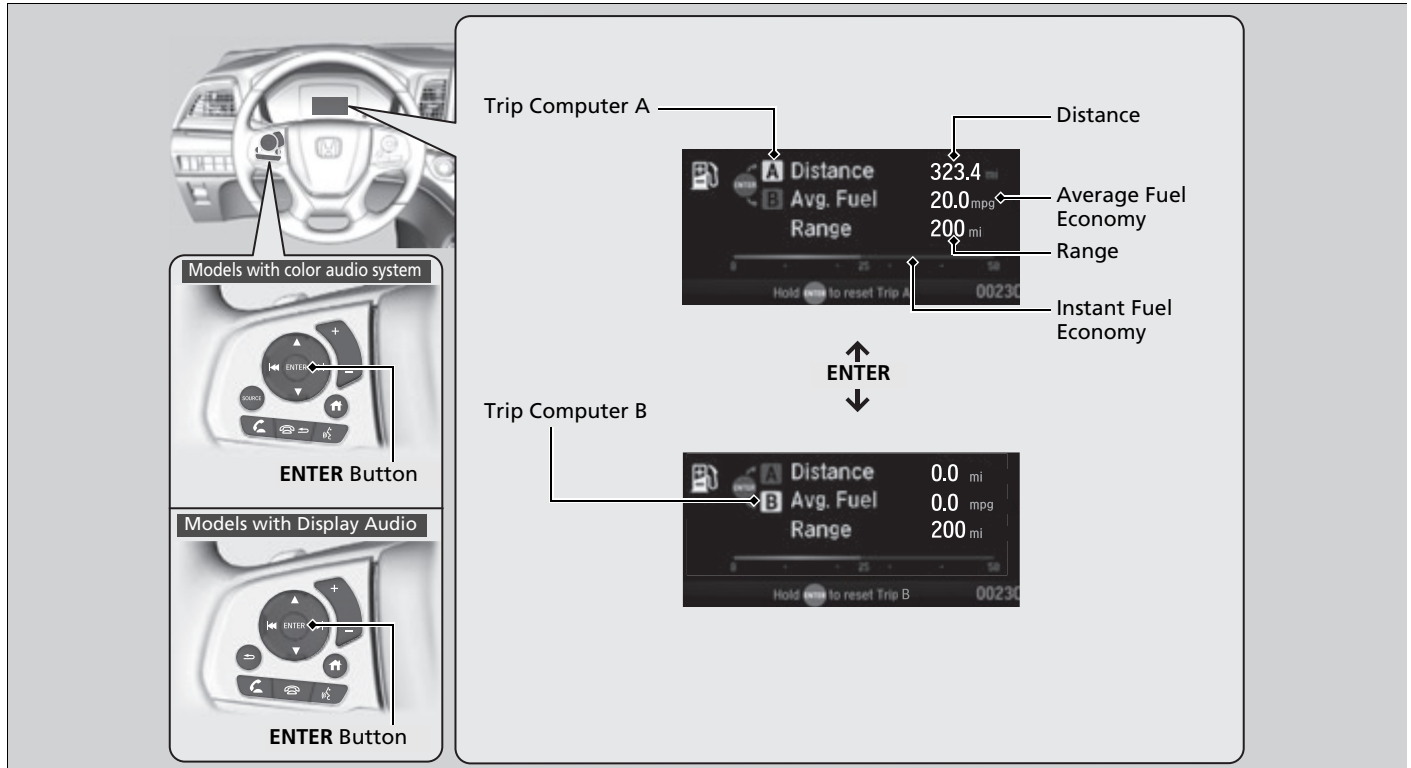

■ Distance

Shows the total number of miles or kilometers driven since the last reset. Meters A and B can be used to measure two separate trips.

Resetting distance

To reset the **Distance**, display it and then press and hold the **ENTER** button until the **Distance** is reset to **0.0**.

■ Average fuel economy (Avg. Fuel)

Shows the estimated average fuel economy of each **Distance** in mpg or l/100 km. The display is updated at set intervals. When a **Distance** is reset, the average fuel economy is also reset.

■ Instant fuel economy

Shows the instant fuel economy as a bar graph in mpg or l/100 km.

■ Range

Shows the estimated distance you can travel on the remaining fuel. This estimated distance is based on the vehicle's current fuel economy.

Distance

Switch between **Distance A** and **Distance B** by pressing the **ENTER** button.

Average fuel economy (Avg. Fuel)

You can change when the average fuel economy is reset.

Models with color audio system

➔ **Vehicle Customization** P. 143

Models with Display Audio

➔ **Customized Features** P. 463

■ Navigation *

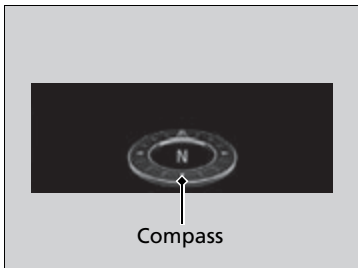

■ Compass

Shows the compass screen.

■ Turn-by-Turn Directions

When driving guidance is provided by the navigation system* or Android Auto, turn-by-turn directions to your destination appear.

➤ Refer to the **Navigation System Manual**

➤ **Android Auto** P. 376

» Navigation *

You can select whether to have the turn-by-turn display come on or not during route guidance.

➤ **Customized Features** P. 463

Models with navigation system

When the compass or turn-by-turn directions are displayed, you can control some navigation system functions on the driver information interface by pressing the **ENTER** button.

➤ Refer to the **Navigation System Manual**

Safety Support

Indicates the state of RDM, CMBS™ and Blind spot information System*, such as On, Off, or Failure, by color and letters.

The following colors indicate the state of any of the above mentioned systems:

- Green: The system is on.
- Gray: The system is off.
- Amber: There is a problem with the system.

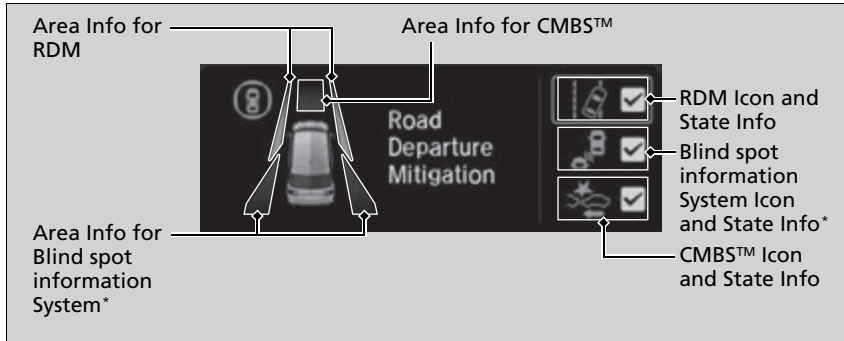

* Not available on all models

Continued

» Safety Support

If a system is indicated by the color amber, have your vehicle checked by a dealer immediately.

To turn on or off each system, first press the ▲/▼ button to switch displays. From the next display you can select which system to turn on or off.

➤ **RDM On and Off** P. 627

➤ **CMBS™ On and Off** P. 593

➤ **Blind spot information system on and off** P. 583

You can also confirm the state of the each function by the color of the safety support indicator.

➤ **Safety Support Indicator (Amber)** P. 104

➤ **Safety Support Indicator (Green/Gray)** P. 107

■ Warnings

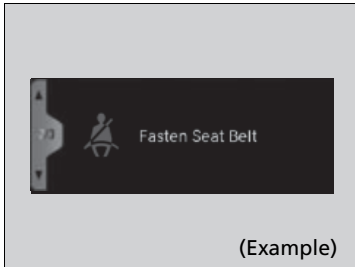

➤ Driver Information Interface Warning and Information Messages P. 108

⌘ Warnings

The **Warnings** app is dynamic and will only appear when there are active warnings. If there are no Warnings, this app will not be shown.

Maintenance



Shows the current condition of the tire pressure and the remaining oil life.

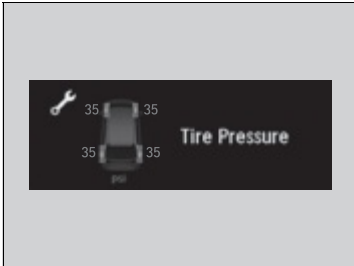

■ Tire Pressure

Shows the tire pressure of each tire.

➤ **Tire Pressure Monitoring System (TPMS) with Tire Fill Assist** P. 577



■ Oil Life

Shows the remaining oil life and Maintenance Minder™.

➤ **Maintenance Minder™** P. 667

■ Phone*

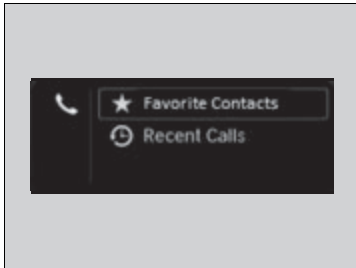

Shows the current phone information.

▶ **Bluetooth® HandsFreeLink®** P. 510

■ Units

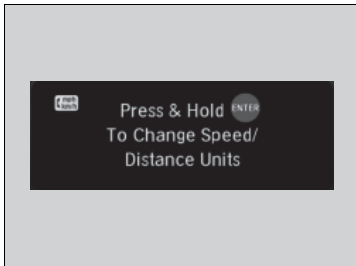

Enables you to set the speedometer and the displayed measurements to read in either mph or km/h.

Press and hold the **ENTER** button. Each time you do this, the unit will change from mph to km/h or vice versa. After this, a confirmation screen will appear for a few seconds.

■ Blank

Shows blank screen.

■ Now Playing*

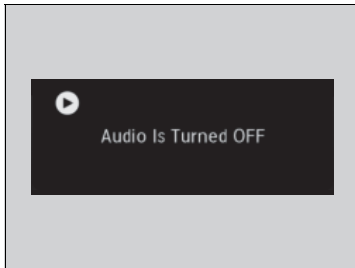

Shows the current audio information.

▶ **Audio System Basic Operation** P. 300

* Not available on all models

■ Show/Hide Apps

You can show or hide the meter contents.



Select the content you wish to show or hide, then press **ENTER**.

- ▶ Repeat it if you want to show or hide more than one app.

▶ Show/Hide Apps

You cannot hide apps with the  icon on the right side.

Selecting **Default All** in **Vehicle Customization** does not restore these settings to their original state.

Models with Display Audio

You can also add the **Android Auto**, **Apple CarPlay**, **Sirius XM***, **My Honda Music**, **USB**, **AM**, **FM**, **Bluetooth Audio**, **Social Playlist**, **AUX Input**, **CD*** and **Rear Entertainment*** apps.

Settings

Change the settings to your liking.

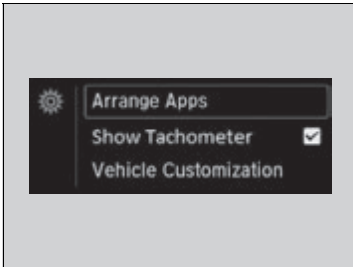

■ Arrange Apps

You can change the order of the apps on the home screen.

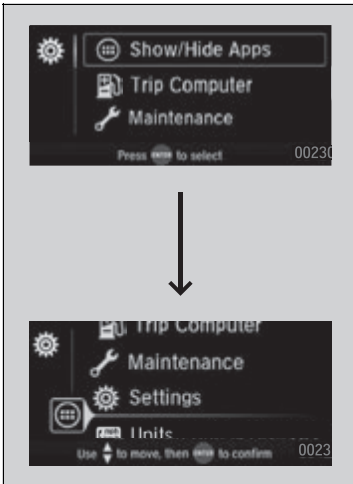

1. Press the ▲/▼ button to select **Arrange Apps**, then press **ENTER**.
2. Press the ▲/▼ button to select the icon you want to move, then press **ENTER**.

3. Press the ▲/▼ button repeatedly to move the icon to your desired position, then press **ENTER**.

☒ Arrange Apps

Selecting **Default All** in **Vehicle Customization** does not restore these settings to their original state.

Continued

■ Show Tachometer

You can show or hide the tachometer.

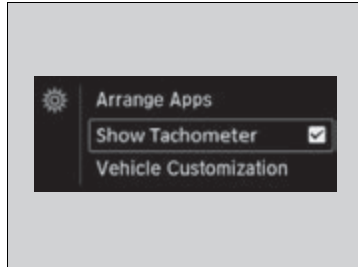

Press the  button to select **Show Tachometer**, then press **ENTER**.

- ▶ The tachometer appears when the check box is checked.

» Show Tachometer



Selecting **Default All** in **Vehicle Customization** does not restore these settings to their original state.

Models with color audio system

■ **Vehicle Customization**

Use the driver information interface to customize certain vehicle features.

How to customize

First, make sure the vehicle is at a complete stop and that the power mode is set to ON. Next, press the  (home) button, then press the  button to select **Settings**. Finally, press the **ENTER** button.

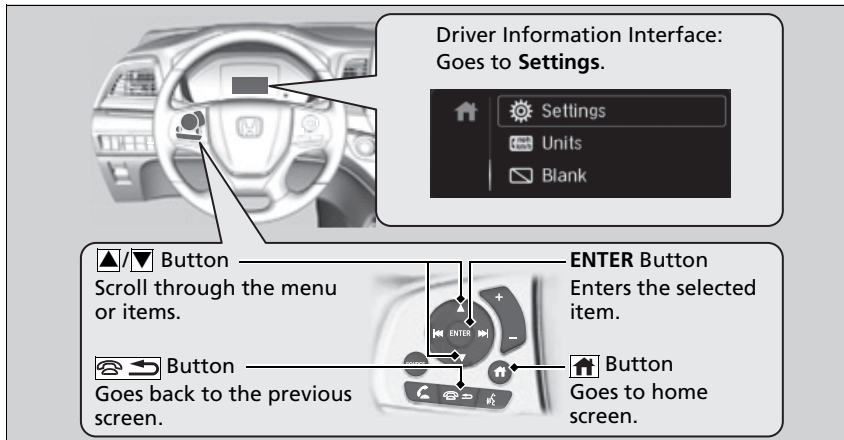

▶▶ Vehicle Customization

To customize other features, press the  button.

▶ **List of customizable options** P. 146

▶ **Example of how to customize a setting**
P. 150

Change to  before you attempt to change a customized setting.

Customization flow

Press the  (home) button.

Instrument Panel

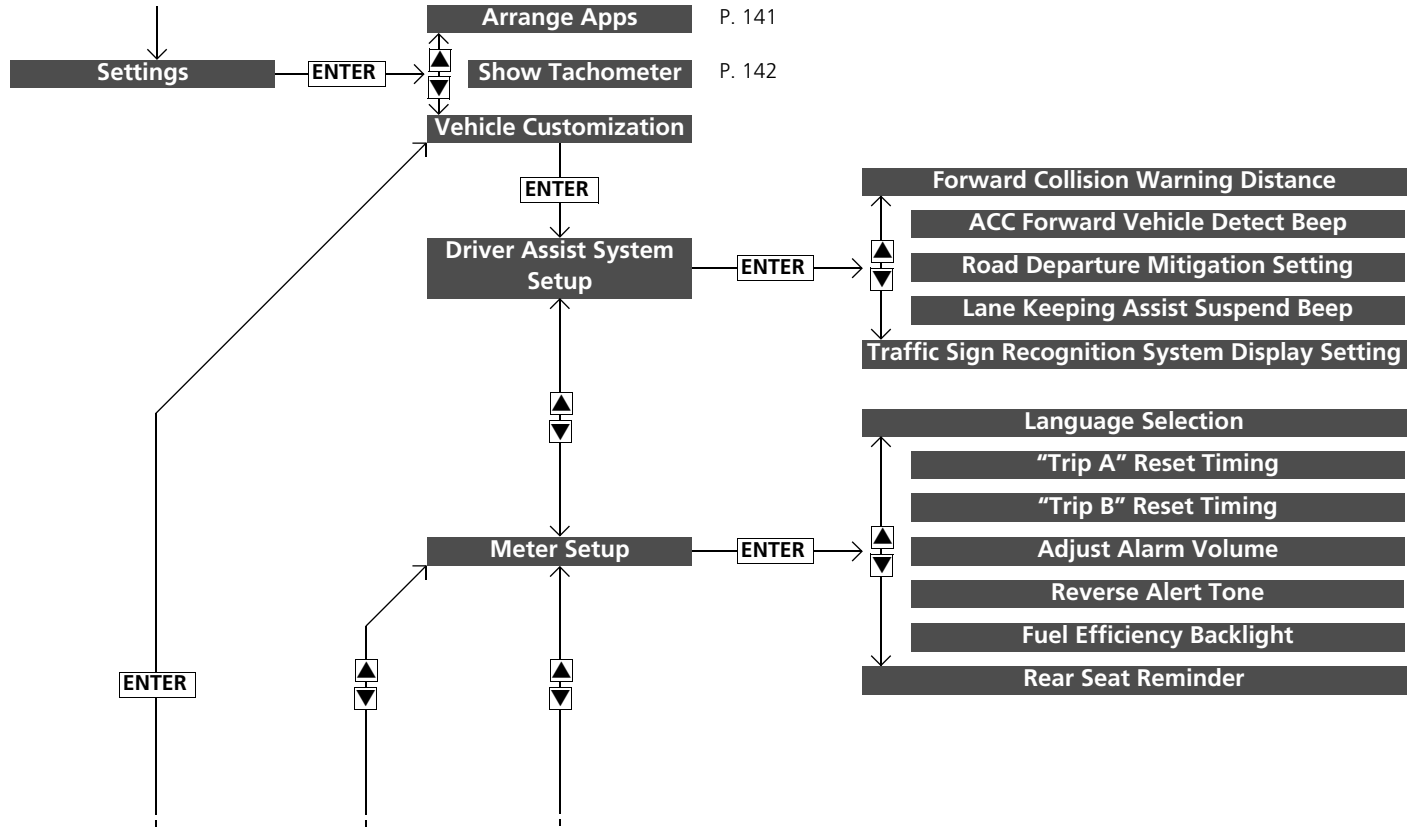

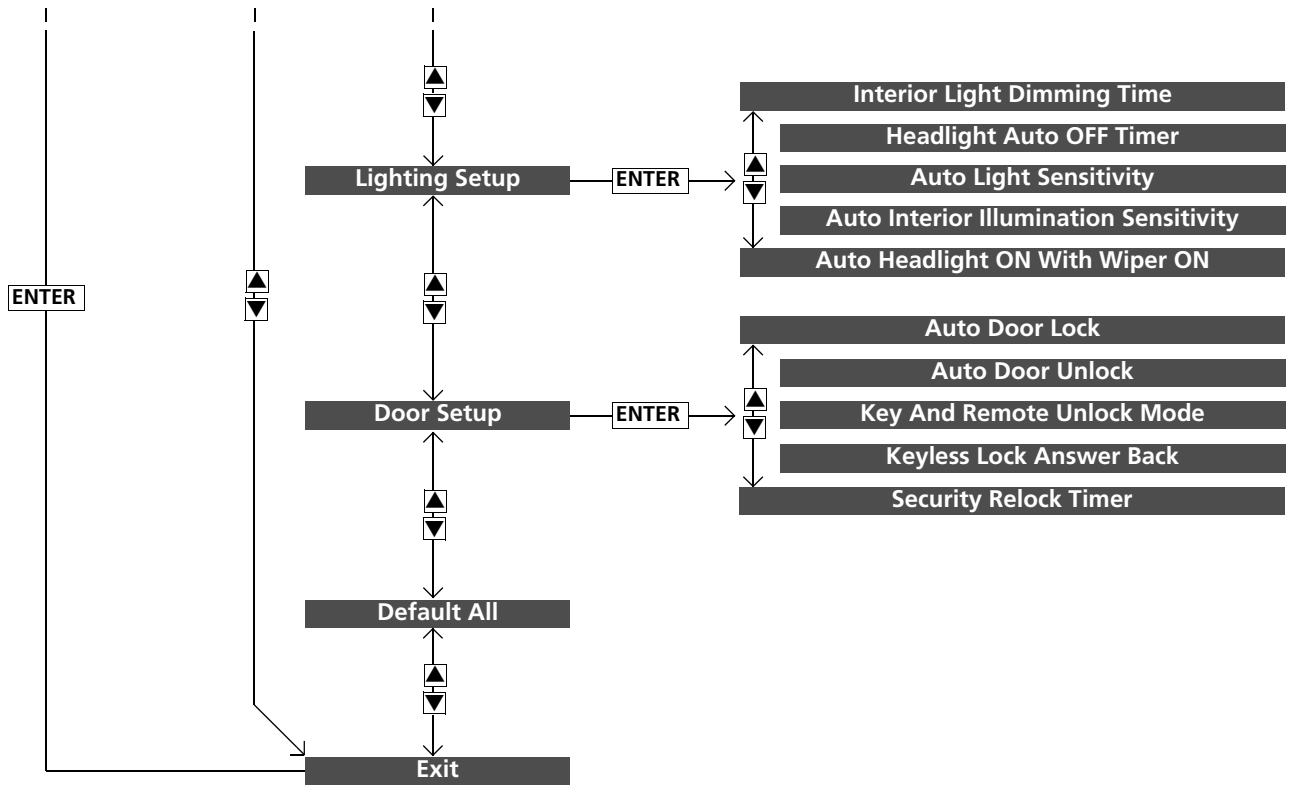

Instrument Panel

■ List of customizable options

Setup Group	Customizable Features	Description	Selectable Settings
Driver Assist System Setup	Forward Collision Warning Distance	Changes the distance at which CMBS™ alerts.	Long/Normal*¹/Short
	ACC Forward Vehicle Detect Beep	Causes the system to beep when the system detects a vehicle, or when the vehicle goes out of ACC range.	ON/OFF*¹
	Road Departure Mitigation Setting	Changes the setting for the road departure mitigation system.	Narrow/Normal*¹/Wide/Warning Only
	Lane Keeping Assist Suspend Beep	Causes the system to beep when the LKAS is suspended.	ON/OFF*¹
	Traffic Sign Recognition System Display Setting	Selects whether the traffic sign icons come on.	ON*¹/OFF

*1:Default Setting

Setup Group	Customizable Features	Description	Selectable settings
Meter Setup	Language Selection	Changes the displayed language.	English^{*1}/Français/Español
	"Trip A" Reset Timing	Changes the setting of how the distance and average fuel economy of trip computer A is reset.	When Fully Refueled/IGN OFF/Manually Reset^{*1}
	"Trip B" Reset Timing	Changes the setting of how the distance and average fuel economy of trip computer B is reset.	When Fully Refueled/IGN OFF/Manually Reset^{*1}
	Adjust Alarm Volume	Changes the volume setting for buzzers, warnings, turn signals, and other alerting systems.	High/Mid^{*1}/Low
	Reverse Alert Tone	Causes the beeper to sound once when the gear position is changed to R .	ON^{*1}/OFF
	Fuel Efficiency Backlight	Turns the ambient meter feature on and off.	ON^{*1}/OFF
	Rear Seat Reminder	Turns the Rear Seat Reminder feature on and off.	ON^{*1}/OFF

*1:Default Setting

Setup Group	Customizable Features	Description	Selectable settings
Lighting Setup	Interior Light Dimming Time	Changes the length of time the interior lights stay on after you close the doors.	60sec/30sec^{*1}/15sec
	Headlight Auto OFF Timer	Changes the length of time the exterior lights stay on after you close the driver's door.	60sec/30sec/15sec^{*1}/0sec
	Auto Light Sensitivity	Changes the timing for the headlights to come on.	Max/High/Mid^{*1}/Low/Min
	Auto Interior Illumination Sensitivity	Changes the sensitivity of the brightness of the instrument panel when the headlight switch is in the AUTO position.	Max/High/Mid^{*1}/Low/Min
	Auto Headlight ON With Wiper ON	Changes the settings for the wiper operation when the headlights automatically come on while the headlight switch is in the AUTO position.	ON^{*1}/OFF

*1: Default Setting

Setup Group	Customizable Features	Description	Selectable settings
Door Setup	Auto Door Lock	Changes the setting for when the doors automatically lock.	With Vehicle Speed*¹/Shift From P/OFF
	Auto Door Unlock	Changes the setting for when the doors automatically unlock.	All Doors When Driver's Door Opens*¹/All Doors When Shifted To Park/All Doors When Ignition Switched OFF/OFF
	Key And Remote Unlock Mode	Sets up either the driver's door or all doors to unlock on the first operation of the remote or built-in key.	Driver Door*¹/All Doors
	Keyless Lock Answer Back	LOCK/UNLOCK - The exterior lights flash. LOCK (2nd push)- The beeper sounds.	ON*¹/OFF
	Security Relock Timer	Changes the time it takes for the doors to relock and the security system to set after you unlock the vehicle without opening a door.	90sec/60sec/30sec*¹
Default All	—	Cancels customized changes you have made or restores them to their default setting.	Cancel/Set



*1:Default Setting

Example of how to customize a setting

Below are steps that explain how to change the reset timing for trip A from the default setting (manual) so that it resets automatically when the vehicle is fully refueled.

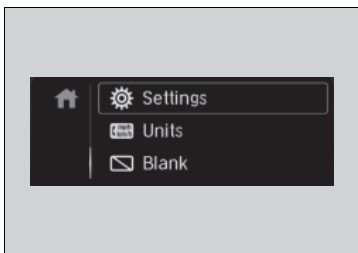
Instrument Panel



1. Press the  (home) button and then the  button to select **Settings**, then press the **ENTER** button.

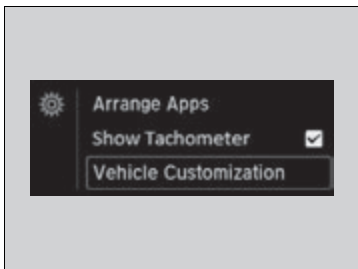

2. Press the  button to select **Vehicle Customization**, then press the **ENTER** button.

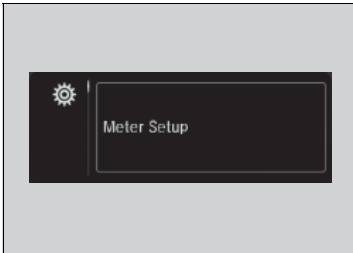

3. Press the / button to select **Meter Setup**, then press the **ENTER** button.
 - **Language Selection** appears first in the display.

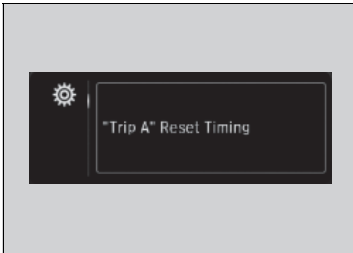





4. Press the / button to select **"Trip A" Reset Timing**, then press the **ENTER** button.
 - The display switches to the customization setup screen, where you can select **When Fully Refueled**, **IGN OFF**, **Manually Reset**, or **Exit**.



5. Press the / button to select **When Fully Refueled**, then press the **ENTER** button.
 - The **SETUP "When Fully Refueled"** screen appears, then the display returns to the customization menu screen.



6. Press the / button until **Exit** appears on the display, then press the **ENTER** button.
7. Repeat Step 6 until you return to the **Vehicle Customization** screen, then press the  (home) or  (back) button to return to the home screen.

Controls

This chapter explains how to operate the various controls necessary for driving.



Lock	154
Locking and Unlocking the Doors	
Key	156
Low Keyless Remote Signal Strength ...	158
Locking/Unlocking the Doors from the Outside ...	159
Locking/Unlocking the Doors from the Inside ...	166
Childproof Door Locks	169
Auto Door Locking/Unlocking	170
Tailgate	171
Sliding Doors	182
Security System	
Immobilizer System	191
Security System Alarm	191
Windows	194
Moonroof*	197

Operating the Switches Around the Steering Wheel	
ENGINE START/STOP Button	198
Turn Signals	201
Light Switches	202
Fog Lights*	205
Daytime Running Lights	206
Auto High-Beam	207
Wipers and Washers	210
Rear Defogger/Heated Door Mirror* Button ...	213
Canadian models	
Heated Windshield Button	214
Brightness Control	215
Driving Position Memory System*	216
Adjusting the Steering Wheel	218

Mirrors	219
Interior Rearview Mirror	219
Power Door Mirrors	220
Seats	
Front Seats	222
Maintain a Proper Sitting Position	234
Head Restraints	235
Interior Convenience Items	239
Dual-zone climate control system	
Climate Control System	
Using Automatic Climate Control	260
Rear Climate Control System	263
Tri-zone climate control system	
Climate Control System	
Using Automatic Climate Control	265
Automatic Climate Control Sensors	271

* Not available on all models







Adjusting the Clock

You can adjust the time manually in the audio/information screen, with the power mode in ON.

Adjusting the Time



Models with color audio system

1. Press and hold the **MENU/CLOCK** button.
2. Select **Adjust Clock**, then press .
3. Rotate  to adjust the hours.
4. Press  to switch to minute adjustment.
5. Rotate  to adjust the minutes.
6. Press  to switch to **Set**.
7. Press  to complete clock adjustment.

» Clock

Models with navigation system

The clock is automatically updated through the navigation system, so the time does not need to be adjusted.







Models with color audio system

These indications are used to show how to operate the selector knob.

Rotate  to select.

Press  to enter.

To change the setting between **12h** and **24h**:



1. Press the **MENU/CLOCK** button.
2. Rotate  to select **Settings**, then press .
3. Rotate  to select **Clock Format**, then press .
4. Rotate  to select **12h** or **24h**, then press .



Models with Display Audio

1. Select , then select **Settings**.
2. Select **System**.
3. Select **Date & Time**.
4. Select **Set Date & Time**.
5. Select **Automatic Date & Time**, then select **OFF**.

To adjust time:

6. Select **Set Time**.
7. Selecting .
 - ▶ AM/PM icon can be switched to each other either by selecting , or by directly touching the icon.
 - ▶ When you customize the clock display to 24 hour clock, AM/PM icon is not displayed.
8. Select **Save** to set the time.

To adjust date:

6. Select **Set Date**.
7. Selecting .
8. Select **Save** to set the date.



▶▶ Clock

Models with Display Audio

You can also adjust the clock by touching the clock displayed on the upper right corner of the display or the **Clock** icon on the home screen.

1. Touch the clock on the display.
The clock screen of the select face-type appears.
2. Select **Settings**.
3. Select **Date & Time Settings**.
4. Select **Set Date & Time**.
5. Select **Automatic Date & Time**, then select **OFF**.
6. Select **Set Date** or **Set Time**.
7. Adjusting the dates, hours and minutes by selecting .
8. Select **Save** to set the time.

You can customize the clock display to show the 12 hour clock or 24 hour clock.

 **Customized Features** P. 463

Key

This vehicle comes with the following keys:

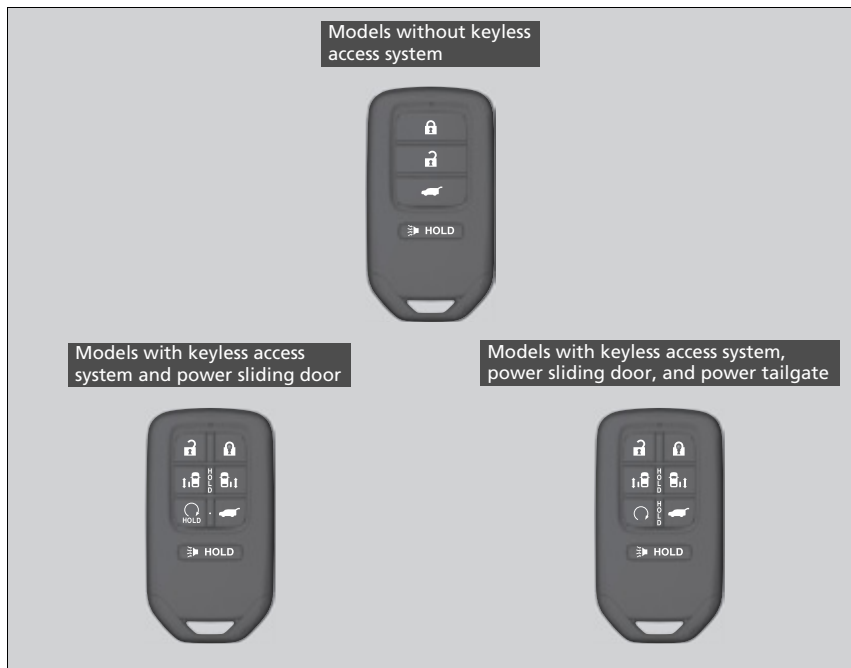

Use the keys to start and stop the engine, and to lock and unlock all the doors, tailgate, and fuel fill door.

Key

All of the keys have an immobilizer system. The immobilizer system helps to protect against vehicle theft.

➤ **Immobilizer System** P. 191

Follow the advice below to prevent damage to the keys:

- Do not leave the keys in direct sunlight, or in locations with high temperature or high humidity.
- Do not drop the keys or set heavy objects on them.
- Keep the keys away from liquids, dust or sand.
- Do not take the keys apart except for replacing the battery.

If the circuits in the keys are damaged, the engine may not start, and the remote transmitter may not work.

If the keys do not work properly, have them inspected by a dealer.

Models with keyless access system

You can remotely start the engine using the remote engine start.

➤ **Remote Engine Start with Vehicle Feedback*** P. 552

■ Built-in Key

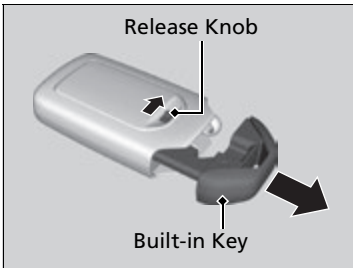

The built-in key can be used to lock/unlock the doors and tailgate when the keyless remote battery becomes weak and the power door lock/unlock operation is disabled.

To remove the built-in key, slide the release knob and then pull out the key. To reinstall the built-in key, push the built-in key into the keyless remote until it clicks.

■ Key Number Tag

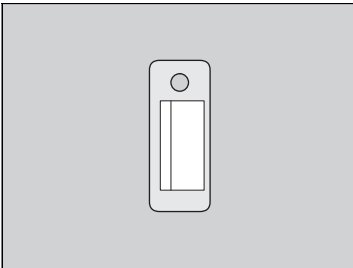

Contains a number that you will need if you purchase a replacement key.

▣ Key Number Tag

Keep the key number tag separate from the key in a safe place outside of your vehicle. If you wish to purchase an additional key, contact a dealer.

If you lose your key and you cannot start the engine, contact a dealer.

Low Keyless Remote Signal Strength

The vehicle transmits radio waves to locate the keyless remote when locking/unlocking the doors*, tailgate*, and fuel fill door*, opening the power sliding door* and the power tailgate*, or to start the engine.

In the following cases, locking/unlocking the doors*, opening the power sliding door* and the power tailgate*, or starting the engine may be inhibited or operation may be unstable:

- Strong radio waves are being transmitted by nearby equipment.
- You are carrying the keyless remote together with telecommunications equipment, laptop computers, cell phones, or wireless devices.
- A metallic object is touching or covering the keyless remote.

Low Keyless Remote Signal Strength

Communication between the keyless remote and the vehicle consumes the keyless remote's battery. Battery life is about two years, but this varies depending on regularity of use.

The battery is consumed whenever the keyless remote is receiving strong radio waves. Avoid placing it near electrical appliances such as televisions and personal computers.

Locking/Unlocking the Doors from the Outside

■ Using the Keyless Access with Push Button Start System *

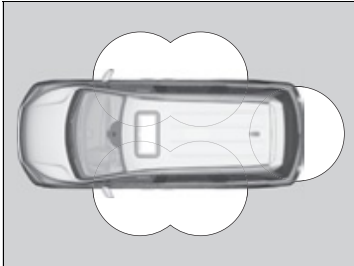

When you carry the keyless remote, you can lock/unlock the doors, fuel fill door, and open the tailgate.

You can lock/unlock the doors, fuel fill door, and tailgate within a radius of about 32 inches (80 cm) of the outside door handle or tailgate outer handle.

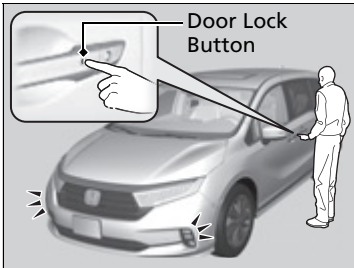

■ Locking the doors and tailgate

Press the door lock button on the front door or the tailgate.

- ▶ Some exterior lights flash; the beeper sounds; all the doors and tailgate lock; and the security system sets.

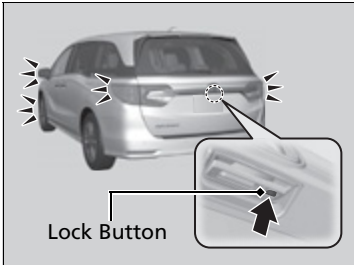

☒ Locking/Unlocking the Doors from the Outside

If the interior light switch is in the door activated position, the interior lights come on when you unlock the doors and tailgate.

No doors opened: The lights fade out after 30 seconds. Doors and tailgate relocked: The lights go off immediately.

☒ Interior Lights P. 239

☒ Using the Keyless Access with Push Button Start System *

You can lock or unlock doors using the keyless access system only when the power mode in VEHICLE OFF.

- Do not leave the keyless remote in the vehicle when you get out. Carry it with you.
- Even if you are not carrying the keyless remote, you can lock/unlock the doors and the tailgate while someone else with the remote is within range.
- The door may be unlocked if the door handle is covered with water in heavy rain or in a car wash if the keyless remote is within range.
- If you grip a door handle wearing gloves, the door sensor may be slow to respond or may not respond by unlocking the doors.
- After locking the door, you have up to 2 seconds during which you can pull the door handle to confirm whether the door is locked. If you need to unlock the door immediately after locking it, wait at least 2 seconds before gripping the handle, otherwise the door will not unlock.
- The door might not open if you pull it immediately after gripping the door handle. Grip the handle again and confirm that the door is unlocked before pulling the handle.
- Even within the 32 inches (80 cm) radius, you may not be able to lock/unlock the doors and the tailgate with the keyless remote if it is above or below the outside handle.
- The keyless remote may not operate if it is too close to the door and door glass.

* Not available on all models

■ Unlocking the doors and tailgate

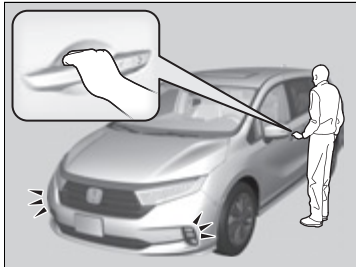

- Grab the driver's door handle:
- ▶ The driver's door and fuel fill door unlocks.
 - ▶ Some exterior lights flash twice and the beeper sounds twice.

Grab the front passenger's door or rear door handle:

- ▶ All doors and the tailgate unlock.
- ▶ Some exterior lights flash twice and the beeper sounds twice.

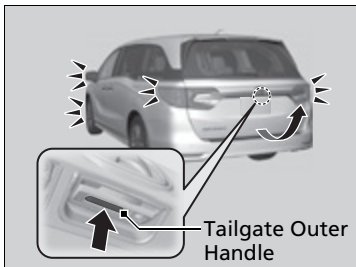
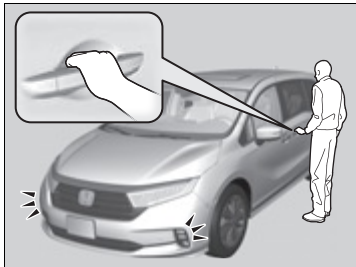

Press the tailgate outer handle:

- ▶ The tailgate unlocks.
 - ▶ Some exterior lights flash twice and the beeper sounds twice.
- ▶ **Opening/Closing the Tailgate** P. 172

▶▶ Using the Keyless Access with Push Button Start System *

If you do not open a door or the tailgate within 30 seconds of unlocking the vehicle with the keyless access system, the doors and tailgate will automatically relock.

The light flash, beep and unlock settings can be customized.

▶ **Customized Features** P. 463

Models with power tailgate

You can also unlock and open with the power tailgate.

▶ **Using the Tailgate Outer Handle** P. 178

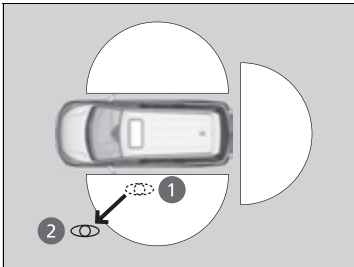
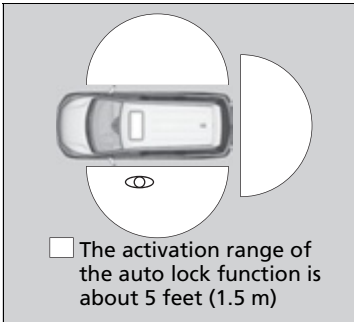

■ Locking the doors and tailgate (Walk away auto lock®)

When you walk away from the vehicle with all doors and tailgate closed while carrying the keyless remote, the doors and tailgate will automatically lock.

The auto lock function activates when all doors and tailgate are closed, and the keyless remote is within about 5 feet (1.5 m) radius of the outside door handle.

Exit vehicle while carrying the keyless remote and close door(s) and tailgate.

1. While within about 5 feet (1.5 m) radius of the vehicle.

▶ The beeper sounds; the auto lock function will be activated.

2. Carry the keyless remote beyond about 5 feet (1.5 m) from the vehicle and remain outside this range for 2 or more seconds.

▶ Some exterior lights flash; the beeper sounds; all doors and tailgate will then lock.

☒ Locking the doors and tailgate (Walk away auto lock®)

The auto lock function is set to OFF as the factory default setting. The auto lock function can be set to ON using the audio/information screen.

If you set the auto lock function to ON using the audio/information screen, only the remote transmitter that was used to unlock the driver's door prior to the setting change can activate auto lock.

▶ **Customized Features** P. 463

After the auto lock function has been activated, when you stay within the locking/unlocking operation range, the indicator on the keyless remote will continue to flash until the doors and tailgate are locked.

When you stay beside the vehicle within the operation range, the doors and tailgate will automatically lock approximately 30 seconds after the auto lock function activating beeper sounds.

When you open a door or tailgate after the auto lock function activating beeper sounds, the auto lock function will be canceled.

Under the following circumstances, the auto lock function will not activate:

- The keyless remote is inside the vehicle.
- ▶ The beeper will not sound.
- The keyless remote is taken out of its operational range before all doors and tailgate are closed.
- ▶ The beeper will sound.

To temporarily deactivate the function:

1. Set the power mode to OFF.
2. Open the driver's door.
3. Using the master door lock switch, operate the lock as follows:
Lock→Unlock→Lock→Unlock.
▶ The beeper sounds and the function is deactivated.

To restore the function:

- Set the power mode to ON.
- Lock the vehicle without using the auto lock function.
- With the keyless remote on you, move out of the auto lock function operation range.
- Open any door.

▶ Locking the doors and tailgate (Walk away auto lock®)

The auto lock function does not operate when any of the following conditions are met.

- The keyless remote is inside the vehicle.
- A door, tailgate or the hood is not closed.
- The power mode is set to any mode other than OFF.
- The keyless remote is not located within a radius of about 5 feet (1.5 m) from the vehicle when you get out of the vehicle and close the doors and tailgate.

Auto lock function operation stop beeper

After the auto lock function has been activated, the auto lock operation stop beeper sounds for approximately two seconds in the following cases.

- The keyless remote is put inside the vehicle through a window.
- You are located too close to the vehicle.
- The keyless remote is put inside the tailgate.

If the warning beeper sounds, check that you are carrying the keyless remote. Then, open/close a door and confirm the auto lock activation beeper sounds once.

Models with power tailgate

If equipped, the user must wait until the power tailgate fully closes before the auto lock function will be activated.

■ Using the Remote Transmitter

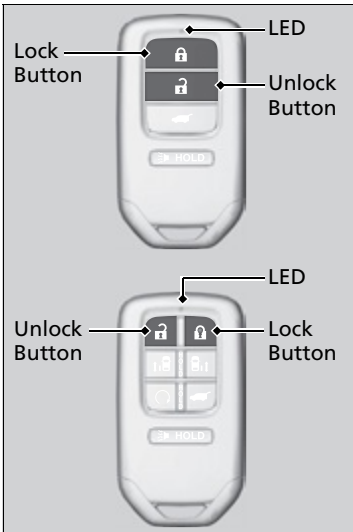

■ Locking the doors and tailgate

Press the lock button.

Once:

- ▶ Some exterior lights flash, all the doors, tailgate, and fuel fill door lock, and the security system sets.

Twice (within five seconds after the first push):

- ▶ A beeper sounds and verifies the security system is set.

▣ Using the Remote Transmitter

If you do not open a door or the tailgate within 30 seconds of unlocking the vehicle with the remote transmitter, the doors and tailgate will automatically relock.

You can change the relock timer setting.

Models with color audio system

➤ **Vehicle Customization** P. 143

Models with Display Audio

➤ **Customized Features** P. 463

The remote transmitter uses low-power signals, so the operating range may vary depending on the surroundings.

You can lock or unlock doors using the remote transmitter only when the power mode is in VEHICLE OFF.

The remote will not lock the vehicle when a door is open.

■ Unlocking the doors and tailgate

Press the unlock button.

Once:

- ▶ Some exterior lights flash twice, and the driver's door and fuel fill door unlocks.

Twice:

- ▶ The remaining doors and the tailgate unlock.

■ Locking/Unlocking the Doors Using a Key

If the lock or unlock button of the keyless remote does not work, use the key instead.

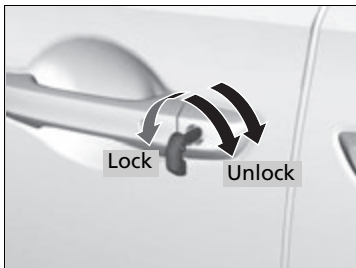

Fully insert the key and turn it.

▶▶ Using the Remote Transmitter

If the distance at which the remote transmitter works varies, the battery is probably low. If the LED does not come on when you press a button, the battery is dead.

▶▶ **Replacing the Remote Battery** P. 708

You can customize the door unlock mode setting.

▶▶ **Models with color audio system**

▶▶ **Vehicle Customization** P. 143

▶▶ **Models with Display Audio**

▶▶ **Customized Features** P. 463

▶▶ Locking/Unlocking the Doors Using a Key

When you lock the driver's door with a key, all of the other doors, tailgate, and fuel fill door lock at the same time. When unlocking, the driver's door unlocks first. Turn the key a second time within a few seconds to unlock the remaining doors and the tailgate.

You can customize the door unlock mode setting.

▶▶ **Models with color audio system**

▶▶ **Vehicle Customization** P. 143

▶▶ **Models with Display Audio**

▶▶ **Customized Features** P. 463

■ Locking a Door Without Using a Key

If you do not have the key on you, or if for some reason you cannot lock a door using the key, you can lock the door without it.

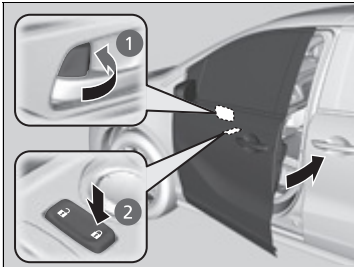

■ Locking the front doors

Push the lock tab forward **1** or push the master door lock switch in the lock direction **2**, and close the door.

■ Locking the rear doors

Slide the lock tab downward and close the door.

■ Lockout prevention system

The doors and tailgate cannot be locked when the keyless remote is inside the vehicle.

☒ Locking a Door Without Using a Key

When you lock the driver's door, all the other doors, tailgate, and fuel fill door lock at the same time. When you lock the front passenger's door with the master door lock switch, all the other doors and the tailgate lock at the same time. Before locking a door, make sure that the key is not inside the vehicle.

Locking/Unlocking the Doors from the Inside

■ Using the Lock Tab

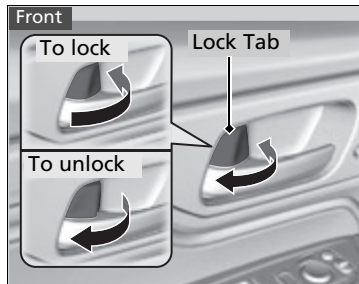

Front

■ Locking a door

Push the lock tab forward.

■ Unlocking a door

Pull the lock tab rearward.

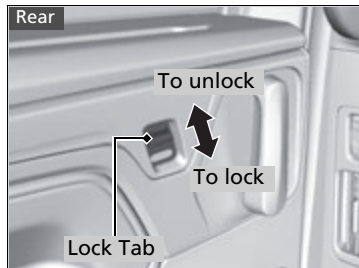

Rear

■ Locking a door

Slide the lock tab downward.

■ Unlocking a door

Slide the lock tab upward.

▶▶ Using the Lock Tab

When you lock the door using the lock tab on the driver's door, all of the other doors, tailgate, and fuel fill door lock at the same time.

When you unlock the door using the lock tab on the driver's door, only the driver's door will unlock.

■ Unlocking Using the Front Door Inner Handle



Pull the front door inner handle.

- ▶ The door unlocks and opens in one motion.

Unlocking and opening the front door from the inner handle unlocks all the other doors.

To avoid unlocking all the doors at once, use the lock tab on the driver's door to unlock, then lock again before opening the door.

- ▶ This setting works for one time only. If you do not want all the doors to be unlocked all the time, customize the **Auto Door Unlock** setting to **OFF** using the driver information interface* or audio/information screen*.

Models with color audio system

➤ **Vehicle Customization** P. 143

Models with Display Audio

➤ **Customized Features** P. 463

☒ Unlocking Using the Front Door Inner Handle

The front door inner handles are designed to allow front seat occupants to open the door in one motion. However this feature requires that front seat occupants never pull a front door inner handle while the vehicle is in motion.

Children should always ride in a rear seat where childproof door locks are provided.

➤ **Childproof Door Locks** P. 169

* Not available on all models

■ Using the Master Door Lock Switch

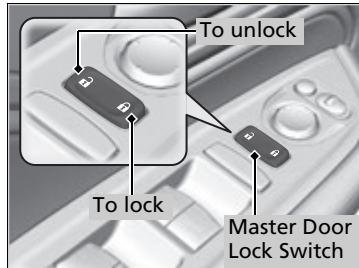

Press the master door lock switch in as shown to lock or unlock all doors, tailgate, and fuel fill door.

☒ Using the Master Door Lock Switch

When you lock/unlock either front door using the master door lock switch, all the other doors and the tailgate lock/unlock at the same time.

Childproof Door Locks

The childproof door locks prevent the rear doors from being opened from the inside regardless of the position of the lock tab.

■ Setting the Childproof Door Locks

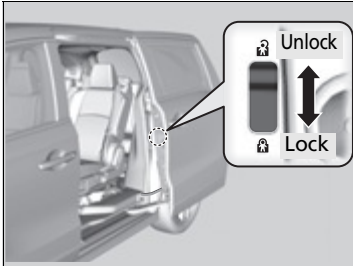

Slide the lever in the rear door to the lock position, and close the door.

■ When opening the sliding door

Open the door using the outside door handle.

☒ Childproof Door Locks



To open the door from the inside when the childproof door lock is on, put the lock tab in the unlock position, lower the rear window, put your hand out of the window, and pull the outside door handle.

Models with power sliding doors

The door pillar switches become disabled.

☒ Power Sliding Door Switches P. 186

You can open and close the power sliding door, using the power sliding door switches near the steering wheel, or the remote.

Auto Door Locking/Unlocking

Your vehicle locks and unlocks all doors and the tailgate automatically when a certain condition is met.

■ Auto Door Locking

■ Drive lock mode

All doors and the tailgate lock when the vehicle's speed reaches about 10 mph (15 km/h).

■ Auto Door Unlocking

■ Driver's door open mode

All doors and the tailgate unlock when the driver's door is opened.

▶▶ Auto Door Locking/Unlocking

You can turn off or change to another auto door locking/unlocking setting using the driver information interface* or audio/information screen*.

▶▶ Models with color audio system

▶▶ **Vehicle Customization** P. 143

▶▶ Models with Display Audio

▶▶ **Customized Features** P. 463

Precautions for Opening/Closing the Tailgate

Always make sure individuals and objects are clear of the tailgate before opening or closing it.

Models without power tailgate

- Open the tailgate all the way.
 - ▶ If it is not fully opened, the tailgate may begin to close under its own weight.
- Be careful when it is windy. The wind may cause the tailgate to close.

All models

Keep the tailgate closed while driving to:

- ▶ Avoid possible damage.
- ▶ Prevent exhaust gas from leaking into the vehicle.
 - ☒ **Carbon Monoxide Gas** P. 85

Precautions for Opening/Closing the Tailgate

WARNING

Anyone caught in the path of a tailgate that is being opened or closed can be seriously injured.

Make sure that all people are clear of the tailgate before opening or closing it.

Be careful not to hit your head on the tailgate or to put your hands between the tailgate and the cargo area when closing the tailgate.

When you are storing or picking up luggage from the cargo area, or by using a forward and back kicking motion under the center of the rear bumper for hands free access*, while the engine is idling, do not stand in front of the exhaust pipe. You may get burned.

Do not allow any passenger in the cargo space. They may get hurt during hard braking, a sudden acceleration, or a crash.

* Not available on all models

Opening/Closing the Tailgate

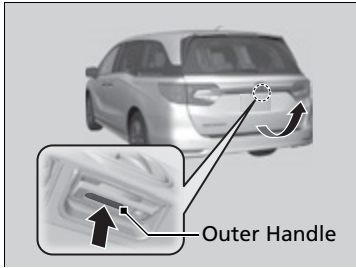

When all the doors are unlocked or press the tailgate unlock button on the remote transmitter, the tailgate is unlocked.

Press the outer handle of the tailgate and lift open the tailgate.

Models with keyless access system

If you are carrying the keyless remote, you do not have to unlock the tailgate before opening it.

To close the tailgate, grab the inner handle, pull the tailgate down, and push it closed from outside.

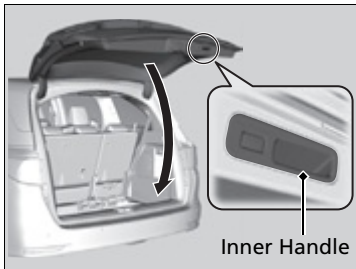

If you close the tailgate when all the doors are locked, the tailgate locks automatically.

- Some exterior lights flash.

►► Opening/Closing the Tailgate

Do not leave the keyless remote in the vehicle when you get out. Carry it with you.

Models with keyless access system

Even if you are not carrying the keyless remote, you can lock/unlock the tailgate while someone else with the keyless remote is within range.

All models

Do not leave the keyless remote inside the cargo area and close the tailgate. The beeper sounds and the tailgate cannot be closed.

■ Using the Remote Transmitter

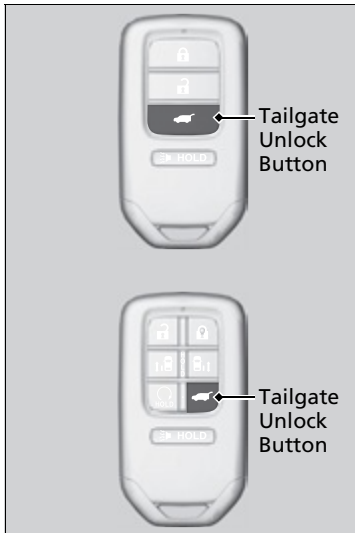

Press the tailgate unlock button to unlock the tailgate.

▣ Using the Remote Transmitter

If you have unlocked and opened the tailgate using the keyless remote, when closing, the tailgate locks automatically.

Opening/Closing the Power Tailgate*

The power tailgate can be operated by pressing the power tailgate button on the remote transmitter, pressing the power tailgate button in the driver's side control panel, pressing the button on the tailgate, or by raising and lowering your foot under the center of the rear bumper for hands free access (if equipped).

The power tailgate can be opened/closed when the transmission is in **P**.

► Opening/Closing the Power Tailgate*

WARNING

Opening or closing a power tailgate while any part of a passenger is in the tailgate's operating path can cause serious injury.

Make sure all passengers or objects are clear of the tailgate operating range before opening or closing the tailgate.

NOTICE

Do not push or pull on the power tailgate when it is being automatically opened or closed. Forcibly opening or closing the power tailgate while in operation can deform the tailgate frame.

When operating the power tailgate, make sure there is enough space around your vehicle. People near the tailgate may be seriously hurt if the tailgate hits or closes on their heads. Be especially cautious if children are around.

The power tailgate may not open or close under the following conditions:

- You start the engine while the tailgate is automatically opening or closing.
- The vehicle is parked on a steep hill.
- The vehicle is swayed in a strong wind.
- The tailgate or the roof is covered with snow or ice.

■ Using the Hands Free Access*

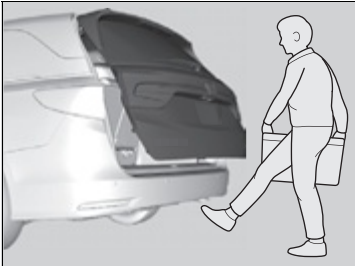

Use a forward and back kicking motion for about 1 second under the center of the rear bumper to open or close the power tailgate while carrying the keyless remote.

- Some exterior lights flash and a beeper sounds, then the tailgate begins to move.

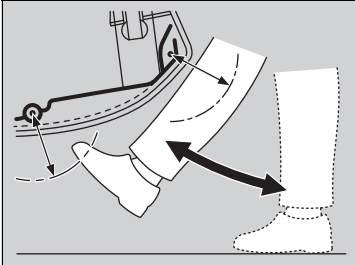

☒ Using the Hands Free Access*

During rain or in other instances when the vehicle becomes wet, the sensor may not properly detect your foot motion.

When performing work on or around the rear section of the vehicle, you may inadvertently open or close the tailgate.

To prevent this from happening, select Customized Features on the audio/information screen display and then select **OFF** for the feature.

➤ **Customized Features** P. 463

If you hold your foot under the bumper for too long or sweep your foot from side to side, the power tailgate does not open or close.

This function will not operate if you don't have the keyless remote on you. Please make sure you have the keyless remote on you.

* Not available on all models

■ Using the Remote Transmitter

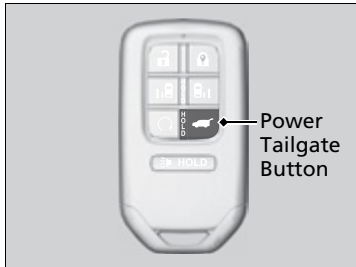

Press the power tailgate button for more than one second to operate when the power mode is in VEHICLE OFF.

- ▶ Some exterior lights flash and the beeper sounds.

If you press the button again while the power tailgate is moving, it will stop. Press the button for more than one second, and the power tailgate will reverse direction.

■ Customizing when to open the tailgate

Anytime: The power tailgate unlocks and opens at the same time. This is the default setting.

When Unlocked: The tailgate opens when all doors are unlocked.

➤ **Customized Features** P. 463

▶▶ Opening/Closing the Power Tailgate*

If you close the power tailgate when all the doors are locked, the power tailgate locks automatically.

If you replace the battery or the power tailgate fuse while the tailgate is open, the power tailgate may be disabled. The power tailgate resumes once you manually close the tailgate.

Installing aftermarket components other than Honda genuine accessories on the power tailgate may prevent it from fully opening or closing.

Make sure the power tailgate is fully open before you get your luggage in and out.

The beeper sounds when you start driving while the power tailgate is still open, or closing.

■ Using the Power Tailgate Button

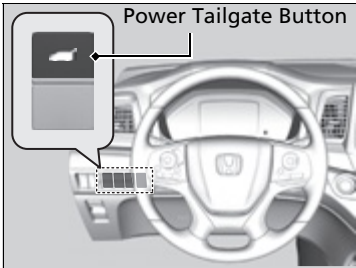

To open or close the power tailgate, press the power tailgate button for about one second.

- Some exterior lights flash and the beeper sounds.

If you press the button again while the power tailgate is moving, it will stop. Press the button for about one second, and the power tailgate will reverse direction.

☒ Opening/Closing the Power Tailgate*

If the power tailgate meets resistance while opening or closing, the auto reverse feature reverses the direction. The beeper sounds three times.

The auto reverse function stops sensing when the tailgate is almost closed to make sure that it fully closes.

Do not touch the sensors located on both sides of the tailgate. The power tailgate does not close if you touch either sensor when you are trying to close the tailgate.

Be careful not to scratch the sensors with a sharp object. If scratched, they can be damaged, and the power tailgate closing feature malfunctions.

* Not available on all models

■ Using the Tailgate Outer Handle

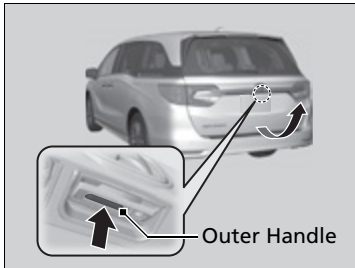

If you press the outer handle of the tailgate for no longer than one second, the tailgate opens automatically.

- The beeper sounds.
- If you want to open the tailgate manually, press the button for more than one second.

► **Opening/Closing the Tailgate** P. 172

If you are carrying the keyless remote, you do not have to unlock the tailgate before opening it.

If you press the outer handle again while the power tailgate is moving, it will stop. Press the outer handle, and the power tailgate will reverse direction.

► Using the Tailgate Outer Handle

Do not leave the keyless remote in the vehicle when you get out. Carry it with you.

Even if you are not carrying the keyless remote, you can lock/unlock the tailgate while someone else with the remote is within range.

Do not leave the keyless remote inside the cargo area and close the tailgate. The beeper sounds and the tailgate cannot be closed.

You can change the setting to open the power tailgate by the tailgate outer handle.

► **Customized Features** P. 463

■ Using the Tailgate Inner Button

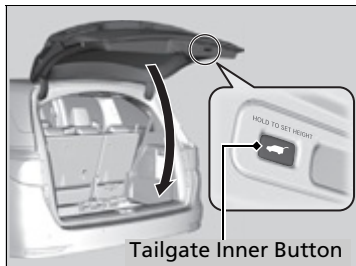

Press the tailgate inner button on the tailgate to close the power tailgate.

▶ The beeper sounds.

If you press the button again while the power tailgate is moving, it will stop.

Press and release the button again, and the power tailgate will reverse direction.

■ Programming Tailgate Position

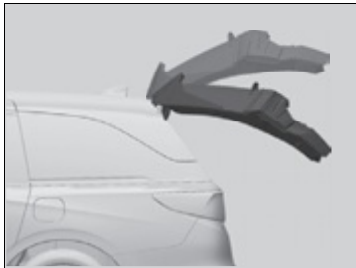

The extent to which the power tailgate automatically opens can be programmed.

To program:

1. Open the tailgate to the desired position.

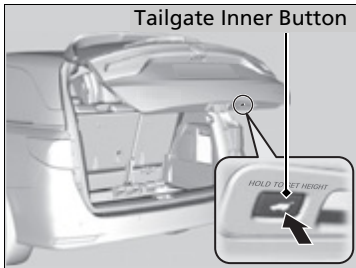

2. Press and hold the tailgate inner button. You will hear one long beep, followed by two short beeps.

▣ Programming Tailgate Position

If the tailgate is only slightly opened, the position cannot be programmed, even if you push the tailgate inner button.

If you want to reprogram the power tailgate to open all the way, manually raise the tailgate to its uppermost position and follow the directions in step 2.

■ Auto-Closer

If you manually close the power tailgate, it latches automatically.

■ Power Tailgate Fall Detection

Automatically lowers the power tailgate when there is a possibility that the fully opened power tailgate can fall down by its own weight (for example, by snow on the tailgate). The beeper sounds while the power tailgate lowers.

ⓘ Auto-Closer

The auto-closer feature does not activate if you press the tailgate outer handle while the power tailgate is closing.

NOTICE

Do not put any force on the tailgate while the power tailgate is latching.

Keep your hands away from the tailgate when you manually close the tailgate and let it latch automatically. It is dangerous to put your hands around the tailgate as it starts to latch itself.

ⓘ Power Tailgate Fall Detection

If you try to manually close the power tailgate immediately after it fully opens, the power tailgate fall detection may activate.

Once the power tailgate fall detection activates, wait until the power tailgate fully closes. Keep away from the power tailgate when it is in motion.

If the power tailgate fall detection constantly activates, consult a dealer.

Precautions for Opening/Closing the Sliding Doors

Always make sure individuals and objects are clear of the sliding doors.

■ Opening the sliding doors

Open the door all the way until it stops.

- ▶ If it is not fully opened, the door may close again by its own weight.

⌘ Precautions for Opening/Closing the Sliding Doors

WARNING

Closing a sliding door while any part of a passenger is in the door's path can cause serious injury.

Make sure all passengers are clear of the doorway before closing a sliding door.

Do not leave the sliding door open while parking on a slope. The door may slide close by its weight.

When opening or closing the sliding doors, do not grab the door or place your hand on the vehicle body. Use the handle.

Do not put your foot and hand on the sliding door rail and on the rollers.

If a small child is in the vehicle, use the childproof door locks to prevent the child in the rear seat from accidentally opening the sliding doors.

 **Childproof Door Locks** P. 169

Do not put any items that stick out from the pocket in the door pockets. It may prevent the doors from properly opening or closing, and damage the vehicle.

Opening/Closing a Sliding Door

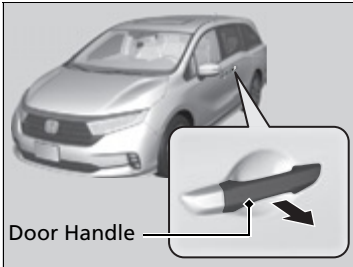

Door Handle

■ From outside

To open: Pull the door handle rearward and slide the door.

To close: Pull the door handle forward and slide the door.

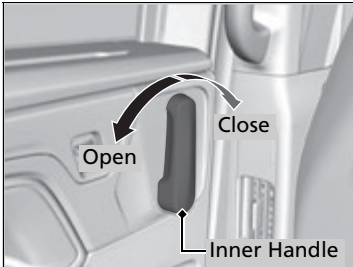

■ From inside

To open: Grab the inner handle and pull it rearward. Slide the door.

To close: Grab the inner handle and pull it forward. Slide the door.

☒ Opening/Closing a Sliding Door

Once a door is fully opened, the door position is locked.

Do not step on the lower arm of the sliding door or the cover that stores the wiring for the sliding door. The lower arm or the wiring will likely be damaged, causing the sliding door to malfunction.

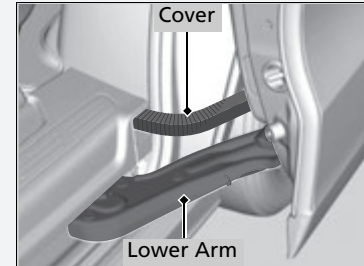

If you try to open the sliding door with the window open more than 5 inch (13 cm), the door stops halfway. Close the door, close the window, and then open the door again.

While the fuel fill door is open, the beeper sounds and you cannot operate the driver's side sliding door. Operate the driver's side sliding door after the fuel fill door is closed.

Opening/Closing the Power Sliding Doors*

The power sliding doors can be operated by pressing the power sliding door button on the keyless remote, pressing the power sliding door switches on the dashboard or door pillars, or using the door handle.

The power sliding doors can be operated when:

- The sliding door main switch is in the **ON** position.
- The power sliding door is unlocked.
- The fuel fill door is closed (on the driver's side sliding door only).
- The power mode is in VEHICLE OFF or the remote engine start mode is active with use of the keyless remote.
- The transmission is in **[P]**, the brake pedal is depressed, or the parking brake is applied (with the power mode in ON) when using the power sliding door switches on the dashboard.

⚠ Opening/Closing the Power Sliding Doors*

If the transmission is in a position other than **[P]**, and release the brake pedal and the parking brake:

While opening – The sliding door stops and is left ajar.

While closing – The beeper sounds until the door closes.

Check that passengers, especially children, do not have their hands on the sliding doors or on the door pillars before its operation. If someone is caught in the opening or closing sliding door, it can cause serious injury.

Before replacing a rear tire, turn the power sliding door main switch to OFF.

Operate the power sliding doors only when the vehicle is at a complete stop. Make sure you apply the brake when rear passengers are boarding or exiting.

Switching between manual and automatic operations

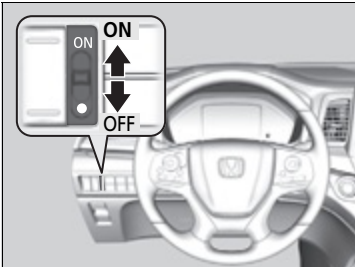

Automatic operation: Select the **ON** position of the sliding door main switch.

Manual operation: Select the OFF position of the sliding door main switch.

📖 **Opening/Closing a Sliding Door** P. 183

⌘ Opening/Closing the Power Sliding Doors*

Do not turn the main switch off while the power sliding door is in operation on a slope. The power sliding door's fail-safe mode activates and the beeper sounds continuously.

When the fail-safe mode is active, turn the main switch on and close the door automatically.

The following can deactivate the fail-safe mode and the sliding door may close by its own weight:





- Using the door handle
- Turning the main switch from **ON** to OFF

If you replace the battery or the power sliding door fuse while the door is open, the power sliding door may be disabled. The power sliding door resumes once you manually close the door.

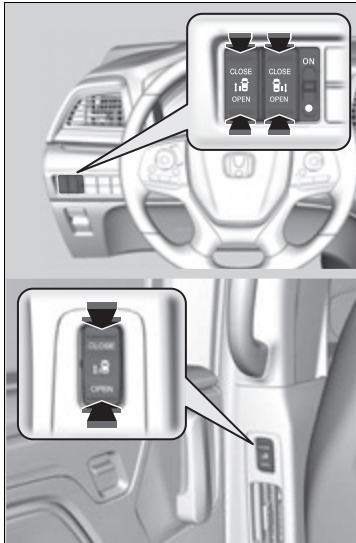
* Not available on all models

■ Power Sliding Door Switches



The power sliding door opens when you press the **OPEN** side of the  /  switch, and closes when you press the **CLOSE** side of the  /  switch.

While the power sliding door is in operation, if you press the switch that corresponds to that power sliding door, the beeper sounds and the operation stops.

To resume the power sliding door operation, press the same switch again.

▶▶ Opening/Closing the Power Sliding Doors*

Auto Reverse

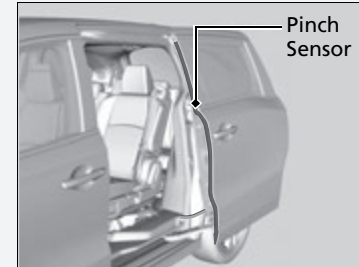

Do not touch the pinch sensor located at the front edge of the power sliding door. Do not damage the sensor. The power sliding door may not operate properly.

If the power sliding door senses resistance when closing automatically, it will stop closing and reverse direction. The beeper sounds.

Before the power sliding door operation, make sure there are no people or obstacles near the door. The auto reverse function should be activated in case of emergency only. If someone is caught in the opening or closing sliding door, it can cause serious injury. Pay special attention to children.

Closing a power sliding door on someone's hand or fingers can cause serious injury. Some parts of the door edge do not sense resistance when the door is near closing.

Remote Transmitter

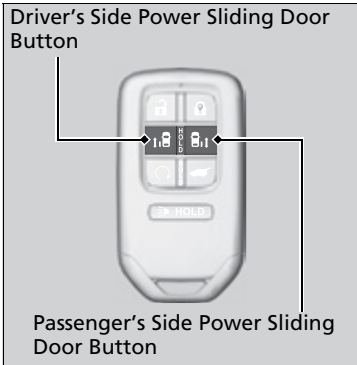

Press the power sliding door button for more than one second to operate.

While the power sliding door is in operation, if you press the button that corresponds to that power sliding door, the beeper sounds and the operation stops.

If you press the same button again, the sliding door reverses its direction.

Customizing when to open the sliding doors

Anytime: The power sliding door unlocks and opens at the same time. This is the default setting.

When Unlocked: The door opens when all doors are unlocked.

➤ **Customized Features** P. 463

Remote Transmitter

When you press the power sliding door button to open the door, the front door on the same side unlocks.

Customizing when to open the sliding doors

In **When Unlocked**, trying to operate the power sliding door without unlocking the door triggers the beeper to sound.

■ Door Handles

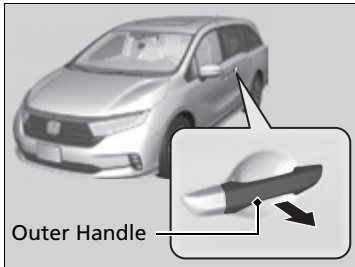

■ Outer handles

Pull the outer handle toward you. The sliding door starts opening or closing.

When the power sliding door is locked, pulling the outer handle unlocks all the doors and tailgate while the keyless remote is in your possession.

The power sliding door handle you pull operates the door automatically.

While a power sliding door is in operation, if you pull its handle, the beeper sounds and the operation stops.

Pull the same handle again, the power sliding door reverses direction.

⌘ Opening/Closing the Power Sliding Doors*

The beeper will sound and the power sliding door will not open if you pull the inner or outer handle under the following conditions:

- The power mode is in ON.
- The transmission is not in **P**.
- The brake pedal is released.
- The parking brake is released.

If you leave the power sliding door half open on a steep hill with the engine off, the door starts to slide down toward the hill bottom after 30 minutes. While the door slides down, the beeper sounds.

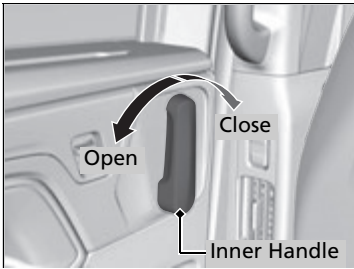

■ Inner handles

Pull it rearward to automatically open the sliding door, and pull it forward to automatically close the door.

While a power sliding door is in operation, if you pull its handle, the beeper sounds and the operation stops.

To resume the power sliding door operation, pull the same handle in the same direction again.

Auto-Closer*

If you manually close the power sliding door, it latches automatically.

The auto-closer feature activates with or without the main switch **ON**.

⚠ Auto-Closer*

Keep your hands away from the power sliding door. The manually closed door latches automatically when it is half-shut.

The auto-closer feature does not activate if you keep pulling the inner or outer handle while the sliding door is closing.

Do not put any force on the power sliding door while the door is latching.

Immobilizer System

This system prevents a key that has not been pre-registered from starting the engine.

Pay attention to the following when pressing the **ENGINE START/STOP** button:

- Do not allow objects that emit strong radio waves near the **ENGINE START/STOP** button.
- Make sure the key is not covered by or touching a metal object.
- Do not bring a key from another vehicle's immobilizer system near the **ENGINE START/STOP** button.
- Do not put the key near magnetic items. Electronic devices, such as televisions and audio systems emit strong magnetic fields. Note that even a key chain can become magnetic.

Security System Alarm

The security system alarm activates when the tailgate, hood, or doors are forcibly opened.

The alarm does not activate if the tailgate or doors are opened with the key, remote transmitter or keyless access system*.

However, the alarm activates if a door is opened with the key, then the hood is opened before the power mode is set to ON.

■ When the security system alarm activates

The horn sounds intermittently, and some exterior lights flash.

Immobilizer System

NOTICE

Leaving the key in the vehicle can result in theft or accidental movement of the vehicle. Always take the key with you whenever you leave the vehicle unattended.

Do not alter the system or add other devices to it. Doing so may damage the system and make your vehicle inoperable.

Canadian models only: Apply and hold the brake pedal before turning the vehicle on the first time after the battery has been disconnected.

Security System Alarm

The security system alarm continues for a maximum of two minutes until the security system alarm deactivates.

* Not available on all models

■ To deactivate the security system alarm

Unlock the vehicle using remote transmitter or keyless access system*, or set the power mode to ON. The system, along with the horn and flashing lights, is deactivated.

■ Setting the security system alarm

The security system alarm automatically sets when the following conditions have been met:

- The power mode is set to VEHICLE OFF.
- The hood is closed.
- All doors and the tailgate are locked from outside with the key, remote transmitter or keyless access system*.

■ When the security system alarm sets

The security system alarm indicator in the instrument panel blinks. When the blinking interval changes after about 15 seconds, the security system alarm is set.

■ To cancel the security system alarm

The security system alarm is canceled when the vehicle is unlocked using the remote transmitter, or keyless access system*, or when the power mode is set to ON. The security system alarm indicator goes off at the same time.

» Security System Alarm

Do not set the security system alarm when someone is in the vehicle or a window is open. The system can accidentally activate when:

- Unlocking the door with the lock tab.
- Opening the hood with the hood release.

Models with power tailgate

- Opening the tailgate with the power tailgate button on the dashboard.

If the battery goes dead after you have set the security system alarm, the security alarm may activate once the battery is recharged or replaced. If this occurs, deactivate the security system alarm by unlocking a door using the remote transmitter or keyless access system*.

Do not alter the system or add other devices to it. Doing so may damage the system and make your vehicle inoperable.

■ Panic Mode

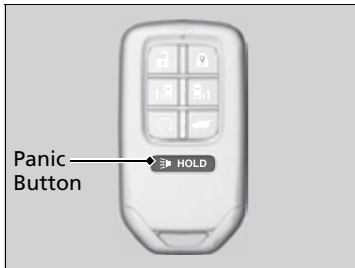

■ The panic button on the remote transmitter

If you press the panic button for approximately one second, the following will occur for about 30 seconds:

- The horn sounds.
- Some exterior lights flash.

■ Canceling panic mode

- Press any button on the remote transmitter.
- Set the power mode to ON.

Opening/Closing the Power Windows

The power windows can be opened and closed when the power mode is in ON, using the switches on the doors. The driver's side switches can be used to open and close all of the windows.

The power window lock button on the driver's side must be switched off (not pushed in, indicator off) to open and close the windows from anywhere other than the driver's seat.

When the power window lock button is pushed in, the indicator comes on and you can only operate the driver's window. Turn the power window lock button on if a child is in the vehicle.

Opening/Closing the Power Windows

WARNING

Closing a power window on someone's hands or fingers can cause serious injury.

Make sure your passengers are away from the windows before closing them.

The power windows can be operated for up to 10 minutes after you set the power mode to VEHICLE OFF. Opening either front door cancels this function.

Auto Reverse

If a power window senses resistance when closing automatically, it will stop closing and reverse direction.

The driver's window auto reverse function is disabled when you continuously pull up the switch.

The auto reverse function stops sensing when the window is almost closed to ensure that it fully closes.

Opening/Closing the Windows with Auto-Open/Close Function

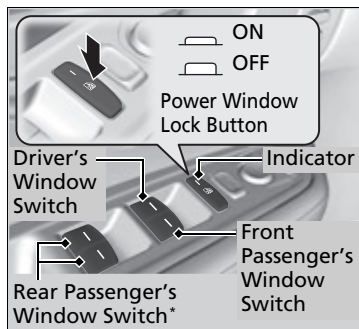

Manual operation

To open: Push the switch down lightly, and hold it until the desired position is reached.

To close: Pull the switch up lightly, and hold it until the desired position is reached.

Automatic operation

To open: Push the switch down firmly.

To close: Pull the switch up firmly.

The window opens or closes completely. To stop the window at any time, push or pull the switch briefly.

■ Opening/Closing Windows without Auto-Open/Close Function*

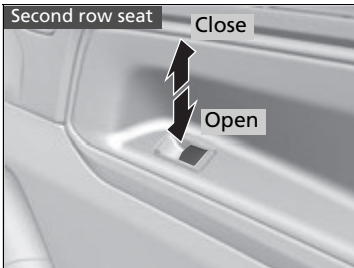

To open: Push the switch down.
To close: Pull the switch up.

Release the switch when the window reaches the desired position.

■ Opening the Windows with the Remote

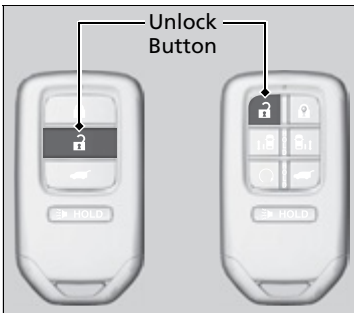

To open: Press the unlock button, and then within 10 seconds, press it again and hold it. If the windows stop midway, repeat the procedure.

☒ Opening/Closing the Power Windows

While driving with any of the windows open, you may hear a booming, throbbing, or helicopter-type noise or pressure. This is called wind buffeting. This is a normal occurrence that can be minimized.

If you hear a wind buffeting noise with any of the windows open, lower all of the other windows slightly or open the moonroof*.

☒ Opening the Windows with the Remote

Models with moonroof

If you open the windows with the remote, the moonroof will open automatically along with them.

* Not available on all models

Continued

■ Opening/Closing the Windows with the Key

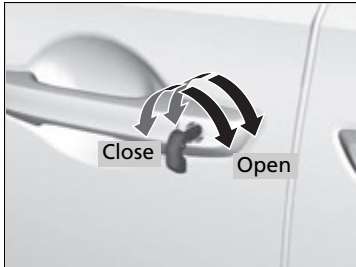

To open: Unlock the driver's door with the key. Within 10 seconds of returning the key to the central position, turn the key in the unlock direction and hold it there.

To close: Lock the driver's door with the key. Within 10 seconds of returning the key to the central position, turn the key in the lock direction and hold it there.

Release the key to stop the windows at the desired position. If you want further adjustment, repeat the same operation.

► Opening/Closing the Windows with the Key

Models with moonroof

If you open/close the windows with the key, the moonroof will open/close automatically along with them.

Opening/Closing the Moonroof

You can only operate the moonroof when the power mode is in ON. Use the switch in the front of the ceiling to open and close the moonroof.

Using the Moonroof Switch

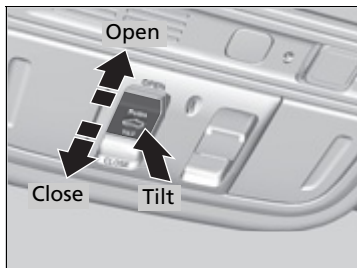

Automatic operation

To open: Pull the switch back firmly.

To close: Push the switch forward firmly.

The moonroof will automatically open or close all the way. To stop the moonroof midway, pull or push the switch briefly.

Manual operation

To open: Pull the switch back lightly, and hold it until the desired position is reached.

To close: Push the switch forward lightly, and hold it until the desired position is reached.

Tilting the moonroof up

To tilt: Push on the center of the moonroof switch.

To close: Push the switch forward firmly, then release.

Opening/Closing the Moonroof

WARNING

Opening or closing the moonroof on someone's hands or fingers can cause serious injury.

Make sure all hands and fingers are clear of the moonroof before opening or closing it.

NOTICE

Opening the moonroof in below freezing temperature or when it is covered with snow or ice can damage the moonroof panel or motor.

The moonroof can be operated for up to 10 minutes after you set the power mode to VEHICLE OFF. Opening either front door cancels this function.

When resistance is detected, the auto reverse function causes the moonroof to change directions, then stop. Auto reverse stops sensing when the moonroof is almost closed to ensure that it fully closes.

You can use the remote transmitter or the key to operate the moonroof.

➤ **Opening the Windows with the Remote**
P. 195

➤ **Opening/Closing the Windows with the Key** P. 196

ENGINE START/STOP Button

■ Changing the Power Mode

VEHICLE OFF (LOCK)
The button is off.
The steering wheel is locked*1.
The power to all electrical components is turned off.

ACCESSORY
The button blinks (in red).
Operate the audio system and other accessories in this position.

ON
The button blinks (in red).
All electrical components can be used.

Without pressing the brake pedal

➔ Press the button without the gear position in **P**.

➔ Change to **P** then press the button.

➔ Press the button.

➔ **U.S. models**
Change to **P**.

*1:Canadian models

⌘ENGINE START/STOP Button

ENGINE START/STOP Button Operating Range

You can start the engine when the keyless remote is inside the vehicle.

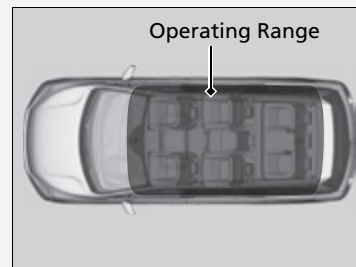

The engine may also run if the keyless remote is close to the door or window, even if it is outside the vehicle.

ON mode:

The **ENGINE START/STOP** button is red when the engine is running.

If the battery of the keyless remote is getting low, the engine may not start when you press the **ENGINE START/STOP** button. If the engine does not start, refer to the following link.

➔ **If the Remote Battery is Weak** P. 733

Automatic Power Off

If you leave the vehicle for 30 to 60 minutes with the transmission in **P** and the power mode in ACCESSORY, the vehicle automatically goes into the mode similar to VEHICLE OFF (LOCK) to avoid draining the battery.

Canadian models

When in this mode:

The steering wheel does not lock.

You cannot lock or unlock doors with the remote transmitter or the keyless access system.

Press the **ENGINE START/STOP** button to switch the mode to VEHICLE OFF (LOCK).

ENGINE START/STOP Button

Canadian models

If the power mode does not change from VEHICLE OFF to ACCESSORY, press the **ENGINE START/STOP** button while moving the steering wheel left and right. The steering wheel will unlock, allowing the mode to change.

Do not leave the power mode in ACCESSORY or ON when you get out.

■ Power Mode Reminder

If you open the driver's door when the power mode is set to ACCESSORY, a warning beep sounds.

■ Keyless Remote Reminder

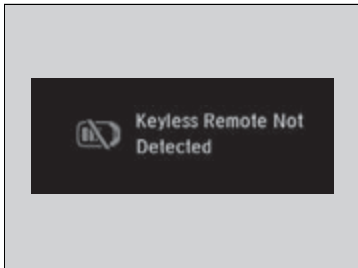

When the power mode is set to any mode other than OFF and you remove the keyless remote from the vehicle and shut the door, an alarm will sound. If the alarm continues to sound, place the keyless remote in another location.

■ When the power mode is in ACCESSORY

The alarm will sound from outside the vehicle.

■ When the power mode is in ON

An alarm will sound both inside and outside the vehicle. In addition, a warning indicator will appear on the instrument panel.

⊗ Keyless Remote Reminder

When the keyless remote is within the system's operational range, and all the doors are closed, the warning function cancels.

If the keyless remote is taken out of the vehicle after the engine has been started, you can no longer change the **ENGINE START/STOP** button mode or restart the engine. Always make sure if the keyless remote is in your vehicle when you operate the **ENGINE START/STOP** button.

Removing the keyless remote from the vehicle through a window does not activate the warning buzzer.

Do not put the keyless remote on the dashboard or in the glove box. It may cause the warning buzzer to activate. Under some other conditions that can prevent the vehicle from locating the keyless remote, the warning buzzer may also activate even if the remote is within the system's operational range.

Turn Signals

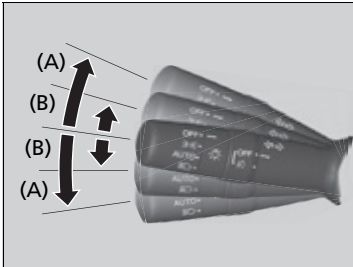

The turn signals can be used when the power mode is in ON.

■ (A): Turn signal

Push the lever up or down based on the direction you want to turn, and the turn signal will blink.

■ (B): One-touch turn signal

When you lightly push the lever up or down and release it, the turn signal will blink 3 times.

☒ Turn Signals

The turn signal indicator on the instrument panel will blink when the external turn signal blinks.

☒ **Indicators** P. 88

Light Switches

Manual Operation

Models without default AUTO position switch

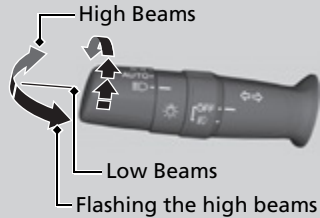

Models with default AUTO position switch

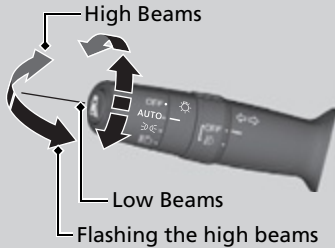

- Turns on parking, side marker, tail, and rear license plate lights
- Turns on headlights, parking, side marker, tail, and rear license plate lights

Rotating the light switch turns the lights on and off, regardless of the power mode setting.

High beams

Push the lever forward until you hear a click.

Low beams

When in high beams, pull the lever back to return to low beams.

Flashing the high beams

Pull the lever back, and release it.

Models with default AUTO position switch

Lights off

Rotate the switch to **OFF** either when:

- The transmission is in **P**.
- The parking brake is applied.

To turn the lights on again, rotate the switch to **OFF** to cancel the lights off mode. Even if you do not cancel the lights off mode, the lights come on automatically when:

- The transmission is taken out of **P** and the parking brake is released.
- The vehicle starts to move.

Light Switches

If you leave the power mode in VEHICLE OFF with the lights on, a chime sounds when the driver's door is opened.

When the lights are on, the lights on indicator in the instrument panel will be on.

Lights On Indicator P. 98

Do not leave the lights on when the engine is off because it will cause the battery to discharge.

If you sense that the level of the headlights is abnormal, have the vehicle inspected by a dealer.

Automatic Operation (automatic lighting control)

Models without default AUTO position switch



Models with default AUTO position switch



Automatic lighting control can be used when the power mode is in ON.

Models without default AUTO position switch

When you turn the light switch to **AUTO**, the headlights and other exterior lights will switch on and off automatically depending on the ambient brightness.

Models with default AUTO position switch

When the light switch is in **AUTO**, the headlights and other exterior lights will switch on and off automatically depending on the ambient brightness.

The headlights come on when you unlock a door in dark areas with the headlight switch in **AUTO**.

- ▶ Once you lock the door, the headlights will go off.

Automatic Operation (automatic lighting control)

We recommend that you turn on the lights manually when driving at night, in a dense fog, or in dark areas such as long tunnels or parking facilities.

The light sensor is in the location shown below. Do not cover this light sensor with anything; otherwise, the automatic lighting system may not work properly.

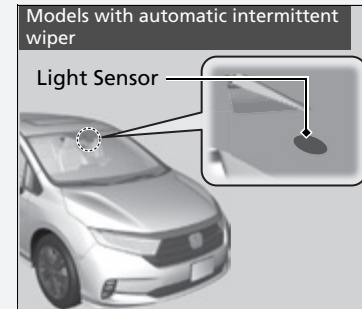
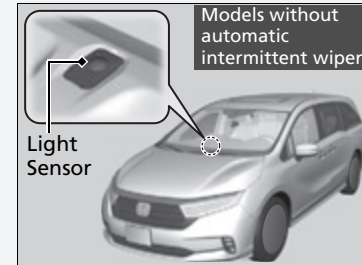

■ Headlight Integration with Wiper

The headlights automatically come on when the wipers are used several times within a certain number of intervals with the headlight switch in **AUTO**.

The headlights automatically go off a few minutes later if the wipers are stopped.

■ Automatic Lighting Off Feature

The headlights, all other exterior lights, and the instrument panel lights turn off 15 seconds after you set the power mode to VEHICLE OFF, take the remote with you, and close the driver's door.

If you set the power mode to VEHICLE OFF with the headlight switch on, but do not open the door, the lights turn off after 10 minutes (3 minutes, if the switch is in the **AUTO** position).

The lights turn on again when you unlock or open the driver's door. If you unlock the door, but do not open it within 15 seconds, the lights go off. If you open the driver's door, you will hear a reminder chime alerting you that the lights are on.

⌘ Automatic Operation (automatic lighting control)

U.S. models

You can adjust the auto light sensitivity as follows:

Setting	The exterior lights come on when the ambient light is at
MAX	
HIGH	
MID	
LOW	
MIN	

➔ **Customized Features** P. 463

⌘ Headlight Integration with Wiper

This feature activates when **AUTO** mode is selected and the headlights are off.

The instrument panel brightness does not change when the headlights come on.

At dark ambient light levels, the automatic lighting control feature turns on the headlights, regardless of the number of wiper sweeps.

⌘ Automatic Lighting Off Feature

You can change the headlight auto off timer setting.

Models with color audio system

➔ **Vehicle Customization** P. 143

Models with Display Audio

➔ **Customized Features** P. 463

Fog Lights*

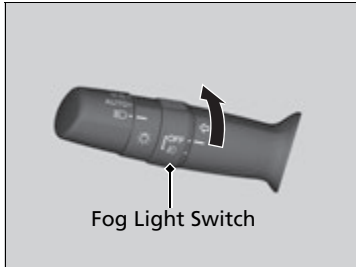

When the low beam headlights are on, turn the fog light switch on to use the fog lights.

* Not available on all models

Daytime Running Lights

When the conditions listed below are met, the daytime running lights come on:

- The power mode is in ON.
- The headlight switch is off.
- The parking brake is released.

The lights remain on even if you set the parking brake. Setting the power mode to VEHICLE OFF will turn off the daytime running lights.

The daytime running lights go off once the headlight switch is turned on, or when the headlight switch is in **AUTO** and it is getting dark outside.

Auto High-Beam

The front sensor camera detects the light sources ahead of the vehicle such as the lights of a preceding or oncoming vehicle, or street lights. When you are driving at night, the system automatically switches the headlights between low beam and high beam depending on the situation.

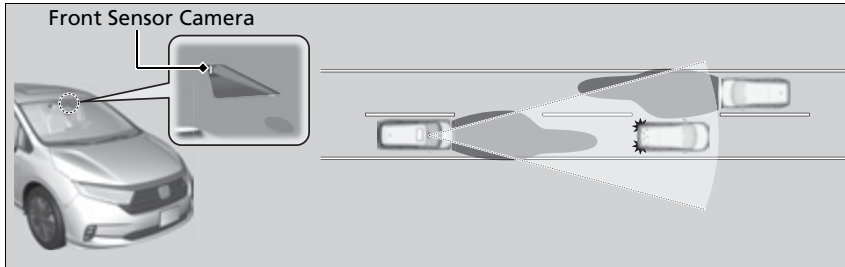

How to Use the Auto High-Beam

When all of the following conditions have been met, the auto high-beam indicator comes on and the auto high-beam is activated.

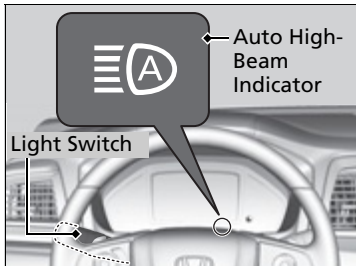

- The power mode is in ON.
- The light switch is in **AUTO**.
- The lever is in the low beam position.
- The headlights have been automatically activated.
- It is dark outside the vehicle.

If the auto high-beam indicator does not come on even when all the conditions have been met, carry out the following procedure and the indicator will come on.

- Pull the lever toward you for flashing the high beams then release it while driving.

Continued

Auto High-Beam

The auto high-beam system does not always operate in every situation. This system is just for assisting the driver. Always observe your surroundings and switch the headlights between high beam and low beam manually if necessary.

If you find the timing of beam changes inconvenient for driving, change the headlight beams manually.

The range and the distance at which the camera can recognize varies depending on conditions surrounding your vehicle.

Regarding the handling of the camera mounted to the inside of the windshield, refer to the following.

Front Sensor Camera P. 635

For the auto high-beam to work properly:

- Do not place an object that reflects light on the dashboard.
- Keep the windshield around the camera clean. When cleaning the windshield, be careful not to apply the windshield cleanser to the camera lens.
- Do not attach an object, sticker or film to the area around the camera.
- Do not touch the camera lens.

If the camera receives a strong impact, or repairing of the area near the camera is required, consult a dealer.

■ Automatic switching between high-beam and low-beam

When auto-high beam is active, the headlights switch between high beam and low beam based on the following conditions.

Switching to high beam:

All of the following conditions must be met before the high beams turn on.

- Your vehicle speed is 25 mph (40 km/h) or more.
- There are no preceding or oncoming vehicle with headlights or taillights turned on.
- There are few street lights on the road ahead.



Switching to low beam:

One of the following conditions must be met before the low beams turn on.

- Your vehicle speed is 15 mph (24 km/h) or less.
- There is a preceding or oncoming vehicle with headlights or taillights turned on.
- There are many street lights on the road ahead.

■ Manual switching between high-beam and low-beam

If you want to manually switch the headlights between high beam and low beam, follow either of the procedures below. Note that when you do this, the auto high-beam indicator will turn off and the auto high-beam will be deactivated.

Using the lever:

Pull the lever toward you for flashing the high beams then release it within about one second while driving.

- ▶ To reactivate the auto high-beam, pull the lever toward you for flashing the high beams then release it while driving. The auto high-beam indicator will come on.

Using the light switch:

Turn the light switch to .

- ▶ To reactivate the auto high-beam, turn the light switch to **AUTO** when the lever is in the low beam position, the auto high-beam indicator will come on.

📖 How to Use the Auto High-Beam

In the following cases, the auto high-beam system may not switch the headlights properly or the switching timing may be changed. In case of the automatic switching operation does not fit for your driving habits, please switch the headlights manually.

- The brightness of the lights from the preceding or oncoming vehicle is intense or poor.
- Visibility is poor due to the weather (rain, snow, fog, windshield frost, etc.).
- Surrounding light sources, such as street lights, electric billboards and traffic lights are illuminating the road ahead.
- The brightness level of the road ahead constantly changes.
- The road is bumpy or has many curves.
- A vehicle suddenly appears in front of you, or a vehicle in front of you is not in the preceding or oncoming direction.
- Your vehicle is tilted with a heavy load in the rear.
- A traffic sign, mirror, or other reflective object ahead is reflecting strong light toward the vehicle.
- The oncoming vehicle frequently disappears under roadside trees or behind median barriers.
- The preceding or oncoming vehicle is a motorcycle, bicycle, mobility scooter, or other small vehicle.

The auto high-beam system keeps the headlight low beam when:

- Windshield wipers are operating at a high speed.
- The camera has detected dense fog.

■ How to Turn Off the Auto High-Beam

You can turn the auto high-beam system off. If you want to turn the system off or on, set the power mode to ON, then carry out the following procedures while the vehicle is stationary.

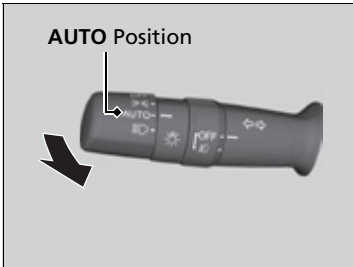

To turn the system off:

With the light switch is in **AUTO**, pull the lever toward you and hold it for at least 40 seconds. After the auto high-beam indicator light blinks twice, release the lever.

To turn the system on:

With the light switch is in **AUTO**, pull the lever toward you and hold it for at least 30 seconds. After the auto high-beam indicator light blinks once, release the lever.

☒ How to Use the Auto High-Beam

If the **Some Driver Assist Systems Cannot Operate: Camera Temperature Too High** message appears:

- Use the climate control system to cool down the interior and, if necessary, also use defroster mode with the airflow directed toward the camera.
- Start driving the vehicle to lower the windshield temperature, which cools down the area around the camera.

If the **Some Driver Assist Systems Cannot Operate: Clean Front Windshield** message appears:

- Park your vehicle in a safe place, and clean the windshield. If the message does not disappear after you have cleaned the windshield and driven for a while, have your vehicle checked by a dealer.

☒ How to Turn Off the Auto High-Beam

If you turn the auto high-beam system off, the system does not operate until you turn the system on.

Park in a safe place before turning the system off or on.

Wipers and Washers

■ Windshield Wiper/Washer

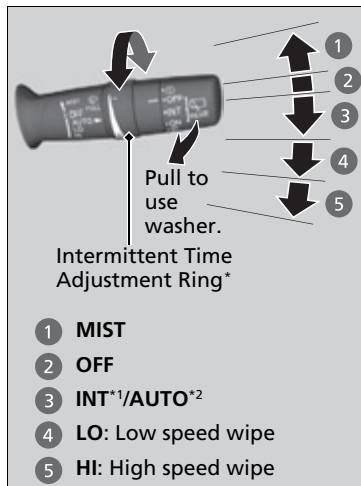

The windshield wipers and washers can be used when the power mode is in ON.

■ MIST

The wipers run at high speed until you release the lever.

■ Wiper switch (OFF, INT*1/AUTO*2, LO, HI)

Move the lever up or down to change the wiper settings.

■ Adjusting wiper operation*

Turn the adjustment ring to adjust wiper operation.

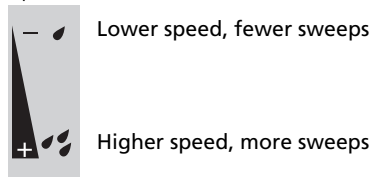

■ Washer

Sprays while you pull the lever toward you. When you release the lever for more than one second, the spray stops, the wipers sweep two or three more times to clear the windshield, then stop.

*1: Models with manual intermittent operation

*2: Models with automatic intermittent operation

* Not available on all models

» Wipers and Washers

NOTICE

Do not use the wipers when the windshield is dry. The windshield will get scratched, or the rubber blades will get damaged.

NOTICE

In cold weather, the blades may freeze to the windshield. Operating the wipers in this condition may damage the wipers. Use the defroster or heated windshield* to warm the windshield, then turn the wipers on.

Models with intermittent time adjustment ring

If the vehicle speeds up while the wipers are operating intermittently, the length of the wipe interval shortens.

When the vehicle speeds up, the wiper operation's shortest delay setting (👉) and the **LO** setting become the same.

NOTICE

Turn the washers off if no washer fluid comes out. The pump may get damaged.

■ Automatic Intermittent Wipers*

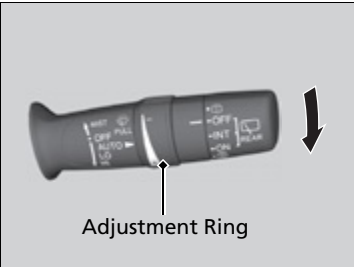

When you push the lever down to **AUTO**, the windshield wipers sweep once, and go into the automatic mode.

The wipers operate intermittently, at low speed, or at high speed and stops in accordance with the amount of rainfall the rainfall sensor detects.

■ AUTO sensitivity adjustment

When the wiper function is set to **AUTO**, you can adjust the sensitivity of the rainfall sensor (using the adjustment ring) so that wipers will operate in accordance with your preference.

Sensor sensitivity

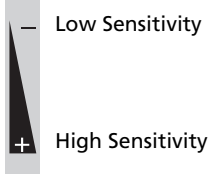

⌘ Wipers and Washers

If the wipers stop operating due to any obstacle such as the build-up of snow, park the vehicle in a safe place. Rotate the wiper switch to OFF, and set the power mode to ACCESSORY or VEHICLE OFF, then remove the obstacle.

The wiper motor may stop motor operation temporarily to prevent an overload. Wiper operation will return to normal within a few minutes, once the circuit has returned to normal.

⌘ Automatic Intermittent Wipers*

The rainfall sensor is in the location shown below.

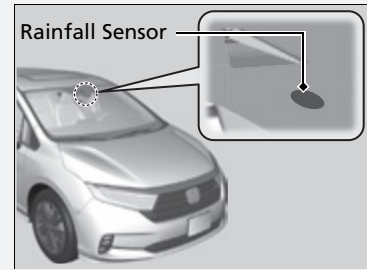

NOTICE

AUTO should always be turned **OFF** before the following situation in order to prevent severe damage to the wiper system:

- Cleaning the windshield
- Driving through a car wash
- No rain present

* Not available on all models

Continued

■ Rear Wiper/Washer

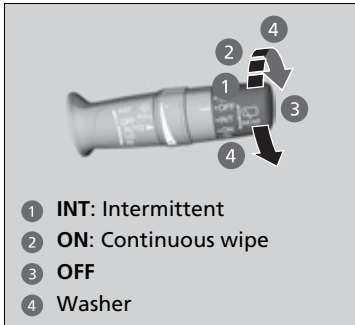

The rear wiper and washer can be used when the power mode is in ON.

■ Wiper switch (OFF, INT, ON)

Change the wiper switch setting according to the amount of rain.

■ Washer ()

Sprays while you rotate the switch to this position.

Hold it to activate the wiper and to spray the washer. Once released, the washer spray will stop and the rear wiper will return to its selected switch setting after a few sweeps.

■ Operating in reverse

When you put the transmission into **R** with the windshield wiper activated, the rear wiper operates automatically as follows even if its switch is off.

Front Wiper Position	Rear Wiper Operation
INT *1 (Intermittent)	Intermittent
AUTO *2 (Intermittent)	
LO (Low speed wipe)	Continuous
HI (High speed wipe)	

*1: Models with manual intermittent operation

*2: Models with automatic intermittent operation

Rear Defogger/Heated Door Mirror* Button

Models with tri-zone climate control system

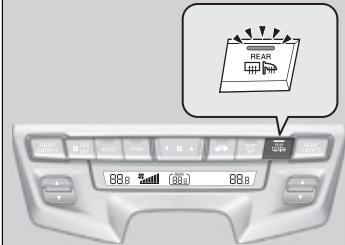

Models with dual-zone climate control system

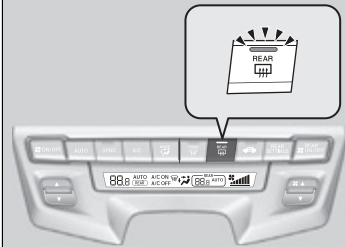

Press the rear defogger and heated door mirror* button to defog the rear window and mirrors* when the power mode is in ON.

The rear defogger and heated door mirrors* automatically switch off after 10-30 minutes depending on the outside temperature.

However, if the outside temperature is 32°F (0°C) or below, they do not automatically switch off.

⌘ Rear Defogger/Heated Door Mirror* Button

This system consumes a lot of power, so turn it off when the window has been defogged. Also, do not use the system for a long time while the engine is idling. This may weaken the battery, making it difficult to start the engine.

Models with heated door mirror button

When the power mode is set to ON and the outside temperature is below 41°F (5°C), the heated door mirror may automatically activate for 10 minutes.

* Not available on all models

Canadian models

Heated Windshield Button

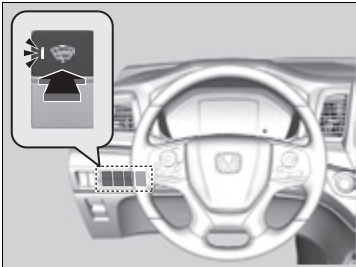

Press the heated windshield button to deice the windshield when the power mode is in ON.

▶▶ Heated Windshield Button

This system consumes a lot of power, so turn it off when the window has been deiced. Also, do not use the system for a long period when the engine is idling. This may weaken the battery, making it difficult to start the engine.

When the outside temperature is below 39°F (4°C), the heated windshield may automatically activate. The system deactivates itself once the outside temperature reaches 43°F (6°C).

Brightness Control

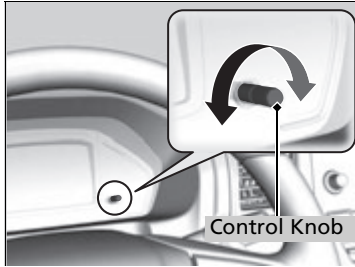

When the power mode is in ON, you can use the brightness control knob to adjust instrument panel brightness.

Brighten: Turn the knob to the right.

Dim: Turn the knob to the left.

You will hear a beeper when the brightness reaches minimum or maximum. Several seconds after you have adjusted the brightness, you will be returned to the previous screen.

■ Brightness level indicator

The brightness level is shown on the driver information interface while you are adjusting it.



☒ Brightness Control

The brightness of the instrument panel will be reduced when the following conditions have been met:

- The power mode is in ON.
- The parking lights are turned on.
- The ambient lighting is low.

The brightness can be set differently for when the exterior lights are on, and when they are off.

Driving Position Memory System*

You can store two driver's seat positions (except for power lumbar) and outside mirror positions with the driving position memory system.

When you unlock and open the driver's door with a remote, the seat and outside mirrors adjust automatically to one of the two preset positions.

When you enter the vehicle, the driver information interface briefly shows you which remote transmitter you used to unlock the vehicle.

- **DRIVER 1** transmitter is linked to memory button 1.
- **DRIVER 2** transmitter is linked to memory button 2.



The driver's seat moves rearward depending on the set seating position once you

- Stop the vehicle.
- Put the transmission in **P**.
- Set the power mode to VEHICLE OFF.
- Open the driver's door.

Once the power mode is in the ACCESSORY position, the driver's seat moves to the **DRIVER 1** or **2** preset position.

▶▶ Driving Position Memory System*

Using the audio/information screen, you can disable the automatic seat and door mirrors adjustment function.

▶ Customized Features P. 463

The driver's seat easy exit feature:

- Will move rearward to allow you to more easily exit the vehicle.
- Can be turned on or off.

▶ Customized Features P. 463

System Operation

The system will not operate if:

- The vehicle speed is above 2 mph (3 km/h).
- Either memory button is pressed while the seat is in motion.
- The seat position is adjusted while in operation.
- The memory 1 or 2 position is set fully to the rear.

■ Storing a Position in Memory

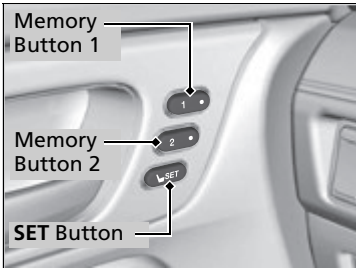

1. Set the power mode to ON. Adjust the driver's seat and the door mirrors to the desired position.
2. Press the **SET** button.
 - ▶ You will hear the beep, and the memory button indicator light will blink.
3. Press and hold memory button **1** or **2** within five seconds of pressing the **SET** button.
 - ▶ Once the seat and the outside mirrors position has been memorized, the indicator light on the button you pressed stays on.

☒ Storing a Position in Memory

After you press the **SET** button, the storing operation will be canceled when:

- You do not press the memory button within five seconds.
- You readjust the seat and door mirrors position before the double-beep.
- You set the power mode to any position except ON.

■ Recalling the Stored Position

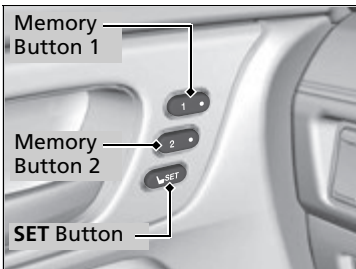

1. Put the transmission into **P**.
2. Apply the parking brake.
3. Press a memory button (**1** or **2**).
 - ▶ You will hear the beeper, and the indicator light will blink.

The seat and the door mirrors will automatically move to the memorized position. When it has finished moving, you will hear the beep, and the indicator light stays on.

☒ Recalling the Stored Position

The seat and the door mirrors will stop moving if you:

- Press the **SET** button or memory button **1** or **2**.
- Adjust the seat position or door mirrors.
- Put the transmission into a position other than **P**.

Adjusting the Steering Wheel

The steering wheel height and distance from your body can be adjusted so that you can comfortably grip the steering wheel in an appropriate driving posture.

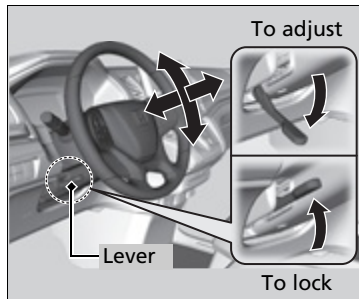

1. Push the steering wheel adjustment lever down.
 - ▶ The steering wheel adjustment lever is under the steering column.
2. Move the steering wheel up or down, and in or out.
 - ▶ Make sure you can see the instrument panel gauges and indicators.
3. Pull the steering wheel adjustment lever up to lock the steering wheel in position.
 - ▶ After adjusting the position, make sure you have securely locked the steering wheel in place by trying to move it up, down, in, and out.

Adjusting the Steering Wheel

WARNING

Adjusting the steering wheel position while driving may cause you to lose control of the vehicle and be seriously injured in a crash.

Adjust the steering wheel only when the vehicle is stopped.

Interior Rearview Mirror

Adjust the angle of the rearview mirror when you are sitting in the correct driving position.

Rearview Mirror with Day and Night Positions*

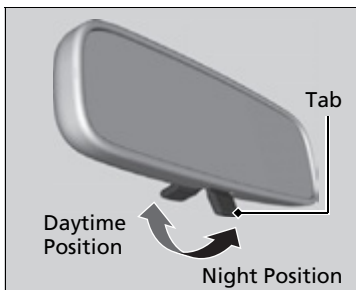

Flip the tab to switch the position. The night position will help to reduce the glare from headlights behind you when driving after dark.

Automatic Dimming Rearview Mirror* and Power Door Mirrors*

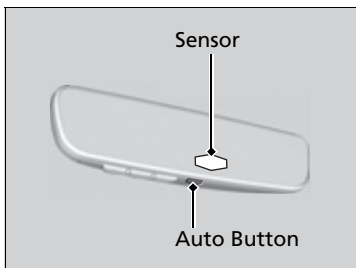

When you are driving after dark, the automatic dimming rearview mirror and power door mirrors* reduces the glare from headlights behind you. Press the auto button to turn this function on and off. When activated, the auto indicator comes on.

Mirrors

Keep the inside and outside mirrors clean and adjusted for best visibility.

Adjust the mirrors before you start driving.

➤ **Front Seats** P. 222

Automatic Dimming Rearview Mirror* and Power Door Mirrors*

The auto dimming function cancels when the transmission is in **R**.

* Not available on all models

Power Door Mirrors

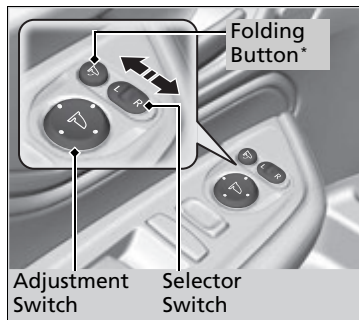

You can adjust the door mirrors when the power mode is in ON.

■ Mirror position adjustment

L/R selector switch: Select the left or right mirror. After adjusting the mirror, return the switch to the center position.

Mirror position adjustment switch: Press the switch left, right, up, or down to move the mirror.

■ Folding door mirrors*

Press the folding button to fold in and out the door mirrors.

Reverse Tilt Door Mirror*

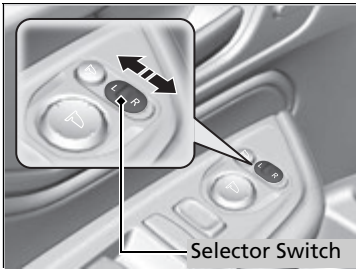

If activated, either side door mirror automatically tilts downward when you put the transmission into **R**; this improves close-in visibility on the selected side of the vehicle when backing up. The mirror automatically returns to its original position when you take the transmission out of **R**.

To activate this feature, set the power mode to ON and slide the selector switch to the left or right side.

Front Seats

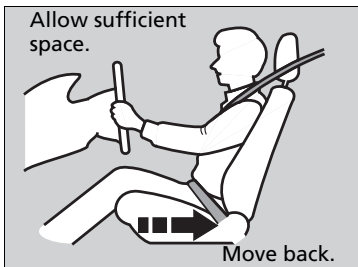

Adjust the driver's seat as far back as possible while allowing you to maintain full control of the vehicle. You should be able to sit upright, well back in the seat and be able to adequately press the pedals without leaning forward, and grip the steering wheel comfortably. The passenger's seat should be adjusted in a similar manner, so that it is as far back from the front airbag in the dashboard as possible.

Seats

Always make seat adjustments before driving.

Front Seats

WARNING

Sitting too close to a front airbag can result in serious injury or death if the front airbags inflate.

Always sit as far back from the front airbags as possible while maintaining control of the vehicle.

The National Highway Traffic Safety Administration and Transport Canada recommend that drivers allow at least 10 inches (25 cm) between the center of the steering wheel and the chest.

Adjusting the Seat Positions

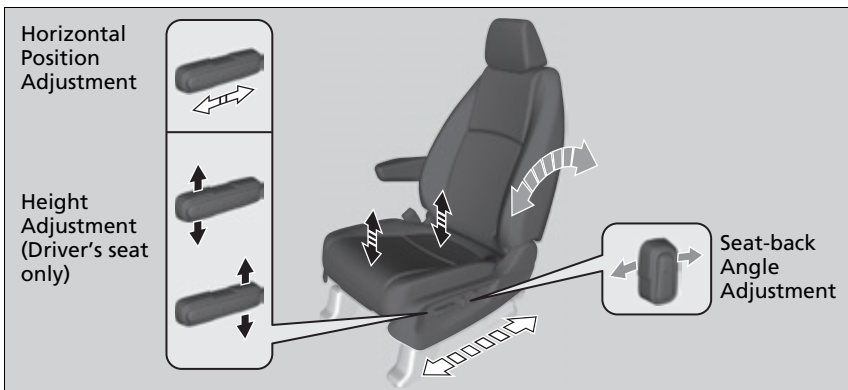

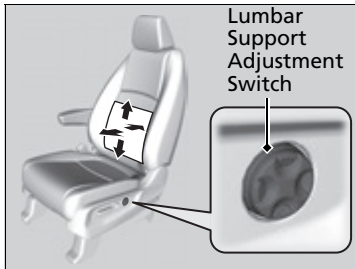

■ Lumbar Support Adjustment Switch*

Press the top: To move the lumbar support up.

Press the bottom: To move the lumbar support down.

Press the front: To increase the entire lumbar support.

Press the rear: To decrease the entire lumbar support.

* Not available on all models

■ Adjusting the Seat-Backs

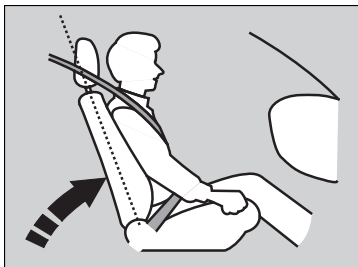

Adjust the driver's seat-back to a comfortable, upright position, leaving ample space between your chest and the airbag cover in the center of the steering wheel.

The front seat passenger should also adjust their seat-back to a comfortable, upright position.

Reclining a seat-back so that the shoulder part of the belt no longer rests against the occupant's chest reduces the protective capability of the belt. It also increases the chance of sliding under the belt in a crash and being seriously injured. The farther a seat-back is reclined, the greater the risk of injury.

► Adjusting the Seat-Backs

⚠ WARNING

Reclining the seat-back too far can result in serious injury or death in a crash.

Adjust the seat-back to an upright position, and sit well back in the seat.

Do not put a cushion, or other object, between the seat-back and your back.

Doing so may interfere with proper seat belt or airbag operation.

If you cannot get far enough away from the steering wheel and still reach the controls, we recommend that you investigate whether some type of adaptive equipment may help.

Second Row Seats

Adjusting the Seat Positions

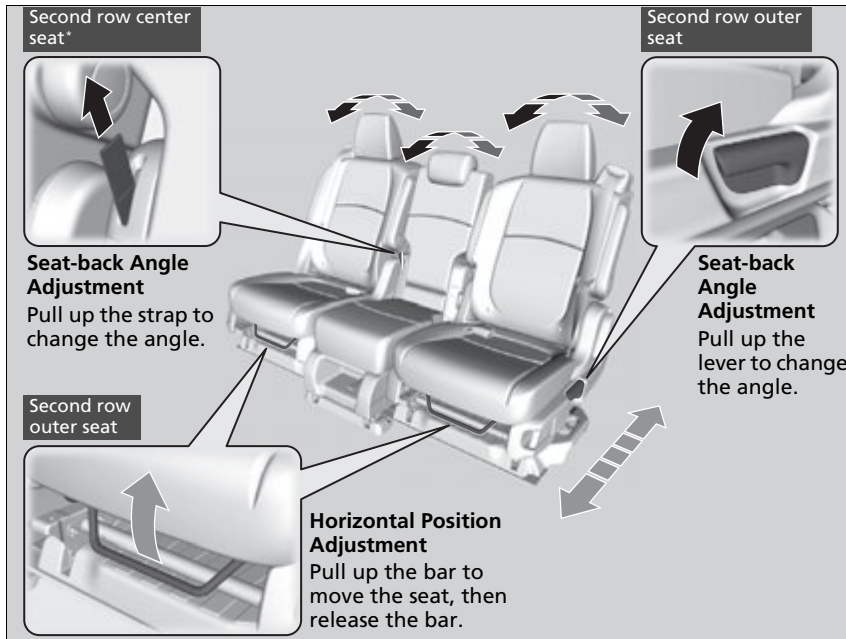

* Not available on all models

Continued

Second Row Seats

⚠ WARNING

An unsecured seat or seat-back can move out of position or collapse without warning if there is sudden acceleration or stop or in a crash.

A seat or seat-back that suddenly moves or collapses can result in severe injury or death.

Always make sure all seats and seat-backs are securely locked into position before driving.

Adjusting the Seat Positions

Once the desired seat position and seat-back angles are made, rock the seat-back and forth to make sure they are locked into position.



■ Folding Down the Second Row Outer Seat

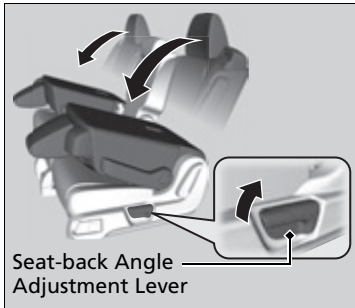

1. Pull up the armrest(s).
2. Lower the head restraint to its lowest position.
3. Move the seat to its rearmost position.
4. Pull the seat-back angle adjustment lever, then fold the seat-back down.

To return the seat to the original position, pull up the seat-back angle adjustment lever and fold the seat-back in the upright position.

■ Third Row Seat Access

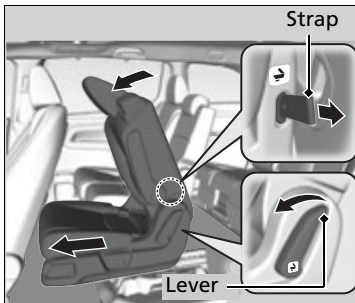

1. Pulling forward on the walk-in lever or pulling the release strap tilts the second row outer seat's seat-back forward.
 - The whole seat slides forward.
2. When re-positioning the seat, push it firmly to the rear to ensure the horizontal adjusters and the seat-back lock completely into place.

► Folding Down the Second Row Outer Seat

Make sure that the folded seat-back does not press against the front passenger's seat, as this can cause the weight sensors in the front passenger's seat to work improperly.

► **Passenger Airbag Off Indicator** P. 64

The front seat(s) must be far enough forward so they do not interfere with the second row seats as they fold down.

Make sure the seat-back and seat cushion are securely latched back into place before driving.

■ Removing the Second Row Center Seat*

Your vehicle's multi-functional second row center seat is removable.

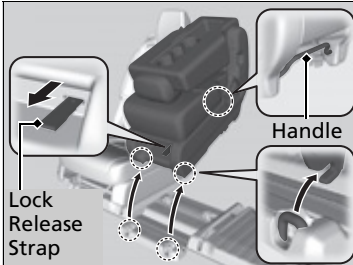

1. Store the center seat belt first. Insert the latch plate into the slot on the side of the anchor buckle.
2. Retract the seat belt into the holder on the ceiling.
 - **Seat Belt with Detachable Anchor** P. 45
3. Pull up the strap and fold down the second row center seat-back.
4. Pull the lock release strap under the seat cushion, and lift the rear of the seat.
 - To lift the seat, grab the handle under the rear side of the seat cushion.
5. Pull the seat-back slightly, then pivot it upward.
 - This unhooks the front of the seat from the floor.

▣ Removing the Second Row Center Seat*

Do not remove the seat while driving.

The multi-functional center seat can be used as the beverage holder when folded down.

► **Beverage Holders** P. 244

To reinstall the seat, hook the front of the seat to the floor first. After confirming both the front hooks are fully inserted into the front strikers, begin to lower the seat, then allow it to drop and lock to the rear floor strikers. Raise the seat-back to an upright position, then rock the seat-back and forth to confirm both the rear latches are securely locked into position.

* Not available on all models

■ Removing a Second Row Outer Seat

Your vehicle's second row outer seats are removable.

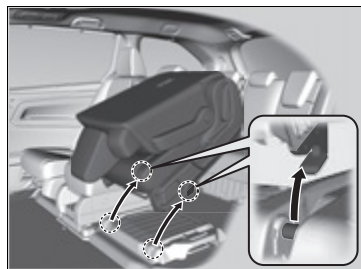
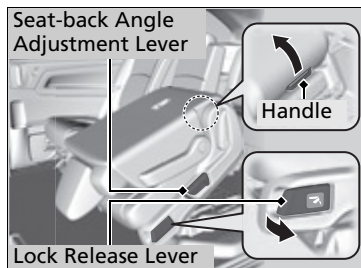

1. Lower the head restraint to its lowest position.
2. Move the seat to its rearmost position.
3. Pull the seat-back angle adjustment lever, then fold the seat-back down.
4. Pull the lock release lever, tilt the seat-back forward and lift the rear of the seat.
 - To lift the seat, grab the handle under the rear side of the seat.
5. Pivot the rear of the seat upward to unhook the front of the seat from the floor.

▣ Removing a Second Row Outer Seat

Do not remove the seat while driving.

Reinstalling a Second Row Outer Seat

With the seat-back folded forward, insert the front seat hooks into the front floor strikers.

After confirming both front hooks are fully inserted into the front strikers, begin to lower the seat, then allow it to drop and lock to the rear floor strikers.

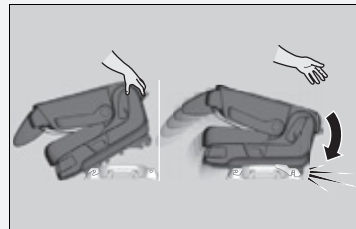

Raise the seat-back to an upright position, then rock the seat-back and forth to confirm both the inner and outer latches are securely locked into position.

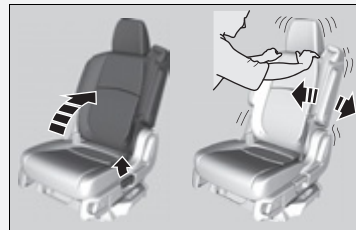

■ Magic Slide® 2nd-Row Seats*

Your vehicle's second row outer seats are slidable.



1. Remove the second row center seat.

➤ **Removing the Second Row Center Seat*** P. 227

2. Pull up the handle at the side of the second row outer seat, then slide the seat.

▣ Magic Slide® 2nd-Row Seats*

When the second row outer seats are in slide (center) position, passengers have easier access to the third row seats.

* Not available on all models

Third Row Seats

■ Adjusting the Seat Positions

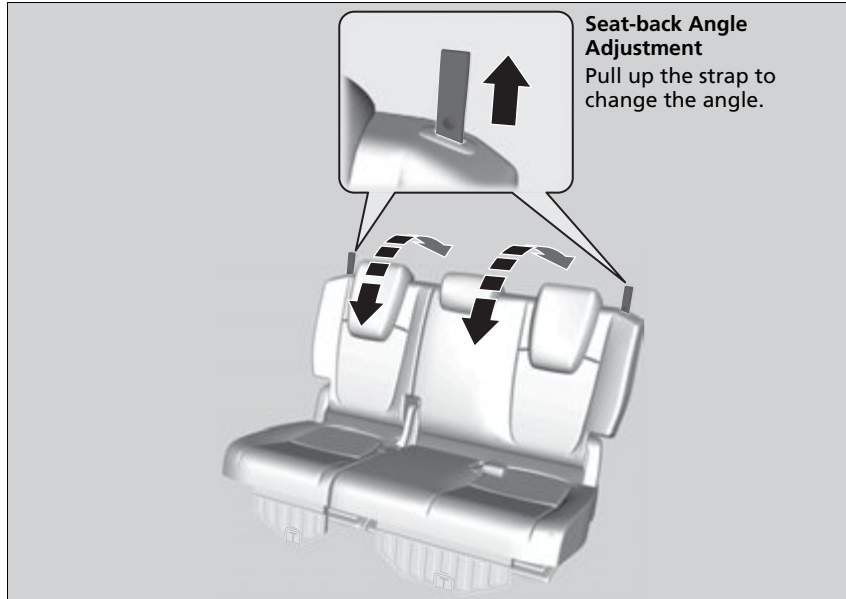

► Adjusting the Seat Positions

Once a seat is adjusted correctly, rock it back and forth to make sure it is locked in position.

■ One-Motion 60/40 Split 3rd-Row Magic Seat®

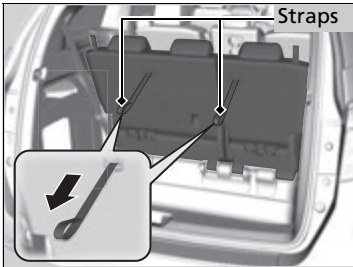

1. Store the center seat belt first. Insert a key into the slot on the side of the anchor buckle.
2. Retract the seat belt into the holder on the ceiling.
 - ▶ **Seat Belt with Detachable Anchor** P. 45
3. Lower the head restraints to their lowest position.
4. The right and left halves can be tucked away separately. Pull either strap to release the front leg lock of the third row seat.
5. Continue pulling the strap to tuck the seat and strap away into the cargo area.

▣ One-Motion 60/40 Split 3rd-Row Magic Seat®

Remove any items from the cargo area before you tuck away the third row seat.

The instruction label is attached at the back of the third row seat-back.

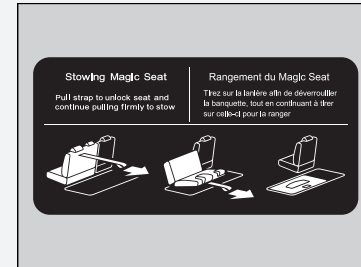

When you tuck away one side of the third row seats and use the non-recessed part of the cargo area, make sure to secure the cargo. Loose items can fly forward and cause injury if you have to brake hard.

■ **When returning the seat to the upright position:**

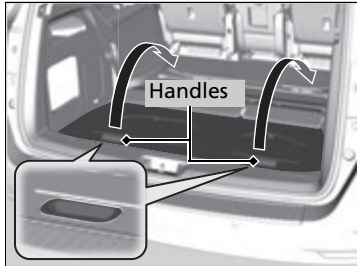

1. Grab the handle from outside.
Pull up the folded seat, begin to pivot it forward, then allow it to drop into position.

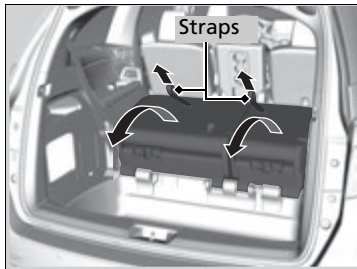

2. The front leg latches when it contacts the floor striker.

Pull the strap to put the seat-back(s) upright. Rock the seat-back and forth to confirm the seat is securely locked in position. There should be no movement.

⌘ **When returning the seat to the upright position:**

Make sure the seat is securely latched before driving by rocking the seat-back and forth.

Rear Seat Reminder

This feature alerts you to the possible presence of passengers or items in the second row or third row seats before you exit the vehicle. It activates when the vehicle is set to VEHICLE OFF if the rear doors were opened shortly before or after the vehicle was set to ON.

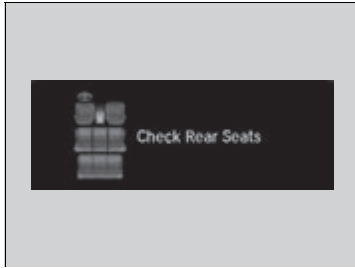

A reminder appears on the driver information interface and an alert will sound when the power mode is set to VEHICLE OFF.



A reminder appears on the audio/information screen when the power mode is set to VEHICLE OFF.

To dismiss the notification, select **Dismiss**.

►► Rear Seat Reminder

When the power mode is set to VEHICLE OFF, the reminder comes on briefly, then the function is deactivated.

The reminder will not work if the power mode has not been set to ON within 10 minutes of operating the rear doors.

The system does not detect passengers in the rear seat(s). Instead, it can detect when a rear door is opened and closed, indicating that there may be something in the rear seat(s).

You can turn off the notification setting.

Models with color audio system

► **Vehicle Customization** P. 143

Models with Display Audio

► **Customized Features** P. 463

Maintain a Proper Sitting Position

After all occupants have adjusted their seats and head restraints, and put on their seat belts, it is very important that they continue to sit upright, well back in their seats, with their feet on the floor, until the vehicle is safely parked and the engine is off.

Sitting improperly can increase the chance of injury during a crash. For example, if an occupant slouches, lies down, turns sideways, sits forward, leans forward or sideways, or puts one or both feet up, the chance of injury during a crash is greatly increased.

In addition, an occupant who is out of position in the front seat can be seriously or fatally injured in a crash by striking interior parts of the vehicle or being struck by an inflating front airbag.

► Maintain a Proper Sitting Position

WARNING

Sitting improperly or out of position can result in serious injury or death in a crash.

Always sit upright, well back in the seat, with your feet on the floor.

Head Restraints

Your vehicle is equipped with head restraints in all seating positions.

■ Adjusting the Front and Second Row Outer and Third Row Outer Head Restraints Positions

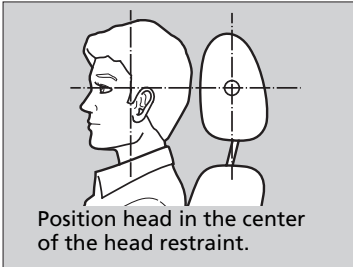

Head restraints are most effective for protection against whiplash and other rear-impact crash injuries when the center of the back of the occupant's head rests against the center of the restraint. The tops of the occupant's ears should be level with the center height of the restraint.

▣ Head Restraints

⚠ WARNING

Improperly positioning head restraints reduces their effectiveness and increases the likelihood of serious injury in a crash.

Make sure head restraints are in place and positioned properly before driving.

In order for the head restraint system to work properly:

- Do not hang any items on the head restraints, or from the restraint legs.
- Do not place any objects between an occupant and the seat-back.
- Install each restraint in its proper location.

Front and second row outer

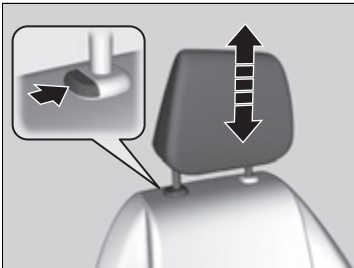

To raise the head restraint: Pull it upward.

To lower the head restraint: Push it down while pressing the release button.

Third row outer

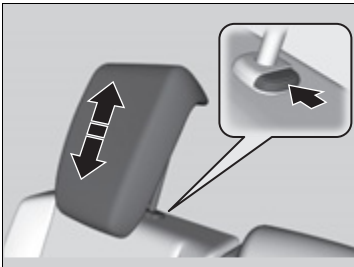

■ Changing the Second Row*/Third Row Center Seat Head Restraint Positions

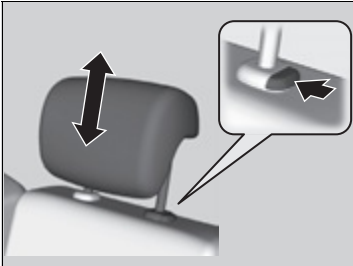

A passenger sitting in the second row/third row center seating position should adjust the height of their head restraint to an appropriate position before the vehicle begins moving.

To raise the head restraint:

Pull it upward.

To lower the head restraint:

Push it down while pressing the release button.

■ Removing and Reinstalling the Head Restraints

Head restraints can be removed for cleaning or repair.

To remove a head restraint:

Pull the restraint up as far as it will go. Then, push the release button and pull the restraint up and out.

To reinstall a head restraint:

Insert the legs back in place, then adjust the head restraint to an appropriate height while pressing the release button. Pull up on the restraint to make sure it is locked in position.

⌘ Removing and Reinstalling the Head Restraints

⚠ WARNING

Failure to reinstall, or correctly reinstall, the head restraints can result in severe injury during a crash.

Always replace the head restraints before driving.

To remove the third row seat outer head restraints, fold down the seat-back first.

⌘ **Third Row Seats** P. 230

* Not available on all models

Armrest

■ Using the Front and Second Row Outer* Seat Armrest



Pull down the armrest.

■ Front seat with adjustable armrest

Pull the armrest all the way down, then pull it up to the desired angle.

■ Using the Second Row Seat Armrest*



Pull up the strap and fold down the center backrest to use as an armrest.

Interior Lights

Interior Light Switches

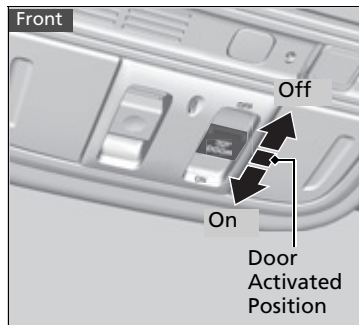

■ ON

The interior lights come on regardless of whether the doors or the tailgate are open or closed.

■ Door activated

The interior lights come on in the following situations:

Front:

- When any of the doors or the tailgate are opened.
- You unlock the driver's door.
- When the power mode is set to VEHICLE OFF.

Cargo area:

When the tailgate is open.

■ OFF

The interior lights remain off regardless of whether the doors or the tailgate are open or closed.



Interior Light Switches

In the door activated position, the interior lights fade out and go off about 30 seconds after the doors are closed.

The lights go off after 30 seconds in the following situations:

- When you unlock the driver's door but do not open it.
- When you set the power mode to VEHICLE OFF but do not open a door.

You can change the interior light dimming time.

Models with color audio system

➤ **Vehicle Customization** P. 143

Models with Display Audio

➤ **Customized Features** P. 463

The interior lights go off immediately in the following situations:

- When you lock the driver's door.
- When you set the power mode to ON.
- When you close the driver's door in ACCESSORY mode.

If you leave any of the doors open in VEHICLE OFF mode, the interior lights go off after about 15 minutes.

If you leave the tailgate open in VEHICLE OFF mode, the cargo area light goes off after about 30 minutes.

To avoid draining the battery, do not leave the interior light on for an extended length of time when the engine is off.

■ Map Light Switches

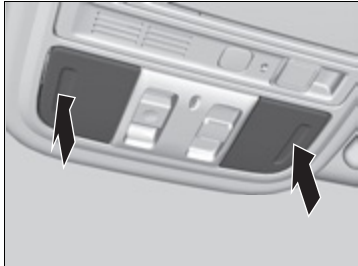

■ Front

The map lights can be turned on and off by pressing the lenses.



■ Second and third row

The map lights can be turned on and off by pressing the lenses when the front interior light switch is in the door activated position.

☒ Interior Light Switches

To avoid draining the battery, do not leave the interior light on for an extended length of time when the engine is off.

☒ Map Light Switches

When the front interior light switch is in the door activated position and any door is open, the map light will not go off when you press the lens.

Storage Items

■ Glove Box

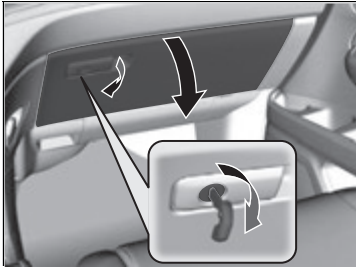

Pull the handle to open the glove box. You can lock the glove box with the built-in key.

☒ Glove Box

⚠ WARNING

An open glove box can cause serious injury to your passenger in a crash, even if the passenger is wearing the seat belt.

Always keep the glove box closed while driving.

■ Console Box*

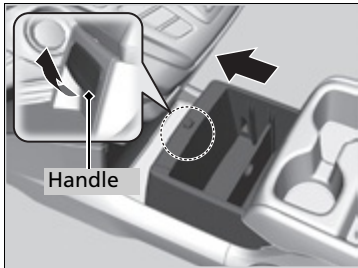

To open the console box, pull the handle and slide the box forward.

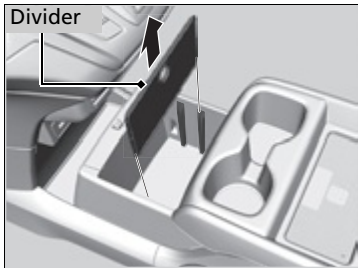

You can create more storage space by removing the divider.

■ Console Compartment with Lid*

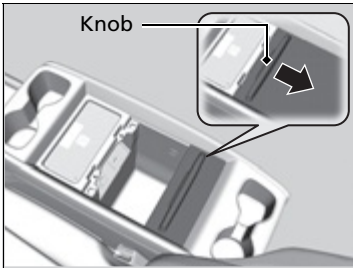

To open the console compartment, press the knob to unlock the lid, and then slide it rearward.

■ Center Pocket*

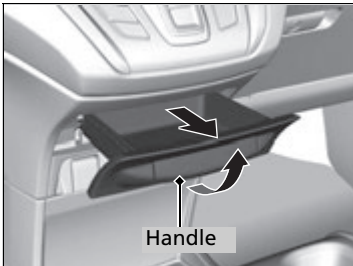

Pull the handle to open the center pocket.

* Not available on all models

■ Beverage Holders



■ Center console beverage holders

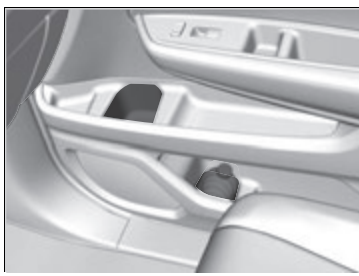

■ Front door beverage holders

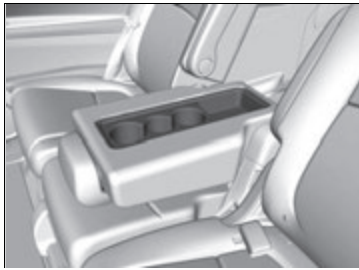

■ Second row seat beverage holders*

To use the beverage holder, fold the backrest.

▣ Using the Second Row Seat Armrest*

P. 238

▣ Beverage Holders

NOTICE

Spilled liquids can damage the upholstery, carpeting, and electrical components in the interior.

Be careful when you are using the beverage holders. Hot liquid can scald you.

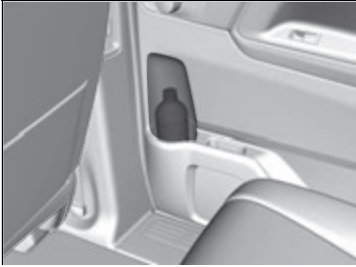

■ Rear door beverage holders



■ Third row seat beverage holders

■ Coat Hooks

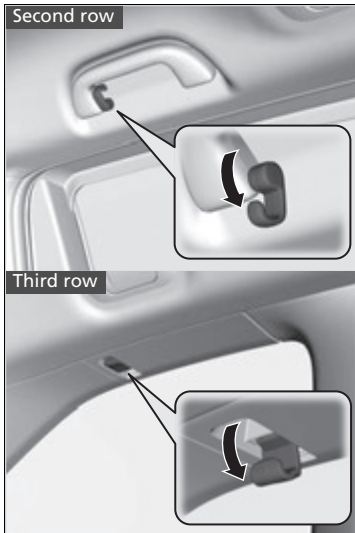

There are coat hooks under the grab handles in the second row, and under the window frames in the third row. Pull it down to use it.

▣ Coat Hooks

The coat hooks are not designed for large or heavy items.

■ Cargo Hooks

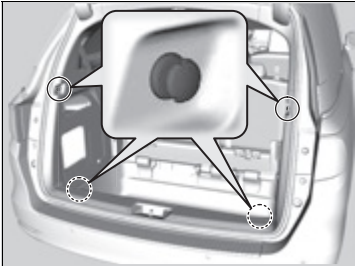

Use the cargo hooks to secure luggage in the cargo area.

■ Grocery Bag Hooks

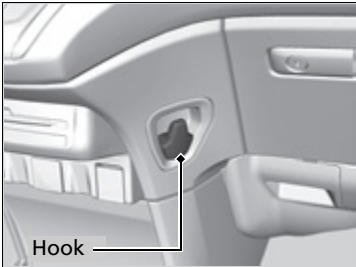

■ Front

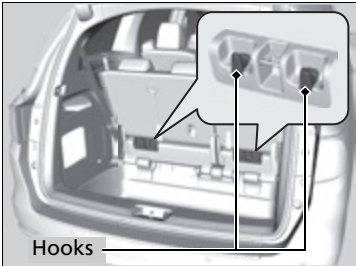

■ Rear

▣ Grocery Bag Hooks

The hooks are designed to hold light items. Heavy objects may damage the hook.

■ Sunglasses Holder

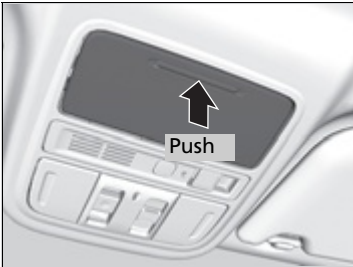

To open the sunglasses holder, push and release the indent. To close, push it again until it latches.

You can store eyeglasses and other small items in this holder.



■ Conversation mirror

The sunglasses holder comes with a mirror. Open the sunglasses holder fully, then push it back to the first detent. You can use the mirror to view the rear seats.

☒ Sunglasses Holder

Keep the holder closed while driving except when accessing stored items.

Other Interior Convenience Items

■ Accessory Power Sockets

The accessory power sockets can be used when the power mode is in ACCESSORY or ON.

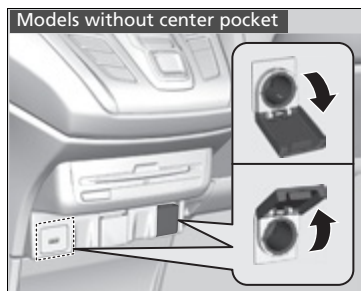

■ Accessory power socket (console panel)

Open the cover to use it.

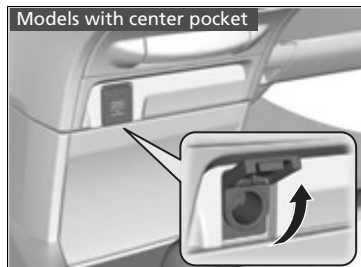

» Accessory Power Sockets

NOTICE

Do not insert an automotive type cigarette lighter element. This can overheat the accessory power socket.

The accessory power socket is designed to supply power for 12 volt DC accessories that are rated 180 watts (15 amps) or less.

To prevent battery drain, use the accessory power socket only when the engine is running.

When both sockets are being used, the combined power rating of the accessories should not exceed 180 watts (15 amps).

When the accessory power socket is not in use, close the cover to prevent any small foreign objects from getting into the accessory power socket.

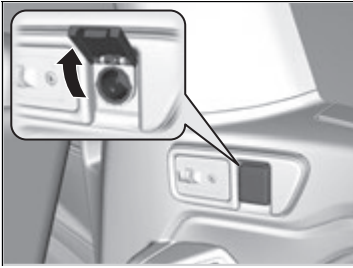

■ **Accessory power socket (third row seat)***

Open the cover to use it.

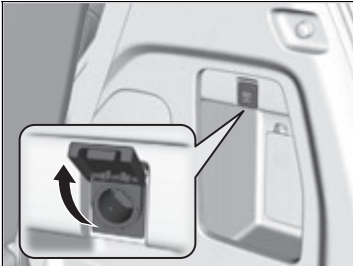

■ **Accessory power socket (cargo area)**

Open the cover to use it.

* Not available on all models

■ AC Power Outlet*

The AC power outlet can be used when the engine is running.

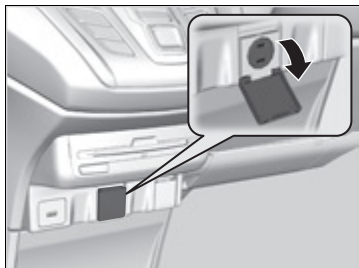

Open the cover to use it. Plug in the appliance slightly, turn it 90° clockwise, then push it all the way.

⌘ AC Power Outlet*

NOTICE

Do not use the AC power outlet for electric appliances that require high initial peak wattage, such as cathode-ray tube type televisions, refrigerators, electric pumps, etc. It is not suitable for devices that process precise data, such as medical equipment, and that require an extremely stable power supply, such as microcomputer-controlled electric blankets, touch sensor lamps, etc.

The AC power outlet is designed to supply power for up to 115 volt appliances that are rated 150 watts or less.

Continued use of any electric appliance/device exceeding these ratings may result in damage to the appliance/device.

When the AC power outlet is not in use, close the cover to prevent any small foreign objects from getting into the AC power outlet.

■ Wireless Charger*

To use the wireless charger, the power mode must be in ACCESSORY or ON. Charge a compatible device on the area indicated by the  mark as follows:

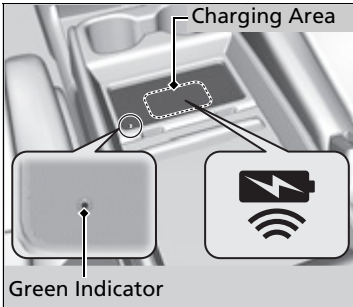

1. Place the device you want to charge on the charging area.
 - ▶ The system will automatically start charging the device, and the green indicator light will come on.
 - ▶ Make sure that the device is compatible with the system and placed with the chargeable side in the center of the charging area.
2. When charging is completed, the green indicator light will go off.
 - ▶ If the device is not located on the charge area correctly, the green indicator light will blink.

▶▶ Wireless Charger*

FCC statement

This product complies with the appropriate requirements or the required standards of FCC (Federal Communication Commission), described below:

This device complies with Part 18 of the FCC rules. This equipment generates, uses, and can radiate radio frequency energy and, if not installed and used per the instructions, may cause harmful interference to radio communications.

In order to use safely:

- Remove any metal objects from the charge pad before charging a device.
- Do not open the charger case.
- Do not use the charger if it malfunctions. Contact your dealer.

If the charger interferes with radio communications, attempt to correct the interference:

- Press and hold the switch on the charger for a few seconds to turn off the charger.

■ When charging does not start

Perform one of the solutions in the following table.

Indicator	Cause	Solution
Slow Blink	There is an obstacle(s) between the charging area and the device.	Remove the obstacle(s).
	The device is not within the charging area.	Move the device to the center of the charging area where  is located.
Fast Blink	The wireless charger is faulty.	Turn the vehicle off and back on. If the indicator still blinks, contact a dealer.

Controls

Wireless Charger*

⚠ CAUTION

Metal objects between the charge pad and the device to be charged will get hot and can burn you.

- Always remove foreign objects from the charge pad before charging the device.
- Be sure the surface is clear of dust and other debris before charging.
- Do not spill liquids (i. e. water, drinks, etc.) on the charger and the device.
- Do not use oil, grease, alcohol, benzine or thinner for cleaning the charge pad.
- Do not cover the system with towels, clothing, or other objects while charging etc.
- Avoid spraying aerosols which may come in contact with the charge pad surface.

Using the audio/information screen, you can disable the wireless charger function.

 **Customized Features** P. 463

This system consumes a lot of power. Do not use the system for a long time when the engine is not running. This may weaken the battery, making it difficult to start the engine.

When using the wireless charger, check the user's manual that came with the compatible device you want to charge.

Wireless Charger*

NOTICE

Do not place any magnetic recording media or precision machines within the charging area while charging. The data on your cards such as credit cards can be lost because of the magnetic effect. Also, precision machines such as watches may malfunction.

“Qi” and  marks are the registered trademarks owned by Wireless Power Consortium (WPC).

 mark is the registered trademark owned by Power Matters Alliance (PMA).

In the following cases, charging may stop or not start:

- The device is already fully charged.
- The temperature of the device is extremely high while charging.
- You are at a place that emits strong electromagnetic waves or noises, such as a TV station, electric power plant, or gas station.

A device may not charge if the size or shape of its chargeable side is not appropriate for use with the charging area.

Not all devices are compatible with the system.

During the charging phase, it is normal for the charging area and device to heat up.

Charging may be briefly interrupted when:

- All the doors and the tailgate are closed - to avoid interference with the proper functioning of the keyless access system.
- The position of the device is altered.

Do not charge more than one device at a time on a charging area.

* Not available on all models

■ Heated Steering Wheel*

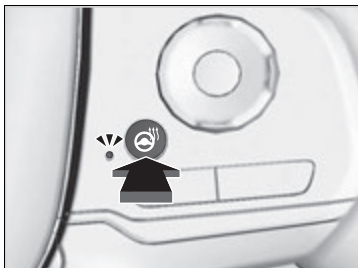

The power mode must be in ON to use the heated steering wheel.

Press the button on the right side of the steering wheel.

When a comfortable temperature is reached, press the button again to turn it off.

The heated steering wheel is turned off every time you start the engine, even if you turned it on the last time you drove the vehicle.

▣ Heated Steering Wheel*

Do not use the heated steering wheel continuously when the engine is off. Under such conditions, the battery may be weakened, making the engine difficult to start.

■ Front Seat Heaters*

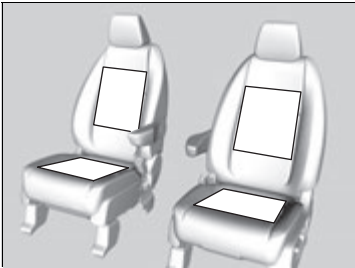

The seat heaters can be used when the power mode is in ON.

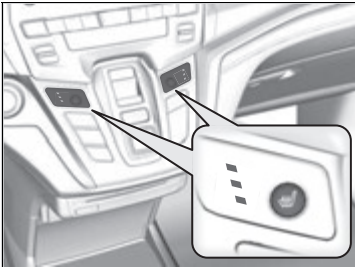

Press the seat heater button:

- Once - The HI setting (three indicators on)
- Twice - The MID setting (two indicators on)
- Three times - The LO setting (one indicator on)
- Four times - The OFF setting (no indicators on)

When the power mode is turned on after it is turned off, the previously selected setting is maintained.

▣ Front Seat Heaters*

⚠ WARNING

Heat induced burns are possible when using seat heaters.

Persons with a diminished ability to sense temperature (e.g., persons with diabetes, lower-limb nerve damage, or paralysis) or with sensitive skin should not use seat heaters.

Do not use the seat heaters even in LO when the engine is off. Under such conditions, the battery may be weakened, making the engine difficult to start.

After a certain period of time, the strength setting for the seat heaters will automatically be reduced by one level at a time until the seat heater shuts off. The elapsed time varies according to the interior environment.

* Not available on all models

■ Front Seat Heaters and Seat Ventilation*

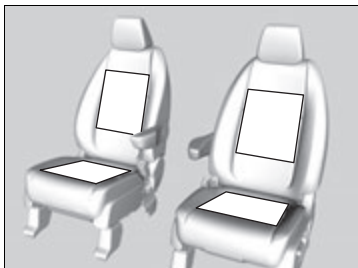

The seat heaters or ventilators can be used when the power mode is in ON.

The seat heaters: Use them to warm up the seat.

The seat ventilators: Use them when you want to ventilate the surface of the seats. When used with the air conditioning, the surface of the seats will become easier to cool.

Press the seat heater or the seat ventilation button:

Once - The HI setting (three indicators on)

Twice - The MID setting (two indicators on)

Three times - The LO setting (one indicator on)

Four times - The OFF setting (no indicators on)

When the power mode is turned on after it is turned off, the previously selected setting is maintained.



▣ Front Seat Heaters and Seat Ventilation*

⚠ WARNING

Heat induced burns are possible when using seat heaters.

Persons with a diminished ability to sense temperature (e.g., persons with diabetes, lower-limb nerve damage, or paralysis) or with sensitive skin should not use seat heaters.

Do not use the seat heaters and the seat ventilation even in LO when the engine is OFF. Under such conditions, the battery may be weakened, making the engine difficult to start.

After a certain period of time, the strength setting for the seat heaters will automatically be reduced by one level at a time until the seat heater shuts off. The elapsed time varies according to the interior environment.

■ Integrated Sunshades*

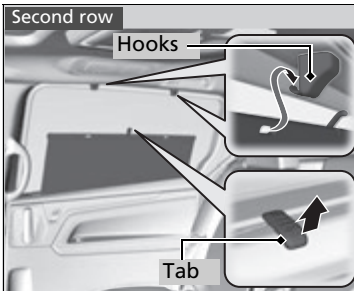

■ Second row sunshades

Pull the tab and roll up the sunshade all the way. Use the hooks to hang it.

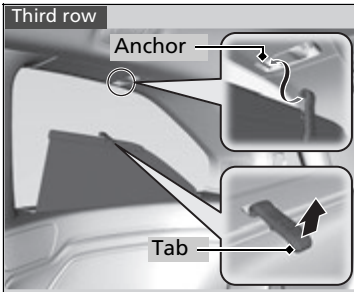

■ Third row sunshades

Pull the tab and roll up the sunshade all the way. Attach the tab to the anchor.

☒ Integrated Sunshades*

Use the sunshades only when the windows are fully closed. If a window is open while a shade is being used, the shade can blow off and unhook, hitting and hurting anyone sitting near the window.

* Not available on all models

Climate Control System

Dual-zone climate control system

Using Automatic Climate Control

The automatic climate control system maintains the interior temperature you select. The system also selects the proper mix of heated or cooled air that raises or lowers the interior temperature to your preference as quickly as possible.

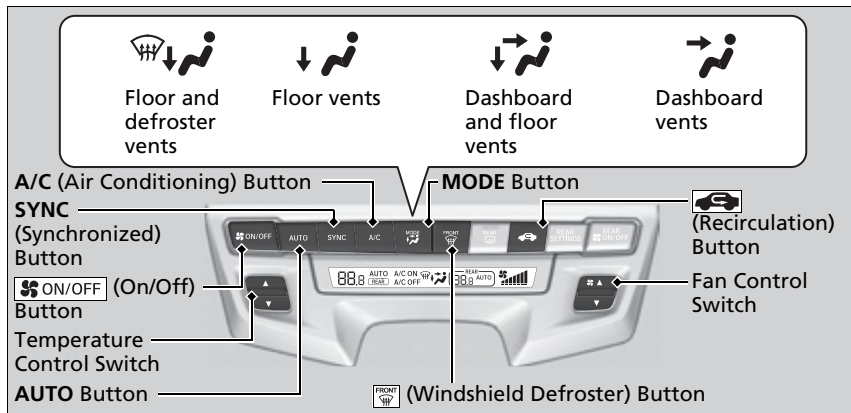

Use the system when the engine is running.

1. Press the **AUTO** button.
2. Adjust the interior temperature using the temperature control switch.
3. Press the **ON/OFF** button to cancel.

■ Switching between the recirculation and fresh air modes

Press the  button and switch the mode depending on environmental conditions.

Recirculation Mode (indicator on): Recirculates air from the vehicle's interior through the system.

Fresh Air Mode (indicator off): Maintains outside ventilation. Keep the system in fresh air mode in normal situations.

▣ Using Automatic Climate Control

During idle-stops, air-conditioning is suspended, and only the blower remains active. If you do not want air-conditioning suspended, press Auto Idle Stop **OFF** button to cancel idle-stop.

If any buttons are pressed while using the climate control system in auto, the function of the button that was pressed will take priority.

The **AUTO** indicator will go off, but functions unrelated to the button that was pressed will be controlled automatically.

To prevent cold air from blowing in from outside, the fan may not start immediately when the **AUTO** button is pressed.

If the interior is very warm, you can cool it down more rapidly by partially opening the windows, turning the system on auto, and setting the temperature to low. Change the fresh air mode to recirculation mode until the temperature cools down.

When you set the temperature to the lower or upper limit, **Lo** or **Hi** is displayed.

Pressing the **ON/OFF** button switches the climate control system between on and off. When turned on, the system returns to your last selection.

While ECON mode is active, the climate control system may have reduced cooling performance.

■ Defrosting the Windshield and Windows

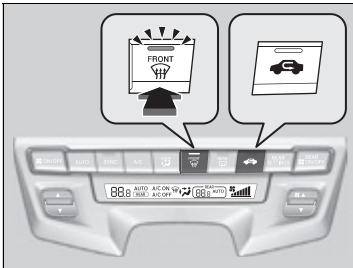

Pressing the  button turns the air conditioner system on and automatically switches the system to fresh air mode.

■ To rapidly defrost the windows

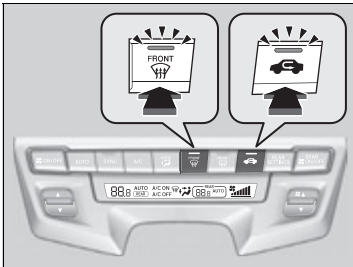

1. Press the  button.
2. Press the  button.

☒ Defrosting the Windshield and Windows

For your safety, make sure you have a clear view through all the windows before driving.

Do not set the temperature near the upper or lower limit.

When cold air hits the windshield, the outside of the windshield may fog up.

If you press the  button during Auto Idle Stop, the engine restarts automatically.

☒ To rapidly defrost the windows

After defrosting the windows, switch over to fresh air mode.

If you keep the system in recirculation mode, the windows may fog up from humidity. This impedes visibility.

■ Synchronization Mode

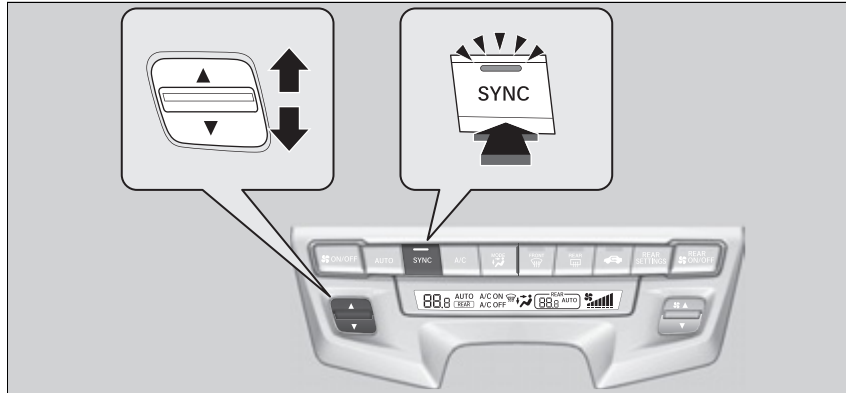

You can set the temperature synchronously for the front compartment and the rear passenger compartment in synchronization mode.

1. Press the **SYNC** button.
 - The system switches to synchronization mode.
2. Adjust the temperature using the temperature control switch.

Press the **SYNC** button to return to dual mode.

☞ Synchronization Mode

When the system is not in synchronization mode, the temperature for the front compartment and rear passenger compartment can be set separately.

Dual-zone climate control system

Rear Climate Control System

■ Using the Rear Climate Control System

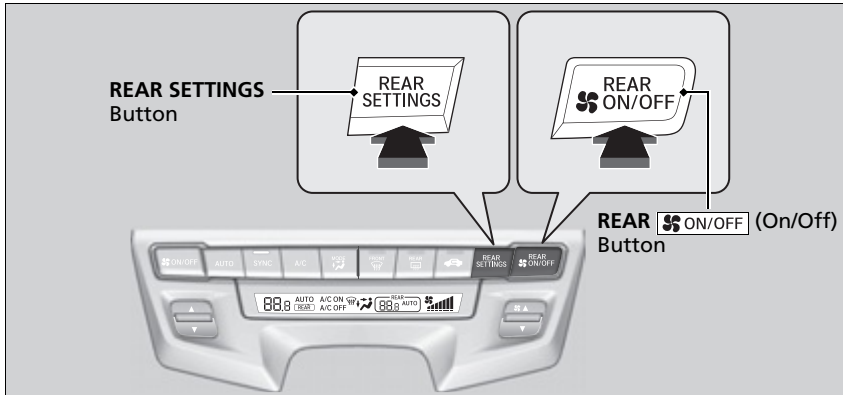

Use the system when the engine is running.

1. Press the **REAR ON/OFF** button.
2. Press the **REAR SETTINGS** button.
 - The system switches to the rear control mode for 10 seconds. The **REAR** indicator appears on the display.
3. Press the **AUTO** button.
 - The rear system changes to AUTO mode.
 - The system automatically adjusts the fan speed and airflow levels to maintain the set rear temperature. Change the temperature if necessary.
 - To turn off the rear climate control system, press the **REAR ON/OFF** button.

Dual-zone climate control system

Automatic Climate Control Sensors

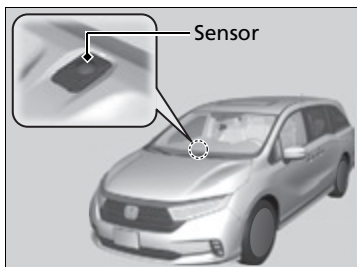

The automatic climate control system is equipped with sensors. Do not cover or spill any liquid on them.

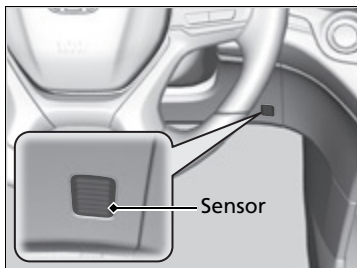

Tri-zone climate control system

Using Automatic Climate Control

The automatic climate control system maintains the interior temperature you select. The system also selects the proper mix of heated or cooled air that raises or lowers the interior temperature to your preference as quickly as possible.

Using Automatic Climate Control

Press the **FRONT CLIMATE** button to display A/C, MODE, and fan control information on the audio/information screen for several seconds. Select icon to turn on or off A/C, change the vent mode, or change the fan speed.

During idle-stops, air-conditioning is suspended, and only the blower remains active. If you do not want air-conditioning suspended, press Auto Idle Stop **OFF** button to cancel idle-stop.

If any buttons are pressed while using the climate control system in auto, the function of the button that was pressed will take priority. The **AUTO** indicator will go off, but functions unrelated to the button that were pressed will be controlled automatically.

To prevent cold air from blowing in from outside, the fan may not start immediately when the **AUTO** button is pressed.

If the interior is very warm, you can cool it down more rapidly by partially opening the windows, turning the system on AUTO, and setting the temperature to low. Change the fresh mode to recirculation mode until the temperature cools down.

When you set the temperature to the lower or upper limit, **Lo** or **Hi** is displayed.

Continued

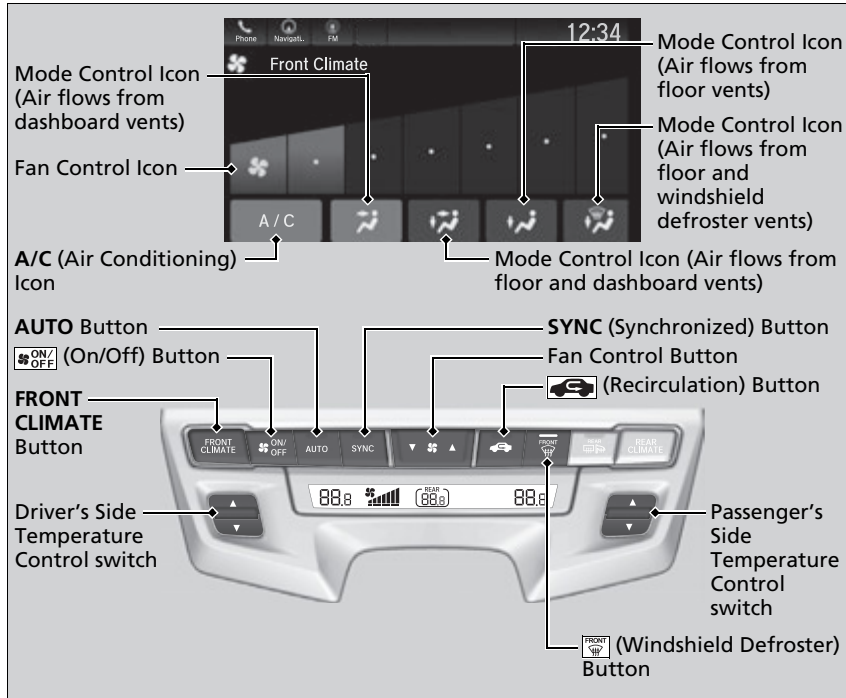

Use the system when the engine is running.

1. Press the **AUTO** button.
2. Adjust the interior temperature using the driver's side or passenger's side control switch.
3. Press the **ON/OFF** button to cancel.

▶▶ Using Automatic Climate Control

Pressing the **ON/OFF** button switches the climate control system between on and off. When turned on, the system returns to your last selection.

While ECON mode is active, the climate control system may have reduced cooling performance.

■ Switching between the recirculation and fresh air modes

Press the  button and switch the mode depending on environmental conditions.

Recirculation Mode (indicator on): Recirculates air from the vehicle's interior through the system.

Fresh Air Mode (indicator off): Maintains outside ventilation. Keep the system in fresh air mode in normal situations.

■ Defrosting the Windshield and Windows

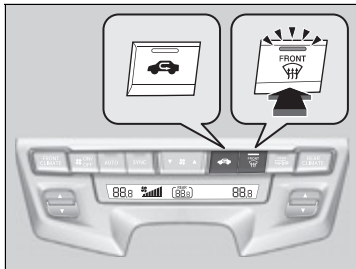

Pressing the  button turns the air conditioner system on and automatically switches the system to fresh air mode.

■ To rapidly defrost the windows

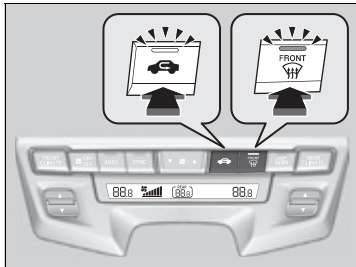

1. Press the  button.
2. Press the  button.

☒ Defrosting the Windshield and Windows

For your safety, make sure you have a clear view through all the windows before driving.

Do not set the temperature near the upper or lower limit.

When cold air hits the windshield, the outside of the windshield may fog up.

If you press the  button during Auto Idle Stop, the engine restarts automatically.

☒ To rapidly defrost the windows

After defrosting the windows, switch over to fresh air mode.

If you keep the system in recirculation mode, the windows may fog up from humidity. This impedes visibility.

■ Synchronization Mode

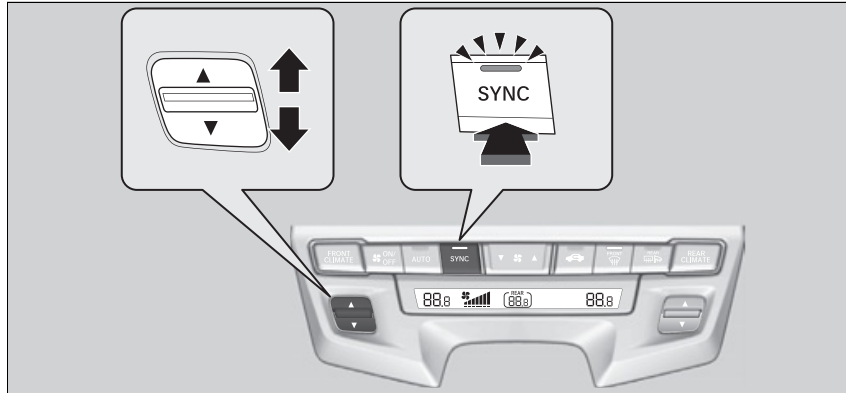

You can set the temperature synchronously for the driver's side, the passenger's side and the rear passenger compartment in synchronization mode.

1. Press the **SYNC** button.
 - The system switches to synchronization mode.
2. Adjust the temperature using the driver's side temperature control switch.

Press the **SYNC** button to return to tri-zone mode.

▣ Synchronization Mode

When the system is not in synchronization mode, the temperature for the driver's side, passenger's side, and rear passenger compartment can be set separately.

Tri-zone climate control system

Rear Climate Control System

Using the Rear Climate Control System From the Front Panel

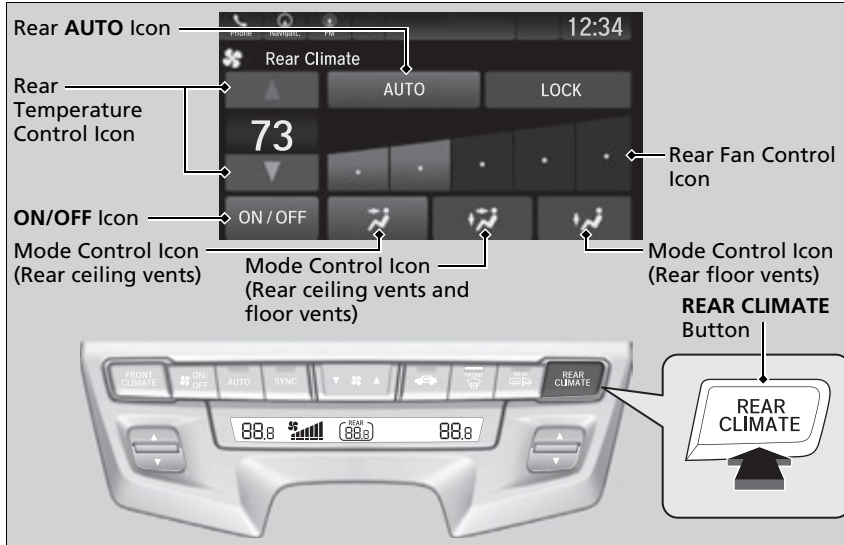

Use the system when the engine is running.

1. Press the **REAR CLIMATE** button.
2. Press the **REAR CLIMATE** button to display AUTO, MODE, temperature control, and fan control information on the audio/information screen for several seconds.
3. Select the **AUTO** icon.
 - The rear system changes to AUTO mode.
 - The system automatically adjusts the fan speed and airflow levels to maintain the set rear temperature. Change the temperature if necessary.
 - To turn off the rear climate control system, select the **ON/OFF** icon.

Continued

Using the Rear Climate Control System From the Front Panel

LOCK appears on the rear control panel while the rear lock is on.

If the rear lock is on while in SYNC mode, the rear control panel is disabled. **LOCK SYNC** appears on the rear control panel.

Using the Rear Climate Control System From the Front Panel

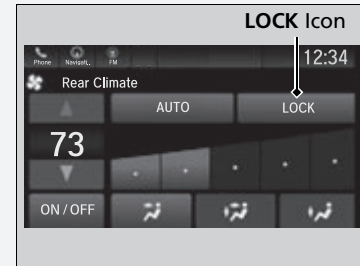

Select the **LOCK** icon to turn the rear lock mode on and off.

While the rear lock mode is on, the rear control panel is disabled.

- The color of **LOCK** icon on the audio/information screen changes from gray to blue.

■ Using the Rear Climate Control System From the Rear Panel

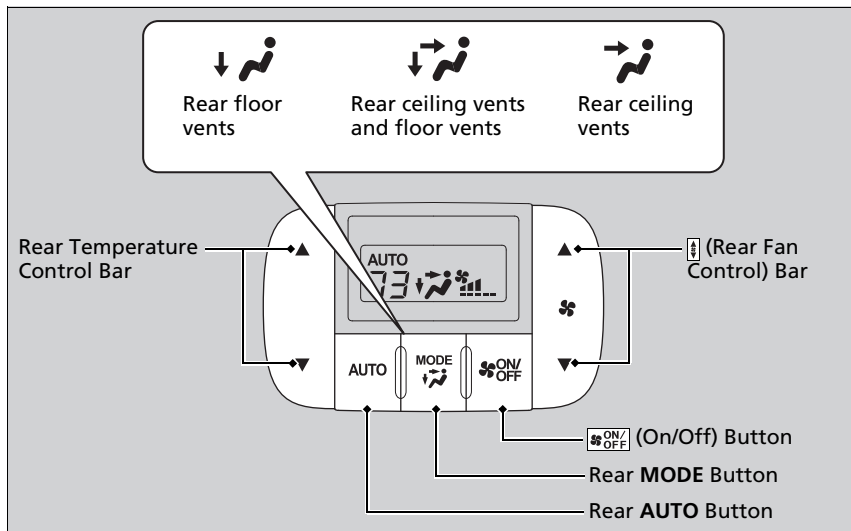

▣ Using the Rear Climate Control System From the Rear Panel

When the rear lock mode is off, the temperature of the rear passenger compartment can be controlled independently.

Use the system when the engine is running.

1. Press the **AUTO** button.
2. Adjust the interior temperature using the rear temperature control bar.
3. To turn off the rear climate control system, press  button.

Tri-zone climate control system

Automatic Climate Control Sensors

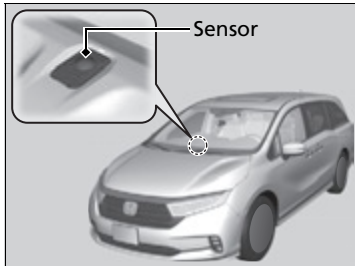

The automatic climate control system is equipped with sensors. Do not cover or spill any liquid on them.

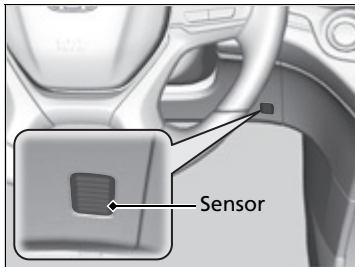

This page intentionally left blank.

Features

This chapter describes how to operate technology features.

Audio System

About Your Audio System	274
USB Ports	275
Auxiliary Input Jack	277
Audio System Theft Protection	278
Audio Remote Controls	279

Models with color audio system

Audio System Basic Operation	282
Audio/Information Screen	283
Adjusting the Sound	287
Display Setup	288
Playing AM/FM Radio	289
Playing an iPod	291
Playing a USB Flash Drive	294
Playing <i>Bluetooth</i> ® Audio	297

Models with Display Audio

Audio System Basic Operation	300
Audio/Information Screen	301
System Updates	315
File Manager	321
Adjusting the Sound	327
Display Setup	328
Voice Control Operation	330
Playing AM/FM Radio	333
Playing SiriusXM® Radio*	337
Playing a CD*	347
Playing an iPod	350
Playing a USB Flash Drive	353
Playing My Honda Music	356
Playing <i>Bluetooth</i> ® Audio	360

Playing Social Playlist	362
HondaLink®	364
Wi-Fi Connection	369
AT&T Hotspot*	371
Siri Eyes Free	372
Apple CarPlay	373
Android Auto	376

Audio Error Messages

General Information on the Audio System ..	385
Blu-ray/DVD Rear Entertainment System * ..	409
Customized Features	457, 463
HomeLink® Universal Transceiver * ..	482
Bluetooth® HandsFreeLink®	485, 510
CabinWatch® *	535
CabinTalk® *	536

* Not available on all models

About Your Audio System

The audio system features AM/FM radio and SiriusXM® Radio* service. It can also play audio CDs*, USB flash drives, iPod, iPhone, iPad* and *Bluetooth*® devices.

You can operate the audio system from the buttons* and knobs on the panel, the remote controls on the steering wheel, or the icons on the touchscreen interface*.

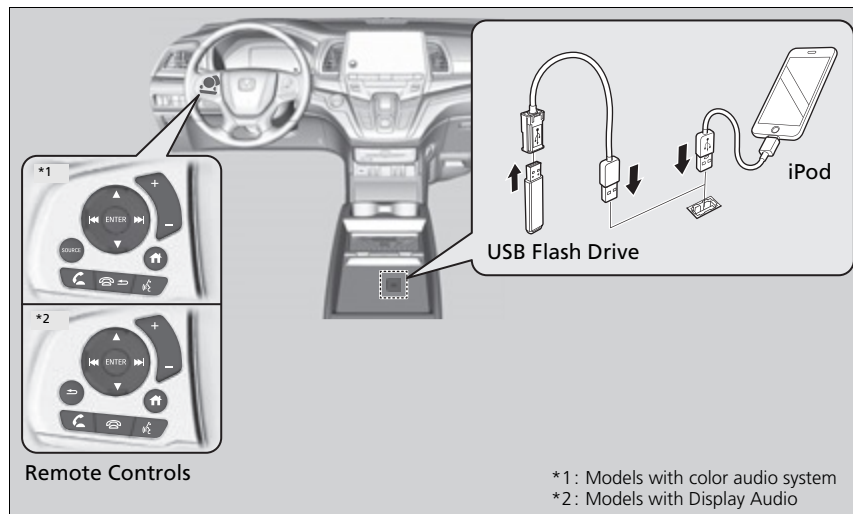

About Your Audio System

iPod, iPad, iPhone and iTunes are trademarks of Apple Inc.

State or local laws may prohibit the operation of handheld electronic devices while operating a vehicle.

Models with Blu-ray™ or CD player

Video CDs, DVDs*1, Blu-ray Discs*1, and 3-inch (8-cm) mini CDs are not supported.

*1: Models with CD player

SiriusXM® Radio* is available on a subscription basis only. For more information on SiriusXM® Radio*, contact a dealer.

General Information on the Audio System

P. 385

SiriusXM® Radio* is available in the United States and Canada, except Hawaii, Alaska, and Puerto Rico.

SiriusXM®* is a registered trademark of SiriusXM Radio*, Inc.

Models with Display Audio

After you set the power mode to VEHICLE OFF, you can use the audio system for up to 30 minutes per driving cycle, or until opening the driver's door. However, whether you can continue using the audio system depends on the battery condition. Repeatedly using this feature may drain the battery.

USB Ports

Install the iPod USB connector or the USB flash drive to the USB port.

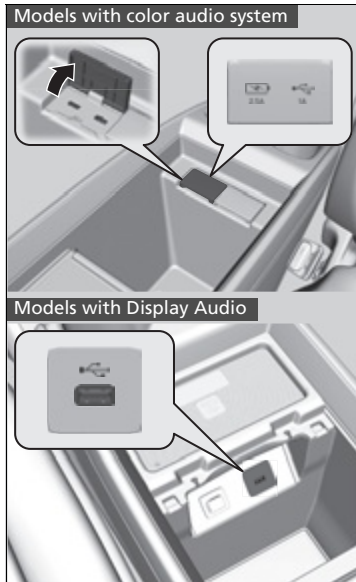

■ In the console compartment

Models with color audio system

The USB port (1.0A) on the right side is for playing audio files on a USB flash drive, connecting a cell phone, and charging devices.

The USB port (2.5A) on the left side is only for charging devices.

Models with Display Audio

The USB port (2.5A) is for charging devices, playing audio files and connecting compatible phones with Apple CarPlay or Android Auto.

- ▶ To prevent any potential issues, be sure to use an Apple MFi Certified Lightning Connector for Apple CarPlay, and for Android Auto, the USB cables should be certified by USB-IF to be compliant with USB 2.0 Standard.

⌘ USB Ports

- Do not leave the iPod or USB flash drive in the vehicle. Direct sunlight and high temperatures may damage it.
- We recommend that you use a USB cable if you are attaching a USB flash drive to the USB port.
- Do not connect the iPod or USB flash drive using a hub.
- Do not use a device such as a card reader or hard disk drive, as the device or your files may be damaged.
- We recommend backing up your data before using the device in your vehicle.
- Displayed messages may vary depending on the device model and software version.

If the audio system does not recognize the iPod, try reconnecting it a few times or reboot the device. To reboot, follow the manufacturer's instructions provided with the iPod or visit www.apple.com/ipod.

USB charge

The USB port can supply up to 2.5A of power. It does not output 2.5A unless the device requests. For amperage details, read the operating manual of the device that needs to be charged.

Under certain conditions, a device connected to the port may generate noise to the radio station you are listening to.



■ **On the console panel***

The USB port (2.5A) is only for charging devices.

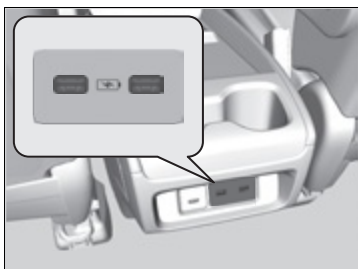

■ **On the back of the console compartment***

The USB ports (2.5A) are only for charging devices.



■ **On the left side of the third row seats***

The USB port (2.5A) is only for charging devices.

▶▶ USB Ports

USB Port (2.5A)*

This port is for battery charge only. You cannot play music even if you have connected a music player to it.

Auxiliary Input Jack

Models with color audio system

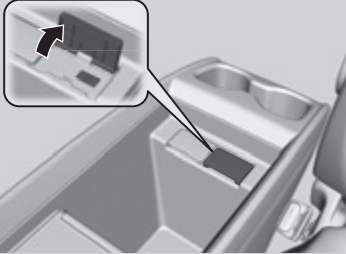

Models with Display Audio

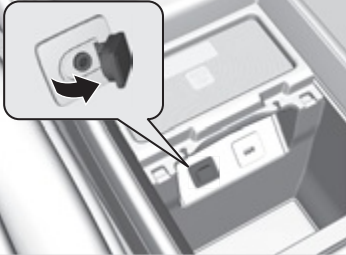

Use the jack to connect standard audio devices.

1. Open the **AUX** cover.
2. Connect a standard audio device to the input jack using a 1/8 inch (3.5 mm) stereo miniplug.
 - ▶ The audio system automatically switches to the AUX mode.

▶▶ Auxiliary Input Jack

Models with color audio system

You can return to AUX mode by pressing the **MEDIA** button.

Models with Display Audio

You can return to AUX mode by selecting the audio source icon on the audio/information screen.

You cannot use the auxiliary input jack if you replace the audio system.

Audio System Theft Protection

The audio system is disabled when it is disconnected from the power source, such as when the battery is disconnected or goes dead. In certain conditions, the system may display a code entry screen. If this occurs, reactivate the audio system.

■ Reactivating the audio system

1. Set the power mode to ON.
2. Turn on the audio system.
3. Press and hold the audio system power knob for more than two seconds.
 - ▶ The audio system is reactivated when the audio control unit establishes a connection with the vehicle control unit. If the control unit fails to recognize the audio unit, you must go to a dealer and have the audio unit checked.

Audio Remote Controls

Models with color audio system

Allow you to operate the audio system while driving.

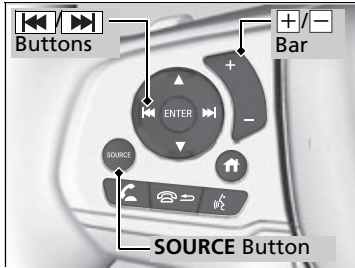

SOURCE Button

Cycles through the audio modes as follows:
FM1→FM2→AM→USB/iPod→*Bluetooth*[®]
Audio→AUX

+/- (Volume) Bar

Press : To increase the volume.

Press : To decrease the volume.

Buttons

- When listening to the radio
 - Press** : To select the next preset radio station.
 - Press** : To select the previous preset radio station.
 - Press and hold** : To select the next strong station.
 - Press and hold** : To select the previous strong station.
- When listening to an iPod, USB flash drive, or *Bluetooth*[®] Audio
 - Press** : To skip to the next song.
 - Press** : To go back to the beginning of the current or previous song.
- When listening to a USB flash drive, or *Bluetooth*[®] Audio
 - Press and hold** : To skip to the next folder.
 - Press and hold** : To go back to the previous folder.

Audio Remote Controls

Some modes appear only when an appropriate device or medium is used.

Depending on the *Bluetooth*[®] device you connect, some functions may not be operated.

Models with Display Audio

Allow you to operate the audio system while driving. The information is shown on the driver information interface.

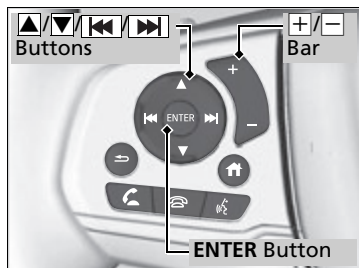

(Volume) Bar

Press : To increase the volume.

Press : To decrease the volume.

▶▶ Audio Remote Controls

Some modes appear only when an appropriate device or medium is used.

Depending on the *Bluetooth*® device you connect, some functions may not be operated.

Press the  (back) button to go back to the previous screen or cancel a command.

Press the  (home) button to go back to the home screen of the driver information interface.

You can show or hide the audio mode icons, or change the order of the icons.

 **Show/Hide Apps** P. 140

 **Arrange Apps** P. 141

▲/▼/◀▶/ENTER Buttons

- When selecting the audio mode
Press ▲ or ▼ to select **Now Playing** on the home screen of the driver information interface, and then press the **ENTER** button.

Press ▲ or ▼: To cycles through the audio modes as follows:
Android Auto/Apple CarPlay→SiriusXM®*→Rear Entertainment*→AUX
Input→AM→*Bluetooth*® Audio→Social Playlist→FM→My Honda Music→USB/
iPod→CD*
- When listening to the radio
Press ▶▶: To select the next preset radio station.
Press ◀◀: To select the previous preset radio station.
Press and hold ▶▶: To select the next strong station.
Press and hold ◀◀: To select the previous strong station.
- When listening to a CD*, iPod, USB flash drive, My Honda Music, or *Bluetooth*® Audio
Press ▶▶: To skip to the next song.
Press ◀◀: To go back to the beginning of the current or previous song.
- When listening to an iPod, USB flash drive, My Honda Music, *Bluetooth*® Audio, or Apple CarPlay
Press and hold ◀◀/▶▶: To move rapidly within a song.

* Not available on all models

Models with color audio system

To use the audio system, the power mode must be in ACCESSORY or ON.

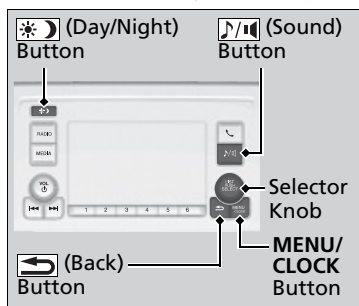

Use the selector knob or **MENU/CLOCK** button to access some audio functions.

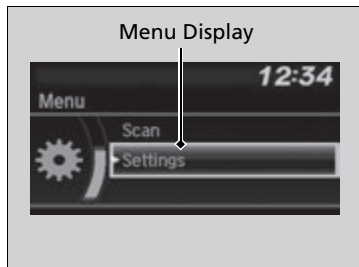

Selector knob: Rotate left or right to scroll through the available choices. Press to set your selection.

MENU/CLOCK button: Press to select any mode.

The available modes include the wallpaper, display, clock, language setup, and play modes. Play modes can be also selected from scan, random, repeat, and so on.

(Back) button: Press to go back to the previous display.

(Sound) button: Press to select the sound setting mode.

(Day/Night) button: Press to change the audio/information screen brightness.

Press , then adjust the brightness using .

- ▶ Each time you press , the mode switches between the daytime mode, nighttime mode and off mode.

Audio System Basic Operation

These indications are used to show how to operate the selector knob.

Rotate to select.

Press to enter.

Menu Items

- Adjusting the Clock** P. 154
- Wallpaper Setup** P. 285
- Display Setup** P. 288
- Scan** P. 290, 296
- Play Mode** P. 293, 296
- RDS Settings** P. 290
- Bluetooth** P. 297

One of the operating systems used in this unit is eCos.

For software license terms and condition, visit their website (eCos license URL:

<http://ecos.sourceforge.org/license-overview.html>)

For source code disclosure and other details regarding eCos, visit:

<http://www.hondaopensource2.com>

Press the **SOURCE**, , , or button on the steering wheel to change any audio setting.

- Audio Remote Controls** P. 279

Audio/Information Screen

Displays the audio status and wallpaper. From this screen, you can go to various setup options.

Switching the Display

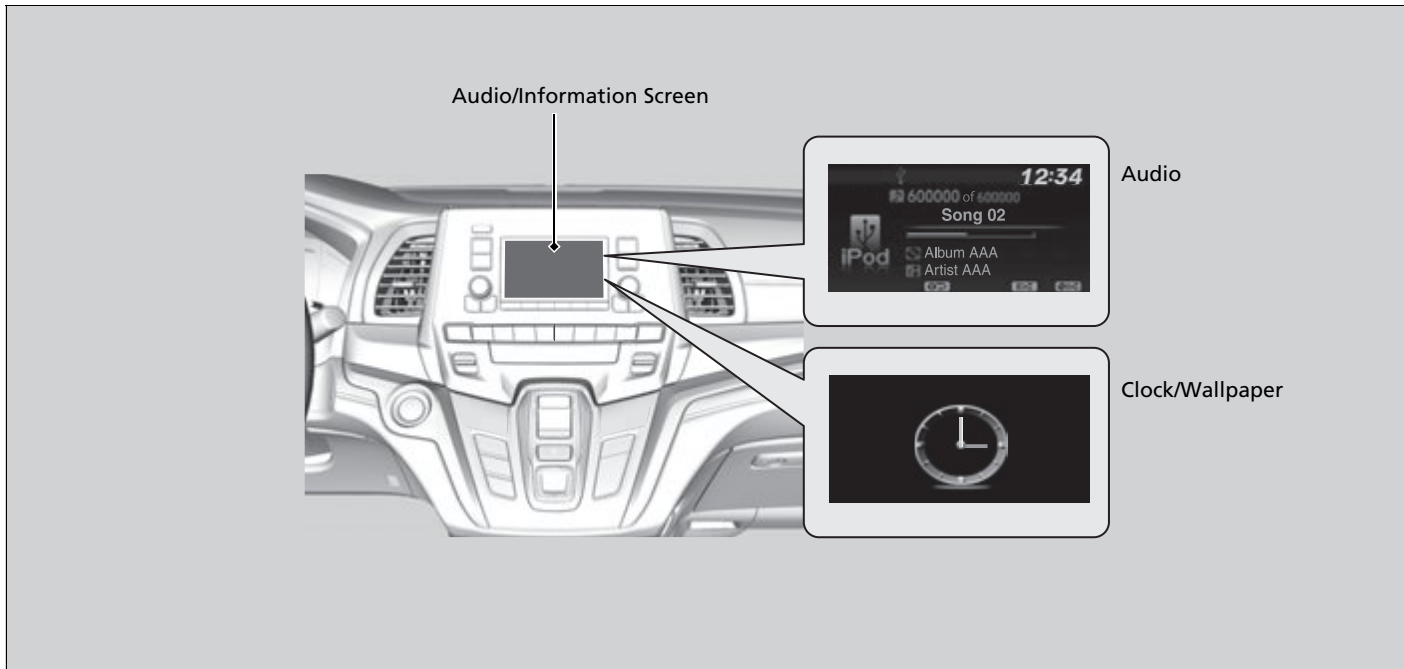







■ Audio

Shows the current audio information.

■ Clock/Wallpaper

Shows a clock screen or an image you import.

■ Change display

1. Press the **MENU/CLOCK** button.
2. Rotate  to select **Settings**, then press .
3. Rotate  to select **Display Change**, then press .
4. Rotate  to select **Wallpaper**, then press .
 - ▶ If you want to return to the audio/information screen, select **Audio**.

Wallpaper Setup

You can change, store, and delete the wallpaper on the audio/information screen.

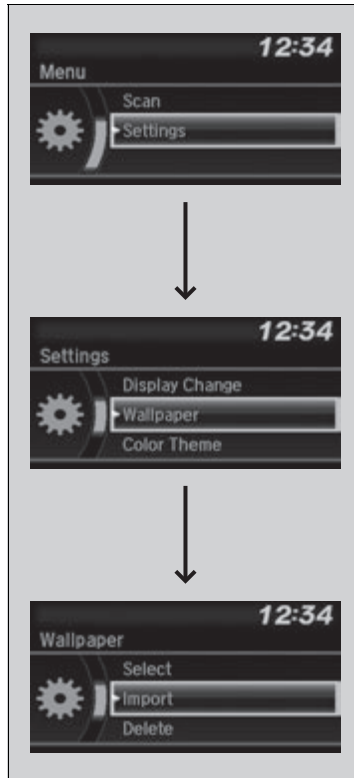













■ Import wallpaper

You can import up to three images, one at a time, for wallpaper from a USB flash drive.

1. Connect the USB flash drive to the USB port.

▶ **USB Ports** P. 275









2. Press the **MENU/CLOCK** button.
3. Rotate  to select **Settings**, then press .
4. Rotate  to select **Wallpaper**, then press .
5. Rotate  to select **Import**, then press .
 - ▶ The picture name is displayed on the list.
6. Rotate  to select a desired picture, then press .
 - ▶ The selected picture is displayed.
7. Press  to save the picture.
8. Press  to select **OK**.
9. Rotate  to select a location to save the picture, then press .
 - ▶ The display will return to the wallpaper setting screen.

▣ Wallpaper Setup







- When importing wallpaper files, the image must be in the USB flash drive's root directory. Images in a folder cannot be imported.
- The file name must be fewer than 64 characters.
- The file format of the image that can be imported is BMP (bmp) or JPEG (jpg).
- The individual file size limit is 2 MB.
- The maximum image size is 1,920 x 936 pixels. If the image size is less than 480 x 234 pixels, the image is displayed in the middle of the screen with the extra area appearing in black.
- Up to 255 files can be selected.
- If the USB flash drive does not have any pictures, the **No compatible images were found. See Owner's Manual.** message appears.

Continued









■ Select wallpaper

1. Press the **MENU/CLOCK** button.
2. Rotate  to select **Settings**, then press .
3. Rotate  to select **Wallpaper**, then press .
4. Rotate  to select **Select**, then press 
 - ▶ The screen changes to the wallpaper list.
5. Rotate  to select a desired wallpaper, then press .

■ To view wallpaper once it is set

1. Press the **MENU/CLOCK** button.
2. Rotate  to select **Settings**, then press .
3. Rotate  to select **Display Change**, then press .
4. Rotate  to select **Wallpaper**, then press .

■ Delete wallpaper

1. Press the **MENU/CLOCK** button.
2. Rotate  to select **Settings**, then press .
3. Rotate  to select **Wallpaper**, then press .
4. Rotate  to select **Delete**, then press 
 - ▶ The screen changes to the wallpaper list.
5. Rotate  to select a wallpaper that you want to delete, then press .
6. Rotate  to select **Yes**, then press 
 - ▶ The display will return to the wallpaper setting screen.



▶▶ Wallpaper Setup

To go back to the previous screen, press the  (back) button.

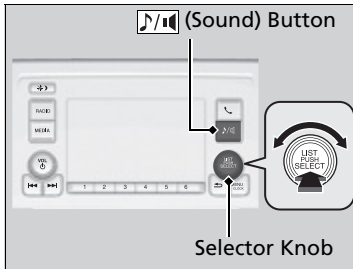

When the file size is large, it takes a while to be previewed.

Adjusting the Sound

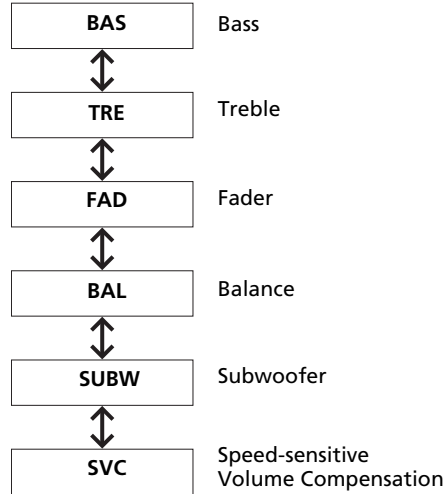
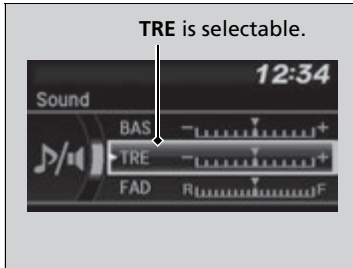

Press the  (sound) button, and rotate  to scroll through the following choices:



Rotate  to adjust the sound setting, then press .

Adjusting the Sound









The SVC has four modes: **Off**, **Low**, **Mid**, and **High**. SVC adjusts the volume level based on the vehicle speed. As you go faster, audio volume increases. As you slow down, audio volume decreases.

Display Setup

You can change the brightness or color theme of the audio/information screen.







■ Changing the Screen Brightness

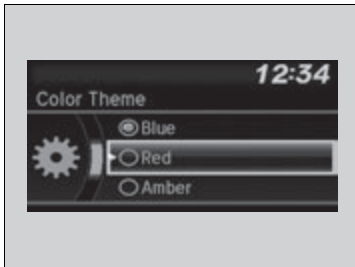

1. Press the **MENU/CLOCK** button.
2. Rotate  to select **Settings**, then press .
3. Rotate  to select **Display Adjustment**, then press .
4. Rotate  to select **Brightness**, then press .
5. Rotate  to adjust the setting, then press .

■ Changing the Screen's Color Theme



1. Press the **MENU/CLOCK** button.
2. Rotate  to select **Settings**, then press .
3. Rotate  to select **Color Theme**, then press .
4. Rotate  to select the setting you want, then press .

▣ Changing the Screen Brightness

You can change the **Contrast** and **Black Level** settings in the same manner.

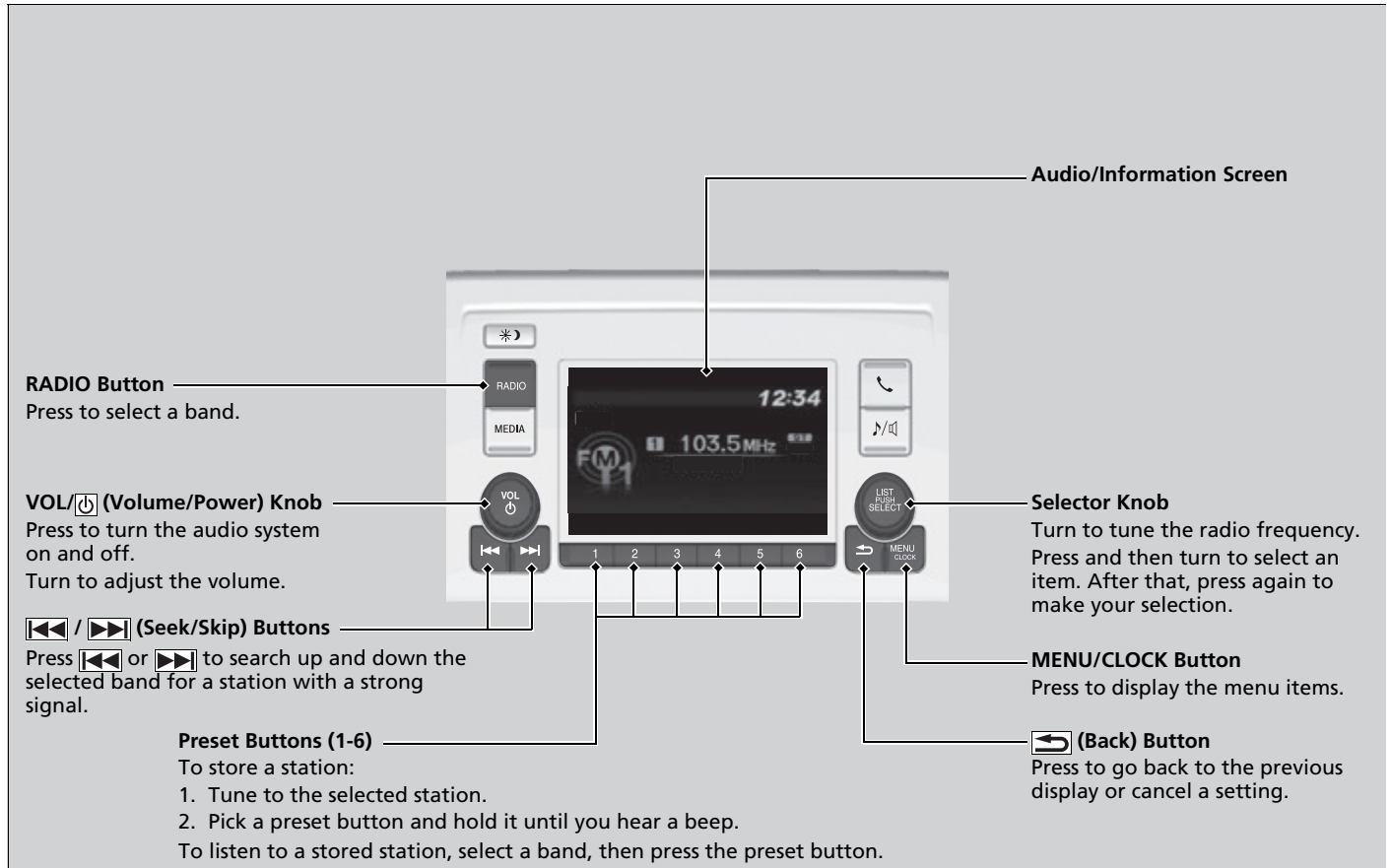

Playing AM/FM Radio



■ Radio Data System (RDS)



Provides text data information related to your selected RDS capable FM station.

■ To find an RDS station from Station List

1. Press  while listening to an FM station.
2. Rotate  to select the station, then press .



■ Update List

Updates your available station list at any time.

1. Press  while listening to an FM station.
2. Rotate  to select **Update List**, then press .

■ Radio text

Displays the radio text information of the selected RDS station.

1. Press the **MENU/CLOCK** button.
2. Rotate  to select **Settings**, then press .
3. Rotate  to select **RDS Settings**, then press .
4. Rotate  to select **Radio Text**, then press .

■ Scan

Samples each of the strongest stations on the selected band for 10 seconds.

1. Press the **MENU/CLOCK** button.
2. Rotate  to select **Scan**, then press .

To turn off scan, press .

▶▶ Playing AM/FM Radio

The **ST** indicator appears on the display indicating stereo FM broadcasts. Stereo reproduction in AM is not available.

You can store 6 AM stations and 12 FM stations into reset button memory. FM1 and FM2 let you store 6 stations each.

Switching the Audio Mode

Press the **SOURCE** button on the steering wheel.

 **Audio Remote Controls** P. 279

▶▶ Radio Data System (RDS)

When you select an RDS-capable FM station, the RDS automatically turns on, and the frequency display changes to the station name. However, when the signals of that station become weak, the display changes from the station name to the frequency.

Playing an iPod

Connect the iPod using your USB connector to the USB port, then press the **MEDIA** button.

📖 **USB Ports** P. 275

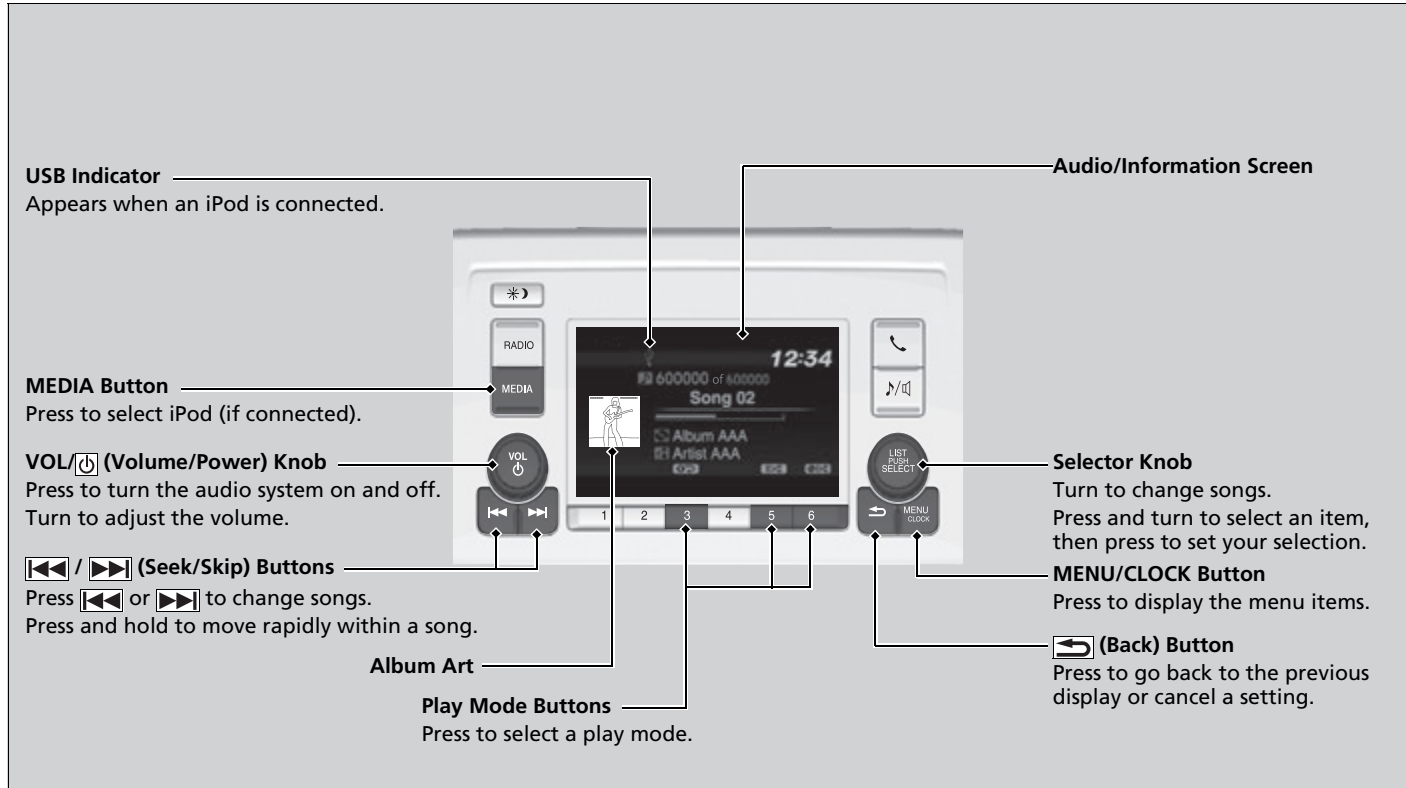

■ How to Select a Song from the iPod Music List with the Selector Knob



1. Press to display the iPod music list.

2. Rotate to select a category.

3. Press to display a list of items in the category.

4. Rotate to select an item, then press .
 ▶ Press and rotate repeatedly until a desired item you want to listen to is displayed.

▶▶ Playing an iPod

Available operating functions vary on models or versions. Some functions may not be available on the vehicle's audio system.

If there is a problem, you may see an error message on the audio/information screen.

iPod/USB Flash Drive P. 382

How to Select a Play Mode

You can select repeat and shuffle modes when playing a song.

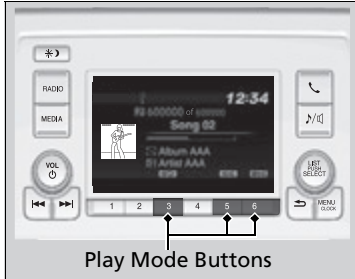

Available mode icons appear above the play mode buttons.

Press the button corresponding to the mode you want to select.

To turn off a play mode

Press the selected button.

How to Select a Play Mode

Play Mode Menu Items



 **Shuffle Albums:** Plays all available albums in a selected category (playlists, artists, albums, songs, genres, or composers) in random order.



 **Shuffle:** Plays all available songs in a selected category (playlists, artists, albums, songs, genres, or composers) in random order.

 **Repeat One Track:** Repeats the current song.

You can also select a play mode by pressing the **MENU/CLOCK** button.

Rotate  to select **Play Mode**, then press .

Rotate  to select a mode, then press .

To turn it off, rotate  to select **Normal Play**, then press .

Playing a USB Flash Drive

Your audio system reads and plays audio files on a USB flash drive in either MP3, WMA or AAC*1 format.

Connect your USB flash drive to the USB port, then press the **MEDIA** button.

➤ **USB Ports** P. 275

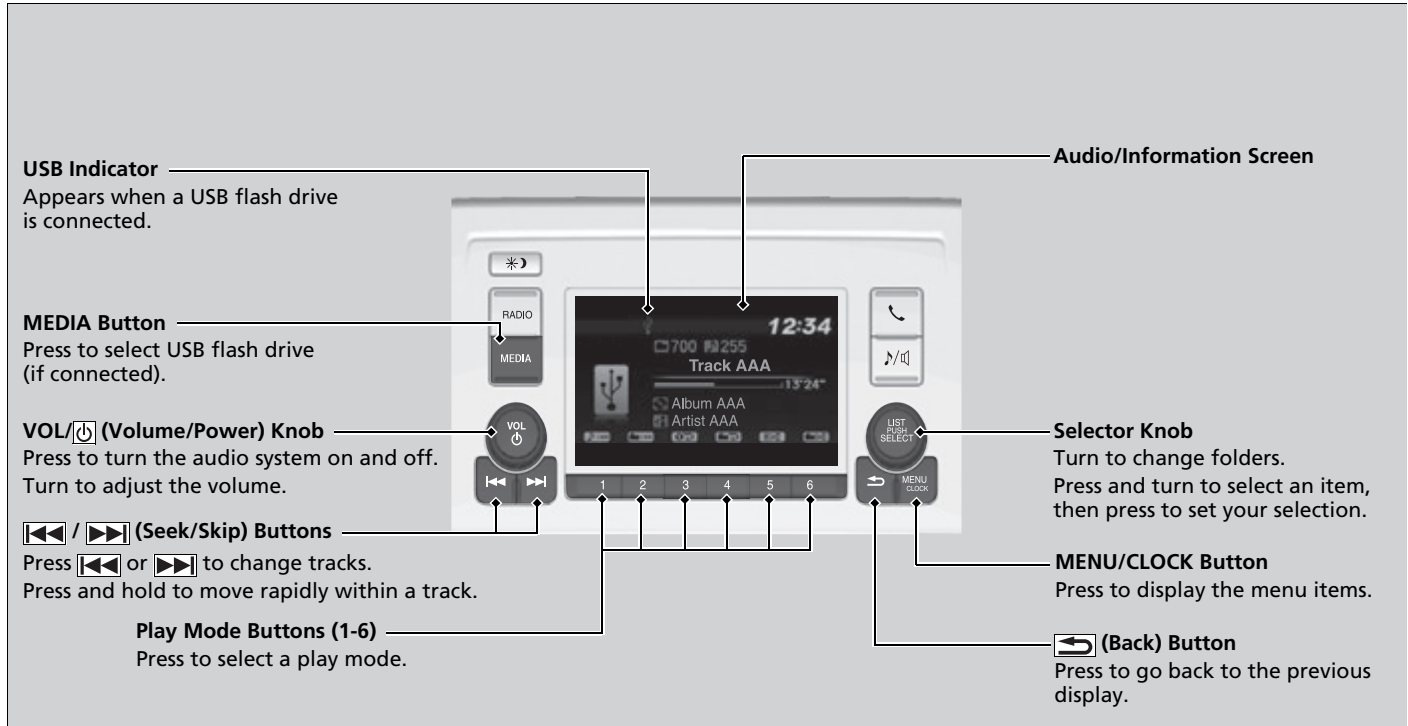



*1: Only AAC format files recorded with iTunes are playable on this unit.

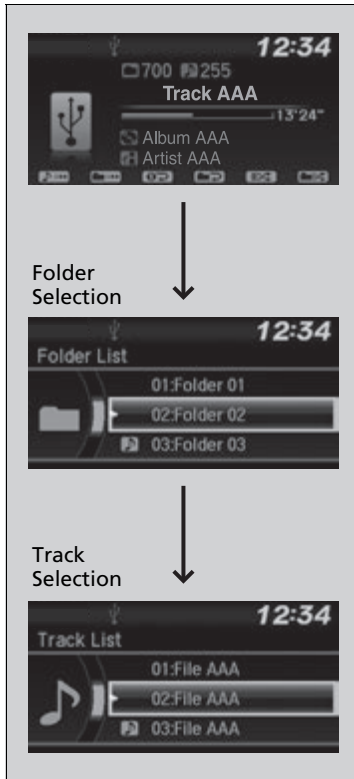

How to Select a File from a Folder with the Selector Knob



1. Press  to display a folder list.

2. Rotate  to select a folder.

3. Press  to display a list of tracks in that folder.

4. Rotate  to select a track, then press .

▶▶ Playing a USB Flash Drive

Use the recommended USB flash drives.

▶ **General Information on the Audio System**
P. 385

Files in WMA format protected by digital rights management (DRM) are not played.

The audio system displays **Unplayable File**, and then skips to the next file.

If there is a problem, you may see an error message on the audio/information screen.

▶ **iPod/USB Flash Drive** P. 382

Continued

■ How to Select a Play Mode

You can select repeat, random, and scan modes when playing a file.



Available mode icons appear above the play mode buttons.

Press the button corresponding to the mode you want to select.

■ To turn off a play mode

Press the selected button.

▶▶ How to Select a Play Mode

Play Mode Menu Items

Repeat

 **Repeat One Folder:** Repeats all files in the current folder.

 **Repeat One Track:** Repeats the current file.

Random

 **Random in Folder:** Plays all files in the current folder in random order.

 **Random All:** Plays all files in random order.

Scan



 **Scan Folders:** Provides 10-second sampling of the first file in each of the main folders.



 **Scan Tracks:** Provides 10-second sampling of all files in the current folder.

You can also select a play mode by pressing the

MENU/CLOCK button.

Rotate  to select **Play Mode**, then press .

Rotate  to select a mode, then press .

To turn it off, rotate  to select **Normal Play**, then press .

Playing *Bluetooth*® Audio

Your audio system allows you to listen to music from your *Bluetooth*-compatible phone.

This function is available when the phone is paired and connected to the vehicle's *Bluetooth*® HandsFreeLink® (HFL) system.

☑ **Phone Setup** P. 491

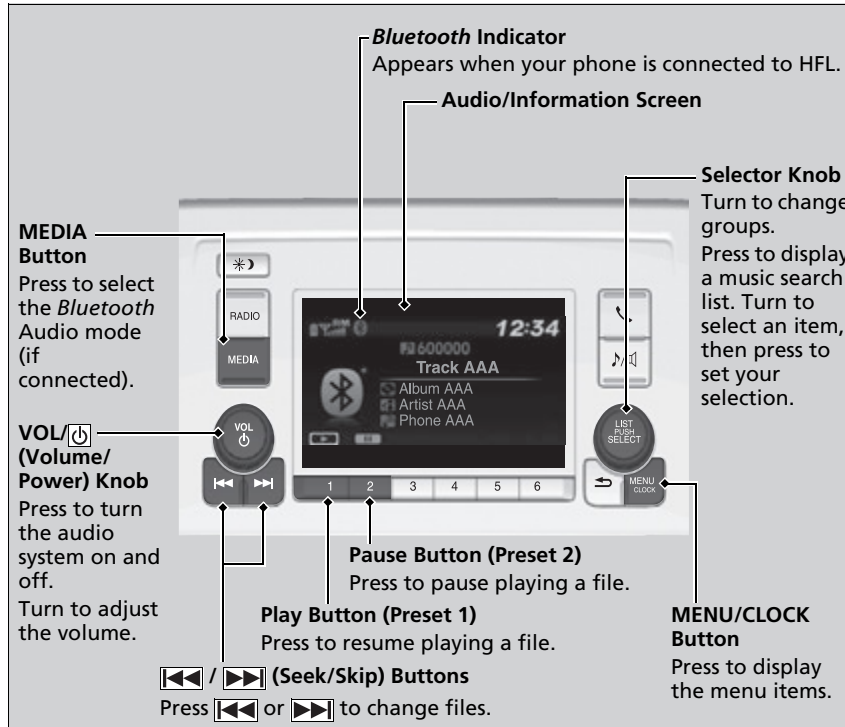

Continued

▶▶ Playing *Bluetooth*® Audio

Not all *Bluetooth*-enabled phones with streaming audio capabilities are compatible with the system. For a list of compatible phones:

- U.S.: Visit automobiles.honda.com/handsfreelink/, or call 1-888-528-7876.
- Canada: For more information on smartphone compatibility, call 1-888-528-7876.

In some states, it may be illegal to perform some data device functions while driving.

Only one phone can be used with HFL at a time. When there are more than two paired phones in the vehicle, the first paired phone the system finds is automatically connected.

If more than one phone is paired to the HFL system, there may be a delay before the system begins to play.

In some cases, the name of the artist, album, or track may not appear correctly.

Some functions may not be available on some devices.

■ To Play *Bluetooth*® Audio Files

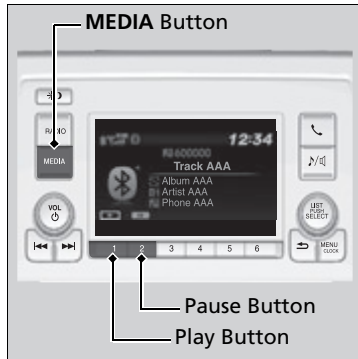

1. Make sure that your phone is paired and connected to HFL.
2. Press the **MEDIA** button until the *Bluetooth*® Audio mode is selected.

If the phone is not recognized, another HFL-compatible phone, which is not compatible for *Bluetooth*® Audio, may already be connected.

■ To pause or resume a file

Press the play or pause button to select a mode.

▶▶ To Play *Bluetooth*® Audio Files

To play the audio files, you may need to operate your phone. If so, follow the phone maker's operating instructions.

The pause function may not be available on some phones.

If any audio device is connected to the auxiliary input jack or USB port, you may need to press the **MEDIA** button repeatedly to select the *Bluetooth*® Audio system.

Switching to another mode pauses the music playing from your phone.

How to Select a Song from the Music Search List with the Selector Knob

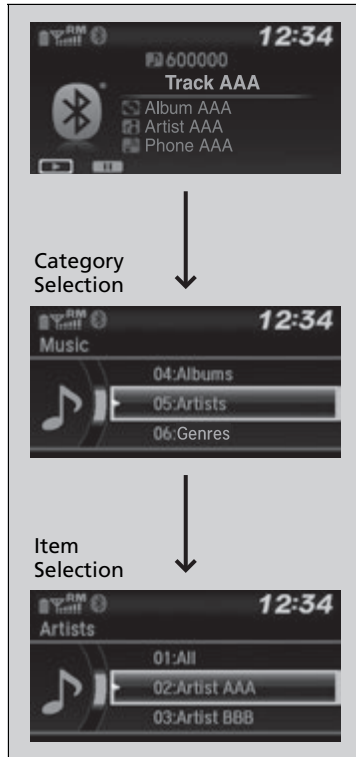

1. Press to display the music search list.

2. Rotate to select a category.

3. Press to display a list of items in the category.

4. Rotate to select an item, then press .

- ▶ Press and rotate repeatedly until a desired item you want to listen to is displayed.

How to Select a Song from the Music Search List with the Selector Knob

Depending on the *Bluetooth*® device you connect, some or all of the categories may not be displayed.

Models with Display Audio

To use the audio system function, the power mode must be in ACCESSORY or ON.

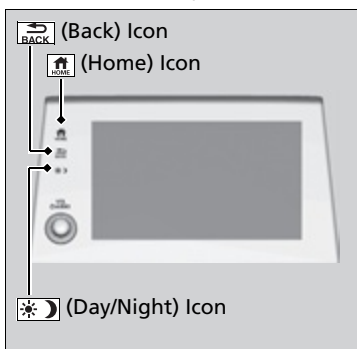



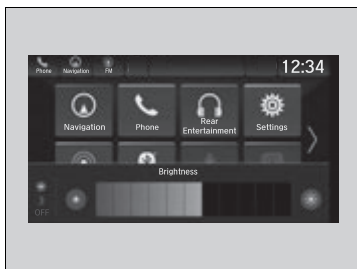

: Select to go to the home screen.

 **Switching the Display** P. 301

: Select to go back to the previous display when it is displayed.



: Select to change the audio/information screen brightness.

Select  once and select  or  to make an adjustment.

▶ Each time you select , the mode switches among the daytime mode, nighttime mode and off mode.

Audio/Information Screen

Displays the audio status and wallpaper. From this display, you can go to various setup options.

Switching the Display

Using the audio/information screen

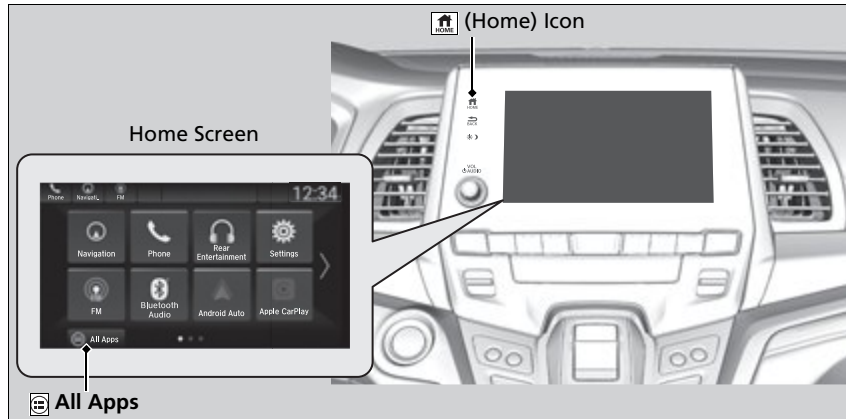

Select  to go to the home screen.

Select the following icons on the home screen or after selecting  **All Apps**.

Audio/Information Screen

Touchscreen Operation

- Use simple gestures - including touching, swiping, and scrolling - to operate certain audio functions.
- Some items may be grayed out during driving to reduce the potential for distraction.
- You can select them when the vehicle is stopped or use voice commands.
- Wearing gloves may limit or prevent touchscreen response.

You can change the touchscreen sensitivity setting.

 **Customized Features** P. 463

■ Phone

Displays the HFL information.

➤ **Bluetooth® HandsFreeLink®** P. 510

■ Trip Computer

Displays the trip computer information.

- **Current Drive** tab: Displays the current trip information.
- **Trip A/Trip B** tab: Displays information for the current and three previous drives. The information is stored every time you reset Trip A/B. To reset Trip A/B, select **Reset**. To change the setting of how to reset Trip A/B, select **Settings**, then select **Trip A Reset Method** or **Trip B Reset Method**.

■ Clock

Displays the clock.

■ System Updates

Updates the software version of the audio system.

➤ **System Updates** P. 315

■ FM/AM/Sirius XM*/CD*/USB/Bluetooth Audio/AUX Input/My Honda Music/Social Playlist

Displays the each audio information.

■ Settings

Enters the customizing menu screen.

➤ **Customized Features** P. 463

■ Navigation*

Displays the navigation screen.

➤ **Refer to the Navigation System Manual**

■ HondaLink

Displays the HondaLink® screen.

➤ **HondaLink®** P. 364

■ Apple CarPlay/Android Auto

Displays the **Apple CarPlay** or **Android Auto**.

➤ **Apple CarPlay** P. 373

➤ **Android Auto** P. 376

■ Messages

Displays the text message screen.

➤ **Bluetooth® HandsFreeLink®** P. 510

■ CabinTalk*

Displays the **CabinTalk** screen.

➤ **CabinTalk®*** P. 536

■ CabinWatch*

Displays the **CabinWatch** screen.

➤ **CabinWatch®*** P. 535

■ Rear Entertainment*

Displays the rear audio screen.

➤ **Blu-ray/DVD Rear Entertainment System*** P. 409

* Not available on all models

■ **AT&T Hotspot***

Displays the AT&T Hotspot screen.

➤ **AT&T Hotspot*** P. 371

■ **File Manager**

Displays the file manager screen.

➤ **File Manager** P. 321

Wallpaper Setup

You can change, store, and delete the wallpaper on the audio/information screen.

Import wallpaper

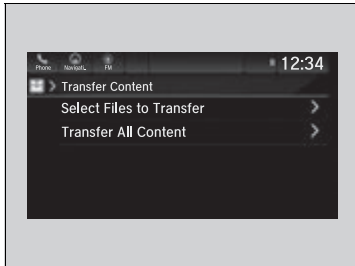
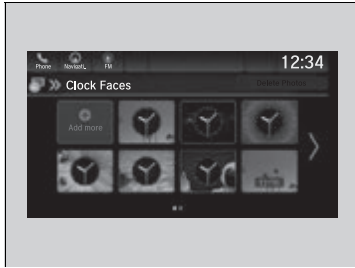

1. Connect the USB flash drive to the USB port in the console compartment.
 ▶ **USB Ports** P. 275
2. Select **Clock**.
3. Select **Settings**.
4. Select **Clock Faces**.
5. Select **Add More**.
 ▶ The **File Manager** screen is displayed.
6. Import a desired picture.
 ▶ **How to Transfer a File** P. 321
 ▶ The display will return to the **Clock Faces** screen.

Wallpaper Setup

The wallpaper you set up on **Clock Faces** cannot be displayed on the driver information interface.

- The file name must be fewer than 255 characters.
- The file format of the image that can be imported is BMP, GIF, JPEG, PNG, or WebP.
- If the USB flash drive does not have any pictures, the **No Data** message appears.

■ Select wallpaper

1. Select **Clock**.
2. Select **Settings**.
3. Select **Clock Faces**.
4. Select a desired wallpaper.
 - ▶ The preview is displayed on the screen.
5. Select **Save**.
 - ▶ The display will return to the clock screen.

■ To view wallpaper once it is set

1. Select  **HOME**.
2. Select **Clock**.



■ Delete wallpaper

1. Select **Clock**.
2. Select **Settings**.
3. Select **Clock Faces**.
4. Select **Delete Photos**.
 - ▶ The **File Manager** screen is displayed.
5. Delete a picture.
 - 🗑️ **How to Delete a File** P. 324
 - ▶ The display will return to the **Clock Faces** screen.

■ Home Screen

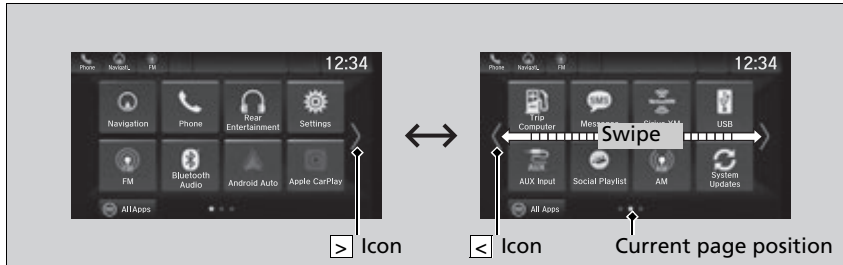
■ To move to the next screen



Selecting  or , or swiping the screen left or right changes to the next screen.

▶▶ Home Screen



The home screen has 5 pages. You cannot add any more pages.

Select  to go directly back to the first page of the home screen from any page.

■ To add app icons on the home screen

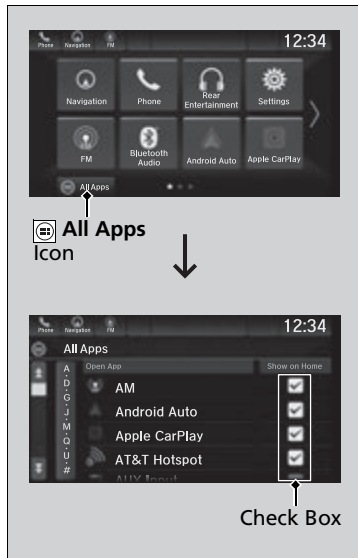
App icons can be added on the home screen.



1. Select .
2. Select  **All Apps**.
3. Check the box of the app you want to add.
 - ▶ The app icon will be added on the home screen.

▶▶ To add app icons on the home screen

Pre-installed apps may not start up normally. If this occurs, you need to reset the system.

 **Defaulting All the Settings** P. 481

If you perform **Factory Data Reset**, it may reset all the settings to their factory default.

 **Defaulting All the Settings** P. 481

In case those apps still do not startup normally even after **Factory Data Reset**, contact your dealer.

There is a possibility that a browser is shut down in the situation of the use. In that situation, the screen will return to before the browser startup.

■ To move icons on the home screen

You can change location on the home screen.



1. Select and hold an icon.
 - ▶ The screen switches to the customization screen.
2. Drag and drop the icon to where you want it to be.
3. Select **Done**.
 - ▶ The screen will return to the home screen.

▶▶ To move icons on the home screen

Select **Tips** to show tips. To hide them, select it again.

■ To remove icons on the home screen

You can delete the icons on the home screen.



1. Select and hold an icon.
 - ▶ The screen switches to the customization screen.
2. Drag and drop the icon you want to remove to the **Hide** icon.
 - ▶ The icon is removed from the home screen.
3. Select **Done**.
 - ▶ The screen will return to the home screen.

▶▶ To remove icons on the home screen

Apps will not be deleted by deleting the icon on the home screen.

Select **Tips** to show tips. To hide them, select it again.

■ To preset icons on the home screen

You can store up to three icons on the upper left of the home screen.

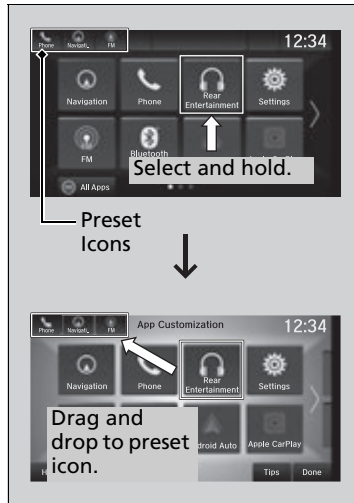

1. Select and hold an icon.
 - ▶ The screen switches to the customization screen.
2. Drag and drop the icon you want to store to the upper left of the home screen.
 - ▶ The icon is preset.
3. Select **Done**.
 - ▶ The screen will return to the home screen.

▶▶ To preset icons on the home screen

Select **Tips** to show tips. To hide them, select it again.

■ Status Area



1. Select the system status icon.
 - ▶ The status area appears.
2. Select an item to see the details.
3. Select  or the system status icon to close the area.

■ Updating Apps

Some of the audio system's apps can be updated wirelessly when connected via Wi-Fi, or *Bluetooth*® in conjunction with the HondaLink® app installed on a compatible iOS or Android device. If an update is available, a notification is displayed at the top of the screen with the respective app's update icon.

■ To update an app:

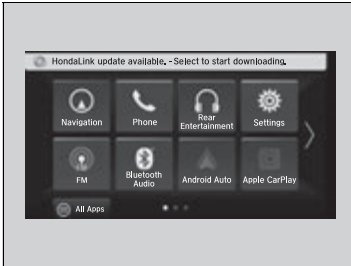

1. A notification appears and notifies you of a update message on the header area.

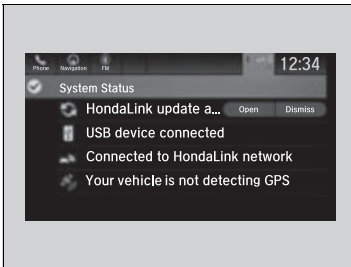

2. Select the system status icon, and then select the software update notification from the list.

▶▶ Updating Apps

The wireless updates are for the apps on the audio system only.

To update compatible apps on your iPhone or Android phone, please visit the App Store or Google Play Store, respectively.

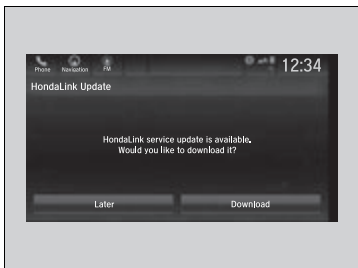

3. Select **Download.**

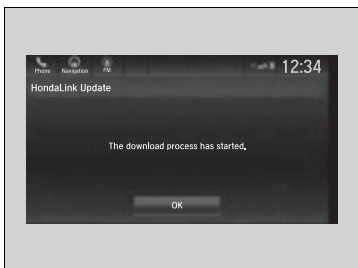

4. Select **OK.**

- ▶ A notification appears on the screen if the update is successful. Select **OK**.
- ▶ Restart the engine for the update to be applied.

System Updates

The audio system's firmware can be updated with a Wi-Fi connection or with a USB device.

How to Update Wirelessly

Wireless connection mode setup

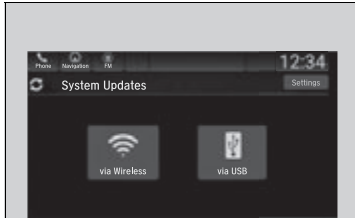

1. Select .
2. Select **System Updates**.
3. Select **Settings**.
4. Select **Connection Setup**.

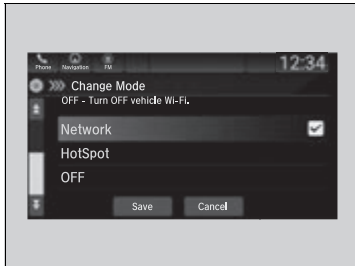

5. Select **Change Mode**.
6. Select **Network**, then **Save**.
 - ▶ The display returns to the network list.
7. Select an access point from the network list, then **Connect**.
 - ▶ If the audio system requires a password, enter a password.

Wireless connection mode setup

If your vehicle has a telematics control unit (TCU), you do not need the wireless connection mode setup.

Continued

■ How to update

When the audio system update is available, the notification is shown on the audio/information screen. Use the following procedure to update the system.

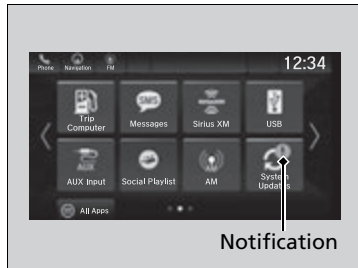

1. Select .
2. Select **System Updates**.

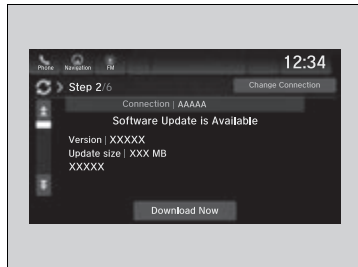

3. Select **via Wireless**.
4. Select **Download Now**.
 - ▶ A notification appears on the screen.

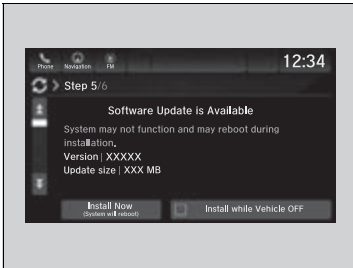

5. Select **Install Now** or **Install while Vehicle OFF**.

- ▶ A notification appears on the screen if the update is successful.

How to update

If **Install while Vehicle OFF** is selected and the user turns the vehicle back on after the update has been completed, for 3 to 5 minutes the system will rebuild the applications, during which time the Honda logo will be displayed.

Continued

■ Automatic download settings

Use the following procedure to change to the automatic download setting.

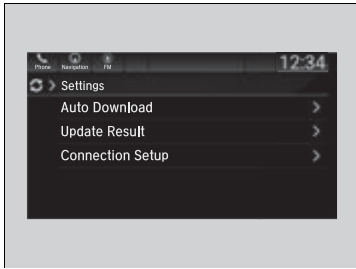

1. Select .
2. Select **System Updates**.
3. Select **Settings**.
4. Select **Auto Download**.
5. Select the access point, then **Allow**.

■ View an update result

Use the following procedure to confirm the update result.

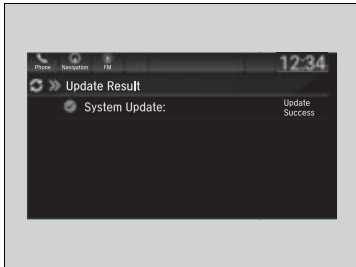

1. Select .
2. Select **System Updates**.
3. Select **Settings**.
4. Select **Update Result**.

How to Update with a USB Device

Download the update files from the server

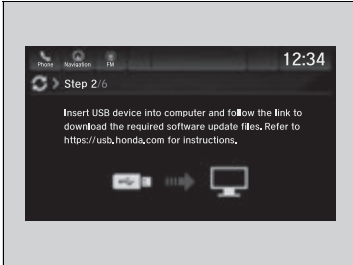
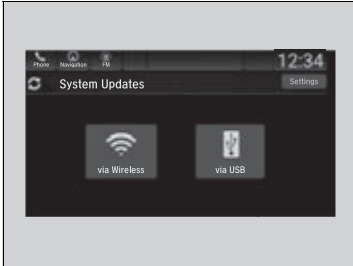

1. Select .
2. Select **System Updates**.
3. Select **via USB**.
 - ▶ A notification appears on the screen.
4. Connect a USB device into the USB port in the console compartment.
 - ▶ The inventory data is copied into the USB device.
 - ▶ **USB Ports** P. 275
5. Remove the USB device from the USB port.
6. Connect the USB device into your computer, and then download the update files.
 - ▶ Follow the link to download the required software update files. Refer to <https://usb.honda.com> for instructions.

How to Update with a USB Device

A USB device with a minimum of 8 GB of free space or more is recommended.

Be sure to delete any previous inventory or update files from the USB before starting the USB update process.

■ Update the audio system

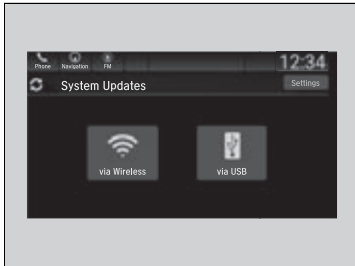

1. Select .
2. Select **System Updates**.
3. Select **via USB**.
 - ▶ A notification appears on the screen.
4. Connect the USB device with the update files into the USB port.
 - ▶ A notification appears on the screen.
 - **USB Ports** P. 275

5. Select **Install Now** or **Install while Vehicle OFF**.
 - ▶ A notification appears on the screen if the update is successful.

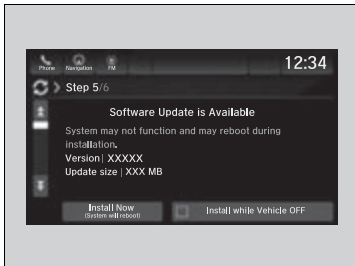

▶▶ Update the audio system

If **Install while Vehicle OFF** is selected and the user turns the vehicle back on after the update has been completed, for 3 to 5 minutes the system will rebuild the applications, during which time the Honda logo will be displayed.

File Manager

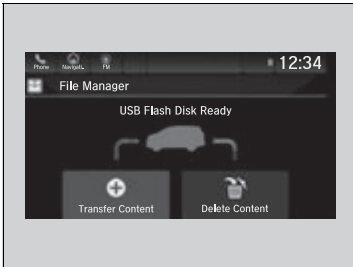

Allows you to transfer image or audio files to the audio system with a USB device.

How to Transfer a File



1. Connect a USB device into the USB port in the console compartment.

▶ **USB Ports** P. 275

2. Select , then select  **All Apps**.

3. Select **File Manager**.

4. Select **Transfer Content**.

To transfer a selected file:

5. Select **Select Files to Transfer**.

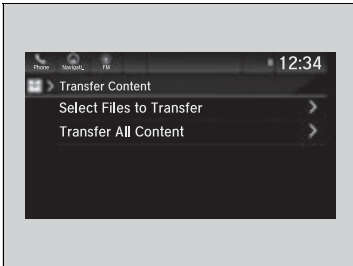

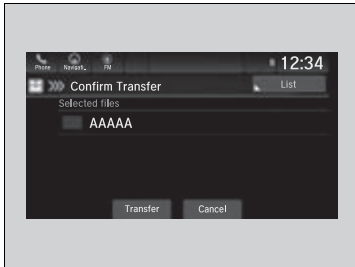
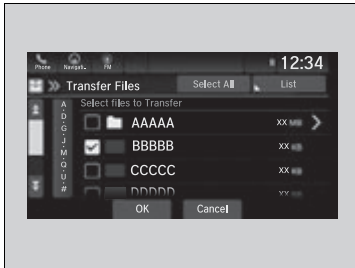

6. Select the file or folder you want to transfer.
7. Select **OK**.

8. Select **Transfer**.

- ▶ A confirmation message appears on the screen. Select **Continue**.
- ▶ A notification appears on the screen if the transfer is successful. Then, the display will return to the **File Manager** screen.

▶▶ How to Transfer a File

To switch the view method, select **List** or **Thumbnail** on the upper right of the screen.

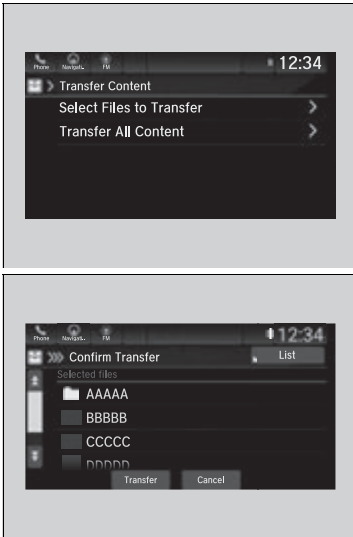

To transfer all files:

5. Select Transfer All Content.

6. Select Transfer.

- ▶ A confirmation message appears on the screen. Select **Continue**.
- ▶ A notification appears on the screen if the transfer is successful. Then, the display will return to the **File Manager** screen.



☒ How to Transfer a File

To switch the view method, select **List** or **Thumbnail** on the upper right of the screen.

Continued

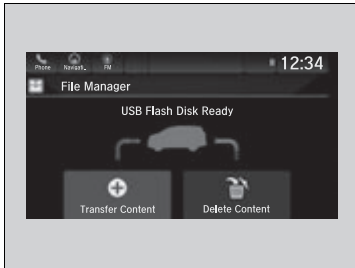
■ How to Delete a File



1. Select , then select  **All Apps**.
2. Select **File Manager**.
3. Select **Delete Content**.

To delete a selected file:

4. Select **Select Files to Delete**.

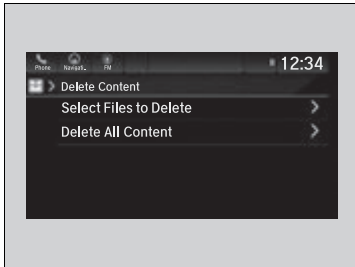

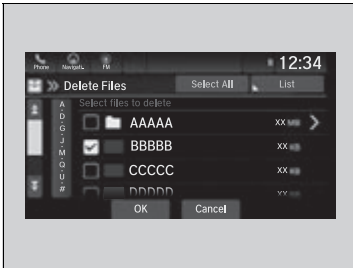

5. Select the file or folder you want to delete.

6. Select **OK**.

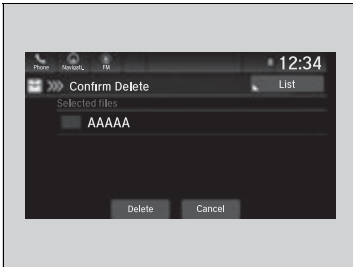

7. Select **Delete**.

- ▶ A notification appears on the screen if the deletion is successful. Then, the display will return to the **File Manager** screen.

▶▶ How to Transfer a File

To switch the view method, select **List** or **Thumbnail** on the upper right of the screen.

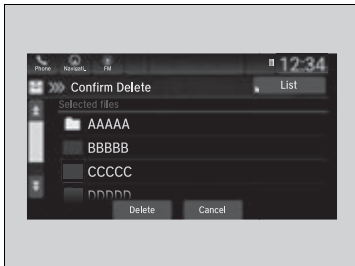
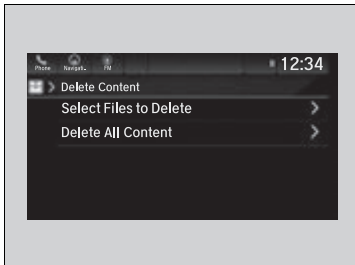

To delete all files:

4. Select **Delete All Content**.

5. Select **Delete**.

▶ A notification appears on the screen if the transfer is successful. Then, the display will return to the **File Manager** screen.

▶▶ How to Transfer a File

To switch the view method, select **List** or **Thumbnail** on the upper right of the screen.

Adjusting the Sound

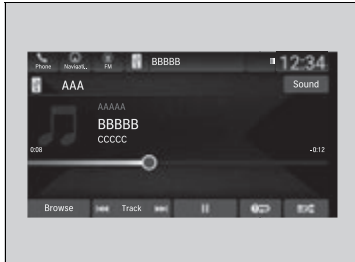

1. Select .
2. Select an audio source icon.
3. Select **Sound**.

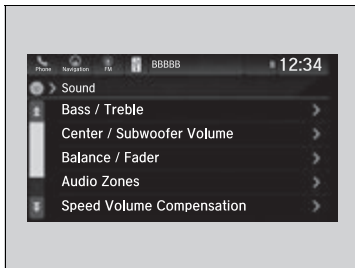

Select an item from the following choices:

- **Bass / Treble**: Treble, Midrange, Bass
- **Center / Subwoofer Volume (Subwoofer Volume)**: Center*, Subwoofer
- **Balance / Fader**: Balance, Fader
- **Audio Zones***: Driver Only, Front Only, Rear Only, Full Vehicle
- **Speed Volume Compensation**: Speed Volume Compensation (SVC)
- **DTS Neural Surround***: DTS Neural Surround™

Adjusting the Sound

The SVC has four modes: off, low, mid, and high. SVC adjusts the volume level based on the vehicle speed. As you go faster, audio volume increases. As you slow down, audio volume decreases.

You can also adjust the sound the following procedure.

1. Select .
2. Select **Settings**.
3. Select **Sound**.

To reset each setting for **Bass / Treble**, **Center / Subwoofer Volume (Subwoofer Volume)** and **Balance / Fader**, select **Reset**.

* Not available on all models

Display Setup

You can change the brightness of the audio/information screen.

■ Changing the Screen Brightness

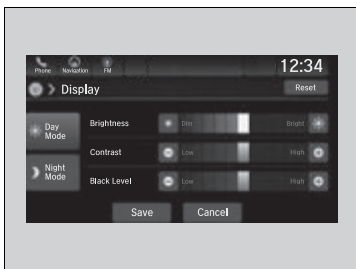

1. Select .
2. Select **Settings**.
3. Select **Display**.
4. Select **Day Mode** or **Night Mode**.
5. Select the setting you want.
6. Select **Save**.

☒ Changing the Screen Brightness

You can change the **Contrast** and **Black Level** settings in the same manner.

To reset the settings, select **Reset**.

■ Selecting an Audio Source

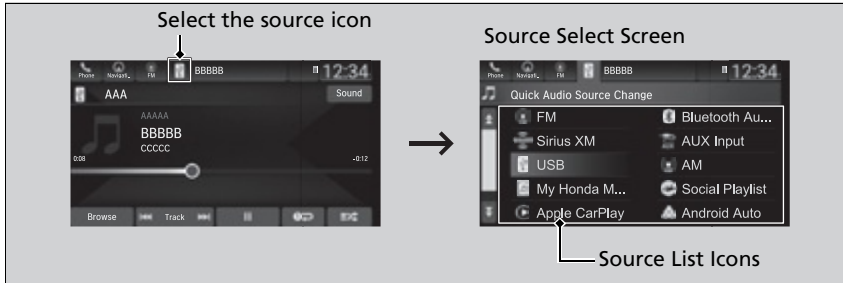

Select the current source icon, then select an icon on the source list to switch the audio source.



■ Limitations for Manual Operation*

Certain manual functions are disabled or inoperable while the vehicle is in motion. You cannot select a grayed-out option until the vehicle is stopped.

* Not available on all models

Voice Control Operation

Your vehicle has a voice control system that allows hands-free operation.

The voice control system uses the  (talk) and  (back) buttons on the steering wheel and a microphone near the map lights on the ceiling.

Voice Recognition

To achieve optimum voice recognition when using the voice control system:



- Make sure the correct screen is displayed for the voice command that you are using.

The system recognizes only certain commands. Available voice commands.

 **Voice Portal Screen** P. 331

- Close the windows and moonroof*.
- Adjust the dashboard and side vents so air does not blow onto the microphone on the ceiling.
- Speak clearly in a clear, natural speaking voice without pausing between words.
- Reduce any background noise if possible. The system may misinterpret your command if more than one person is speaking at the same time.

Voice Control Operation

When you press the  button, a helpful prompt asks what you would like to do. Press and release the  button again to bypass this prompt and give a command.

Voice Recognition

The voice control system can only be used from the driver's seat because the microphone unit removes noises from the front passenger's side.

Voice Portal Screen

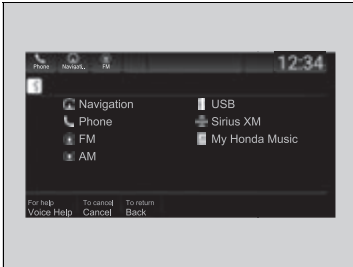

When the  (talk) button is pressed, available voice commands appear on the screen.

For a complete list of commands, say “Voice Help” after the beep.

The system only recognizes the commands on the following pages, at certain screens. Free form voice commands are not recognized.

*1: Models with navigation system

* Not available on all models

Phone

This can only be used when the phone is connected. When the system recognizes the *Phone* command, the screen will change the dedicated screen for the voice recognition of the phone.

- Call <Your Contact Name>
- Call <Phone Number>
- Call <Category>

Phone commands are not available if using Apple CarPlay.

Audio

When the system recognizes the *Audio* command, the screen will change the dedicated screen for the voice recognition of the audio.

- FM
- AM
- USB
- Sirius XM*
- My Honda Music

Navigation*1

The screen changes the navigation screen.

➤ Refer to the Navigation System Manual

Voice Help

Readout voice guidance for Help on current screen.

■ Phone Commands

The system accepts these commands on the dedicated screen for the voice recognition of the phone.

- *Call <Your Contact Name>*
- *Call <Phone Number>*
- *Call <Category>*

■ Audio Commands

The system accepts these commands on the dedicated screen for the voice recognition of the audio.

■ FM Commands

- *Tune to <87.7-107.9> FM*

■ AM Commands

- *Tune to <530-1710> AM*

■ Sirius XM Commands*

- *Channel <1-999>*
- *Channel <station name>*

■ USB/My Honda Music Commands

- *Play Artist*
- *Play Album*
- *Play Genre*
- *Play Playlist*
- *Play Music*
- *Play Song*

Playing AM/FM Radio

The diagram shows a car's audio system interface with the following callouts:

- (Back) Icon**: Select to go back to the previous display.
- VOL/AUDIO (Volume/Power) Knob**: Push to turn the audio system on and off. Turn to adjust the volume.
- Seek Icons**: Select **◀◀** or **▶▶** to search up and down the selected band for a station with a strong signal.
- Tune Icon**: Select to use the on-screen keyboard for entering the radio frequency directly.
- Scan Icon**: Select to scan each station with a strong signal.
- Audio/Information Screen**: The main display area showing radio frequency (87.9), time (12:34), and various icons.
- Settings Icon**: Select whether to tune to HD Radio™* automatically.
- Preset Icons**: Tune the radio frequency for preset memory. Select and hold the preset icon to store that station. Select **>** to display preset 5 onwards.

* Not available on all models

■ Preset Memory

To store a station:

1. Tune to the selected station.
2. Select and hold the preset number for the station you want to store.

■ Station List

Lists the strongest stations on the selected band.

1. Select **Station List** to display a list.
2. Select the station.

■ Manual update

Updates your available station list at any time.

1. Select **Station List** to display a list.
2. Select **Refresh**.

▶▶ Preset Memory

The **ST** indicator appears on the display indicating stereo FM broadcasts. Stereo reproduction in AM is not available.

Switching the Audio Mode

Press the ▲ or ▼ button on the steering wheel or select the audio source icon on the screen.

▶▶ **Audio Remote Controls** P. 279

You can store 12 AM/FM stations into preset memory.

Models with HD Radio™ feature

HD Radio Technology manufactured under license from iBiquity Digital Corporation. U.S. and Foreign Patents. HD Radio™ and the HD, HD Radio, and "Arc" logos are proprietary trademarks of iBiquity Digital Corp.



■ Scan

Samples each of the strongest stations on the selected band for 10 seconds. To turn off scan, select **Stop** or .

■ Radio Data System (RDS)

Provides text data information related to your selected RDS-capable FM station.

■ To find an RDS station from Station List

1. Select **Station List** to display a list while listening to an FM station.
2. Select the station.

■ Manual update

Updates your available station list at any time.

1. Select **Station List** to display a list while listening to an FM station.
2. Select **Refresh**.

■ Scan

Samples each of the strongest stations on the selected band for 10 seconds. To turn off scan, select **Stop** or .

⌘ Radio Data System (RDS)

When you select an RDS-capable FM station, the RDS automatically turns on, and the frequency display changes to the station name. However, when the signals of that station become weak, the display changes from the station name to the frequency.

Models with HD Radio™ feature

■ HD Subchannel

Displays the subchannel list when an HD Radio™ station is selected while listening to an FM station.

1. Select **HD Radio Channels**.
2. Select the channel number.

Playing SiriusXM® Radio *

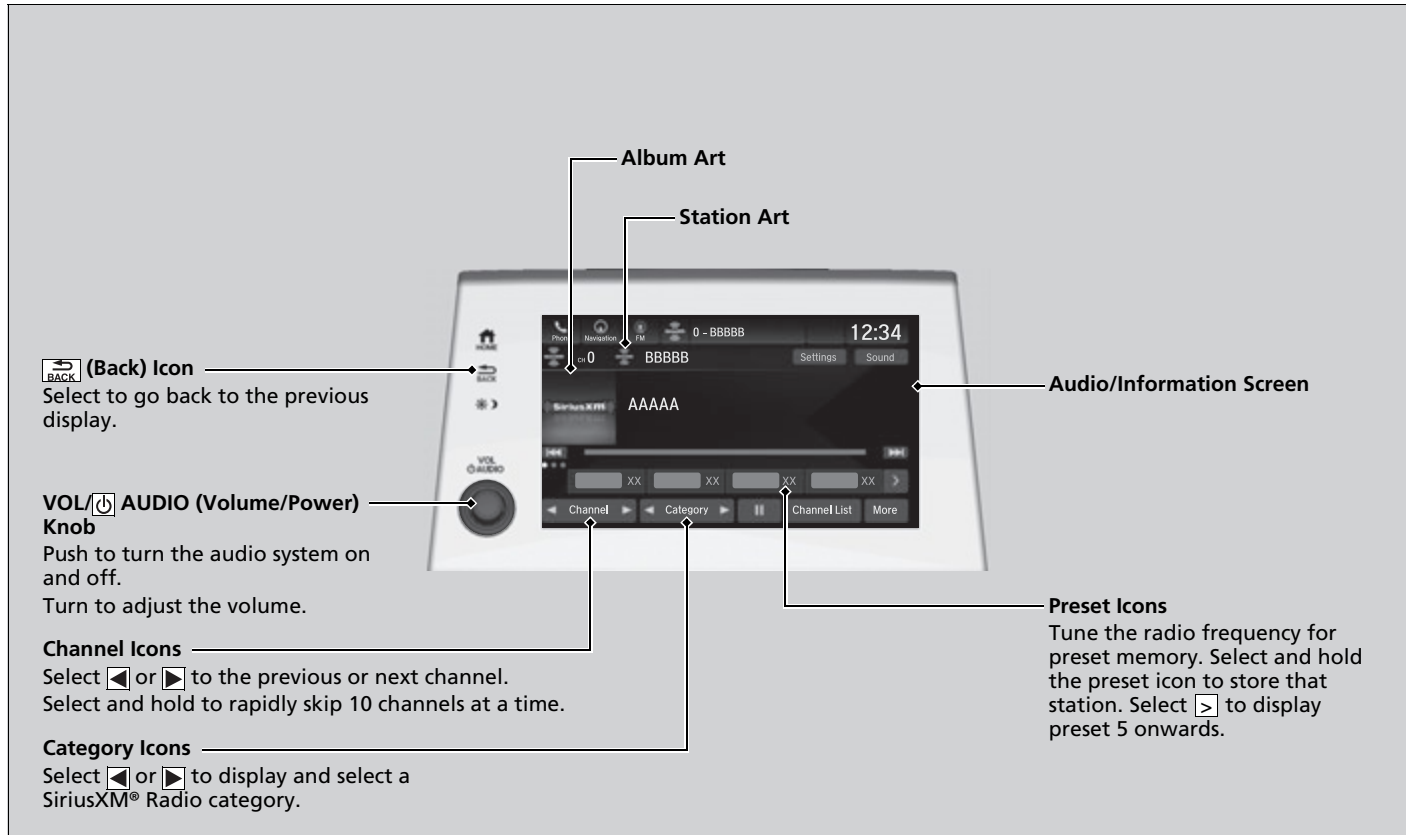

BACK (Back) Icon

Select to go back to the previous display.

VOL/AUDIO (Volume/Power) Knob

Push to turn the audio system on and off.
Turn to adjust the volume.

Channel Icons

Select ◀ or ▶ to the previous or next channel.
Select and hold to rapidly skip 10 channels at a time.

Category Icons

Select ◀ or ▶ to display and select a SiriusXM® Radio category.

Audio/Information Screen

Preset Icons

Tune the radio frequency for preset memory. Select and hold the preset icon to store that station. Select ▶ to display preset 5 onwards.

* Not available on all models

■ To Change the Tune Mode

1. Select **Settings**.
2. Select **Tune Mode**.
3. Select **All Channels** or **Within Category**.

▶▶ Playing SiriusXM® Radio*

In the channel mode, all available channels are selectable. In the category mode, you can select a channel within a category (Jazz, Rock, Classical, etc.).

There may be instances when SiriusXM® Radio does not broadcast all the data fields (artist name, title). This does not indicate a problem with your audio system.

SiriusXM® Radio stations load in ascending order, which can take about a minute. Once they have loaded you will be able to scroll up or down to make your selections.

Switching the Audio Mode

Press the ▲ or ▼ button on the steering wheel or select the audio source icon on the screen.

▶▶ **Audio Remote Controls** P. 279

Tune Start:

When you change to a preset channel, a song being played on that channel restarts from the beginning with this function. This can be turned on or off by the following procedure.

1. Select **Settings**.
2. Select **Tune Start**.
3. Select **ON** or **OFF**.

To change a category, select **Category** icons, or select **More** and then select **Category List**.

■ Preset Memory

To store a channel:

1. Tune to the selected channel.
2. Select and hold the preset number for the station you want to store.

■ Multi-channel preset (for music channels only)

You can store up to 10 of your preferred music channels per preset.



1. Tune a station.
2. Select and hold the preset number you want to add a music channel.
3. Select **Add to TuneMix** or **Create TuneMix**.
 - ▶ A message appears if there are no available presets.

▣ Preset Memory

You can store 12 SiriusXM® channels into the preset memory.

▣ Multi-channel preset (for music channels only)

TuneMix:

The multi-channel preset function can be turned on or off by the following procedure.

1. Select **Settings**.
2. Select **TuneMix**.
3. Select **ON** or **OFF**.

When you want to replace the channel, select **Replace Preset**.

If you want to delete a channel, select **Edit TuneMix**, and then select the channel you want to delete.

■ Listening to Featured Channels

Suggested channel listing received from SiriusXM® can be displayed and selected.

1. Select **Channel List**.
2. Select the featured channel list title you want to listen to.
 - ▶ The selected channel list of the title is displayed.
3. Select the channel.

▶▶ Listening to Featured Channels

Up to three featured channels by SiriusXM® can be displayed.



Featured channel lists are at the top of the channel list.

To switch the sorting method, select **Number, Name** or **Category** on the upper right of the screen.

Select **Keypad** to use the on-screen keyboard for entering the channel number directly.

■ Replay Function

The system can record up to the last 60 minutes broadcast of your currently tuned channel as well as the last 30 minutes broadcast of preset channels, starting from the moment you turn the vehicle on. If you tuned to preset channel, the system records up to 60 minutes of a broadcast instead of up to 30 minutes. You can rewind and replay the last 30 or 60 minutes of a broadcast.

Move the position you want to replay by selecting  or .

To play or pause on playback mode, select the play/pause icon.

■ Returning to real-time broadcast

Select and hold .

▶▶ Replay Function

The system starts storing broadcast in memory when the power mode is turned ON. You can go back to the program from that point.

You can no longer replay any program once the power mode is turned off as it erases memory. You can check how long the program has been stored in memory from the audio/information screen.

After 30 or 60 minutes of recording the system will automatically start deleting the oldest data.

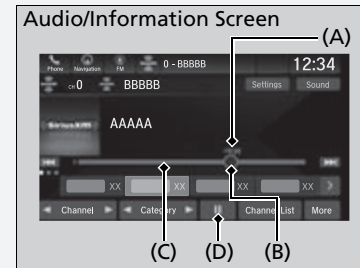

(A): Shows how much time the replayed segment is behind the real-time broadcast

(B): Replayed segment

(C): Length stored in memory

(D): Play/Pause icon

■ Live Sports Alert

While listening to other channel, you can receive sports alerts such as scores from your favorite teams.

■ To set up a favorite team

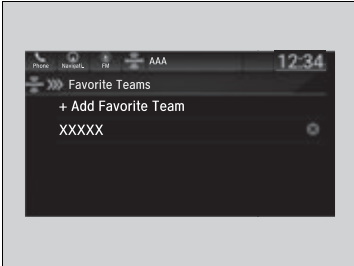

1. Select **Settings**.
2. Select **Sports Notifications Setup**.
3. Select **Favorite Teams**.
4. Select **+ Add Favorite Team**.
5. Select a team.

■ To set up an alert message

1. Select **Settings**.
2. Select **Sports Notifications Setup**.
3. Select **Notifications**.
4. Select **Game Notifications** or **SportsFlash Game Play Notifications**.
5. Select **Notifications**.
6. Select **On**.
7. Select a favorite team.

▶▶ Live Sports Alert

The sports alert function at SiriusXM® mode only.

▶▶ To set up a favorite team

Sports alerts cut in only when SiriusXM® mode is on.

■ Traffic and Weather Information

You can receive traffic and weather information.

1. Select **Settings**.
2. Select **Traffic & Weather Setup**.
3. Select **Selected City**.
4. Select the region.
 - ▶ When you do not want to receive the information, select **Reset Location**.

☒ Traffic and Weather Information

The traffic and weather information function at SiriusXM® mode only.

Continued

■ Channel Schedule

You can view a channel schedule or receive a alert when your favorite program is about to start.

■ To view a channel schedule

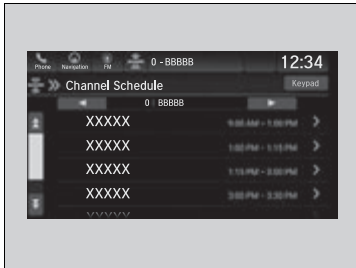

1. Select **More**.
2. Select **Channel Schedule**.

■ To set up an alert message

1. Select **More**.
2. Select **Channel Schedule**.
3. Select a program.
4. Select **Set Program Alert**.
5. Select **Just Once** or **Every Time**.

▶ Channel Schedule

Select **Keypad** to use the on-screen keyboard for entering the channel number directly.

▶ To set up an alert message

The alert function at SiriusXM® mode only.

Selecting **Just Once** disables the alert feature next time you turn the power mode to ON.

If you want to delete the alert, select **Remove Alert**.

Manage Program Alert

You can change settings for the alert function.

To enable the alert function

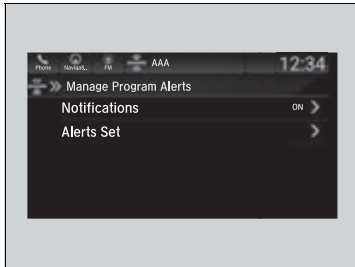

1. Select **Settings**.
2. Select **Manage Program Alerts**.
3. Select **Notifications**.
4. Select **ON** or **OFF**.

To remove an alert

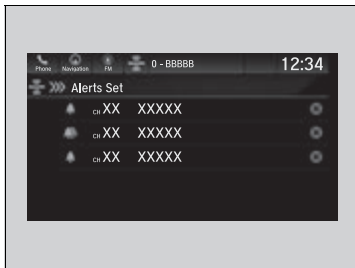

1. Select **Settings**.
2. Select **Manage Program Alerts**.
3. Select **Alerts Set**.
4. Select  on the alert you want to delete.
 - ▶ A confirmation message appears on the screen. Select **Delete**.

■ Scan

Sample each channel on the selected mode for 10 seconds.

1. Select **More**.
2. Select **Scan**.

You can change a scan mode by the following procedure.

1. Select **Settings**.
2. Select **Scan Mode**.
3. Select **Channel** or **Preset**.

To turn off scan, select **Stop**.

▶▶ Scan

The “Scan Songs in Presets” function is based on TuneScan™ technology of SiriusXM®.

The “Featured Channels” function is based on Featured Favorites™ technology of SiriusXM®.

TuneScan™ and Featured Favorites™ are registered trademarks of SiriusXM® Radio, Inc.

Playing a CD*

Your audio system supports audio CDs, CD-Rs, and CD-RWs in either MP3, WMA, or AAC*1 format. With the CD loaded, select the CD mode.

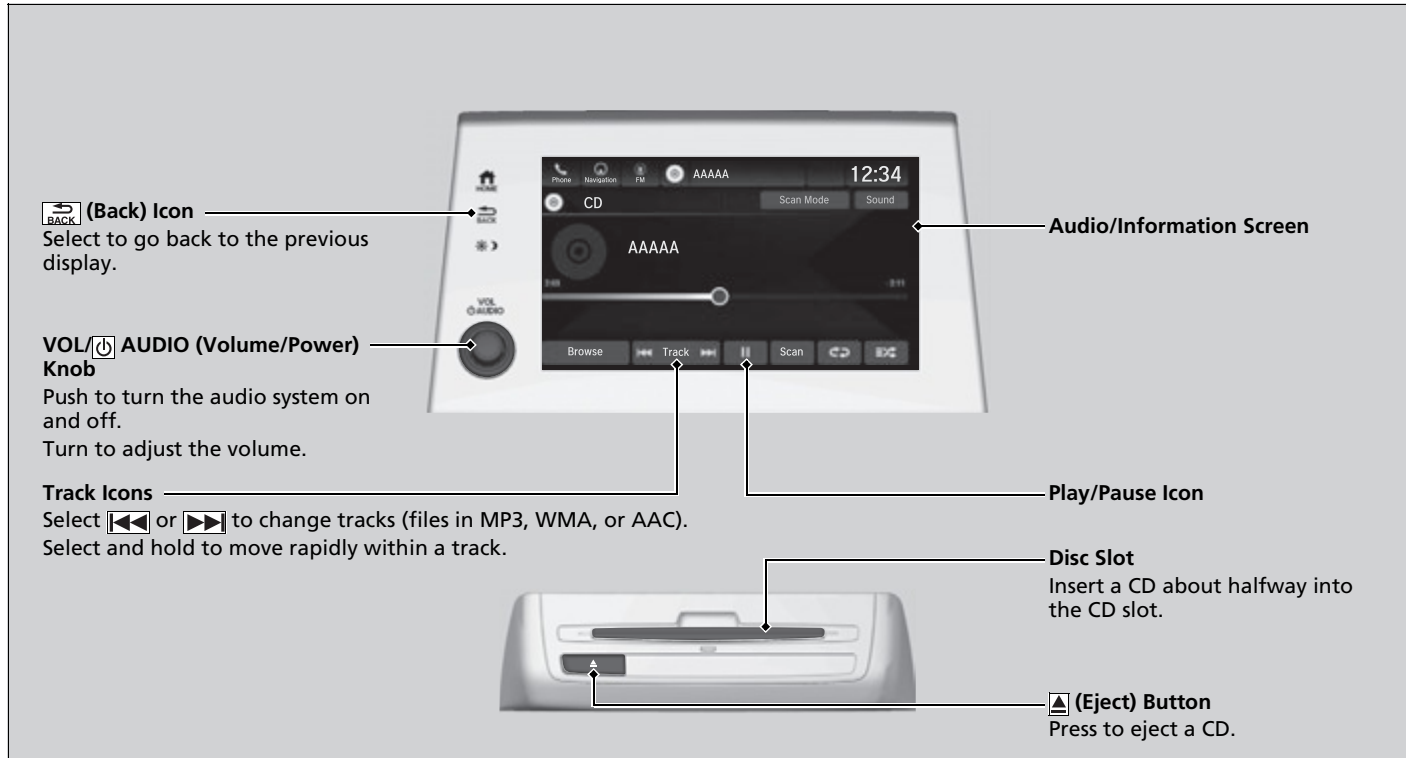

*1: Only AAC format files recorded with iTunes are playable on this unit.

* Not available on all models

How to Select a File from the Music Search List

Browse Screen

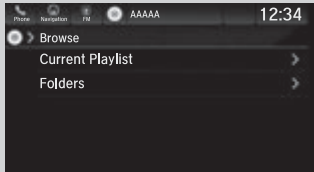

Track List Screen



If there is a folder(s) on a CD:

1. Select **Browse**.
2. Select **Current Playlist**, or **Folders** then a folder.
3. Select a track.

If there is no folder on a CD:

1. Select **Track List**.
2. Select a track.

▶▶ Playing a CD*

NOTICE

Do not use CDs with adhesive labels. The label can cause the CD to jam in the unit.

WMA files protected by digital rights management (DRM) cannot be played.

The audio system displays **Selected file cannot be played on this system**, then skips to the next file.

Text data appears on the display under the following circumstances:

- When you select a new folder, file, or track.
- When you change the audio mode to CD.
- When you insert a CD.

If you eject the CD but do not remove it from the slot, the system reloads the CD automatically after several seconds.

How to Select a Play Mode

You can select scan, repeat, and random modes when playing a track or file.

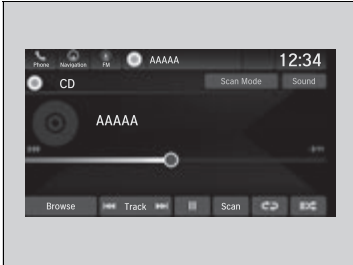

■ Scan

Select **Scan**.

- ▶ If there is a folder(s) on a CD, you can select **Current folder** or **First Track in All Folders**.

To turn off scan, select **Stop**.

■ Random/Repeat

Cycles through the modes as follows:

Random

 (off) →  →  (highlighted)

Repeat

 (off) →  → 

How to Select a Play Mode

Play Mode Menu Items

Scan

Select **Scan Mode**, and then select the following:

First Track in All Folders (MP3/WMA/AAC):

Provides 10-second sampling of the first file in each of the main folders.

Current folder: Provides 10-second sampling of all tracks on the CD (all files in the current folder in MP3, WMA, or AAC).

Random/Repeat

 **Random in Folder** (MP3/WMA/AAC): Plays all files in the current folder in random order.

 **Random All Tracks**: Plays all tracks/files in random order.

 **Repeat Folder** (MP3/WMA/AAC): Repeats all files in the current folder.

 **Repeat Track**: Repeats the current track/file.

Playing an iPod

Connect the iPod using your USB connector to the USB port, then select the USB mode.

➤ **USB Ports** P. 275

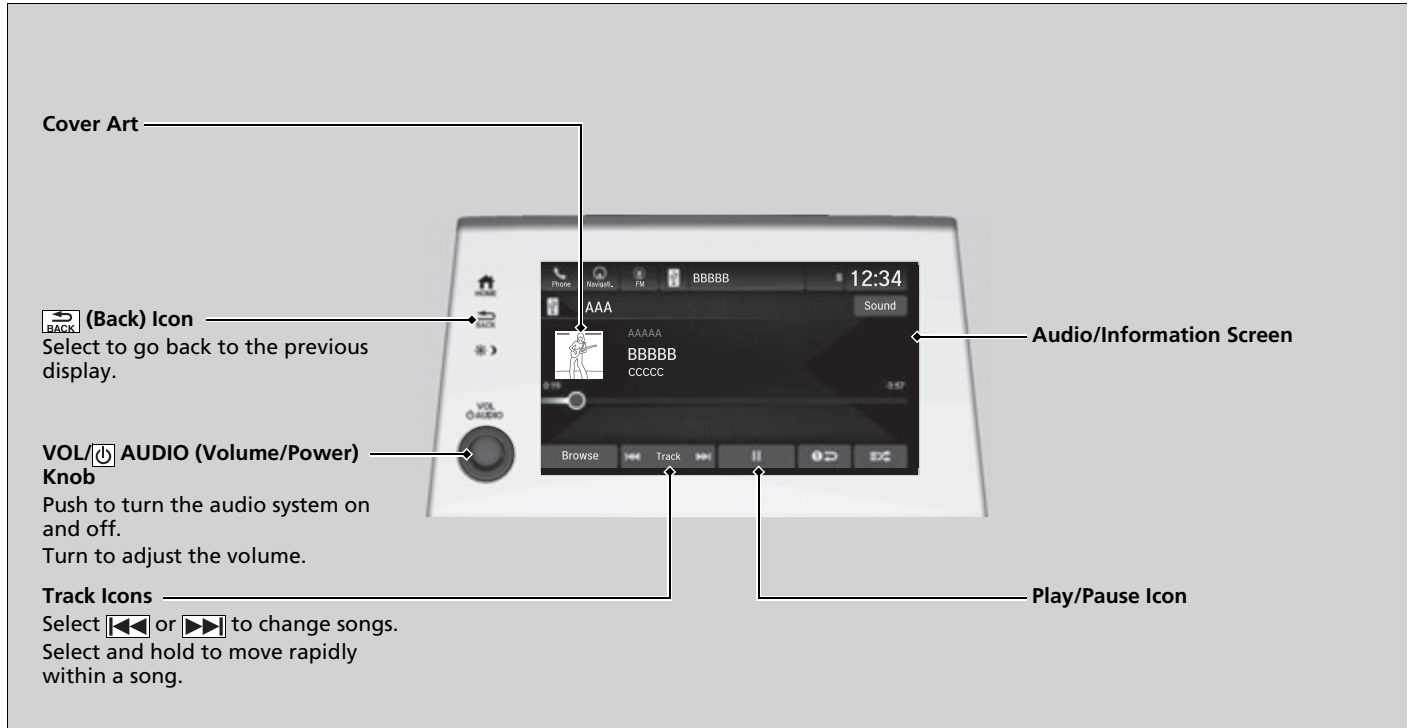

How to Select a Song from the Music Search List

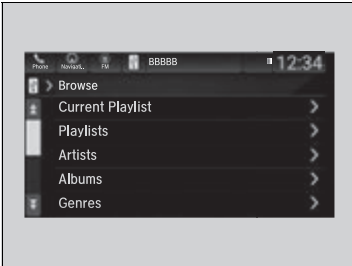

1. Select **Browse**.
2. Select the items on that menu.

▶▶ Playing an iPod

Available operating functions vary on models or versions. Some functions may not be available on the vehicle's audio system.

If there is a problem, you may see an error message on the audio/information screen.

▶▶ **iPod/USB Flash Drive** P. 382

If you operate the music app on your iPhone/iPod while the phone is connected to the audio system, you may no longer be able to operate the same app on the audio/information screen.

Reconnect the device if necessary.

If an iPhone is connected via Apple CarPlay, the iPod/USB source will be unavailable and audio files on the phone will be playable only within Apple CarPlay.

■ How to Select a Play Mode

You can select shuffle and repeat modes when playing a file.

Select  or .

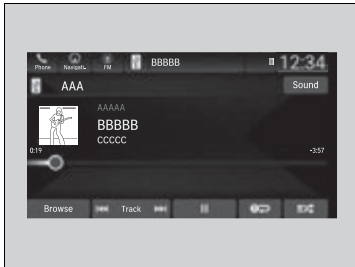

■ To turn off a play mode

Select the mode you want to turn off.

▶▶ How to Select a Play Mode

Play Mode Menu Items

 **Shuffle All Songs:** Plays all available files in a selected list (playlists, artists, albums, songs, podcasts, genres, composers, or audiobooks) in random order.

 **Repeat Song:** Repeats the current track.

Playing a USB Flash Drive

Your audio system reads and plays audio files on a USB flash drive in either MP3, WMA, or AAC*1 format.

Connect your USB flash drive to the USB port, then select the USB mode.

📖 **USB Ports** P. 275

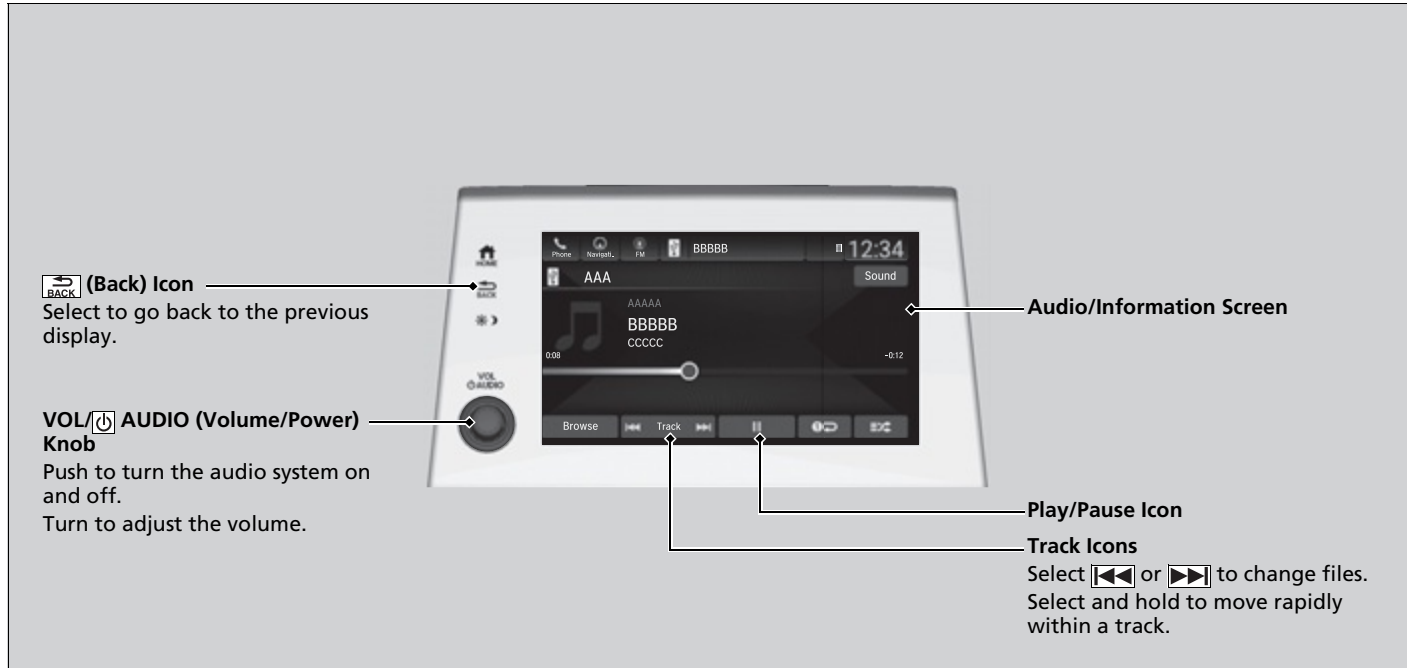

*1: Only AAC format files recorded with iTunes are playable on this unit.

How to Select a File from the Music Search List

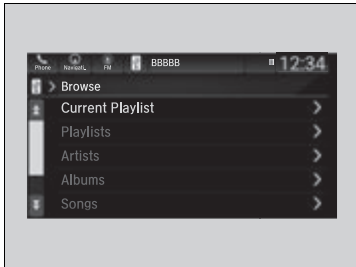

1. Select **Browse**.
2. Select the items on that menu.

▶▶ Playing a USB Flash Drive

Use the recommended USB flash drives.

▶ **General Information on the Audio System**
P. 385

WMA files protected by digital rights management (DRM) cannot be played.

The audio system displays **The selected file cannot be played on this system**, then skips to the next file.

If there is a problem, you may see an error message on the audio/information screen.

▶ **iPod/USB Flash Drive** P. 382

■ How to Select a Play Mode

You can select repeat and random modes when playing a file.

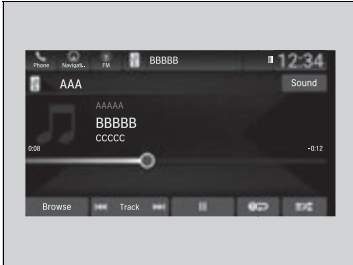

■ Random/Repeat

Select  or .

■ To turn off a play mode

Select the mode you want to turn off.

▶▶ How to Select a Play Mode

Play Mode Menu Items

Random/Repeat

 **Random in Category:** Plays all files in the current category in random order.

 **Repeat Track:** Repeats the current file.

Playing My Honda Music

My Honda Music plays audio files that have been imported from a USB flash drive.

Your audio system supports audio files in either MP3, WMA, or AAC*1 format.

➤ **File Manager** P. 321

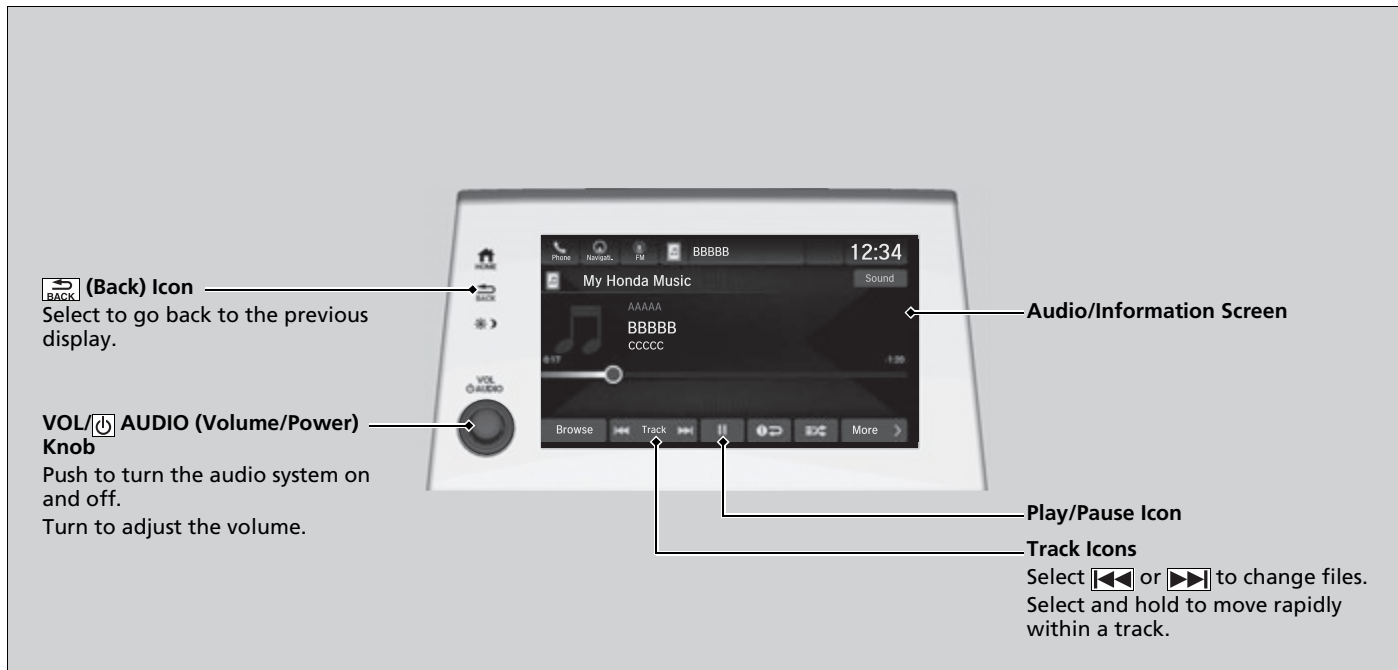

*1: Only AAC format files recorded with iTunes are playable on this unit.

How to Transfer an Audio File

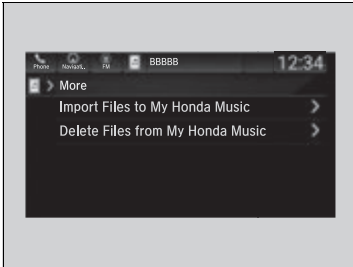

1. Connect a USB device into the USB port.
 ▶ **USB Ports** P. 275
2. Select **More**.
3. Select **Import Files to My Honda Music**.
 ▶ The **File Manager** screen is displayed.
4. Transfer an audio file to your audio system.
 ▶ **How to Transfer a File** P. 321

How to delete an audio file

1. Select **More**.
2. Select **Delete Files from My Honda Music**.
 ▶ The **File Manager** screen is displayed.
3. Delete an audio file.
 ▶ **How to Delete a File** P. 324

How to Transfer an Audio File

If there is no audio file in your audio system, the system will automatically proceed to step 3 after connecting a USB device.

Use the recommended USB flash drives.

▶ **General Information on the Audio System**
 P. 385

Continued

■ How to Select a File from the Music Search List

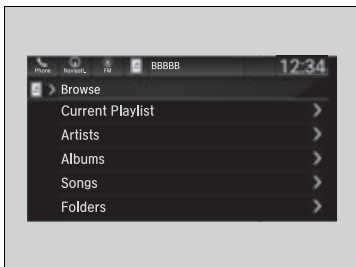

1. Select **Browse**.
2. Select the items on that menu.

▶▶ Playing My Honda Music

WMA files protected by digital rights management (DRM) cannot be played.

The audio system displays **The selected file cannot be played on this system**, then skips to the next file.

■ How to Select a Play Mode

You can select repeat and random modes when playing a file.

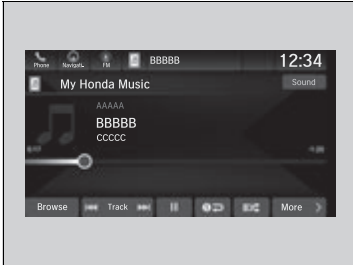

■ Random/Repeat

Select  or .

■ To turn off a play mode

Select the mode you want to turn off.

▶▶ How to Select a Play Mode

Play Mode Menu Items

Random/Repeat

 **Random in Category:** Plays all files in the current category in random order.

Random All Tracks: Plays all files in random order.

 **Repeat Track:** Repeats the current file.

Playing *Bluetooth*® Audio

Your audio system allows you to listen to music from your *Bluetooth*-compatible phone.

This function is available when the phone is paired and connected to the vehicle's *Bluetooth*® HandsFreeLink® (HFL) system.

📄 **Phone Setup** P. 515

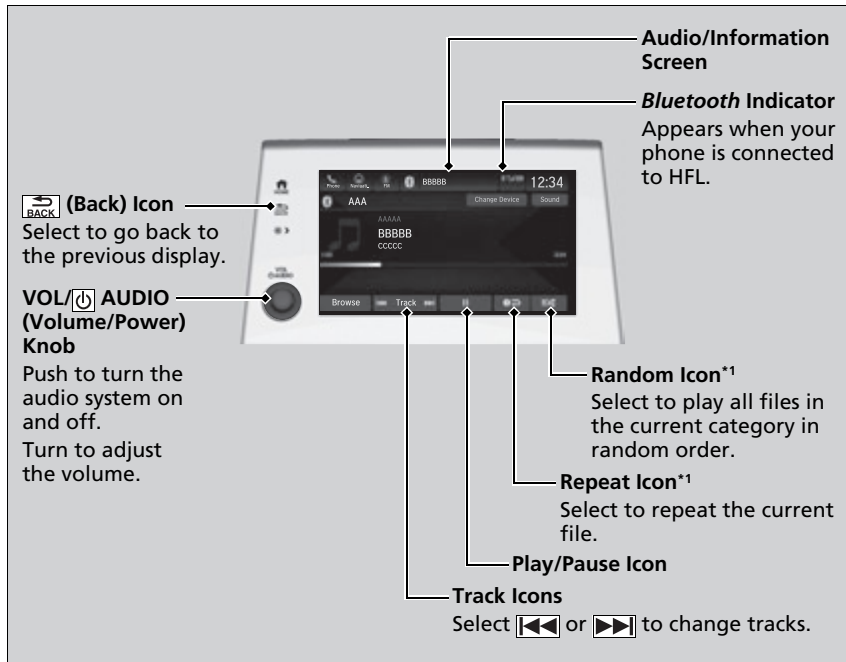

*1: Depending on the *Bluetooth*® device you connect, this function may not be displayed.

▶▶ Playing *Bluetooth*® Audio

Not all *Bluetooth*-enabled phones with streaming audio capabilities are compatible with the system. To check if your phone is compatible, visit <http://www.handsfreelink.com/Honda/>.

It may be illegal to perform some data device functions while driving.

Only one phone can be used with HFL at a time. When there are more than two paired phones in the vehicle, the first paired phone the system finds is automatically connected.

The connected phone for *Bluetooth*® Audio can be different.

If more than one phone is paired to the HFL system, there may be a delay before the system begins to play.

In some cases, the name of the artist, album, or track may not appear correctly.

Some functions may not be available on some devices.

If a phone is currently connected via Apple CarPlay or Android Auto, *Bluetooth*® Audio from that phone will be unavailable. However, you can have a second previously paired phone stream *Bluetooth*® Audio by selecting [📱] from the *Bluetooth*® device list.

📄 **Phone Setup** P. 515

■ To Play *Bluetooth*® Audio Files

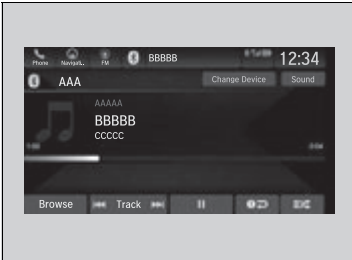

1. Make sure that your phone is paired and connected to the system.

➤ **Phone Setup** P. 515

2. Select the *Bluetooth*® Audio mode.

If the phone is not recognized, another HFL-compatible phone, which is not compatible for *Bluetooth*® Audio, may already be connected.

■ To pause or resume a file

Select the play/pause icon.

■ Searching for Music

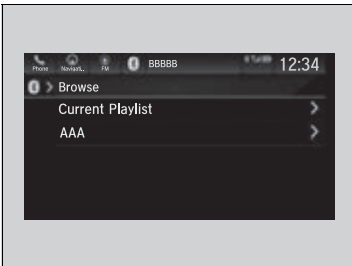

1. Select **Browse**.

2. Select a search category (e.g., Albums).

3. Select an item.

▶ The selection begins playing.

☒ To Play *Bluetooth*® Audio Files

To play the audio files, you may need to operate your phone. If so, follow the phone maker's operating instructions.

Switching to another mode pauses the music playing from your phone.

You can change the connected phone by selecting **Change Device**.

➤ **Phone Setup** P. 515

☒ Searching for Music

Depending on the *Bluetooth*® device you connect, some or all of the lists may not be displayed.

Playing Social Playlist

The Honda CabinControl® smartphone app allows users to share audio files from their devices to Social Playlist.

The driver cannot select the audio files from the audio/information screen. The driver can play in order of their choice only if they individually select each song in the queue. The driver cannot rearrange the order of the playlist.

📶 **Wi-Fi Connection** P. 369

▶▶ Playing Social Playlist

For more information, check the Honda CabinControl smartphone app instruction manual.

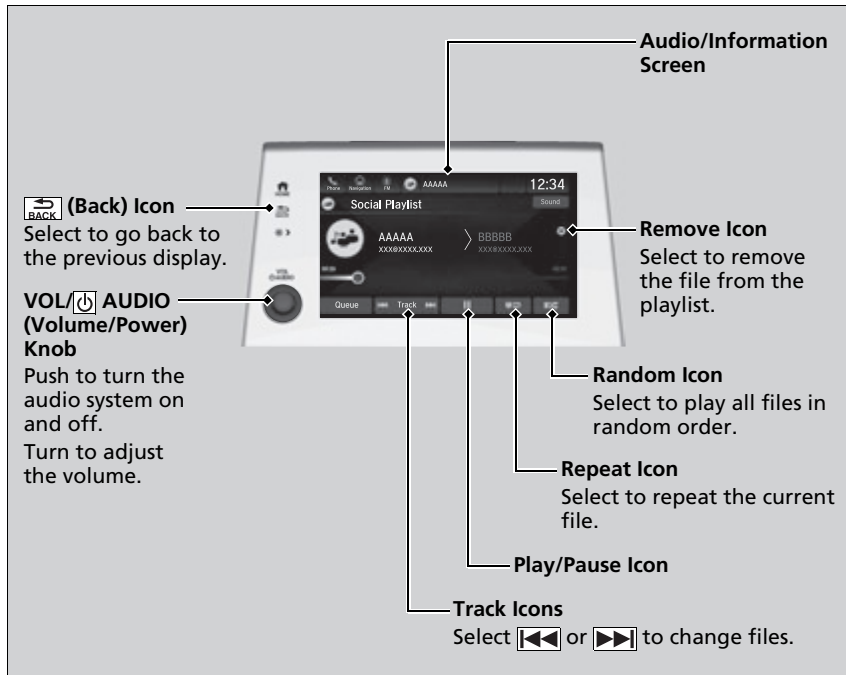

How to Edit the Playlist

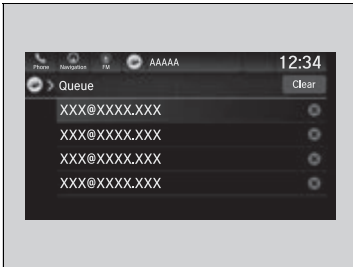

1. Select .

2. Select **Social Playlist**.

3. Select **Queue**.

To play a file on the playlist:

▶ Select the file.

To remove a file from the playlist:

▶ Select  on the file.

To clear the playlist:

▶ Select **Clear**, and then select **Request Songs** to reload a playlist.

To check the connected device:

▶ Select **Device List**.

HondaLink®

HondaLink® connects you to the latest information from Honda. You can connect your phone wirelessly through Wi-Fi or *Bluetooth*®.

➔ **Wi-Fi Connection** P. 369

➔ **Phone Setup** P. 515

To Connect to HondaLink® Service

Use the following procedure to connect to HondaLink® service.

■ To enable the HondaLink® service

You need to allow the consent of the location service to enable the HondaLink® service.

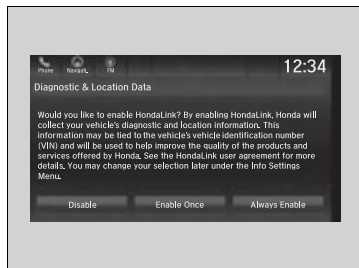

Disable: Does not allow this consent.

Enable Once: Allows only one time. (Shows again next time.)

Always Enable: Allows anytime. (Never show again.)

▶▶ HondaLink®

The HondaLink® connect app is compatible with most iPhone and Android phones.

Some cell phone carriers charge for tethering and smartphone data use. Check your phone's data subscription package.

When Apple CarPlay or Android Auto is connected to the audio system, HondaLink® can be accessed even without a Wi-Fi connection.

■ **To link with HondaLink®**

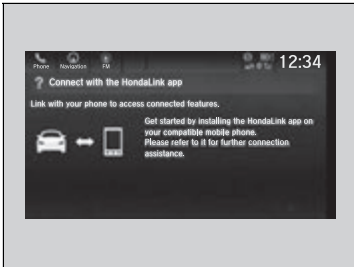

You may see the connection guide screen after launching HondaLink® when there is no connection available.

■ **HondaLink® Menu**

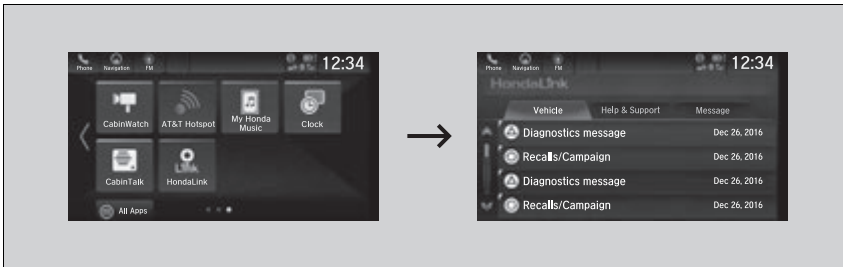

■ **Vehicle**

Displays instruction messages when the vehicle needs service.

■ **Help & Support**

Displays tips for vehicle usage, and get support via road side or customer service center.

■ Messages from Honda

Displays helpful and important information from Honda.

■ Vehicle Information and Message from Honda Tips

You can check the messages that are received quickly in the shortcut operation.

1. A notification appears and notifies you of a new message on the header area.



2. A notification is continuously displayed in the header area until the new message is read.





3. Select the system status icon to see the messages.

4. Select a new message to open.

■ Operator Assistance*

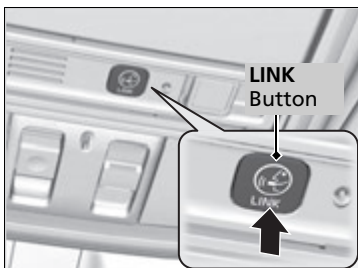
Connect to the HondaLink® operator when trying to find a destination or for roadside assistance.



1. Press the **LINK** button.
 - ▶ Connection to the operator begins.
2. Talk to the operator.
 - ▶ To disconnect, select **Hang Up** on the audio/information screen or press the  button on the steering wheel.

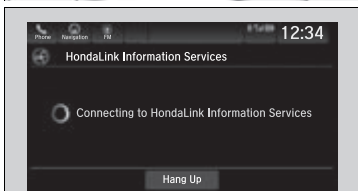

Audio/information screen when connected to the HondaLink® operator.

▶▶ Operator Assistance*

Remain attentive to road conditions and driving during operator assistance.

If you want to add or renew a subscription, call the Operator Assistance.



1. Select .
2. Select **Settings**.
3. Select **System**.
4. Select **Subscription**.
5. Select **HondaLink Subscription Status**.

Wi-Fi Connection

You can connect the audio system to the Internet using Wi-Fi and browse websites or use online services on the audio/information screen. If your phone has cell hotspot capabilities, the system can be tethered to the phone. Use the following steps to setup.

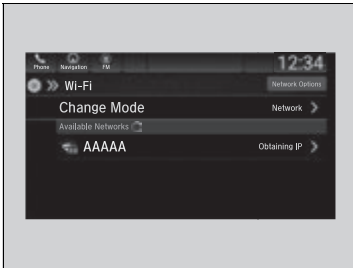
Wi-Fi mode (setting for the first time)



1. Select .
2. Select **Settings**.
3. Select **Connections**.
4. Select **Wi-Fi**.
5. Select **Change Mode**.
6. Select **Network** or **HotSpot**, then **Save**.
 - ▶ To change the Wi-Fi settings, select **Network Options** or **HotSpot Options**.
 - ▶ Select the access point you want to connect to the system.
7. Select **Connect**.
 - ▶ Enter a password for the access point, and select **OK**.
 - ▶ When the connection is successful, the  icon is displayed on the list.
8. Select  to go back to the home screen.

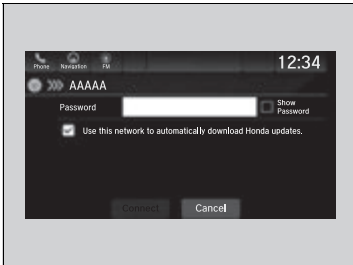

Wi-Fi Connection

Wi-Fi and Wi-Fi Direct a registered trademark of Wi-Fi Alliance®.



Wi-Fi mode (setting for the first time)

You cannot go through the setting procedure while a vehicle is moving. Park in a safe place to setup the Wi-Fi connection.

Some cell phone carriers charge for tethering and smartphone data use. Check your phone's data subscription package.

Check your phone manual to find out if the phone has Wi-Fi connectivity.

You can confirm whether Wi-Fi connection is on or off with the  icon on the Wi-Fi network list. Transmission speed and others will not be displayed on this screen.

In case of Wi-Fi connection with your phone, make sure your phone's Wi-Fi setting is in access point (tethering) mode.

Continued

■ Wi-Fi mode (after the initial setting has been made)

Make sure your phone's Wi-Fi setting is in access point (tethering) mode.

▶▶ Wi-Fi mode (after the initial setting has been made)

iPhone users

You may need to go through an initial setup for Wi-Fi connection again after you boot your phone.

AT&T Hotspot*

If you have subscribed to AT&T hotspot services, your vehicle will provide data to connect your mobile devices to the Internet. You can use the AT&T Hotspot app to turn on/off vehicle data and monitor data usage left on your subscription.

■ AT&T Hotspot Menu

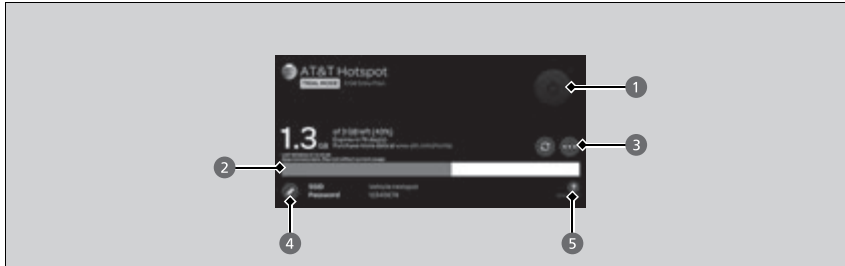

① Hotspot Enable

Turn on/off AT&T Hotspot.

② Data Usage Bar

Check the current status of your data plan. This Usage Bar will show your current plan and how much data remains on your plan. Subscription plans for AT&T Hotspot can be added/modified at www.att.com/honda.

③ Refresh and Plan Info

Refreshes screen to show data remaining.

Shows your current AT&T subscription plan for the vehicle.

④ Edit Hotspot Properties

Shows the current username and password for vehicle Hotspot. Hotspot settings can be changed while the vehicle is not in motion.

⑤ Help

☒ AT&T Hotspot*

To use AT&T Hotspot services, your vehicle must be subscribed to a data plan. If your vehicle is not subscribed to a data plan, you can visit www.att.com/honda to add vehicle data services.

Hotspot username and password can be changed in the Edit Hotspot Properties of the AT&T Hotspot app. Settings can not be accessed while driving. Park in a safe place to adjust Hotspot settings.

Alternatively, you can use your mobile hotspot to connect the vehicle and other mobile devices to the Internet.

☒ **Wi-Fi Connection** P. 369

* Not available on all models

Siri Eyes Free

You can talk to Siri using the  (Talk) button on the steering wheel when your iPhone is paired to the *Bluetooth*® HandsFreeLink® (HFL) system.

➔ **Phone Setup** P. 515

❏ Siri Eyes Free

Siri is a trademark of Apple Inc.

Check Apple Inc. website for features available for Siri.

While driving we recommend only using Siri through the  button on the steering wheel (Siri Eyes Free).

❏ Using Siri Eyes Free

Some commands work only on specific phone features or apps.

■ Using Siri Eyes Free

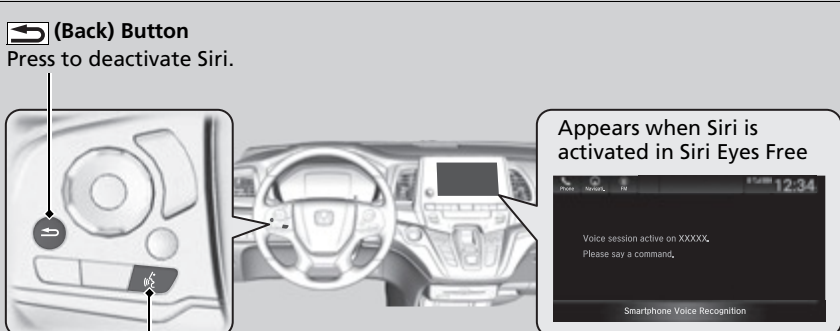

 **(Back) Button**
Press to deactivate Siri.

 **(Talk) Button**
Press and hold until the display changes as shown.

Appears when Siri is activated in Siri Eyes Free

Voice session active on XXXXX.
Please say a command.

Smartphone Voice Recognition

While in Siri Eyes Free:
The display remains the same.
No feedback or commands appears.

Apple CarPlay

If you connect an Apple CarPlay-compatible iPhone to the system via the USB port, you can use the audio/information screen, instead of the iPhone display, to make a phone call, listen to music, view maps (navigation), and access messages.

📄 **USB Ports** P. 275

■ Apple CarPlay Menu

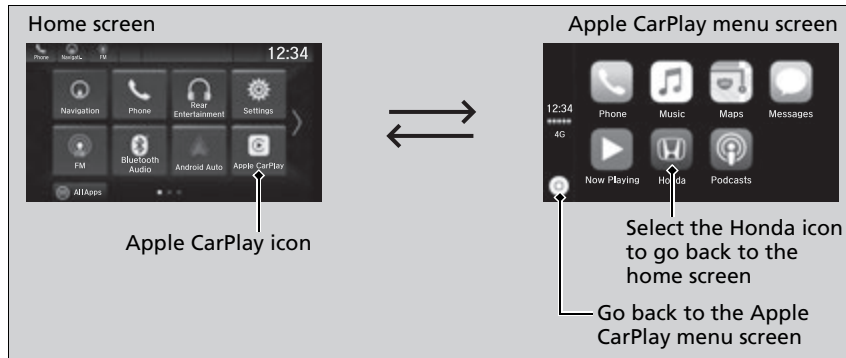

■ Phone

Access the contact list, make phone calls, or listen to voice mail.

■ Messages

Check and reply to text messages, or have messages read to you.

■ Music

Play music stored on your iPhone.

▶▶ Apple CarPlay

Only iPhone 5 or newer versions with iOS 8.4 or later are compatible with Apple CarPlay.

Park in a safe place before connecting your iPhone to Apple CarPlay and when launching any compatible apps.

To use Apple CarPlay, connect the USB cable to the USB port located in the console compartment. Other USB ports will not enable Apple CarPlay operation.

📄 **USB Ports** P. 275

While connected to Apple CarPlay, calls are only made through Apple CarPlay. If you want to make a call with HandsFreeLink, turn Apple CarPlay OFF or detach the USB cable from your iPhone.

📄 **Setting Up Apple CarPlay** P. 374

When your iPhone is connected to Apple CarPlay, it is not possible to use the *Bluetooth*® Audio or *Bluetooth*® HandsFreeLink®. However, other previously paired phones can stream audio via *Bluetooth*® while Apple CarPlay is connected.

📄 **Phone Setup** P. 515

For details on countries and regions where Apple CarPlay is available, as well as information pertaining to function, refer to the Apple homepage.

■ Maps

Display Apple Maps and use the navigation function just as you would on your iPhone.

Models with navigation system

Only one navigation system (pre-installed navigation or Apple CarPlay) can give directions at a time. When you are using one system, directions to any prior destination set on the other system will be canceled, and the system you are currently using will direct you to your destination.

■ Setting Up Apple CarPlay

After you have connected your iPhone to the system via the USB port, use the following procedure to set up Apple CarPlay. Use of Apple CarPlay will result in the transmission of certain user and vehicle information (such as vehicle location, speed, and status) to your iPhone to enhance the Apple CarPlay experience. You will need to consent to the sharing of this information on the audio/information screen.

■ Enabling Apple CarPlay

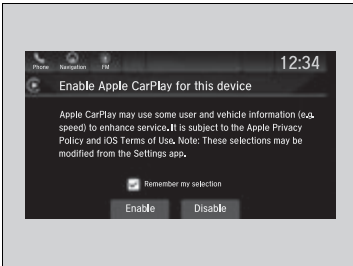

Enable: Allows this consent.

Disable: Does not allow this consent.

You may change the consent settings under the **Connections** settings menu.

▶▶ Apple CarPlay

Apple CarPlay Operating Requirements & Limitations

Apple CarPlay requires a compatible iPhone with an active cellular connection and data plan. Your carrier's rate plans will apply.

Changes in operating systems, hardware, software, and other technology integral to providing Apple CarPlay functionality, as well as new or revised governmental regulations, may result in a decrease or cessation of Apple CarPlay functionality and services. Honda cannot and does not provide any warranty or guarantee of future Apple CarPlay performance or functionality.

It is possible to use 3rd party apps if they are compatible with Apple CarPlay. Refer to the Apple homepage for information on compatible apps.

▶▶ Setting Up Apple CarPlay

You can also use the method below to set up Apple CarPlay:

Select HOME→Settings→Connections→Apple CarPlay

Use of user and vehicle information

The use and handling of user and vehicle information transmitted to/from your iPhone by Apple CarPlay is governed by the Apple iOS terms and conditions and Apple's Privacy Policy.

■ Operating Apple CarPlay with Siri

Press and hold the talk button to activate Siri.

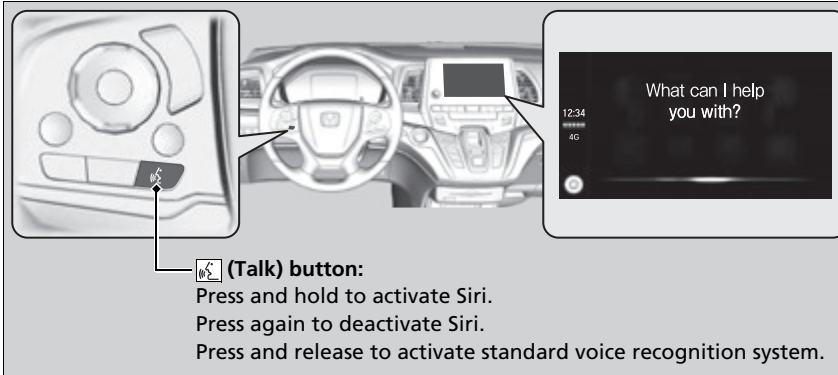

☒ Operating Apple CarPlay with Siri

Below are examples of questions and commands for Siri:

- What movies are playing today?
- Call dad at work.
- What song is this?
- How's the weather tomorrow?
- Read my latest email.
- Find a table for four tonight in Chicago.

For more information, please visit www.apple.com/ios/siri.

Android Auto

When you connect an Android phone to the audio system via the USB port, Android Auto is automatically initiated. When connected via Android Auto, you can use the audio/information screen to access the Phone, Google Maps (Navigation), Google Play Music, and Google Now functions. When you first use Android Auto, a tutorial will appear on the screen.

We recommend that you complete this tutorial while safely parked before using Android Auto.

📄 **USB Ports** P. 275

📄 **Auto Pairing Connection** P. 378

📄 Android Auto

To use Android Auto, you need to download the Android Auto app from Google Play to your smartphone.

Only Android 5.0 (Lollipop) or later versions are compatible with Android Auto. *Bluetooth* A2DP cannot be used while your phone is connected to Android Auto.

Park in a safe place before connecting your Android phone to Android Auto and when launching any compatible apps.

To use Android Auto, connect the USB cable to the USB port located in the console compartment. Other USB ports will not enable Android Auto operation.

📄 **USB Ports** P. 275

To directly access the Android Auto phone function, press **Phone** on the home screen.

📄 **Auto Pairing Connection** P. 378

When your Android phone is connected to Android Auto, it is not possible to use the *Bluetooth*® Audio. However, other previously paired phones can stream audio via *Bluetooth*® while Android Auto is connected.

📄 **Phone Setup** P. 515

Android Auto Menu

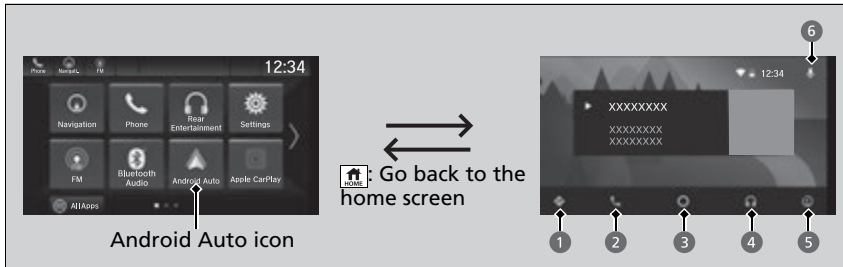

1 Maps (Navigation)

Display Google Maps and use the navigation function just as you would with your Android phone. When the vehicle is in motion, it is not possible to make keyboard entries. Stop the vehicle in a safe location to undertake a search or provide other inputs.

Models with navigation system

Only one navigation system (pre-installed navigation or Android Auto) can give directions at a time. When you are using one system, directions to any prior destination set on the other system will be canceled, and the system you are currently using will direct you to your destination.

The audio/information screen shows you turn-by-turn driving directions to your destination.

2 Phone (Communication)

Make and receive phone calls as well as listen to voicemail.

3 Google Now (Home screen)

Display useful information organized by Android Auto into simple cards that appear just when they're needed.

Android Auto

For details on countries and regions where Android Auto is available, as well as information pertaining to function, refer to the Android Auto homepage.

Screens may differ depending on the version of the Android Auto app you are using.

Android Auto Operating Requirements & Limitations

Android Auto requires a compatible Android phone with an active cellular connection and data plan. Your carrier's rate plans will apply.

Changes in operating systems, hardware, software, and other technology integral to providing Android Auto functionality, as well as new or revised governmental regulations, may result in a decrease or cessation of Android Auto functionality and services. Honda cannot and does not provide any warranty or guarantee of future Android Auto performance or functionality.

It is possible to use 3rd party apps if they are compatible with Android Auto. Refer to the Android Auto homepage for information on compatible apps.

4 Music and audio

Play Google Play Music and music apps that are compatible with Android Auto. To switch between music apps, press this icon.

5 Go back to the Home Screen.

6 Voice

Operate Android Auto with your voice.

Auto Pairing Connection

When you connect an Android phone to the unit via the USB port, Android Auto is automatically initiated.

Enabling Android Auto

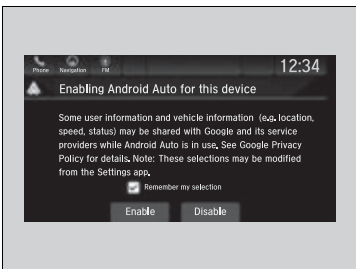

Enable: Allows this consent.

Disable: Does not allow this consent.

You may change the consent settings under the **Connections** settings menu.

Enabling Android Auto

Only initialize Android Auto when you are safely parked. When Android Auto first detects your phone, you will need to set up your phone so that auto pairing is possible. Refer to the instruction manual that came with your phone.

You can use the method below to change Android Auto settings after you have completed the initial setup:
Select HOME→Settings→Connections→Android Auto

Use of user and vehicle information

The use and handling of user and vehicle information transmitted to/from your phone by Android Auto is governed by the Google's Privacy Policy.

■ Operating Android Auto with Voice Recognition

Press and hold the talk button to operate Android Auto with your voice.



☒ Operating Android Auto with Voice Recognition

Below are examples of commands you can give with voice recognition:

- Reply to text.
- Call my wife.
- Navigate to Honda.
- Play my music.
- Send a text message to my wife.
- Call flower shop.

For more information, please refer to the Android Auto homepage.



You can also activate the voice recognition function by pressing the  icon in the upper-right corner of the screen.

Audio Error Messages

Models with Display Audio

CD Player*

If a disc error occurs, you may see the following error messages.

Error Message	Cause	Solution
Problem ejecting disc from the player. Contact Honda dealer to fix this problem.	Disc stuck in player	<ul style="list-style-type: none">• Contact a dealer and the player needs to be replaced.
There is a problem with the player. Eject and re-insert the disc. If this does not work, try another disc. If the error continues, contact Honda dealer.	Focus error Unsupported disc error Mechanical error Servo error DRM file access Error file access	<ul style="list-style-type: none">• Press the  (eject) button and remove the disc, and check that the error message is cleared.• Check that the disc is not damaged or deformed, and insert the disc again.  Protecting CDs P. 387
The system has overheated. Try to reduce the temperature by tuning the audio system off and allowing the player to cool down.	High temperature	<ul style="list-style-type: none">• Turn the audio system off and allow the player to cool down until the error message is cleared.

Error Message	Cause	Solution
<p>There is a problem with the player. Eject and re-insert the disc. If this does not work, try another disc. If this error continues contact Honda dealer.</p>	<p>Disc error</p>	<ul style="list-style-type: none"> • Check that the disc is not damaged or deformed. ▶ Protecting CDs P. 387
<p>The system has overheated. Try to reduce the temperature by turning the audio system off and allowing the player to cool down.</p>	<p>High temperature</p>	<ul style="list-style-type: none"> • Turn the audio system off and allow the player to cool down until the error message is cleared.

iPod/USB Flash Drive

If an error occurs while playing an iPod or USB flash drive, you may see the following error messages. If you cannot clear the error message, contact a dealer.

Error Message	Solution
USB Error^{*1} Problem reading connected device. See Owner's Manual for a list of compatible devices. If device is compatible, try reconnecting device. If this error remains, contact Honda dealer. ^{*2}	Appears when there is a problem with the audio system. Check if the device is compatible with the audio system.
Bad USB Device^{*1} Problem reading connected device. See Owner's Manual for a list of compatible devices. If device is compatible, try reconnecting device. If this error remains, contact Honda dealer. ^{*2}	Appears when an incompatible device is connected. Disconnect the device. Then, turn the audio system off and turn it on again. Do not reconnect the device that caused the error.
Unsupported Ver^{*1} Problem reading connected device. See Owner's Manual for a list of compatible devices. If device is compatible, try reconnecting device. If this error remains, contact Honda dealer. ^{*2}	<ul style="list-style-type: none"> • Appears when an unsupported iPod is connected. If it appears when a supported iPod is connected, update the iPod software to the newer version. • Appears when an unsupported device is connected. If it appears when a supported device is connected, reconnect the device.

*1:Models with color audio system

*2:Models with Display Audio

Error Message	Solution
Problem reading connected device. See Owner's Manual for a list of compatible devices. If device is compatible, try reconnecting device. If this error remains, contact Honda dealer.*2	<p>Appears when the system does not acknowledge the iPod. Reconnect the iPod.</p>
Unplayable File*1 The selected file cannot be played on this system*2	<p>Appears when the files in the USB flash drive are DRM or an unsupported format. This error message appears for about three seconds, then plays the next song.</p>
No Data*1 The connected device does not contain any files that can be played on this system. See Owner's Manual for a list of compatible file types.*2	<p>iPod Appears when the iPod is empty.</p> <p>USB flash drive Appears when the USB flash drive is empty or there are no MP3, WMA, or AAC files in the USB flash drive.</p> <p>iPod and USB flash drive Check that compatible files are stored on the device.</p>

*1:Models with color audio system

*2:Models with Display Audio

Models with Display Audio

Android/Apps

If an error occurs while using the audio system or apps, you may see the following error messages. If you cannot clear the error message, contact a dealer.

Error Message	Solution
Unfortunately, **** has stopped.* ¹	Error has occurred within app, select OK on the screen to close the app.
**** is not responding. Would you like to close it? * ¹	App is not responding. Select Wait if you can wait for a response from app a little longer. If it does not respond even if you keep waiting, select OK to close the app and start it up. If the error message continues, perform Factory Data Reset .  Defaulting All the Settings P. 481

*1: ****part is variable characters, and will change depending upon where an error occurs.

General Information on the Audio System

Models with Display Audio

SiriusXM® Radio Service *

■ Subscribing to SiriusXM® Radio

1. You need your radio ID ready before registering for subscription. To see the ID in the screen, select **Channel** to 0.
2. Have your radio ID ready, and either call or visit the SiriusXM® website to subscribe.

■ Receiving SiriusXM® Radio

Switch to the SiriusXM® mode by using the audio remote controls on the steering wheel, or through the audio/information screen, and stay in this mode for about 30 minutes until the service is activated. Make sure your vehicle is in an open area with good reception.

■ SiriusXM® Radio Display Messages

Channel not subscribed. Call SiriusXM to subscribe.:

You are not subscribed to the channel selected.

Subscription updated:

SiriusXM® radio is receiving information update from the network.

Channel Not Available:

No such channel exists, or the artist or title information is unavailable.

No Signal:

The signal is too weak in the current location.

Check Tuner:

There is a problem with the SiriusXM® tuner. Contact a dealer.

Check Antenna:

There is a problem with the SiriusXM® antenna. Contact a dealer.

* Not available on all models

☒ Subscribing to SiriusXM® Radio

Contact Information for SiriusXM® Radio:

- US: SiriusXM® Radio at www.siriusxm.com or 1-800-852-9696
- Canada: SiriusXM® Canada at www.siriusxm.ca, or 1-877-209-0079

☒ Receiving SiriusXM® Radio

The SiriusXM® satellites are in orbit over the equator; therefore, objects south of the vehicle may cause satellite reception interruptions. Satellite signals are more likely to be blocked by tall buildings and mountains the farther north you travel from the equator.

You may experience reception problems under the following circumstances:

- In a location with an obstruction to the south of your vehicle.
- In tunnels
- On the lower level of a multi-tiered road
- Large items carried on the roof rack

Models with Display Audio

Recommended CDs*

- Use only high-quality CD-R or CD-RW discs labeled for audio use.
- Use only CD-R or CD-RW discs on which the recordings are closed.
- Play only standard round-shaped CDs.

The CD packages or jackets should have one of these marks.



CDs with MP3, WMA or AAC files

- Some software files may not allow for audio play or text data display.
- Some versions of MP3, WMA or AAC formats may be unsupported.

▶▶ Recommended CDs*

A Dual-disc cannot play on this audio unit. If recorded under certain conditions, a CD-R or CD-RW may not play either.

■ Protecting CDs

Follow these precautions when handling or storing CDs:

- Store a CD in its case when it is not being played.
- When wiping a CD, use a soft clean cloth from the center to the outside edge.
- Handle a CD by its edge. Never touch either surface.
- Never insert foreign objects into the CD player.
- Keep CDs out of direct sunlight and extreme heat.
- Do not place stabilizer rings or labels on the CD.
- Avoid fingerprints, liquids, and felt-tip pens on the CD.

▶▶ Protecting CDs

NOTICE

Do not insert a damaged CD. It may be stuck inside and damage the audio unit.

Examples:

- Bubbled, wrinkled, labeled, and excessively thick CDs



Bubbled/
Wrinkled



With Label/
Sticker



Using
Printer Label
Kit



Sealed



With Plastic Ring

- Damaged CDs



Chipped/
Cracked



Warped

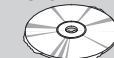

Burrs

- Poor quality CDs

- Small CDs



3-inch
(8-cm)
CD

Compatible iPod, iPad, iPhone, and USB Flash Drives

■ iPod, iPad, and iPhone Model Compatibility

Model
iPod (5th generation)
iPod classic 80GB/160GB (launch in 2007)
iPod classic 120GB (launch in 2008)
iPod classic 160GB (launch in 2009)
iPod nano (1st to 7th generation*) released between 2005 and 2012
iPod touch (1st to 5th generation*) released between 2007 and 2012
iPhone* ¹ /iPhone 3G/iPhone 3GS/iPhone 4/iPhone 4s/iPhone 5* ¹ /iPhone 5c/iPhone 5s/iPhone 6/iPhone 6 Plus
iPad* ¹ /iPad 2* ¹ /iPad (3rd generation)* ¹ /iPad (4th generation)* ¹
iPad Air* ¹ /iPad Air 2* ¹
iPad mini* ¹ /iPad mini 2* ¹ /iPad mini 3* ¹

■ USB Flash Drives

- A USB flash drive of 256 MB or higher is recommended.
- Some digital audio players may not be compatible.
- Some USB flash drives (e.g., a device with security lockout) may not work.
- Some software files may not allow for audio play or text data display.
- Some versions of MP3, WMA, or AAC formats may be unsupported.

*1: Models with Display Audio

* Not available on all models

ⓘ iPod, iPad, and iPhone Model Compatibility

This system may not work with all software versions of these devices.

ⓘ USB Flash Drives

Files on the USB flash drive are played in their stored order. This order may be different from the order displayed on your PC or device.

Honda App License Agreement

END USER LICENSE AGREEMENT

PLEASE CAREFULLY READ THIS END USER LICENSE AGREEMENT (THIS “AGREEMENT”) WHICH GOVERNS YOUR USE OF THE SOFTWARE INSTALLED ON YOUR HONDA OR ACURA VEHICLE (YOUR “VEHICLE”) AS WELL AS THE APPLICATIONS, SERVICES, FUNCTIONS, AND CONTENT PROVIDED THROUGH THE SOFTWARE (COLLECTIVELY, THE “SERVICES”). YOUR USE OF THE SOFTWARE OR SERVICES WILL SERVE AS YOUR CONSENT TO THE TERMS OF THIS AGREEMENT. THE SOFTWARE IS OWNED (OR LICENSED), PROVIDED, AND/OR OPERATED BY AMERICAN HONDA MOTOR CO. INC., (“HONDA,” “US,” “WE,” OR “OUR”), WITH ITS BUSINESS ADDRESS AT 1919 TORRANCE BLVD., TORRANCE, CA 90501. REFERENCE TO “HONDA” IN THIS AGREEMENT INCLUDES HONDA’S PARENT COMPANY AND ITS AFFILIATES AND DESIGNATED AGENTS. THE SERVICES ARE OWNED (OR LICENSED), PROVIDED, AND/OR OPERATED BY HONDA OR A THIRD-PARTY SERVICE PROVIDER (A “PROVIDER”). REFERENCE TO A “PROVIDER” IN THIS AGREEMENT INCLUDES SUCH PROVIDER’S PARENT COMPANY, AFFILIATES, AND DESIGNATED AGENTS.

A. Description of the Software. The SOFTWARE includes the software, firmware and the like, installed and executing on your VEHICLE during manufacture, and thereafter updated from time to time by HONDA, you or an authorized HONDA dealer (a “DEALER”). The SOFTWARE allows you to access and use a variety of SERVICES, including but not limited to: (a) HONDA applications, services, and content provided through the SOFTWARE (together, “HONDA SERVICES”); and (b) PROVIDER applications, services, and content provided through the SOFTWARE (together, “PROVIDER SERVICES”), each of which may provide access to various information, media, content, and services.

B. SOFTWARE Licensing and Intellectual Property.

1. SOFTWARE. This AGREEMENT grants you a non-exclusive, limited, and revocable license to use the SOFTWARE and SERVICES solely (a) as installed on your VEHICLE by HONDA, (b) as updated on your Vehicle by HONDA, you (but only as and when directed by HONDA), or a DEALER and (c) as permitted under the terms of this AGREEMENT.

2. HONDA Services. The SOFTWARE may provide you with access to various HONDA SERVICES. Installation, activation, or use of HONDA SERVICES may require your consent to additional terms, conditions, and privacy policies applicable to those HONDA SERVICES (the “HONDA TERMS”). You acknowledge and agree that any collection, use, sharing of data generated by your VEHICLE or your use of your VEHICLE, and your use of the HONDA SERVICES shall be subject to this AGREEMENT and any additional HONDA TERMS that may be specifically applicable to such HONDA SERVICES or data generation. The HONDA SERVICES may collect, use, and share such data while you are using the SOFTWARE.

3. Open-Source Software. The SOFTWARE and SERVICES may incorporate software licensed to HONDA under free or open-source licenses which govern HONDA's distribution and your use of such software. HONDA and the third-party authors, licensors, and distributors of such software disclaim all warranties and all liability arising from any and all use or distribution of the software. To the extent such software is provided under terms that differ from the applicable free or open-source licenses, those terms are offered by HONDA alone. Additional information regarding free and open-source software incorporated in the SOFTWARE and SERVICES is available in this manual or within the SOFTWARE.

4. Provider Services. The SOFTWARE may provide you with access to various PROVIDER SERVICES. Installation or use of such PROVIDER SERVICES may require your consent to additional terms, conditions, and privacy policies of the applicable PROVIDER (the "PROVIDER TERMS"). This AGREEMENT restricts the manner in which you can install and use PROVIDER SERVICES but does not grant you a license or permission to use such PROVIDER SERVICES. Your permission to use PROVIDER SERVICES is limited and subject to any license grants, conditions, and limitations included in the PROVIDER TERMS. You acknowledge that any collection, use, sharing of your information, targeted advertising practices by PROVIDERS, and your use of the PROVIDER SERVICES shall be subject to both this AGREEMENT and any applicable PROVIDER TERMS. The PROVIDER SERVICES may collect, use, and share such information while you are using the SOFTWARE.

5. License Limitations and Restrictions on Use.

(a) Limited License. You understand and agree that the SOFTWARE and SERVICES are licensed, not sold, to you solely for use in accordance with this AGREEMENT and any applicable PROVIDER TERMS, and any documentation for the VEHICLE made available to you by HONDA (any "DOCUMENTATION"). HONDA and its licensors reserve all rights in the SOFTWARE and HONDA SERVICES not expressly granted to you under this AGREEMENT. PROVIDERS and their licensors reserve all rights in the PROVIDER SERVICES not expressly granted to you under the applicable PROVIDER TERMS.

(b) Restrictions on Use. The licenses granted under this AGREEMENT do not permit you to use the SOFTWARE or SERVICES on a device other than your VEHICLE. As a condition of using the SOFTWARE and SERVICES, you agree that you may not and will not:

- (1) copy, download, distribute, modify, publish, sell, rent, lease, lend, license, sublicense, reuse, or create derivative works of the SOFTWARE or SERVICES or any of the content or other material within the SOFTWARE or SERVICES, including without limitation, HONDA or PROVIDER names, logos, or any other trademarks of HONDA or PROVIDERS or used in association with the SOFTWARE or any SERVICES, except as required to use the SOFTWARE or SERVICES in accordance with this AGREEMENT, any applicable PROVIDER TERMS, and the DOCUMENTATION;
- (2) access or use the SOFTWARE or SERVICES in any manner intended to damage or impair the operation of the SOFTWARE or SERVICES or interfere with anyone else's use and enjoyment of the SOFTWARE or SERVICES;
- (3) access or attempt to access any system or server on which the SOFTWARE or SERVICES is hosted or modify or alter the SOFTWARE or SERVICES in any way;
- (4) use the SOFTWARE or SERVICES for any unlawful purpose, or in violation of any third party rights;
- (5) use the SOFTWARE or SERVICES in violation of any applicable traffic regulations, rules or laws, including but not limited to any driver distraction laws, rules or regulations;
- (6) violate the terms of this AGREEMENT, any HONDA TERMS, any PROVIDER TERMS or other applicable third-party terms, conditions, and privacy policies; or
- (7) reverse engineer, decompile, disassemble, attempt to derive the source code of, nor permit others to reverse engineer, decompile, or disassemble, or attempt to derive the source code of the SOFTWARE or SERVICES, except and only to the extent that such activity is expressly permitted (a) by applicable law notwithstanding this limitation or (b) the terms of applicable free or opensource software licenses.

6. Intellectual Property Rights. All title and intellectual property rights in and to the SOFTWARE and SERVICES, the accompanying DOCUMENTATION, and all copies of the SOFTWARE or SERVICES are owned by HONDA, PROVIDERS, or their suppliers or licensors. This AGREEMENT does not grant you any rights in connection with any trademarks or service marks of HONDA, PROVIDERS, or their licensors, affiliates, or suppliers.

7. Export Restrictions: You acknowledge that the SOFTWARE and SERVICES are subject to U.S., European Union, and other export jurisdictions. You agree to comply with all applicable international and national laws that apply to the SOFTWARE and SERVICES, including the U.S. Export Administration Regulations, as well as end-user, end-use, and destination restrictions issued by the U.S. and other governments.

C. SOFTWARE Operation

1. HONDA reserves the right to suspend or terminate your access to and use of the SOFTWARE or SERVICES if you are found to be in violation of this AGREEMENT or as reasonably deemed necessary by HONDA.

2. Eligibility/Registration/Activation. The SOFTWARE is intended for and available to individuals who (a) are of legal age of majority in their jurisdiction of residence (and at least 18 years of age), or are younger than 18 years of age and possess a valid driver's license issued by their jurisdiction of residence, and (b) own or have permissive access to a compatible VEHICLE. We do not knowingly collect any information, including personal information, from children under 13. If we learn or are notified that we have collected personal information of a child under 13, we will immediately take steps to delete such information.

3. Use of PROVIDER SERVICES through the SOFTWARE. Certain PROVIDER SERVICES made available through the SOFTWARE may require that you register or otherwise have an account with the PROVIDER and agree to PROVIDER TERMS. Any use of any of such PROVIDER SERVICES within the SOFTWARE is subject to this AGREEMENT and the applicable PROVIDER TERMS. HONDA does not exercise control over such PROVIDER SERVICES and is not responsible or liable for the availability, security, or content of such PROVIDER SERVICES, and the inclusion of any PROVIDER SERVICES does not imply a referral from, the approval of, or the endorsement by HONDA of such PROVIDER SERVICES. HONDA is not responsible or liable, directly or indirectly, for any damage relating to or resulting from your use of the PROVIDER SERVICES.

4. Links to Third Party Sites: The SOFTWARE may provide you with the ability to access third-party sites and content through the use of the SOFTWARE or SERVICES. The third-party sites and content are not under the control of HONDA. HONDA is not responsible or liable, directly or indirectly, for such third-party websites and their content or for any damage relating to or resulting from your access or use of such websites and content.

5. Unauthorized Use and Abuse. You are responsible for ensuring your (and any authorized third parties') use of the SOFTWARE and SERVICES remains in compliance with this AGREEMENT and all other applicable HONDA TERMS and PROVIDER TERMS. You acknowledge and agree that any use of the SOFTWARE or SERVICES occurring through your VEHICLE will be deemed your actions and that HONDA and PROVIDERS may rely upon such actions. You agree to immediately notify us if you suspect fraudulent or abusive activity involving the SOFTWARE or SERVICES. If you so notify us or if we otherwise suspect fraudulent or abusive activity, you agree to cooperate with us in any fraud investigation and to use any fraud prevention measures we prescribe. Your failure to immediately notify us or cooperate to use such measures will result in your liability for all fraudulent usage or abusive activity associated with your VEHICLE.

6. SOFTWARE Updates. The SOFTWARE and SERVICES may be updated when your VEHICLE is serviced by a DEALER or remotely, over-the-air, by HONDA from time to time; such updates may occur with or without further notice or your future consent. The SOFTWARE may be updated at HONDA's discretion and for any purpose including, without limitation, to patch or otherwise improve the SOFTWARE or SERVICES functionality, security, or stability. All updates to the SOFTWARE and SERVICES are subject to this AGREEMENT and any other applicable HONDA TERMS and PROVIDER TERMS.

7. Uninstalling, Removing, and Replacing the SOFTWARE. Replacing SOFTWARE or HONDA SERVICES with software or firmware not provided and installed by HONDA or a DEALER will render all representations and warranties for the SOFTWARE, HONDA SERVICES, and VEHICLE functionality reliant upon the SOFTWARE or HONDA SERVICES null and void.

D. SOFTWARE Operational Notices and Warnings

1. Vehicle Geolocation Information. You acknowledge that your VEHICLE may be equipped with certain traffic and map features. The traffic feature will automatically collect and transmit, through GPS technology, your Vehicle's current location (longitude and latitude), travel direction and speed ("VEHICLE GEOLOCATION INFORMATION") to HONDA and PROVIDERS. The VEHICLE GEOLOCATION INFORMATION is used by HONDA and PROVIDERS to provide traffic and navigation-related information to you, but may also be used to provide other SERVICES or offers to you. HONDA will not use such VEHICLE GEOLOCATION INFORMATION for its own marketing efforts, or provide such information to unaffiliated third parties for their own purposes, without your express consent.

2. Potential Map Inaccuracy and Route Safety. Maps used by this system may be inaccurate because of changes in roads, traffic controls, routing, or driving conditions. Always use good judgment and common sense when following suggested routes. Do not follow the route suggestions if doing so would result in an unsafe or illegal driving maneuver, if you would be placed in an unsafe situation, or if you would be directed into an area that you consider unsafe. Do not rely on any navigation features included in the system to route you to emergency services. Not all emergency services such as police, fire stations, hospitals, or clinics are likely to be contained in the map database for such navigation features. Ask local authorities or an emergency services operator for such locations and routes. The driver is ultimately responsible for the safe operation of the vehicle and therefore, must evaluate whether it is safe to follow the suggested directions. Any navigation features are provided only as an aid. Make your driving decisions based on your observations of local conditions and existing traffic regulations. Navigation features are not a substitute for your personal judgment. Any route suggestions made by the SOFTWARE or SERVICES should never replace any local traffic regulations or your personal judgment or knowledge of safe driving practices.

3. Speech Recognition: You acknowledge and understand that HONDA and PROVIDERS may record, retain, and use voices commands when you use the speech recognition components of the SOFTWARE or SERVICES. You and all VEHICLE operators and passengers (a) consent to the recording and retention of voice commands in support of providing speech recognition components and (b) release HONDA and PROVIDERS from all claims, liabilities, and losses that may result from any use of such recorded voice commands. Recognition errors are inherent in speech recognition. It is your responsibility to monitor any speech recognition functions included in the system and address any errors. Neither HONDA nor PROVIDERS will be liable for any damages arising out of errors in the speech recognition process.

4. Distraction Hazards. Navigation features may require manual (non-verbal) input or setup. Attempting to perform such set-up or insert data while driving can seriously distract your attention and could cause a crash or other serious consequences; the ability to undertake such interactions may also be limited by state or local law, which laws you are responsible to know and follow. Even occasional short scans of the screen may be hazardous if your attention has been diverted away from your driving at a critical time. Pull over and stop the vehicle in a safe and legal manner before attempting to access a function of the system requiring prolonged attention. Do not raise the volume excessively. Keep the volume at a level where you can still hear outside traffic and emergency signals while driving. Driving while unable to hear these sounds could result in a crash.

E. Information Collection and Storage

1. Information Collection, Use, Transmission and Storage of Data. Consent to Use of Data: You agree that HONDA and PROVIDERS may collect and use your information gathered in any manner as part of product support services related to the SOFTWARE or related services. HONDA may share such information with third parties, including, without limitation, PROVIDERS, third party software and services suppliers, their affiliates and/or their designated agents, solely to improve their products or to provide services or technologies to you. HONDA, third party software and systems suppliers, their affiliates and/or their designated agent may disclose this information to others, but not in a form that personally identifies you.

2. Information Storage. Depending on the type of multimedia system you have in your VEHICLE, certain information may be stored for ease of use of the SOFTWARE including, without limitation, search history, location history in certain applications, previous and saved destinations, map locations within certain applications, and device numbers and contact information.

(a) Vehicle Health Information. Your VEHICLE may remotely transmit information regarding the status and health of your VEHICLE (“VEHICLE INFORMATION”) to HONDA without notification to you. VEHICLE INFORMATION may contain VEHICLE maintenance and malfunction status that is derived from VEHICLE diagnostic data and includes, but is not limited to, status of powered doors and windows, battery life data, battery charging data, VEHICLE speed, coolant temperature, air compressor revolution, output power, warning codes, diagnostic trouble codes, fuel injection volume, and engine rotations per minute. VEHICLE HEALTH INFORMATION may be used by HONDA for research and development, to deliver HONDA SERVICES and information to you, and to contact you, and is retained only for a period of time necessary to fulfill these goals.

(b) VEHICLE Geolocation Data (non-navigation/map based). If you opt-in to geolocation-based SERVICES, your vehicle’s geolocation data (latitude and longitude) will be automatically sent from your VEHICLE to HONDA and PROVIDERS.

(c) You understand that the inputting or uploading of information to your VEHICLE’s multimedia system or the SOFTWARE or SERVICES is at your own risk and that HONDA is not responsible for unauthorized access to or use of any personal or other information. All information uploaded to the SOFTWARE and SERVICES may be stored on your VEHICLES’s multimedia system and you understand that the security and safety of your VEHICLE’s multimedia system is your sole responsibility.

F. NO WARRANTY. You understand and agree that your use of the SOFTWARE and SERVICES are solely at your own risk and that you will be solely responsible for any damage to your VEHICLE's multimedia system or any other equipment or any loss of data that may result from your use of the SOFTWARE or SERVICES. THE SOFTWARE AND SERVICES ARE PROVIDED ON AN "AS IS" AND "AS AVAILABLE" BASIS WITHOUT ANY WARRANTY OF ANY KIND, EXPRESSED, IMPLIED OR STATUTORY. WE SPECIFICALLY DISCLAIM ANY IMPLIED WARRANTIES OF MERCHANTABILITY, FITNESS FOR A PARTICULAR PURPOSE, AND NON-INFRINGEMENT. HONDA makes no warranties that the SOFTWARE or SERVICES will meet your requirements, or that the SOFTWARE or SERVICES will be uninterrupted, timely, secure, non-infringing or error free. You understand and agree that you are responsible for any and all charges, costs or expenses associated with your use of the SOFTWARE or SERVICES. Advice or information, whether oral or written, obtained by you from us or through the SOFTWARE or SERVICES are provided for informational purposes only and will not create any warranty not expressly made herein. You should not rely on any such information or advice. We assume no liability or responsibility for any errors or omissions in the SOFTWARE or SERVICES. We do not make any warranty or representation that your use of the material displayed on, or obtained through, the SOFTWARE or SERVICES is non-infringing of any rights of any third party. Any decision or action taken by you on the basis of information or content provided via the application is at your sole discretion and risk. HONDA and PROVIDERS are not responsible or liable for any such decision, or for the accuracy, completeness, usefulness, or availability of any content or information displayed, transmitted, or otherwise made available via the SOFTWARE or SERVICES. To the extent jurisdictions do not allow the exclusion of certain warranties, some of the above exclusions may not apply to you.

G. LIMITATIONS ON LIABILITY. You and HONDA are each waiving important rights.

1. Limitations on YOUR liability. HONDA cannot recover from you any consequential, indirect, incidental, or special damages, or attorney's fees in connection with your use of the SOFTWARE or HONDA SERVICES. HONDA WAIVES TO THE FULLEST EXTENT ALLOWED BY LAW ANY CLAIM FOR DAMAGES OTHER THAN DIRECT, COMPENSATORY DAMAGES AS LIMITED IN THIS AGREEMENT.

2. Limitation on HONDA and PROVIDER liability. Neither HONDA nor PROVIDERS will be liable to you or any other party for consequential, indirect, incidental, special, or punitive damages (including without limitation lost profits) in connection with your use of the SOFTWARE or SERVICES, even if HONDA or PROVIDERS are aware of the possibility of such damages. These limitations apply to all claims, including, without limitation, claims in contract and tort (such as negligence, product liability and strict liability). To the extent that a jurisdiction does not permit the exclusion or limitation of liability as set forth herein our liability is limited to the maximum extent permitted by law in such states. If HONDA or PROVIDERS are found liable to you for any reason, you agree that the aggregate liability of all these parties to you for any claim is limited to ten U.S. dollars (US \$10.00). Neither HONDA nor any PROVIDER would have agreed to provide the SOFTWARE or SERVICES to you if you did not agree to this limitation. This amount is the sole and exclusive liability of HONDA and PROVIDERS to you, and is payable as liquidated damages and not as a penalty. Except where prohibited by law, you may not bring any claim against HONDA or any third-party beneficiary more than two (2) years after the claim arises. We do not have any liability for SOFTWARE or SERVICES interruptions of any length.

(a) **Release of HONDA and PROVIDERS** For yourself and anyone else claiming under you, you agree to release and discharge HONDA, PROVIDERS, their respective officers, directors, and employees, and each third-party beneficiary from all claims, liabilities and losses in connection with the SOFTWARE or SERVICES, including, but not limited to claims for personal injury or property damage arising from the total or partial failure of performance of the SOFTWARE or SERVICES, even if caused by or based upon the negligence, gross negligence, strict products liability, Deceptive Trade Practices Act violations, bad faith, or breach of warranty of us or the malfunction of the SOFTWARE or SOFTWARE SERVICES. YOU AGREE TO WAIVE TO THE FULLEST EXTENT ALLOWED BY LAW, ANY CLAIM FOR DAMAGES OTHER THAN DIRECT, COMPENSATORY DAMAGES AS LIMITED IN THIS AGREEMENT. YOU HEREBY RELEASE AND DISCHARGE HONDA AND ITS LICENSORS AND CONTRACTORS (INCLUDING ANY THIRD PARTIES PROVIDING ALL OR PART OF THE SOFTWARE OR SERVICES) FROM AND AGAINST ANY CLAIMS, DAMAGES, EXPENSES AND LIABILITY ARISING FROM OR RELATED TO ANY INJURIES, DAMAGES, OR LOSSES TO ANY PERSON (INCLUDING DEATH) OR PROPERTY OF ANY KIND RESULTING IN WHOLE OR PART, DIRECTLY OR INDIRECTLY, FROM YOUR USE OF THE SOFTWARE OR SERVICES.

H. Survival. You agree that the limitations of liability and indemnities in this AGREEMENT will survive even after the AGREEMENT has ended. These limitations of liability apply not only to you, but to anyone using the SOFTWARE or SERVICES via your VEHICLE, to anyone making a claim on your behalf, and to any claims made by your family, employees, customers, or others arising out of or relating to your VEHICLE, the SOFTWARE, or SERVICES.

I. Availability/Interruption. The SOFTWARE and certain SERVICES are made available through your VEHICLE's compatible multimedia system when the VEHICLE is turned on. Certain SERVICES may be available only through your compatible mobile device when it is within the operating range of the VEHICLE and a wireless carrier. The availability of the SOFTWARE and SERVICES may be subject to transmission limitation or interruption, including but not limited to technical obsolescence or sunset of the hardware, software or firmware, inside of or external to the Vehicle, required for data transmission or receipt. HONDA does not guarantee that the SOFTWARE, SERVICES, or any portion thereof will be available at all times or in all areas. You acknowledge and agree that HONDA is not responsible for performance degradation, interruption or delays. You acknowledge that HONDA shall not be liable to you if the SOFTWARE or SERVICES in a given location are not available. If the SOFTWARE or SERVICES are not available within your intended location, you agree that your sole remedy shall be to cease using the SOFTWARE and SERVICES.

J. PRODUCT SUPPORT: Product support for the SOFTWARE is provided by HONDA. For product support, please refer to HONDA instructions provided in the DOCUMENTATION. Should you have any questions concerning this AGREEMENT, or if you desire to contact HONDA for any other reason, please refer to the HONDA contact information provided in the DOCUMENTATION.

K. Termination and Transfer.

1. Termination. This AGREEMENT is effective until terminated by you or US. WE may terminate this AGREEMENT for any or no reason, and with or without notice to you. Your rights under this AGREEMENT will terminate automatically without notice from US if you fail to comply with any term of this AGREEMENT. Upon termination of this AGREEMENT, you shall cease all use of the SOFTWARE and SERVICES.

2. Transfer: You may permanently transfer your rights under this AGREEMENT only as part of a sale or transfer of the VEHICLE, provided you retain no copies, you transfer all of the SOFTWARE and HONDA SERVICES (including all component parts, the media and printed materials, and any upgrades), and the recipient agrees to the terms of this AGREEMENT. You agree to notify HONDA upon the sale or transfer of the VEHICLE. To contact HONDA, please refer to the HONDA contact information provided in the DOCUMENTATION.

L. Changes to the SOFTWARE or SERVICES. WE may change, modify, or update the SOFTWARE or SERVICES from time to time. Unless explicitly stated otherwise, any new features or services that augment or enhance the SOFTWARE or SERVICES in the future shall respectively be considered part of the SOFTWARE or SERVICES and subject to this AGREEMENT. WE reserve the right at any time and from time to time to interrupt, restrict, modify, suspend, discontinue, temporarily or permanently, the SOFTWARE or SERVICES (or any portion thereof), with or without notice to you, and you agree that HONDA shall not be liable to you or to any third party for any modification, suspension or discontinuance of the SOFTWARE or SERVICES.

M. ARBITRATION:

PLEASE READ THIS ARBITRATION PROVISION CAREFULLY TO UNDERSTAND YOUR RIGHTS. YOU AGREE THAT ANY CLAIM THAT YOU MAY HAVE IN THE FUTURE MUST BE RESOLVED THROUGH BINDING ARBITRATION. YOU WAIVE THE RIGHT TO HAVE YOUR DISPUTE HEARD IN COURT AND WAIVE THE RIGHT TO BRING CLASS CLAIMS. YOU UNDERSTAND THAT DISCOVERY AND APPEAL RIGHTS ARE MORE LIMITED IN ARBITRATION.

Arbitration is a method of resolving a claim, dispute or controversy without filing a lawsuit. By agreeing to arbitrate, the right to go to court is waived and instead claims, disputes or controversies are submitted to binding arbitration. This provision sets forth the terms and conditions of our agreement. YOU and HONDA agree and acknowledge that this Agreement affects interstate commerce and the Federal Arbitration Act ("FAA") applies. By using the Software, Vehicle, or Services, YOU elect to have disputes resolved by arbitration. YOU, HONDA or any involved third party may pursue a Claim. "Claim" means any dispute between YOU, HONDA, or any involved third party relating to your use of the Software, the Vehicle, or the Services, this Agreement, or our relationship, including any representations, omissions or warranties. "Claim" does not include personal injury or wrongful death claims. YOU or HONDA may seek remedies in small claims court or provisional judicial remedies without arbitrating. In addition, notwithstanding anything herein to the contrary, YOU or HONDA may seek equitable relief in a court of competent jurisdiction.

YOU or HONDA may select arbitration with American Arbitration Association, JAMS or National Arbitration and Mediation. Contact these sponsors for their rules. The hearing will be in the federal district where YOU reside. If agreed, it may be by telephone or written submissions. Filing and arbitrator fees to be paid per the sponsor rules. You may contact the sponsor for a fee waiver. If no fee waivers, HONDA will pay filing and arbitrator fees up to \$5,000, unless law requires more. Each party is responsible for other fees. Arbitrator may award costs or fees to prevailing party, if permitted by law. HONDA will not seek fees, unless the claims are frivolous.

Arbitrator shall be an attorney or current or retired judge familiar with automotive or consumer software. The arbitrator shall follow substantive law, statute of limitations and decide all issues relating to the interpretation, construction, enforceability and applicability of this provision. The arbitrator may order relief permitted by law. This provision is governed and enforceable by the FAA. An award shall include a written opinion and be final, subject to appeal by the FAA.

This provision survives termination of this Agreement or relationship, bankruptcy, assignment or transfer. If part of this provision is unenforceable, the remainder remains in effect. If unenforceability allows arbitration as a class action, then this provision is entirely unenforceable. YOU may opt out within 30 days of your initial use of the Software by sending a signed, written notice to HONDA at Honda Financial Services, P.O. Box 165007, Irving, TX 75016. HONDA reserves the right to make changes to this provision after providing written notice and an opportunity to opt out.

N. Miscellaneous: You may not assign this AGREEMENT without HONDA's prior written consent. This AGREEMENT and any additional HONDA TERMS and PROVIDER TERMS represents the entire agreement between you and US. HONDA may amend the terms of this AGREEMENT by providing you with notices of such updated terms. If you do not consent to be bound by the updated terms, your sole remedy will be to cease using the SOFTWARE and SERVICES. If any part of this AGREEMENT is found invalid, void, or unenforceable, the balance of the AGREEMENT will remain valid and enforceable according to its terms. To the fullest extent permitted by law, and except as explicitly provided otherwise, this AGREEMENT and any disputes arising out of or relating to it will be governed by the laws of the State of California, except that California laws concerning choice of law or conflicts shall not apply if they would cause the substantive law of another jurisdiction to apply. Notwithstanding the foregoing, Section M shall be governed by the Federal Arbitration Act and the laws of the State of California, as applicable, as set forth therein. The failure to enforce any term of this AGREEMENT on one occasion shall not prevent enforcement on any other occasion or the enforcement of any other term. Headings and captions shall not be considered included for purposes of interpretation or application hereof, but are for convenience only.

Models with Display Audio

Legal Information on Apple CarPlay/Android Auto

OWNER'S MANUAL LICENSE/LIABILITY STATEMENTS

USE OF APPLE CARPLAY IS SUBJECT TO YOUR AGREEMENT TO THE CARPLAY TERMS OF USE, WHICH ARE INCLUDED AS PART OF THE APPLE iOS TERMS OF USE. IN SUMMARY, THE CARPLAY TERMS OF USE DISCLAIM APPLE AND ITS SERVICE PROVIDERS' LIABILITY IF THE SERVICES FAIL TO PERFORM CORRECTLY OR ARE DISCONTINUED, STRICTLY LIMIT APPLE AND ITS SERVICE PROVIDERS' OTHER LIABILITIES, DESCRIBE THE KINDS OF USER INFORMATION (INCLUDING, FOR EXAMPLE, VEHICLE LOCATION, VEHICLE SPEED, AND VEHICLE STATUS) BEING GATHERED AND STORED BY APPLE AND ITS SERVICE PROVIDERS, AND DISCLOSE CERTAIN POSSIBLE RISKS ASSOCIATED WITH THE USE OF CARPLAY, INCLUDING THE POTENTIAL FOR DRIVER DISTRACTION. SEE APPLE'S PRIVACY POLICY FOR DETAILS REGARDING APPLE'S USE AND HANDLING OF DATA UPLOADED BY CARPLAY.

USE OF ANDROID AUTO IS SUBJECT TO YOUR AGREEMENT TO THE ANDROID AUTO TERMS OF USE WHICH MUST BE AGREED TO WHEN THE ANDROID AUTO APPLICATION IS DOWNLOADED TO YOUR ANDROID PHONE. IN SUMMARY, THE ANDROID AUTO TERMS OF USE DISCLAIM GOOGLE AND ITS SERVICE PROVIDERS' LIABILITY IF THE SERVICES FAIL TO PERFORM CORRECTLY OR ARE DISCONTINUED, STRICTLY LIMIT GOOGLE AND ITS SERVICE PROVIDERS' OTHER LIABILITIES, DESCRIBE THE KINDS OF USER INFORMATION (INCLUDING, FOR EXAMPLE, VEHICLE LOCATION, VEHICLE SPEED, AND VEHICLE STATUS) BEING GATHERED AND STORED BY GOOGLE AND ITS SERVICE PROVIDERS, AND DISCLOSE CERTAIN POSSIBLE RISKS ASSOCIATED WITH THE USE OF ANDROID AUTO, INCLUDING THE POTENTIAL FOR DRIVER DISTRACTION. SEE GOOGLE'S PRIVACY POLICY FOR DETAILS REGARDING GOOGLE'S USE AND HANDLING OF DATA UPLOADED BY ANDROID AUTO.

DISCLAIMER OF WARRANTIES; LIMITATION ON LIABILITY

YOU EXPRESSLY ACKNOWLEDGE AND AGREE THAT USE OF APPLE CARPLAY OR ANDROID AUTO (“THE APPLICATIONS”) IS AT YOUR SOLE RISK AND THAT THE ENTIRE RISK AS TO SATISFACTORY QUALITY, PERFORMANCE, ACCURACY AND EFFORT IS WITH YOU TO THE MAXIMUM EXTENT PERMITTED BY APPLICABLE LAW, AND THAT THE APPLICATIONS AND INFORMATION ON THE APPLICATIONS IS PROVIDED “AS IS” AND “AS AVAILABLE,” WITH ALL FAULTS AND WITHOUT WARRANTY OF ANY KIND, AND HONDA HEREBY DISCLAIMS ALL WARRANTIES AND CONDITIONS WITH RESPECT TO THE APPLICATIONS AND INFORMATION ON THE APPLICATIONS, EITHER EXPRESS, IMPLIED OR STATUTORY, INCLUDING, BUT NOT LIMITED TO, THE IMPLIED WARRANTIES AND/OR CONDITIONS OF MERCHANTABILITY, SATISFACTORY QUALITY, FITNESS FOR A PARTICULAR PURPOSE, ACCURACY, QUIET ENJOYMENT, AND NON-INFRINGEMENT OF THIRD PARTY RIGHTS. NO ORAL OR WRITTEN INFORMATION OR ADVICE GIVEN BY HONDA OR AN AUTHORIZED REPRESENTATIVE SHALL CREATE A WARRANTY. AS EXAMPLES, AND WITHOUT LIMITATION, HONDA DISCLAIMS ANY WARRANTY REGARDING THE ACCURACY OF DATA PROVIDED BY THE APPLICATIONS, SUCH AS THE ACCURACY OF DIRECTIONS, ESTIMATED TRAVEL TIME, SPEED LIMITS, ROAD CONDITIONS, NEWS, WEATHER, TRAFFIC, OR OTHER CONTENT PROVIDED BY APPLE, GOOGLE, THEIR AFFILIATES, OR THIRD PARTY PROVIDERS; HONDA DOES NOT GUARANTEE AGAINST LOSS OF APPLICATION DATA, WHICH MAY BE LOST AT ANY TIME; HONDA DOES NOT GUARANTEE THAT THE APPLICATIONS OR ANY SERVICES PROVIDED THROUGH THEM WILL BE PROVIDED AT ALL TIMES OR THAT ANY OR ALL SERVICES WILL BE AVAILABLE AT ANY PARTICULAR TIME OR LOCATION. FOR EXAMPLE, SERVICES MAY BE SUSPENDED OR INTERRUPTED WITHOUT NOTICE FOR REPAIR, MAINTENANCE, SECURITY FIXES, UPDATES, ETC., SERVICES MAY BE UNAVAILABLE IN YOUR AREA OR LOCATION, ETC. IN ADDITION, YOU UNDERSTAND THAT CHANGES IN THIRD PARTY TECHNOLOGY OR GOVERNMENT REGULATION MAY RENDER THE SERVICES AND/OR APPLICATIONS OBSOLETE AND/OR UNUSABLE.

TO THE EXTENT NOT PROHIBITED BY LAW, IN NO EVENT SHALL HONDA OR ITS AFFILIATES BE LIABLE FOR PERSONAL INJURY, OR ANY INCIDENTAL, SPECIAL, INDIRECT OR CONSEQUENTIAL DAMAGES WHATSOEVER, INCLUDING, WITHOUT LIMITATION, DAMAGES FOR LOSS OF PROFITS, CORRUPTION OR LOSS OF DATA, FAILURE TO TRANSMIT OR RECEIVE ANY DATA, BUSINESS INTERRUPTION OR ANY OTHER COMMERCIAL DAMAGES OR LOSSES, ARISING OUT OF OR RELATED TO THE APPLICATIONS OR YOUR USE OF OR INABILITY TO USE THE APPLICATIONS OR INFORMATION ON THE APPLICATIONS, HOWEVER CAUSED, REGARDLESS OF THE THEORY OF LIABILITY (CONTRACT, TORT OR OTHERWISE) AND EVEN IF HONDA WERE ADVISED OF THE POSSIBILITY OF SUCH DAMAGES. SOME STATES AND JURISDICTIONS DISALLOW THE EXCLUSION OR LIMITATION OF LIABILITY FOR DAMAGES, SO THESE LIMITATIONS AND EXCLUSIONS MAY NOT APPLY TO YOU. IN NO EVENT SHALL HONDA’S TOTAL LIABILITY TO YOU FOR ALL DAMAGES (OTHER THAN AS MAY BE REQUIRED BY APPLICABLE LAW IN CASES INVOLVING PERSONAL INJURY) EXCEED THE AMOUNT OF FIVE DOLLARS (\$5.00). THE FOREGOING LIMITATIONS WILL APPLY EVEN IF THE ABOVE STATED REMEDY FAILS OF ITS ESSENTIAL PURPOSE.

Models with Display Audio

About Open Source Licenses

To see the open source license information, follow these steps.

1. Select .
2. Select **Settings**.
3. Select **System**.
4. Select **About**.
5. Select **Legal Information**.

» About Open Source Licenses

For Telematics Control Unit

Free/Open Source Software Information.

This product contains Free/Open Source Software(FOSS).

The license information and/or the source code of such FOSS can be found at the following URL.

<https://www.denso.com/global/en/opensource/tcu/honda/>

License Information *

■ DOLBY DIGITAL

Manufactured under license from Dolby Laboratories. Dolby, Dolby Audio, Pro Logic, and the double-D symbol are trademarks of Dolby Laboratories.



■ DTS

For DTS patents, see <http://patents.dts.com>. Manufactured under license from DTS Licensing Limited. DTS, DTS-HD, the Symbol, & DTS and the Symbol together are registered trademarks of DTS, Inc. ©DTS, Inc. All Rights Reserved.



Bluetooth

The *Bluetooth*® word mark and logos are registered trademarks owned by *Bluetooth SIG, Inc.* and any use of such marks by DENSO CORPORATION is under license. Other trademarks and trade names are those of their respective owners.



Windows Media

This product is protected by certain intellectual property rights of Microsoft. Use or distribution of such technology outside of this product is prohibited without a license from Microsoft.

■ Apple

“Made for iPod,” “Made for iPhone,” and “Made for iPad” mean that an electronic accessory has been designed to connect specifically to iPod, iPhone, or iPad, respectively, and has been certified by the developer to meet Apple performance standards. Apple is not responsible for the operation of this device or its compliance with safety and regulatory standards. Please note that the use of this accessory with iPod, iPhone, or iPad may affect wireless performance.

Apple, the Apple Logo, iPad, iPhone, iPod, iPod classic, iPod nano, and iPod touch are trademarks of Apple Inc., registered in the U.S. and other countries. iPad Air, iPad mini, iPad Pro, Apple CarPlay, and Lightning are trademarks of Apple Inc. App Store is a service mark of Apple Inc.



MPEG

Mpeg4 Visual

THIS PRODUCT IS LICENSED UNDER THE MPEG-4 VISUAL PATENT PORTFOLIO LICENSE FOR THE PERSONAL AND NON-COMMERCIAL USE OF A CONSUMER FOR (i) ENCODING VIDEO IN COMPLIANCE WITH THE MPEG-4 VISUAL STANDARD (“MPEG-4 VIDEO”) AND/OR (ii) DECODING MPEG-4 VIDEO THAT WAS ENCODED BY A CONSUMER ENGAGED IN A PERSONAL AND NONCOMMERCIAL ACTIVITY AND/OR WAS OBTAINED FROM A VIDEO PROVIDER LICENSED BY MPEG LA TO PROVIDE MPEG-4 VIDEO. NO LICENSE IS GRANTED OR SHALL BE IMPLIED FOR ANY OTHER USE. ADDITIONAL INFORMATION INCLUDING THAT RELATING TO PROMOTIONAL, INTERNAL AND COMMERCIAL USES AND LICENSING MAY BE OBTAINED FROM MPEG LA, LLC. SEE [HTTP://WWW.MPEGLA.COM](http://www.mpegla.com).

VC-1

THIS PRODUCT IS LICENSED UNDER THE VC-1 PATENT PORTFOLIO LICENSE FOR THE PERSONAL AND NON-COMMERCIAL USE OF A CONSUMER TO (i) ENCODE VIDEO IN COMPLIANCE WITH THE VC-1 STANDARD (“VC-1 VIDEO”) AND/OR (ii) DECODE VC-1 VIDEO THAT WAS ENCODED BY A CONSUMER ENGAGED IN A PERSONAL AND NON-COMMERCIAL ACTIVITY AND/OR WAS OBTAINED FROM A VIDEO PROVIDER LICENSED TO PROVIDE VC-1 VIDEO. NO LICENSE IS GRANTED OR SHALL BE IMPLIED FOR ANY OTHER USE. ADDITIONAL INFORMATION MAY BE OBTAINED FROM MPEG LA, L.L.C. SEE [HTTP://WWW.MPEGLA.COM](http://www.mpegla.com).

AVC/H.264

THIS PRODUCT IS LICENSED UNDER THE AVC PATENT PORTFOLIO LICENSE FOR THE PERSONAL AND NONCOMMERCIAL USE OF A CONSUMER TO (i) ENCODE VIDEO IN COMPLIANCE WITH THE AVC STANDARD ("AVC VIDEO") AND/OR (ii) DECODE AVC VIDEO THAT WAS ENCODED BY A CONSUMER ENGAGED IN A PERSONAL AND NON-COMMERCIAL ACTIVITY AND/OR WAS OBTAINED FROM A VIDEO PROVIDER LICENSED TO PROVIDE AVC VIDEO. NO LICENSE IS GRANTED OR SHALL BE IMPLIED FOR ANY OTHER USE.

ADDITIONAL INFORMATION MAY BE OBTAINED FROM MPEG LA, L.L.C. SEE [HTTP://WWW.MPEGLA.COM](http://www.mpegla.com).

■ SDHC Memory Card

microSDHC Logo is a trademark of SD-3C, LLC.

Blu-ray/DVD Rear Entertainment System *

Rear seat passengers can enjoy a completely separate entertainment source than front passengers, including movies, games, and other audio choices.

Blu-ray/DVD Rear Entertainment System *

Blu-ray Disc™, Blu-ray™, and the logos are trademarks of the Blu-ray Disc Association.

BD-XL, BD-Live, Blu-ray 3D, and Ultra HD Blu-ray are not supported.

CAUTION: Radio Frequency Radiation Exposure The Rear Entertainment System remote complies with FCC radiation exposure limits set forth for an uncontrolled environment and meets the FCC radio frequency (RF) Exposure Guidelines. The Rear Entertainment System remote should be kept at least 7.9 inch (20 cm) or more away from a person's body when operated.

* Not available on all models

Wireless Headphones

The rear seat passengers can listen to audio from the Blu-ray/DVD rear entertainment system using the wireless headphones that come with your vehicle.

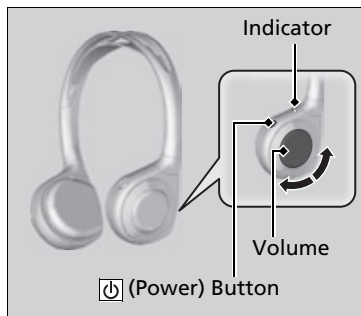

To turn on the switch: Press the  (power) button at the right earpiece. The indicator comes on.

To adjust the volume: Turn the dial at the right earpiece.

■ DTS Headphone:X™

For DTS patents, see <http://patents.dts.com>. Manufactured under license from DTS Licensing Limited. DTS, the Symbol, & DTS and the Symbol together are registered trademarks, and DTS Headphone:X is a trademark of DTS, Inc. © DTS, Inc. All Rights Reserved.



▶▶ Wireless Headphones

Your vehicle comes with two wireless headphones.

Wear the headphones correctly with the earpiece marked with L over your left ear, and the earpiece marked R over your right ear.

Wearing the headphones backward may affect the audio reception.

You can put the headphones into the front seat-back upper pockets, and the remote into the front passenger's seat-back lower pocket as shown below.

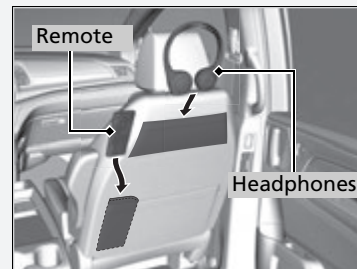

Auxiliary Console Panels

Headphone connectors for the Blu-ray/DVD rear entertainment system are on the both sides of the third row outer seats.

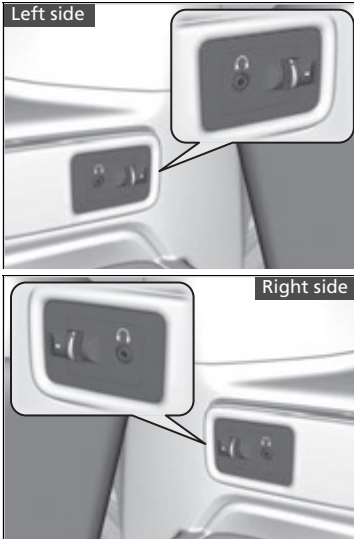

■ Headphone connectors

Headphones can also be used by connecting to either auxiliary console panel. There are two headphone connectors for the third row passengers. Each connector has its own volume control.

HDMI™ Port

There is an HDMI™ port on the back of the console compartment. The Blu-ray/DVD rear entertainment system will accept HDMI™ port from video games and video equipment which are equipped with an HDMI™ port.

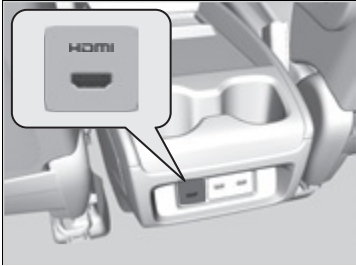

Overhead Screen

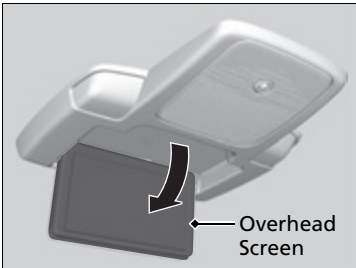



Pull down the screen to the first or second detent until it latches.

ⓧ HDMI™ Port

The terms HDMI and HDMI High-Definition Multimedia Interface, and the HDMI Logo are trademarks or registered trademarks of HDMI Licensing LLC in the United States and other countries.

The HDMI port is for use with the Blu-ray/DVD rear entertainment system only.

Operating the System

To operate the system, set the power mode to ON or ACCESSORY. Select **Rear Entertainment**, then  **Rear** in the audio/information screen to turn on the system. You can also turn on the system by pressing the  (power) button on the remote.

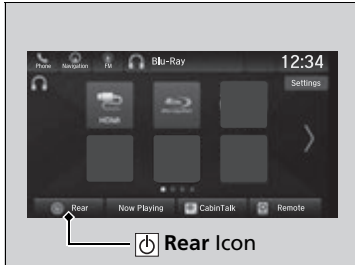

■ Home Screen

To display the home screen on the overhead screen, press the  (home) button on the remote. From this screen, you can use various apps or settings.

▣ Home Screen

To change the order of icons, press and hold the **ENTER** button on the remote.

Video Accessibility

The Blu-ray/DVD Rear Entertainment System (RES) supports an accessibility function which allows the user to enable audio feedback of on-screen operations through the wireless and wired headphones.

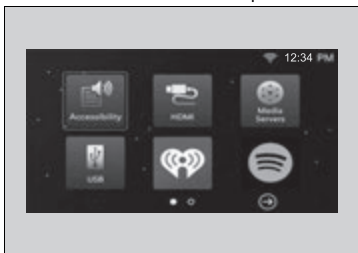

Selecting the Accessibility Function

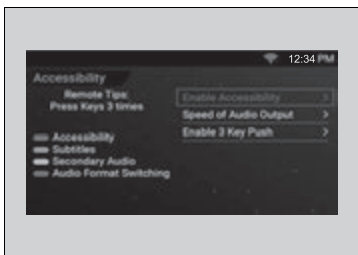

1. Press the  (power) button on the RES remote.
2. Select **Accessibility**, then press the **ENTER** button on the remote.

The following selections are available:

- **Enable Accessibility:** Turns the accessibility mode on or off. (Factory default: Off)
- **Speed of Audio Output:** Adjusts to increase or decrease the speed of audio output. (Factory default: Middle (8th) tick mark)
- **Enable 3 Key Push:** Enables or disables the feature that allows you to turn a function on or off, or change a function setting without going through the menu. (Factory default: On)

Selecting the Accessibility Function

Since the accessibility function is set to OFF by default, you must set it to ON before using it.

You can also select **Accessibility** from the Settings screen.

 **System Settings** P. 420

To change the position of the Video Accessibility icon, press and hold the **ENTER** button on the RES remote, then drag the icon to the desired location.

■ Changing Function Status

Press any of the following colored buttons on the RES remote three times to turn a function on or off, or to change a function setting.

Red button: **Accessibility**

Green button: **Subtitles**

Yellow button: **Secondary Audio**

Blue button: **Audio Format Switching**

Playing a DVD/Blu-ray™

To play a DVD or Blu-ray™, insert a DVD or Blu-ray™ into the lower slot of the front audio system, and select **[Rear]** in the audio/information screen.

- ▶ The system automatically starts the DVD or Blu-ray™. DVD or Blu-ray™ is available for the rear seat passenger only.

System Controls

(Power) Button

Press to turn the Blu-ray/DVD rear entertainment system on or off.

(Home) Button

Press to display the home screen.

(Back) Button

Press to go back to the previous display or operation.

Red/Green/Yellow/Blue Button

Press to use on a DVD or Blu-ray™ menu.





(Play/Pause) Button

Press to pause or play a DVD or Blu-ray™.

Buttons

Press to change chapters.

, , , and **ENTER** Buttons

Use , , , or  to highlight a menu item, and press the **ENTER** button to make a selection.

(Light) Button

Press to illuminate the buttons for a few seconds.

MENU Button

Press to display the menu items.

(Stop) Button

Press to stop a DVD or Blu-ray™.

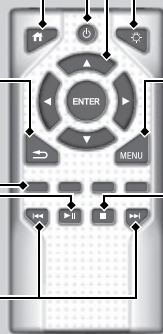

■ Rear DVD or Blu-ray™ Menu

1. Press the **MENU** button on the remote to display the menu screen.
2. Select an item and then press the **ENTER** button on the remote.

The following items are available:

- **DVD Menu/Blu-ray Menu:** Displays the top menu of the DVD or Blu-ray™.
- **Aspect Ratio:** Selects an aspect ratio of the image.
 - ▶ **Setting the Aspect Ratio** P. 417
- **Brightness:** Adjusts the screen's brightness.
- **Contrast:** Adjusts the screen's contrast.
- **Root Menu***1: Displays the disc menu for the current playing title.
- **Pop-up Menu***2: Displays the menu of the Blu-ray™.
- **Player Options:** Displays while a DVD or Blu-ray™ is playing and changes the DVD or Blu-ray™ preferences.
 - ▶ **Setting the Player Options** P. 418

■ Setting the Aspect Ratio

1. Press the **MENU** button on the remote to display the menu screen.
2. Select **Aspect Ratio**.
3. Select the setting you want.
 - ▶ You can select the three options; normal, full, or zoom.

*1: Appears only when you select the DVD source.

*2: Appears only when you select the Blu-ray™ source.

▶▶ Rear DVD or Blu-ray™ Menu

During DVD or Blu-ray™ operation, when the source is changed or the audio system is turned off, DVD or Blu-ray™ operation stops.

Depending on the disc you insert, some items may not be displayed.

■ Setting the Player Options

1. Press the **MENU** button on the remote to display the menu screen.
2. Select **Player Options**.
3. Select an item and then press the **ENTER** button on the remote.

The following items are available:

- **Repeat:**
 - Off:** Repeat mode is off.
 - Title** (only for DVD-V, AVCREC and BDAV): Repeats the current title.
 - Chapter** (only for DVD-V, AVCREC and BDAV): Repeats the current chapter.
 - Program** (only for DVD-VR): Repeats the current program if the disc has the correspondence list.
 - Playlist** (only for DVD-VR): Repeats the current playlist if the disc has the correspondence list.
 - Entry Point** (only for DVD-VR): Repeats the current entry point if the disc has the correspondence list.
- **Subtitles and Audio:** Selects the language of the DVD subtitle and audio.
- **Angle:** Selects the angle of the scene shot with multiple cameras.
- **Search:** Skips to a title or chapter.
 - 🔍 **Searching a title/chapter/program/playlist** P. 419
- **Change Order** (only for DVD-VR, AVCREC and BDAV): Changes the order of the program or playlist.
- **Default Language:** Selects the language for the menus, audio, and subtitle of the DVD or Blu-ray™.
- **Sound Leveling:** Adjusts the range of the loud and soft sound. Select **Auto, On** or **Off**.
- **Secondary Audio** (only for BDMV): Turns on and off the function that plays the available commentary or narrator audio along with the main disc track.
- **Onscreen Remote:** Displays the on-screen buttons for the remote.

■ Searching a title/chapter/program/playlist

1. Press the **MENU** button on the remote to display the menu screen.
2. Select **Player Options**.
3. Select **Search**.
4. Enter a number of a title, chapter, program or playlist to skip, and then select **enter**.

The following items are available:



- **Title**: Skips to a title you specify.
- **Chapter**: Skips to a chapter you specify.
- **Program** (only for DVD-VR): Skips to a program you specify while playing with the program list.
- **Playlist** (only for DVD-VR): Skips to a playlist you specify while playing with the playlist.

■ System Settings

1. Press the  (home) button on the remote.
2. Select **Settings** and then press the **ENTER** button on the remote to display the **Settings** screen.
3. Select an item.

The following items are available:

- **Display:** Adjusts the screen's preferences.
 - ▶ **Adjusting the screen** P. 421
- **Language:** Sets the system language used on all screens.
 - ▶ **Setting the Language** P. 421
- **Headphones:** Sets the surround of the wireless headphones.
 - ▶ **Setting the Headphones** P. 421
- **Accessibility:** With **On** selected, the Blu-ray/DVD rear entertainment system provides audio feedback through the headphones to assist the user with on-screen operations.
- **About My System:** Displays the information of the Blu-ray/DVD rear entertainment system.
- **System Reset:** Resets the Blu-ray/DVD rear entertainment system settings and erases all login information.

After you make all the adjustments, press the  (back) or  (home) button to return.

■ Adjusting the screen

1. Press the  (home) button on the remote.
2. Select **Settings** and then press the **ENTER** button on the remote to display the **Settings** screen.
3. Select **Display** and then press the **ENTER** button on the remote.
4. Select the setting you want.

The following items are available:

- **Brightness:** Adjusts the screen's brightness.
- **Contrast:** Adjusts the screen's contrast.
- **Tint:** Adjusts the screen's hue.
- **Color:** Adjusts the screen's color strength.

■ Setting the Language

1. Press the  (home) button on the remote.
2. Select **Settings** and then press the **ENTER** button on the remote to display the **Settings** screen.
3. Select **Language** and then press the **ENTER** button on the remote.
4. Select the setting you want.
 - ▶ You can select the language from **US English, UK English, Spanish, Canadian French, Arabic, or Korean.**

■ Setting the Headphones



1. Press the  (home) button on the remote.
2. Select **Settings** and then press the **ENTER** button on the remote to display the **Settings** screen.
3. Select **Headphones** and then press the **ENTER** button on the remote.
4. Select the setting you want.
 - ▶ You can select the options from **Off** or **On**. Select **Off** to disable the feature.

Front Control Panel Operation

You can operate the Blu-ray/DVD Rear Entertainment System (RES) from the audio/information screen.

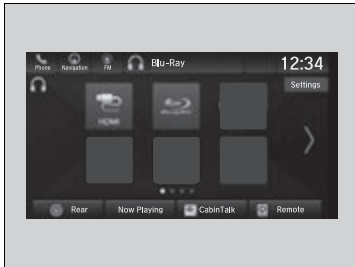
■ Selecting the App using Front Control Panel



1. Select .
2. Select **Rear Entertainment**.
3. Select  **Rear** if the power is off.
 - ▶ If you select this icon while the system is operating, the system is turned off.
4. Select the app you want to use.

The following items are available on the audio/information screen:

-  **Rear**: Turns the system on or off.
- **Now Playing**: Displays the current playing app.
- **Rear Apps**: Displays the home screen.
- **CabinTalk**: Displays the **CabinTalk** screen.
 - ▶ **CabinTalk**®* P. 536
- **Remote**: Disables controls from the remote.
- **Settings**: Changes the system settings.
 - ▶ **Rear System Setup** P. 423

Rear System Setup

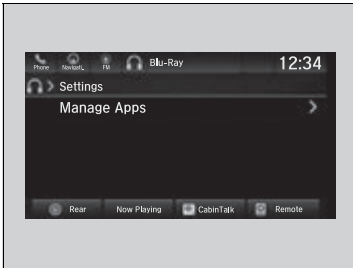

■ Manage Apps

Shows or hides app icons on the home screen.

1. Select .
2. Select **Rear Entertainment**.
3. Select **Settings**.
4. Select **Manage Apps**.

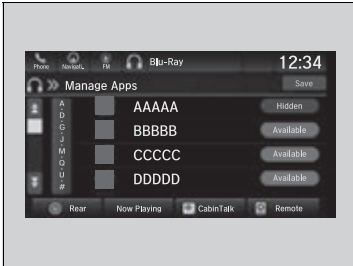

5. Select **Available** or **Hidden**.
6. Select **Save**.

■ Setting the DVD or Blu-ray™ Menu

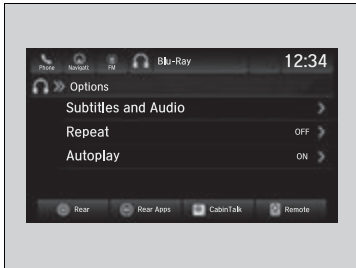

Select **Options** while a DVD or Blu-ray™ is playing.

The following items are available on the audio/information screen:

- **Subtitles and Audio**
 - ▶ **Setting the Player Options** P. 418
- **Repeat**
 - ▶ **Setting the Player Options** P. 418
- **Change Order**
 - ▶ **Setting the Player Options** P. 418
- **Autoplay**: Turns on and off to automatically play a DVD or Blu-ray™ disc.

▶▶ Setting the DVD or Blu-ray™ Menu

Depending on the disc you insert, some items may not be displayed.

Playing Apps

You can play apps such as USB, iPod, HDMI® and more from the rear seats.

▶▶ Playing Apps

Streaming Applications

Your vehicle's Blu-ray/DVD rear entertainment system comes pre-loaded with audio streaming applications.

Before launching any application, first confirm that your vehicle's date and time are set correctly. Having the incorrect date and time settings may prevent your applications from operating correctly.

You can set the date and time on the front display in the following steps.

Select Home→Settings→Date & Time→Set Date & Time

Your vehicle is equipped with the ability to apply software updates. When a software update is provided to your vehicle, please accept the update and allow the installation to complete.

Disclaimer:

The audio quality of your streaming applications will depend on your internet connection.

If you experience lagging or disconnections, check your connection and confirm it is operational.

■ System Controls

⏻ (Power) Button

Press to turn the Blu-ray/DVD rear entertainment system on or off.

🏠 (Home) Button

Press to display the home screen.

⏪ (Back) Button

Press to go back to the previous display or operation.

▶|| (Play/Pause) Button

Press to pause or play a video or audio file.

⏮/▶▶ Buttons

Press to change videos or audio files.

▲, ▼, ◀, ▶ and ENTER Buttons

Use ▲, ▼, ◀, or ▶ to highlight a menu item, and press the ENTER button to make a selection.

💡 (Light) Button

Press to illuminate the buttons for a few seconds.

MENU Button

Press to display the menu items.

■ (Stop) Button

Press to stop a video or audio file.

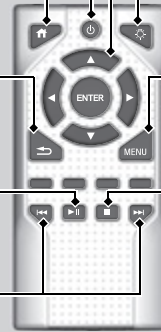

■ Playing a Disc in the Rear

To play a disc, press the  (home) button on the remote, and then select the Blu-ray Disc icon on the overhead screen.

When you press the **MENU** button on the remote while the CD is playing, the audio menu appears on the overhead screen.

The available options appear on the overhead screen are repeat, random, brightness, and contrast.

■ Playing an iPod and a USB Flash Drive in the Rear

To play an iPod and a USB flash drive, press the  (home) button on the remote, and then select the **USB** icon on the overhead screen.

When you press the **MENU** button on the remote while the iPod or USB flash drive is playing, the audio menu appears on the overhead screen.

The available options appear on the overhead screen are repeat, random, aspect ratio, brightness, and contrast.

System Controls

You can also operate the Blu-ray/DVD rear entertainment system on the audio/information screen.

■ Playing a Video Using the HDMI™

To play videos from an HDMI™-compatible device, connect the device using an HDMI™ cable.

▶ **HDMI™ Port P. 412**

Press the  (home) button on the remote, and then select the **HDMI** icon on the overhead screen.





When you press the **MENU** button on the remote while the video using the HDMI™ is playing, the audio menu appears on the overhead screen.

The available options appear on the overhead screen are aspect ratio, brightness, and contrast.

■ How Much Farther?™*

Displays the current location temperature, time remaining, distance traveled, and distance remaining with an animation.

To play the app, press the  (home) button on the remote, and then select the **How Much Farther?** icon on the overhead screen.

You can select a background from five types using  or  on the remote, and bring some items (at top of the screen) up and down using  or .

■ Media Servers

Plays a stored video or audio file from a connected device via Wi-Fi.

Connect the device using Wi-Fi.

 **Wi-Fi Connection** P. 369

Press the  (home) button on the remote, and then select the **Media Servers** icon on the overhead screen.

The operation are the same as the USB mode.

⌘ How Much Farther?™*

When there is no destination set on the navigation system, an animated demonstration will be displayed.

⌘ Media Servers

NOTE: For this feature to work, an app that exposes your device as a media server must be installed on your device. Open this app on your device prior to selecting the **Media Servers** icon. This feature is only supported on Android phones.

* Not available on all models

Audio Sources for Front and Rear Seats

The table shows the possible audio source combinations of the front audio system and Blu-ray/DVD rear entertainment system's simultaneous use.

Front Rear	AM/FM Radio	SiriusXM® Radio	CD DVD*1 Blu-ray™*1	USB iPod
CD DVD*1 Blu-ray™*1	Yes	Yes	Yes	Yes
USB iPod	Yes	Yes	No	Yes
HDMI™*1	Yes	Yes	No	Yes

*1: The front seat passengers are only able to hear the DVD's, Blu-ray™'s or HDMI™'s sound from the front speakers.

▶▶ Audio Sources for Front and Rear Seats

Yes: These audio sources are simultaneously playable. When listening to same source in both the front and rear, the playing channel or track will also be the same for each.

No: These audio sources are not simultaneously playable.

Playable Discs

The discs that come with these labels can be played in your vehicle's Blu-ray/DVD rear entertainment system.

Also look for the region code of 1, ALL,  or  on the package or jacket on the disc.

DVD-ROMs and Blu-ray™ ROMs (BD ROM) are not playable in this unit.

The disc packages or jackets should have one of these marks.



Also includes:



▶▶ Playable Discs

This product incorporates copyright protection technology that is protected by U.S. patents and other intellectual property rights.

This item incorporates copy protection technology that is protected by U.S. patents and other intellectual property rights of Rovi Corporation. Reverse engineering and disassembly are prohibited.

For DTS patents, see <http://patents.dts.com>. Manufactured under license from DTS Licensing Limited. DTS, DTS-HD, the Symbol, & DTS and the Symbol together are registered trademarks of DTS, Inc. ©DTS, Inc. All Rights Reserved.

Manufactured under license from Dolby Laboratories. Dolby, Dolby Audio, Pro Logic, and the double-D symbol are trademarks of Dolby Laboratories.

"Blu-ray Disc™", "Blu-ray™", and the logos are trademarks of the Blu-ray Disc Association.

DVD is a trademark of DVD Format/Logo Licensing Corporation.

■ Java

Oracle, Java and all Java-based trademarks and logos are trademarks or registered trademarks of Oracle and/or its affiliates. Other names may be trademarks of their respective owners.



END USER LICENSE AGREEMENT

BEFORE USING THIS IN-CAR BLU-RAY PRODUCT, PLEASE READ ALL OF THE FOLLOWING TERMS AND CONDITIONS OF THIS END USER LICENSE AGREEMENT ("Agreement") CAREFULLY. THIS AGREEMENT IS A LEGALLY BINDING CONTRACT BETWEEN END USER ("you") AND PANASONIC THAT SETS FORTH THE TERMS AND CONDITIONS THAT GOVERN YOUR USE OF ORACLE JAVA ME MEDIA PACK FOR CDC (the "program") IMPLEMENTED IN THIS IN-CAR BLU-RAY PRODUCT.

- (1) Java Technology Restrictions. You are prohibited from creating, modifying, changing the behavior of classes, interfaces, or subpackages that are in any way identified as "Java", "Javax", "Sun" or similar convention as specified by Oracle in any naming convention designation.
- (2) Trademarks and Logos. You shall acknowledge that Oracle owns the Java trademark and all Java-related trademarks, logos and icons including the Coffee Cup and Duke ("Java Marks") and shall agree to: (a) comply with the Java Trademark Guidelines at <http://www.oracle.com/us/legal/third-party-trademarks/index.html>; (b) not do anything harmful to or inconsistent with Oracle's rights in the Java Marks; and (c) assist Oracle in protecting those rights, including assigning to Oracle any rights acquired by you in any Java Mark.
- (3) Third Party Code. You shall read additional copyright notices and license terms applicable to portions of the programs are set forth below.

COMPONENTS

The following software (or certain identified files distributed with the software) may be included in this product. Unless otherwise specified, the software identified in this file is licensed under the licenses described below. The disclaimers and copyright notices provided are based on information made available to Oracle by the third party licensors listed.

3DES

3DES

Des3Cipher - the triple-DES encryption method

Copyright (C) 1996 by Jef Poskanzer <jef@mail.acme.com>. All rights reserved.

Redistribution and use in source and binary forms, with or without modification, are permitted provided that the following conditions are met:

- 1. Redistributions of source code must retain the above copyright notice, this list of conditions and the following disclaimer.*
- 2. Redistributions in binary form must reproduce the above copyright notice, this list of conditions and the following disclaimer in the documentation and/or other materials provided with the distribution.*

THIS SOFTWARE IS PROVIDED BY THE AUTHOR AND CONTRIBUTORS "AS IS" AND ANY EXPRESS OR IMPLIED WARRANTIES, INCLUDING, BUT NOT LIMITED TO, THE IMPLIED WARRANTIES OF MERCHANTABILITY AND FITNESS FOR A PARTICULAR PURPOSE ARE DISCLAIMED. IN NO EVENT SHALL THE AUTHOR OR CONTRIBUTORS BE LIABLE FOR ANY DIRECT, INDIRECT, INCIDENTAL, SPECIAL, EXEMPLARY, OR CONSEQUENTIAL DAMAGES (INCLUDING, BUT NOT LIMITED TO, PROCUREMENT OF SUBSTITUTE GOODS OR SERVICES; LOSS OF USE, DATA, OR PROFITS; OR BUSINESS INTERRUPTION) HOWEVER CAUSED AND ON ANY THEORY OF LIABILITY, WHETHER IN CONTRACT, STRICT LIABILITY, OR TORT (INCLUDING NEGLIGENCE OR OTHERWISE) ARISING IN ANY WAY OUT OF THE USE OF THIS SOFTWARE, EVEN IF ADVISED OF THE POSSIBILITY OF SUCH DAMAGE.

Visit the ACME Labs Java page for up-to-date versions of this and other fine Java utilities: <http://www.acme.com/java/>

AES

Cryptix General License

Copyright (c) 1995-2005 The Cryptix Foundation Limited. All rights reserved.

Redistribution and use in source and binary forms, with or without modification, are permitted provided that the following conditions are met:

1. Redistributions of source code must retain the copyright notice, this list of conditions and the following disclaimer.
2. Redistributions in binary form must reproduce the above copyright notice, this list of conditions and the following disclaimer in the documentation and/or other materials provided with the distribution.

THIS SOFTWARE IS PROVIDED BY THE CRYPTIX FOUNDATION LIMITED AND CONTRIBUTORS "AS IS" AND ANY EXPRESS OR IMPLIED WARRANTIES, INCLUDING, BUT NOT LIMITED TO, THE IMPLIED WARRANTIES OF MERCHANTABILITY AND FITNESS FOR A PARTICULAR PURPOSE ARE DISCLAIMED.

IN NO EVENT SHALL THE CRYPTIX FOUNDATION LIMITED OR CONTRIBUTORS BE LIABLE FOR ANY DIRECT, INDIRECT, INCIDENTAL, SPECIAL, EXEMPLARY, OR CONSEQUENTIAL DAMAGES (INCLUDING, BUT NOT LIMITED TO, PROCUREMENT OF SUBSTITUTE GOODS OR SERVICES; LOSS OF USE, DATA, OR PROFITS; OR BUSINESS INTERRUPTION) HOWEVER CAUSED AND ON ANY THEORY OF LIABILITY, WHETHER IN CONTRACT, STRICT LIABILITY, OR TORT (INCLUDING NEGLIGENCE OR OTHERWISE) ARISING IN ANY WAY OUT OF THE USE OF THIS SOFTWARE, EVEN IF ADVISED OF THE POSSIBILITY OF SUCH DAMAGE.

DES

DES

DesCipher - the DES encryption method

*@@ The meat of this code is by Dave Zimmerman <dzimm@widget.com>, and is:
Copyright (c) 1996 Widget Workshop, Inc. All Rights Reserved.*

Permission to use, copy, modify, and distribute this software and its documentation for NON-COMMERCIAL or COMMERCIAL purposes and without fee is hereby granted, provided that this copyright notice is kept intact.

WIDGET WORKSHOP MAKES NO REPRESENTATIONS OR WARRANTIES ABOUT THE SUITABILITY OF THE SOFTWARE, EITHER EXPRESS OR IMPLIED, INCLUDING BUT NOT LIMITED TO THE IMPLIED WARRANTIES OF MERCHANTABILITY, FITNESS FOR A PARTICULAR PURPOSE, OR NON-INFRINGEMENT. WIDGET WORKSHOP SHALL NOT BE LIABLE FOR ANY DAMAGES SUFFERED BY LICENSEE AS A RESULT OF USING, MODIFYING OR DISTRIBUTING THIS SOFTWARE OR ITS DERIVATIVES.

THIS SOFTWARE IS NOT DESIGNED OR INTENDED FOR USE OR RESALE AS ON-LINE CONTROL EQUIPMENT IN HAZARDOUS ENVIRONMENTS REQUIRING FAIL-SAFE PERFORMANCE, SUCH AS IN THE OPERATION OF NUCLEAR FACILITIES, AIRCRAFT NAVIGATION OR COMMUNICATION SYSTEMS, AIR TRAFFIC CONTROL, DIRECT LIFE SUPPORT MACHINES, OR WEAPONS SYSTEMS, IN WHICH THE FAILURE OF THE SOFTWARE COULD LEAD DIRECTLY TO DEATH, PERSONAL INJURY, OR SEVERE PHYSICAL OR ENVIRONMENTAL DAMAGE ("HIGH RISK ACTIVITIES"). WIDGET WORKSHOP SPECIFICALLY DISCLAIMS ANY EXPRESS OR IMPLIED WARRANTY OF FITNESS FOR HIGH RISK ACTIVITIES.

@@ The rest of the code is:

Copyright (C) 1996 by Jef Poskanzer <jef@mail.acme.com>. All rights reserved.

Redistribution and use in source and binary forms, with or without modification, are permitted provided that the following conditions are met:

1. Redistributions of source code must retain the above copyright notice, this list of conditions and the following disclaimer.
2. Redistributions in binary form must reproduce the above copyright notice, this list of conditions and the following disclaimer in the documentation and/or other materials provided with the distribution.

THIS SOFTWARE IS PROVIDED BY THE AUTHOR AND CONTRIBUTORS "AS IS" AND ANY EXPRESS OR IMPLIED WARRANTIES, INCLUDING, BUT NOT LIMITED TO, THE IMPLIED WARRANTIES OF MERCHANTABILITY AND FITNESS FOR A PARTICULAR PURPOSE ARE DISCLAIMED. IN NO EVENT SHALL THE AUTHOR OR CONTRIBUTORS BE LIABLE FOR ANY DIRECT, INDIRECT, INCIDENTAL, SPECIAL, EXEMPLARY, OR CONSEQUENTIAL DAMAGES (INCLUDING, BUT NOT LIMITED TO, PROCUREMENT OF SUBSTITUTE GOODS OR SERVICES; LOSS OF USE, DATA, OR PROFITS; OR BUSINESS INTERRUPTION) HOWEVER CAUSED AND ON ANY THEORY OF LIABILITY, WHETHER IN CONTRACT, STRICT LIABILITY, OR TORT (INCLUDING NEGLIGENCE OR OTHERWISE) ARISING IN ANY WAY OUT OF THE USE OF THIS SOFTWARE, EVEN IF ADVISED OF THE POSSIBILITY OF SUCH DAMAGE.

Visit the ACME Labs Java page for up-to-date versions of this and other fine Java utilities: <http://www.acme.com/java/>

JPEG library

The authors make NO WARRANTY or representation, either express or implied, with respect to this software, its quality, accuracy, merchantability, or fitness for a particular purpose. This software is provided "AS IS", and you, its user, assume the entire risk as to its quality and accuracy.

This software is copyright (C) 1991-1998, Thomas G. Lane.

zlib 1.1.3

@@ Acknowledgments:

Oracle gratefully acknowledges the contributions of Jean-loup Gailly and Mark Adler in creating the zlib general purpose compression library which is used in this product.

@@ Copyright notice:

(C) 1995-1998 Jean-loup Gailly and Mark Adler

This software is provided 'as-is', without any express or implied warranty. In no event will the authors be held liable for any damages arising from the use of this software.

Permission is granted to anyone to use this software for any purpose, including commercial applications, and to alter it and redistribute it freely, subject to the following restrictions:

- 1. The origin of this software must not be misrepresented; you must not claim that you wrote the original software. If you use this software in a product, an acknowledgment in the product documentation would be appreciated but is not required.*
- 2. Altered source versions must be plainly marked as such, and must not be misrepresented as being the original software.*
- 3. This notice may not be removed or altered from any source distribution.*

Jean-loup Gailly
jloup@gzip.org

Mark Adler
madler@alumni.caltech.edu

If you use the zlib library in a product, we would appreciate *not* receiving lengthy legal documents to sign. The sources are provided for free but without warranty of any kind. The library has been entirely written by Jean-loup Gailly and Mark Adler; it does not include third-party code.

If you redistribute modified sources, we would appreciate that you include in the file ChangeLog history information documenting your changes.

(4) Others.

(i) You shall not install the programs separately and independently from this Blu-ray product.

(ii) You agree not to rely on the future availability of any programs or services which Oracle will provide.

(5) ENTIRE AGREEMENT

You agree that this Agreement is the complete agreement pertaining to the subject matter hereof (including references to information contained in a URL) and this Agreement supersedes all prior or contemporaneous written or oral agreements or representations existing between you and Panasonic with respect to such subject matter. If any term of this Agreement is found to be invalid or unenforceable, the remaining provisions will remain effective. Panasonic's failure to enforce any right or provisions in this Agreement will not constitute a waiver of such provision, or any other provision of this Agreement.

■ HDMI

HDMI, the HDMI Logo, and High-Definition Multimedia Interface are trademarks or registered trademarks of HDMI Licensing LLC in the United States and other countries.

■ Cinavia

This product uses Cinavia technology to limit the use of unauthorized copies of some commercially-produced film and videos and their soundtracks. When a prohibited use of an unauthorized copy is detected, a message will be displayed and playback or copying will be interrupted.

More information about Cinavia technology is provided at Cinavia Online Consumer Information Center at <http://www.cinavia.com>. To request additional information about Cinavia by mail, send a postcard with your mailing address to: Cinavia Consumer Information Center, P.O. Box 86851, San Diego, CA, 92138, USA.

This product incorporates proprietary technology under license from Verance Corporation and is protected by U.S. Patent 7,369,677 and other U.S. and worldwide patents issued and pending as well as copyright and trade secret protection for certain aspects of such technology. Cinavia is a trademark of Verance Corporation. Copyright 2004-2014 Verance Corporation. All rights reserved by Verance. Reverse engineering or disassembly is prohibited.

■ MPEG

THIS PRODUCT IS LICENSED UNDER THE AVC PATENT PORTFOLIO LICENSE FOR THE PERSONAL AND NON-COMMERCIAL USE OF A CONSUMER TO (i) ENCODE VIDEO IN COMPLIANCE WITH THE AVC STANDARD ("AVC VIDEO") AND/OR (ii) DECODE AVC VIDEO THAT WAS ENCODED BY A CONSUMER ENGAGED IN A PERSONAL AND NON-COMMERCIAL ACTIVITY AND/OR WAS OBTAINED FROM A VIDEO PROVIDER LICENSED TO PROVIDE AVC VIDEO. NO LICENSE IS GRANTED OR SHALL BE IMPLIED FOR ANY OTHER USE. ADDITIONAL INFORMATION MAY BE OBTAINED FROM MPEG LA, L.L.C. SEE [HTTP://WWW.MPEGLA.COM](http://www.mpegla.com).

THIS PRODUCT IS LICENSED UNDER THE VC-1 PATENT PORTFOLIO LICENSE FOR THE PERSONAL AND NON-COMMERCIAL USE OF A CONSUMER TO (i) ENCODE VIDEO IN COMPLIANCE WITH THE VC-1 STANDARD ("VC-1 VIDEO") AND/OR (ii) DECODE VC-1 VIDEO THAT WAS ENCODED BY A CONSUMER ENGAGED IN A PERSONAL AND NON-COMMERCIAL ACTIVITY AND/OR WAS OBTAINED FROM A VIDEO PROVIDER LICENSED TO PROVIDE VC-1 VIDEO. NO LICENSE IS GRANTED OR SHALL BE IMPLIED FOR ANY OTHER USE. ADDITIONAL INFORMATION MAY BE OBTAINED FROM MPEG LA, L.L.C. SEE [HTTP://WWW.MPEGLA.COM](http://www.mpegla.com).

This product is protected by certain intellectual property rights of Microsoft Corporation and third parties. Use or distribution of such technology outside of this product is prohibited without a license from Microsoft or an authorized Microsoft subsidiary and third parties.

This product is licensed under the AVC patent portfolio license and VC-1 patent portfolio license for the personal use of a consumer or other uses in which it does not receive remuneration to

(i) encode video in compliance with the AVC Standard and VC-1 Standard ("AVC/VC-1 Video") and/or

(ii) decode AVC/VC-1 Video that was encoded by a consumer engaged in a personal activity and/or was obtained from a video provider licensed to provide AVC/VC-1 Video.

No license is granted or shall be implied for any other use.

Additional information may be obtained from MPEG LA, L.L.C. See <http://www.mpegla.com>.

■ OSS

This product incorporates the following software:

- (1) The software developed by, or developed for, Panasonic Corporation ("Panasonic"),
- (2) The software owned by third party and licensed to Panasonic,
- (3) The software licensed under the GNU GENERAL PUBLIC LICENSE, Version 2 ("GPL"),
- (4) The software licensed under the GNU LESSER GENERAL PUBLIC LICENSE, Version 2.1 ("LGPL"), and/or
- (5) Open sourced software licensed under terms and conditions other than GPL or LGPL.

For the software classified as (3) or (4) above, please refer to the terms and conditions of GPL and LGPL at the websites listed below:

<http://www.gnu.org/licenses/old-licenses/gpl-2.0.html>

<http://www.gnu.org/licenses/old-licenses/lgpl-2.1.html>

The software classified as (3) and (4) above are copyrighted by multiple people. Please refer to the websites below regarding the copyright notices of those people.

http://www.hondaopensource2.com/17M_BDP/

At least three (3) years from delivery of products, Panasonic will give to any third party who contacts us at the Contact Information provided below, for a charge no more than our cost of physically performing source code distribution, a complete machine-readable copy of the source code corresponding to the GPL/LGPL Software.

Please note that we are unable to answer any queries regarding source code details, etc.

[Contact Information]

Engineering Administration Group Manager Panasonic Corporation, Automotive Systems Company, 4261 Ikonobe-cho, Tsuzuki-ku, Yokohama, Kanagawa 224-8520, Japan

Furthermore, source code corresponding to the GPL/LGPL Software listed above is freely available to you and any member of the public at the websites listed below:

http://www.hondaopensource2.com/17M_BDP/

The software classified as (5) above contains various open sourced software ("OSS") including the following software:

LICENSE ISSUES

The OpenSSL toolkit stays under a dual license, i.e. both the conditions of the OpenSSL License and the original SSLeay license apply to the toolkit. See below for the actual license texts. Actually both licenses are BSD-style Open Source licenses. In case of any license issues related to OpenSSL please contact openssl-core@openssl.org.

OpenSSL License

Copyright (c) 1998-2011 The OpenSSL Project. All rights reserved.

Redistribution and use in source and binary forms, with or without modification, are permitted provided that the following conditions are met:

1. Redistributions of source code must retain the above copyright notice, this list of conditions and the following disclaimer.
2. Redistributions in binary form must reproduce the above copyright notice, this list of conditions and the following disclaimer in the documentation and/or other materials provided with the distribution.
3. All advertising materials mentioning features or use of this software must display the following acknowledgment:
"This product includes software developed by the OpenSSL Project for use in the OpenSSL Toolkit. (<http://www.openssl.org/>)"
4. The names "OpenSSL Toolkit" and "OpenSSL Project" must not be used to * endorse or promote products derived from this software without prior written permission. For written permission, please contact openssl-core@openssl.org.
5. Products derived from this software may not be called "OpenSSL" nor may "OpenSSL" appear in their names without prior written permission of the OpenSSL Project.
6. Redistributions of any form whatsoever must retain the following acknowledgment:
"This product includes software developed by the OpenSSL Project for use in the OpenSSL Toolkit (<http://www.openssl.org/>)"

THIS SOFTWARE IS PROVIDED BY THE OpenSSL PROJECT "AS IS" AND ANY EXPRESSED OR IMPLIED WARRANTIES, INCLUDING, BUT NOT LIMITED TO, THE IMPLIED WARRANTIES OF MERCHANTABILITY AND FITNESS FOR A PARTICULAR PURPOSE ARE DISCLAIMED. IN NO EVENT SHALL THE OpenSSL PROJECT OR ITS CONTRIBUTORS BE LIABLE FOR ANY DIRECT, INDIRECT, INCIDENTAL, SPECIAL, EXEMPLARY, OR CONSEQUENTIAL DAMAGES (INCLUDING, BUT NOT LIMITED TO, PROCUREMENT OF SUBSTITUTE GOODS OR SERVICES; LOSS OF USE, DATA, OR PROFITS; OR BUSINESS INTERRUPTION) HOWEVER CAUSED AND ON ANY THEORY OF LIABILITY, WHETHER IN CONTRACT, STRICT LIABILITY, OR TORT (INCLUDING NEGLIGENCE OR OTHERWISE) ARISING IN ANY WAY OUT OF THE USE OF THE POSSIBILITY OF SUCH DAMAGE.

This product includes cryptographic software written by Eric Young (eay@cryptsoft.com). This product includes software written by Tim Hudson (tjh@cryptsoft.com).

Original SSLeay License

Copyright (C) 1995-1998 Eric Young (eay@cryptsoft.com) All rights reserved.

This package is an SSL implementation written by Eric Young (eay@cryptsoft.com).

The implementation was written so as to conform with Netscapes SSL.

This library is free for commercial and non-commercial use as long as the following conditions are aheared to. The following conditions apply to all code found in this distribution, be it the RC4, RSA, lhash, DES, etc., code; not just the SSL code. The SSL documentation included with this distribution is covered by the same copyright terms except that the holder is Tim Hudson (tjh@cryptsoft.com).

Copyright remains Eric Young's, and as such any Copyright notices in the code are not to be removed.

If this package is used in a product, Eric Young should be given attribution as the author of the parts of the library used.

This can be in the form of a textual message at program startup or in documentation (online or textual) provided with the package.

Redistribution and use in source and binary forms, with or without modification, are permitted provided that the following conditions are met:

1. Redistributions of source code must retain the copyright notice, this list of conditions and the following disclaimer.
2. Redistributions in binary form must reproduce the above copyright notice, this list of conditions and the following disclaimer in the documentation and/or other materials provided with the distribution.
3. All advertising materials mentioning features or use of this software must display the following acknowledgement:
"This product includes cryptographic software written by Eric Young (*eay@cryptsoft.com*)"
The word 'cryptographic' can be left out if the routines from the library being used are not cryptographic related :-).
4. If you include any Windows specific code (or a derivative thereof) from the apps directory (application code) you must include an acknowledgement: "This product includes software written by Tim Hudson (*tjh@cryptsoft.com*)"

THIS SOFTWARE IS PROVIDED BY ERIC YOUNG "AS IS" AND ANY EXPRESS OR IMPLIED WARRANTIES, INCLUDING, BUT NOT LIMITED TO, THE IMPLIED WARRANTIES OF MERCHANTABILITY AND FITNESS FOR A PARTICULAR PURPOSE ARE DISCLAIMED. IN NO EVENT SHALL THE AUTHOR OR CONTRIBUTORS BE LIABLE FOR ANY DIRECT, INDIRECT, INCIDENTAL, SPECIAL, EXEMPLARY, OR CONSEQUENTIAL DAMAGES (INCLUDING, BUT NOT LIMITED TO, PROCUREMENT OF SUBSTITUTE GOODS OR SERVICES; LOSS OF USE, DATA, OR PROFITS; OR BUSINESS INTERRUPTION) HOWEVER CAUSED AND ON ANY THEORY OF LIABILITY, WHETHER IN CONTRACT, STRICT LIABILITY, OR TORT (INCLUDING NEGLIGENCE OR OTHERWISE) ARISING IN ANY WAY OUT OF THE USE OF THIS SOFTWARE, EVEN IF ADVISED OF THE POSSIBILITY OF SUCH DAMAGE.

The license and distribution terms for any publically available version or derivative of this code cannot be changed. i.e. this code cannot simply be copied and put under another distribution license [including the GNU Public License.]

portmap

Copyright (c) 1998, Regents of the University of California All rights reserved.

Redistribution and use in source and binary forms, with or without modification, are permitted provided that the following conditions are met:

Redistributions of source code must retain the above copyright notice, this list of conditions and the following disclaimer.

Redistributions in binary form must reproduce the above copyright notice, this list of conditions and the following disclaimer in the documentation and/or other materials provided with the distribution.

Neither the name of the University of California, Berkeley nor the names of its contributors may be used to endorse or promote products derived from this software without specific prior written permission.

WARRANTIES, INCLUDING, BUT NOT LIMITED TO, THE IMPLIED WARRANTIES OF MERCHANTABILITY AND FITNESS FOR A PARTICULAR PURPOSE ARE DISCLAIMED. IN NO EVENT SHALL THE COPYRIGHT HOLDER OR CONTRIBUTORS BE LIABLE FOR ANY DIRECT, INDIRECT, INCIDENTAL, SPECIAL, EXEMPLARY, OR CONSEQUENTIAL DAMAGES (INCLUDING, BUT NOT LIMITED TO, PROCUREMENT OF SUBSTITUTE GOODS OR SERVICES; LOSS OF USE, DATA, OR PROFITS; OR BUSINESS INTERRUPTION) HOWEVER CAUSED AND ON ANY THEORY OF LIABILITY, WHETHER IN CONTRACT, STRICT LIABILITY, OR TORT (INCLUDING NEGLIGENCE OR OTHERWISE) ARISING IN ANY WAY OUT OF THE USE OF THIS SOFTWARE, EVEN IF ADVISED OF THE POSSIBILITY OF SUCH DAMAGE.

tcp wrappers

Copyright (c) 1998, Regents of the University of California All rights reserved.

Redistribution and use in source and binary forms, with or without modification, are permitted provided that the following conditions are met:

Redistributions of source code must retain the above copyright notice, this list of conditions and the following disclaimer.

Redistributions in binary form must reproduce the above copyright notice, this list of conditions and the following disclaimer in the documentation and/or other materials provided with the distribution.

Neither the name of the University of California, Berkeley nor the names of its contributors may be used to endorse or promote products derived from this software without specific prior written permission.

THIS SOFTWARE IS PROVIDED BY THE COPYRIGHT HOLDERS AND CONTRIBUTORS "AS IS" AND ANY EXPRESS OR IMPLIED WARRANTIES, INCLUDING, BUT NOT LIMITED TO, THE IMPLIED WARRANTIES OF MERCHANTABILITY AND FITNESS FOR A PARTICULAR PURPOSE ARE DISCLAIMED. IN NO EVENT SHALL THE COPYRIGHT HOLDER OR CONTRIBUTORS BE LIABLE FOR ANY DIRECT, INDIRECT, INCIDENTAL, SPECIAL, EXEMPLARY, OR CONSEQUENTIAL DAMAGES (INCLUDING, BUT NOT LIMITED TO, PROCUREMENT OF SUBSTITUTE GOODS OR SERVICES; LOSS OF USE, DATA, OR PROFITS; OR BUSINESS INTERRUPTION) HOWEVER CAUSED AND ON ANY THEORY OF LIABILITY, WHETHER IN CONTRACT, STRICT LIABILITY, OR TORT (INCLUDING NEGLIGENCE OR OTHERWISE) ARISING IN ANY WAY OUT OF THE USE OF THIS SOFTWARE, EVEN IF ADVISED OF THE POSSIBILITY OF SUCH DAMAGE.

FreeType

Portions of this software are copyright (c) 1996-2002, 2006 The FreeType Project (www.freetype.org). All rights reserved.

Legal Terms

0. Definitions

Throughout this license, the terms 'package', 'FreeType Project', and 'FreeType archive' refer to the set of files originally distributed by the authors (David Turner, Robert Wilhelm, and Werner Lemberg) as the 'FreeType Project', be they named as alpha, beta or final release.

'You' refers to the licensee, or person using the project, where 'using' is a generic term including compiling the project's source code as well as linking it to form a 'program' or 'executable'. This program is referred to as 'a program using the FreeType engine'.

This license applies to all files distributed in the original FreeType Project, including all source code, binaries and documentation, unless otherwise stated in the file in its original, unmodified form as distributed in the original archive. If you are unsure whether or not a particular file is covered by this license, you must contact us to verify this.

The FreeType Project is copyright (C) 1996-2000 by David Turner, Robert Wilhelm, and Werner Lemberg. All rights reserved except as specified below.

1. No Warranty

THE FREETYPE PROJECT IS PROVIDED 'AS IS' WITHOUT WARRANTY OF ANY KIND, EITHER EXPRESS OR IMPLIED, INCLUDING, BUT NOT LIMITED TO, WARRANTIES OF MERCHANTABILITY AND FITNESS FOR A PARTICULAR PURPOSE. IN NO EVENT WILL ANY OF THE AUTHORS OR COPYRIGHT HOLDERS BE LIABLE FOR ANY DAMAGES CAUSED BY THE USE OR THE INABILITY TO USE, OF THE FREETYPE PROJECT.

2. Redistribution

This license grants a worldwide, royalty-free, perpetual and irrevocable right and license to use, execute, perform, compile, display, copy, create derivative works of, distribute and sublicense the FreeType Project (in both source and object code forms) and derivative works thereof for any purpose; and to authorize others to exercise some or all of the rights granted herein, subject to the following conditions:

- Redistribution of source code must retain this license file ('FTL.TXT') unaltered; any additions, deletions or changes to the original files must be clearly indicated in accompanying documentation. The copyright notices of the unaltered, original files must be preserved in all copies of source files.
- Redistribution in binary form must provide a disclaimer that states that the software is based in part of the work of the FreeType Team, in the distribution documentation. We also encourage you to put an URL to the FreeType web page in your documentation, though this isn't mandatory.

These conditions apply to any software derived from or based on the FreeType Project, not just the unmodified files. If you use our work, you must acknowledge us. However, no fee need be paid to us.

3. Advertising

Neither the FreeType authors and contributors nor you shall use the name of the other for commercial, advertising, or promotional purposes without specific prior written permission.

We suggest, but do not require, that you use one or more of the following phrases to refer to this software in your documentation or advertising materials: 'FreeType Project', 'FreeType Engine', 'FreeType library', or 'FreeType Distribution'.

As you have not signed this license, you are not required to accept it. However, as the FreeType Project is copyrighted material, only this license, or another one contracted with the authors, grants you the right to use, distribute, and modify it. Therefore, by using, distributing, or modifying the FreeType Project, you indicate that you understand and accept all the terms of this license.

4. Contacts

There are two mailing lists related to FreeType:

- *freetype@nongnu.org* Discusses general use and applications of FreeType, as well as future and wanted additions to the library and distribution. If you are looking for support, start in this list if you haven't found anything to help you in the documentation.
- *freetype-devel@nongnu.org* Discusses bugs, as well as engine internals, design issues, specific licenses, porting, etc. Our home page can be found at

<http://www.freetype.org>

[libjpeg](#)

this software is based in part on the work of the Independent JPEG Group

[Vera.ttf](#)

Copyright (c) 2003 by Bitstream, Inc. All Rights Reserved. Bitstream Vera is a trademark of Bitstream, Inc.

Permission is hereby granted, free of charge, to any person obtaining a copy of the fonts accompanying this license ("Fonts") and associated documentation files (the "Font Software"), to reproduce and distribute the Font Software, including without limitation the rights to use, copy, merge, publish, distribute, and/or sell copies of the Font Software, and to permit persons to whom the Font Software is furnished to do so, subject to the following conditions:

The above copyright and trademark notices and this permission notice shall be included in all copies of one or more of the Font Software typefaces.

The Font Software may be modified, altered, or added to, and in particular the designs of glyphs or characters in the Fonts may be modified and additional glyphs or characters may be added to the Fonts, only if the fonts are renamed to names not containing either the words "Bitstream" or the word "Vera".

This License becomes null and void to the extent applicable to Fonts or Font Software that has been modified and is distributed under the "Bitstream Vera" names.

The Font Software may be sold as part of a larger software package but no copy of one or more of the Font Software typefaces may be sold by itself.

THE FONT SOFTWARE IS PROVIDED "AS IS", WITHOUT WARRANTY OF ANY KIND, EXPRESS OR IMPLIED, INCLUDING BUT NOT LIMITED TO ANY WARRANTIES OF MERCHANTABILITY, FITNESS FOR A PARTICULAR PURPOSE AND NONINFRINGEMENT OF COPYRIGHT, PATENT, TRADEMARK, OR OTHER RIGHT. IN NO EVENT SHALL BITSTREAM OR THE GNOME FOUNDATION BE LIABLE FOR ANY CLAIM, DAMAGES OR OTHER LIABILITY, INCLUDING ANY GENERAL, SPECIAL, INDIRECT, INCIDENTAL, OR CONSEQUENTIAL DAMAGES, WHETHER IN AN ACTION OF CONTRACT, TORT OR OTHERWISE, ARISING FROM, OUT OF THE USE OR INABILITY TO USE THE FONT SOFTWARE OR FROM OTHER DEALINGS IN THE FONT SOFTWARE.

Except as contained in this notice, the names of Gnome, the Gnome Foundation, and Bitstream Inc., shall not be used in advertising or otherwise to promote the sale, use or other dealings in this Font Software without prior written authorization from the Gnome Foundation or Bitstream Inc., respectively. For further information, contact: fonts at gnome dot org.

libtiff

Copyright (c) 1988-1997 Sam Leffler
Copyright (c) 1991-1997 Silicon Graphics, Inc.

Permission to use, copy, modify, distribute, and sell this software and its documentation for any purpose is hereby granted without fee, provided that (i) the above copyright notices and this permission notice appear in all copies of the software and related documentation, and (ii) the names of Sam Leffler and Silicon Graphics may not be used in any advertising or publicity relating to the software without the specific, prior written permission of Sam Leffler and Silicon Graphics.

THE SOFTWARE IS PROVIDED "AS-IS" AND WITHOUT WARRANTY OF ANY KIND, EXPRESS, IMPLIED OR OTHERWISE, INCLUDING WITHOUT LIMITATION, ANY WARRANTY OF MERCHANTABILITY OR FITNESS FOR A PARTICULAR PURPOSE. IN NO EVENT SHALL SAM LEFFLER OR SILICON GRAPHICS BE LIABLE FOR ANY SPECIAL, INCIDENTAL, INDIRECT OR CONSEQUENTIAL DAMAGES OF ANY KIND, OR ANY DAMAGES WHATSOEVER RESULTING FROM LOSS OF USE, DATA OR PROFITS, WHETHER OR NOT ADVISED OF THE POSSIBILITY OF DAMAGE, AND ON ANY THEORY OF LIABILITY, ARISING OUT OF OR IN CONNECTION WITH THE USE OR PERFORMANCE OF THIS SOFTWARE.

giflib

The GIFLIB distribution is Copyright (c) 1997 Eric S. Raymond

Permission is hereby granted, free of charge, to any person obtaining a copy of this software and associated documentation files (the "Software"), to deal in the Software without restriction, including without limitation the rights to use, copy, modify, merge, publish, distribute, sublicense, and/or sell copies of the Software, and to permit persons to whom the Software is furnished to do so, subject to the following conditions:

The above copyright notice and this permission notice shall be included in all copies or substantial portions of the Software.

THE SOFTWARE IS PROVIDED "AS IS", WITHOUT WARRANTY OF ANY KIND, EXPRESS OR IMPLIED, INCLUDING BUT NOT LIMITED TO THE WARRANTIES OF MERCHANTABILITY, FITNESS FOR A PARTICULAR PURPOSE AND NONINFRINGEMENT. IN NO EVENT SHALL THE AUTHORS OR COPYRIGHT HOLDERS BE LIABLE FOR ANY CLAIM, DAMAGES OR OTHER LIABILITY, WHETHER IN AN ACTION OF CONTRACT, TORT OR OTHERWISE, ARISING FROM, OUT OF OR IN CONNECTION WITH THE SOFTWARE OR THE USE OR OTHER DEALINGS IN THE SOFTWARE.

zlib

zlib License

This software is provided 'as-is', without any express or implied warranty. In no event will the authors be held liable for any damages arising from the use of this software.

Permission is granted to anyone to use this software for any purpose, including commercial applications, and to alter it and redistribute it freely, subject to the following restrictions:

1. The origin of this software must not be misrepresented; you must not claim that you wrote the original software. If you use this software in a product, an acknowledgment in the product documentation would be appreciated but is not required.
2. Altered source versions must be plainly marked as such, and must not be misrepresented as being the original software.
3. This notice may not be removed or altered from any source distribution.



■ FDA

-Caution-



Use of controls or adjustments or performance of procedures other than those specified herein may result in hazardous radiation exposure.

■ Playable Disc Types

This unit is compatible with NTSC and PAL color TV systems. Use discs that are labeled as NTSC or PAL. Capability of this unit to play discs other than NTSC or PAL TV system (SECAM) is not guaranteed.

Type and symbol of playable disc	Size/Playable Side	Max. play time
	12 cm/single-sided	Single layer 133 min.
	12 cm/Double-sided	Dual layer 242 min.
	12 cm/Double-sided	Single layer 266 min.
	12 cm/Single-sided	Dual layer 484 min.
		<MPEG 2 standard>
		at 27 Mbps 123 min.
		246 min.

■ Playable Disc Region Codes









Some DVD/Blu-ray™ discs have a region code such as , , , and this number shows the region the disc can be played in. Playable disc regions are restricted depending on the map coverage areas. If you play other discs, **Check Disc** message is displayed. In addition, some discs that do not have a region code number may still have a region restriction and may not be played on this unit.

▶▶ Playable Disc Types

Some discs may not function as expected. Also read the instruction book which comes with the disc.

Disc Symbols

The following symbols appear on DVD/Blu-ray™ discs or packing.

Symbol	Description
	Number of available soundtracks
	Number of available subtitles
	Number of angles
	Selectable screen aspect ratios (TV screen's horizontal to vertical ratio)
	16:9: Widescreen 4:3: Normal screen
	Selectable region codes
	ALL: Region free A number (ex. 1): Particular region code
	Selectable region codes
	ABC: Region free An alphabet (ex. A): Particular region code

For Dual Disc (double sided disc with both a DVD layer and a non-DVD layer), the DVD layer can be played as a Video DVD if the disc has the mark displayed on the right. Discs without the mark and the non-DVD layer are not supported, and operation cannot be guaranteed. In addition, the discs may be scratched when they are inserted or ejected.



Recommended Discs

Compression video is not supported. Compression audio specifications are below.

Media	CD-R/CD-RW DVD-R/DVD-RW DVD+R/DVD+RW		
Disc format	CD-ROM Mode1 CD-ROM Mode2 Form1 DVD-ROM		
File format	ISO9660 Level 1 & 2 Romeo, Joliet		
Audio format	MP3	WMA	AAC
Audio format specification	MPEG-1 AUDIO LAYER3 MPEG-2 AUDIO LAYER3 MPEG-2.5 AUDIO LAYER3	Microsoft Windows Media Audio Ver7,8,9	MPEG4-AAC m4a files created by iTunes (Apple)
Sampling frequency [kHz]	MPEG-1: 32/44.1/48 MPEG-2: 16/22.05/24 MPEG-2.5: 8/11.025/12	8/11.025/12/16/22.05/24/ 32/44.1/48 Exceptions not supported by DVD Player: 12/24	8/11.025/12/16/22.05/24/ 32/44.1/48
Bit rate [kbps]	MPEG1: 32/40/48/56/64/ 80/96/112/128/160/192/ 224/256/320 MPEG2: 8/16/24/32/40/48/ 56/64/80/96/112/128/144/ 160 MPEG2.5: 8/16/24/32/40/ 48/56/64/80/96/112/128/ 144/160	5/8/16/24/32/40/48/64/80/ 96/128/160/192/224/256/ 320/384 Exceptions not supported by DVD Player: 24/224/384	8/16/20/24/28/32/40/48/56/ 64/80/96/112/128/160/192/ 224/256/320/384/448/512/ 576 Exceptions not supported by DVD Player: 384/448/512/ 576
File extension	.mp3/.MP3	.wma/.WMA	.m4a/.M4A

Recommended Discs

Large files may take longer to change audio or fast-forward/fast-rewind.



Some CD-R/CD-RW/DVD-R/DVD-RW may not be read due to the discs' encoding properties. Use discs recorded with disc-at-once or track-at-once for this unit.

“AVCHD Progressive” and the “AVCHD Progressive” logo are trademarks of Panasonic Corporation and Sony Corporation.



DVD or Blu-ray™ Player Error Messages

If a disc error occurs, you may see the following error messages.

Error Message in Audio/Information Screen	Error Message in Overhead Screen	Cause	Solution
Problem ejecting disc from the player. Contact Honda dealer to fix this problem.	Problem ejecting disc from the player. Contact Honda dealer to fix this problem.	Disc stuck in player	<ul style="list-style-type: none"> • Contact a dealer and the player needs to be replaced.
There is a problem with the player. Eject and re-insert the disc. If this does not work, try another disc. If the error continues, contact Honda dealer.	There seems to be a problems playing this disc. Try inserting the disc into the Blu-ray player again.	Focus error Unsupported disc error Mechanical error Servo error DRM file access Error file access Device error	<ul style="list-style-type: none"> • Press the  button and remove the disc, and check that the error message is cleared. • Check that the disc is not damaged or deformed, and insert the disc again.  Protecting CDs P. 387
The system has overheated. Try to reduce the temperature by tuning the audio system off and allowing the player to cool down.	The Blu-ray player is too hot right now. Give it some time to cool off and try again later.	High temperature	<ul style="list-style-type: none"> • Turn the audio system off and allow the player to cool down until the error message is cleared.
Playback stopped. The content being played is protected by Cinavia and is not authorized for playback on this device.	Playback stopped. The content being played is protected by Cinavia™ and is not authorized for playback on this device. For more information, see http://www.cinavia.com . Message Code 1.	Cinavia 1 error	<ul style="list-style-type: none"> • Current track/file will be skipped. The next supported track/file plays automatically.

Error Message in Audio/ Information Screen	Error Message in Overhead Screen	Cause	Solution
<p>Audio outputs temporarily muted. Do not adjust the playback volume. The content being played is protected by Cinavia and is not authorized for playback on this device. For more information, see http://www.cinavia.com. Message Code 3.</p>	<p>Audio outputs temporarily muted. Do not adjust the playback volume. The content being played is protected by Cinavia™ and is not authorized for playback on this device. For more information, see http://www.cinavia.com. Message Code 3.</p>	<p>Cinavia 3 error</p>	<ul style="list-style-type: none"> • Current track/file will be skipped. The next supported track/file plays automatically.
<p>This disc cannot be played. Check that the disc is not damaged or deformed. If the disc is OK, see Owner's Manual for information on supported disc types and files.</p>	<p>There seems to be a problem with this disc. Please check if it might be damaged.</p>	<p>Region mismatch</p>	<ul style="list-style-type: none"> • Press the  button and remove the disc, and check that the error message is cleared. • Check the disk if region code is matched.
<p>—</p>	<p>Cannot access Blu-ray Player. Contact Honda dealer.</p>	<p>DTCP certificate error</p>	<ul style="list-style-type: none"> • Contact a dealer and the player needs to be replaced.

Customized Features

Models with color audio system

Use the audio/information screen to customize certain features.

■ How to customize

While the vehicle is at a complete stop with the power mode in ON, press the **MENU/CLOCK** button, then select **Settings**. To customize the phone settings, press the  button, then select **Phone Setup**.

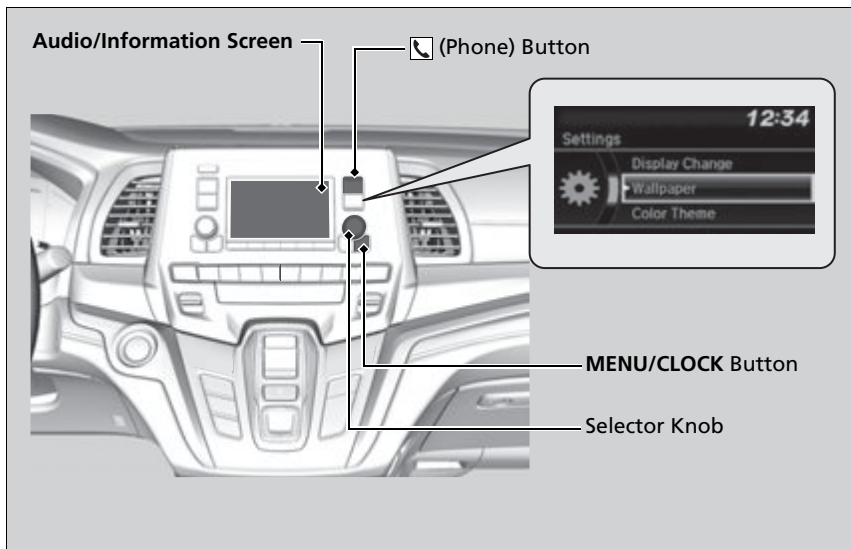

⌘ Customized Features



When you customize settings, make sure that the vehicle is at a complete stop and put the transmission into **P**.

⌘ How to customize

These indications are used to show how to operate the selector knob.

Rotate  to select.

Press  to enter.

To customize other features, select **Settings**, rotate , then press .



➔ **List of customizable options** P. 460

■ Customization flow

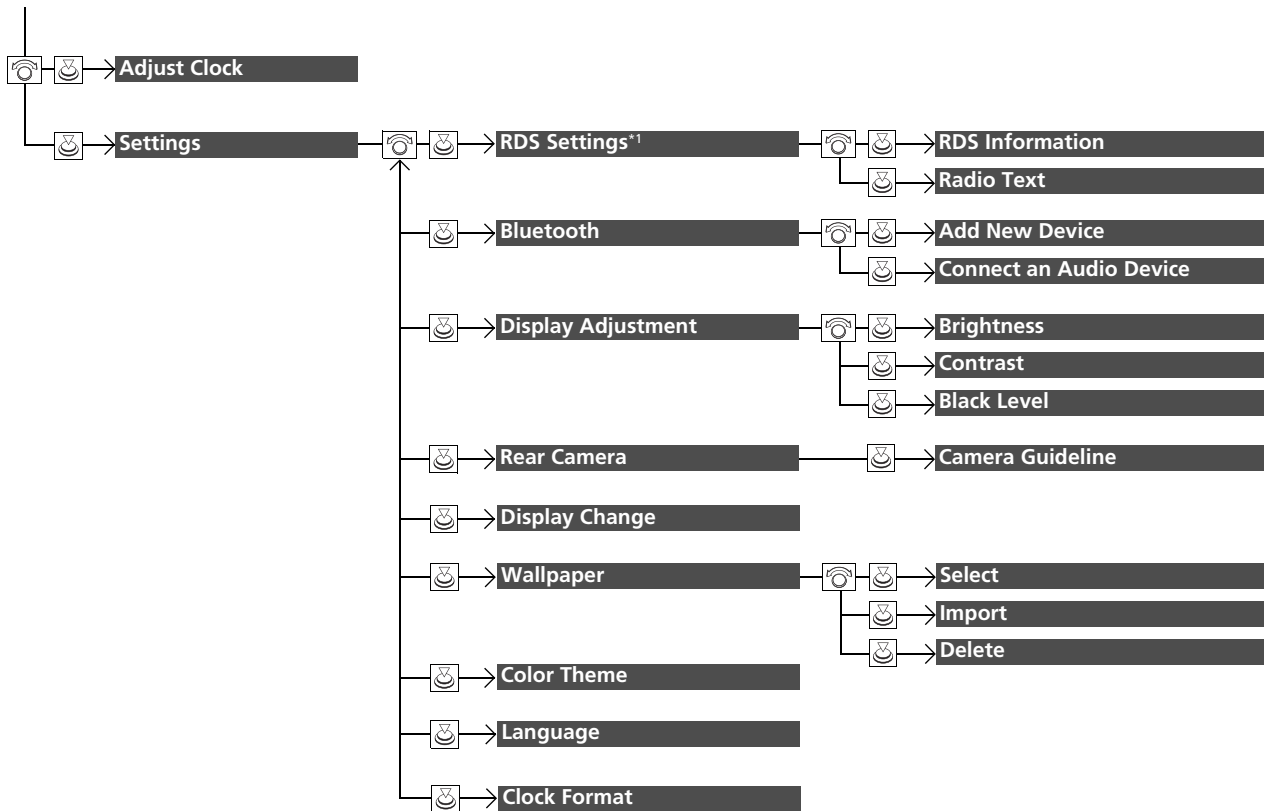
Press the MENU/CLOCK button.



*1: FM mode

Press the  button and rotate  to select **Phone Setup**, then press .

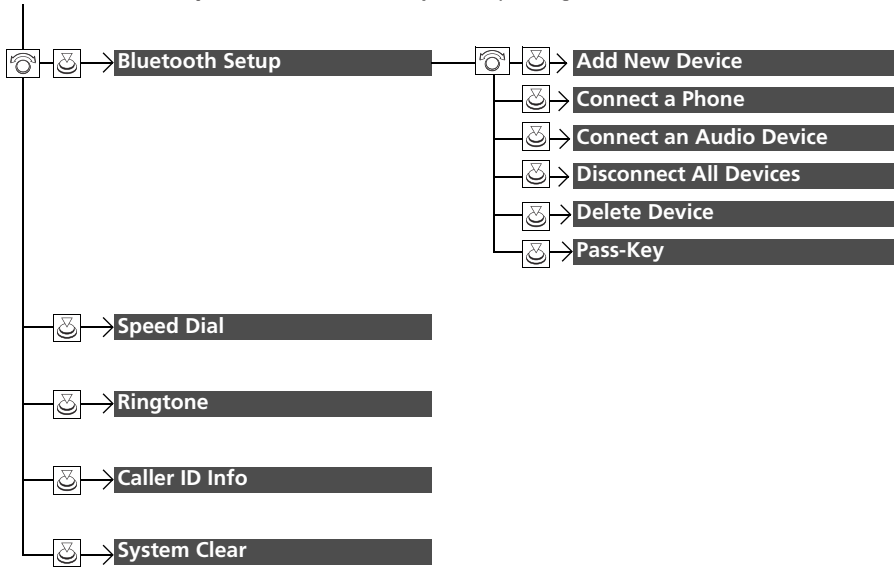

■ List of customizable options

Setup Group	Customizable Features	Description	Selectable Settings	
Settings	Adjust Clock	Adjusts clock. ➡ Clock P. 154	—	
	FM mode	RDS Information	Selects whether the RDS information comes on.	On*¹/Off
	RDS Settings	Radio Text	Displays the radio text information of the selected RDS station.	—
	Bluetooth	Add New Device Connect an Audio Device	See Bluetooth Setup on P. 462	
	Display Adjustment	Brightness	Changes the brightness of the audio/information screen.	—
		Contrast	Changes the contrast of the audio/information screen.	—
		Black Level	Changes the black level of the audio/information screen.	—
	Rear Camera	Camera Guideline	Selects whether the guidelines come on the audio/information screen.	On*¹/Off

*1:Default Setting

Setup Group	Customizable Features	Description	Selectable Settings
Settings	Display Change	Changes the display type.	Audio^{*1}/Wallpaper
	Wallpaper		
	Select	Changes the wallpaper type.	Clock^{*1}/Image1/Image2/ Image3
	Import	Imports an image file for a new wallpaper. 📁 Wallpaper Setup P. 285	—
	Delete	Deletes an image file for a wallpaper.	Image1^{*1}/Image2/Image3
	Color Theme	Changes the background color of the audio/ information screen.	Blue^{*1}/Red/Amber/Gray
	Language	Changes the display language.	English^{*1}/Français/Español
	Clock Format	Selects the digital clock display from 12h to 24h.	12h^{*1}/24h

*1:Default Setting

Setup Group	Customizable Features	Description	Selectable Settings
Phone Setup	Add New Device	Pairs a new phone to HFL. ➤ Phone Setup P. 491	—
	Connect a Phone	Pairs a new phone or connects a paired phone to HFL. ➤ Phone Setup P. 491	—
	Bluetooth Setup		
	Connect an Audio Device	Connects a <i>Bluetooth</i> ® Audio device to HFL.	—
	Disconnect All Devices	Disconnects a paired phone from HFL.	—
	Delete Device	Deletes a paired phone.	—
	Pass-Key	Changes a pairing code.	—
	Speed Dial	Edits, adds or deletes a speed dial entry. ➤ Speed Dial P. 500	—
	Ringtone	Selects the ring tone.	Mobile Phone * ¹ / Fixed
	Caller ID Info	Prioritizes the caller's name or phone number as the caller ID.	Name Priority * ¹ / Number Priority
System Clear	Cancels/Resets all customized items in the Phone Setup group as default.	—	

*1:Default Setting

Models with Display Audio

Use the audio/information screen to customize certain features.

■ How to customize

With the power mode in ON, select **Settings**, then select a setting item.

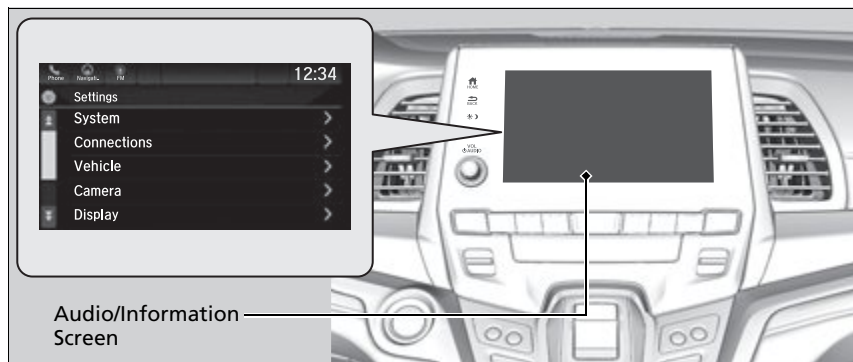

Customized Features

When you customize settings, make sure that the vehicle is at a complete stop and put the transmission into **P**.

To customize other features, select **Settings**.

➤ **List of customizable options** P. 470

■ Customization flow

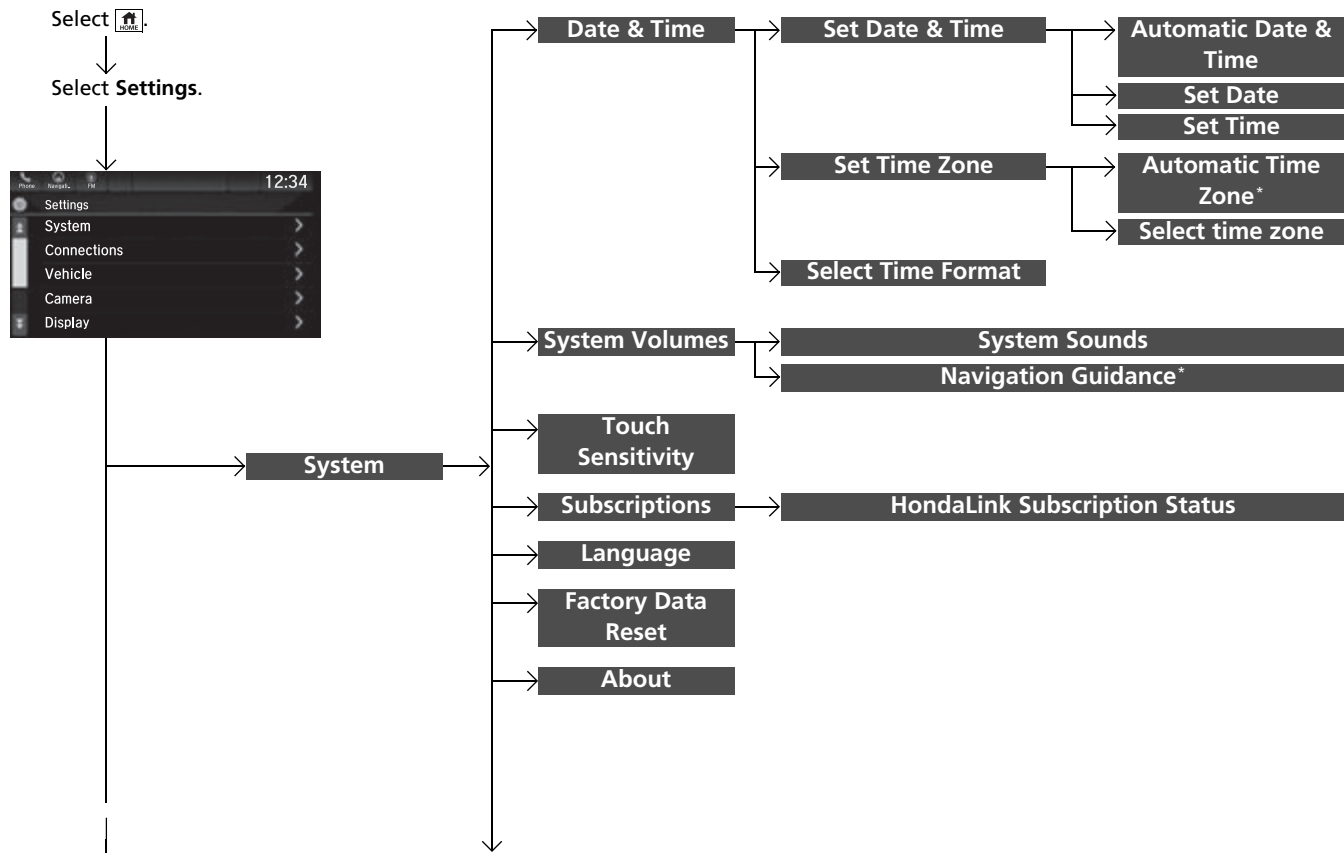

Features

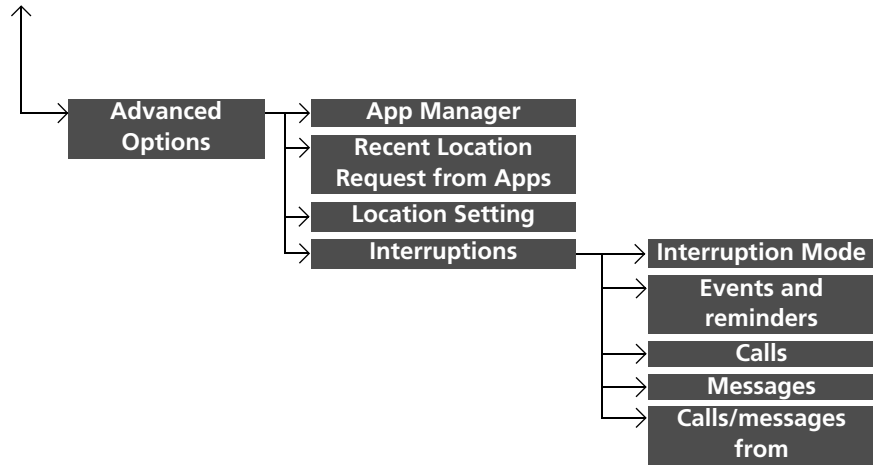

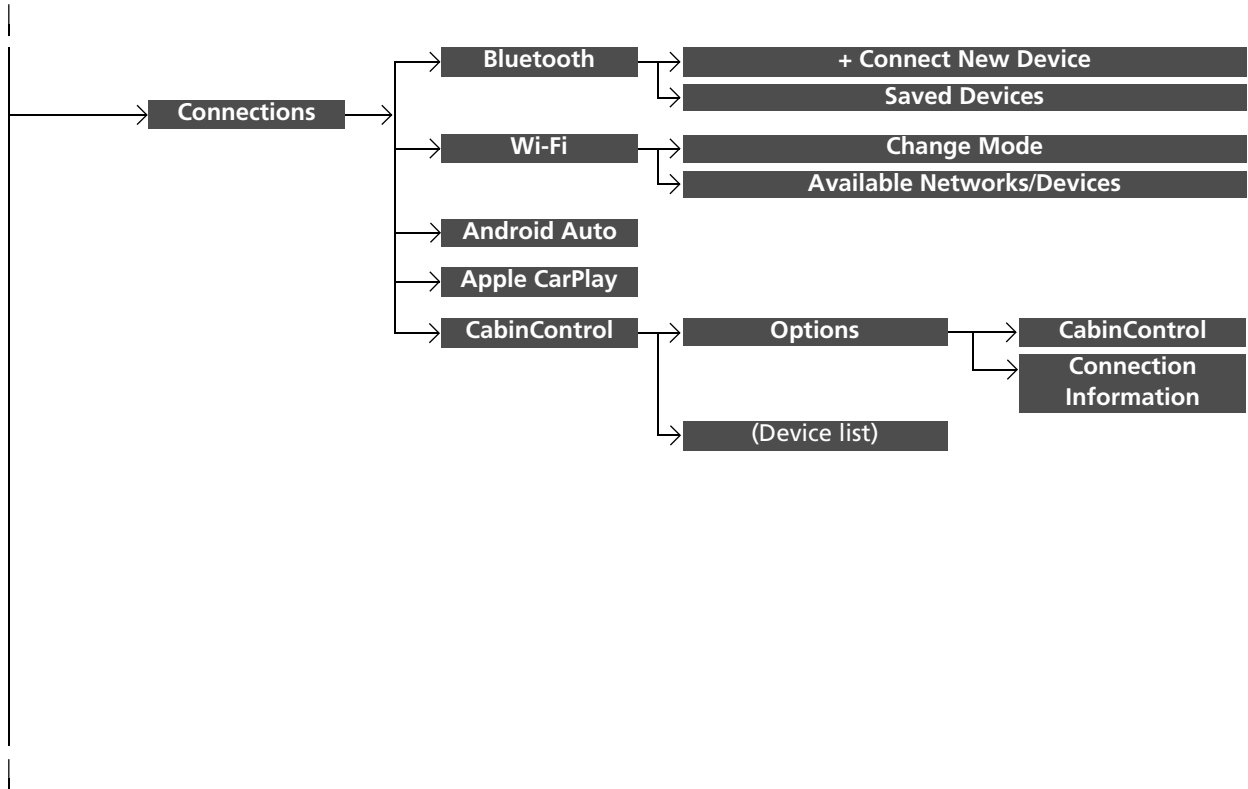

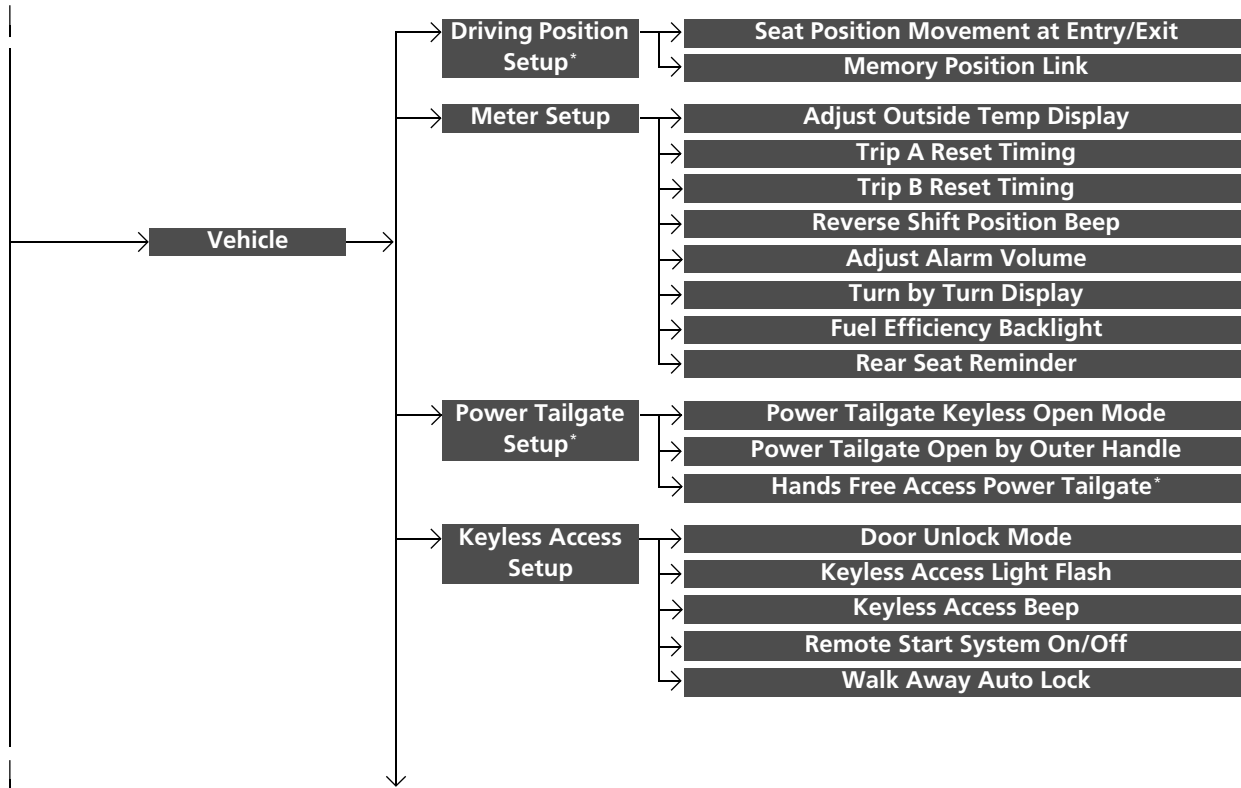

* Not available on all models

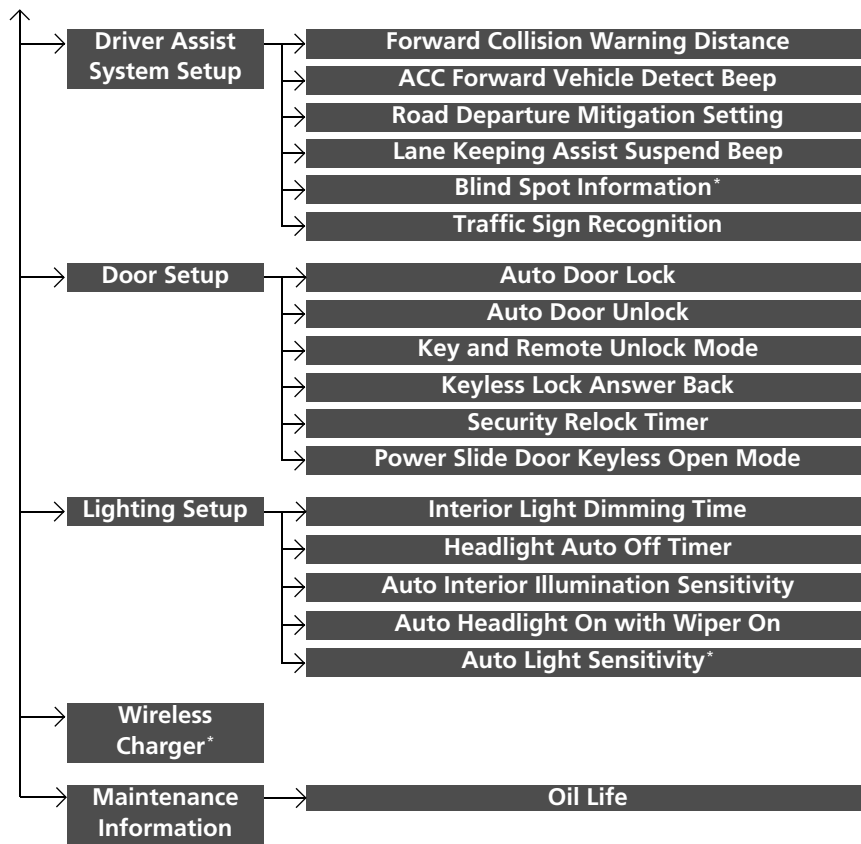

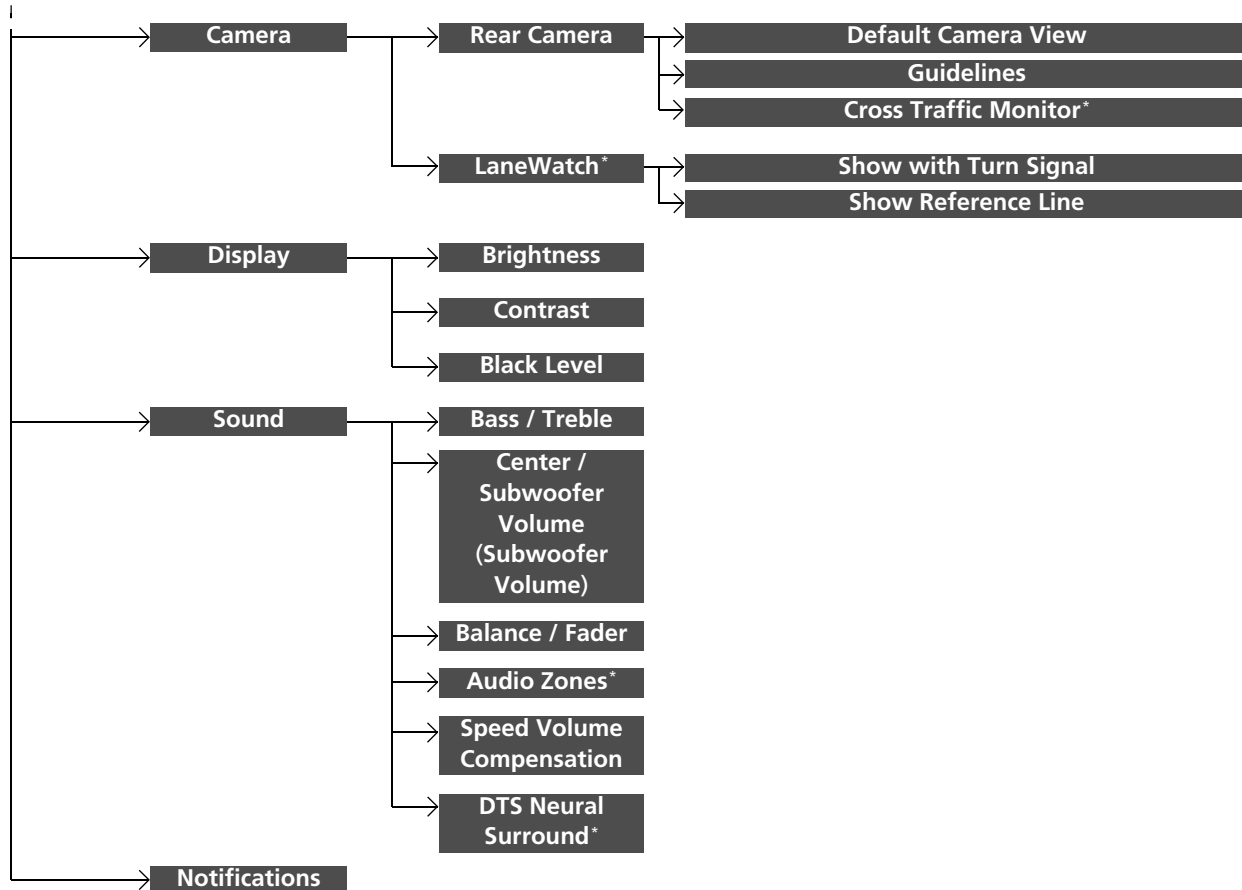

* Not available on all models

■ List of customizable options

Setup Group	Customizable Features	Description	Selectable Settings		
System	Date & Time	Automatic Date & Time	Selects ON to have the GPS automatically adjust the clock. Select OFF to cancel this function.	ON *1/ OFF	
		Set Date & Time	Set Date	Adjusts date. <input checked="" type="checkbox"/> Adjusting the Clock P. 154	—
		Set Time	Adjusts clock. <input checked="" type="checkbox"/> Adjusting the Clock P. 154	—	
	Date & Time	Set Time Zone	Automatic Time Zone*	Sets the navigation system to automatically adjust the clock when driving through different time zones.	ON *1/ OFF
		Select time zone	Changes the time zone manually.	—	
		Select Time Format	Selects the digital clock display from 12H to 24H.	12H *1/ 24H	

*1:Default Setting

Setup Group	Customizable Features	Description	Selectable Settings	
System	System Volumes	System Sounds	Changes the system sounds volume.	—
		Navigation Guidance*	Changes the navigation guidance volume.	—
	Touch Sensitivity		Sets the sensitivity of the touch panel screen.	High/Low* ¹
	Subscriptions	HondaLink Subscription Status	Lists subscriptions and subscription status for HondaLink®.	—
	Language		Changes the display language.	English (United States)* ¹ / English (United Kingdom)/ Korean/French/Spanish/Arabic
	Factory Data Reset		Resets all the settings to their factory default. 🔍 Defaulting All the Settings P. 481	Continue/Cancel
	About		Displays the Android setting items.	—

*1:Default Setting

* Not available on all models

Setup Group	Customizable Features	Description	Selectable Settings
System	Advanced Options	App Manager	Displays the Android system memory and apps information. —
		Recent Location Request from Apps	Displays the recent location requests from apps. —
		Location Setting	Selects OFF not to allow apps including the navigation system* to access the vehicle's location. ON*¹/OFF
	Inter-ruptions	Inter-ruption Mode	Sets the interruption mode for allowing to notify when calls and notifications arrive. Always interrupt*¹/ Don't interrupt/ Allow only priority interruptions
		Events and reminders	Sets priority interruptions of events and reminders. ON*¹/OFF
		Calls	Sets priority interruptions of calls. ON/OFF*¹
		Messages	Sets priority interruptions of messages. ON/OFF*¹
Calls/ messages from	Sets priority interruptions of from who. Anyone*¹/Contacts only/Starred contacts only		

*1:Default Setting

Setup Group	Customizable Features	Description	Selectable Settings	
Connections	Bluetooth	+ Connect New Device Pairs a new phone to HFL. 📱 Phone Setup P. 515	—	
		Saved Devices Connects, disconnects, or deletes a paired phone. 📱 Phone Setup P. 515	—	
	Wi-Fi	Change Mode Changes the Wi-Fi mode.	Network*¹/HotSpot/ OFF	
		Available Networks/ Devices Displays the available network(s) or current connected device(s).	—	
	Android Auto	Sets up the Android Auto connection.	—	
	Apple CarPlay	Sets up the Apple CarPlay connection.	—	
	CabinControl	Options	Cabin-Control Turns the Honda CabinControl function on and off.	ON*¹/OFF
			Connection Information Displays the Honda CabinControl connection information.	—
		(Device list)	Selects functions or deletes a device.	—

*1:Default Setting

Setup Group	Customizable Features	Description	Selectable Settings	
Vehicle	Driving Position Setup*	Seat Position Movement at Entry/Exit	Moves the seat rearward when you get in/get out of the vehicle. Changes the setting for this feature.	ON*¹/OFF
		Memory Position Link	Turns the driving position memory system on and off.	ON*¹/OFF
	Adjust Outside Temp Display	Adjusts the temperature reading by a few degrees.	-5°F ~ ±0°F*¹ ~ +5°F (U.S.) -3°C ~ ±0°C*¹ ~ +3°C (Canada)	
	Meter Setup	Trip A Reset Timing	Changes the setting of how to reset trip meter A and average fuel economy A.	With Refuel/IGN Off/Manually Reset*¹
		Trip B Reset Timing	Changes the setting of how to reset trip meter B and average fuel economy B.	With Refuel/IGN Off/Manually Reset*¹
		Reverse Shift Position Beep	Turns the reverse alert tone on and off.	ON*¹/OFF
	Adjust Alarm Volume	Changes the alarm volume, such as the buzzers, warnings, turn signal sound, and so on.	High/Mid*¹/Low	

*1:Default Setting

Setup Group	Customizable Features	Description	Selectable Settings	
Vehicle	Meter Setup	Turn by Turn Display	Selects whether the turn-by-turn display comes on during the route guidance.	ON*¹/OFF
		Fuel Efficiency Backlight	Turns the ambient meter feature on and off.	ON*¹/OFF
		Rear Seat Reminder	Turns the Rear Seat Reminder feature on and off.	ON*¹/OFF
	Power Tailgate Setup*	Power Tailgate Keyless Open Mode	Changes the keyless setting for when the power tailgate opens.	Anytime*¹/When Unlocked
		Power Tailgate Open by Outer Handle	Changes the setting to open power tailgate by tailgate outer handle.	Off (Manual only)/ On (Power/ Manual)*¹
		Hands Free Access Power Tailgate*	Changes the setting to open power tailgate by a swift forward in and out kicking motion under the rear bumper.	ON*¹/OFF
	Keyless Access Setup	Door Unlock Mode	Changes which doors unlock when you grab the driver's door handle.	Driver Door or Tailgate*¹/All Doors
		Keyless Access Light Flash	Causes some exterior lights to flash when you unlock/lock the doors.	ON*¹/OFF
		Keyless Access Beep	Causes the beeper to sound when you unlock/lock the doors.	ON*¹/OFF

*1:Default Setting

* Not available on all models

Setup Group	Customizable Features	Description	Selectable Settings	
Vehicle	Keyless Access Setup	Remote Start System On/Off	Turns the remote engine start feature on and off.	ON^{*1}/OFF
		Walk Away Auto Lock	Changes the settings for the automatic locking the doors when you walk away from the vehicle while carrying the remote.	Enable/Disable^{*1}
	Driver Assist System Setup	Forward Collision Warning Distance	Changes at which distance CMBS™ alerts.	Long/Normal^{*1}/Short
		ACC Forward Vehicle Detect Beep	Causes the system to beep when the system detects a vehicle, or when the vehicle goes out of the ACC with Low Speed Follow range.	ON/OFF^{*1}
		Road Departure Mitigation Setting	Changes the setting for the road departure mitigation system.	Normal^{*1}/Wide/Warning Only/Narrow
		Lane Keeping Assist Suspend Beep	Causes the system to beep when the LKAS is suspended.	ON/OFF^{*1}
		Blind Spot Information*	Changes the setting for the blind spot information system.	Audible and Visual Alert^{*1}/Visual Alert
		Traffic Sign Recognition	Selects whether the traffic sign icons come on the driver information interface.	ON^{*1}/OFF

*1: Default Setting

Setup Group	Customizable Features	Description	Selectable Settings	
Vehicle	Door Setup	Auto Door Lock	Changes the setting for the automatic locking feature.	With Vehicle Speed^{*1}/Shift from P/OFF
		Auto Door Unlock	Changes the setting for when the doors unlock automatically.	All Doors with Driver's Door Opens^{*1}/All Doors with Shift to P/All Doors with IGN Off/OFF
		Key and Remote Unlock Mode	Sets up either the driver's door or all doors to unlock on the first push of the remote or built-in key.	Driver Door^{*1}/All Doors
		Keyless Lock Answer Back	LOCK/UNLOCK- The exterior lights flash. LOCK (2nd push)- The beeper sounds.	ON^{*1}/OFF
		Security Relock Timer	Changes the time it takes for the doors to relock and the security system to set after you unlock the vehicle without opening any door.	90 sec/60 sec/30 sec^{*1}
		Power Slide Door Keyless Open Mode	Changes the keyless setting for when the power sliding door opens.	Anytime^{*1}/When Unlocked

*1:Default Setting

Setup Group	Customizable Features	Description	Selectable Settings
Vehicle	Interior Light Dimming Time	Changes the length of time the interior lights stay on after you close the doors.	60 sec/30 sec*¹/15 sec
	Headlight Auto Off Timer	Changes the length of time the exterior lights stay on after you close the driver's door.	60 sec/30 sec/15 sec*¹/0 sec
	Lighting Setup Auto Interior Illumination Sensitivity	Changes the sensitivity of the brightness of the instrument panel when the headlight switch is in the AUTO position.	Min/Low/Mid*¹/High/Max
	Auto Headlight On with Wiper On	Changes the settings for the wiper operation when the headlights automatically come on while the headlight switch is in the AUTO position.	ON*¹/OFF
	Auto Light Sensitivity*	Changes the timing for the headlights to come on.	Max/High/Mid*¹/Low/Min
	Wireless Charger*	Turns the wireless charger feature on and off.	ON*¹/OFF
Maintenance Information	Oil Life	Resets the engine oil life display when you have performed the maintenance service.	—

*1:Default Setting

Setup Group	Customizable Features	Description	Selectable Settings
Camera	Default Camera View	Changes the camera view mode when the rear camera monitor is turned on. <input checked="" type="checkbox"/> Multi-View Rear Camera P. 657	Last Used*¹/Normal View/Wide View
	Rear Camera Guidelines	Selects whether the guidelines come on the rear camera monitor. <input checked="" type="checkbox"/> Multi-View Rear Camera P. 657	Dynamic/Fixed/Both*¹/OFF
	Cross Traffic Monitor*	Turns the cross traffic monitor on and off.	ON*¹/OFF
	LaneWatch* Show with Turn Signal	Selects whether the LaneWatch display comes on when you move the turn signal lever to indicate a right turn.	ON*¹/OFF
	Show Reference Line	Selects whether the reference lines come on the LaneWatch monitor.	ON*¹/OFF
Display	Brightness	Adjusts the settings of the audio/information screen. <input checked="" type="checkbox"/> Display Setup P. 328	
	Contrast		
	Black Level		

*1:Default Setting

Setup Group	Customizable Features	Description	Selectable Settings
Sound	Bass / Treble	Adjusts the settings of the audio speakers' sound. 📖 Adjusting the Sound P. 327	
	Center / Subwoofer Volume (Subwoofer Volume)		
	Balance / Fader		
	Audio Zones*		
	Speed Volume Compensation		
	DTS Neural Surround*		
Notifications		Changes the notification settings for apps.	—

*1: Default Setting

Defaulting All the Settings

Reset all the menu and customized settings as the factory defaults.



1. Select .
2. Select **Settings**.
3. Select **System**.
4. Select **Factory Data Reset**.
 - A confirmation message appears on the screen.
5. Select **Continue** to reset the settings.
6. Select **Continue** again to reset the settings.
 - The system will reboot.

Defaulting All the Settings

When you transfer the vehicle to a third party, reset all settings to default and delete all personal data.

If you perform **Factory Data Reset**, it will reset the preinstalled apps to their factory default.

If you perform **Factory Data Reset**, you cannot use the HondaLink® because it becomes off line.

► **HondaLink®** P. 364

The HomeLink® Universal Transceiver can be programmed to operate up to three remote controlled devices around your home, such as garage doors, lighting, or home security systems.

■ Important Safety Precautions

Refer to the safety information that came with your garage door opener to test that the safety features are functioning properly. If you do not have the safety information, contact the manufacturer.

Before programming HomeLink, make sure that people and objects are out of the way of the garage or gate to prevent potential injury or damage.

When programming a garage door opener, park just outside the garage door's path.

⌘ HomeLink® Universal Transceiver*

Before programming HomeLink to operate a garage door opener, confirm that the opener has an external entrapment protection system, such as an "electronic eye," or other safety and reverse stop features. If it does not, HomeLink may not be able to operate it.

Training HomeLink

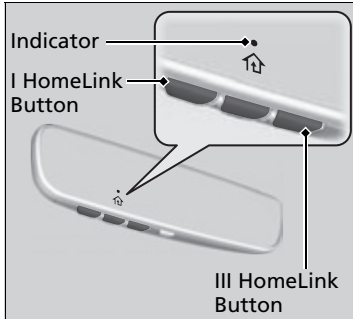

If it is necessary to erase a previously entered learned code:

- Press and hold the I and III HomeLink buttons for about 10 seconds, until the green indicator blinks. Release the buttons, and proceed to step 1.
- If you are training the second or third button, go directly to step 1.

The instructions on the next page should work for most gate or garage openers, but may not work for all. For detailed instructions about your specific remote opener, visit <http://www.homelink.com> or call (800) 355-3515.

Training HomeLink

NOTE:

Some LED lightbulbs installed in the garage door opener can interfere with the training and consistent operation of your HomeLink device. Please consider use of Low RF interference bulbs in your garage door opener.

■ Programming a Button

1. Position the remote transmitter you wish to link 1 to 3 inches (3 - 8 cm) from the HomeLink® button you want to program.

2. Press and release the desired HomeLink button. Is the HomeLink indicator (LED) *slowly flashing orange*?

YES

3a. Hold the button on the remote transmitter. Does HomeLink indicator (LED) change from *slowly flashing orange to rapidly flashing green or continuously on green*? The process should take less than 60 seconds.

4. Press and hold the programmed HomeLink button for about a second. Does the device (garage door opener) work?

YES

Training Complete

NO

5. Press and hold the HomeLink button again.

HomeLink LED is *continuously on green.*

6. Press and hold the HomeLink button again. The remote-controlled device should operate.

Training Complete

NO

3b. Canadian Garage Door Opener
 A. Press and release the HomeLink button. Press, hold and release the button on the remote every 2 secs. Does the HomeLink indicator (LED) change from *slowly flashing orange to rapidly flashing or continuously on green*? The process should take less than 60 seconds.

HomeLink indicator *rapidly flashes green.*

5a. The remote has a rolling code. Press the "learn" button on the remote-controlled device (e.g. garage door opener).

5b. Within 30 secs, press and hold the programmed HomeLink button for 2 secs.

▶▶ Training HomeLink

Reprogramming a Button
 If you want to retrain a programmed button for a new device, you do not have to erase all button memory. You can replace the existing memory code using this procedure:

- 1.** Press and hold the desired HomeLink button until the HomeLink indicator begins to *slowly flash orange*. This should take about 20 seconds.
- 2.** Release the HomeLink button and position the remote transmitter you wish to link 1 - 3 inches (3 - 8 cm) from the HomeLink button you want to program, then follow steps 3 - 6 under "programming a button."

Erasing Button Memory
 To erase programming from the buttons, press and hold the two outside HomeLink buttons until the HomeLink indicator changes from *orange to rapidly flashing green*. This should take about 10 seconds. You should erase all programming before selling the vehicle.

Operating
 To operate, simply press and release the programmed HomeLink button. Activation will now occur for the trained device.

Questions
 For questions or comments, visit www.HomeLink.com, www.youtube.com/HomeLinkGentex, or by calling the HomeLink Hotline (North America only) at (800) 355-3515.

HomeLink® is a registered trademark of Gentex Corporation.

Models with color audio system

Bluetooth® HandsFreeLink® (HFL) allows you to place and receive phone calls using your vehicle's audio system, without handling your cell phone.

Using HFL

HFL Buttons

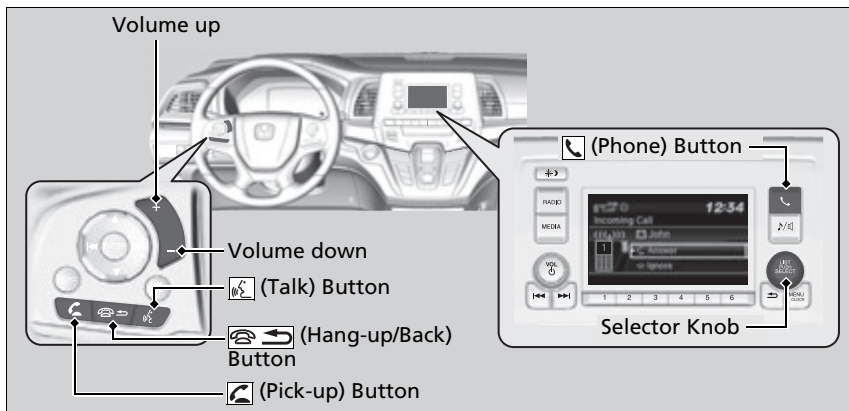

(Pick-up) button: Press to go directly to the Phone screen or to answer an incoming call.

(Hang-up/Back) button: Press to end a call or to cancel a command.

(Talk) button: Press to call a number with a stored voice tag.

(Phone) button: Press to go directly to the Phone screen.

Selector knob: Rotate to select an item on the screen, then press.

Using HFL

Place your phone where you can get good reception.

To use HFL, you need a Bluetooth-compatible cell phone. For a list of compatible phones, pairing procedures, and special feature capabilities:

- U.S.: Visit automobiles.honda.com/handsfreelink/, or call 1-888-528-7876.
- Canada: For more information on smartphone compatibility, call 1-888-528-7876.

Voice control tips

- Aim the vents away from the ceiling and close the windows, as noise coming from them may interfere with the microphone.
- Press and release the **(Talk)** button when you want to call a number using a stored voice tag. Speak clearly and naturally after a beep.
- If the microphone picks up voices other than yours, the command may be misinterpreted.
- To change the volume level, use the audio system's volume knob or the remote audio controls on the steering wheel.

State or local laws may prohibit the operation of handheld electronic devices while operating a vehicle.

Continued

■ HFL Status Display

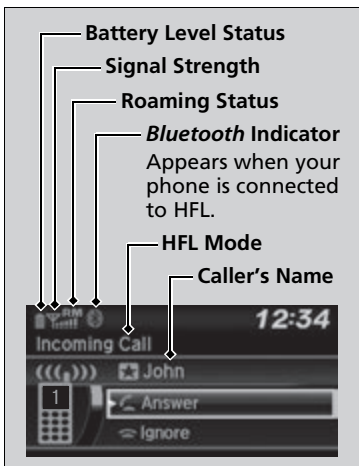

The audio/information screen notifies you when there is an incoming call.

■ Limitations for Manual Operation

Certain manual functions are disabled or inoperable while the vehicle is in motion. You cannot select a grayed-out option until the vehicle is stopped.

Only previously stored speed dial entries can be called using voice commands while the vehicle is in motion.

➤ **Speed Dial** P. 500

☒ Using HFL

If you receive a call while using the audio system, the system resumes its operation after ending the call.

Up to 20 speed dial entries can be stored. If there is no entry in the system, Speed Dial is disabled.

➤ **Speed Dial** P. 500

Up to 20 call histories can be stored. If there is no call history, Call History is disabled.

Bluetooth® Wireless Technology
The *Bluetooth®* word mark and logos are registered trademarks owned by *Bluetooth SIG, Inc.*, and any use of such marks by Honda Motor Co., Ltd., is under license. Other trademarks and trade names are those of their respective owners.

HFL Limitations
An incoming call on HFL will interrupt the audio system when it is playing. It will resume when the call is ended.

☒ HFL Status Display

The information that appears on the audio/information screen varies between phone models.

HFL Menu

The power mode must be in ACCESSORY or ON to use the system.

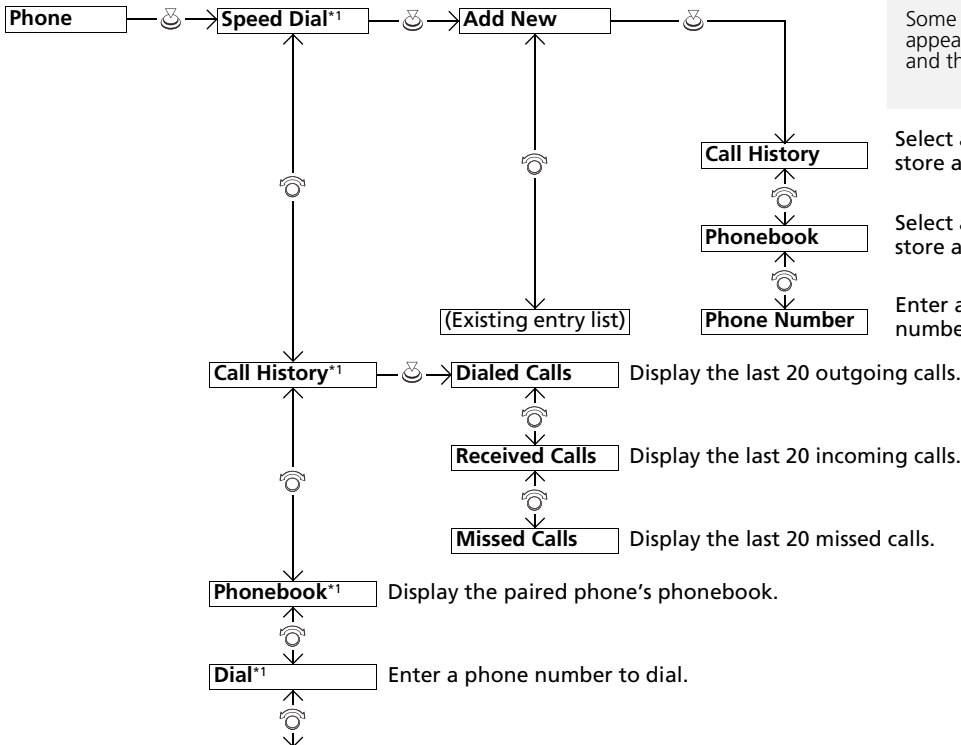

HFL Menu

To use HFL, you must first pair your *Bluetooth*-compatible cell phone to the system while the vehicle is parked.

Some functions are limited while driving. A message appears on the screen when the vehicle is moving and the operation is canceled.

Select a phone number from the call history to store as a speed dial number.

Select a phone number from the phonebook to store as a speed dial number.

Enter a phone number to store as a speed dial number.

Display the last 20 outgoing calls.

Display the last 20 incoming calls.

Display the last 20 missed calls.

Display the paired phone's phonebook.

Enter a phone number to dial.

*1: Appears only when a phone is connected to HFL.

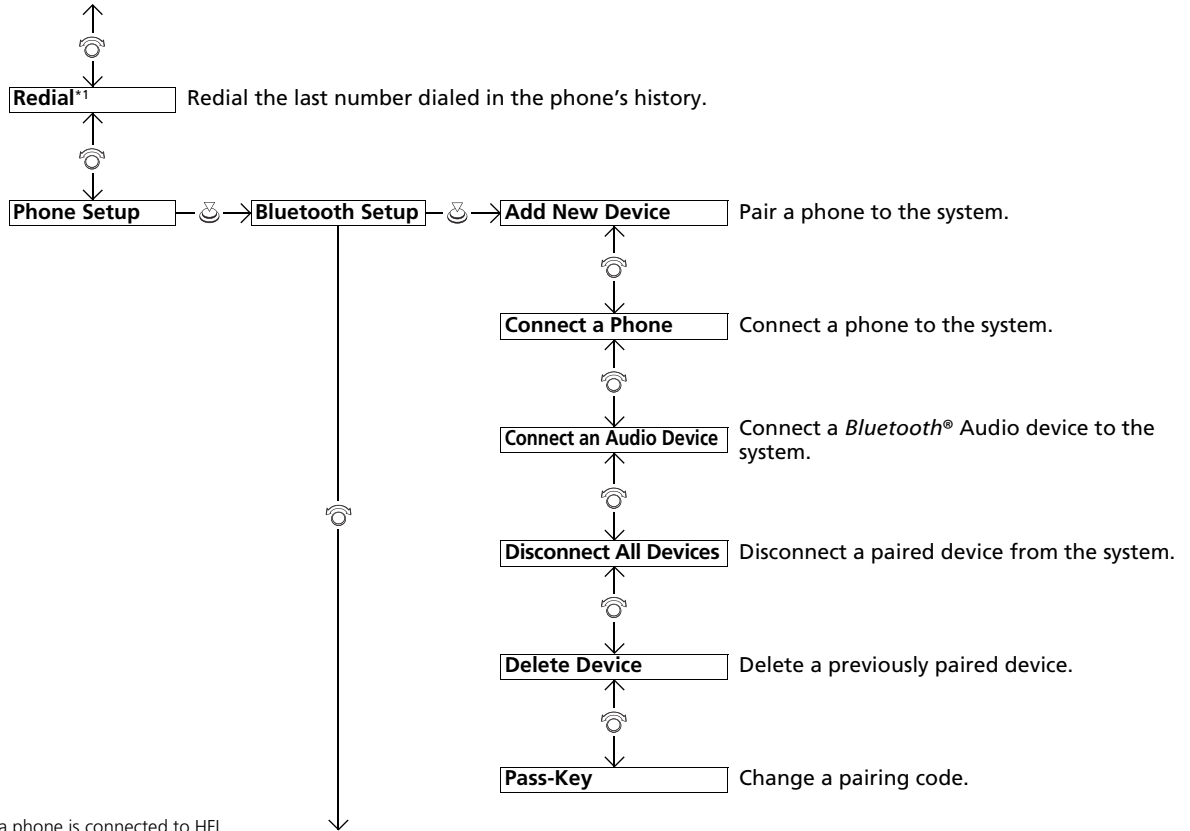

*1: Appears only when a phone is connected to HFL.

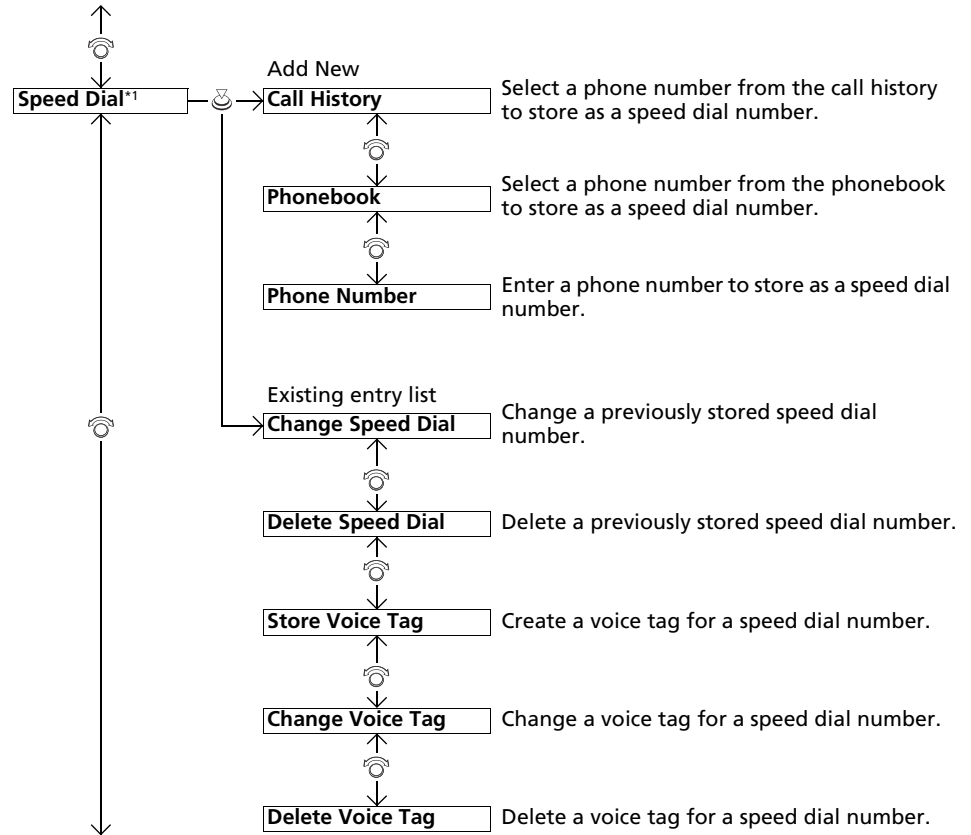

*1: Appears only when a phone is connected to HFL.

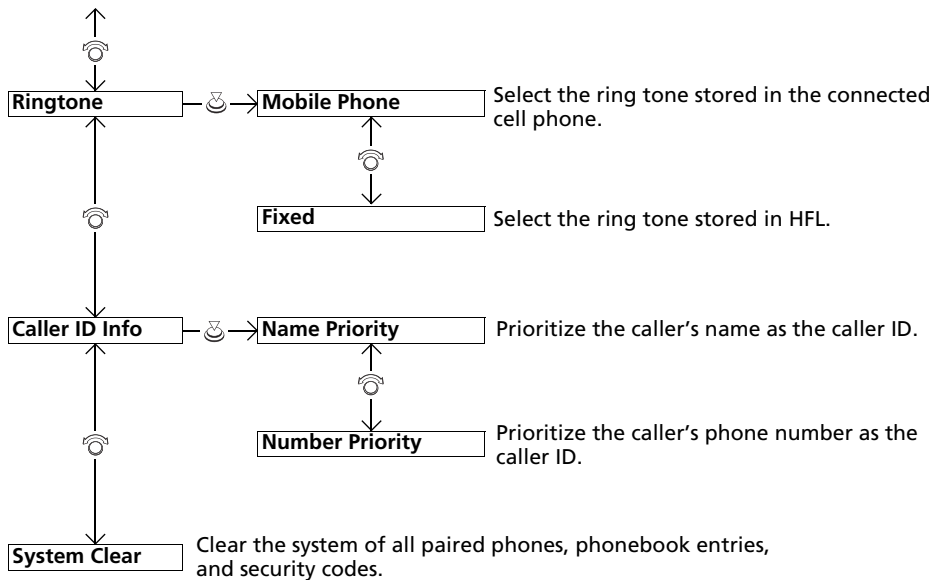

Phone Setup

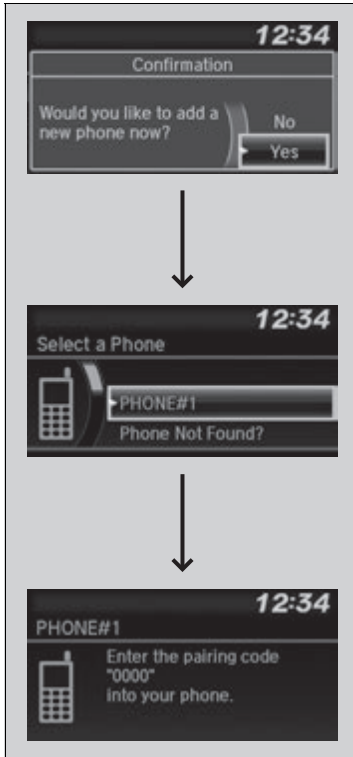

■ To pair a cell phone (when there is no phone paired to the system)

1. Press the button or the button.
2. Rotate to select **Yes**, then press .
3. Make sure your phone is in search or discoverable mode, then press .
 - ▶ HFL automatically searches for a *Bluetooth*® device.
4. When your phone appears on the list, select it by pressing .
 - ▶ If your phone does not appear, select **Phone Not Found?** and search for *Bluetooth*® devices using your phone. From your phone, select **HandsFreeLink**.
5. The system gives you a pairing code on the audio/information screen.
 - ▶ Confirm if the pairing code on the screen and your phone match. This may vary by phone.
6. A notification appears on the screen if pairing is successful.

☒ Phone Setup

Your *Bluetooth*-compatible phone must be paired to HFL before you can make and receive hands-free calls.

Phone Pairing Tips:

- You cannot pair your phone while the vehicle is moving.
- Up to six phones can be paired.
- Your phone's battery may drain faster when it is connected to HFL.
- If your phone is not ready for pairing or not found by the system within three minutes, the system will time out and return to idle.

Once you have paired a phone, you can see it displayed on the screen with one or two icons on the right side.







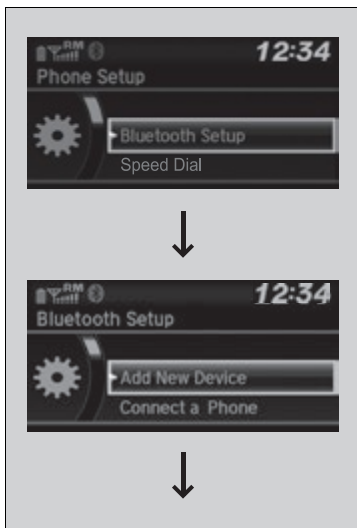

These icons indicate the following:

- : The phone can be used with HFL.
- : The phone is compatible with *Bluetooth*® Audio.

Continued



■ **To pair a cell phone (when a phone has already been paired to the system)**

1. Press the  button or the  button.
 - ▶ If a prompt appears asking to connect to a phone, select **No** and proceed with step 2.
2. Rotate  to select **Phone Setup**, then press .
3. Rotate  to select **Bluetooth Setup**, then press .
4. Rotate  to select **Add New Device**, then press .

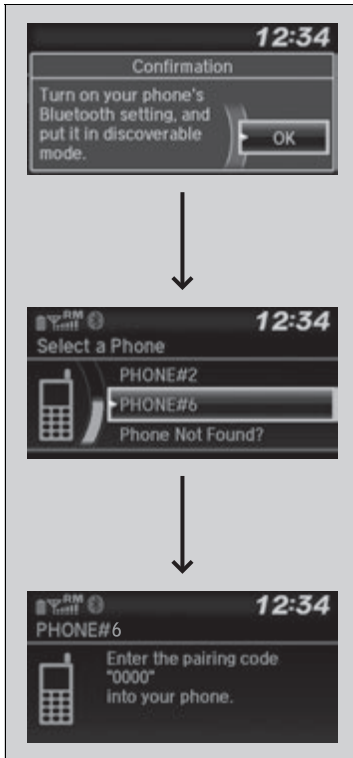

5. Make sure your phone is in search or discoverable mode, then press .
 - ▶ HFL automatically searches for a *Bluetooth*® device.

6. When your phone appears on the list, select it by pressing .
 - ▶ If your phone does not appear, select **Phone Not Found?** and search for *Bluetooth*® devices using your phone. From your phone, select **HandsFreeLink**.

7. The system gives you a pairing code on the audio/information screen.
 - ▶ Confirm if the pairing code on the screen and your phone match. This may vary by a phone.

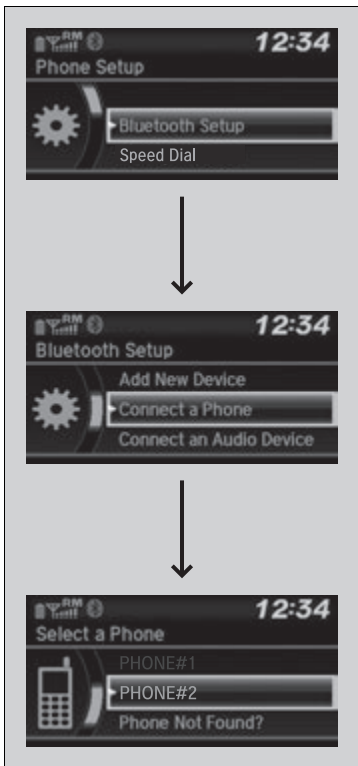

■ **To change the currently paired phone**

1. Press the button or the button.
2. Rotate to select **Phone Setup**, then press .
3. Rotate to select **Bluetooth Setup**, then press .

4. Rotate to select **Connect a Phone**, then press .
 - ▶ The screen changes to a device list.

5. Rotate to select a desired device name, then press .
 - ▶ HFL disconnects the connected phone and starts searching for another paired phone.

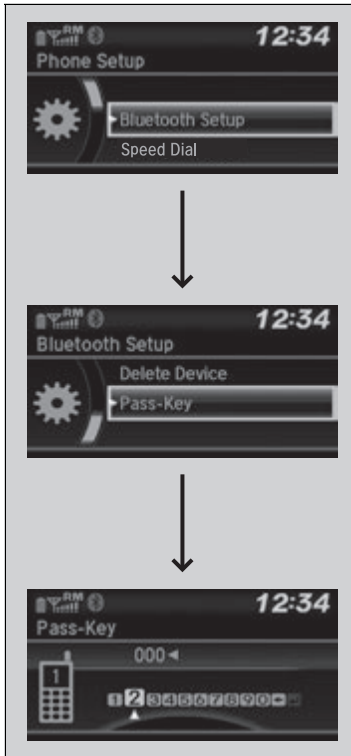

■ **To change the pairing code setting**

1. Press the button or the button.
2. Rotate to select **Phone Setup**, then press .
3. Rotate to select **Bluetooth Setup**, then press .
4. Rotate to select **Pass-Key**, then press .
5. Input a new pairing code, then press .

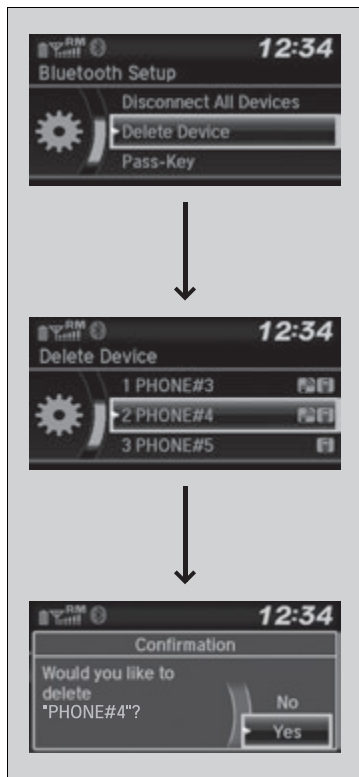

■ **To delete a paired phone**

1. Press the button or the button.
2. Rotate to select **Phone Setup**, then press .
3. Rotate to select **Bluetooth Setup**, then press .
4. Rotate to select **Delete Device**, then press .
 - ▶ The screen changes to a device list.
5. Rotate to select a phone you want to delete, then press .
6. A confirmation message appears on the screen. Rotate to select **Yes**, then press .

Ring Tone

You can change the ring tone setting.



1. Press the button or the button.
2. Rotate to select **Phone Setup**, then press .
3. Rotate to select **Ringtone**, then press .
4. Rotate to select **Mobile Phone** or **Fixed**, then press .

Caller's ID Information

You can select a caller's information to be displayed when you have an incoming call.

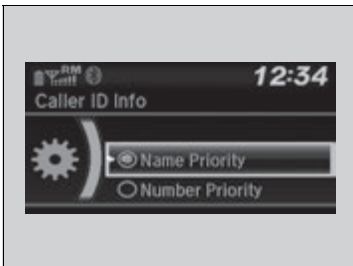

1. Press the button or the button.
2. Rotate to select **Phone Setup**, then press .
3. Rotate to select **Caller ID Info**, then press .
4. Rotate to select a mode you want, then press .

Ring Tone

Mobile Phone: For certain connected phones, the ring tone stored in the phone sounds from the speakers.

Fixed: The fixed ring tone sounds from the speakers.

Caller's ID Information

Name Priority: A caller's name is displayed if it is stored in the phonebook.

Number Priority: A caller's phone number is displayed.

■ To Clear the System

All speed dial entries, all imported phonebook data, all call history data, paired phones, pairing codes, caller's ID settings, and volume settings are reset as default.

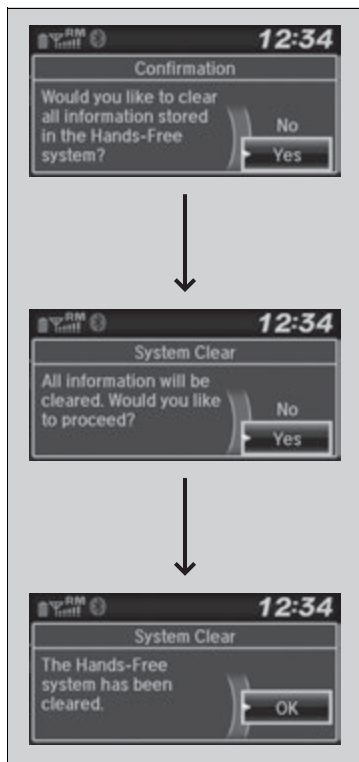

1. Press the button or the button.
 2. Rotate to select **Phone Setup**, then press .
 3. Rotate to select **System Clear**, then press .
 4. Rotate to select **Yes**, then press .
5. A confirmation message appears on the screen. Rotate to select **Yes**, then press .
6. A notification appears on the screen. Press .

Automatic Import of Cellular Phonebook and Call History

When your phone is paired, the contents of its phonebook and call history are automatically imported to HFL.



Automatic Import of Cellular Phonebook and Call History

When you select a name from the list in the cellular phonebook, you can see up to three category icons. The icons indicate what types of numbers are stored for that name.



If a name has four or more numbers, ... appears instead of category icons.

On some phones, it may not be possible to import the category icons to HFL.

The phonebook is updated after every connection. Call history is updated after every connection or call.

■ Speed Dial

Up to 20 speed dial numbers can be stored per phone.

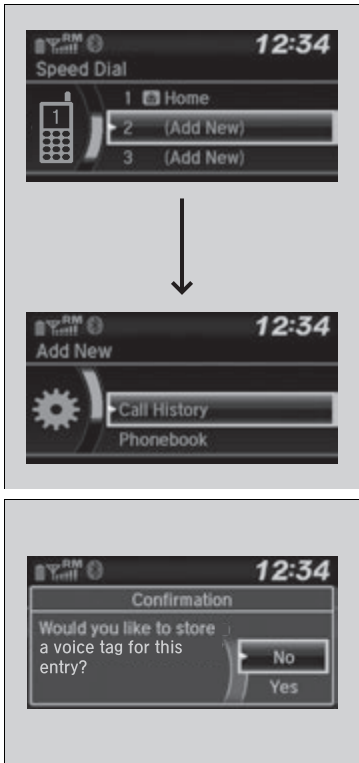

To store a speed dial number:

1. Press the button or the button.
2. Rotate to select **Speed Dial**, then press .
3. Rotate to select **Add New**, then press .
4. Rotate to select a place to choose a number from, then press .
 - From **Call History**:
 - ▶ Select a number from the call history.
 - From **Phonebook**:
 - ▶ Select a number from the connected cell phone's imported phonebook.
 - From **Phone Number**:
 - ▶ Input the number manually.
5. When the speed dial is successfully stored, you are asked to create a voice tag for the number. Rotate to select **Yes** or **No**, then press .
6. Using the button, follow the prompts to say the name for the speed dial entry.

▶▶ Speed Dial

You can use the audio preset buttons during a call to store a speed dial number:

1. Press and hold the desired audio preset button during a call.
2. The contact information for the active call will be stored for the corresponding speed dial.

When a voice tag is stored, you can press the button and call the number using voice commands.

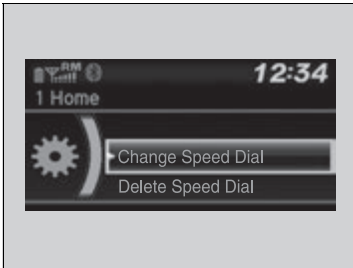

■ To edit a speed dial

1. Press the button or the button.
2. Rotate to select **Phone Setup**, then press .
3. Rotate to select **Speed Dial**, then press .
4. Select an existing speed dial entry.
5. Rotate to select **Change Speed Dial**, then press .
6. Select a new speed dial number, then press .

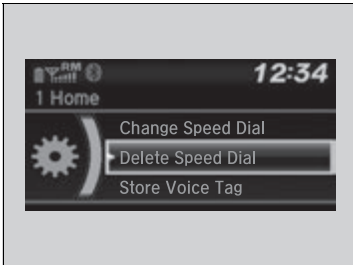

■ To delete a speed dial number

1. Press the button or the button.
2. Rotate to select **Phone Setup**, then press .
3. Rotate to select **Speed Dial**, then press .
4. Select an existing speed dial entry.
5. Rotate to select **Delete Speed Dial**, then press .
 - ▶ A confirmation message appears on the screen. Rotate to select **Yes**, then press .

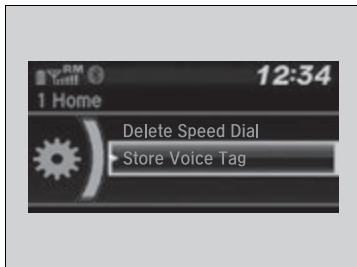

■ To add a voice tag to a stored speed dial number

1. Press the button or the button.
2. Rotate to select **Phone Setup**, then press .
3. Rotate to select **Speed Dial**, then press .
4. Select an existing speed dial entry.
5. Rotate to select **Store Voice Tag**, then press
 - ▶ A confirmation message appears on the screen. Rotate to select **Yes**, then press .
6. Using the button, follow the prompts to complete the voice tag.

▶▶ Speed Dial

Avoid using duplicate voice tags.
Avoid using "home" as a voice tag.
It is easier for HFL to recognize a longer name. For example, use "John Smith" instead of "John."

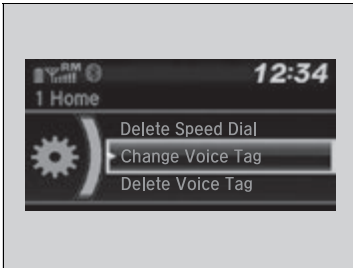

■ **To change a voice tag**

1. Press the button or the button.
2. Rotate to select **Phone Setup**, then press .
3. Rotate to select **Speed Dial**, then press .
4. Select an existing speed dial entry.
5. Rotate to select **Change Voice Tag**, then press .
 - ▶ A confirmation message appears on the screen. Rotate to select **Yes**, then press .
6. Using the button, follow the prompts to complete the voice tag.

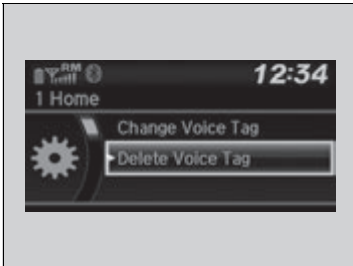

■ **To delete a voice tag**

1. Press the button or the button.
2. Rotate to select **Phone Setup**, then press .
3. Rotate to select **Speed Dial**, then press .
4. Select an existing speed dial entry.
5. Rotate to select **Delete Voice Tag**, then press .
 - ▶ A confirmation message appears on the screen. Rotate to select **Yes**, then press .

Continued

■ Making a Call

You can make calls by inputting any phone number, or by using the imported phonebook, call history, speed dial entries, or redial.

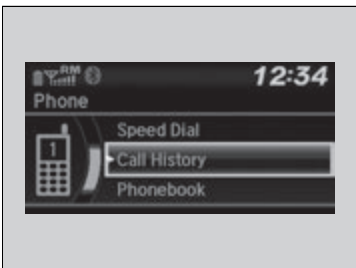

☞ Making a Call

Voice-tagged speed dial entries can be dialed by voice from any screen.

Press the  button and follow the prompts.

Once a call is connected, you can hear the voice of the person you are calling through the audio speakers.

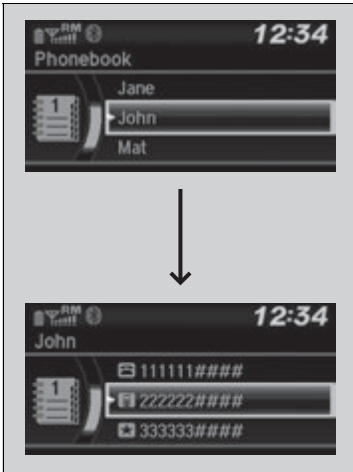

■ **To make a call using the imported phonebook**

When your phone is paired, the contents of its phonebook are automatically imported to HFL.

1. Press the button or the button.
 2. Rotate to select **Phonebook**, then press .
 3. The phonebook is stored alphabetically. Rotate to select the initial, then press .
 4. Rotate to select a name, then press .
 5. Rotate to select a number, then press .
- ▶ Dialing starts automatically.

■ **To make a call using a phone number**

1. Press the button or the button.
 2. Rotate to select **Dial**, then press .
 3. Rotate to select a number, then press .
 4. Rotate to select , then press .
- ▶ Dialing starts automatically.

☒ **To make a call using the imported phonebook**

This function is disabled while the vehicle is moving. However, you can call a stored voice-tagged speed dial number using voice commands.

- ☒ **Limitations for Manual Operation** P. 486
- ☒ **Speed Dial** P. 500

☒ **To make a call using a phone number**

This function is disabled while the vehicle is moving. However, you can call a stored voice-tagged speed dial number using voice commands.

- ☒ **Limitations for Manual Operation** P. 486
- ☒ **Speed Dial** P. 500

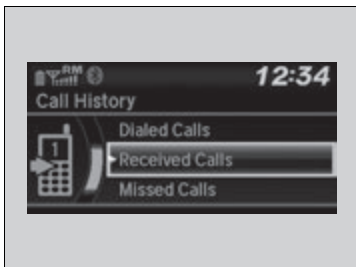

■ To make a call using redial

1. Press the button or the button.
2. Rotate to select **Redial**, then press .
- ▶ Dialing starts automatically.

■ To make a call using the call history

Call history is stored by **Dialed Calls**, **Received Calls**, and **Missed Calls**.

1. Press the button or the button.
2. Rotate to select **Call History**, then press .
3. Rotate to select **Dialed Calls**, **Received Calls**, or **Missed Calls**, then press .
4. Rotate to select a number, then press .
- ▶ Dialing starts automatically.

☒ To make a call using redial

Press and hold the button to redial the last number dialed in your phone's call history.

☒ To make a call using the call history

The call history appears only when a phone is connected to HFL, and displays the last 20 dialed, received, or missed calls. (Appears only when a phone is connected to the system.)

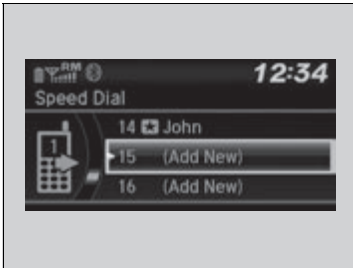

■ To make a call using a speed dial entry

1. Press the button or the button.
2. Rotate to select **Speed Dial**, then press .
3. Rotate to select a number, then press .
 - ▶ Dialing starts automatically.

☒ To make a call using a speed dial entry

On the **Phone** screen, the first six speed dials on the list can be directly selected by pressing the corresponding audio preset buttons (1-6).

Select **Others** to view another paired phone's speed dial list.

When a voice tag is stored, press the button and call the number using voice commands.

☒ **Speed Dial** P. 500

Voice-tagged speed dial entries can be dialed by voice from any screen. Press the button and follow the prompts.

■ Receiving a Call

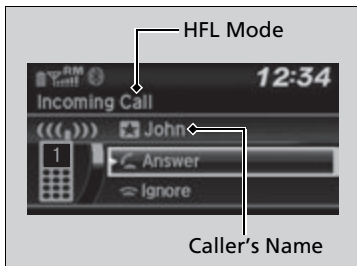

When there is an incoming call, an audible notification sounds and the **Incoming Call** screen appears.

Press the  button to answer the call.

Press the  button to decline or end the call.

▶ Receiving a Call





Call Waiting

Press the  button to put the current call on hold to answer the incoming call.

Press the  button again to return to the current call.

Select **Ignore** to ignore the incoming call if you do not want to answer it.

Press the  button if you want to hang up the current call.

You can select the icons on the audio/information screen instead of the  and  buttons. Rotate  to select the icon, then press .

Options During a Call

The following options are available during a call.

Swap Call: Put the current call on hold to answer the incoming call.

Mute: Mute your voice.

Transfer Call: Transfer a call from HFL to your phone.

Dial Tones: Send numbers during a call. This is useful when you call a menu-driven phone system.

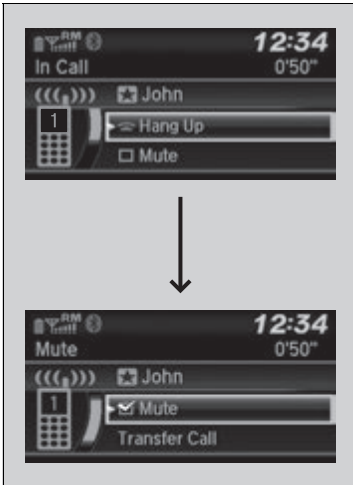

Rotate to select the option, then press .

- ▶ The check box is checked when **Mute** is selected. Select **Mute** again to turn it off.

Options During a Call

Dial Tones: Available on some phones.

Models with Display Audio

Bluetooth® HandsFreeLink® (HFL) allows you to place and receive phone calls using your vehicle's audio system, without handling your cell phone.

Using HFL

HFL Buttons

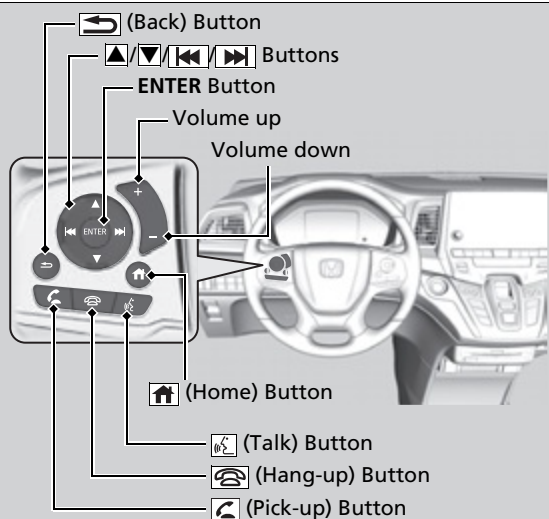

Bluetooth® HandsFreeLink®

Place your phone where you can get good reception.

To use HFL, you need a *Bluetooth*-compatible cell phone. For a list of compatible phones, pairing procedures, and special feature capabilities, ask a dealer or your Honda dealer.

To use the system, the **Bluetooth** setting must be **ON**.

➤ **Phone Setup** P. 515

Voice control tips

- Aim the vents away from the ceiling and close the windows, as noise coming from them may interfere with the microphones.
- Press the  button when you want to call a number using a phonebook name or a number. Speak clearly and naturally after a beep.
- If the microphones pick up voices other than yours, the command may be misinterpreted.
- To change the volume level, select the audio system's **VOL** (Volume) or use the remote audio controls on the steering wheel.

If there is no speed dial entry in the system, the pop-up notification appears on the screen.

➤ **Favorite Contacts** P. 520

If there is no call history, the call history is disabled.

 **(Pick-up) button:** Press to go directly to the phone screen of the driver information interface, or to answer an incoming call.

 **(Hang-up) button:** Press to end a call.

 **(Back) button:** Press to go back to the previous screen, or cancel a command.

 **(Talk) button:** Press to access Voice Portal.

 **buttons:** Press to select an item displayed on the phone screen of the driver information interface.

ENTER button: Press to call a number listed in the selected item on the phone screen of the driver information interface.

 **(Home) button:** Press to go back to the home screen of the driver information interface.

To go to the phone screen of the driver information interface:

1. Press the  (home) button on the steering wheel.
2. Select **Phone**.
 - ▶ You can select **Favorite Contacts** or **Recent Calls**.

Bluetooth® HandsFreeLink®

Bluetooth® Wireless Technology

The *Bluetooth®* word mark and logos are registered trademarks owned by *Bluetooth SIG, Inc.*, and any use of such marks by Honda Motor Co., Ltd., is under license. Other trademarks and trade names are those of their respective owners.

HFL Limitations

An incoming call on HFL will interrupt the audio system when it is playing. It will resume when the call is ended.

■ HFL Status Display

The audio/information screen notifies you when there is an incoming call.



▣ HFL Status Display

The information that appears on the audio/information screen varies between phone models.

■ Limitations for Manual Operation *

Certain manual functions are disabled or inoperable while the vehicle is in motion. You cannot select a grayed-out option until the vehicle is stopped.

Only previously stored phonebook names or numbers can be called using voice commands while the vehicle is in motion.

➤ **Favorite Contacts** P. 520

HFL Menu

The power mode must be in ACCESSORY or ON to use the system.

■ Phone settings screen

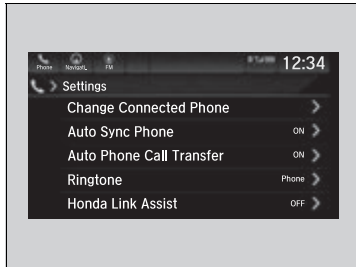

1. Select .
2. Select **Phone**.
3. Select **Settings**.

☒ HFL Menu

To use HFL, you must first pair your *Bluetooth*-compatible cell phone to the system while the vehicle is parked.

Some functions are limited while driving.

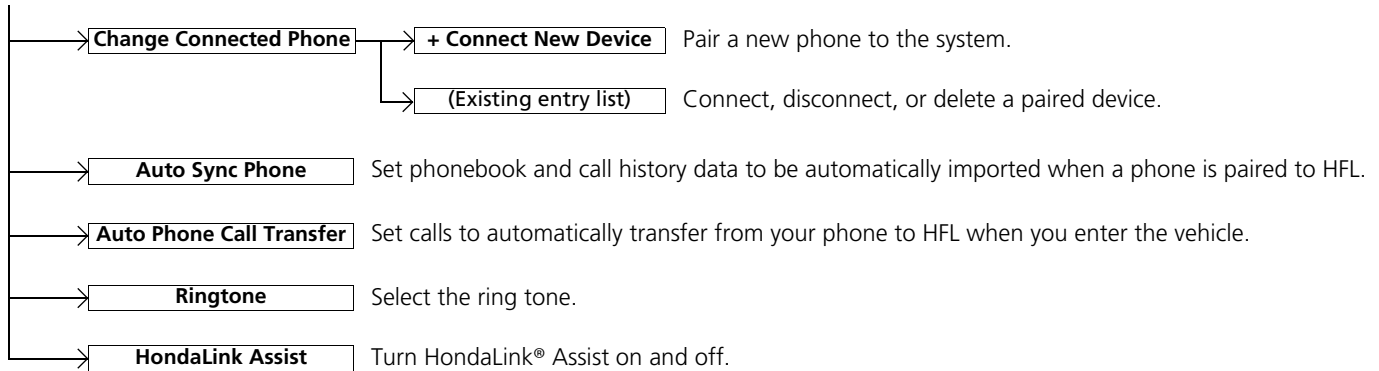

■ Phone menu screen

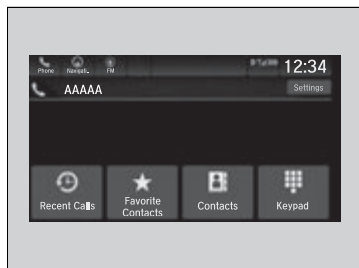

1. Select .
2. Select **Phone**.

Features

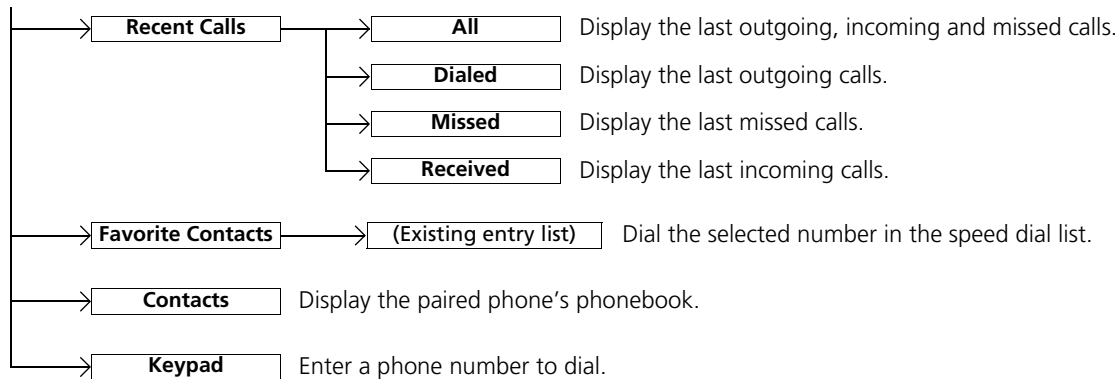

Phone Setup

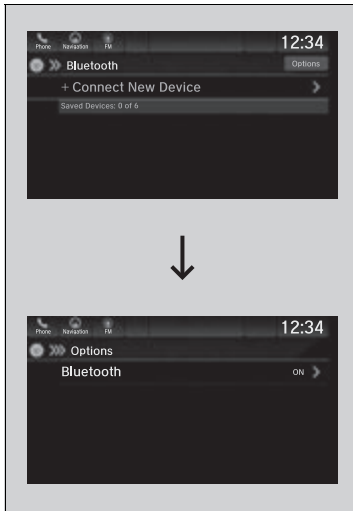

■ **Bluetooth®** setup

You can turn *Bluetooth®* function on and off.

1. Select .
2. Select **Settings**.
3. Select **Connections**.
4. Select **Bluetooth**.
5. Select **Options**.
6. Select **Bluetooth**, then **ON**.

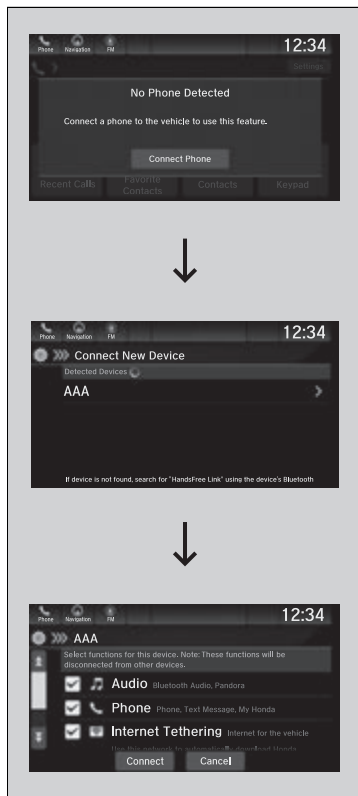

■ **To pair a cell phone (when there is no phone paired to the system)**

1. Select .
2. Select **Phone**.
3. Select **Connect Phone**.
4. Make sure your phone is in search or discoverable mode, then select **+ Connect New Device**.
 - ▶ HFL automatically searches for a *Bluetooth*® device.
5. Select your phone when it appears on the list.
 - ▶ If your phone still does not appear, search for *Bluetooth*® devices using your phone. From your phone, search for **HandsFree Link**.
6. The system gives you a pairing code on the audio/information screen.
 - ▶ Confirm if the pairing code on the screen and your phone match. This may vary by phone.
7. Select desired functions and then select **Connect**.
 - ▶ A confirmation message appears on the screen. Select **Continue** or **Connect without Internet**.

▶▶ Phone Setup



Your *Bluetooth*-compatible phone must be paired to the system before you can make and receive hands-free calls.

Phone Pairing Tips:

- You cannot pair your phone while the vehicle is moving.
- Up to six phones can be paired.
- Your phone's battery may drain faster when it is paired to the system.
- If your phone is not ready for pairing or not found by the system within three minutes, the system will time out and return to idle.

Once you have paired a phone, you can see it displayed on the screen with one or more icons on the right side.



These icons indicate the following:

- : The phone is compatible with *Bluetooth*® Audio.
- : The phone can be used with HFL.
- : The phone can be used with the internet tethering.

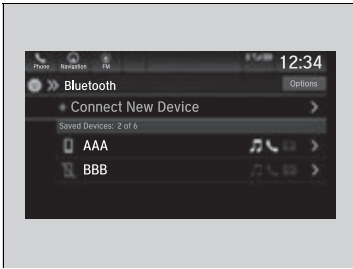
If there is an active connection to Apple CarPlay or Android Auto, pairing of additional *Bluetooth* compatible devices is unavailable and **+ Connect New Device** is grayed out from the **Bluetooth** screen.



■ **To change the currently paired phone**

1. Go to the phone settings screen.
 ▶ **Phone settings screen** P. 513
2. Select **Change Connected Phone**.
3. Select a phone to connect.
 ▶ HFL disconnects the connected phone and starts searching for another paired phone.
4. Select ,  or .
5. Select **Apply**.

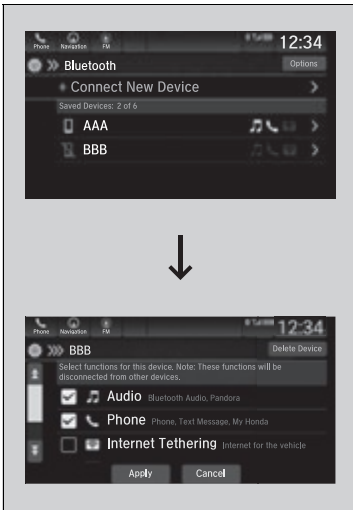

■ **To delete a paired phone**

1. Go to the phone settings screen.
 ▶ **Phone settings screen** P. 513
2. Select **Change Connected Phone**.
3. Select a phone you want to delete.
4. Select **Delete Device**.
5. A confirmation message appears on the screen. Select **Delete**.

☒ **To change the currently paired phone**

If no other phones are found or paired when trying to switch to another phone, HFL will inform you that the original phone is connected again.

To pair other phones, select + **Connect New Device** from the **Bluetooth** screen.

■ Ring Tone

You can change the ring tone setting.

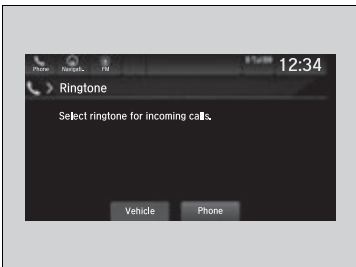

1. Go to the phone settings screen.
▶ **Phone settings screen** P. 513
2. Select **Ringtone**.
3. Select **Vehicle** or **Phone**.

■ Automatic Transferring

If you get into the vehicle while you are on the phone, the call can be automatically transferred to HFL.

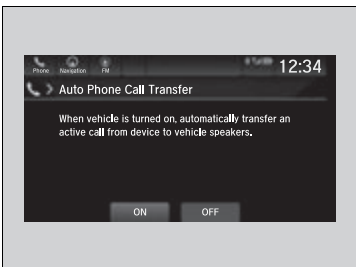

1. Go to the phone settings screen.
▶ **Phone settings screen** P. 513
2. Select **Auto Phone Call Transfer**.
3. Select **ON** or **OFF**.

▶▶ Ring Tone

Vehicle: The fixed ring tone sounds from the speakers.

Phone: Depending on the make and model of the mobile phone, the ring tone stored in the phone will sound if the phone is connected.

Automatic Import of Cellular Phonebook and Call History

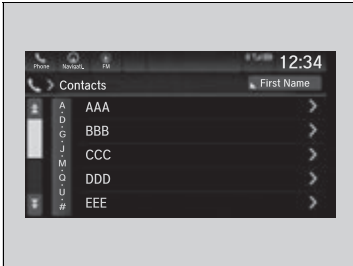

■ When Automatic Phone Sync is set to On:

When your phone is paired, the contents of its phonebook and call history are automatically imported to the system.

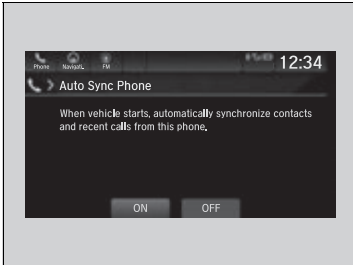

■ Changing the Automatic Phone Sync setting

1. Go to the phone settings screen.
 - ▶ **Phone settings screen** P. 513
2. Select **Auto Sync Phone**.
3. Select **ON** or **OFF**.

▶▶ Automatic Import of Cellular Phonebook and Call History

When you select a name from the list in the cellular phonebook, you can see a category icon. The icons indicate what types of numbers are stored for that name.

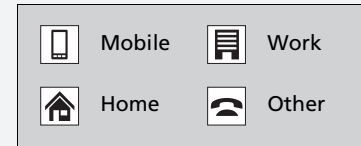

On some phones, it may not be possible to import the category icons to the system.

The phonebook is updated after every connection. Call history is updated after every connection or call.

Favorite Contacts

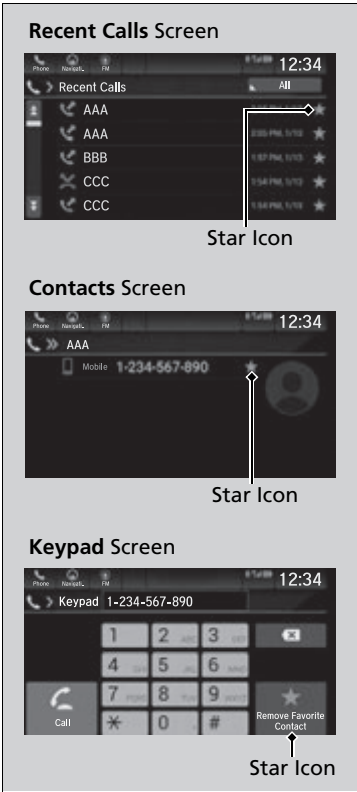

To store a speed dial number:

1. Go to the phone menu screen.
 - ▶ **Phone menu screen** P. 514
2. Select the **Recent Calls, Contacts,** or **Keypad** screen.
3. Select the star icon.
 - ▶ A notification appears on the screen if the speed dial is successfully stored.
 - ▶ To remove the speed dial, select the star icon again.

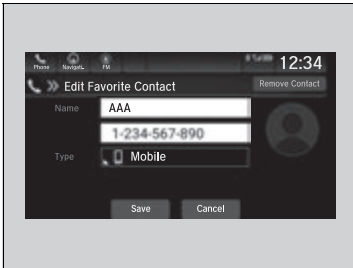

■ To edit a speed dial

1. Go to the phone menu screen.
➤ **Phone menu screen** P. 514
2. Select **Favorite Contacts**.
3. Select **Edit** on the speed dial entry you want to edit.
4. Select a setting you want.

■ To delete a speed dial

1. Go to the phone menu screen.
➤ **Phone menu screen** P. 514
2. Select **Favorite Contacts**.
3. Select **Edit** on the speed dial entry you want to delete.
4. Select **Remove Contact**.
5. A confirmation message appears on the screen. Select **Continue**.

■ Making a Call

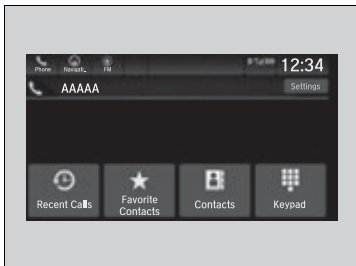

You can make calls by inputting any phone number, or by using the imported phonebook, call history, or speed dial entries.

☞ Making a Call

Once a call is connected, you can hear the voice of the person you are calling through the audio speakers.

While there is an active connection with Apple CarPlay, phone calls cannot be made with HandsFreeLink® and are only made from Apple CarPlay.

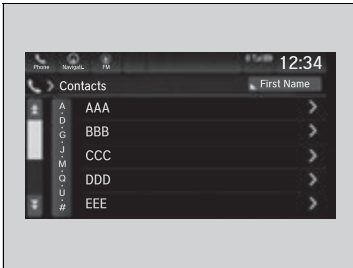

■ **To make a call using the imported phonebook**

1. Go to the phone menu screen.
▶ **Phone menu screen** P. 514
2. Select **Contacts**.
3. Select a name.
▶ You can sort by **First Name** or **Last Name**. Select the icon on the upper right of the screen.
4. Select a number.
▶ Dialing starts automatically.

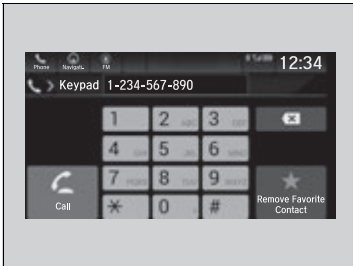

■ **To make a call using a phone number**

1. Go to the phone menu screen.
▶ **Phone menu screen** P. 514
2. Select **Keypad**.
3. Select a number.
▶ Use the keyboard on the touch screen for entering numbers.
4. Select **Call**.
▶ Dialing starts automatically.

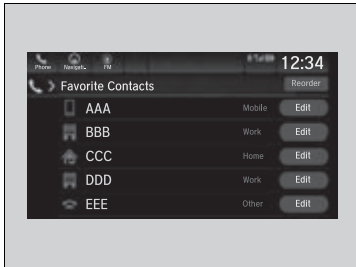
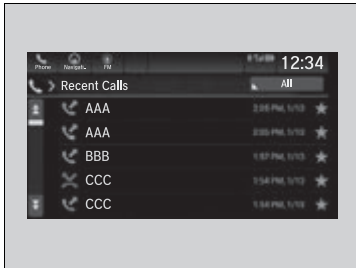

■ **To make a call using the call history**

Call history is stored by **All**, **Dialed**, **Missed**, and **Received**.

1. Go to the phone menu screen.
 - ▶ **Phone menu screen** P. 514
2. Select **Recent Calls**.
 - ▶ You can sort by **All**, **Dialed**, **Missed**, or **Received**. Select the icon on the upper right of the screen.
3. Select a number.
 - ▶ Dialing starts automatically.

■ **To make a call using a speed dial entry**

1. Go to the phone menu screen.
 - ▶ **Phone menu screen** P. 514
2. Select **Favorite Contacts**.
 - ▶ You can change the order of speed dial entries by selecting **Reorder**.
3. Select a number.
 - ▶ Dialing starts automatically.



▶▶ To make a call using the call history

The call history appears only when a phone is connected to the system.

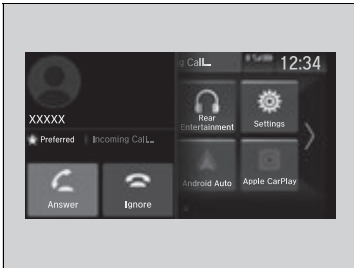
Receiving a Call



When there is an incoming call, an audible notification sounds (if activated) and the **Incoming Call...** screen appears.

Press the  button to answer the call.
Press the  button to decline or end the call.

Options During a Call

The following options are available during a call.

Mute: Mute your voice.

Use Handheld: Transfer a call from the system to your phone.

Keypad: Send numbers during a call. This is useful when you call a menu-driven phone system.

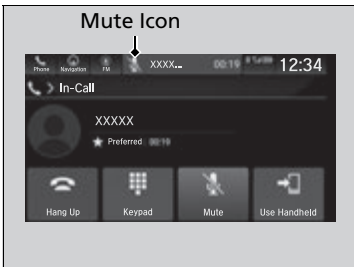

The available options are shown on the lower half of the screen.

Select the option.

- ▶ The mute icon appears when **Mute** is selected. Select **Mute** again to turn it off.

Receiving a Call



Call Waiting

Press the  button to put the current call on hold to answer the incoming call.

Press the  button again to return to the current call.

Select **Ignore** to ignore the incoming call if you do not want to answer it.

Press the  button if you want to hang up the current call.

You can select the icons on the audio/information screen instead of the  and  buttons.

Options During a Call

Keypad: Available on some phones.

You can select the icons on the audio/information screen.

■ To Set Up Text Message Options

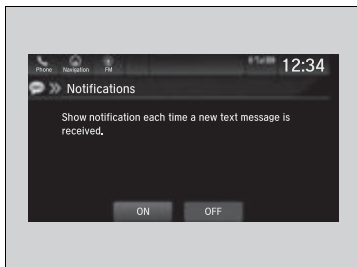

■ To turn on or off the text message notice

1. Select .
2. Select **Messages**.
3. Select **Settings**.
4. Select **Notifications**.
5. Select **ON** or **OFF**.

▶▶ To Set Up Text Message Options

To use the text message function, it may be necessary to set up on your phone.

▶▶ To turn on or off the text message notice

ON: A pop-up notification comes on every time you receive a new message.

OFF: The message you receive is stored in the system without notification.

Receiving a Text Message

HFL can display newly received text messages as well as the last 20 messages received on a linked cell phone. Each received message can be read aloud and replied to using a fixed common phrase.

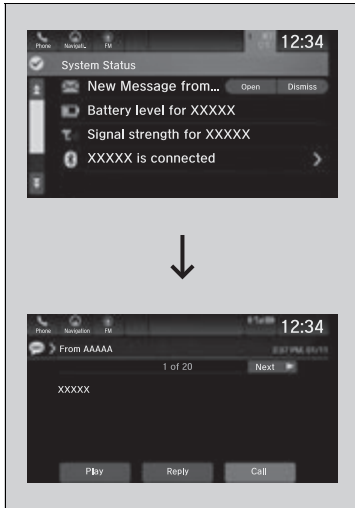

1. A pop-up appears and notifies you of a new text message.
2. Select **Open** to display the message.
 - ▶ The text message is displayed.
3. Select **Play** to listen to the message. To discontinue the message read-out, select **Stop**.

Receiving a Text Message

The system does not display any received messages while you are driving. You can only hear them read aloud.

The system can only receive messages that are sent a text (SMS) messages. The message sent using the data services will not be displayed in the list.

With some phones, you may be able to display up to 20 of the last text messages received.

State or local laws may limit your use of the HFL text message feature. Only use the text message feature when conditions allow you to do so safely.

■ Selecting a Phone

You can select one from the *Bluetooth*® device list to be active and receive notifications.

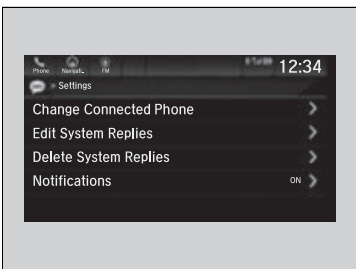

1. Select .
2. Select **Messages**.
3. Select **Settings**.
4. Select **Change Connected Phone**.
5. Change a desired phone.
 - ▣ **To change the currently paired phone**
P. 517

▶▶ Selecting a Phone

You can only receive notifications from one phone at a time.

Displaying Messages

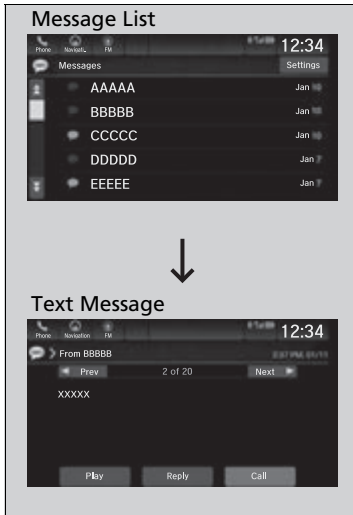



1. Select .
2. Select **Messages**.
 - ▶ Select a phone if necessary.
3. Select a message.
 - ▶ The text message is displayed.

Displaying Messages

The  (blue) icon appears next to an unread message.

If you delete a message on the phone, the message will also be deleted from the system. If you send a message from the system, the message goes to your phone's outbox.

To see the previous or next message, select  **Prev** or **Next**  on the message screen.

Continued

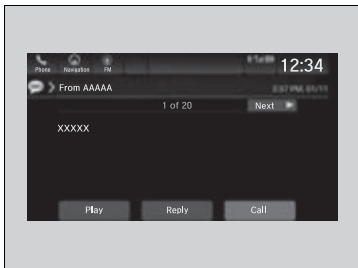

■ Read or Stop reading a message

1. Go to the text message screen.
2. Select **Play**.
 - ▶ The system starts reading the message aloud.
3. Select **Pause** to stop reading. Select **Play** again to start reading the message.



■ Reply to a message

1. Go to the text message screen.
2. Select **Reply**.
3. Select the reply message.
 - ▶ The pop-up menu appears on the screen.
4. Select **Send** to send the message.
 - ▶ **Message sent** appears on the screen when the reply message was successfully sent.

☒ Reply to a message

The available fixed reply messages are as follows:

- **Talk to you later, I'm driving.**
- **I'm on my way.**
- **I'm running late.**
- **OK**
- **Yes**
- **No**

You can add a reply message by selecting **+ Create New Message**.

☒ **To edit a reply message** P. 531

Only certain phones receive and send messages when paired and connected. For a list of compatible phones:

- U.S.: Visit automobiles.honda.com/handsfreelink/, or call 1-888-528-7876.
- Canada: For more information on smartphone compatibility, call 1-888-528-7876.

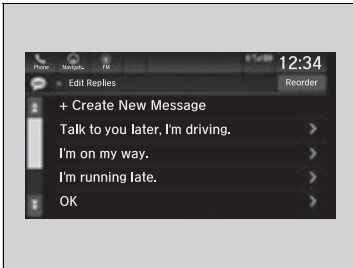

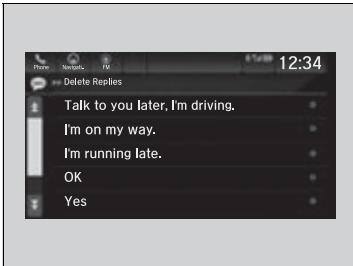

■ **To edit a reply message**

1. Select .
2. Select **Messages**.
3. Select **Settings**.
4. Select **Edit System Replies**.
5. Select the reply message you want to edit or **+ Create New Message**.
 - ▶ The on-screen keyboard screen is displayed.
6. Enter a reply message, and then select **Save**.



■ **To delete a reply message**

1. Select .
2. Select **Messages**.
3. Select **Settings**.
4. Select **Delete System Replies**.
5. Select  on the reply message you want to delete.
 - ▶ The pop-up menu appears on the screen.
6. Select **Delete**.

☒ To edit a reply message

You can change the order of reply messages by selecting **Reorder**.

Continued

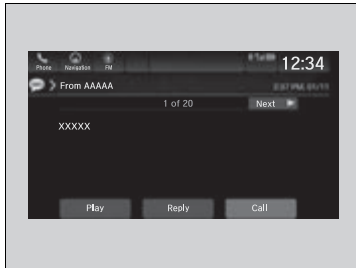

■ **Making a call to a sender**

1. Go to the text message screen.
2. Select **Call**.

In Case of Emergency

Automatic collision notification

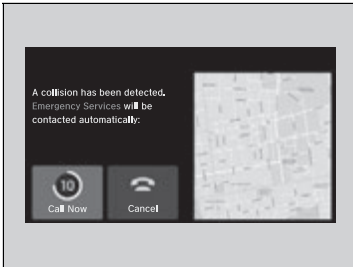

If your vehicle's airbags deploy or if the unit detects that the vehicle is severely impacted, your vehicle automatically will attempt to connect to the HondaLink® operator. If connected, information about your vehicle, its location, and its condition can be sent to the operator*1; you also can speak to the operator when connected.

IMPORTANT: For vehicles equipped with HondaLink® Assist, owner activation constitutes authorization for Honda to collect information from your vehicle needed to provide the service, and agreement to the Terms of Use at www.hondalink.com/termsandconditions. In a crash, HondaLink® Assist will attempt to notify emergency services but NEITHER HONDA NOR ITS SERVICE PROVIDERS GUARANTEE THAT SUCH NOTIFICATION WILL OCCUR.

Honda reserves the right to terminate HondaLink® Assist services at any time or for any reason, and in the future may not be able to provide services due to changes in, or obsolescence of, technology integral to the service or changes in governmental regulation.

*1: Depending on your phone and adequate cellular coverage, your vehicle's location may not be sent to the operator.

* Not available on all models

Continued

In Case of Emergency

If the telematics control unit (TCU)* is unsubscribed then HondaLink® Assist can function through a connected cell phone via the USB cable or Bluetooth®.

Your vehicle may not be able to connect to the operator if the battery level is low, the line is disconnected, or you do not have adequate cellular coverage.

You cannot use this emergency services when:

- You travel outside the HondaLink® service coverage areas.
- There is a problem with the connecting devices, such as the microphones, speakers, or the unit itself.

You cannot operate other phone-related functions using the screen while talking to the operator. Select **Hang Up** to terminate the connection to your vehicle.

Automatic collision notification

If the unit fails to connect to the operator, it repeatedly tries until it succeeds.

■ To enable notification

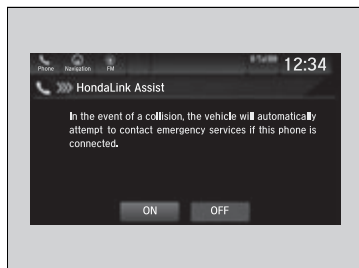

1. Go to the phone settings screen.
 ▶ **Phone settings screen** P. 513
2. Select **HondaLink Assist**.
3. Select **ON** or **OFF**.

■ Manual operator connection*

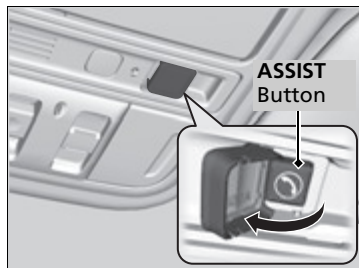

If you need to talk to the HondaLink® operator in a situation where no airbag has deployed, you can manually connect to them by pressing the **ASSIST** button with the power mode in **ACCESSORY** or **ON**.

1. Open the cover attached to the ceiling console.
2. Press the **ASSIST** button.
 ▶ You are connected to the HondaLink® operator.

▶▶ To enable notification

Setting options:

- **ON**: Notification is available.
- **OFF**: Disable the feature.

▶▶ Manual operator connection*

Do not press the button while driving. When you need to contact the operator, park the vehicle in a safe place.

If the unit fails to connect to the operator, it automatically cancels the action after three minutes.

If necessary, the cover can be broken to access the **ASSIST** button.

Your audio system allows you to monitor a view of the second and third row seat's passengers on the audio/information screen.



How to use

Models with center speaker





Models without center speaker



1. Select .
2. Select **CabinWatch**.
 - ▶ To zoom the desired position, double tap or pinch out on the camera image.
 - ▶ To return to the normal display, double tap again or pinch in.
 - ▶ Select  to mute your voice.

Models with center speaker

- ▶ Select  to broadcast to headphones.
- ▶ Select  to broadcast to the rear speakers.

CabinWatch®*

You can customize the following items by selecting **Settings** on the **CabinWatch** screen.

- **Show At System Start:** Selects whether **CabinWatch** is displayed every time you start the engine.
- **Default View Mode:** You can change the screen setting every time you turn on **CabinWatch**.

The **CabinWatch** camera is equipped near the overhead screen.

The camera can also monitor at the nighttime with the IR lights.

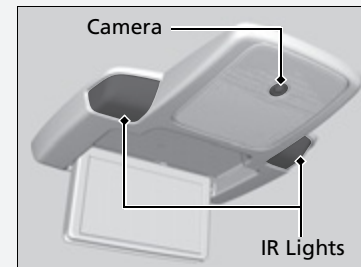

For **CabinWatch** to work properly:

- Do not attach an object, sticker or film to the area around the camera.
- Do not touch the camera lens.
- In some low light conditions the IR lights may impact color of the camera image.

* Not available on all models

Your audio system allows you or the front passenger voices to be broadcast to the second and third row seat's passengers using the rear speakers and/or headphones.



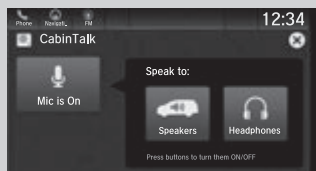

How to use

Models with center speaker

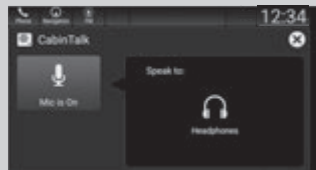

Models without center speaker



1. Select .
 2. Select **CabinTalk**.
 - ▶ Select  to mute your voice.
- Models with center speaker**
- ▶ Select  to broadcast to the rear speakers.
 - ▶ Select  to broadcast to headphones.

CabinTalk®*

You can also switch to the **CabinTalk** screen by selecting **CabinTalk** on the front control panel for the Blu-ray/DVD rear entertainment system.

▶ **Front Control Panel Operation** P. 422

Models with center speaker

When  is selected, you can adjust the speaker volume by turning the volume knob.

Driving



This chapter discusses driving and refueling.

Before Driving

Driving Preparation	538
Maximum Load Limit.....	541

Towing a Trailer

Towing Preparation.....	544
Driving Safely with a Trailer.....	548
Towing Behind a Motorhome	549

When Driving

Starting the Engine	550
Precautions While Driving.....	556
Automatic Transmission	557
Shifting	558
Auto Idle Stop.....	566
ECON Button	572

Intelligent Traction Management	573
Vehicle Stability Assist™ (VSA®), aka Electronic Stability Control (ESC), System	574
Agile Handling Assist	576
Tire Pressure Monitoring System (TPMS) with Tire Fill Assist	577
Tire Pressure Monitoring System (TPMS) - Required Federal Explanation	579
Blind spot information System*	581
LaneWatch™*	584
Honda Sensing®	586
Collision Mitigation Braking System™ (CMBS™)	589
Adaptive Cruise Control (ACC) with Low Speed Follow	600
Lane Keeping Assist System (LKAS) ..	616
Road Departure Mitigation (RDM) System.....	625

Traffic Sign Recognition System	630
Front Sensor Camera	635
Radar Sensor	637

Braking

Brake System	638
Anti-lock Brake System (ABS)	644
Brake Assist System	645

Parking Your Vehicle

When Stopped	646
Parking Sensor System*	648
Cross Traffic Monitor*	653

Multi-View Rear Camera

.....	657
-------	-----

Refueling

Fuel Information	659
How to Refuel	660

Fuel Economy and CO₂ Emissions.....

.....	662
-------	-----

* Not available on all models

Driving Preparation

Check the following items before you start driving.

Exterior Checks

- Make sure there are no obstructions on the windows, door mirrors, exterior lights, or other parts of the vehicle.
 - ▶ Remove any frost, snow, or ice.
 - ▶ Remove any snow on the roof, as this can slip down and obstruct your field of vision while driving. If frozen solid, remove ice once it has softened.
 - ▶ When removing ice from around the wheels, be sure not to damage the wheel or wheel components.
- Make sure the hood is securely closed.
 - ▶ If the hood opens while driving, your front view will be blocked.
- Make sure the tires are in good condition.
 - ▶ Check air pressures, and check for damage and excessive wear.
 - ✦ **Checking and Maintaining Tires** P. 697
- Make sure there are no people or objects behind or around the vehicle.
 - ▶ There are blind spots from the inside.

Exterior Checks

NOTICE

When doors are frozen shut, use warm water around the door edges to melt any ice. Do not try to force them open, as this can damage the rubber trim around the doors. When done, wipe dry to avoid further freezing.

Do not pour warm water into the key cylinder. You will be unable to insert the key if the water freezes in the hole.

Heat from the engine and exhaust can ignite flammable materials left under the hood, causing a fire. If you've parked your vehicle for an extended period, inspect and remove any debris that may have collected, such as dried grass and leaves that have fallen or have been carried in for use as a nest by a small animal. Also, check under the hood for leftover flammable materials after you or someone else has performed maintenance on your vehicle.

Interior Checks

- Store or secure all items on board properly.
 - ▶ Carrying too much cargo, or improperly storing it, can affect your vehicle's handling, stability, stopping distance, and tires, and make it unsafe.
 - ✦ **Maximum Load Limit** P. 541
- Do not pile items higher than the seat height.
 - ▶ They can block your view and may be thrown forward in the event of sudden braking.
- Do not place anything in the front seat footwells. Make sure to secure the floor mat.
 - ▶ An object or unsecured floor mat can interfere with your brake and accelerator pedal operation while driving.
- If you have any animals on board, do not let them move around in the vehicle.
 - ▶ They may interfere with driving and a crash could occur.
- Securely close and lock all doors and the tailgate.
 - ✦ **Locking/Unlocking the Doors from the Inside** P. 166
- Adjust your seating position properly.
 - ▶ Adjust the head restraint, too.
 - ✦ **Seats** P. 222
 - ✦ **Adjusting the Front and Second Row Outer and Third Row Outer Head Restraints Positions** P. 235
- Adjust the mirrors and steering wheel properly for your driving.
 - ▶ Adjust them while sitting in the proper driving position.
 - ✦ **Mirrors** P. 219
 - ✦ **Adjusting the Steering Wheel** P. 218

Interior Checks

The headlight aim is set by the factory, and does not need to be adjusted. However, if you regularly carry heavy items in the cargo area or tow a trailer, have the aiming readjusted at a dealer or by a qualified technician.

- Be sure items placed on the floor behind the front seats cannot roll under the seats.
 - ▶ They can interfere with the driver's ability to operate the pedals, the operation of the seats, or the operation of the sensors under the seats.
- Everyone in the vehicle must fasten their seat belt.
 - 📌 **Fastening a Seat Belt** P. 43
- Make sure that the indicators in the instrument panel come on when you start the vehicle, and go off soon after.
 - ▶ Always have a dealer check the vehicle if a problem is indicated.
 - 📌 **Indicators** P. 88

Maximum Load Limit

Models without second row center seat

The maximum load for your vehicle is 1,173 lbs (532 kg).

Models with second row center seat

The maximum load for your vehicle is 1,340 lbs (608 kg).

All models

See the Tire and Loading Information label attached to the driver's doorjamb.

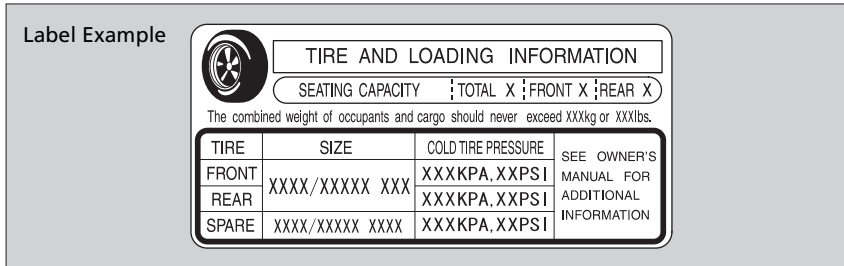

This figure includes the total weight of all occupants, cargo, and accessories, and the tongue load if you are towing a trailer.

Steps for Determining Correct Load Limit -

- (1) Locate the statement "The combined weight of occupants and cargo should never exceed XXX kg or XXX lbs." on your vehicle's placard.
- (2) Determine the combined weight of the driver and passengers that will be riding in your vehicle.
- (3) Subtract the combined weight of the driver and passengers from XXX kg or XXX lbs.

Continued

Maximum Load Limit

⚠ WARNING

Overloading or improper loading can affect handling and stability and cause a crash in which you can be hurt or killed.

Follow all load limits and other loading guidelines in this manual.

Gross Vehicle Weight Rating (GVWR):

The maximum allowable weight of the vehicle, all occupants, all accessories, all cargo, and the tongue load.

➤ Specifications P. 760

Gross Axle Weight Rating (GAWR):

The maximum allowable weight of the vehicle axle.

➤ Specifications P. 760

- (4)** The resulting figure equals the available amount of cargo and luggage load capacity. For example, if the “XXX” amount equals 1,400 lbs. and there will be five 150 lb. passengers in your vehicle, the amount of available cargo and luggage load capacity is 650 lbs.
(1,400 - 750 (5 x 150) = 650 lbs.)
- (5)** Determine the combined weight of luggage and cargo being loaded on the vehicle. That weight may not safely exceed the available cargo and luggage load capacity calculated in step 4.
- (6)** If your vehicle will be towing a trailer, load from your trailer will be transferred to your vehicle. Consult this manual to determine how this reduces the available cargo and luggage load capacity of your vehicle.

In addition, the total weight of the vehicle, all occupants, accessories, cargo, and trailer tongue load must not exceed the Gross Vehicle Weight Rating (GVWR) or the Gross Axle Weight Rating (GAWR). Both are on a label on the driver's doorjamb.

Load Limits Example

Example1

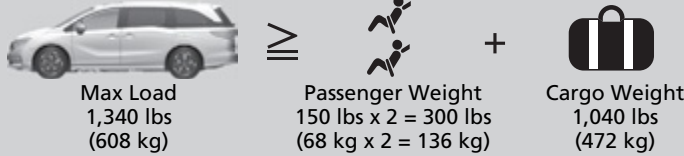

Max Load
1,340 lbs
(608 kg)

Passenger Weight
150 lbs x 2 = 300 lbs
(68 kg x 2 = 136 kg)

Cargo Weight
1,040 lbs
(472 kg)

Example2

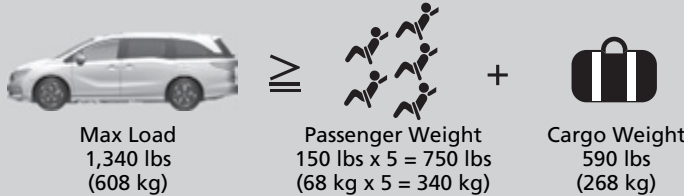

Max Load
1,340 lbs
(608 kg)

Passenger Weight
150 lbs x 5 = 750 lbs
(68 kg x 5 = 340 kg)

Cargo Weight
590 lbs
(268 kg)

▶▶ Maximum Load Limit

Towing a Trailer:

See Towing a Trailer to determine whether your vehicle is designed to tow a trailer.

▶ **Towing a Trailer** P. 544

Towing Preparation

Towing Load Limits

Your vehicle can tow a trailer if you carefully observe the load limits, use the proper equipment, and follow the towing guidelines. Check the load limits before driving.

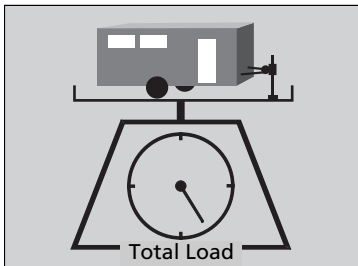

Total trailer weight

Do not exceed the maximum allowable weight of the trailer, cargo, and everything in or on it shown in the table.

Towing loads in excess of this can seriously affect vehicle handling and performance and can damage the engine and drivetrain.

Number of occupants	Weight
2	3,500 lbs (1,587 kg)
3	3,350 lbs (1,520 kg)
4	3,150 lbs (1,429 kg)
5	3,000 lbs (1,360 kg)
6	2,000 lbs (907 kg)
7	800 lbs (363 kg)
8	Towing not recommended

Each weight limit is calculated based on the following conditions:

- Occupants fill seats from the front of the vehicle to the back
- Each occupant weighs 150 lbs (68 kg)
- Each occupant has 17.6 lbs (8 kg) of cargo in the cargo area.

Any additional weight, cargo or accessories reduce the maximum trailer weight and maximum tongue load.

Towing Load Limits

WARNING

Exceeding any load limit or improperly loading your vehicle and trailer can cause a crash in which you can be seriously hurt or killed.

Check the loading of your vehicle and trailer carefully before starting to drive.

Check if all loads are within limits at a public scale. If a public scale is not available, add the estimated weight of your cargo load to the weight of your trailer (as quoted by the manufacturer), and then measure the tongue load with an appropriate scale or tongue gauge or estimate it based on cargo distribution. Refer to the trailer owner's manual for additional information.

Break-in Period

Avoid towing a trailer during your vehicle's first 600 miles (1,000 km).

Never exceed the gross weight ratings.
Gross weight information

➤ **Vehicle Specifications** P. 760

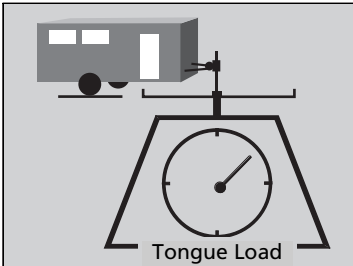

■ Tongue load

The weight of the tongue with a fully loaded trailer on the hitch should be approximately 10% of the total trailer weight.

- Excessive tongue load reduces front tire traction and steering control. Too little tongue load can make the trailer unstable and cause it to sway.

■ Towing Equipment and Accessories

Towing equipment varies by the size of your trailer, how much load you are towing, and where you are towing.

■ Hitches

The hitch must be of an approved type and properly bolted to the underbody.

■ Weight distribution hitches

Your vehicle is designed to tow without the need for a load distributing hitch. If you wish to use one, please consult your trailer maker for proper installation and set-up. Improper set-up could degrade the handling, stability, and braking performance of your vehicle.

☒ Towing Equipment and Accessories

Make sure that all equipment is properly installed and maintained, and that it meets federal, state, province/territory, and local regulations.

Consult your trailer maker for proper installation and setup of the equipment. Improper installation and setup can affect the handling, stability, and braking performance of your vehicle.

Consult your trailer sales or rental agency if any other items are recommended or required for your towing situation.

The lighting and wiring of trailers can vary by type and brand. If a connector is required, it should only be installed by a qualified technician.

■ Safety chains

Always use safety chains when you tow a trailer. Leave enough slack to allow the trailer to turn corners easily, but do not allow the chains to drag on the ground.

■ Trailer brakes

Recommended for any trailer with a total weight of 1,000 lbs (450 kg) or more: There are two common types of trailer brakes: surge and electric. Surge brakes are common for boat trailers, since the brakes will get wet. If you choose electric brakes, be sure they are electronically actuated. Do not attempt to attach trailer brakes to your vehicle's hydraulic system, as it will lower braking effectiveness and create a potential hazard.

■ Trailer light

Trailer lights and equipment must comply with federal, state, province/territory, and local regulations. Check with your local trailer sales or rental agency for the requirements in the area where you plan to tow.

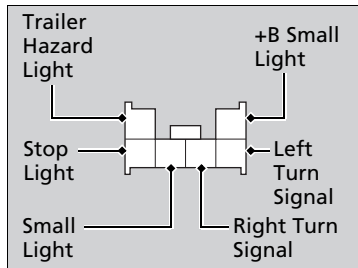

We recommend that you have a dealer install a Honda wiring harness and converter. They are designed for your vehicle.

▶▶ Towing Equipment and Accessories

Trailer packages and products:

- Ball mount, hitch plug, hitch pin etc.
- Wiring harness kit
- Trailer hitch kit

Are available at a dealer.

▶▶ Trailer light

The trailer lighting connector is located behind the left side panel in the cargo area. Even if you are planning to use the non-Honda trailer lighting harness and converter, ask a dealer for the correct connector and pins.

■ Sway control

This device can be used if your trailer tends to sway. Your trailer maker can tell you what kind of sway control you need and how to install it. Improper installation could degrade the handling and stability of your vehicle.

■ Trailer mirrors

Many states, provinces and territories require special exterior mirrors when towing a trailer. Install special mirrors whenever you cannot clearly see behind you, or if the trailer creates a blind spot.

Driving Safely with a Trailer

■ Things You Need To Know Before Towing a Trailer

- Have the trailer properly serviced and keep it in good condition.
- Make sure that all the weights and load in the vehicle and trailer are within limits.
 - ✚ **Towing Load Limits** P. 544
- Securely attach the hitch, safety chains, and other necessary parts to the trailer.
- Securely store all the items in and on the trailer so that they do not shift while driving.
- Check if the lights and brakes on the trailer are working properly.
- Check the pressure of the trailer tires, including the spare.
- Turn off the Auto Idle Stop system using the Auto Idle Stop **OFF** button. The trailer weight can affect your vehicle's brake effectiveness if Auto Idle Stop is activated on a hill while towing a trailer.

■ Towing Speeds and Gears

- Drive slower than normal.
- Obey posted speed limits for vehicles with trailers.
- Use the  position when towing a trailer on level roads.

■ Turning and Braking

- Turn more slowly and with a wider turning arc than normal.
- Allow more time and distance for braking.
- Do not brake or turn suddenly.

» Driving Safely with a Trailer

Operating speed when towing a trailer must not exceed 62 mph (100 km/h).

Parking

In addition to the normal precautions, place wheel chocks at each of the trailer's tires.

Remember to unhitch the trailer before changing a flat tire. Ask the trailer sales or rental agency where and how to store the trailer's spare tire.

» Towing Speeds and Gears

When towing a fixed-sided trailer (e.g., camper), do not exceed 55 mph (88 km/h). At higher speeds, the trailer may sway or affect vehicle handling.

■ Driving in Hilly Terrain

- Monitor your temperature gauge. If it nears the red (Hot) mark, turn off the climate control system and reduce speed. Pull to the side of the road safely to cool down the engine if necessary.
- Shift to the  position if the transmission shifts frequently.

Towing Behind a Motorhome

Your vehicle is not designed to be towed behind a motor home. If your vehicle needs to be towed in an emergency, refer to the emergency towing information.

 **Emergency Towing** P. 752

Starting the Engine

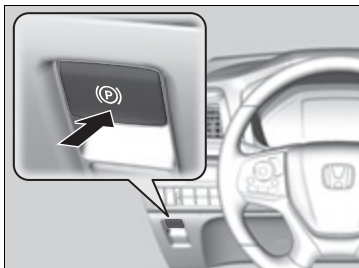

1. Make sure the parking brake is applied.
 - ▶ The parking brake and brake system indicator (red) comes on for 15 seconds when you press the electric parking brake switch.

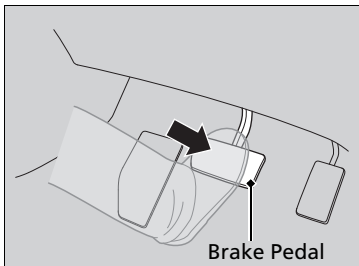

2. Depress the brake pedal.

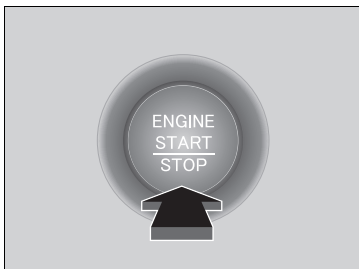

3. Press the **ENGINE START/STOP** button without depressing the accelerator pedal. The engine will crank until it starts.

Starting the Engine

Keep your foot firmly on the brake pedal when starting the engine. The engine is harder to start in cold weather and in thinner air found at altitudes above 8,000 feet (2,400 meters).

When starting the engine in cold weather, turn off all electrical accessories such as the lights, climate control system, and rear defogger in order to reduce battery drain.

If you live in a region where winter is extremely cold, an engine block heater will improve starting and warming of the engine. Consult a dealer for details.

If the exhaust system sounds abnormal or you can smell exhaust gas inside the vehicle, have your vehicle checked by a dealer. There may be a problem with the engine or exhaust system.

Bring the remote close to the **ENGINE START/STOP** button if the battery in the remote is weak.

▶ If the Remote Battery is Weak P. 733

The engine may not start if the remote is subjected to strong radio waves.

Do not hold the **ENGINE START/STOP** button to start the engine.

If the engine does not start, wait at least 30 seconds before trying again.

■ Stopping the Engine

You can turn the engine off when the vehicle is completely stopped.

1. Put the transmission into **P**.
2. Press the **ENGINE START/STOP** button.

▣ Starting the Engine

The immobilizer system protects your vehicle from theft.

If an improperly coded device is used, the engine's fuel system is disabled.

▣ **Immobilizer System** P. 191



■ Remote Engine Start with Vehicle Feedback*

You can remotely start the engine using the  button on the remote.

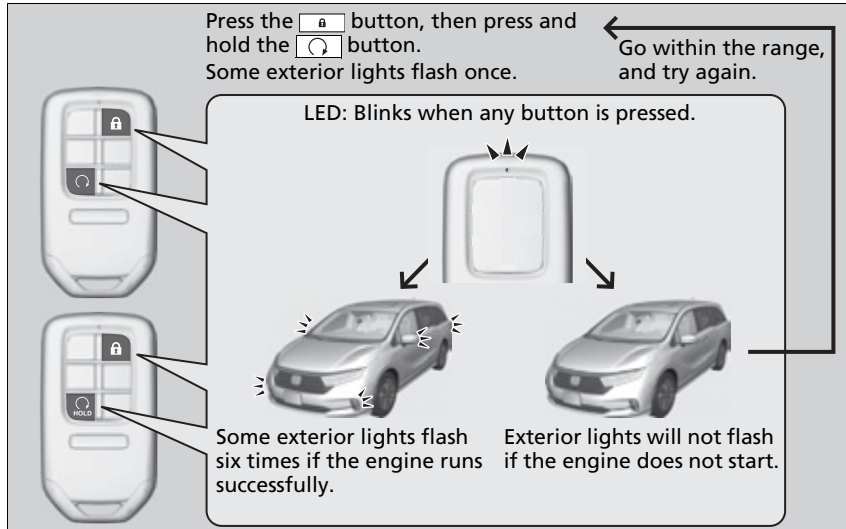
■ To start the engine



When started remotely, the engine automatically shuts off after 10 minutes of idling and/or the brake pedal and **ENGINE START/STOP** button have not been pressed simultaneously.

To extend the run time for another 10 minutes during the first run, press the  button, then press and hold the  button.

- ▶ Some exterior lights flash six times if a 10-minute extension request was transmitted successfully.

⚠ Remote Engine Start with Vehicle Feedback*

⚠ WARNING

Carbon monoxide gas is toxic and can rapidly accumulate in closed or even partly enclosed areas.

Breathing it can cause unconsciousness and even kill you.

Never use the remote engine starter with the vehicle parked in a garage or other areas with limited ventilation.

The remote engine start may violate local laws. Before using the remote engine start, check your local laws.

If there are buildings and obstacles between your vehicle and the remote, the range will be reduced. This distance may vary by external electrical interference.

■ To stop the engine

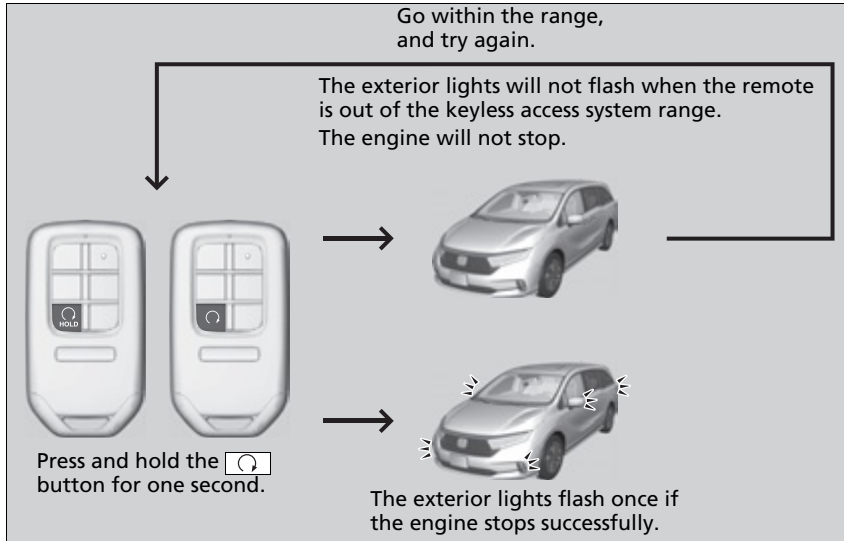

⊠ Remote Engine Start with Vehicle Feedback*

The engine may not start by the remote engine start if:

- You have disabled a remote engine start setting using the audio/information screen.
- The power mode is not in VEHICLE OFF.
- The transmission is in a position other than **P**.
- The hood is open, or any door or the tailgate is unlocked.
- You have already used the remote twice to start the engine.
- The battery temp is too low or the battery charge is too low.
- Another registered remote is in the vehicle.
- There is any antenna failure.
- The door is unlocked with the built-in key.
- The engine oil pressure is low.
- The engine coolant temperature is extremely high.
- The telematics unit* malfunctions.
- The security system alarm is not set.

The engine may stop while it is running if:

- You do not start the vehicle within 10 minutes of starting the engine with the remote.
- The engine is stopped by using the remote.
- The security system alarm is not set.
- The door is unlocked with the built-in key.
- The hood is open, or any door, or the tailgate is unlocked.
- Any door is open.
- The transmission is in a position other than **P**.
- The engine coolant temperature is extremely high.
- The battery is low.
- The engine oil pressure is low.
- The Malfunction Indicator Lamp comes on if there is a problem with the emissions control systems.

* Not available on all models

Continued

▣ Remote Engine Start with Vehicle Feedback*

While the engine is running, the vehicle will automatically precondition inside the vehicle.

When it is warm outside:

- The climate control system is activated in recirculation mode.
- The seat ventilation is activated*.

When it is cold outside:

- The defroster is activated at a moderately warm temperature.
- The rear defogger and door mirror heaters are activated.
- The seat heaters and heated steering wheel* are activated.

▣ **Heated Steering Wheel*** P. 256



▣ **Front Seat Heaters and Seat Ventilation*** P. 258

Starting to Drive

When the engine was started using the  button on the remote*



1. Depress and hold the brake pedal, then press the **ENGINE START/STOP** button.

When the engine was started in any case

2. Keeping your right foot on the brake pedal, press the  button. Select  when reversing.
3. With the parking brake applied, release the brake pedal and gently depress the accelerator pedal.
 - ▶ Make sure the parking brake and brake system indicator goes off.
 - **Parking Brake** P. 638
 - **If the Transmission System Indicator Blinks along with the Warning Message** P. 744

■ Hill start assist system

Hill start assist keeps the brake engaged briefly to help prevent the vehicle from rolling on inclines as you move your foot from the brake pedal to the accelerator.

Change the gear position to  or  when facing uphill, or  when facing downhill, then release the brake pedal.

Starting to Drive

When the engine was started using the  button on the remote*

The engine stops when the gear position is changed from  before the **ENGINE START/STOP** button is pressed. Follow the step 1 when starting to drive.

You can also release the parking brake by pulling the electric parking brake switch while depressing the brake pedal.

When facing downhill, you can start your vehicle more smoothly by manually releasing it with the electric parking brake switch than by releasing it with the accelerator pedal.

▶ Hill start assist system

Hill start assist may not prevent the vehicle from rolling downhill on a very steep or slippery slope, and will not operate on small inclines.

Hill start assist is not a replacement for the parking brake.

Hill start assist will operate even when VSA® is switched off.

* Not available on all models

Precautions While Driving

In Rain

Avoid driving in deep water and on flooded roads. This can damage the engine or driveline, or cause electrical component failure.

Other Precautions

If there is a strong impact with something under the vehicle, stop in a safe location. Check the underside of the vehicle for damage or any fluid leaks.

Precautions While Driving

NOTICE

Do not change the gear position while pressing the accelerator pedal. You could damage the transmission.

NOTICE

If you repeatedly turn the steering wheel at an extremely low speed, or hold the steering wheel in the full left or right position for a while, the electric power steering (EPS) system heats up. The system goes into a protective mode, and limits its performance. The steering wheel becomes harder and harder to operate. Once the system cools down, the EPS system is restored. Repeated operation under these conditions can eventually damage the system.

If the power mode is set to ACCESSORY while driving, the engine will shut down and all steering and brake power assist functions will stop, making it difficult to control the vehicle.

Do not select **[N]** while driving as you will lose engine braking (and acceleration) performance.

During the first 600 miles (1,000 km) of operation, avoid sudden acceleration or full throttle operation so as not to damage the engine or powertrain.

Avoid hard braking for the first 200 miles (300 km) after purchasing your new vehicle or replacing the brake pads or rotors, to allow for proper break-in.

Automatic Transmission

■ Creeping

When the engine runs at higher idle speeds, the creeping force increases. Keep the brake pedal firmly depressed when stopped.

■ Kickdown

Quickly depressing the accelerator pedal while driving uphill may cause the transmission to drop to a lower gear, unexpectedly increasing vehicle speed. Depress the accelerator pedal carefully, especially on slippery roads and curves.

Shifting

Change the gear position in accordance with your driving needs.

■ Shift button positions



P **Park**
Used when parking or starting the engine
Transmission is locked

R **Reverse**
Used when reversing

N **Neutral**
Transmission is not locked

D/S **Drive/S Position**
Each time you press the **D/S** button, the mode switches between Drive and S Position mode.
Used for:

Drive

- Normal driving (gears change between 1st and 10th automatically)
- Temporarily driving in the sequential mode

S Position

- Automatically changing gears between 1st and 8th (8th gear is used only at high speed)
- Driving in the sequential mode

▶ Shifting

⚠ WARNING

The vehicle can roll away if left unattended without confirming that Park is engaged.

A vehicle that rolls away could cause a crash resulting in serious injury or death.

Always keep your foot on the brake pedal until you have confirmed that **P** is shown on the gear position indicator.

To prevent malfunction and unintended engagement:

- Do not spill any liquids on or around shift buttons.
- Do not place or drop any objects on or around shift buttons.
- Do not let passengers or children operate the shift buttons.

The beeper sounds and the message appears on the driver information interface when you depress the accelerator pedal with the gear position in **N**.

▶ Driver Information Interface Warning and Information Messages P. 108

Change the gear position to **D** or **R** with the brake pedal depressed.

When shifting gears in extremely low temperatures (–22°F/–30°C), there may be a short delay before the shift is indicated in the display. Always confirm you are in the correct gear before driving.

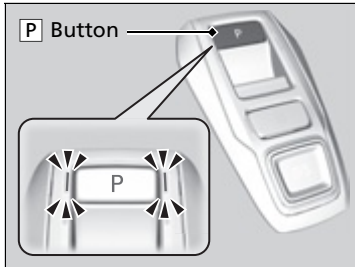
■ P (park) button

Park your vehicle in a safe place with the power mode in ON, then apply the brakes and press the **P** button to put the transmission in Park.

The indicators on the sides of the **P** button come on.

■ Shift Operation

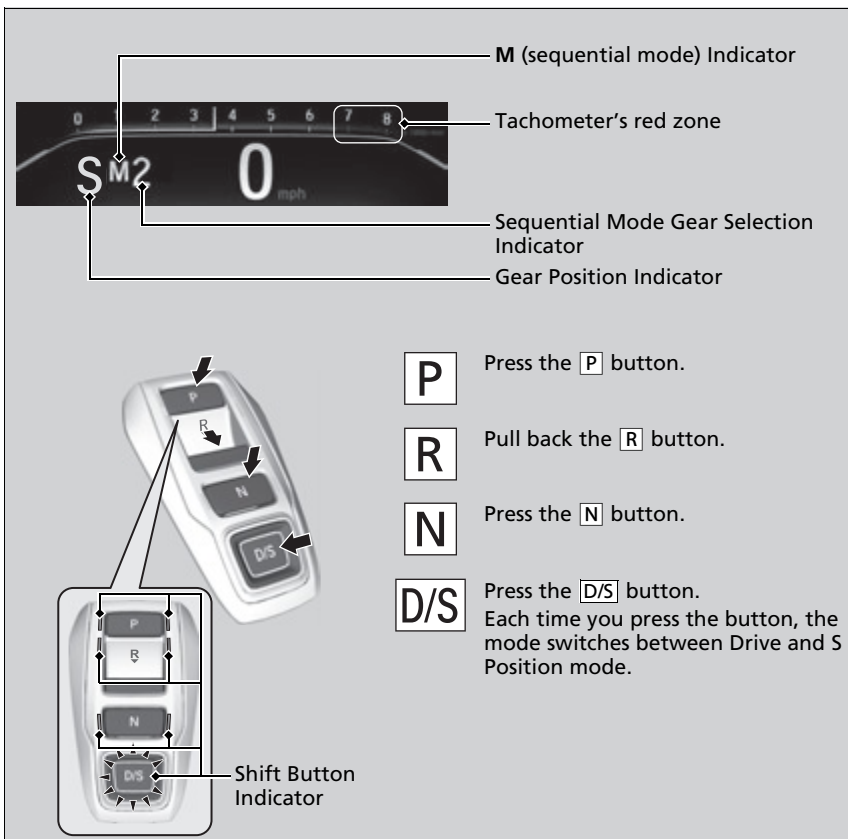

▶ Shift Operation

NOTICE

When you change **D** to **R** and vice versa, depress the brake pedal to come to a complete stop, then select the intended gear position while maintaining brake pressure.

Use the gear position indicator and the shift button indicator to check the gear position before selecting a shift button.

If the indicator of the currently selected gear position, or all the gear position indicators are blinking simultaneously, there is a problem with the transmission.

Avoid sudden acceleration and have the transmission checked by a dealer as soon as possible.

The fuel supply may be cut off if you drive at engine speeds in or over the tachometer's red zone (engine speed limit). If this happens, you may experience a slight jolt.

When the engine speed is increased while the transmission is in **N**, **P** or **R**, the fuel supply may be cut off even without the engine speed entering the tachometer's red zone.

The beeper sounds once when you change to **R**.

Models with color audio system

▶ **Vehicle Customization** P. 143

Models with Display Audio

▶ **Customized Features** P. 463

■ When opening the driver's door

If you open the driver's door under the following conditions, the gear position automatically changes to **P**;

- The vehicle is stationary with the engine running, or moving at 1 mph (2 km/h) or slower.
- The transmission is in other than **P**.
- You have unfastened the driver side seat belt.
 - ▶ If you manually change the gear position from **P** with the brake pedal depressed, the gear position will automatically return to **P** once you release the brake pedal.

■ When turning off the power mode

If you turn the engine off while the vehicle is stationary, and the transmission is in other than **P**, the gear position automatically changes to **P**.

⌘ When opening the driver's door

You should always select **P** before opening the driver's door.

Make sure to park the vehicle in a safe place.

📌 When Stopped P. 646

If you want to drive the vehicle after the gear position has automatically changed to **P** under the described conditions, close the door, fasten the seat belt, depress the brake pedal, then change the gear position.

If you leave the vehicle, turn off the engine and lock the doors.

■ **If you want to keep the transmission in **N** position [car wash mode]**

With the engine running:

1. Press and hold the brake pedal.
2. Select **N**, then release the button to display (Neutral) **N** hold mode on the driver information interface.
3. Press and hold **N** again for two seconds.
 - ▶ This puts the vehicle in car wash mode which must be used when your vehicle is pulled through a conveyor type automatic car wash where you or an attendant do not remain in the vehicle.

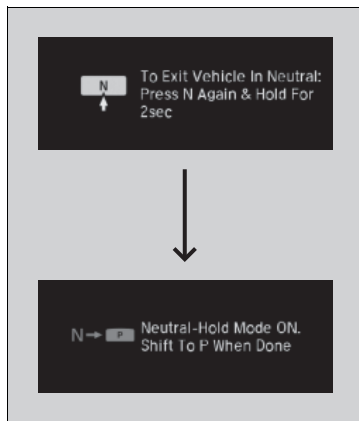

If the **ENGINE STOP/START** button is pressed after car wash mode has been activated, the power mode will change to ACCESSORY and a message will be displayed on the driver information interface.

- ▶ For 15 minutes the gear position remains in **N** with the power mode in ACCESSORY. After that, the position automatically changes to **P** and the power mode changes to OFF.
- ▶ Manually changing to **P** cancels ACCESSORY mode. The **P** indicator comes on and the power mode changes to OFF. You must always shift to **P** when car wash mode is no longer needed.

⚠ If you want to keep the transmission in **N** position [car wash mode]

NOTICE

When transmission is too hot, carwash mode may not be available. Let the engine idle and cool down transmission.

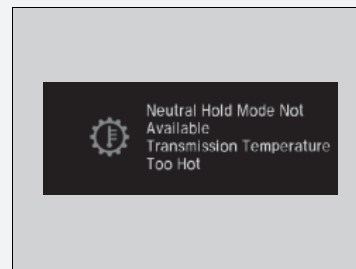

The transmission may not stay in **N** position while the following indicator is on:

- Transmission system indicator.
- Malfunction indicator lamp.
- Charging system indicator.

■ Restrictions on selecting a gear position

You cannot select a gear position under certain circumstances that may lead to a crash.

When the transmission is in:	1. Under these circumstances:	2. If you try to change to the following:	3. The gear position remains in/changes to:	How to change the gear position
P	The brake pedal is not depressed.	Other gear position	P	Release the accelerator pedal and depress the brake pedal.
	The accelerator pedal is depressed.			
N	The vehicle is moving at low speed without the brake pedal depressed.	Other gear position	N	Release the accelerator pedal and depress the brake pedal.
	The vehicle is moving at low speed with the accelerator pedal depressed.			
N, D or S	The vehicle is moving forward.	R	N	Stop your vehicle in a safe place, depress the brake pedal, and select the appropriate gear position.
R or N	The vehicle is moving backward.	D, S		
R, N, D or S	The vehicle is moving.	P		

■ Sequential Mode

Use the paddle shifters to change between 1st and 10th gears without removing your hands from the steering wheel. The transmission will switch to the sequential mode.

■ When the transmission is in **[D]**:

The vehicle will go into the sequential mode momentarily, and the sequential mode gear selection indicator will come on.

When the vehicle goes into the sequential mode by **[-]** paddle shifter and the lower gear is available, the transmission properly selects single or double gear change.

Once you start traveling at a constant speed, the sequential mode will automatically switch off, and the sequential mode gear selection indicator will go off.

Hold the **[+]** paddle shifter for two seconds to return to normal drive.

■ When the transmission is in **[S]**:

The vehicle will go into the sequential mode, and the **M** (sequential mode) indicator and sequential mode gear selection indicator will come on.

If the vehicle speed increases and the engine speed reaches near the tachometer's red zone, the transmission automatically shifts up to the next gear.

You can cancel this mode by holding the **[+]** paddle shifter for two seconds. When the sequential mode is canceled, the sequential mode indicator and sequential mode gear selection indicator go off.

Sequential Mode Operation

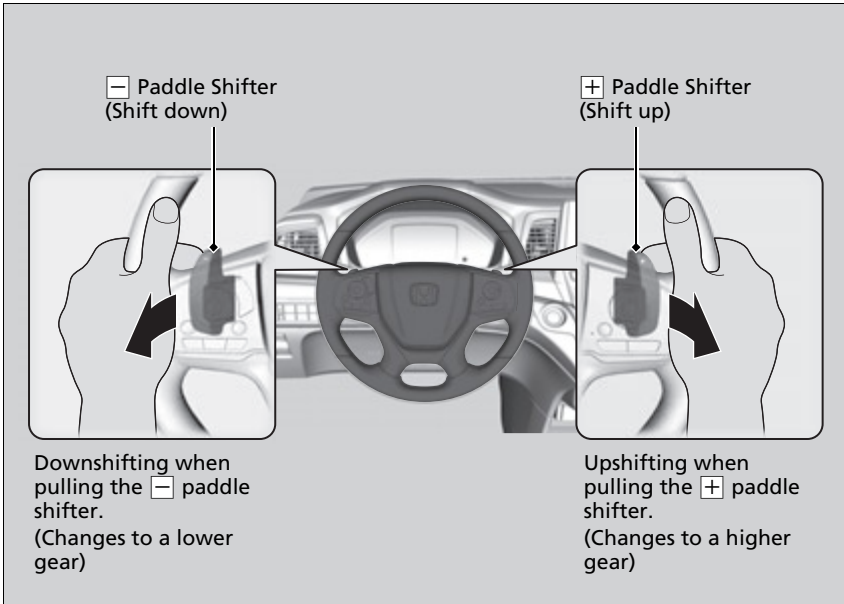

Sequential Mode Operation

Each paddle shift operation makes a single or double gear change.
To change gears continuously, release the paddle shifter before pulling it again for the next gear.

If the sequential mode gear selection indicator blinks when you try to shift up or down, this means your vehicle speed is not in its allowable gear range or the protection of transmission system is necessary. Slightly accelerate to shift up and decelerate to shift down while the indicator is blinking.

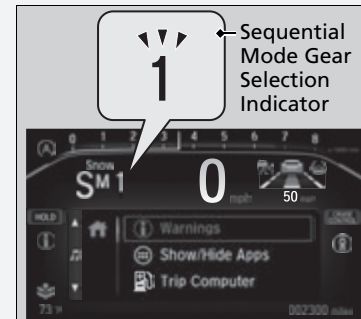

Auto Idle Stop

To help maximize fuel economy, the engine automatically stops when the vehicle comes to a stop, depending on environmental and vehicle operating conditions. The indicator (green) comes on at this time.

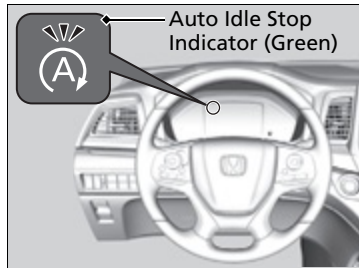

The environmental and vehicle conditions that impact Auto Idle Stop system operation are varied.

➤ **Auto Idle Stop Activates When:** P. 568, 569

The engine then restarts once the vehicle is about to move again, and the indicator (green) goes off.

➤ **The Engine Automatically Restarts When:** P. 569

The Auto Idle Stop suspend indicator comes on and a message appears on the driver information interface when the Auto Idle Stop system cannot be activated.

➤ **Indicators** P. 88

If the driver's door is opened while the indicator comes on, a buzzer sounds to notify you that the Auto Idle Stop function is in operation.

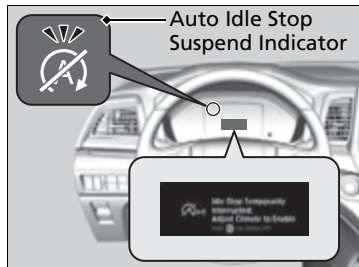

Auto Idle Stop

The 12-volt battery installed in this vehicle is specifically designed for a model with Auto Idle Stop. Using a 12-volt battery other than this specified type may shorten the 12-volt battery life, and prevent Auto Idle Stop from activating. If you need to replace the 12-volt battery, make sure to select the specified type. Ask a dealer for more details.

The duration of the Auto Idle Stop operation:

- **Increase** in the ECON mode, compared to when the ECON mode is off, with climate control in use.
- **ECON Button** P. 572

A message associated with Auto Idle Stop appears on the driver information interface.

➤ **Indicators** P. 102

■ Auto Idle Stop System ON/OFF

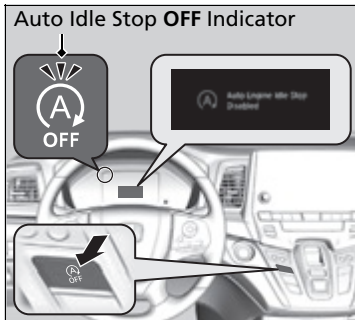

To turn the Auto Idle Stop system off, press this button. The Auto Idle Stop system stops.

- ▶ The Auto Idle Stop system will stop and the indicator will come on.

The Auto Idle Stop system is turned on every time you start the engine, even if you turned it off the last time you drove the vehicle.

⌘ Auto Idle Stop

If you hold the Auto Idle Stop **OFF** button, you can disable idle stop messages.

➤ **Indicators** P. 102

⌘ Auto Idle Stop System ON/OFF

If you turn off the Auto Idle Stop system while it is activated, the engine will restart.

■ Auto Idle Stop Activates When:

The vehicle stops with the gear position in **D** and the brake pedal depressed. When you put the transmission into **P**, the Auto Idle Stop continues to operate, even if the brake pedal is released.

▶ If you depress the brake pedal, the engine may automatically restart.

■ Auto Idle Stop does not activate when:

- The Auto Idle Stop **OFF** button is pressed.
- The driver's seat belt is not fastened.
- The engine coolant temperature is low or high.
- The transmission fluid temperature is low or high.
- The vehicle comes to a stop again before the vehicle speed reaches 3 mph (5 km/h) after the engine starts.
- The vehicle is stopped on a steep incline.
- The transmission is in a position other than **D**.
- The engine is started with the hood open.
 - ▶ Turn off the engine. Close the hood before you restart the engine to activate Auto Idle Stop.
- The battery charge is low.
- The internal temperature of the battery is 14°F (–10°C) or less.
- The climate control system is in use, and the outside temperature is below –4°F (–20°C) or over 104°F (40°C).
- The climate control system is in use, and the temperature is set to **Hi** or **Lo**.
-  is on (indicator on).
 - The rear fan is set to maximum speed.
 - ▶ Auto Idle Stop may not activate under other conditions when the rear climate control system is in use.
- When the Intelligent Traction Management is set to **Snow**.

ⓘ Auto Idle Stop Activates When:

Do not open the hood while the Auto Idle Stop function is activated. If the hood is opened, the engine will not restart automatically.

In this case, restart the engine with the **ENGINE START/STOP** button.

➤ **Starting the Engine** P. 550

When ACC with Low Speed Follow is in operation, the vehicle stops without depressing the brake pedal and Auto Idle Stop may activate. In such cases, the engine may restart if you change the shift position other than **D**.

Pressing the **ENGINE START/STOP** button causes the engine to no longer restart automatically. Follow the standard procedure to start the engine.

➤ **Starting the Engine** P. 550

■ Auto Idle Stop may not activate when:

- The vehicle is stopped by braking suddenly.
- The steering wheel is operated.
- The fan speed is high.
- The climate control system is in use, and there is a significant difference between the set temperature and the actual interior temperature.
- The climate control system is in use, and humidity in the interior is high.
- The rear fan is set to maximum speed.
 - ▶ Auto Idle Stop may not activate under other conditions when the rear climate control system is in use.

■ The Engine Automatically Restarts When:

- The brake pedal is released (without the automatic brake hold system activated).
- The accelerator pedal is depressed (with the automatic brake hold system activated).
 - **Automatic Brake Hold** P. 642

⊠ The Engine Automatically Restarts When:

If you are using an electronic device during Auto Idle Stop, the device may temporarily be turned off when the engine restarts.

■ **The engine restarts even if the brake pedal is depressed*1 when:**

- The Auto Idle Stop **OFF** button is pressed.
- The steering wheel is operated.
- The transmission is put into **R** or **S**, or when it is set from **N** to **D**.
 - ▶ If you put the transmission into **P** after the Auto Idle Stop activates, the Auto Idle Stop continues to operate. In this case, the engine restarts when you depress the brake pedal.
- The pressure on the brake pedal is reduced and the vehicle starts moving while stopped on an incline.
- The brake pedal is released slightly during a stop.
- The battery charge becomes low.
- The accelerator pedal is depressed.
- The driver's seat belt is unlatched.
-  is on (indicator on).
- The climate control system is in use, and the difference between the set temperature and actual interior temperature becomes significant.
- The climate control system is being used to dehumidify the interior.
- The rear fan is set to maximum speed.
 - ▶ Auto Idle Stop may not activate under other conditions when the rear climate control system is in use.
- When the Intelligent Traction Management is set to **Snow**.
- The vehicle ahead of you starts again when your vehicle stops automatically with ACC with Low Speed Follow.

⌘ The engine restarts even if the brake pedal is depressed*1 when:

*1: With the automatic brake hold system activated, you can release the brake pedal while Auto Idle Stop is in operation.

If the automatic brake hold system has been turned off, or if there is a problem with the system, the engine will restart automatically when you release the brake pedal.

➤ **Automatic Brake Hold** P. 642

■ Starting Assist Brake Function

Briefly keeps the brake applied after releasing the brake pedal to restart the engine. This can keep your vehicle from unexpectedly moving while on an incline.

ECON Button

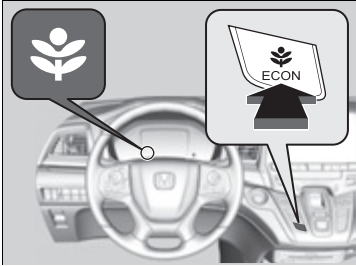

The **ECON** button turns the ECON mode on and off.

The ECON mode helps you improve your fuel economy by adjusting the performance of the engine, air conditioning system, and cruise control.

» ECON Button

While in ECON mode, the climate control system has greater temperature fluctuation.

Intelligent Traction Management

The Intelligent Traction Management optimizes vehicle performance to help you drive on various surfaces. The system has available modes to select from: **Normal** and **Snow**.

Press the **SNOW** button to select the appropriate mode. The mode you select appears on the driver information interface. When the vehicle is turned off and restarted, Intelligent Traction Management mode will revert to **Normal**.

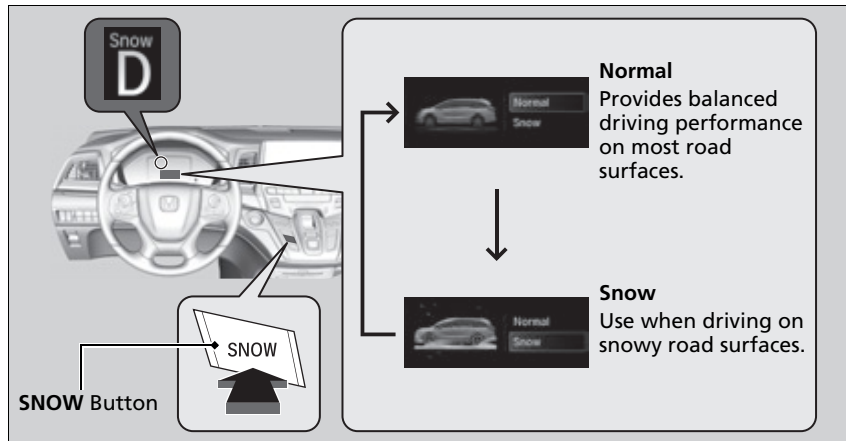

Vehicle Stability Assist™ (VSA®), aka Electronic Stability Control (ESC), System

VSA® helps to stabilize the vehicle during cornering if the vehicle turns more or less than what was intended. It also assists in maintaining traction on slippery surfaces. It does so by regulating engine output and selectively applying the brakes.

■ VSA® Operation

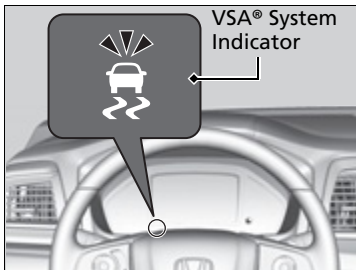

When VSA® activates, you may notice that the engine does not respond to the accelerator. You may also notice some noise from the hydraulic brake system. You will also see the indicator blink.

⚠ Vehicle Stability Assist™ (VSA®), aka Electronic Stability Control (ESC), System

The VSA® may not function properly if tire type and size are mixed. Make sure to use the same size and type of tire, and the air pressures as specified.

When the VSA® system indicator comes on and stays on while driving, there may be a problem with the system. While this may not interfere with normal driving, have your vehicle checked by a dealer immediately.

VSA® cannot enhance stability in all driving situations and does not control the entire braking system. You still need to drive and corner at speeds appropriate for the conditions and always leave a sufficient margin of safety.

The main function of the VSA® system is generally known as Electronic Stability Control (ESC). The system also includes a traction control function.

■ VSA® On and Off

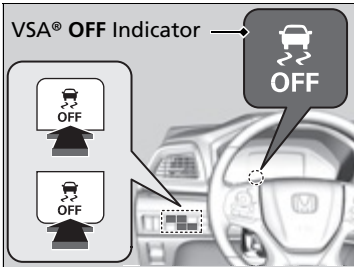

This button is on the driver side control panel. To partially disable VSA® functionality/features, press and hold it until you hear a beep.

Your vehicle will have normal braking and cornering ability, but traction control function will be less effective.

To restore VSA® functionality/features, press the  (VSA® OFF) button until you hear a beep.

VSA® is turned on every time you start the engine, even if you turned it off the last time you drove the vehicle.

▣ Vehicle Stability Assist™ (VSA®), aka Electronic Stability Control (ESC), System

In certain unusual conditions when your vehicle gets stuck in shallow mud or fresh snow, it may be easier to free it with the VSA® temporarily switched off.

When the  button is pressed, the traction control function becomes less effective. This allows for the wheels to spin more freely at low speed. You should only attempt to free your vehicle with the VSA® off if you are not able to free it when the VSA® is on.

Immediately after freeing your vehicle, be sure to switch VSA® on again. We do not recommend driving your vehicle with the VSA® system switched off.

You may hear a motor sound coming from the engine compartment while system checks are being performed immediately after starting the engine or while driving. This is normal.

Agile Handling Assist

Lightly brakes each of the front and rear wheels, as needed, when you turn the steering wheel, and helps support the vehicle's stability and performance during cornering.

ⓘ Agile Handling Assist

The agile handling assist cannot enhance stability in all driving situations. You still need to drive and corner at speeds appropriate for the conditions and always leave a sufficient margin of safety.

When the VSA® system indicator comes on and stays on while driving, the agile handling assist does not activate.

You may hear a sound coming from the engine compartment while the agile handling assist is activated. This is normal.

Tire Pressure Monitoring System (TPMS) with Tire Fill Assist

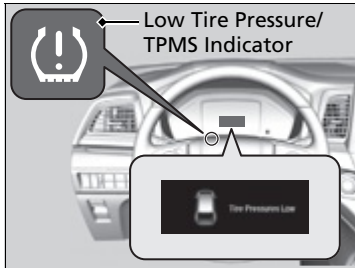

Monitors the tire pressure while you are driving. If your vehicle's tire pressure becomes significantly low, the Low Tire Pressure/TPMS indicator comes on and a message appears on the driver information interface.

☒ Tire Pressure Monitoring System (TPMS) with Tire Fill Assist

Conditions such as low ambient temperature and altitude change directly affect tire pressure and can trigger the Low Tire Pressure/TPMS indicator to come on.

☒ **If the Low Tire Pressure/TPMS Indicator Comes On or Blinks** P. 743

Tire pressure checked and inflated in:

- Warm weather can become under-inflated in colder weather.
- Cold weather can become over-inflated in warmer weather.

The Low Tire Pressure/TPMS indicator will not come on as a result of over inflation.





The TPMS audibly and visually informs you of changes in tire pressure of the individual tire that you are adjusting using audible and visual indications.

If a change in tire pressure has been significant, the system beeps and the hazard lights flash continuously for five seconds when the specified tire pressure is reached. Stop filling the tire.

■ Tire Pressure Monitor



To select the tire pressure monitor, please follow the following steps using the buttons on the steering wheel.

1. Set the power mode to ON.
2. Press the  (home) button.
3. Press the  button repeatedly until  **Maintenance** appears.
4. Press the **ENTER** button and select **Tire Pressure** by pressing the  button.
5. Press the **ENTER** button and the tire pressure appears on the driver information interface.

The pressure for each tire is displayed in psi.

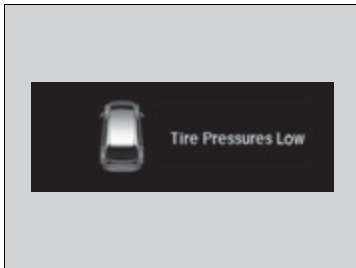

Tire Pressures Low is displayed when a tire has significantly low pressure. The specific tire is displayed on the screen.

▶▶ Tire Pressure Monitor

The pressure displayed on the driver information interface can be slightly different from the actual pressure as measured by a gauge. If there is a significant difference between the two values, or if the Low Tire Pressure/TPMS indicator and the message on the driver information interface do not go off after you have inflated the tire to the specified pressure, have the system checked by a dealer.

Tire Pressure Monitor Problem may appear if you drive with the compact spare tire, or there is a problem with the TPMS.

Tire Pressure Monitoring System (TPMS) - Required Federal Explanation

Each tire, including the spare (if provided), should be checked monthly when cold and inflated to the inflation pressure recommended by the vehicle manufacturer on the vehicle placard or tire inflation pressure label.

(If your vehicle has tires of a different size than the size indicated on the vehicle placard or tire inflation pressure label, you should determine the proper tire inflation pressure for those tires.)

As an added safety feature, your vehicle has been equipped with a tire pressure monitoring system (TPMS) that illuminates a low tire pressure telltale



when one or more of your tires is significantly under-inflated.

Accordingly, when the low tire pressure telltale illuminates, you should stop and check your tires as soon as possible, and inflate them to the proper pressure.

Driving on a significantly under-inflated tire causes the tire to overheat and can lead to tire failure. Under-inflation also reduces fuel efficiency and tire tread life, and may affect the vehicle's handling and stopping ability.

Please note that the TPMS is not a substitute for proper tire maintenance, and it is the driver's responsibility to maintain correct tire pressure, even if under-inflation has not reached the level to trigger illumination of the TPMS low tire pressure telltale.

Your vehicle has also been equipped with a TPMS malfunction indicator to indicate when the system is not operating properly. The TPMS malfunction indicator is combined with the low tire pressure telltale. When the system detects a malfunction, the telltale will flash for approximately one minute and then remain continuously illuminated. This sequence will continue upon subsequent vehicle start-ups as long as the malfunction exists.

When the malfunction indicator is illuminated, the system may not be able to detect or signal low tire pressure as intended.

TPMS malfunctions may occur for a variety of reasons, including the installation of replacement or alternate tires or wheels on the vehicle that prevent the TPMS from functioning properly.

Always check the TPMS malfunction telltale after replacing one or more tires or wheels on your vehicle to ensure that the replacement or alternate tires and wheels allow the TPMS to continue to function properly.

Blind spot information System*

Is designed to detect vehicles in specified alert zones adjacent to your vehicle, particularly in harder to see areas commonly known as “blind spots.” When the system detects vehicles approaching from behind in adjacent lanes, the appropriate indicator comes on for a few seconds, providing assistance when you change lanes.

■ How the system works

- The transmission is in **D** or **S**.
- Your vehicle speed is between 20 mph (32 km/h) and 100 mph (160 km/h)

Alert zone range

- A: Approx. 1.6 ft. (0.5 m)
- B: Approx. 10 ft. (3 m)
- C: Approx. 10 ft. (3 m)

Radar Sensors: underneath the rear bumper corners

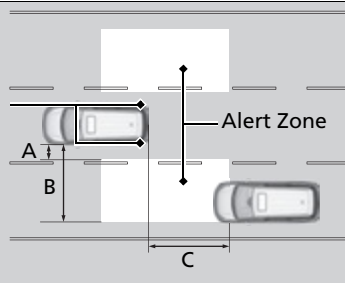

⚠ Blind spot information System*

⚠ WARNING

Failure to visually confirm that it is safe to change lanes before doing so may result in a crash and serious injury or death. Do not rely only on the blind spot information system when changing lanes. Always look in your mirrors, to either side of your vehicle, and behind you for other vehicles before changing lanes.

Important Safety Reminder

Like all assistance systems, blind spot information system has limitations. Over reliance on the blind spot information system may result in a collision.

The system is for your convenience only. Even if an object is within the alert zone, the following situations may occur.

- The blind spot information system alert indicator may not come on due to obstruction (splashes, etc.) even without the **Blind Spot Info Not Available** driver information interface appearing.
- The blind spot information system alert indicator may come on even with the message appearing.

The blind spot information system alert indicator may not come on under the following conditions:

- A vehicle does not stay in the alert zone for more than two seconds.
- A vehicle is parked in a side lane.
- The speed difference between your vehicle and the vehicle you are passing is greater than 6 mph (10 km/h).
- An object not detected by the radar sensors approaches or passes your vehicle.
- A vehicle running in the adjacent lane is a motorcycle or other small vehicle.

* Not available on all models

■ When the system detects a vehicle

Blind spot information System Alert Indicator:
Located near the pillar on both sides.

Comes on when:

- A vehicle enters the alert zone from behind to overtake you with a speed difference of no more than 31 mph (50 km/h) from your vehicle.
- You pass a vehicle with a speed difference of no more than 12 mph (20 km/h).

Blinks and the beeper sounds when:
You move the turn signal lever in the direction of the detected vehicle. The beeper sounds three times.

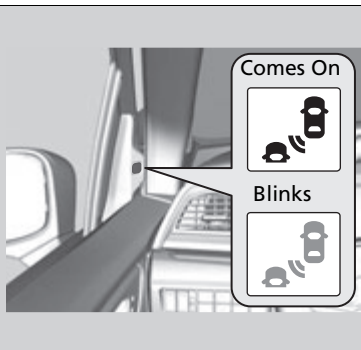

▶▶ Blind spot information System*

You can change the setting for the blind spot information system.

▶ **Customized Features** P. 463

Turn the system off when towing a trailer. The system may not work properly for the following reasons:

- The added mass tilts the vehicle and changes the radar coverage.
- The trailer itself can be detected by the radar sensors, causing the blind spot information system alert indicators to come on.

Blind spot information system may be adversely affected when:

- Objects (guard rails, poles, trees, etc..) are detected.
- An object that does not reflect radio waves well, such as a motorcycle, is in the alert zone.
- Driving on a curved road.
- A vehicle is moving from a far lane to the adjacent lane.
- The system picks up external electrical interference.
- The rear bumper or the sensors have been improperly repaired or the rear bumper has been deformed.
- The orientation of the sensors has been changed.
- In bad weather (Heavy rain, snow, and fog).

For proper blind spot information system operation:



- Always keep the rear bumper corner area clean.
- Do not cover the rear bumper corner area with labels or stickers of any kind.
- Take your vehicle to a dealer if you need the rear bumper corner area or the radar sensors to be repaired, or the rear bumper corner area is strongly impacted.

The system does not operate when in **R**.

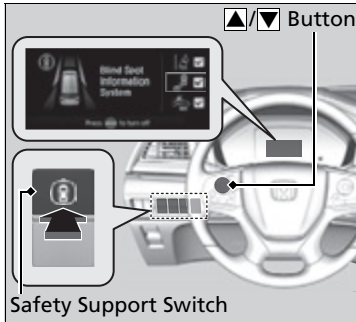
■ Blind spot information system on and off



When you turn the blind spot information system on and off, do the following.

1. Press the safety support switch.
2. Press the ▲/▼ button to select  symbol, then press **ENTER**.
 - ▶ A tick appears in the box and the color of the  symbol changes green when the system is on. The tick disappear and the color of the  symbol changes gray when the system is off.

The blind spot information system is in the previously selected on or off setting each time you start the power system.

Canadian models

LaneWatch™*

LaneWatch is an assistance system that allows you to check the passenger side rear areas displayed on the audio/information screen when the turn signal is activated to the passenger's side. A camera in the passenger side door mirror monitors these areas and allows you to check for vehicles, in addition to your visual check and use of the passenger door mirror. You can also keep the system on for your convenience while driving.

▶ LaneWatch™*

⚠ WARNING

Failure to visually confirm that it is safe to change lanes before doing so may result in a crash and serious injury or death.

Do not rely only on LaneWatch while driving.

Always look in your mirrors, to either side of your vehicle, and behind you for other vehicles before changing lanes.

Important Safety Reminder

Like all assistance systems, LaneWatch has limitations. Over reliance on LaneWatch may result in a collision.

The LaneWatch function can be affected by weather, lighting (including headlights and low sun angle), ambient darkness, camera condition, and loading.

The LaneWatch may not provide the intended display of traffic to the side and rear under the following conditions:

- Your vehicle's suspension has been altered, changing the height of the vehicle.
- Your tires are over or under inflated.
- Your tires or wheels are of varied size or construction.

1 The system activates when you:

Move the turn signal lever to the passenger side.

Press the LaneWatch button.



The system deactivates when you:

Pull the turn signal lever back.

Press the LaneWatch button again.

2

The passenger side view display appears on the audio/information screen.

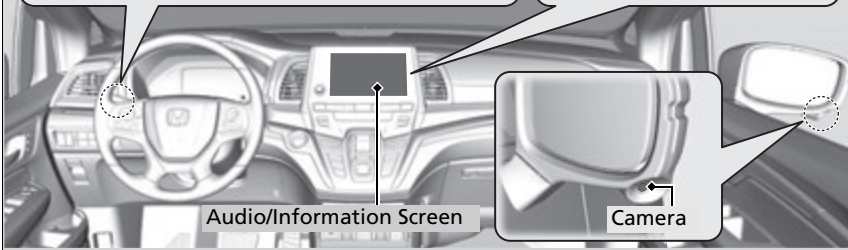

Audio/Information Screen

Camera

■ Customizing the LaneWatch settings

You can customize the following items using the audio/information screen.

- **Show with Turn Signal:** Selects whether LaneWatch monitor comes on when you operate the turn signal lever.
- **Show Reference Line:** Selects whether the reference lines appear on the LaneWatch monitor.
 - **Customized Features** P. 463

■ Reference Lines

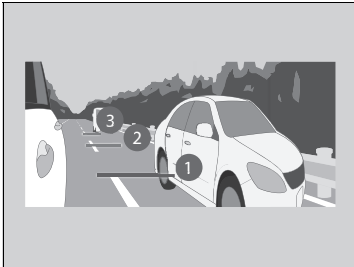

Three lines that appear on the screen can give an idea of how far the vehicles or objects on the screen are from your vehicle, respectively. If an object is near line 1 (in red), it indicates that it is close to your vehicle whereas an object near line 3 is farther away.

☒ LaneWatch™*

The LaneWatch camera view is restricted. Its unique lens makes objects on the screen slightly look different from what they are.

LaneWatch display does not come on when the transmission is in **[R]**.

For proper LaneWatch operation:

- The camera is located in the passenger side door mirror. Always keep this area clean. If the camera lens is covered with dirt or moisture, use a soft, moist cloth to keep the lens clean and free of debris.
- Do not cover the camera lens with labels or stickers of any kind.
- Do not touch the camera lens.

☒ Reference Lines

The area around the reference line 1 (red) is very close to your vehicle. As always, make sure to visually confirm the safety of a lane change before changing lanes.

The distance between your vehicle and lines 1, 2 and 3 on the screen vary depending on road conditions and vehicle loading. For example, the reference lines on the screen may seem to appear closer than the actual distances when the rear of your vehicle is more heavily loaded.

Consult a dealer if:

- The passenger side door mirror, or area around it is severely impacted, resulting in changing the camera angle.
- The LaneWatch display does not come on at all.

* Not available on all models

Honda Sensing® is a driver support system which employs the use of two distinctly different kinds of sensors: a radar sensor located inside the front grille and a front sensor camera mounted to the interior side of the windshield, behind the rearview mirror.

Honda Sensing® has following functions.

■ The functions which do not require switch operations to activate

- Collision Mitigation Braking System™ (CMBS™) ➤ P. 589
- Road Departure Mitigation (RDM) System ➤ P. 625
- Traffic Sign Recognition System ➤ P. 630

■ The functions which require switch operations to activate

- Adaptive Cruise Control (ACC) with Low Speed Follow ➤ P. 600
- Lane Keeping Assist System (LKAS) ➤ P. 616

■ Operation Switches for the ACC with Low Speed Follow/ LKAS

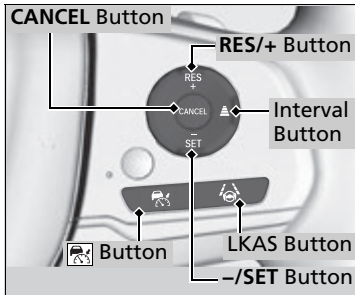

■ Button

Press to activate standby mode for ACC with Low Speed Follow. Or press to cancel the system.

■ LKAS Button

Press to activate standby mode for LKAS. Or press to cancel this system.

■ RES/+ and -/SET Buttons

Press **RES/+** button to resume the ACC with Low Speed Follow or increase the vehicle speed.

Press **-/SET** button to set the ACC with Low Speed Follow or decrease the vehicle speed.

■ Interval Button

Press to change the ACC with Low Speed Follow following-interval.

■ CANCEL Button

Press to cancel ACC with Low Speed Follow.

■ Driver Information Interface Content

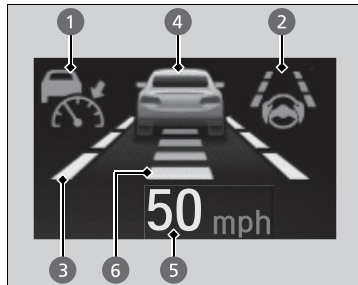

You can see the current state of ACC with Low Speed Follow, and LKAS.

- ① Indicates that ACC with Low Speed Follow is ready to be activated.
 - White: The system is in standby.
 - Green: The system is on.
 - Amber: There is a problem with the system.
- ② Indicates that LKAS is ready to be activated.
 - White: The system is in standby.
 - Green: The system is on.
 - Amber: There is a problem with the system.
- ③ Indicates that LKAS is activated and whether or not traffic lane lines are detected.
 - Solid line: The system is on.
 - Contour line: The system is in standby.
- ④ Indicates whether or not ACC with Low Speed Follow detects the vehicle ahead.
- ⑤ Shows vehicle set speed in ACC with Low Speed Follow.
- ⑥ Shows set vehicle interval in ACC with Low Speed Follow.

Collision Mitigation Braking System™ (CMBS™)

The system can assist you when it determines there is a possibility of your vehicle colliding with a vehicle or a pedestrian detected in front of your vehicle. The CMBS™ is designed to alert you when the potential for a collision is determined, as well as to reduce your vehicle speed to help minimize collision severity when a collision is deemed unavoidable.

Collision Mitigation Braking System™ (CMBS™)

For directions on the proper handling of the radar sensor, refer to the following page.

➤ **Radar Sensor** P. 637

You can read about handling information for the camera equipped with this system.

➤ **Front Sensor Camera** P. 635

Important Safety Reminder

The CMBS™ is designed to reduce the severity of an unavoidable collision. It does not prevent a collisions nor stop the vehicle automatically. It is still your responsibility to operate the brake pedal and steering wheel appropriately according to the driving conditions.

The CMBS™ may not activate or may not detect a vehicle in front of your vehicle under certain conditions:

➤ **CMBS™ Conditions and Limitations** P. 594

■ How the System Works

When to use

The camera is located behind the rearview mirror.

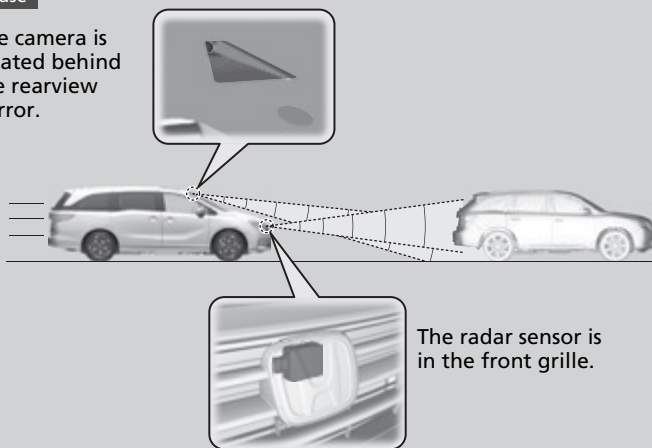

The radar sensor is in the front grille.

The system starts monitoring the roadway ahead when your vehicle speed is about 3 mph (5 km/h) and there is a vehicle in front of you.

The CMBS™ activates when:

- The speed difference between your vehicle and a vehicle or pedestrian detected in front of you becomes about 3 mph (5 km/h) and over with a chance of a collision.
- Your vehicle speed is about 62 mph (100 km/h) or less and the system determines there is a chance of a collision with:
 - Vehicles detected in front of you that are stationary, oncoming, or traveling in your same direction.
 - A pedestrian who is detected in front of you.
- Your vehicle speed is above 62 mph (100 km/h), and the system determines there is a chance of a collision with a vehicle detected in front of you traveling in your same direction.

▣ How the System Works

When the CMBS™ activates, it may automatically apply the brake. It will be canceled when your vehicle stops or a potential collision is not determined.

■ When the system activates

The system provides visual and audible alerts of a possible collision, and stops if the collision is avoided.

- Take appropriate action to prevent a collision (apply the brakes, change lanes, etc.)

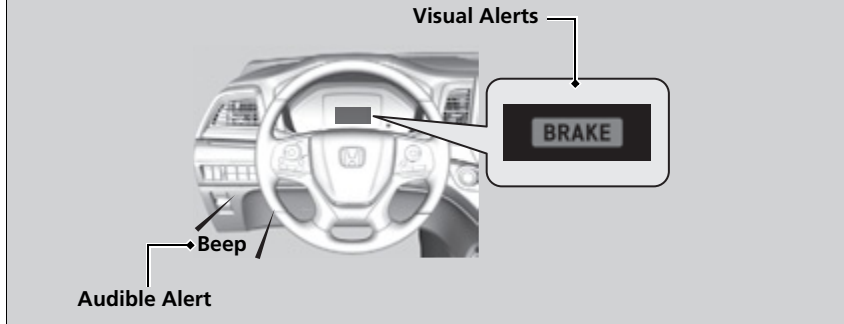

You can change the distance (**Long/Normal/Short**) between vehicles at which the system's earliest collision alert will come on through the driver information interface* or audio/information screen* setting options.

- **List of customizable options** P. 146, 470

☞ When the system activates

The camera in the CMBS™ is also designed to detect pedestrians.

However, this pedestrian detection feature may not activate or may not detect a pedestrian in front of your vehicle under certain conditions.

Refer to the ones indicating the pedestrian detection limitations from the list.

- **CMBS™ Conditions and Limitations** P. 594

■ Collision Alert Stages

The system has three alert stages for a possible collision. However, depending on circumstances, the CMBS™ may not go through all of the stages before initiating the last stage.

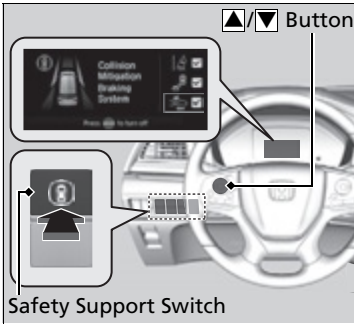

Distance between vehicles		CMBS™		
		The sensors detect a vehicle	Audible & Visual WARNINGS	Braking
Stage one		There is a risk of a collision with the vehicle ahead of you.	When in Long , visual and audible alerts come on at a longer distance from a vehicle ahead than in Normal setting, and in Short , at a shorter distance than in Normal .	—
Stage two		The risk of a collision has increased, time to respond is reduced.	Visual and audible alerts.	Lightly applied
Stage three		The CMBS™ determines that a collision is unavoidable.		Forcefully applied

■ CMBS™ On and Off



When you turn the CMBS™ on and off, do the following.

1. Press the safety support switch.
2. Press the ▲/▼ button to select , then press **ENTER**.

- ▶ A tick appears in the box and the color of the  symbol changes green when the system is on. The tick disappear and the color of the  symbol changes gray when the system is off.

The CMBS™ is turned on every time you start the engine, even if you turned it off the last time you drove the vehicle.

▣ CMBS™ On and Off

The CMBS™ may automatically shut off, and the safety support indicator (amber) will come and stay on under certain conditions:

▶ **CMBS™ Conditions and Limitations** P. 594

When the CMBS™ is activated, it will continue to operate even if the accelerator pedal is partially depressed. However, it will be canceled if the accelerator pedal is deeply depressed.

Have your vehicle checked by a dealer if you find any unusual behavior of the system (e.g., the warning message appears too frequently).

■ CMBS™ Conditions and Limitations

The system may automatically shut off and the safety support indicator (amber) will come on under certain conditions. Some examples of these conditions are listed below. Other conditions may reduce some of the CMBS™ functions.

➤ **Front Sensor Camera** P. 635

➤ **Radar Sensor** P. 637

■ Environmental conditions

- Driving in bad weather (rain, fog, snow, etc.).
- Sudden changes between light and dark, such as an entrance or exit of a tunnel.
- There is little contrast between objects and the background.
- Driving into low sunlight (e.g., at dawn or dusk).
- Strong light is reflected onto the roadway.
- Driving in the shadows of trees, buildings, etc.
- Roadway objects or structures are misinterpreted as vehicles and pedestrians.
- Reflections on the interior of the windshield.
- Driving at night or in a dark condition such as a tunnel.

■ Roadway conditions

- Driving on a snowy or wet roadway (obscured lane marking, vehicle tracks, reflected lights, road spray, high contrast).
- Driving on curvy, winding, or undulating roads.
- The road is hilly or the vehicle is approaching the crest of a hill.

■ Vehicle conditions

- Headlight lenses are dirty or the headlights are not properly adjusted.
- The outside of the windshield is blocked by dirt, mud, leaves, wet snow, etc.
- The inside of the windshield is fogged.
- An abnormal tire or wheel condition (wrong size, varied size or construction, improperly inflated, compact spare tire, etc.).
- When tire chains are installed.
- The vehicle is tilted due to a heavy load or suspension modifications.
- The camera temperature gets too high.
- Driving with the parking brake applied.
- When the radar sensor in the front grille gets dirty.
- The vehicle is towing a trailer.
- Driving at night or in a dark place (e.g., a tunnel) with the headlights off.

■ Detection limitations

- A vehicle or pedestrian suddenly crosses in front of you.
- The distance between your vehicle and the vehicle or pedestrian ahead of you is too short.
- A vehicle cuts in front of you at a slow speed, and it brakes suddenly.
- When you accelerate rapidly and approach the vehicle or pedestrian ahead of you at high speed.
- The vehicle ahead of you is a motorcycle, bicycle, mobility scooter or other small vehicle.
- When there are animals in front of your vehicle.
- When you drive on a curved, winding or undulating road that makes it difficult for the sensor to properly detect a vehicle in front of you.
- The speed difference between your vehicle and a vehicle or pedestrian in front of you is significantly large.
- An oncoming vehicle suddenly comes in front of you.
- Another vehicle suddenly comes in front of you at an intersection, etc.
- Your vehicle abruptly crosses over in front of an oncoming vehicle.
- When driving through a narrow iron bridge.
- When the lead vehicle suddenly slows down.

Limitations applicable to pedestrian detection only

- When there is a group of people in front of your vehicle walking together side by side.
- Surrounding conditions or belongings of the pedestrian alter the pedestrian's shape, preventing the system from recognizing that the person is a pedestrian.
- When the pedestrian is shorter than about 3.3 feet (1 meter) or taller than about 6.6 feet (2 meters) in height.
- When a pedestrian blends in with the background.
- When a pedestrian is bent over or squatting, or when their hands are raised or they are running.
- When several pedestrians are walking ahead in a group.
- When the camera cannot correctly identify that a pedestrian is present due to an unusual shape (holding luggage, body position, size).

■ Automatic shutoff

CMBS™ may automatically shut itself off and the safety support indicator (amber) comes and stays on when:

- The temperature inside the system is high.
- You drive off-road or on a mountain road, or curved and winding road for an extended period.
- An abnormal tire condition is detected (wrong tire size, flat tire, etc.).
- The camera behind the rearview mirror, or the area around the camera, including the windshield, gets dirty.

Once the conditions that caused CMBS™ to shut off improve or are addressed (e.g., cleaning), the system comes back on.

■ With Little Chance of a Collision

The CMBS™ may activate even when you are aware of a vehicle ahead of you, or when there is no vehicle ahead. Some examples of this are:

■ When passing

Your vehicle approaches another vehicle ahead of you and you change lanes to pass.

■ At an intersection

Your vehicle approaches or passes another vehicle that is making a left or right turn.

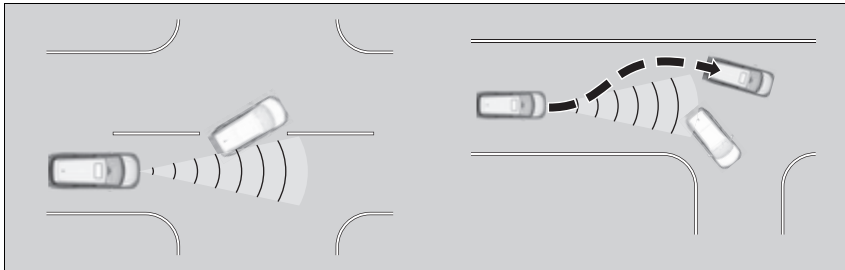

▶ With Little Chance of a Collision

For the CMBS™ to work properly:

Always keep the radar sensor cover clean.

Never use chemical solvents or polishing powder for cleaning the sensor cover. Clean it with water or a mild detergent.

■ On a curve

When driving through curves, your vehicle comes to a point where an oncoming vehicle is right in front of you.

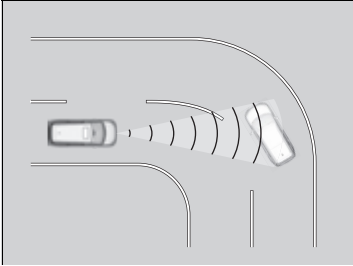
**■ Through a low bridge at high speed**

You drive under a low or narrow bridge at high speed.

■ Speed bumps, road work sites, train tracks, roadside objects, etc.

You drive over speed bumps, steel road plates, etc., or your vehicle approaches train tracks or roadside objects [such as a traffic sign and guard rail] on a curve or, when parking, stationary vehicles and walls.

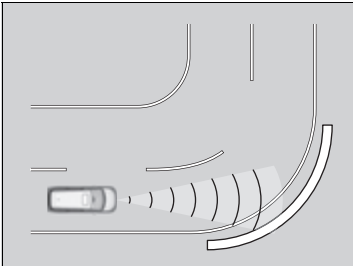

Adaptive Cruise Control (ACC) with Low Speed Follow

Helps maintain a constant vehicle speed and a set following-interval behind a vehicle detected ahead of yours and, if the detected vehicle comes to a stop, can decelerate and stop your vehicle, without you having to keep your foot on the brake or the accelerator.

When ACC with Low Speed Follow slows your vehicle by applying the brakes, your vehicle's brake lights will illuminate.

▶ Adaptive Cruise Control (ACC) with Low Speed Follow

⚠ WARNING

Improper use of ACC with Low Speed Follow can lead to a crash.

Use ACC with Low Speed Follow only when driving on expressways or freeways and in good road and weather conditions.

⚠ WARNING

ACC with Low Speed Follow has limited braking capability and may not stop your vehicle in time to avoid a collision with a vehicle that quickly stops in front of you.

Always be prepared to apply the brake pedal if the conditions require.

Important Reminder

As with any system, there are limits to ACC with Low Speed Follow. Use the brake pedal whenever necessary, and always keep a safe interval between your vehicle and other vehicles.

When to use

The camera is located behind the rearview mirror.



The radar sensor is inside the front grille.

■ **Vehicle speed for ACC with Low Speed Follow:** A vehicle is detected ahead within ACC with Low Speed Follow range – ACC with Low Speed Follow operates at speeds up to 90 mph (145 km/h).

No vehicle is detected within ACC with Low Speed Follow range – ACC with Low Speed Follow operates at the speed of 25 mph (40 km/h) or above.

■ **Gear positions for adaptive cruise control:** In **D** or **S**

■ How to activate the system

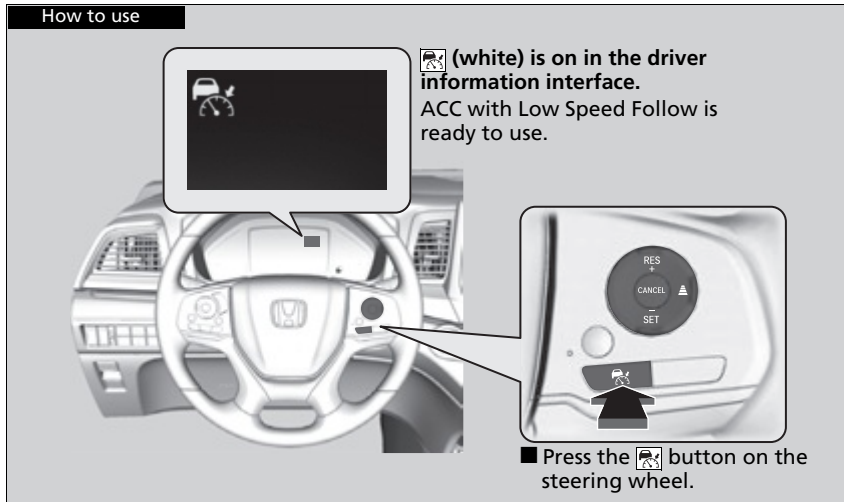

▣ Adaptive Cruise Control (ACC) with Low Speed Follow

For directions on the proper handling of the radar sensor, refer to the following page.

▣ **Radar Sensor** P. 637

You can read about handling information for the camera equipped with this system.

▣ **Front Sensor Camera** P. 635

The radar sensor for ACC with Low Speed Follow is shared with the Collision Mitigation Braking System™ (CMBS™).

▣ **Collision Mitigation Braking System™ (CMBS™)** P. 589

ACC with Low Speed Follow may not work properly under certain conditions.

▣ **ACC with Low Speed Follow Conditions and Limitations** P. 607

When not using ACC with Low Speed Follow: Turn off adaptive cruise by pressing the  button.

■ To Set the Vehicle Speed

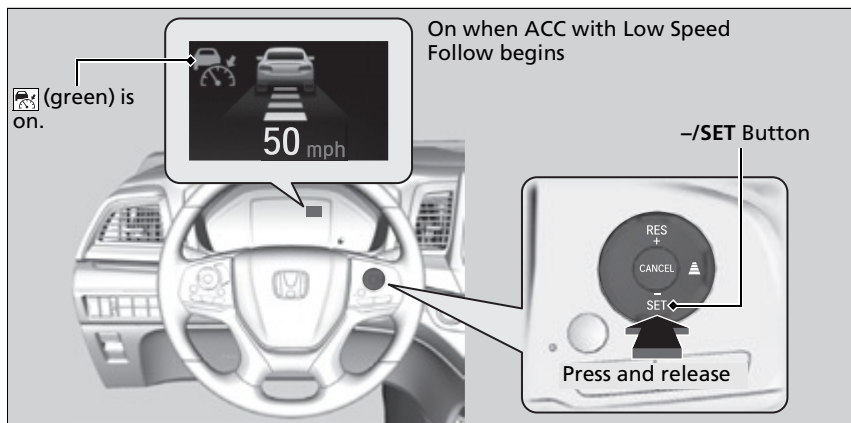

When driving at about 25 mph (40 km/h) or above: Take your foot off the pedal and press down the **-/SET** button when you reach the desired speed. The moment you release the button, the set speed is fixed, and ACC with Low Speed Follow begins.

When driving slower than about 25 mph (40 km/h): If the vehicle is moving and the brake pedal is not depressed, pressing the switch fixes your set speed to about 25 mph (40 km/h) regardless of current vehicle speed. If your vehicle is stationary, you can set the vehicle speed even with the brake pedal depressed.

▣ Adaptive Cruise Control (ACC) with Low Speed Follow

Do not use ACC with Low Speed Follow under the following conditions:

- On roads with heavy traffic or while driving in continuous stop and go traffic.
- On roads with sharp turns.
- On roads with steep downhill sections, as the set vehicle speed can be exceeded by coasting. In such cases, ACC with Low Speed Follow will not apply the brakes to maintain the set speed.
- On roads with toll collection facilities or other objects between lanes of traffic, or in parking areas, or facilities with drive through access.

▣ To Set the Vehicle Speed

You can switch the displayed set speed measurements on the driver information interface between mph and km/h.

▣ **Units** P. 138

When ACC with Low Speed Follow starts operating, the vehicle icon, interval bars and set speed appear on the driver information interface.

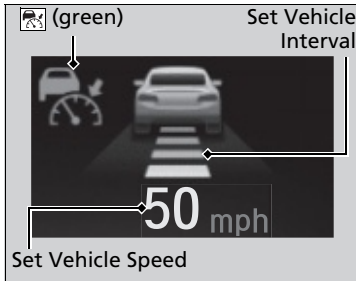

When you use ACC with Low Speed Follow, Straight Driving Assist (a feature of the Electric Power Steering system) is activated. By enabling the steering system to automatically compensate for natural steering pull, Straight Driving Assist makes it easier for you to keep your vehicle in a straight line.

■ When in Operation

■ There is a vehicle ahead

ACC with Low Speed Follow monitors if a vehicle ahead of you enters the ACC with Low Speed Follow range. If a vehicle is detected doing so, the ACC with Low Speed Follow system maintains or decelerates your vehicle's set speed in order to keep the vehicle's set following-interval from the vehicle ahead.

➔ **To Set or Change Following-interval** P. 610

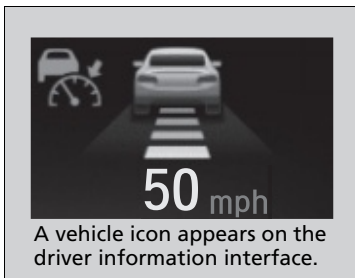
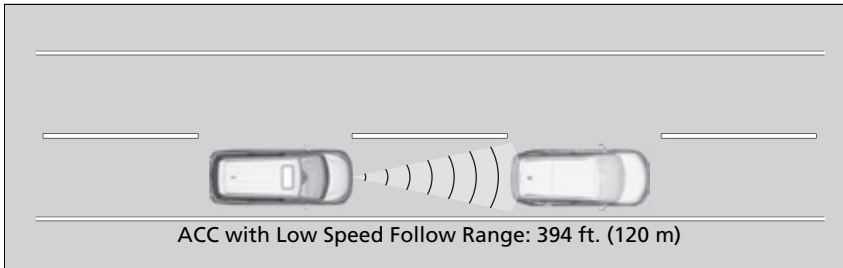

When a vehicle whose speed is slower than your set speed is detected in front of you, your vehicle starts to slow down.

⊠ When in Operation

If the vehicle ahead of you slows down abruptly, or if another vehicle cuts in front of you, a beeper sounds, a message appears on the driver information interface.

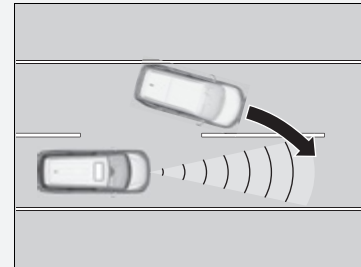

Depress the brake pedal, and keep an appropriate interval from the vehicle ahead.

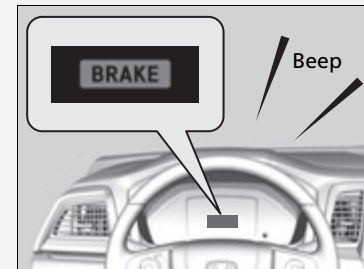

■ **There is no vehicle ahead**

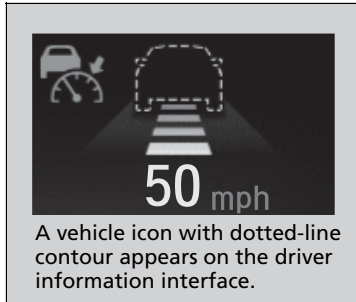

Your vehicle maintains the set speed without having to keep your foot on the brake or accelerator pedal.

If there previously was a vehicle detected ahead that kept your vehicle from traveling at the set speed, ACC with Low Speed Follow accelerates your vehicle to the set speed, and then maintains it.

■ **When you depress the accelerator pedal**

You can temporarily increase the vehicle speed. In this case, there is no audible or visual alert even if a vehicle is in the ACC with Low Speed Follow range. ACC with Low Speed Follow stays on unless you cancel it. Once you release the accelerator pedal, the system resumes an appropriate speed for keeping the following-interval while a vehicle ahead is within the ACC with Low Speed Follow range.

⌘ **When in Operation**

Even if the interval between your vehicle and the vehicle detected ahead is short, ACC with Low Speed Follow may start accelerating your vehicle under the following circumstances:

- The vehicle ahead of you is going at almost the same speed as, or faster than, your vehicle.
- A vehicle that cuts in front of you is going faster than your vehicle, gradually increasing the interval between the vehicles.

You can also set the system to beep when a vehicle in front of you comes in and goes out of the ACC with Low Speed Follow detecting range. Change the **ACC Forward Vehicle Detect Beep** setting.

⌘ **Vehicle Customization** P. 143

⌘ **Customized Features** P. 463

Limitations

You may need to use the brake to maintain a safe interval when using ACC with Low Speed Follow. Additionally, ACC with Low Speed Follow may not work properly under certain conditions.

⌘ **ACC with Low Speed Follow Conditions and Limitations** P. 607

■ A vehicle detected ahead is within ACC with Low Speed Follow range and slows to a stop



Your vehicle also stops, automatically. The **Stopped** message appears on the driver information interface. When the vehicle ahead of you starts again, the vehicle icon on the driver information interface blinks. If you press the **RES/+** or **-/SET** button, or depress the accelerator pedal, ACC with Low Speed Follow operates again within the prior set speed.

If no vehicle is ahead of you before you resume driving, depressing the accelerator pedal will resume operation of ACC with Low Speed Follow within the prior set speed.



ⓘ A vehicle detected ahead is within ACC with Low Speed Follow range and slows to a stop

WARNING

Exiting a vehicle that has been stopped while the ACC with Low Speed Follow system is operating can result in the vehicle moving without operator control.

A vehicle that moves without operator control can cause a crash, resulting in serious injury or death.

Never exit a vehicle when the vehicle is stopped by ACC with Low Speed Follow.

■ ACC with Low Speed Follow Conditions and Limitations

The system may automatically shut off and the  indicator will come on under certain conditions. Some examples of these conditions are listed below. Other conditions may reduce some of the ACC functions.

📷 **Front Sensor Camera** P. 635

📡 **Radar Sensor** P. 637

■ Environmental conditions

Driving in bad weather (rain, fog, snow, etc.).

■ Roadway conditions

Driving on a snowy or wet roadway (obscured lane marking, vehicle tracks, reflected lights, road spray, high contrast).

■ Vehicle conditions

- The outside of the windshield is blocked by dirt, mud, leaves, wet snow, etc.
- An abnormal tire or wheel condition (wrong size, varied size or construction, improperly inflated, compact spare tire, etc.).
- The camera temperature gets too high.
- The parking brake is applied.
- The front grille is dirty.
- The vehicle is tilted due to a heavy load or suspension modifications.
- Tire chains are installed.
- The vehicle is towing a trailer.

📷 ACC with Low Speed Follow Conditions and Limitations

If you need the radar sensor to be repaired, or removed, or the radar sensor cover is strongly impacted, turn off the system by pressing the  button and take your vehicle to a dealer.

Have your vehicle checked by a dealer if you find any unusual behavior of the system (e.g., the warning message appears too frequently).

■ Detection limitations

- A vehicle suddenly crosses in front of you.
- The interval between your vehicle and the vehicle ahead of you is too short.
- A vehicle cuts in front of you at a slow speed, and it brakes suddenly.
- You accelerate rapidly and approach the vehicle ahead of you at high speed.
- The vehicle ahead of you is a motorcycle, bicycle, mobility scooter, or other small vehicle.
- There are animals in front of your vehicle.
- You drive on a curved or winding or undulating road that makes it difficult for the sensor to properly detect a vehicle in front of you.

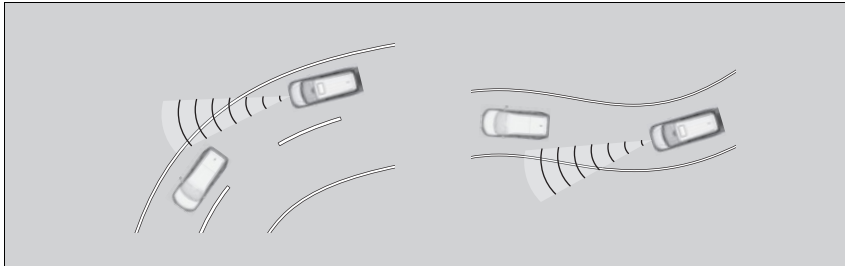

- The speed difference between your vehicle and a vehicle in front of you is significantly large.
- An oncoming vehicle suddenly comes in front of you.
- Your vehicle abruptly crosses over in front of an oncoming vehicle.

- Driving through a narrow metal bridge.



- The vehicle ahead of you brakes suddenly.
- The vehicle ahead of you has a unique shape.

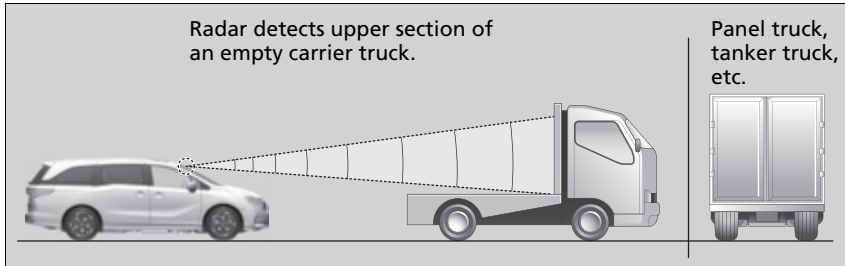

- Your vehicle or the vehicle ahead of you is driving on one edge of the lane.

■ To Adjust the Vehicle Speed

Increase or decrease the vehicle speed using the **RES/+** or **-/SET** buttons on the steering wheel.

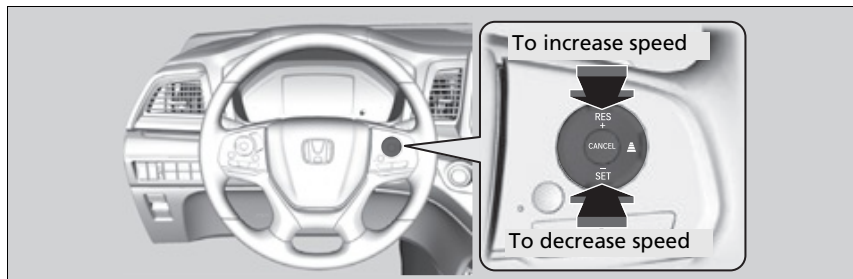

- Each time you press the **RES/+** or **-/SET** button, the vehicle speed is increased or decreased by about 1 mph or 1 km/h accordingly.
- If you keep the **RES/+** or **-/SET** button pressed, the vehicle speed increases or decreases by about 5 mph or 5 km/h accordingly.

■ To Set or Change Following-interval

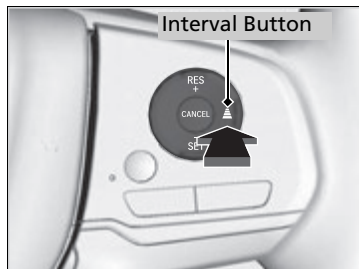

Press the interval button to change the ACC with Low Speed Follow following-interval. Each time you press the button, the following-interval (the interval behind a vehicle detected ahead of you) setting cycles through short, middle, long, and extra long following-intervals.





▣ To Adjust the Vehicle Speed

If a vehicle detected ahead is going at a speed slower than your increased set speed, ACC with Low Speed Follow may not accelerate your vehicle. This is to maintain the set interval between your vehicle and the vehicle ahead.

When you depress the accelerator pedal and then push and release the **-/SET** button, the current speed of the vehicle is set.

Determine the most appropriate following-interval setting based on your specific driving conditions. Be sure to adhere to any following-interval requirements set by local regulation.

The higher your vehicle's following-speed is, the longer the short, middle, long or extra long following-interval becomes. See the following examples for your reference.

Vehicle Interval		When the Set Speed is:	
		50 mph (80 km/h)	65 mph (104 km/h)
Short		83 feet 25 meters 1.1 sec	100 feet 31 meters 1.1 sec
Middle		110 feet 33 meters 1.5 sec	137 feet 42 meters 1.5 sec
Long		154 feet 47 meters 2.1 sec	200 feet 61 meters 2.1 sec
Extra Long		204 feet 62 meters 2.8 sec	265 feet 81 meters 2.8 sec

When your vehicle stops automatically because a vehicle detected ahead of you has stopped, the interval between the two vehicles will vary based on the ACC with Low Speed Follow interval setting.

Continued

■ To Cancel

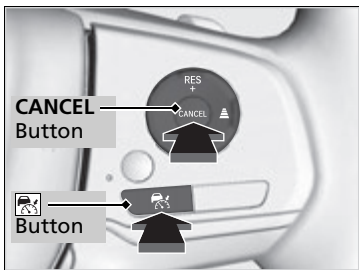

To cancel ACC with Low Speed Follow, do any of the following:

- Press the **CANCEL** button.
 - ▶ The indicator (green) on the driver information interface changes to the indicator (white).
- Press the button.
 - ▶ indicator (green) goes off.
- Depress the brake pedal while the vehicle is moving forward.
 - ▶ The indicator (green) on the driver information interface changes to the indicator (white).

▶▶ To Cancel

Resuming the prior set speed: After you have canceled ACC with Low Speed Follow, you can resume the prior set speed while it is still displayed. Press the **RES/+** button when driving at a speed of at least 25 mph (40 km/h) or more.

The set speed cannot be set or resumed when ACC with Low Speed Follow has been turned off using the button. Press the button to activate the system, then set the desired speed.

■ Automatic cancellation

The beeper sounds and a message appears on the driver information interface when ACC with Low Speed Follow is automatically canceled. Any of these conditions may cause the ACC with Low Speed Follow to automatically cancel:

- Bad weather (rain, fog, snow, etc.).
- When the radar sensor inside the front grille gets dirty.
- The vehicle ahead of you cannot be detected.
- An abnormal tire condition is detected, or the tires are skidding.
- Driving on a mountainous road, or driving off road for extended periods.
- Abrupt steering wheel movement.
- When the ABS or VSA® or CMBS™ is activated.
- When the ABS or VSA® system indicator comes on.
- When the vehicle is stopped on a very steep slope.
- When you manually apply the parking brake.
- When the detected vehicle within the ACC with Low Speed Follow range is too close to your vehicle.
- The camera behind the rearview mirror, or the area around the camera, including the windshield, gets dirty.
- When the Maximum Load Limit is exceeded.
- When passing through an enclosed space, such as tunnel.

The ACC with Low Speed Follow automatic cancellation can be also triggered by the following causes. In these cases, the parking brake will be automatically applied.

- The driver's seat belt is unfastened when the vehicle is stationary.
- The vehicle stops for more than 10 minutes.
- The power system is turned off.

In the following cases, a buzzer sounds, ACC with Low Speed Follow is deactivated, and the **Cruise Cancelled: System Not Available** message appears in the driver information interface.

- The vehicle has repeatedly applied the brakes to maintain the set speed (for example, you are descending a long slope).

⌘ Automatic cancellation

Even though ACC with Low Speed Follow has been automatically canceled, you can still resume the prior set speed. Wait until the condition that caused ACC with Low Speed Follow to cancel improves, then press the **RES/+** button.

■ To Switch ACC with Low Speed Follow to Cruise Control

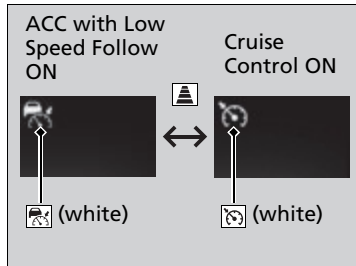

Press and hold the  (interval) button for one second. **Cruise Mode Selected** appears on the driver information interface for two seconds, and then the mode switches to Cruise.

To switch back to ACC with Low Speed Follow, press and hold the  (interval) button again for one second. **ACC Mode Selected** appears on the driver information interface for two seconds.

■ When to use

Desired speed in a range above roughly 25 mph (40 km/h).

ⓘ To Switch ACC with Low Speed Follow to Cruise Control

Always be aware which mode you are in. When you are driving in Cruise mode, the system will not assist you to maintain a following-interval from a vehicle ahead of you.

You can switch the displayed set speed measurements on the driver information interface between mph and km/h.

➤ **Units** P. 138

■ To Set the Vehicle Speed

Take your foot off the pedal and press the **-/SET** button when you reach the desired speed.

The moment you release the **-/SET** button, the set speed is fixed, and cruise control begins. The  indicator (green) comes on.

When you use cruise control, Straight Driving Assist (a feature of the Electric Power Steering system) is activated.

By enabling the steering system to automatically compensate for natural steering pull, Straight Driving Assist makes it easier for you to keep your vehicle in a straight line.







■ To Adjust the Vehicle Speed

Each time you press the **RES/+** or **-/SET** button, the vehicle speed is increased or decreased by about 1 mph (1 km/h).

If you keep the **RES/+** or **-/SET** button pressed, the vehicle speed increases or decreases until you release it. This speed is then set.

■ To Cancel

To cancel cruise control, do any of the following:

- Press the **CANCEL** button.
 - ▶ The  indicator (green) on the driver information interface change to the  indicator (white.)
- Press the  button.
 - ▶  indicator (green) goes off.
- Depress the brake pedal.
 - ▶ The  indicator (green) on the driver information interface change to the  indicator (white.)

☒ To Cancel

Resuming the prior set speed:

After cruise control has been canceled, you can still resume the prior set speed by pressing the **RES/+** button while driving at a speed of at least 25 mph (40 km/h) or more.

You cannot set or resume in the following situations:

- When vehicle speed is less than 25 mph (40 km/h)
- When the  button is turned off.

At vehicle speeds of 22 mph (35 km/h) or less, cruise control canceled automatically.

Lane Keeping Assist System (LKAS)

Provides steering input to help keep the vehicle in the middle of a detected lane and provides tactile and visual alerts if the vehicle is detected drifting out of its lane.

■ Steering input assist

The system applies torque to the steering to keep the vehicle between the left and right lane lines. The applied torque becomes stronger as the vehicle gets closer to either of the lane lines.

■ Front sensor camera Monitors the lane lines



■ Tactile and visual alerts Rapid vibrations on the steering wheel and a warning display alert you that the vehicle is drifting out of a detected lane.

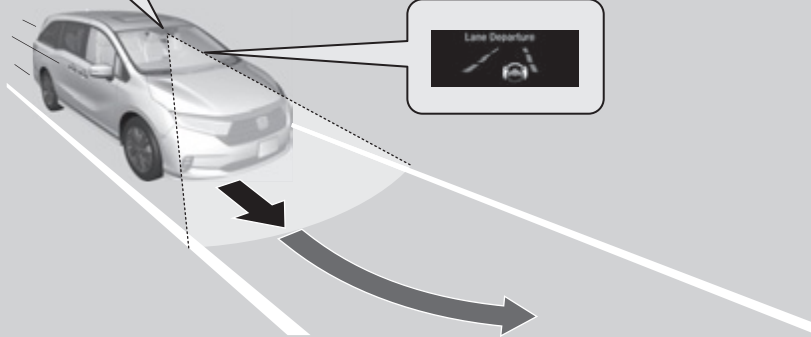

When you operate the turn signals to change lanes, the system is suspended, and resumes after the signals are off.

If you make a lane change without operating the turn signals, the LKAS alerts activate, and torque is applied to the steering.

☒ Lane Keeping Assist System (LKAS)

Important Safety Reminders

The LKAS is for your convenience only. It is not a substitute for your vehicle control. The system does not work if you take your hands off the steering wheel or fail to steer the vehicle.

☒ Driver Information Interface Warning and Information Messages P. 108

Do not place objects on the instrument panel. Objects may reflect on the front windshield and prevent correct detection of the traffic lanes.

The LKAS only alerts you when lane drift is detected without a turn signal in use. The LKAS may not detect all lane markings or lane departures; accuracy will vary based on weather, speed, and lane marker condition. It is always your responsibility to safely operate the vehicle and avoid collisions.

The LKAS is convenient when it is used on freeways.

The LKAS may not work properly or may work improperly under the certain conditions:

☒ LKAS Conditions and Limitations P. 622

You can read about handling information for the camera equipped with this system.

☒ Front Sensor Camera P. 635

When it fails to detect lanes, the system will temporarily be canceled. When lane is detected, system will recover automatically.

■ Lane Keep Support Function

Provides assistance to keep the vehicle in the center of the lane. When the vehicle nears a white or yellow line, steering force of the electric power steering will become stronger.

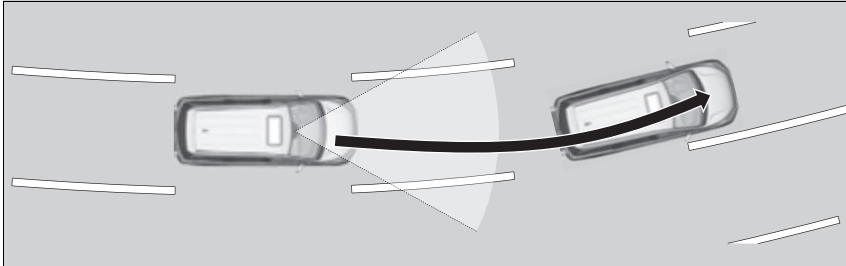

■ Lane Departure Warning Function

When the vehicle enters the warning area, the LKAS alerts you with slight steering wheel vibration as well as a warning display.

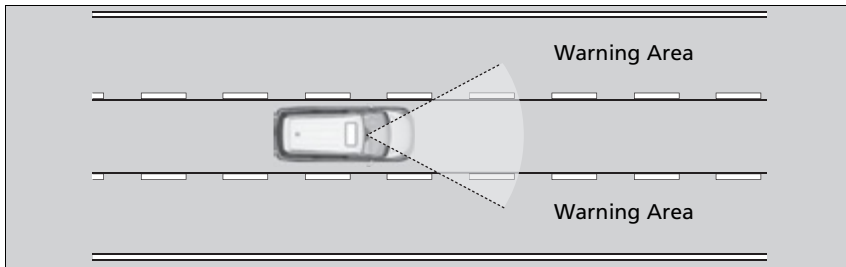

⚠ Lane Keeping Assist System (LKAS)

The LKAS may not function as designed while driving in frequent stop and go traffic, or on roads with sharp curves.

■ When the System can be Used

The system can be used when the following conditions are met.

- The lane in which you are driving has detectable lane markers on both sides, and your vehicle is in the center of the lane.
- The vehicle is traveling between about 45 and 90 mph (72 and 145 km/h).
- You are driving on a straight or slightly curved road.
- The turn signals are off.
- The brake pedal is not depressed.
- The wipers are not in high speed operation.

■ How to activate the system

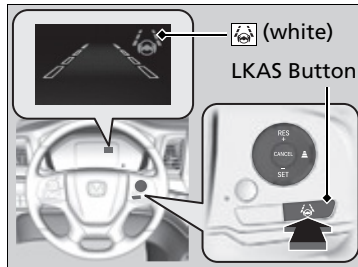

1. Press the LKAS button.

- ▶ Lane outlines appear on the driver information interface.

The icon is on in the driver information interface.

The system is ready to use.

▶ Lane Keeping Assist System (LKAS)

If the vehicle drifts toward either left or right lane line due to the system applying torque, turn off the LKAS and have your vehicle checked by a dealer.

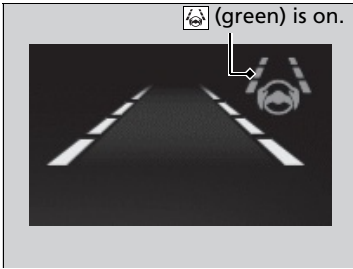

2. Keep your vehicle near the center of the lane while driving.
 - ▶ The dotted outer lines change to solid ones once the system starts operating after detecting the left and right lane markings.

■ To Cancel

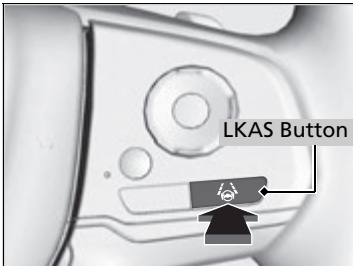

Press the LKAS button.

The LKAS is turned off every time you stop the engine, even if you turned it on the last time you drove the vehicle.

 (white) is on.

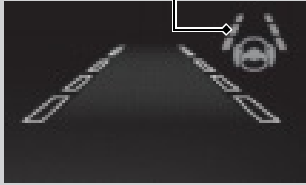

When the LKAS is suspended, the lane lines on the driver information interface change to contour lines, and the beeper sounds (if activated).

■ **The system operation is suspended if you:**

- Set the wipers to high speed.
 - ▶ Turning the wipers off, setting it to **LO**, or the wipers are operating intermittently resumes the LKAS.
- Decrease the vehicle speed to about 40 mph (64 km/h) or less.
 - ▶ Increasing the vehicle speed to about 45 mph (72 km/h) or more resumes the LKAS.
- Depress the brake pedal.
 - ▶ The LKAS resumes and starts detecting the lane lines again once you release the brake pedal.
- Your vehicle is driving to the right or the left of the lane.

▶▶ The system operation is suspended if you:

You can change the setting for the LKAS.

LKAS suspended beep **ON** and **OFF** can be selected.

▶▶ **Vehicle Customization** P. 143

▶▶ **Customized Features** P. 463

■ **The LKAS may automatically be suspended when:**

- The system fails to detect lane lines.
- The steering wheel is quickly turned.
- You fail to steer the vehicle.
- Driving through a sharp curve.
- Driving at a speed in excess of approximately 90 mph (145 km/h).

Once these conditions no longer exist, the LKAS automatically resumes.

■ **The LKAS may automatically be canceled when:**

- The camera temperature gets extremely high.
- The camera behind the rearview mirror, or the area around the camera, including the windshield, gets dirty.
- The ABS or VSA® system engages.

The beeper sounds if the LKAS is automatically canceled.

■ LKAS Conditions and Limitations

The system may not detect lane markings and therefore may not keep the vehicle in the middle of a lane under certain conditions, including the following:

■ Environmental conditions

- Driving in bad weather (rain, fog, snow, etc.).
- Sudden changes between light and dark, such as an entrance or exit of a tunnel.
- There is little contrast between lane lines and the roadway surface.
- Driving into low sunlight (e.g., at dawn or dusk).
- Strong light is reflected onto the roadway.
- Driving in the shadows of trees, buildings, etc.
- Shadows of adjacent objects are parallel to lane markings.
- Roadway objects or structures are misinterpreted as lane markers.
- Reflections on the interior of the windshield.
- Driving at night or in a dark condition such as a tunnel.

■ Roadway conditions

- Driving on a snowy or wet roadway (obscured lane marking, vehicle tracks, reflected lights, road spray, high contrast).
- Driving on a road with temporary lane markings.
- Faint, multiple, or varied lane markings are visible on the roadway due to road repairs or old lane markings.

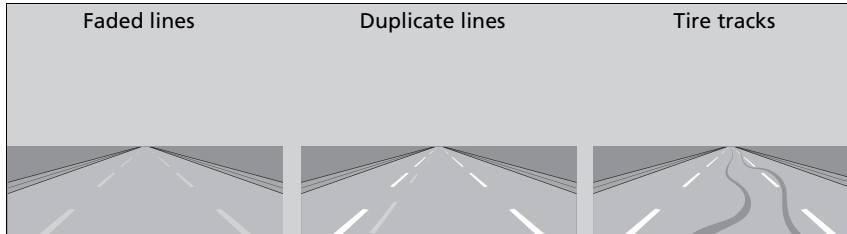

- The roadway has merging, split, or crossing lines (e.g., such as at an intersection or crosswalk).
- The lane markings are extremely narrow, wide, or changing.

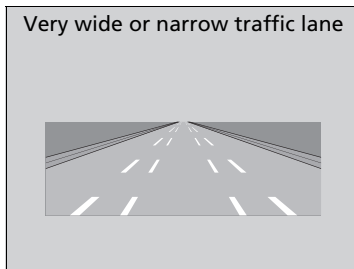

- The vehicle in front of you is driving near the lane lines.
- The road is hilly or the vehicle is approaching the crest of a hill.
- Driving on rough or unpaved roads, or over bumpy surfaces.

Continued

- When objects on the road (curb, guard rail, pylons, etc.) are recognized as white lines (or yellow lines).
- Driving on roads with double lines.

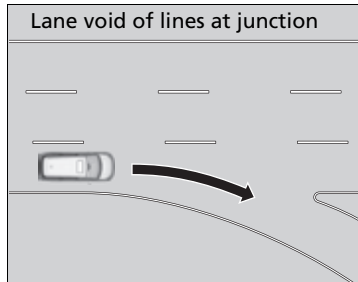

■ Vehicle conditions

- Headlight lenses are dirty or the headlights are not properly adjusted.
- The outside of the windshield is streaked or blocked by dirt, mud, leaves, wet snow, etc.
- The inside of the windshield is fogged.
- The camera temperature gets too high.
- An abnormal tire or wheel condition (wrong size, varied size or construction, improperly inflated, compact spare tire, etc.).
- The vehicle is tilted due to a heavy load or suspension modifications.
- The vehicle is towing a trailer.

Road Departure Mitigation (RDM) System

Alerts and helps to assist you when the system detects a possibility of your vehicle unintentionally crossing over detected lane markings and/or leaving the roadway altogether.

How the System Works

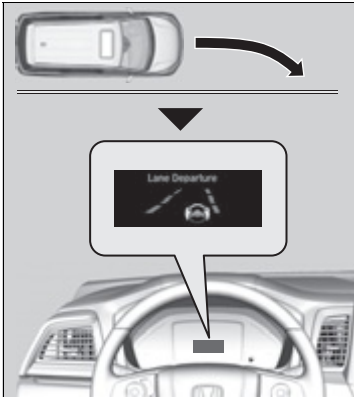

The front camera behind the rearview mirror monitors left and right lane markings (in white or yellow). If your vehicle is getting too close to detected lane markings without a turn signal activated, the system, in addition to a visual alert, applies steering torque and alerts you with rapid vibrations on the steering wheel, to help you remain within the detected lane.

- ▶ **Vehicle Customization** P. 143
- ▶ **Customized Features** P. 463

As a visual alert, the **Lane Departure** message appears on the driver information interface.

If the system determines that its steering input is insufficient to keep your vehicle on the roadway, it may apply braking.

- ▶ Braking is applied only when the lane markings are solid continuous lines.

The system cancels assisting operations when you turn the steering wheel to avoid crossing over detected lane markings.

If the system operates several times without detecting driver response, the system beeps to alert you.

⊠ Road Departure Mitigation (RDM) System

Important Safety Reminder

Like all assistance systems, the RDM system has limitations.

Over-reliance on the RDM system may result in a collision. It is always your responsibility to keep the vehicle within your driving lane.

The RDM system only alerts you when lane drift is detected without a turn signal in use. The RDM system may not detect all lane markings or lane or roadway departures; accuracy will vary based on weather, speed and lane marker condition. It is always your responsibility to safely operate the vehicle and avoid collisions.

You can read about handling information for the camera equipped with this system.

- ▶ **Front Sensor Camera** P. 635

The RDM system may not work properly or may work improperly under the certain conditions:

- ▶ **RDM Conditions and Limitations** P. 628

There are times when you may not notice RDM functions due to your operation of the vehicle, or road surface conditions.

■ How the System Activates

The system becomes ready to start searching for lane markings when all the following conditions are met:

- The vehicle is traveling between about 45 and 90 mph (72 and 145 km/h).
- The vehicle is on a straight or slightly curved road.
- The turn signals are off.
- The brake pedal is not depressed.
- The wipers are not in high speed operation.
- The vehicle is not accelerating or braking, and the steering wheel is not being turned.
- The system makes a determination that the driver is not actively accelerating, braking or steering.

▶▶ Road Departure Mitigation (RDM) System

If LKAS is off and you have selected **Narrow** from the customised options using the driver information interface* or audio/information screen*, the message below will appear in case the system determines a possibility of your vehicle crossing over detected lane markings.

- ▶ **Driver Information Interface Warning and Information Messages** P. 108
- ▶ **Vehicle Customization** P. 143
- ▶ **Customized Features** P. 463



▶▶ How the System Activates

The RDM system may automatically shut off and the safety support indicator (amber) comes and stays on.

- ▶ **Indicators** P. 88



RDM system function can be impacted when the vehicle is:

- Not driven within a traffic lane.
- Driven on the inside edge of a curve, or outside of a lane.
- Driven in a narrow lane.

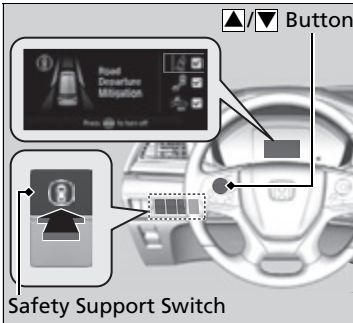
RDM On and Off



When you turn the RDM on and off, do the following.

1. Press the safety support switch.
2. Press the ▲/▼ button to select  symbol, then press **ENTER**.
 - ▶ A tick appears in the box and the color of the  symbol changes green when the system is on. The tick disappears and the color of the  symbol changes gray when the system is off.

The RDM is in the previously selected on or off setting each time you start the power system.

RDM On and Off

When you have selected **Warning Only** from the customized options using the driver information interface* or audio/information screen*, the system does not operate the steering wheel and braking.

- ▶ **Vehicle Customization** P. 143
- ▶ **Customized Features** P. 463

* Not available on all models

■ RDM Conditions and Limitations

The system may not properly detect lane markings and the position of your vehicle under certain conditions. Some examples of these conditions are listed below.

■ Environmental conditions

- Driving in bad weather (rain, fog, snow, etc.).
- Sudden changes between light and dark, such as an entrance or exit of a tunnel.
- There is little contrast between lane lines and the roadway surface.
- Driving into low sunlight (e.g., at dawn or dusk).
- Strong light is reflected onto the roadway.
- Driving in the shadows of trees, buildings, etc.
- Shadows of adjacent objects are parallel to lane markings.
- Roadway objects or structures are misinterpreted as lane markers.
- Reflections on the interior of the windshield.
- Driving at night or in a dark condition such as a tunnel.

■ Roadway conditions

- Driving on a snowy or wet roadway (obscured lane marking, vehicle tracks, reflected lights, road spray, high contrast).
- Driving on a road with temporary lane markings.
- Faint, multiple, or varied lane markings are visible on the roadway due to road repairs or old lane markings.
- The roadway has merging, split, or crossing lines (e.g., such as at an intersection or crosswalk).
- The lane markings are extremely narrow, wide, or changing.
- The vehicle in front of you is driving near the lane lines.
- The road is hilly or the vehicle is approaching the crest of a hill.
- Driving on rough or unpaved roads, or over bumpy surfaces.
- When objects on the road (curb, guard rail, pylons, etc.) are recognized as white lines (or yellow lines).
- Driving on roads with double lines.

■ Vehicle conditions

- Headlight lenses are dirty or the headlights are not properly adjusted.
- The outside of the windshield is streaked or blocked by dirt, mud, leaves, wet snow, etc.
- The inside of the windshield is fogged.
- The camera temperature gets too high.
- An abnormal tire or wheel condition (wrong size, varied size or construction, improperly inflated, compact spare tire, etc.).
- The vehicle is tilted due to a heavy load or suspension modifications.
- When tire chains are installed.
- The vehicle is towing a trailer.

Traffic Sign Recognition System

Reminds you of road sign information, such as the current speed limit your vehicle has just passed through, showing it on the driver information interface.

How the System Works

When the camera located behind the rearview mirror captures traffic signs while driving, the system displays the ones that are recognized as designated for your vehicle. The sign icon will be displayed until the vehicle reaches a predetermined time and distance.

If the system does not detect any traffic signs while you are driving, the sign icon will not be displayed

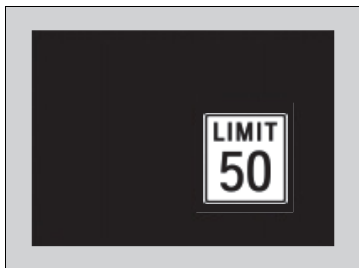

The sign icon also may switch to another one, or disappear when:

- The other designated limit is detected.
- You make a turn with a turn signal at an intersection.

Traffic Sign Recognition System

Not all signs may be displayed, but any signs posted on roadsides should not be ignored. The system does not work on the designated traffic signs of all the countries you travel, nor in all situations.

Do not rely too much on the system. Always drive at speeds appropriate for the road conditions.

Never apply a film or attach any objects to the windshield that could obstruct the camera's field of vision and cause the system to operate abnormally. Scratches, nicks, and other damage to the windshield within the camera's field of vision can cause the system to operate abnormally. If this occurs, we recommend that you replace the windshield with a genuine Honda replacement windshield. Making even minor repairs within the camera's field of vision or installing an aftermarket replacement windshield may also cause the system to operate abnormally. After replacing the windshield, have a dealer recalibrate the camera. Proper calibration of the camera is necessary for the system to operate properly.

To help reduce the likelihood that high interior temperatures will cause the camera's sensing system to shut off, when parking, find a shady area or face the front of the vehicle away from the sun. If you use a reflective sun shade, do not allow it to cover the camera housing. Covering the camera can concentrate heat on it.

You can read about handling information for the camera equipped with this system.

➤ **Front Sensor Camera** P. 635

■ Traffic Sign Recognition System Conditions and Limitations

The traffic sign recognition system may not be able to recognize a traffic sign in the following cases.

■ Vehicle conditions

- Headlight lenses are dirty or the headlights are not properly adjusted.
- The outside of the windshield is blocked by dirt, mud, leaves, wet snow, etc.
- The inside of the windshield is fogged.
- There are portions remaining to be wiped.
- An abnormal tire or wheel condition (wrong size, varied size or construction, improperly inflated, compact spare tire, etc.).
- The vehicle is tilted due to a heavy load or suspension modifications.

■ Environmental conditions

- Driving into low sunlight (e.g., at dawn or dusk).
- Strong light is reflected onto the roadway.
- Sudden changes between light and dark, such as an entrance or exit of a tunnel.
- When you drive in the shadows of trees, buildings, etc.
- Driving at night, in dark areas such as long tunnels.
- Driving in bad weather (rain, fog, snow, etc.).
- A vehicle in front of you is kicking up spray or snow.

⊠ Traffic Sign Recognition System Conditions and Limitations

When the traffic sign recognition system malfunctions,  appears on the driver information interface. If this message does not disappear, have your vehicle checked by a dealer.

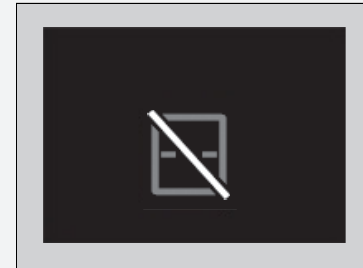

■ **The position or the condition of the traffic sign**

- A sign is hard to be found since it is in a complicated area.
- A sign is located far away from your vehicle.
- A sign is located where the beam of the headlight is hard to reach.
- A sign is on a corner or bend in the road.
- Faded or bent signs.
- Rotated or damaged signs.
- A sign is covered with mud, snow, or frost.
- A part of the sign is hidden by the trees, or the sign itself is hidden by a vehicle and others.
- Light (a streetlight) or a shadow is reflected on the surface of the sign.
- A sign is too bright or too dark (an electric sign).
- A sign of a small size.

■ **Other conditions**

- When you are driving at a high speed.

The traffic sign recognition system may not operate correctly, such as displaying a sign that does not follow the actual regulation for the roadway or does not exist at all in the following cases.

- ▶ A speed limit sign may display at a higher or lower speed than the actual speed limit.
- There is a supplementary sign with further information such as weather, time, vehicle type, school zone, etc.
- Figures on the sign are hard to read (electric signs, numbers on the sign are blurred, etc.).
- A sign is in the vicinity of the lane you are driving in even though it is not for the lane (speed limit sign situated at the junction between the side road and the main road, etc.).
- There are things that look similar to the color or shape of the recognition object (similar sign, electric sign, signboard, structure, etc.).
- A truck or another large vehicle with a sticker of the speed limit sign on the back is traveling in front of you.

■ Signs Displayed on the Driver information interface

The speed limit sign icon is displayed on the upper right half of the screen.

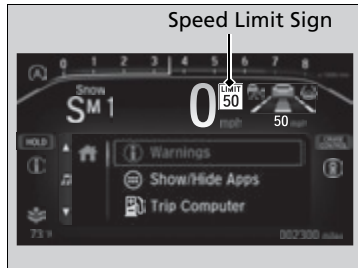

■ Speed limit sign on and off

You can switch on and off the speed limit sign on the driver information interface* or audio/information screen*.

- ▶ **Vehicle Customization** P. 143
- ▶ **Customized Features** P. 463

Front Sensor Camera

The camera, used in systems such as LKAS, RDM, ACC with Low Speed Follow, Traffic Sign Recognition System, and CMBS™, is designed to detect an object that triggers any of the systems to operate its functions.

Camera Location and Handling Tips

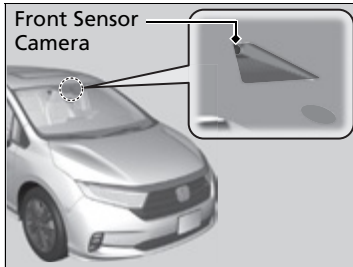

This camera is located behind the rearview mirror.

To help reduce the likelihood that high interior temperatures will cause the camera's sensing system to shut off, when parking, find a shady area or face the front of the vehicle away from the sun. If you use a reflective sun shade, do not allow it to cover the camera housing. Covering the camera can concentrate heat on it.

Front Sensor Camera

Never apply a film or attach any objects to the windshield, the hood, or the front grille that could obstruct the camera's field of vision and cause the system to operate abnormally. Scratches, nicks, and other damage to the windshield within the camera's field of vision can cause the system to operate abnormally. If this occurs, we recommend that you replace the windshield with a genuine Honda replacement windshield. Making even minor repairs within the camera's field of vision or installing an aftermarket replacement windshield may also cause the system to operate abnormally. After replacing the windshield, have a dealer recalibrate the camera. Proper calibration of the camera is necessary for the system to operate properly.

Do not place an object on the top of the instrument panel. It may reflect onto the windshield and prevent the system from detecting lane lines properly.

📷 Front Sensor Camera

If the **Some Driver Assist Systems Cannot Operate: Camera Temperature Too High** message appears:

- Use the climate control system to cool down the interior and, if necessary, also use defroster mode with the airflow directed towards the camera.
- Start driving the vehicle to lower the windshield temperature, which cools down the area around the camera.

If the **Some Driver Assist Systems Cannot Operate: Clean Front Windshield** message appears:

- Park your vehicle in a safe place, and clean the windshield. If the message does not disappear after you have cleaned the windshield and driven for a while, have your vehicle checked by a dealer.

Radar Sensor

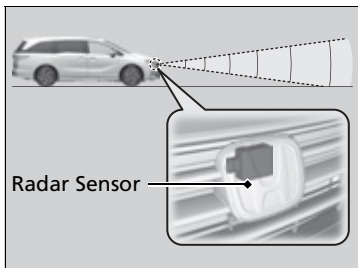

The radar sensor is in the front grille.

▣ Radar Sensor

Avoid strong impacts to the radar sensor cover.

For the CMBS™ to work properly:

- Always keep the radar sensor cover clean.
- Never use chemical solvents or polishing powder for cleaning the sensor cover. Clean it with water or a mild detergent.
- Do not put a sticker on the radar sensor cover or replace the radar sensor cover.

If you need the radar sensor to be repaired, or removed, or the radar sensor cover is strongly impacted, turn off the system by using the CMBS™ OFF button and take your vehicle to a dealer.

▣ **CMBS™ On and Off** P. 593

If the vehicle is involved in any of the following situations, the radar sensor may not work properly. Have your vehicle checked by a dealer:

- Your vehicle is involved in a frontal collision.
- Your vehicle drives through deep water or is submerged in deep water.
- Your vehicle strongly strikes a bump, curb, chock, or embankment that could jar the radar sensor.

Brake System

■ Parking Brake

Use the parking brake to keep the vehicle stationary when parked. When the parking brake is applied, you can manually or automatically release it.

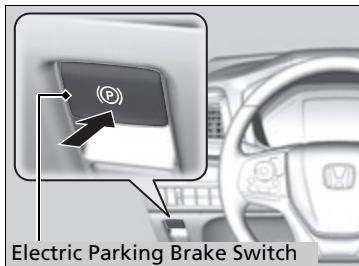

■ To apply

The electric parking brake can be applied any time the vehicle has battery, no matter which position the power mode is in. Press the electric parking brake switch gently and securely.

- ▶ The parking brake and brake system indicator (red) comes on.

⌘ Brake System

When you depress the brake pedal, you may hear a whirling sound from the engine compartment. This is because the brake system is in operation, and it is normal.

⌘ Parking Brake

You may hear the electric parking brake system motor operating from the rear wheel area when you apply or release the parking brake. This is normal.

The brake pedal may slightly move due to the electric parking brake system operation when you apply or release the parking brake. This is normal.

You cannot apply or release the parking brake if the battery goes dead.

➤ **If the Battery Is Dead** P. 735

If you press and hold the electric parking brake switch while driving, the brakes on all four wheels are applied by the VSA® system until the vehicle comes to a stop. The electric parking brake then applies, and the switch should be released.

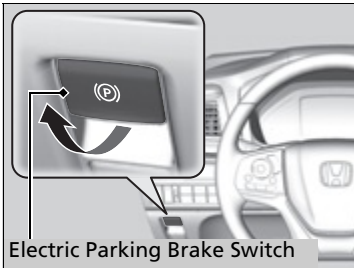

■ To release

The power mode must be in ON in order to release the electric parking brake.

1. Depress the brake pedal fully.
2. Pull the electric parking brake switch up gently and securely.
 - ▶ The parking brake and brake system indicator (red) goes off.

Manually releasing the parking brake using the switch helps your vehicle start slowly and smoothly when facing down hill on steep hills.

▣ Parking Brake

In the following situations, the parking brake automatically operates.

- When the vehicle stops more than 10 minutes while ACC with Low Speed Follow is activated.
- When the driver's seat belt is unfastened while your vehicle is stopped automatically by ACC with Low Speed Follow.
- When the engine is turned off, except by Auto Idle Stop system, while ACC with Low Speed Follow is activated.
- When the vehicle stops with the automatic brake hold system activated for more than 10 minutes.
- When the driver's seat belt is unfastened while your vehicle is stopped and brake hold is applied.
- When the engine is turned off, except by Auto Idle Stop system, while brake hold system is applied.
- When there is a problem with the brake hold system while brake hold is applied.

■ To release automatically

Depressing the accelerator pedal releases the parking brake. Use the accelerator pedal to release the brake when you are starting the vehicle facing uphill, or in a traffic jam.

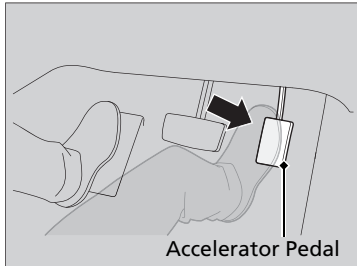

Gently depress the accelerator pedal. When on a hill, it may require more accelerator input to release.

- The parking brake and brake system indicator (red) goes off.

You can release the parking brake automatically when:

- You are wearing the driver's seat belt.
- The engine is running.
- The transmission is not in **P** or **N**.

⊠ Parking Brake

If the parking brake cannot be released automatically, release it manually.

When the vehicle is traveling uphill, the accelerator pedal may need to be pressed farther to automatically release the electric parking brake.

The parking brake cannot be released automatically while the following indicators are on:

- Malfunction indicator lamp
- Transmission system indicator

The parking brake may not be released automatically while the following indicators are on:

- Parking brake and brake system indicator (amber)
- VSA® system indicator
- **ABS** indicator
- Supplemental restraint system indicator

Foot Brake

Your vehicle is equipped with disc brakes at all four wheels. The brake assist system increases the stopping force when you depress the brake pedal hard in an emergency situation. The anti-lock brake system (ABS) helps you retain steering control when braking very hard.

➤ **Brake Assist System** P. 645

➤ **Anti-lock Brake System (ABS)** P. 644

Foot Brake

Check the brakes after driving through deep water, or if there is a buildup of road surface water. If necessary, dry the brakes by lightly depressing the pedal several times.

If you hear a continuous metallic friction sound when applying the brakes, this is caused by the brake wear indicator rubbing on the brake rotor and indicates that the brake pads need to be replaced. Have the vehicle checked by a dealer. If you hear only an occasional squeak or squeal when you initially apply the brake pedal, this may be normal and caused by high frequency vibration of the brake pads against the rotating brake disc.

Constantly using the brake pedal while going down a long hill builds up heat, which reduces the brake effectiveness. Apply engine braking by taking your foot off the accelerator pedal and downshifting to a lower gear.

Do not rest your foot on the brake pedal while driving, as it will lightly apply the brakes and cause them to lose effectiveness over time and reduce pad life. It will also confuse drivers behind you.

Whenever the brakes are activated by CMBST[™] or another system that automatically controls braking, the brake pedal is depressed and released in accordance with braking function.

Continued

■ Automatic Brake Hold

Keeps the brake applied after releasing the brake pedal until the accelerator pedal is pressed. You can use this system while the vehicle is temporarily stopped, like at traffic lights and in heavy traffic.

⚠ Automatic Brake Hold

⚠ WARNING

Activating the automatic brake hold system on steep hills or slippery roads may still allow the vehicle to move if you remove your foot from the brake pedal.

If a vehicle unexpectedly moves, it may cause a crash resulting in serious injury or death.

Never activate the automatic brake hold system or rely on it to keep a vehicle from moving when stopped on a steep hill or slippery roads.

⚠ WARNING

Using the automatic brake hold system to park the vehicle may result in the vehicle unexpectedly moving.

If a vehicle moves unexpectedly, it may cause a crash, resulting in serious injury or death.

Never leave the vehicle when braking is temporarily kept by automatic brake hold and always park the vehicle by putting the transmission in **P** and applying the parking brake.

■ Turning on the system



Automatic Brake Hold Button

■ Activating the system

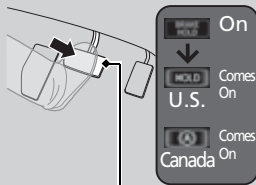

Brake Pedal

■ Canceling the system

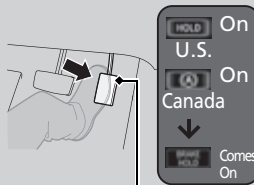

Accelerator Pedal

Fasten your seat belt properly, then start the engine. Press the automatic brake hold button.

- The automatic brake hold system indicator comes on. The system is turned on.

Depress the brake pedal to come to a complete stop. The transmission must be in **D** or **N**.

- The automatic brake hold indicator comes on. Braking is kept for up to 10 minutes.
- Release the brake pedal after the automatic brake hold indicator comes on.

Depress the accelerator pedal while the transmission is in **D**. The system is canceled and the vehicle starts to move.

- The automatic brake hold system indicator comes on. The system continues to be on.

■ **The system automatically cancels when:**

- You engage the parking brake.
- You depress the brake pedal and put the transmission into **P** or **R**.

■ **The system automatically cancels and the parking brake is applied when:**

- Braking is kept for more than 10 minutes.
- The driver's seat belt is unfastened.
- The engine is turned off.
- **Brake Hold System Problem** appears on the driver information interface.
- There is a problem with automatic brake hold system.

■ **Turning off the automatic brake hold system**

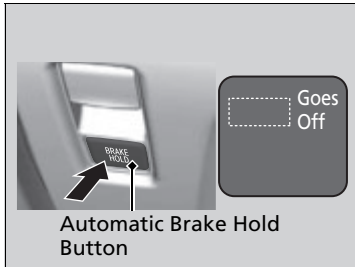

While the system is on, press the automatic brake hold button again.

- The automatic brake hold system indicator goes off.

If you want to turn off automatic brake hold while the system is in operation, press the automatic brake hold button with the brake pedal depressed.

⊠ Automatic Brake Hold

While the system is activated, you can turn off the engine or park the vehicle through the same procedure as you normally do.

⊠ **When Stopped** P. 646

Whether the system is on, or the system is activated, the automatic brake hold turns off once the engine is off.

⊠ Turning off the automatic brake hold system

Make sure to turn off the automatic brake hold system before using an automated car wash.

You may hear an operating noise if the vehicle moves while the automatic brake hold system is in operation.

Anti-lock Brake System (ABS)

■ ABS

Helps prevent the wheels from locking up, and helps you retain steering control by pumping the brakes rapidly, much faster than you can.

The electronic brake distribution (EBD) system, which is part of the ABS, also balances the front-to-rear braking distribution according to vehicle loading.

You should never pump the brake pedal. Let the ABS work for you by always keeping firm, steady pressure on the brake pedal. This is sometimes referred to as “stomp and steer.”

■ ABS operation

The brake pedal may pulsate slightly when the ABS is working. Depress the brake pedal and keep holding the pedal firmly down. On dry pavement, you will need to press on the brake pedal very hard before the ABS activates. However, you may feel the ABS activate immediately if you are trying to stop on snow or ice.

ABS may activate when you depress the brake pedal when driving on:

- Wet or snow covered roads.
- Roads paved with stone.
- Roads with uneven surfaces, such as potholes, cracks, manholes, etc.

When the vehicle speed goes under 6 mph (10 km/h), the ABS stops.

ⓘ Anti-lock Brake System (ABS)

NOTICE

The ABS may not function correctly if you use a tire of the wrong size or type.

If the **ABS** indicator comes on while driving, there may be a problem with the system. While normal braking will not be affected, there is a possibility that the ABS will not operating. Have your vehicle checked by a dealer immediately.

The ABS is not designed for the purpose of reducing the time or distance it takes for a vehicle to stop: It is designed to limit brake lockup which can lead to skidding and loss of steering control.

In the following cases, your vehicle may need more distance to stop than a vehicle without the ABS:

- You are driving on rough or uneven road surfaces, such as gravel or snow.
- The tires are equipped with snow chains.

The following may be observed with the ABS system:

- Motor sounds coming from the engine compartment when the brakes are applied, or when system checks are being performed after the engine has been started and while the vehicle accelerates.
- Brake pedal and/or the vehicle body vibration when ABS activates.

These vibrations and sounds are normal to ABS systems and are no cause for concern.

Brake Assist System

Designed to assist the driver by generating greater braking force when you depress the brake pedal hard during emergency braking.

■ Brake assist system operation

Press the brake pedal firmly for more powerful braking.

When brake assist operates, the pedal may wiggle slightly and an operating noise may be heard. This is normal. Keep holding the brake pedal firmly down.

When Stopped

1. Depress the brake pedal firmly.
2. With the brake pedal depressed, press the electric parking brake switch slowly, but fully.
3. Change the gear position to **P**.
4. Turn off the engine.
 - ▶ The parking brake and brake system indicator (red) goes off in about 15 seconds.

▣ Parking Your Vehicle

Do not park your vehicle near flammable objects, such as dry grass, oil, or timber. Heat from the exhaust can cause a fire.

▣ When Stopped

NOTICE

The following can damage the transmission:

- Depressing the accelerator and brake pedals simultaneously.
- Holding the vehicle in place when facing uphill by depressing the accelerator pedal.
- Changing into **P** before the vehicle stops completely.

In extremely cold temperatures, the parking brake may freeze up if applied. If such temperatures are expected, do not apply the parking brake but, if parking on a slope, either turn the front wheels so they will contact the curb if the vehicle rolls down the slope or block the wheels to keep the vehicle from moving. If you do not take either precaution, the vehicle may roll unexpectedly, leading to a crash.

Always set the parking brake, in particular if you are parked on an incline.

▶▶ When Stopped

⚠ WARNING

The vehicle can roll away if left unattended without confirming that Park is engaged.

A vehicle that rolls away could cause a crash resulting in serious injury or death.

Always keep your foot on the brake pedal until you have confirmed that **P** is shown on the gear position Indicator.

Parking Sensor System *

The corner and center sensors monitor obstacles around your vehicle, and the beeper and the driver information interface or audio/information screen let you know the approximate distance between your vehicle and the obstacle.

■ The sensor location and range

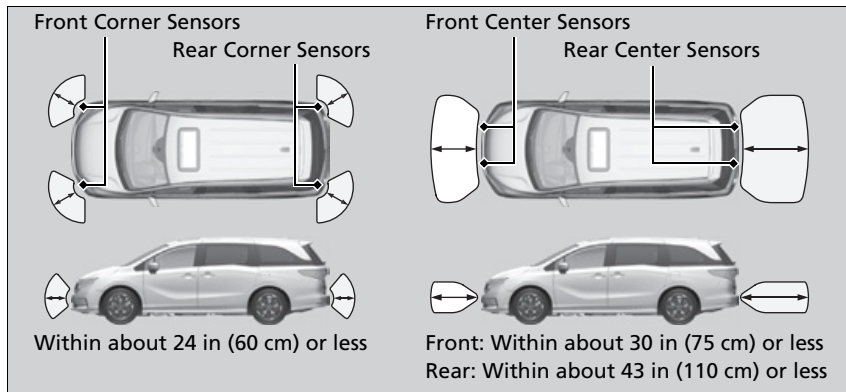

▣ Parking Sensor System *

Even when the system is on, always confirm if there is no obstacle near your vehicle before parking.

The system may not work properly when:

- The sensors are covered with snow, ice, mud or dirt, etc.
- The vehicle is on uneven surface, such as grass, bumpy road, or a hill.
- The vehicle has been out in hot or cold weather.
- The system is affected by devices that emit ultrasonic waves.
- Driving in bad weather.

The system may not sense:

- Thin or low objects.
- Sonic-absorptive materials, such as snow, cotton, or sponge.
- Objects directly under the bumper.

Do not put any accessories on or around the sensors.

■ Parking sensor system on and off

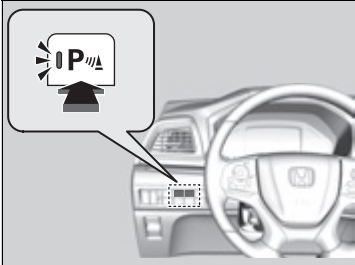

With the power mode in ON, press the parking sensor system button to turn on or off the system. The indicator in the button comes on when the system is on.

The front corner, rear corner and rear center sensors start to detect an obstacle when the transmission is in **[R]**, and the vehicle speed is less than 5 mph (8 km/h).

The front corner and front center sensors start to detect an obstacle when the transmission is not in **[P]**, and the vehicle speed is less than 5 mph (8 km/h).

☒ Parking sensor system on and off

When you set the power mode to ON, the system will be in the previously selected condition.

■ Screen Operation

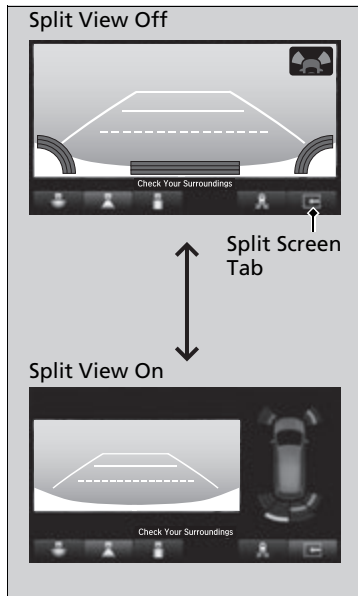

You can switch between split view off and split view on by touching the split screen tab.

☒ Screen Operation

The split screen tab disappears, and the split view returns to the last camera view mode under the following conditions:

- If the parking sensor system is turned off.
- If there is a malfunction in the system.

■ When the distance between your vehicle and obstacles behind becomes shorter

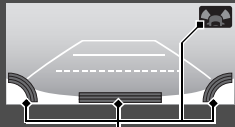
Length of the intermittent beep	Distance between the Bumper and Obstacle		Indicator	Audio/information screen/ Driver Information Interface
	Corner Sensors	Center Sensors		
Moderate	—	Rear only: About 43-30 in (110-75 cm)	Blinks in Yellow* ¹	<div data-bbox="1161 314 1422 337" data-label="Caption"> <p>Audio/information screen</p> </div>  <p>Indicators light up where the sensor detects an obstacle</p>
Short	—	About 30-24 in (75-60 cm)		
Very short	About 24-14 in (60-35 cm)	About 24-14 in (60-35 cm)	Blinks in Amber	
Continuous	About 14 in (35 cm) or less	About 14 in (35 cm) or less	Blinks in Red	

*1: At this stage, only the center sensors detect obstacles.

■ Turning off All Rear Sensors

1. Make sure that the parking sensor system is not activated. Set the power mode to VEHICLE OFF.
2. Press and hold the parking sensor system button, and set the power mode to ON.
3. Keep pressing the button for 10 seconds. Release the button when the indicator in the button blinks.
 - ▶ The beeper sounds once.
4. Press the button again. The indicator in the button goes off.
 - ▶ The beeper sounds twice. The rear sensors are now turned off.

To turn the rear sensors on again, follow the above procedure. The beeper sounds three times when the rear sensors come back on.

⌘ Turning off All Rear Sensors

When you set the gear position to **[R]**, the indicator in the parking sensor system button blinks as a reminder that the rear sensors have been turned off.

Cross Traffic Monitor*

Monitors the rear corner areas using the radar sensors when reversing, and alerts you if a vehicle approaching from a rear corner is detected.

The system is convenient when you are backing out of a parking space.

ⓘ Cross Traffic Monitor*

CAUTION

Cross Traffic Monitor cannot detect all approaching vehicles and may not detect an approaching vehicle at all.

Failure to visually confirm that it is safe to back up the vehicle before doing so may result in a collision.

Do not solely rely on the system when reversing; always also use your mirrors, and look behind and to the sides of your vehicle before reversing.

* Not available on all models

■ How the System Works

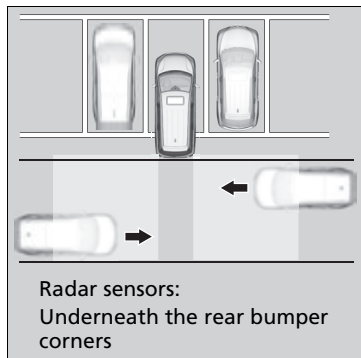

The system activates when:

- The power mode is in ON.
- The Cross Traffic Monitor system is turned on.
- **☑ Cross Traffic Monitor On and Off P. 656**
- The transmission is in **R**.
- Your vehicle is moving at 3 mph (5 km/h) or lower.

When a vehicle is detected approaching from a rear corner, Cross Traffic Monitor alerts you with a buzzer and a displayed warning.

The system will not detect a vehicle that approaches from directly behind your vehicle, nor will it provide alerts about a detected vehicle when it moves directly behind your vehicle.

The system does not provide alerts for a vehicle that is moving away from your vehicle, and it may alert for pedestrians, bicycles, or stationary objects.

☒ Cross Traffic Monitor*

Cross Traffic Monitor may not detect or may delay alerting an approaching vehicle, or may alert without an approaching vehicle under the following conditions:

- An obstacle, such as another vehicle and a wall, near your vehicle's rear bumper, is blocking the radar sensor's scope.
- Your vehicle is moving at the speed of about 3 mph (5 km/h) or higher.
- A vehicle is approaching at the speed other than between about 6 and 16 mph (10 and 25 km/h).
- The system picks up external interference such as other radar sensors from another vehicle or strong radio wave transmitted from a facility nearby.
- Either corner of the rear bumper is covered with snow, ice, mud or dirt.
- When there is bad weather.
- Your vehicle is on an incline.
- Your vehicle is tilted due to a heavy load in the rear.
- Your vehicle is reversing towards a wall, a pole, a vehicle, and so on.
- The rear bumper or the sensors have been improperly repaired or the rear bumper has been deformed. Have your vehicle checked by a dealer.

For proper operation, always keep the rear bumper corner area clean.

Do not cover the rear bumper corner area with labels or stickers of any kind.

■ When the System Detects a Vehicle

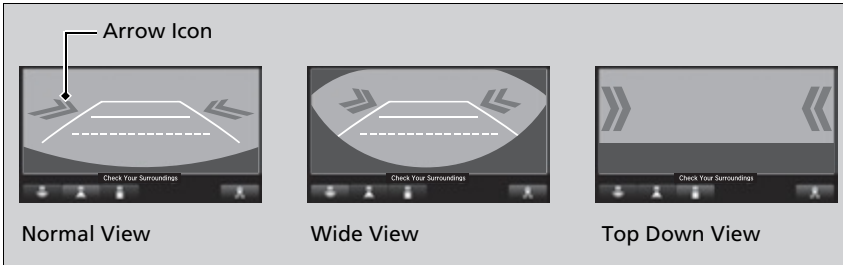



An arrow icon appears on the side a vehicle is approaching on the audio/information screen.

▣ Cross Traffic Monitor*

The parking sensor system's alerting buzzer overrides the Cross Traffic Monitor buzzer when the parking sensors are detecting obstacles at the closest range.

▣ When the System Detects a Vehicle

If the  on the lower right changes to  in amber when the transmission is in **[R]**, mud snow or ice may have accumulated in the vicinity of the sensor. The system is temporarily canceled. Check the bumper corners for any obstructions, and thoroughly clean the area if necessary.

If the  comes on when the transmission is in **[R]**, there may be a problem with the Cross Traffic Monitor system. Do not use the system and have your vehicle checked by a dealer.

If the display remains the same with the gear position is in **[R]**, there may be a problem with the rear camera system and the Cross Traffic Monitor system. Do not use the system and have your vehicle checked by a dealer.

* Not available on all models

■ Cross Traffic Monitor On and Off

You can switch on and off the system using the audio/information screen.

1. Select .
2. Select **Settings**.
3. Select **Camera**.
4. Select **Rear Camera**.
5. Select **Cross Traffic Monitor**.
6. Select **ON** or **OFF**.

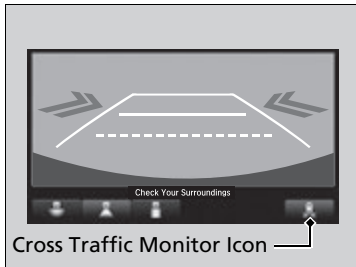

The system can also be turned on and off on the audio/information screen by pressing the Cross Traffic Monitor icon.

About Your Multi-View Rear Camera

The audio/information screen can display your vehicle's rear view. The display automatically changes to the rear view when the transmission is put into **R**.

Multi-View Rear Camera Display Area

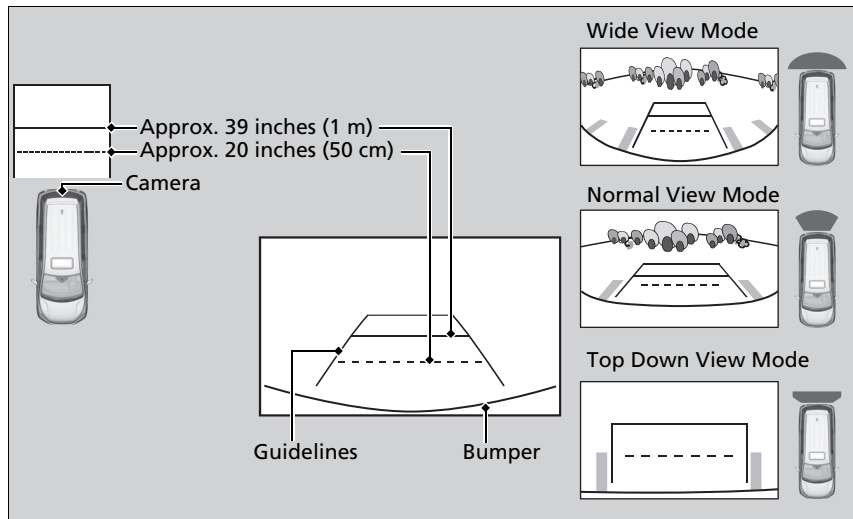

About Your Multi-View Rear Camera

The rear camera view is restricted. You cannot see the corner ends of the bumper or what is underneath the bumper. Its unique lens also makes objects appear closer or farther than they actually are.

Visually confirm that it is safe to drive before backing up. Certain conditions (such as weather, lighting, and high temperatures) may also restrict the rear view. Do not rely on the rearview display which does not give you all information about conditions at the back of your vehicle.

If the camera lens is covered with dirt or moisture, use a soft, moist cloth to keep the lens clean and free of debris.

Models with color audio system

You can change the **Camera Guideline On** or **Off** settings.

➤ **Customized Features** P. 457

Models with Display Audio

You can change the **Fixed**, **Dynamic**, **Both** and **Off** settings.

➤ **Customized Features** P. 463

Fixed: Guidelines appear when you put the transmission into **R**.

Dynamic: Guidelines move according to the steering wheel direction.

Both: Guidelines appear when you put the transmission into **R** and Guidelines move according to the steering wheel direction.

Off: Guidelines do not appear.

Continued

You can view three different camera modes on the rearview display.

Models with color audio system

Press the selector knob to switch the mode.

Models with Display Audio

Select the appropriate icon to switch the mode.

 : Wide view mode

 : Normal view mode

 : Top down view mode

- If the last used viewing mode was Wide view mode or Normal view mode, the same view mode will be activated the next time you put the transmission into **R**.
- If Top down view mode was last used before you set the power mode to OFF, Wide View mode is selected next time you set the power mode to ON and put the transmission into **R**.
- If Top down view mode was last used more than 10 seconds after you put the transmission out of **R**, Wide View mode is selected the next time you put the transmission into **R**.

▶▶ About Your Multi-View Rear Camera

Models with Display Audio

You can change the **Last Used, Normal View** and **Wide View** settings.

➔ **Customized Features** P. 463

Fuel Information

■ Fuel recommendation

Unleaded gasoline, pump octane number 87 or higher

Use of a lower octane gasoline can cause a persistent, heavy metallic knocking noise that can lead to engine damage.

■ Top tier detergent gasoline

Because the level of detergency and additives in gasoline vary in the market, Honda endorses the use of “TOP TIER Detergent Gasoline” where available to help maintain the performance and reliability of your vehicle. TOP TIER Detergent Gasoline meets a new gasoline standard jointly established by leading automotive manufacturers to meet the needs of today’s advanced engines.

Qualifying gasoline retailers will, in most cases, identify their gasoline as having met “TOP TIER Detergent Gasoline” standards at the retail location. This fuel is guaranteed to contain the proper level of detergent additives and be free of metallic additives. The proper level of detergent additives, and absence of harmful metallic additives in gasoline, help avoid build-up of deposits in your engine and emission control system.

For further important fuel-related information for your vehicle, or on information on gasoline that does not contain MMT, visit www.hondacars.com. In Canada, visit www.honda.ca for additional information on gasoline. For more information on top tier gasoline, visit www.toptiergas.com.

■ Fuel tank capacity: 19.5 US gal (73.8 L)

⌘ Fuel Information

NOTICE

We recommend quality gasoline containing detergent additives that help prevent fuel system and engine deposits. In addition, in order to maintain good performance, fuel economy, and emissions control, we strongly recommend the use of gasoline that does NOT contain harmful manganese-based fuel additives such as MMT, if such gasoline is available.

Use of gasoline with these additives may adversely affect performance, and cause the malfunction indicator lamp on your instrument panel to come on. If this happens, contact a dealer for service. Some gasoline today is blended with oxygenates such as ethanol. Your vehicle is designed to operate on oxygenated gasoline containing up to 15% ethanol by volume. Do not use gasoline containing methanol. If you notice any undesirable operating symptoms, try another service station or switch to another brand of gasoline.

How to Refuel

Your fuel tank is not equipped with a fuel filler cap. You can insert the filler nozzle directly into the filler neck. The tank seals itself again when you pull out the filler nozzle.



1. Stop your vehicle with the service station pump on the left side of the vehicle in the rear.
 2. Turn off the engine.
 3. Unlock the driver's door using the master door lock switch.
 - ▶ The fuel fill door on the outer side of the vehicle will unlock.
- 🔓 **Locking/Unlocking the Doors from the Inside** P. 166
4. Press firmly and then release the area indicated by the arrow to release the fuel filler door.

🔧 How to Refuel

⚠️ WARNING

Gasoline is highly flammable and explosive. You can be burned or seriously injured when handling fuel.

- Stop the engine, and keep heat, sparks, and flame away.
- Handle fuel only outdoors.
- Wipe up spills immediately.

The fuel filler opening is designed to accept only service station filler nozzles for refueling. Use of smaller diameter tubes (e.g., those used to siphon fuel for other uses) or other non-service station devices can damage the area in and around the filler opening.

If the filler nozzle keeps turning off when the tank is not full, there may be a problem with the pump's fuel vapor recovery system. Try filling at another pump. If this does not fix the problem, consult a dealer.

The filler nozzle automatically stops to leave space in the fuel tank so that fuel does not overflow as a result of changes in air temperature.

Do not continue to add fuel after the filler nozzle has automatically stopped. Additional fuel can exceed the full tank capacity.

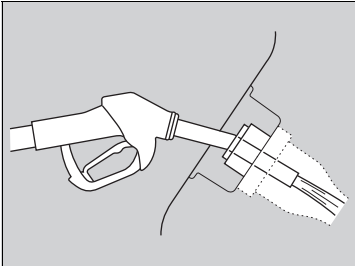

5. Place the end of the filler nozzle on the lower part of filler opening, then insert it slowly and fully.
 - ▶ Make sure that the end of the filler nozzle goes down along with the filler pipe.
 - ▶ Keep the filler nozzle level.
 - ▶ When the tank is full, the filler nozzle will click off automatically.
 - ▶ If you do not fill up the tank to full, always add a minimum of **3.5 US gal (13.3 L)** of fuel.
 - ▶ After filling, wait about five seconds before removing the filler nozzle.
6. Shut the fuel fill door by hand.

How to Refuel

Use the lock tab or the master door lock switch to unlock the fuel fill door.

The vehicle doors and fuel fill door automatically relock if the remote unlock function is used. This can be deactivated by briefly opening then closing the driver's door.

If you repeatedly fill the tank with less than the specified minimum amount of fuel, the malfunction indicator lamp may come on. If this happens, have your vehicle checked by a dealer.

If you have to refuel your vehicle from a portable container, use the funnel provided with your vehicle.

▶ **Refueling From a Portable Fuel Container**
P. 757

Improving Fuel Economy and Reducing CO₂ Emissions

Achieving fuel economy and reducing CO₂ emissions is dependent on several factors, including driving conditions, load weight, idling time, driving habits, and vehicle condition. Depending on these and other factors, you may not achieve the rated fuel economy of this vehicle.

Maintenance and Fuel Economy

You can optimize your fuel economy with proper maintenance of your vehicle. Always maintain your vehicle in accordance with the messages displayed on the driver information interface.

- Use engine oil with the viscosity recommended.
 - ▣ **Recommended Engine Oil** P. 676
- Maintain the specified tire pressure.
- Do not load the vehicle with excess cargo.
- Keep your vehicle clean. A buildup of snow or mud on your vehicle's underside adds weight and increases wind resistance.

Improving Fuel Economy and Reducing CO₂ Emissions

Direct calculation is the recommended method to determine actual fuel consumed while driving.

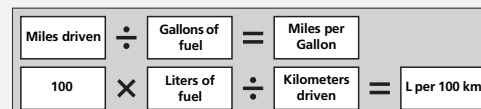

In Canada, posted fuel economy numbers are established following a simulated test. For more information on how this test is performed, please visit <https://www.nrcan.gc.ca> and search for "fuel consumption testing" in the search field at the top of the page.

Maintenance

This chapter discusses basic maintenance.



Before Performing Maintenance

Inspection and Maintenance	664
Safety When Performing Maintenance	665
Parts and Fluids Used in Maintenance	
Service	666

Maintenance Minder™

667

Maintenance Under the Hood

Maintenance Items Under the Hood	673
Opening the Hood	674
Recommended Engine Oil	676
Oil Check	677
Adding Engine Oil	678

Changing the Engine Oil and Oil Filter.....	679
Engine Coolant	681
Transmission Fluid	683
Brake Fluid	684
Refilling Window Washer Fluid.....	685
Replacing Light Bulbs	686
Checking and Maintaining Wiper Blades.....	693
Checking and Maintaining Tires	
Checking Tires	697
Tire and Loading Information Label	698
Tire Labeling	698
DOT Tire Quality Grading (U.S. Vehicles).....	700
Wear Indicators.....	702

Tire Service Life	702
Tire and Wheel Replacement	703
Tire Rotation	704
Winter Tires	705
Battery	706
Remote Transmitter Care	708
Remote Control and Wireless	
Headphone Care*	709
Climate Control System Maintenance	711
Cleaning	
Interior Care	712
Exterior Care.....	715
Accessories and Modifications	718

* Not available on all models

Inspection and Maintenance

For your safety, perform all listed inspections and maintenance to keep your vehicle in good condition. If you become aware of any abnormality (noise, smell, insufficient brake fluid, oil residue on the ground, etc.), have your vehicle inspected by a dealer. (Note, however, that service at a dealer is not mandatory to keep your warranties in effect.)

Types of Inspection and Maintenance

■ Routine inspections

Perform inspections before long distance trips, when washing the vehicle, or when refueling.

➤ **Maintenance** P. 30

■ Periodic inspections

- Check the brake fluid level monthly.
 - **Brake Fluid** P. 684
- Check the tire pressure monthly. Examine the tread for wear and foreign objects.
 - **Checking and Maintaining Tires** P. 697
- Check the operation of the exterior lights monthly.
 - **Replacing Light Bulbs** P. 686
- Check the condition of the wiper blades at least every six months.
 - **Checking and Maintaining Wiper Blades** P. 693

Inspection and Maintenance

U.S. models

Maintenance, replacement, or repair of emissions control devices and systems may be done by any automotive repair establishment or individuals using parts that are “certified” to EPA standards.

According to state and federal regulations, failure to perform maintenance on the maintenance main items marked with # will not void your emissions warranties. However, all maintenance services should be performed in accordance with the intervals indicated by the driver information interface.

➤ **Maintenance Service Items** P. 670

If you want to perform complex maintenance tasks that require more skills and tools, you can purchase a subscription to the Service Express website at www.techinfo.honda.com.

➤ **Authorized Manuals** P. 770

If you want to perform maintenance yourself, make sure that you have the necessary tools and skills first. After performing maintenance, update the records in the separate maintenance booklet.

Safety When Performing Maintenance

Some of the most important safety precautions are given here. However, we cannot warn you of every conceivable hazard that can arise in performing maintenance. Only you can decide whether you should perform a given task.

Maintenance Safety

- To reduce the possibility of fire or explosion, keep cigarettes, sparks, and flames away from the battery and all fuel related parts.
- Never leave rags, towels, or other flammable objects under the hood.
 - ▶ Heat from the engine and exhaust can ignite them, causing a fire.
- To clean parts, use a commercially available degreaser or parts cleaner, not gasoline.
- Wear eye protection and protective clothing when working with the battery or compressed air.
- Engine exhaust contains carbon monoxide, which is poisonous and can kill you.
 - ▶ Only operate the engine if there is sufficient ventilation.

Vehicle Safety

- The vehicle must be in a stationary condition.
 - ▶ Make sure your vehicle is parked on level ground, the parking brake is set, and the engine is off.
- Be aware that hot parts can burn you.
 - ▶ Make sure to let the engine and exhaust system cool thoroughly before touching vehicle parts.
- Be aware that moving parts can injure you.
 - ▶ Do not start the engine unless instructed, and keep your hands and limbs away from moving parts.
 - ▶ Do not open the hood while the Auto Idle Stop function is activated.

⚠ Safety When Performing Maintenance

⚠ WARNING

Improperly maintaining this vehicle or failing to correct a problem before driving can cause a crash in which you can be seriously hurt or killed.

Always follow the inspection and maintenance recommendations according to the schedules in this owner's manual.

⚠ WARNING

Failure to properly follow maintenance instructions and precautions can cause you to be seriously hurt or killed.

Always follow the procedures and precautions in this owner's manual.

Parts and Fluids Used in Maintenance Service

The use of Honda genuine parts and fluids is recommended when maintaining and servicing your vehicle. Honda genuine parts are manufactured according to the same high quality standards used in Honda vehicles.

▣ Parts and Fluids Used in Maintenance Service

NOTICE

Do not press the engine cover forcibly. This may damage the engine cover and component parts.

If the engine oil life is less than 15%, you will see the Maintenance Minder messages appear on the driver information interface every time you set the power mode to ON. The messages notify you when to change the engine oil, or when to bring your vehicle to a dealer for indicated maintenance services.

To Use Maintenance Minder™

■ Displaying the Maintenance Minder Information

Maintenance items, which should be serviced at the same time that you replace the engine oil, appear on the driver information interface.

You can view them on the engine oil life screen at any time.

1. Set the power mode to ON.
2. Press the **ENTER** button repeatedly until home screen appears.
3. Select **Maintenance** by pressing the **▲/▼** button repeatedly and press **ENTER**.
4. Select **Oil Life** by pressing the **▲/▼** button and press **ENTER**.
5. The engine oil life appears on the screen.

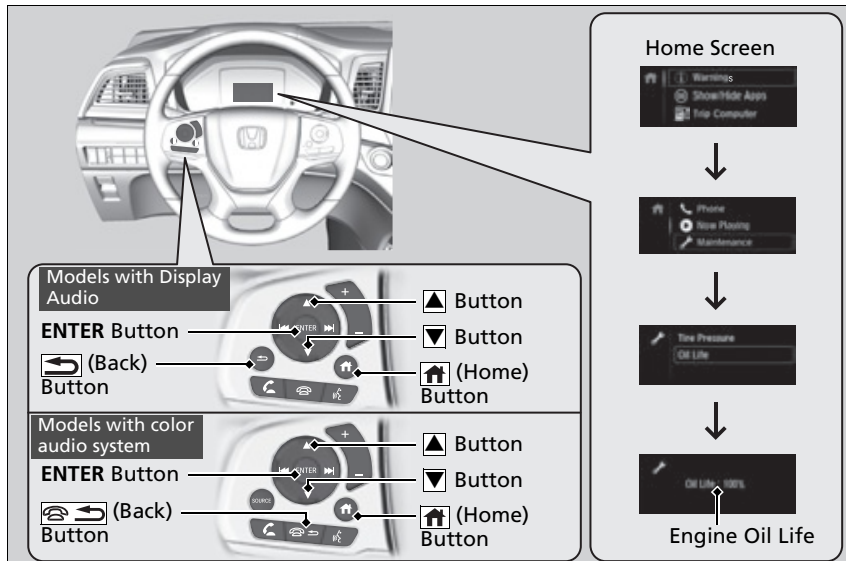

►► Displaying the Maintenance Minder Information













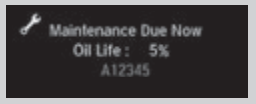

Based on the engine operating conditions, the remaining engine oil life is calculated and displayed as a percentage.

Displayed Engine Oil Life (%)	Calculated Engine Oil Life (%)
100	100 to 91
90	90 to 81
80	80 to 71
70	70 to 61
60	60 to 51
50	50 to 41
40	40 to 31
30	30 to 21
20	20 to 16
15	15 to 11
10	10 to 6
5	5 to 1
0	0

There is a list of maintenance main and sub items you can view on the driver information interface.

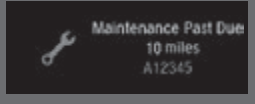
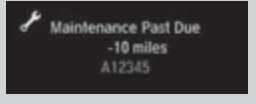
►► **Maintenance Service Items P. 670**

Maintenance Minder Messages on the Driver Information Interface

Maintenance Message	Oil Life Display	Explanation	Information
<p>Maintenance Due Soon</p> 	<p>15%</p> 	<p>The remaining engine oil life is 15 to 6 percent. Once you switch the display by pressing the  ^{*1/} ^{*2,} or  button, this message will go off.</p>	<p>The engine oil is approaching the end of its service life, and the maintenance items should be inspected and serviced soon.</p>
<p>Maintenance Due Now</p> 	<p>5%</p> 	<p>The remaining engine oil life is 5 to 1 percent. Press the  ^{*1/} ^{*2,} or  button to switch to another display.</p>	<p>The engine oil has almost reached the end of its service life, and the maintenance items should be inspected and serviced as soon as possible.</p>
<p>Maintenance Past Due</p> 	<p>Negative Distance</p> 	<p>The remaining engine oil life has passed its service life, and a negative distance appears after driving over 10 miles (U.S. models) or 10 km (Canadian models). Press the  ^{*1/} ^{*2,} or  button to switch to another display.</p>	<p>The engine oil life has passed. The maintenance items must be inspected and serviced immediately.</p>

*1:Models with color audio system

*2:Models with Display Audio

The system message indicator (i) comes on along with the Maintenance Minder message.

■ Maintenance Service Items

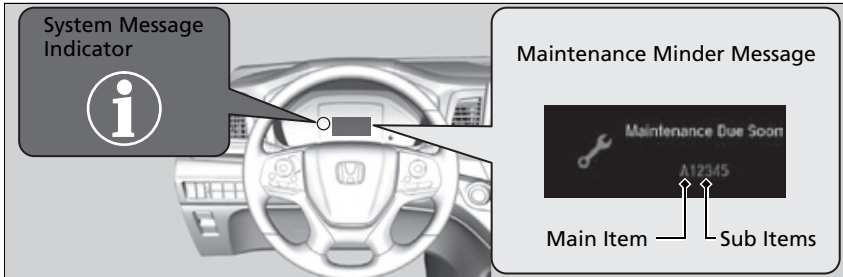

U.S. models

CODE	Maintenance Main Items
A	<ul style="list-style-type: none"> • Replace engine oil*¹
B	<ul style="list-style-type: none"> • Replace engine oil*¹ and oil filter • Inspect front and rear brakes • Inspect tie rod ends, steering gearbox, and boots • Inspect suspension components • Inspect driveshaft boots • Inspect brake hoses and lines (Including ABS/VSA®) • Inspect all fluid levels and condition of fluids • Inspect exhaust system[#] • Inspect fuel lines and connections[#]

*1: If the message **Maintenance Due Now** does not appear more than 12 months after the display is reset, change the engine oil every year.

: See information on maintenance and emissions warranty in the first column on page 767.

▣ Maintenance Service Items

- Adjust the valves during services A, B, 1, 2, or 3 if they are noisy.

CODE	Maintenance Sub Items
1	<ul style="list-style-type: none"> • Rotate tires
2	<ul style="list-style-type: none"> • Replace air cleaner element*² • Replace dust and pollen filter*³ • Inspect drive belt
3	<ul style="list-style-type: none"> • Replace transmission fluid
4	<ul style="list-style-type: none"> • Replace spark plugs • Replace timing belt and inspect water pump*⁴ • Inspect valve clearance
5	<ul style="list-style-type: none"> • Replace engine coolant
7	<ul style="list-style-type: none"> • Replace brake fluid*⁵

*2: If you drive in dusty conditions, replace the air cleaner element every 15,000 miles (24,000 km).

*3: If you drive primarily in urban areas that have high concentrations of soot in the air from industry and from diesel-powered vehicles, replace the dust and pollen filter every 15,000 miles (24,000 km).

*4: If you drive regularly in very high temperatures (over 110°F, 43°C), in very low temperatures (under -20°F, -29°C), replace every 60,000 miles (100,000 km).

*5: If a Maintenance Minder message does not appear more than 36 months after the display for item 7 is reset, change the brake fluid every 3 years.

Canadian models

⌘ Maintenance Service Items

- Adjust the valves during services A, 0, 9, 1, 2, or 3 if they are noisy.

CODE	Maintenance Main Items
A	• Replace engine oil*1
0	• Replace engine oil*1 and oil filter

*1: If the message **Maintenance Due Now** does not appear more than 12 months after the display is reset, change the engine oil every year.

*2: If you drive in dusty conditions, replace the air cleaner element every 24,000 km (15,000 miles).

*3: If you drive primarily in urban areas that have high concentrations of soot in the air from industry and from diesel-powered vehicles, replace the dust and pollen filter every 24,000 km (15,000 miles).

*4: If you drive regularly in very high temperatures (over 43°C, 110°F), in very low temperatures (under -29°C, -20°F), replace every 100,000 km (60,000 miles).

*5: If a Maintenance Minder message does not appear more than 36 months after the display for item 7 is reset, change the brake fluid every 3 years.

#: See information on maintenance and emissions warranty in the first column on page 769.

CODE	Maintenance Sub Items
1	• Rotate tires
2	• Replace air cleaner element*2 • Replace dust and pollen filter*3 • Inspect drive belt
3	• Replace transmission fluid
4	• Replace spark plugs • Replace timing belt and inspect water pump*4 • Inspect valve clearance
5	• Replace engine coolant
7	• Replace brake fluid*5
9	• Service front and rear brakes • Inspect tie rod ends, steering gearbox, and boots • Inspect suspension components • Inspect driveshaft boots • Inspect brake hoses and lines (including ABS/VSA®) • Inspect all fluid levels and condition of fluids • Inspect exhaust system# • Inspect fuel lines and connections#

■ Resetting the Display

Reset the maintenance minder information display if you have performed the maintenance service.

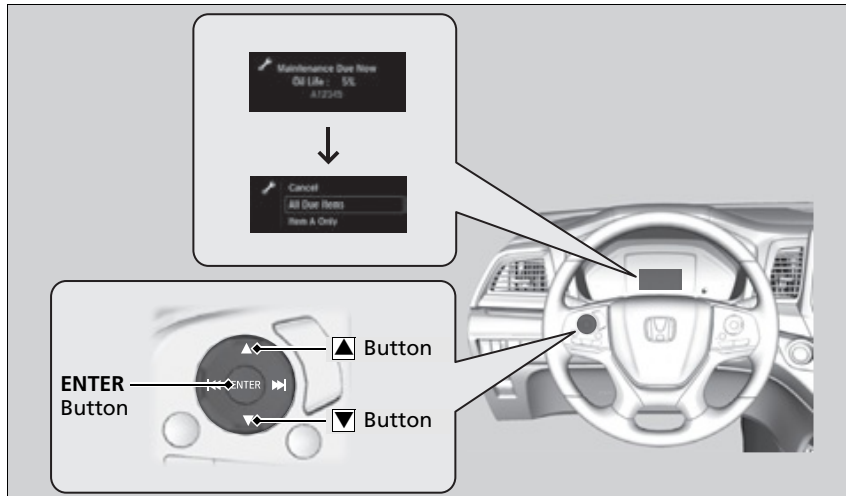

1. Set the power mode to ON.
2. Display the engine oil life.
 - ▶ **Displaying the Maintenance Minder Information** P. 668
3. Press and hold the **ENTER** button for about 10 seconds to enter the reset mode.
4. Press the ▲/▼ button to select a maintenance item to reset, or to select **All Due Items** (You can also select **Cancel** to end the process).
5. Press the **ENTER** button to reset the selected item.
6. Repeat from step 5 for other items you wish to reset.

▶▶ Resetting the Display

NOTICE

Failure to reset the Maintenance Minder™ display after a maintenance service results in the system showing incorrect maintenance intervals, which can lead to serious mechanical problems.

The dealer will reset the Maintenance Minder™ display after completing the required maintenance service. If someone other than a dealer performs maintenance service, reset the Maintenance Minder™ display yourself.

Models with Display Audio

You can also reset the Maintenance Minder™ display using the audio/information screen.

▶ **Customized Features** P. 463

Maintenance Items Under the Hood

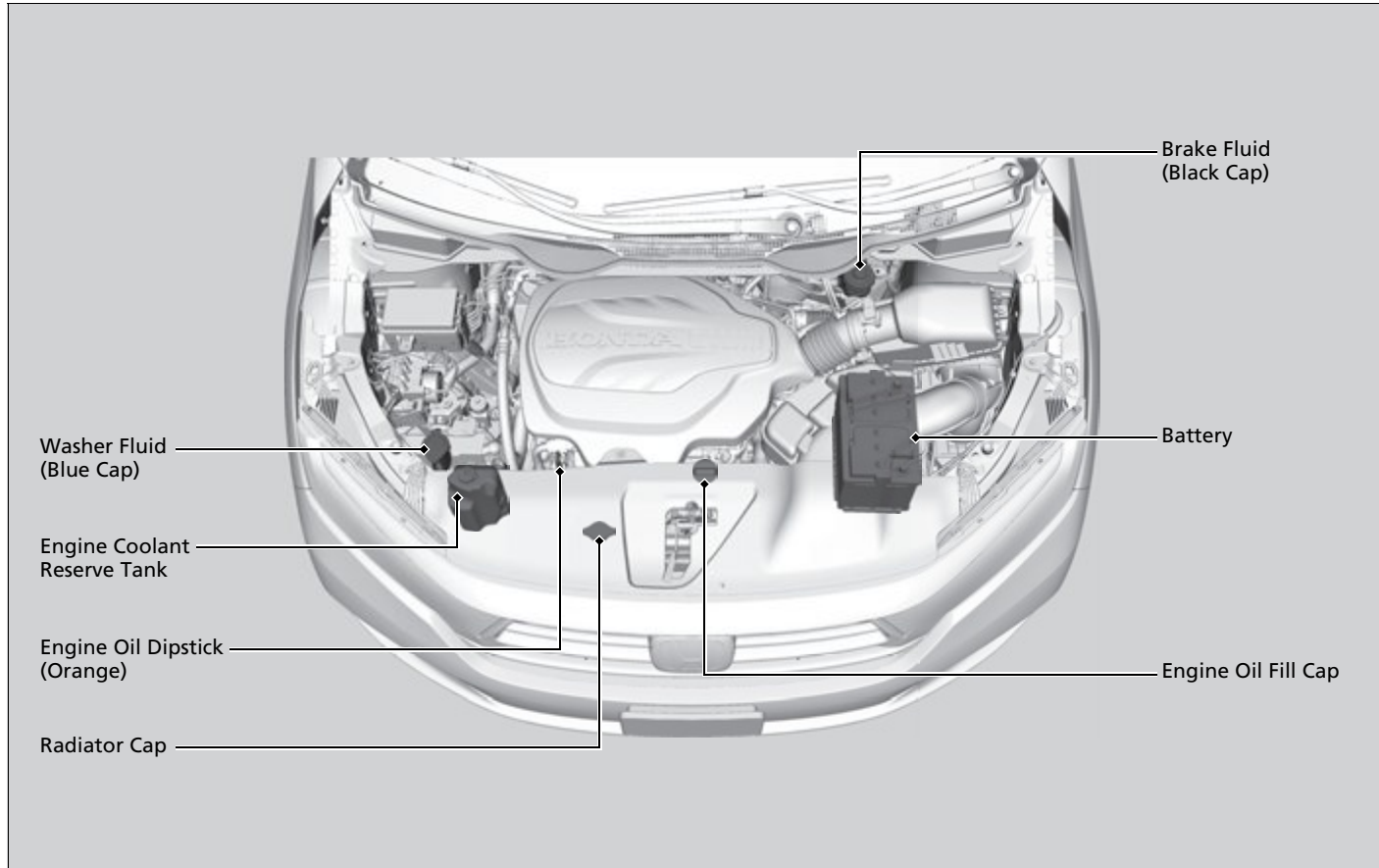

Opening the Hood

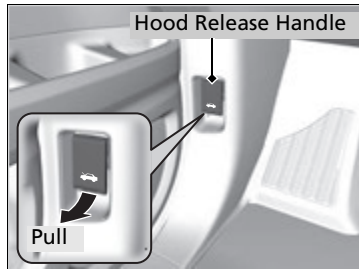

1. Park the vehicle on a level surface, and set the parking brake.
2. Pull the hood release handle under the driver's side lower corner of the dashboard.
 - ▶ The hood will pop up slightly.

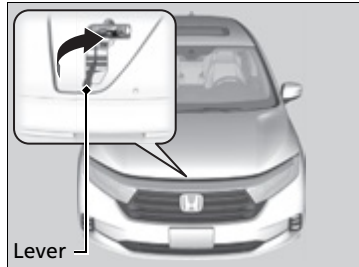

3. Pull up the hood latch lever (located under the front edge of the hood to the center) and raise the hood. Once you have raised the hood slightly, you can release the lever.

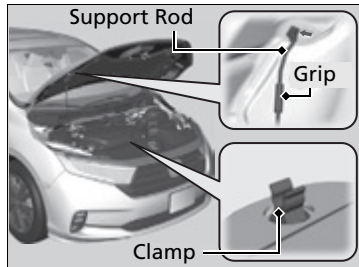

4. Remove the support rod from the clamp using the grip. Mount the support rod in the hood.

When closing, remove the support rod, and stow it in the clamp, then gently lower the hood. Remove your hand at a height of approximately 12 inches (30 cm) and let the hood close.

▶▶ Opening the Hood

NOTICE

Do not open the hood when the wiper arms are raised. The hood will strike the wipers, resulting in possible damage to the hood and/or the wipers.

NOTICE

Do not press the engine cover forcibly. This may damage the engine cover and component parts.

When closing the hood, check that the hood is securely latched.

If the hood latch lever moves stiffly, or if you can open the hood without lifting the lever, the latch mechanism should be cleaned and lubricated.

Do not open the hood while the Auto Idle Stop function is activated.

Engine Compartment Cover

The component parts in the engine compartment are protected by a cover. You may need to remove the cover when you perform certain maintenance work. Pull up on the engine compartment cover, remove it from the pins.

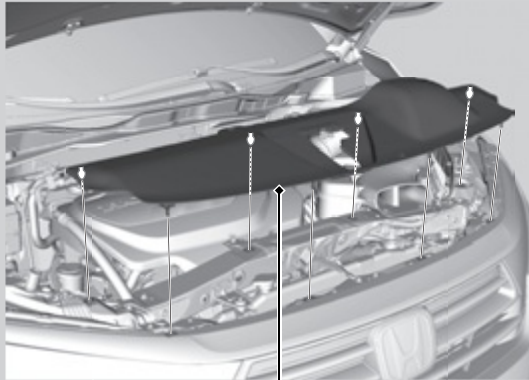

Engine Compartment Cover

Recommended Engine Oil

- **Honda Genuine Motor Oil**
- **Premium-grade 0W-20 detergent oil with an API Certification Seal on the container.**



Oil is a major contributor to your engine's performance and longevity. If you drive the vehicle with insufficient or deteriorated oil, the engine may fail or be damaged.

This seal indicates the oil is energy conserving and that it meets the American Petroleum Institute's latest requirements.

Use Honda Genuine Motor Oil or another commercial engine oil of suitable viscosity for the ambient temperature as shown.

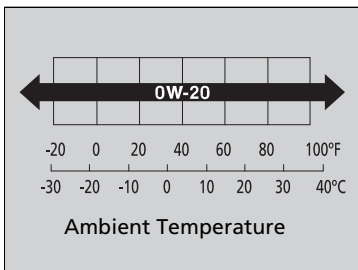

■ Synthetic oil

You may also use synthetic motor oil if it is labeled with the API Certification Seal and is the specified viscosity grade.

►► Recommended Engine Oil

Engine Oil Additives

Your vehicle does not require oil additives. In fact, they may adversely affect the engine performance and durability.

Oil Check

We recommend that you check the engine oil level every time you refuel.

Park the vehicle on level ground.

Wait approximately three minutes after turning the engine off before you check the oil.

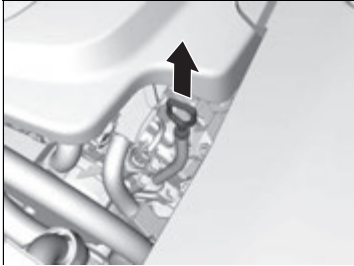

1. Remove the dipstick (orange).
2. Wipe the dipstick with a clean cloth or paper towel.
3. Insert the dipstick back all the way into its hole.

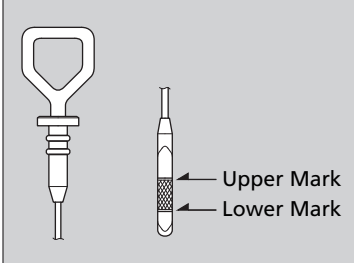

4. Remove the dipstick again, and check the level. It should be between the upper and lower marks. Add oil if necessary.

Oil Check

If the oil level is near or below the lower mark, slowly add oil, being careful not to overfill.

Adding Engine Oil

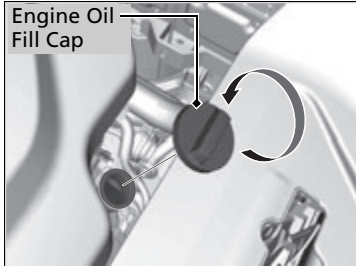

1. Unscrew and remove the engine oil fill cap.
2. Add oil slowly.
3. Reinstall the engine oil fill cap, and tighten it securely.
4. Wait for three minutes and recheck the engine oil dipstick.

► Adding Engine Oil

NOTICE

Do not fill the engine oil above the upper mark. Overfilling the engine oil may result in leaks and engine damage.

If any oil spills, wipe it away immediately. Spilled oil may damage the engine compartment components.

Changing the Engine Oil and Oil Filter

You must change the engine oil and oil filter regularly in order to maintain the engine's lubrication. The engine may be damaged if they are not changed regularly.

Change the oil and filter in accordance with the maintenance message on the driver information interface.

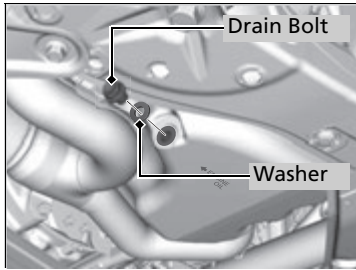

1. Run the engine until it reaches normal operating temperature, and then turn the engine off.
2. Open the hood and remove the engine oil fill cap.
3. Remove the drain bolt and washer from the bottom of the engine, and drain the oil into a suitable container.

Changing the Engine Oil and Oil Filter

NOTICE

You may damage the environment if you do not dispose of the oil in a suitable way. If you are changing the oil by yourself, appropriately dispose of the used oil. Put the oil in a sealed container and take it to a recycling center. Do not throw the oil away into a garbage can or onto the ground.

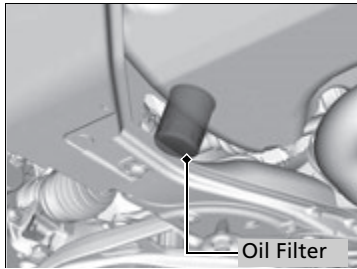

4. Remove the oil filter and dispose of the remaining oil.
5. Check that the filter gasket is not stuck to the engine contact surface.
 - If it is stuck, you must detach it.
6. Wipe away dirt and dust adhering to the contact surface of the engine block, and install a new oil filter.
 - Apply a light coat of new engine oil to the filter gasket.
7. Put a new washer on the drain bolt, then reinstall the drain bolt.
 - Tightening torque:
29 lbf·ft (40 N·m, 4.0 kgf·m)
8. Pour the recommended engine oil into the engine.
 - Engine oil change capacity (including filter):
5.7 US qt (5.4 L)
9. Reinstall the engine oil fill cap securely and start the engine.
10. Run the engine for a few minutes, and then check that there is no leak from the drain bolt or oil filter.
11. Stop the engine, wait for three minutes, and then check the oil level on the dipstick.
 - If necessary, add more engine oil.

► Changing the Engine Oil and Oil Filter

You will need a special wrench to replace the oil filter. You can buy this wrench from a dealer.

When installing the new oil filter, follow the instructions supplied with the oil filter.

Reinstall the engine oil fill cap. Start the engine. If the low oil pressure warning appears, turn off the engine, and check your work.

Engine Coolant

Specified coolant: Honda Long Life Antifreeze/Coolant Type 2

This coolant is premixed with 50% antifreeze and 50% water. Do not add any straight antifreeze or water.

We recommend you check the engine coolant level every time you refuel. Check the reserve tank first. If it is completely empty, also check the coolant level in the radiator. Add the engine coolant accordingly.

Reserve Tank

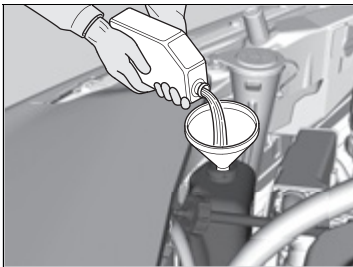
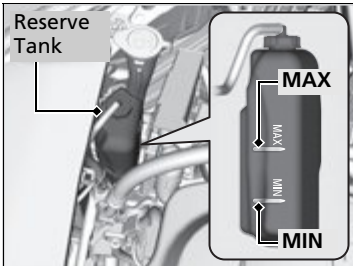

1. **Make sure the engine and radiator are cool.**
2. Check the amount of coolant in the reserve tank.
 - If the coolant level is below the **MIN** mark, add the specified coolant until it reaches the **MAX** mark.
3. Inspect the cooling system for leaks.

Engine Coolant

⚠ WARNING

Removing the radiator cap while the engine is hot can cause the coolant to spray out, seriously scalding you.

Always let the engine and radiator cool down before removing the radiator cap.

NOTICE

Genuine Honda engine coolant is a 50/50 mixture of antifreeze and water that can withstand freezing at temperatures as low as about -31°F (-35°C). If your vehicle is consistently subjected to temperatures below this, the concentration of antifreeze in the coolant should be increased. Consult a dealer for details.

If Honda antifreeze/coolant is not available, you may use another major brand of non-silicate coolant as a temporary replacement. Check that it is a high quality coolant recommended for aluminum engines. Continued use of any non-Honda coolant can result in corrosion, causing the cooling system to malfunction or fail. Have the cooling system flushed and refilled with Honda antifreeze/coolant as soon as possible.

Do not add rust inhibitors or other additives to your vehicle's cooling system. They may not be compatible with the coolant or with the engine components.

Continued

■ Radiator

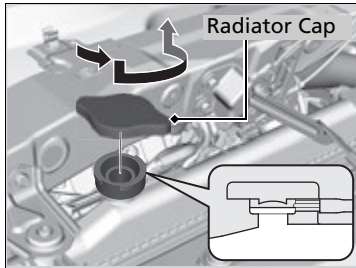

1. **Make sure the engine and radiator are cool.**
2. Remove the engine compartment cover.
 🔧 Engine Compartment Cover P. 675
3. Turn the radiator cap 1/8 turn counter-clockwise and relieve any pressure in the cooling system.
4. Push down and turn the radiator cap counter-clockwise to remove it.
5. The coolant level should be up to the base of the filler neck. Add coolant if it is low.
6. Put the radiator cap back on, and tighten it fully.

🔧 Radiator

NOTICE

Pour the fluid slowly and carefully so you do not spill any. Clean up any spills immediately; they can damage components in the engine compartment.

Transmission Fluid

Automatic Transmission Fluid

Specified fluid: Honda ATF-Type 2

Have a dealer check the fluid level and replace if necessary.

Do not attempt to check or change the automatic transmission fluid yourself.

Automatic Transmission Fluid

NOTICE

Honda ATF-Type 2 fluid must not be mixed with other transmission fluids.

Using a transmission fluid other than Honda ATF-Type 2 may adversely affect the operation and durability of your vehicle's transmission, and damage the transmission.

Any damage caused by using a transmission fluid that is not equivalent to Honda ATF-Type 2 is not covered by Honda's new vehicle limited warranty.

Brake Fluid

Specified fluid: Honda Heavy Duty Brake Fluid DOT 3

■ Checking the Brake Fluid

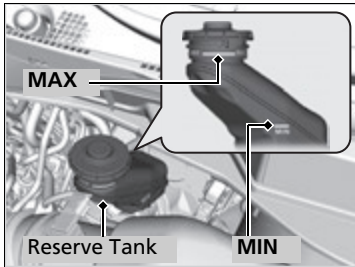

The fluid level should be between the **MIN** and **MAX** marks on the side of the reserve tank.

►► Brake Fluid

NOTICE

Brake fluid marked DOT 5 is not compatible with your vehicle's braking system and can cause extensive damage.

If the specified brake fluid is not available, you should use only DOT 3 or DOT 4 fluid from a sealed container as a temporary replacement.

Using any non-Honda brake fluid can cause corrosion and decrease the longevity of the system. Have the brake system flushed and refilled with Honda Heavy Duty Brake Fluid DOT 3 as soon as possible.

If the brake fluid level is at or below the **MIN** mark, have a dealer inspect the vehicle for leaks or worn brake pads as soon as possible.

Refilling Window Washer Fluid

Check the amount of window washer fluid by looking at the reservoir.

If the level is low, fill the washer reservoir.

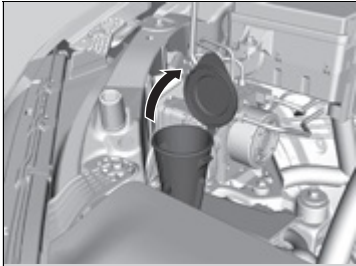

Canadian models

If the washer fluid is low, a message appears on the driver information interface.

Pour the washer fluid carefully. Do not overflow the reservoir.

» Refilling Window Washer Fluid

NOTICE

Do not use engine antifreeze or a vinegar/water solution in the windshield washer reservoir. Antifreeze can damage your vehicle's paint. A vinegar/water solution can damage the windshield washer pump. Use only commercially available windshield washer fluid. Avoid prolonged use of hard water to prevent lime scale build up.

Headlights

Headlights are LED type. Have an authorized Honda dealer inspect and replace the light assembly.

Fog Lights*

Fog lights are LED type. Have an authorized Honda dealer inspect and replace the light assembly.

Parking/Daytime Running Lights

Parking/daytime running lights are LED type. Have an authorized Honda dealer inspect and replace the light assembly.

▣ Headlights

The headlight aim is set by the factory, and does not need to be adjusted. However, if you regularly carry heavy items in the cargo area or tow a trailer, have the aiming readjusted at a dealer or by a qualified technician.

Front Turn Signal Light Bulbs

When replacing, use the following bulbs.

Front Turn Signal Light: 28/8 W (Amber)

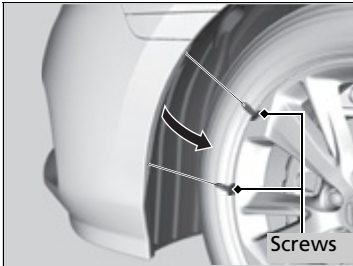

1. Turn the steering wheel all the way to the opposite side from the light being replaced.

Passenger side: Turn the steering wheel to the left.

Driver side: Turn the steering wheel to the right.

2. Remove the screws, and pull the inner fender back.

3. Rotate the socket counter-clockwise and remove it.

4. Remove the old bulb and insert a new bulb.

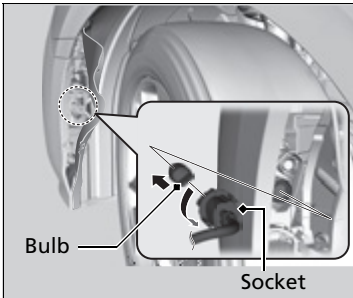

Front Side Marker Light Bulbs

When replacing, use the following bulb.

Front Side Marker Light: 3 CP

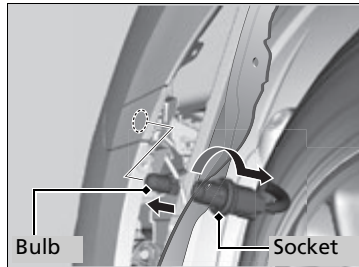
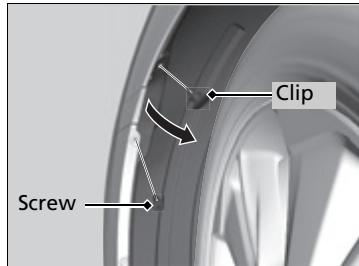

1. Turn the steering wheel all the way to the opposite side from the light being replaced.
Passenger side: Turn the steering wheel to the left.
Driver side: Turn the steering wheel to the right.
2. Remove the holding clip and screw, and pull the inner fender back.
3. Rotate the socket counter-clockwise and remove it.
4. Remove the old bulb and insert a new bulb.

Side Turn Signal/Emergency Indicator Lights*

Door mirror side turn lights are LED type. Have an authorized Honda dealer inspect and replace the light assembly.

Front Side Marker Light Bulbs

Press down the center pin until it clicks to unlock it.

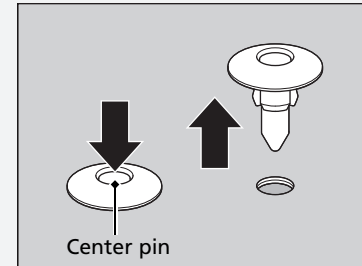

Push the center pin back to lock the clip. Then, insert the clip into the hole and press on the center pin until it is flat.

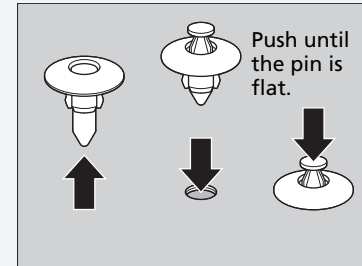

Brake, Rear Turn Signal Light Bulbs, and Rear Side Marker/Taillights

When replacing, use the following bulbs.

Brake Light: 21 W
Rear Turn Signal Light: 21 W
Rear Side Marker/Taillight: LED

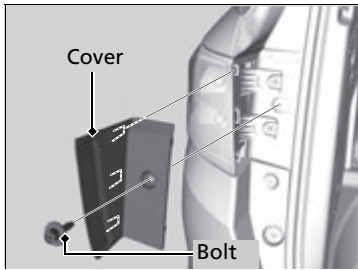

1. Use a Phillips-head screwdriver to remove the bolt.
2. Pull the cover out of the rear pillar.

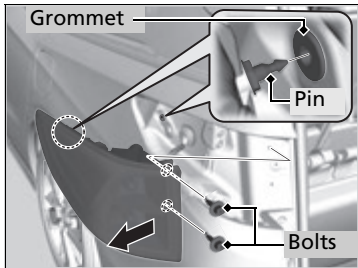

3. Use a Phillips-head screwdriver to remove the bolts.
4. Pull on the light assembly to rotate about the grommet and remove from the rear pillar.

☒ Brake, Rear Turn Signal Light Bulbs, and Rear Side Marker/Taillights

Rear side marker/taillights are LED type. Have an authorized Honda dealer inspect and replace the light assembly.

Continued

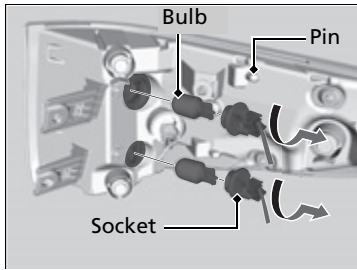

5. Turn the socket counter-clockwise and remove it. Remove the old bulb.
6. Insert a new bulb and turn the socket clockwise.
7. Slide the light assembly onto the guide on the body.
8. Align the pin with the body grommet, then push in until it fully seats.

Back-Up Light Bulbs/Taillights

When replacing, use the following bulbs.

Back-Up Light: 21 W
Taillight: LED

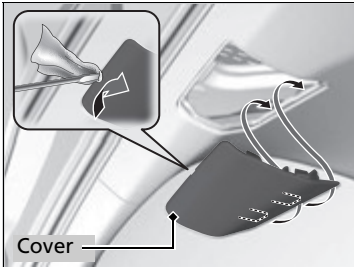

1. Remove the cover by prying on the edge of the cover using a flat-tip screwdriver.
 - ▶ Wrap the flat-tip screwdriver with a cloth to prevent scratches.

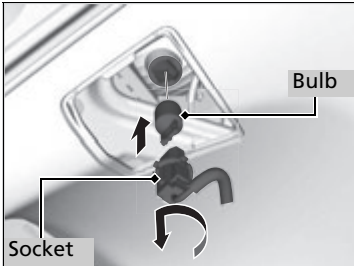

2. Turn the socket counter-clockwise and remove it.
3. Remove the old bulb and insert a new bulb.

Back-Up Light Bulbs/Taillights

Taillights are LED type. Have an authorized Honda dealer inspect and replace the light assembly.

Rear License Plate Light

Rear license plate light is LED type. Have an authorized Honda dealer inspect and replace the light assembly.

High-Mount Brake Light

High-mount brake light is LED type. Have an authorized Honda dealer inspect and replace the light assembly.

Checking Wiper Blades

If the wiper blade rubber has deteriorated, it will leave streaks, become noisy, and the hard surfaces of the blade may scratch the window glass.

Changing the Front Wiper Blade Rubber

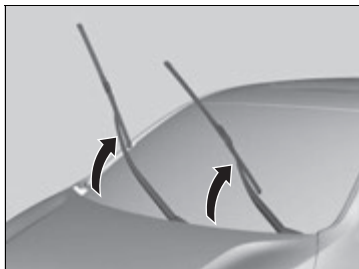
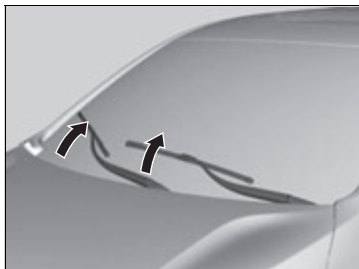

1. Set the power mode to VEHICLE OFF.
2. While holding the wiper switch in the **MIST** position, set the power mode to ON, then to VEHICLE OFF.
 - ▶ Both wiper arms are set to the maintenance position as shown in the image.
3. Lift both wiper arms.

Changing the Front Wiper Blade Rubber

NOTICE

Avoid dropping the wiper arm onto the windshield, it may damage the wiper arm and/or the windshield.

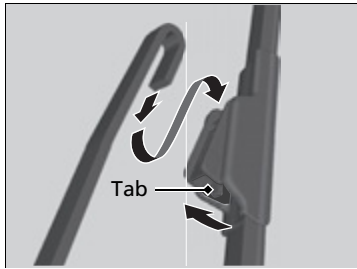

4. Press up on and hold the tab, then slide the holder off the wiper arm.

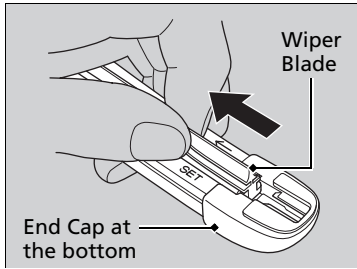

5. Pull the end of the wiper blade in the direction of the arrow in the image until it is out of the holder's end cap.

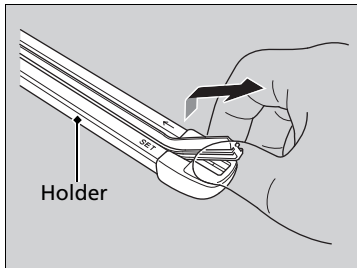

6. Pull the wiper blade in the opposite direction to slide it out of the holder.

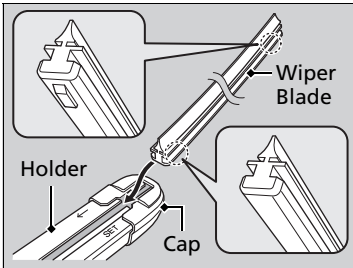

7. Insert the flat side of the new wiper blade onto the bottom part of the holder. Insert the blade all the way.
8. Install the end of the wiper blade into the cap.
9. Slide the holder onto the wiper arm until it locks.
10. Lower both wiper arms.
11. Set the power mode to ON and hold the wiper switch in the **MIST** position until both wiper arms return to the standard position.

Changing the Rear Wiper Blade Rubber

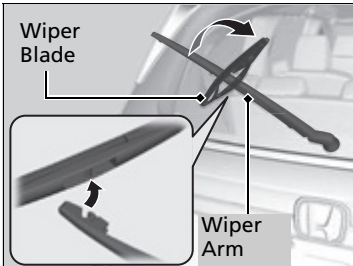

1. Raise the wiper arm off.
2. Pivot the bottom end of the wiper blade up until it comes off from the wiper arm.

✕ Changing the Rear Wiper Blade Rubber

NOTICE

Avoid dropping the wiper arm, it may damage the rear window.

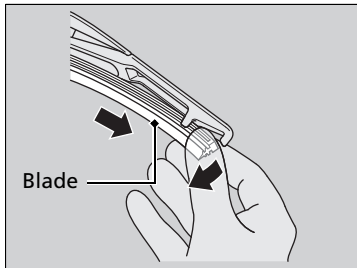

3. Slide the blade out of the holder.

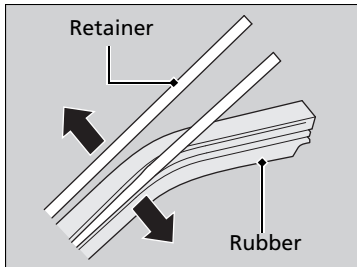

4. Remove the retainers from wiper blade and mount it to a new rubber blade.

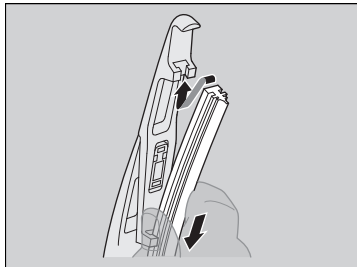

5. Slide the new wiper blade onto the holder.
▶ Make sure it is engaged correctly, then install the wiper blade assembly onto the wiper arm.

Checking Tires

To safely operate your vehicle, your tires must be of the proper type and size, in good condition with adequate tread, and properly inflated.

■ Inflation guidelines

Properly inflated tires provide the best combination of handling, tread life, and comfort. Refer to the driver's doorjamb label or specifications page for the specified pressure.

Underinflated tires wear unevenly, adversely affect handling and fuel economy, and are more likely to fail from overheating.

Overinflated tires make your vehicle ride harshly, are more prone to road hazards, and wear unevenly.

Every day before you drive, look at each of the tires. If one looks lower than the others, check the pressure with a tire gauge.

At least once a month or before long trips, use a gauge to measure the pressure in all tires, including the spare. Even tires in good condition can lose 1-2 psi (10-20 kPa, 0.1-0.2 kgf/cm²) per month.

■ Inspection guidelines

Every time you check inflation, also examine the tires and valve stems. Look for:

- Bumps or bulges on the side or in the tread. Replace the tire if you find any cuts, splits, or cracks in the side of the tire. Replace it if you see fabric or cord.
- Remove any foreign objects and inspect for air leaks.
- Uneven tread wear. Have a dealer check the wheel alignment.
- Excessive tread wear.
 - **Wear Indicators** P. 702
- Cracks or other damage around valve stem.

☒ Checking Tires

⚠ WARNING

Using tires that are excessively worn or improperly inflated can cause a crash in which you can be seriously hurt or killed.

Follow all instructions in this owner's manual regarding tire inflation and maintenance.

Measure the air pressure when tires are cold. This means the vehicle has been parked for at least three hours, or driven less than 1 mile (1.6 km). If necessary, add or release air until the specified pressure is reached.

If checked when hot, tire pressure can be as much as 4–6 psi (30–40 kPa, 0.3–0.4 kgf/cm²) higher than if checked when cold.

Have a dealer check the tires if you feel a consistent vibration while driving. New tires and any that have been removed and reinstalled should be properly balanced.

Check the spare tire pressure once a month or before long trips.

Tire and Loading Information Label

The label attached to the driver’s doorjamb provides necessary tire and loading information.

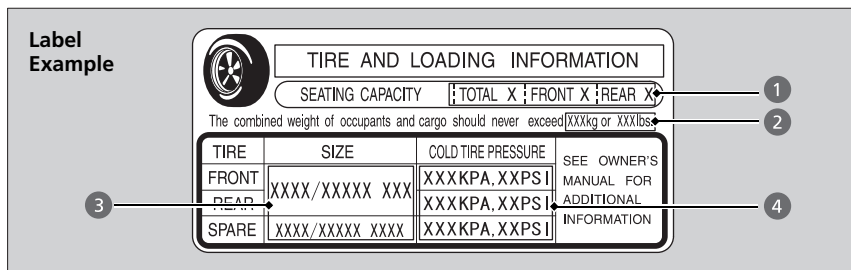

▶▶ Tire and Loading Information Label

The tire and loading information label attached to the driver’s doorjamb contains:

- 1 The number of people your vehicle can carry.
- 2 The total weight your vehicle can carry. Do not exceed this weight.
- 3 The original tire sizes for front, rear, and spare.
- 4 The proper cold tire pressure for front, rear, and spare.

Tire Labeling

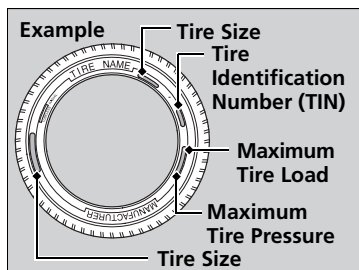

The tires that came on your vehicle have a number of markings. Those you should be aware of are described as shown.

▶▶ Tire Sizes

Following is an example of tire size with an explanation of what each component means.

P235/60 R18 102T

P: Vehicle type (P indicates passenger vehicle).

235: Tire width in millimeters.

60: Aspect ratio (the tire’s section height as a percentage of its width).

R: Tire construction code (R indicates radial).

18: Rim diameter in inches.

102: Load index (a numerical code associated with the maximum load the tire can carry).

T: Speed symbol (an alphabetical code indicating the maximum speed rating).

■ Tire Sizes

Whenever tires are replaced, they should be replaced with tires of the same size.

■ Tire Identification Number (TIN)

The tire identification number (TIN) is a group of numbers and letters that look like the example in the side column. TIN is located on the sidewall of the tire.

■ Glossary of Tire Terminology

Cold Tire Pressure – The tire air pressure when the vehicle has been parked for at least three hours or driven less than 1 mile (1.6 km).

Load Rating – Means the maximum load that a tire is rated to carry for a given inflation pressure.

Maximum Inflation Pressure – The maximum tire air pressure that the tire can hold.

Maximum Load Rating – Means the load rating for a tire at the maximum permissible inflation pressure for that tire.

Recommended Inflation Pressure – The cold tire inflation pressure recommended by the manufacturer.

Treadwear Indicators (TWI) – Means the projections within the principal grooves designed to give a visual indication of the degrees of wear of the tread.

☒ Tire Identification Number (TIN)

DOT B97R FW6X 2209

DOT: This indicates that the tire meets all requirements of the U.S. Department of Transportation.

B97R: Manufacturer's identification mark.

FW6X: Tire type code.

22 09: Date of manufacture.

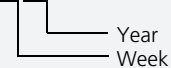

DOT Tire Quality Grading (U.S. Vehicles)

The tires on your vehicle meet all U.S. Federal Safety Requirements. All tires are also graded for treadwear, traction, and temperature performance according to Department of Transportation (DOT) standards. The following explains these gradings.

■ Uniform Tire Quality Grading

Quality grades can be found where applicable on the tire sidewall between tread shoulder and maximum section width.

■ Treadwear

The treadwear grade is a comparative rating based on the wear rate of the tire when tested under controlled conditions on a specified government test course. For example, a tire graded 150 would wear one and one-half (1 1/2) times as well on the government course as a tire graded 100. The relative performance of tires depends upon the actual conditions of their use, however, and may depart significantly from the norm due to variations in driving habits, service practices and differences in road characteristics and climate.

☒ Uniform Tire Quality Grading

For example:

Treadwear 200
Traction AA
Temperature A

All passenger car tires must conform to Federal Safety Requirements in addition to these grades.

■ Traction

The traction grades, from highest to lowest, are AA, A, B, and C. Those grades represent the tire's ability to stop on wet pavement as measured under controlled conditions on specified government test surfaces of asphalt and concrete. A tire marked C may have poor traction performance.

■ Temperature

The temperature grades are A (the highest), B, and C, representing the tire's resistance to the generation of heat and its ability to dissipate heat when tested under controlled conditions on a specified indoor laboratory test wheel. Sustained high temperature can cause the material of the tire to degenerate and reduce tire life, and excessive temperature can lead to sudden tire failure. The grade C corresponds to a level of performance which all passenger car tires must meet under the Federal Motor Vehicle Safety Standard No. 109. Grades B and A represent higher levels of performance on the laboratory test wheel than the minimum required by law.

☒ Traction

Warning: The traction grade assigned to this tire is based on straight-ahead braking traction tests, and does not include acceleration, cornering, hydroplaning, or peak traction characteristics.

☒ Temperature

Warning: The temperature grade for this tire is established for a tire that is properly inflated and not overloaded. Excessive speed, underinflation, or excessive loading, either separately or in combination, can cause heat buildup and possible tire failure.

Wear Indicators

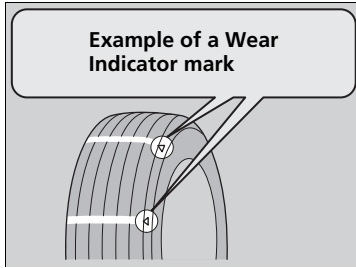

The groove where the wear indicator is located is about 1/16 inch (about 1.6 mm) shallower than elsewhere on the tire. If the tread has worn so that the indicator is exposed, replace the tire.

Worn out tires have poor traction on wet roads.

Tire Service Life

The life of your tires is dependent on many factors, including driving habits, road conditions, vehicle loading, inflation pressure, maintenance history, speed, and environmental conditions (even when the tires are not in use).

In addition to regular inspections and inflation pressure maintenance, it is recommended that you have annual inspections performed once the tires reach five years old. All tires, including the spare, should be removed from service after 10 years from the date of manufacture, regardless of their condition or state of wear.

Tire and Wheel Replacement

Replace your tires with radials of the same size, load range, speed rating, and maximum cold tire pressure rating (as shown on the tire's sidewall). Using tires of a different size or construction can cause certain vehicle systems such as the ABS and Vehicle Stability Assist™ (VSA®) system to work incorrectly.

It is best to replace all four tires at the same time. If that isn't possible, replace the front or rear tires in pairs.

Whenever you have a tire replaced or reset, make sure that the rubber valve stem is replaced and that the TPMS sensor is transferred from the old valve stem to the new one.

If you replace a wheel, make sure that the wheel's specifications match those of the original wheels.

⚠ Tire and Wheel Replacement

⚠ WARNING

Installing improper tires on your vehicle can affect handling and stability. This can cause a crash in which you can be seriously hurt or killed.

Always use the size and type of tires recommended in this owner's manual.

Tire Rotation

Rotating tires according to the maintenance messages on the driver information interface helps to distribute wear more evenly and increase tire life.

■ Tires without rotation marks

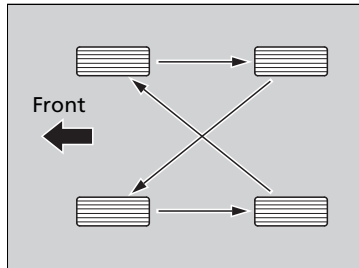

Rotate the tires as shown here.

■ Tires with rotation marks

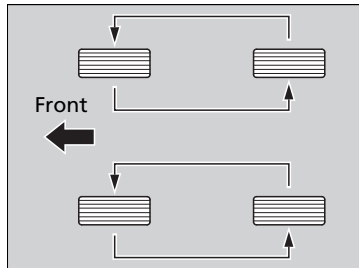

Rotate the tires as shown here.

►► Tire Rotation

Tires with directional tread patterns should only be rotated front to back (not from one side to the other). Directional tires should be mounted with the rotation indication mark facing forward, as shown below.

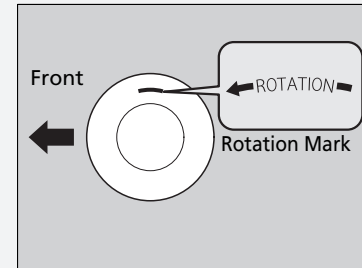

Winter Tires

If driving on snowy or frozen roads, mount all season marked **M+S** tires, snow tires, or tire chains; reduce speed; and maintain sufficient distance between vehicles when driving.

Be particularly careful when operating the steering wheel or brakes to prevent skidding.

Use tire chains, snow tires, or all season tires when necessary or according to the law.

When mounting, refer to the following points.

For winter tires:

- Select the size and load ranges that are the same as the original tires.
- Mount the tires to all four wheels.

For tire chains:

- Install them on the front tires only.
- Because your vehicle has limited tire clearance, we strongly recommend using the chains listed below:

Models with 235/60R18 tires

Peerless Auto-Trac 231905

Models with 235/55R19 tires

Peerless Auto-Trac 232405

- Follow the chain manufacturer's instruction when installing. Mount them as tightly as you can.
- Check that the chains do not touch the brake lines or suspension.
- Drive slowly.

❖ Winter Tires

⚠ WARNING

Using the wrong chains, or not properly installing chains, can damage the brake lines and cause a crash in which you can be seriously injured or killed.

Follow all instructions in this owner's manual regarding the selection and use of tire chains.

NOTICE

Traction devices that are the wrong size or improperly installed can damage your vehicle's brake lines, suspension, body, and wheels. Stop driving if they are hitting any part of the vehicle.

When tire chains are mounted, follow the chain manufacturer's instructions regarding vehicle operational limits.

If your vehicle is equipped with summer tires, be aware that these tires are not designed for winter driving conditions. For more information, contact a dealer.

Checking the Battery



The condition of the battery is monitored by a sensor located on the negative terminal of the battery. If there is a problem with this sensor, the driver information interface will display a warning message. If this happens, have your vehicle inspected by a dealer.

Check the battery terminals for corrosion monthly.

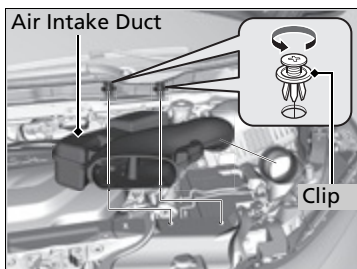

To access the battery terminals:

1. Remove the engine compartment cover.
➤ **Engine Compartment Cover** P. 675
2. Remove the clips using a Phillips-head screwdriver, then remove the air intake duct.

If your vehicle's battery is disconnected or goes dead:

- The audio system is disabled.
➤ **Reactivating the audio system** P. 278
- The clock resets.
➤ **Clock** P. 154
- **Canadian models only**

The immobilizer system needs to be reset.

- **Immobilizer System Indicator** P. 98

⚠ Battery

⚠ WARNING

The battery gives off explosive hydrogen gas during normal operation.

A spark or flame can cause the battery to explode with enough force to kill or seriously hurt you.

When conducting any battery maintenance, wear protective clothing and a face shield, or have a skilled technician do it.

WARNING: Battery post, terminals, and related accessories contain lead and lead compounds.

Wash your hands after handling.

When you find corrosion, clean the battery terminals by applying a baking powder and water solution. Clean the terminals with a damp towel. Cloth/towel dry the battery. Coat the terminals with grease to help prevent future corrosion.

When replacing the battery, the replacement must be of the same specifications.

Consult a dealer for more information.

Charging the AGM Battery

AGM labeled batteries like those installed in your vehicle require a compatible charger to be properly charged. Damage to the battery can result if the battery is charged improperly or with the wrong equipment. For more information on how to charge your vehicle's AGM battery, consult a dealer.

⌘ Battery

The battery installed in this vehicle is specifically designed for a model with Auto Idle Stop. Using a battery other than this specified type may shorten the battery life, and prevent Auto Idle Stop from activating. If you need to replace the battery, make sure to select the specified type and size. Ask a dealer for more details.

Replacing the Remote Battery

If the indicator does not come on when the button is pressed, replace the battery.



Battery type: CR2032

1. Remove the built-in key.
2. Remove the upper half of the cover by carefully prying on the edge with a coin.
 - ▶ Wrap a coin with a cloth to prevent scratching the remote.
 - ▶ Remove carefully to avoid losing the buttons.
3. Make sure to replace the battery with the correct polarity.

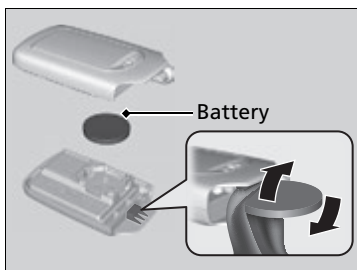

Replacing the Remote Battery

WARNING

CHEMICAL BURN HAZARD

The battery that powers the remote transmitter can cause severe internal burns and can even lead to death if swallowed. Keep new and used batteries away from children.

If you suspect that a child has swallowed the battery, seek medical attention immediately.

NOTICE

An improperly disposed of battery can damage the environment. Always confirm local regulations for battery disposal.

Replacement batteries are commercially available or at a dealer.

Models with Blu-ray/DVD rear entertainment system

Replacing the Battery

Remote Control

If it takes several pushes on the remote control buttons to operate the Blu-ray/DVD rear entertainment system, replace the batteries.

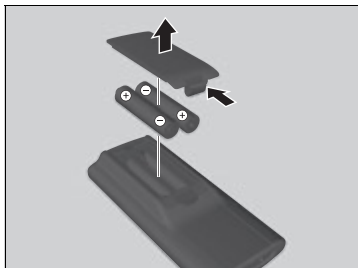

Battery type: AAA

1. Remove the cover.
2. Make sure to replace the batteries with the correct polarity.

Replacing the Battery

NOTICE

An improperly disposed of battery can damage the environment. Always confirm local regulations for battery disposal.

Replacement batteries are commercially available or at a dealer.

Make sure to replace the two batteries at once.

* Not available on all models

■ Wireless Headphones

If there is no sound coming from the wireless headphones, replace the batteries.

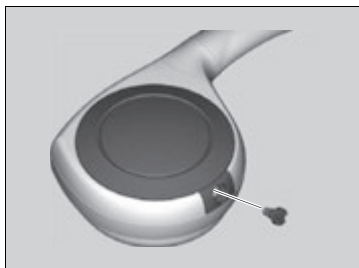

Battery type: AAA

1. Remove the screw.

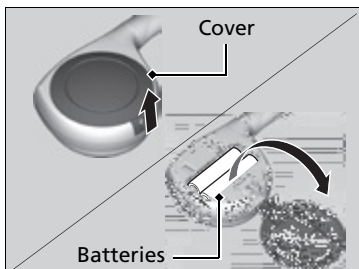

2. Open the cover.

3. Make sure to replace the batteries with the correct polarity.

Air Conditioning

To ensure proper and safe operation, the Society of Automotive Engineers (SAE J2845) recommends that the refrigerant system only be serviced by trained and certified technicians.

Never repair or replace the air conditioning evaporator (cooling coil) with one removed from a used or salvaged vehicle.

New replacement mobile air conditioning evaporators must be certified (and labeled) as meeting SAE Standard J2842.

Dust and Pollen Filter

The climate control system is equipped with a dust and pollen filter that collects pollen, dust, and other debris in the air. The Maintenance Minder™ messages will let you know when to replace the filter.

We recommend that you replace the dust and pollen filter sooner when using your vehicle in areas with high concentrations of dust.

Air Conditioning

NOTICE

Vented refrigerant is harmful to the environment. To avoid refrigerant from venting, never replace the evaporator with one removed from a used or salvaged vehicle.

Refrigerant in your vehicle's air conditioning system is flammable and can be ignited during servicing if proper procedures are not followed.

The air conditioner label is found under the hood:

➤ **Safety Labels** P. 86

➤ **Specifications** P. 760

Canadian models



 : Caution

 : Flammable Refrigerant

 : Requires Registered Technician to Service

 : Air Conditioning System

Dust and Pollen Filter

If the airflow from the climate control system deteriorates noticeably, and the windows fog up easily, the filter may need to be replaced. Please contact a dealer for replacement.

Interior Care

Use a damp cloth with a mixture of mild detergent and warm water to remove dirt. Use a clean cloth to remove detergent residue.

Cleaning Seat Belts

Use a soft brush with a mixture of mild soap and warm water to clean the seat belts. Let the belts air dry. Wipe the loops of the seat belt anchors using a clean cloth.

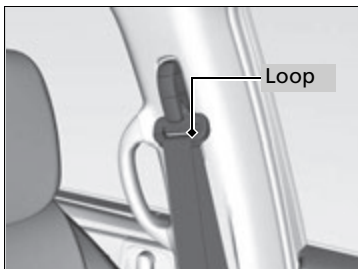

Cleaning the Window

Wipe using a glass cleaner.

Interior Care

Do not spill liquids inside the vehicle. Electrical devices and systems may malfunction if liquids are splashed on them.

Do not use silicone based sprays on electrical devices such as audio devices and switches. Doing so may cause the items to malfunction or cause a fire inside the vehicle.

If a silicone based spray is inadvertently used on electrical devices, consult a dealer.

Depending on their composition, chemicals and liquid aromatics may cause discoloration, wrinkles, and cracking to resin-based parts and textiles. Do not use alkali solvents or organic solvents such as benzene or gasoline.

After using chemicals, make sure to gently wipe them off using a dry cloth.

Do not place used cloths on top of resin based parts or textiles for long periods of time without washing.

Cleaning the Window

Wires are mounted to the inside of the rear window. Wipe along the same direction as the wires with a soft cloth so as not to damage them.

Be careful not to spill fluids, such as water or glass cleaner, on or around the cover of both the front sensor camera and the rainfall/light sensor*.

■ Floor Mats

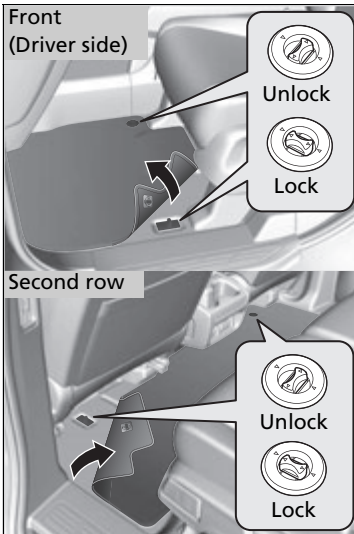

The front and second row floor mats hook over floor anchors, which keep them from sliding forward. To remove a mat for cleaning, turn the anchor knobs to the unlock position. When reinstalling the mat after cleaning, turn the knobs to the lock position.

Do not put additional floor mats on top of the anchored mats.

▣ Floor Mats

If you use any floor mats that were not originally provided with your vehicle, make sure they are designed for your specific vehicle, fit correctly, and are securely anchored by the floor anchors. Position the second row seat floor mat properly. If not properly positioned, the floor mat can interfere with the front seat functions.

Continued

■ Maintaining Genuine Leather*

To properly clean leather:

1. Use a vacuum or soft dry cloth first to remove any dirt or dust.
2. Clean the leather with a soft cloth dampened with a solution comprised of 90% water and 10% neutral soap.
3. Wipe away any soap residue with a clean damp cloth.
4. Wipe away residual water and allow leather to air dry in the shade.

▣ Maintaining Genuine Leather*

It is important to clean or wipe away dirt or dust as soon as possible. Spills can soak into leather resulting in stains. Dirt or dust can cause abrasions in the leather. In addition, please note that some dark colored clothing can rub onto the leather seats resulting in discoloration or stains.

Exterior Care

Dust off the vehicle body after you drive. Regularly inspect your vehicle for scratches on painted surfaces. A scratch on a painted surface can result in body rust. If you find a scratch, promptly repair it.

■ Washing the Vehicle

Wash the vehicle regularly. Wash more frequently when driving in the following conditions:

- If driving on roads with road salt.
- If driving in coastal areas.
- If tar, soot, bird droppings, insects, or tree sap are stuck to painted surfaces.

▣ Washing the Vehicle

Do not spray water into the air intake vents. It can cause a malfunction.

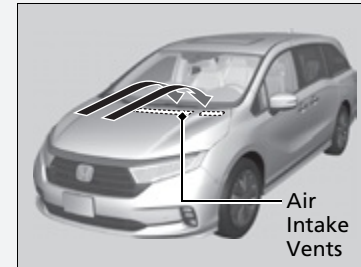

Do not spray water onto the capless unit when the fuel fill door is open. It can cause damage to the fuel system or engine.

If you need to lift the wiper arms away from the windshield, first set the wiper arms to the maintenance position.

▣ **Changing the Front Wiper Blade Rubber**
P. 693

Continued

■ Using an Automated Car Wash

- Make sure to follow the instructions indicated on the automated car wash.
- Fold in the door mirrors.
- For models equipped with automatic intermittent wipers, turn the wipers off.

■ Using High Pressure Cleaners

- Keep sufficient distance between the cleaning nozzle and the vehicle body.
- Take particular care around the windows. Standing too close may cause water to enter the vehicle interior.
- Do not spray high pressure water directly into the engine compartment. Instead, use low pressure water and a mild detergent.

■ Applying Wax

A good coat of automotive body wax helps protect your vehicle's paint from the elements. Wax will wear off over time and expose your vehicle's paint to the elements, so reapply as necessary.

■ Maintaining the Bumpers and Other Resin Coated Parts

If you get gasoline, oil, engine coolant, or battery fluid on resin coated parts, they may be stained or the coating may peel. Promptly wipe it away using a soft cloth and clean water.

►► Using an Automated Car Wash

When using an automated car wash that pulls the vehicle through with a conveyor, make sure the transmission is in **N** position.

► **If you want to keep the transmission in **N** position [car wash mode] P. 562**

►► Applying Wax

NOTICE

Chemical solvents and strong cleaners can damage the paint, metal, and plastic on your vehicle. Wipe away spills immediately.

►► Maintaining the Bumpers and Other Resin Coated Parts

Ask a dealer about the correct coating material when you want to repair the painted surface of the parts made of resin.

■ Cleaning the Window

Wipe using a glass cleaner.

■ Maintaining Aluminum Wheels

Aluminum is susceptible to deterioration caused by salt and other road contaminants. When necessary, as early as possible use a sponge and mild detergent to wipe away these contaminants. Do not use a stiff brush or harsh chemicals (including some commercial wheel cleaners). These can damage the protective finish on aluminum alloy wheels, resulting in corrosion. Depending on the type of finish, the wheels also may lose their luster or appear burnished. To avoid water stains, wipe the wheels dry with a cloth while they are still wet.

■ Fogged Exterior Light Lenses

The inside lenses of exterior lights (headlights, brake lights, etc.) may fog temporarily if you have driven in the rain, or after the vehicle has been run through a car wash. Dew condensation also may build up inside the lenses when there is a significant enough difference between the ambient and inside lens temperatures (similar to vehicle windows fogging up in rainy conditions). These conditions are natural processes, not structural design problems in the exterior lights.

Lens design characteristics may result in moisture developing on the light lens frame surfaces. This also is not a malfunction.

However, if you see large amounts of water accumulation, or large water drops building up inside the lenses, have your vehicle inspected by a dealer.

Accessories

When installing accessories, check the following:

- Do not install accessories on the windshield. They can obstruct your view and delay your reaction to driving conditions.
- Do not install any accessories over areas marked **SRS AIRBAG**, on the sides or backs of the front seats, on front or side pillars, or near the side windows. Accessories installed in these areas may interfere with proper operation of the vehicle's airbags or may be propelled into you or another occupant if the airbags deploy.
- Be sure electronic accessories do not overload electrical circuits or interfere with proper operation of your vehicle.
 - ▣ **Fuses** P. 745
- Before installing any electronic accessory, have the installer contact a dealer for assistance. If possible, have a dealer inspect the final installation.

▣ Accessories and Modifications

WARNING

Improper accessories or modifications can affect your vehicle's handling, stability, and performance, and cause a crash in which you can be seriously hurt or killed.

Follow all instructions in this owner's manual regarding accessories and modifications.

Honda Genuine accessories are recommended to ensure proper operation on your vehicle.

Modifications

Do not modify your vehicle in a manner that may affect its handling, stability, or reliability, or install non-genuine Honda parts or accessories that may have a similar effect.

Even minor modifications to vehicle systems can affect overall vehicle performance. Always make sure all equipment is properly installed and maintained, and do not make any modification to your vehicle or its systems that might cause your vehicle to no longer meet federal, state, province, territory, and local regulations.

The on-board diagnostic port (OBD-II/SAE J1962 connector) installed on this vehicle is intended to be used with automobile system diagnostic devices or with other devices that Honda has approved. Use of any other type of device may adversely affect the vehicle's electronic systems or allow them to be compromised, possibly resulting in a system malfunction, drained battery, or other unexpected problems.

Do not modify or attempt to repair any of the electrical components.

This page intentionally left blank.

Handling the Unexpected

This chapter explains how to handle unexpected troubles.

Tools

Types of Tools..... 722

If a Tire Goes Flat

Changing a Flat Tire..... 723

Engine Does Not Start

Checking the Engine..... 732

If the Remote Battery is Weak 733

Emergency Engine Stop 734

If the Battery Is Dead

Overheating

How to Handle Overheating..... 737

Indicator, Coming On/Blinking

If the Low Oil Pressure Warning Appears..... 739

If the Charging System Indicator Comes On 740

If the Malfunction Indicator Lamp Comes On or Blinks 740

If the Brake System Indicator (Red) Comes On or Blinks 741

If the Brake System Indicator (Red) Comes On or Blinks at the Same Time When the Brake System Indicator (Amber) Comes On..... 742

If the Electric Power Steering (EPS) System Indicator Comes On 743

If the Low Tire Pressure/TPMS Indicator Comes On or Blinks..... 743

If the Transmission System Indicator Blinks along with the Warning Message... 744

Fuses

Fuse Locations 745

Inspecting and Changing Fuses..... 751

Emergency Towing..... 752

If You Cannot Unlock the Fuel Fill Door ... 753

If You Cannot Open the Tailgate 754

When You Cannot Close the Power Sliding Doors* 756

Refueling

Refueling From a Portable Fuel Container 757

* Not available on all models

Types of Tools

Types of Tools

The tools are stored in front of the second row seat and in the right side panel of the cargo area.

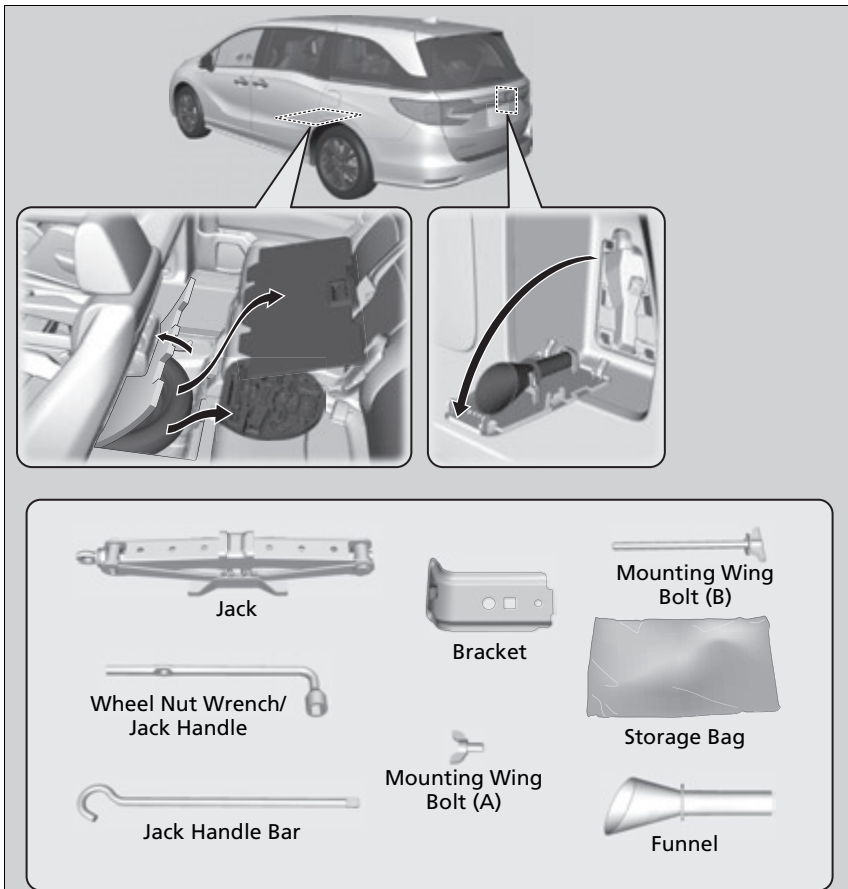

Changing a Flat Tire

If a tire goes flat while driving, grasp the steering wheel firmly, and brake gradually to reduce speed. Then, stop in a safe place. Replace the flat tire with a compact spare tire. Go to a dealer as soon as possible to have the full-size tire repaired or replaced.

1. Park the vehicle on a firm, level, non-slippery surface and apply the parking brake.
2. Put the transmission into **P**.
3. Turn on the hazard warning lights and set the power mode to VEHICLE OFF.

Changing a Flat Tire

Follow compact spare precautions:
Periodically check the tire pressure of the compact spare. It should be set to the specified pressure.
Specified Pressure: 60 psi (420 kPa, 4.2 kgf/cm²)

When driving with the compact spare tire, keep the vehicle speed under 50 mph (80 km/h). Replace with a full-size tire as soon as possible.

The compact spare tire and wheel in your vehicle are specifically for this model. Do not use them with another vehicle. Do not use another type of compact spare tire or wheel with your vehicle.

Do not mount tire chains on a compact spare tire. If a chain-mounted front tire goes flat, remove one of the full-size rear tires and replace it with the compact spare tire. Remove the flat front tire and replace it with the full-size tire that was removed from the rear. Mount the tire chains on the front tire.

Do not use a puncture-repairing agent on a flat tire, as it can damage the tire pressure sensor.

Do not use the jack if it doesn't work properly. Call your dealer or a professional towing service.

■ Getting Ready to Replace the Flat Tire

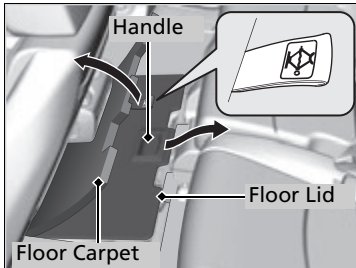

1. Remove the second row floor mat.
 ▶ **Floor Mats** P. 713
2. Pull up the floor carpet.
3. Lift up the floor lid using the handle and remove it.

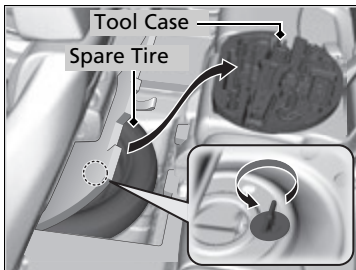

4. Take the tool case out of the spare tire well. Take the jack and wheel nut wrench out of the tool case.
5. Unscrew the wing bolt, then remove the spare tire.

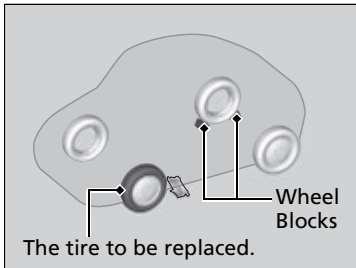

6. Place a wheel block or rock in front and rear of the wheel diagonal to the flat tire.

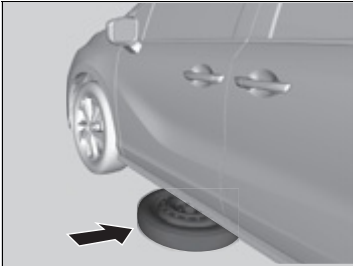

7. Place the compact spare tire (wheel side up) under the vehicle body, near the tire that needs to be replaced.



8. Loosen each wheel nut about one turn using the wheel nut wrench.

■ How to Set Up the Jack

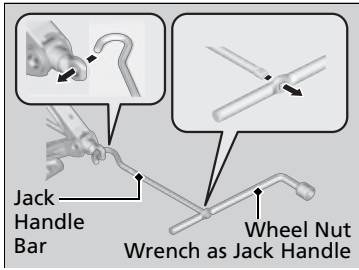
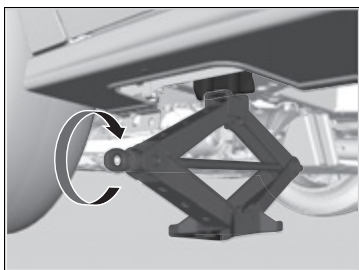
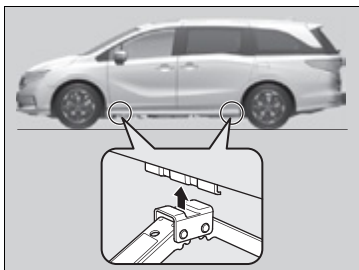

1. Place the jack under the jacking point closest to the tire to be changed.
2. Turn the end bracket clockwise as shown in the image until the top of the jack contacts the jacking point.
 - ▶ Make sure that the jacking point tab is resting in the jack notch.
3. Raise the vehicle, using the jack handle bar and the jack handle, until the tire is off the ground.

🔧 How to Set Up the Jack

⚠ WARNING

The vehicle can easily roll off the jack, seriously injuring anyone underneath.

Follow the directions for changing a tire exactly, and never get under the vehicle when it is supported only by the jack.

Do not use the jack with people or luggage in the vehicle.

Use the jack provided in your vehicle. Other jacks may not support the weight (“load”) or may not fit the jacking point.

The following instructions must be followed to use the jack safely:

- Do not use while the engine is running.
- Use only where the ground is firm and level.
- Use only at the jacking points.
- Do not get in the vehicle while using the jack.
- Do not put anything on top of or underneath the jack.

Models with power sliding doors

Turn off the sliding door main switch before replacing a rear tire. If the main switch is on, the power sliding door may accidentally operate, causing an accident.

■ Replacing the Flat Tire

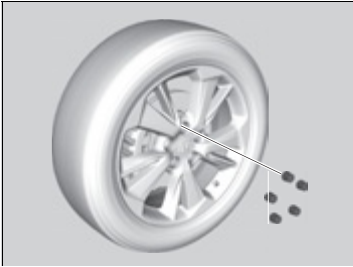

1. Remove the wheel nuts and flat tire.

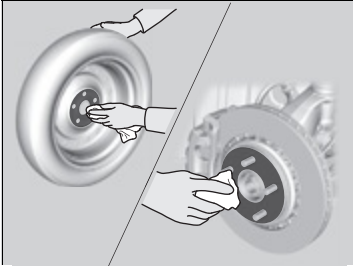

2. Wipe the mounting surfaces of the wheel with a clean cloth.
3. Mount the compact spare tire.
4. Screw the wheel nuts until they touch the lips around the mounting holes, then stop rotating.

▣ Replacing the Flat Tire

Do not over tighten the wheel nuts by applying extra torque using your foot or a pipe.

Continued

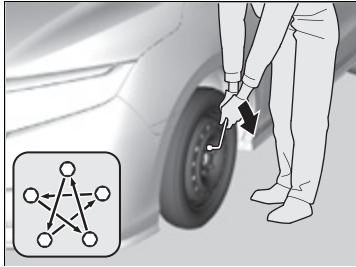

5. Lower the vehicle and remove the jack. Tighten the wheel nuts in the order indicated in the image. Go around, tightening the nuts, two to three times in this order.

Wheel nut torque:

94 lbf·ft (127 N·m, 13 kgf·m)

■ Storing the Flat Tire

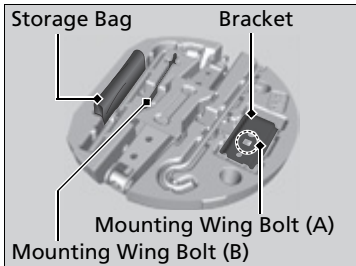

The storage bag, bracket, mounting wing bolt (A) and mounting wing bolt (B) are in the tool case.

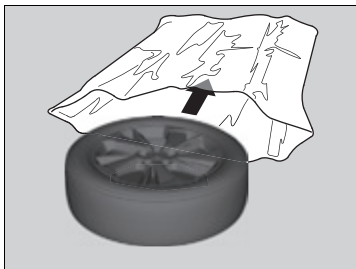

1. Put the flat tire in the storage bag provided with your vehicle.

▣ Storing the Flat Tire

⚠ WARNING

Loose items can fly around the interior in a crash and can seriously injure the occupants.

Store the wheel, jack, and tools securely before driving.

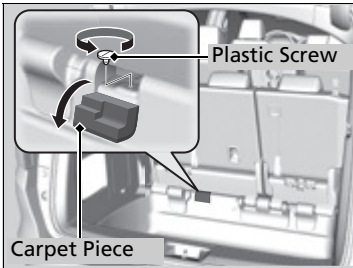

2. Pull down the U-shaped carpet piece.
3. Remove the plastic screw with a coin.

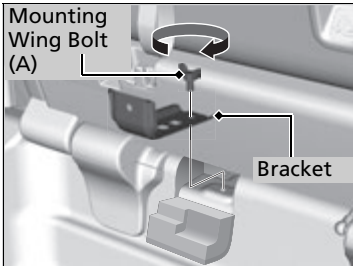

4. Install the bracket and the mounting wing bolt (A) on the attachment point, and tighten the bolt.

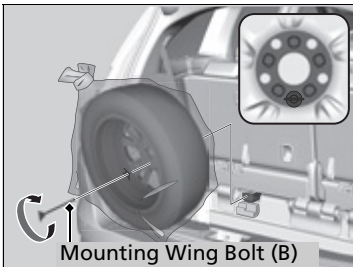

5. Install the flat tire on the bracket with the inside of the wheel facing toward you.
6. Install the mounting wing bolt (B) to the bracket through one of the five wheel nut holes, and tighten the bolt.
 - Poke a hole in the storage bag as needed.

■ **Storing a flat tire on the folded third row seat**

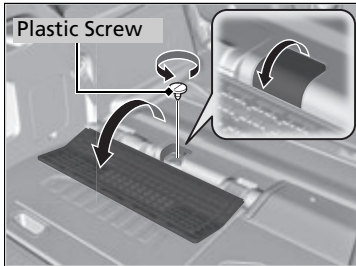

1. Turn over the flap on the left side of the cargo area floor.
2. Pull down the U-shaped carpet piece and remove the plastic screw with a coin.

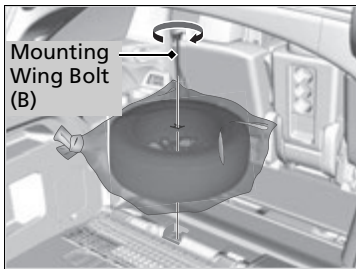

3. Place the flat tire face down on the attachment point.
4. Put the tire mounting wing bolt (B) in the attachment point through one of the five wheel nut holes, and tighten the bolt.
 - Poke a hole in the storage bag as needed.

■ TPMS with Tire Fill Assist and the Compact Spare Tire

If you replace a flat tire with the spare tire, the low tire pressure/TPMS indicator comes on while you are driving. After driving for a few miles (kilometers), **Tire Pressure Monitor Problem** will appear on the driver information interface and the indicator will start blinking for a short time and then stay on; however, this is normal and is no cause for concern.

If you replace the tire with a full-size tire, the warning message on the driver information interface and the low tire pressure/TPMS indicator will go off after a few miles (kilometers).

▣ TPMS with Tire Fill Assist and the Compact Spare Tire

The system cannot monitor the pressure of the spare tire. Manually check the spare tire pressure to be sure that it is correct.

Use the TPMS specific wheels. Each is equipped with a tire pressure sensor mounted inside the tire behind the valve stem.

Checking the Engine

If the engine does not start, check the starter.

☒ Checking the Engine

If you must start the vehicle immediately, use an assisting vehicle or booster battery to jump start it.

☒ **If the Battery Is Dead** P. 735

Starter condition

Checklist

Starter doesn't turn or turns over slowly.

The battery may be dead. Check each of the items on the right and respond accordingly.

The starter turns over normally but the engine doesn't start.

There may be a problem with a fuse. Check each of the items on the right and respond accordingly.

Check for a message on the driver information interface.

- If the **To Start, Hold Remote Near Start Button** message appears
 - ☒ **If the Remote Battery is Weak** P. 733
- ▶ Make sure the remote is in its operating range.
 - ☒ **ENGINE START/STOP Button Operating Range** P. 198

Check the brightness of the interior lights.

- Turn on the interior lights and check the brightness.
- If the interior lights are dim or do not come on at all
 - ☒ **Battery** P. 706
 - If the interior lights come on normally ☒ **Fuses** P. 745

Review the engine start procedure.

Follow its instructions, and try to start the engine again. ☒ **Starting the Engine** P. 550

Check the immobilizer system indicator.

When the immobilizer system indicator is blinking, the engine cannot be started.

☒ **Immobilizer System** P. 191

Check the fuel level.

There should be enough fuel in the tank. ☒ **Fuel Gauge** P. 127

Check the fuses.

Check all fuses, or have the vehicle checked by a dealer.

☒ **Inspecting and Changing Fuses** P. 751

If the problem continues:

☒ **Emergency Towing** P. 752

If the Remote Battery is Weak

If the beeper sounds, the **To Start, Hold Remote Near Start Button** message appears on the driver information interface, the **ENGINE START/STOP** button flashes, and the engine won't start, start the engine as follows:

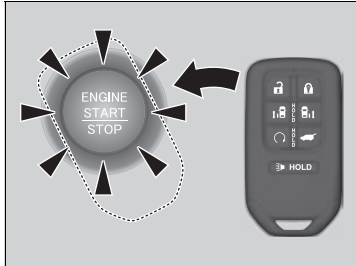

1. Touch the center of the **ENGINE START/STOP** button with the **H** logo on the remote while the **ENGINE START/STOP** button is flashing. The buttons on the remote should be facing you.

▶ The **ENGINE START/STOP** button flashes for about 30 seconds.

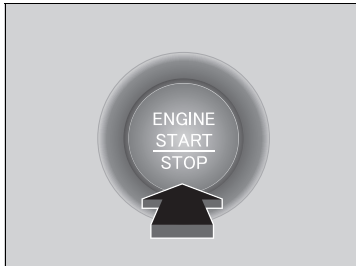

2. Depress the brake pedal and press the **ENGINE START/STOP** button within 10 seconds after the beeper sounds and the **ENGINE START/STOP** button changes from flashing to on.

▶ If you don't depress the pedal, the mode will change to ACCESSORY.

Emergency Engine Stop

The **ENGINE START/STOP** button may be used to stop the engine due to an emergency situation even while driving. If you must stop the engine, do either of the following operations:

- Press and hold the **ENGINE START/STOP** button for about two seconds.
- Firmly press the **ENGINE START/STOP** button three times.

The steering wheel will not lock. However, because turning off the engine disables the power assist the engine provides to the steering and braking systems, it will require significantly more physical effort and time to steer and slow the vehicle. Use both feet on the brake pedal to slow down the vehicle and stop immediately in a safe place.

The gear position automatically changes to **P** after the vehicle comes to a complete stop.

U.S. models

Then, the power mode changes to VEHICLE OFF.

Canadian models

Then, press the **ENGINE START/STOP** button twice without depressing the brake pedal to change the mode to VEHICLE OFF.

Emergency Engine Stop

Do not press the **ENGINE START/STOP** button while driving unless it is absolutely necessary for the engine to be turned off.

If you press the **ENGINE START/STOP** button while driving, the beeper sounds.

Jump Starting Procedure

Turn off the power to electric devices, such as audio and lights. Turn off the engine, then open the hood.

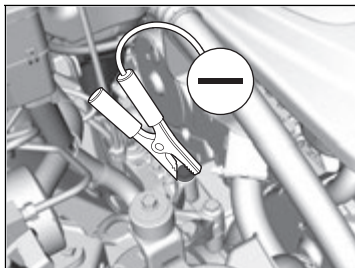
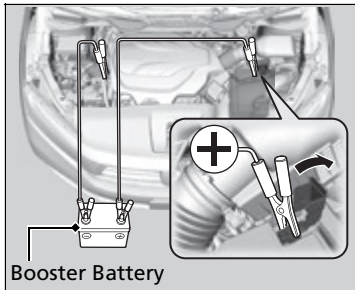

1. Connect the first jumper cable to your vehicle's battery \oplus terminal.
2. Connect the other end of the first jumper cable to the booster battery \oplus terminal.
 - ▶ Use a 12-volt booster battery only.
 - ▶ When using an automotive battery charger to boost your 12-volt battery, select a lower charging voltage than 15-volt. Check the charger manual for the proper setting.
3. Connect the second jumper cable to the booster battery \ominus terminal.
4. Connect the other end of the second jumper cable to the engine mounting bolt as shown. Do not connect this jumper cable to any other part.
5. If your vehicle is connected to another vehicle, start the assisting vehicle's engine and increase its rpm slightly.
6. Attempt to start your vehicle's engine. If it turns over slowly, check that the jumper cables have good metal-to-metal contact.

If the Battery Is Dead

⚠ WARNING

A battery can explode if you do not follow the correct procedure, seriously injuring anyone nearby.

Keep all sparks, open flames, and smoking materials away from the battery.

Securely attach the jumper cables clips so that they do not come off when the engine vibrates. Also, be careful not to tangle the jumper cables or allow the cable ends to touch each other while attaching or detaching the jumper cables.

Battery performance degrades in cold conditions and may prevent the engine from starting.

■ What to Do After the Engine Starts

Once your vehicle's engine has started, remove the jumper cables in the following order.

1. Disconnect the jumper cable from your vehicle's engine mounting bolt.
2. Disconnect the other end of the jumper cable from the booster battery ⊖ terminal.
3. Disconnect the jumper cable from your vehicle's battery ⊕ terminal.
4. Disconnect the other end of the jumper cable from the booster battery ⊕ terminal.

Have your vehicle inspected by a nearby service station or a dealer.

How to Handle Overheating

Overheating symptoms are as follows:

- The temperature gauge pointer is at the **H** mark or the engine suddenly loses power.
- The **Stop Driving When Safe. Engine Temperature Too Hot** message appears on the driver information interface.
- Steam or spray comes out of the engine compartment.

■ First thing to do

1. Immediately park the vehicle in a safe place.
2. Turn off all accessories and turn on the hazard warning lights.
 - ▶ **No steam or spray present:** Keep the engine running and open the hood.
 - ▶ **Steam or spray is present:** Turn off the engine and wait until it subsides. Then, open the hood.

🔧 How to Handle Overheating

⚠️ WARNING

Steam and spray from an overheated engine can seriously scald you.

Do not open the hood if steam is coming out.

NOTICE

Continuing to drive with the temperature gauge pointer at the **H** mark may damage the engine.

Continuing to drive with the **Stop Driving When Safe. Engine Temperature Too Hot** message on the driver information interface may damage the engine.

■ Next thing to do

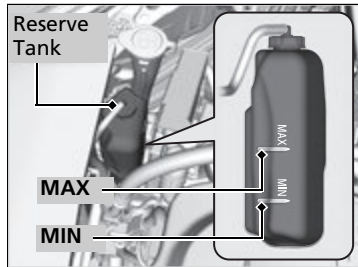

1. Check that the cooling fan is operating and stop the engine once the temperature gauge pointer goes down.
 - If the cooling fan is not operating, immediately stop the engine.
2. Once the engine has cooled down, inspect the coolant level and check the cooling system components for leaks.
 - If the coolant level in the reserve tank is low, add coolant until it reaches the **MAX** mark.
 - If there is no coolant in the reserve tank, check that the radiator is cool. Cover the radiator cap with a heavy cloth and open the cap. If necessary, add coolant up to the base of the filler neck and put the cap back on.

➤ **Radiator** P. 682

■ Last thing to do

Once the engine has cooled sufficiently, restart it and check the temperature gauge. If the temperature gauge pointer has gone down, resume driving. If it has not gone down, contact a dealer for repairs.

► How to Handle Overheating

⚠ WARNING

Removing the radiator cap while the engine is hot can cause the coolant to spray out, seriously scalding you.

Always let the engine and radiator cool down before removing the radiator cap.

If the coolant is leaking, contact a dealer for repairs.

Use water as an emergency/temporary measure only. Have a dealer flush the system with proper antifreeze as soon as possible.

If the Low Oil Pressure Warning Appears

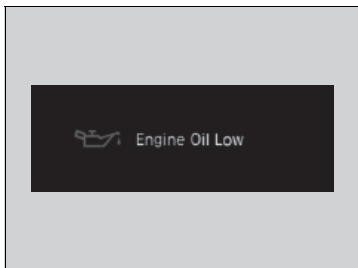

■ Reasons for the warning to appear

Appears when the engine oil pressure is low.

■ What to do as soon as the warning appears

1. Immediately park the vehicle on level ground in a safe place.
2. If necessary, turn the hazard warning lights on.

■ What to do after parking the vehicle

1. Stop the engine and let it sit for approximately three minutes.
 - ▶ Add oil as necessary.
 - **Oil Check** P. 677
3. Start the engine and check the low oil pressure warning.
 - ▶ The warning disappears: Start driving again.
 - ▶ The warning does not disappear within 10 seconds: Immediately stop the engine and contact a dealer for repairs.

☒ If the Low Oil Pressure Warning Appears

NOTICE

Running the engine with low oil pressure can cause serious mechanical damage almost immediately.

If the Charging System Indicator Comes On



■ Reasons for the indicator to come on

Comes on when the battery is not being charged.

■ What to do when the indicator comes on

Turn off the climate control system, rear defogger, and other electrical systems, and immediately contact a dealer for repairs.

If the Malfunction Indicator Lamp Comes On or Blinks



■ Reasons for the indicator lamp to come on or blink

- Comes on when there is a problem with the engine emissions control system.
- Blinks when engine misfiring is detected.

■ What to do when the indicator lamp comes on

Avoid high speeds and immediately get your vehicle inspected at a dealer.

■ What to do when the indicator lamp blinks

Park the vehicle in a safe place with no flammable items and wait at least 10 minutes or more with the engine stopped until it cools.

▶▶ If the Charging System Indicator Comes On

If you need to stop temporarily, do not turn off the engine. Restarting the engine may rapidly discharge the battery.

▶▶ If the Malfunction Indicator Lamp Comes On or Blinks

NOTICE

If you drive with the malfunction indicator lamp on, the emissions control system and the engine could be damaged.

If the malfunction indicator lamp blinks again when restarting the engine, drive to the nearest dealer at 31 mph (50 km/h) or less. Have your vehicle inspected.

If the Brake System Indicator (Red) Comes On or Blinks



■ Reasons for the indicator to come on

- The brake fluid is low.
- There is a malfunction in the brake system.

■ What to do when the indicator comes on while driving

Depress the brake pedal lightly to check pedal pressure.

- If normal, check the brake fluid level the next time you stop.
- If abnormal, take immediate action. If necessary, downshift the transmission to slow the vehicle using engine braking.

■ Reasons for the indicator to blink

- There is a problem with the electric parking brake system.

■ What to do when the indicator blinks

- Avoid using the parking brake and have your vehicle checked by a dealer immediately.

☒ If the Brake System Indicator (Red) Comes On or Blinks

Have your vehicle repaired immediately. It is dangerous to drive with low brake fluid. If there is no resistance from the brake pedal, stop immediately in a safe place. If necessary downshift the gears.

If the brake system indicator (red) and **ABS** indicator come on simultaneously, the electronic brake distribution system is not working. This can result in vehicle instability under sudden braking. Have your vehicle inspected by a dealer immediately.

If the brake system indicator (red) blinks at the same time when the brake system indicator (amber) comes on, the parking brake may not work. Avoid using the parking brake and have your vehicle checked by a dealer immediately.

- ☒ **If the Brake System Indicator (Red) Comes On or Blinks at the Same Time When the Brake System Indicator (Amber) Comes On**
P. 742

If the Brake System Indicator (Red) Comes On or Blinks at the Same Time When the Brake System Indicator (Amber) Comes On

⚠ If the Brake System Indicator (Red) Comes On or Blinks at the Same Time When the Brake System Indicator (Amber) Comes On

If you apply the parking brake, you may not be able to release it.

If the brake system indicator (red) and the brake system indicator (amber) come on at the same time, the parking brake is working.

If the brake system indicator (red) blinks at the same time when the brake system indicator (amber) comes on, the parking brake may not work because it is checking the system.

If you repeatedly operate the electric parking brake in a short period of time, the brake stops operating to prevent heating of the system and the indicator blinks.

It returns to its original state in approximately one minute.



■ If the brake system indicator (red) comes on or blinks at the same time when the brake system indicator (amber) comes on, release the parking brake manually or automatically

🔧 Parking Brake P. 638

• If the brake system indicator (red) continuously comes on or blinks at the same time when the brake system indicator (amber) comes on, stop the vehicle in a safe place and have it inspected by a dealer immediately.

▶ Preventing the vehicle from moving, put the transmission into **P**.



• If only the brake system indicator (red) is turned off, avoid using the parking brake and have your vehicle checked by a dealer immediately.

If the Electric Power Steering (EPS) System Indicator Comes On



■ Reasons for the indicator to come on

Comes on when there is a problem with the EPS system.

■ What to do when the indicator comes on

Stop the vehicle in a safe place and restart the engine.

If the indicator comes on and stays on, immediately have your vehicle inspected by a dealer.

If the Low Tire Pressure/TPMS Indicator Comes On or Blinks



■ Reasons for the indicator to come on or blink

A tire pressure is significantly low. If there is a problem with the TPMS with Tire Fill Assist or the compact spare tire is installed, the indicator blinks for about one minute, and then stays on.

■ What to do when the indicator comes on

Drive carefully and avoid abrupt cornering and hard braking.

Stop your vehicle in a safe place. Check the tire pressure and adjust the pressure to the specified level. The specified tire pressure is on a label on the driver side doorjamb.

■ What to do when the indicator blinks, then remains on

Have the tire inspected by a dealer as soon as possible. If the compact spare tire causes the indicator to blink, change the tire to a full-size tire. The indicator goes off after driving for a few miles (kilometers).

▶▶ If the Low Tire Pressure/TPMS Indicator Comes On or Blinks

NOTICE

Driving on an extremely underinflated tire can cause it to overheat. An overheated tire can fail. Always inflate your tires to the prescribed level.

TPMS with Tire Fill Assist provides visual and audible assistance during tire pressure adjustment. With the power mode in ON, while you adjust tire pressure up or down, the system alerts you as follows:

Below recommended pressure: The beeper sounds and exterior lights flash once every five seconds.

At recommended pressure: The beeper sounds and exterior lights flash rapidly for three seconds with five seconds intervals.

Above recommended pressure: The beeper sounds and lights flash twice every two seconds.

If the Transmission System Indicator Blinks along with the Warning Message

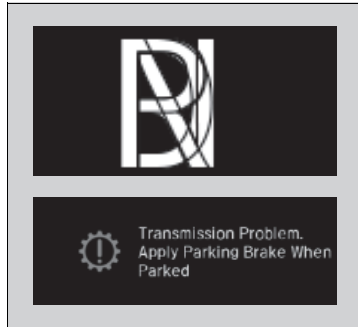

■ Reasons for the indicator to blink

The transmission is malfunctioning.

■ What to do when the indicator blinks

- Immediately have your vehicle inspected by a dealer.
- Change the gear position to **[N]** after starting the engine.
 - ▶ Check if the **[N]** position in the instrument panel and the indicator on the **[N]** button light/blink.
 - **Starting the Engine** P. 550

ⓘ If the Transmission System Indicator Blinks along with the Warning Message

You may not be able to turn on the engine.

Make sure to set the parking brake when parking your vehicle.

Call a professional towing service if you need to tow your vehicle.

➤ **Emergency Towing** P. 752

Fuse Locations

If any electrical devices are not working, set the power mode to VEHICLE OFF and check to see if any applicable fuse is blown.

■ Engine Compartment Fuse Box

■ Fuse box A

Located at the rear end of the engine compartment on the right side. Push the tabs to open the box.

Fuse locations are shown on the fuse box cover. Locate the fuse in question by the fuse number and box cover number.

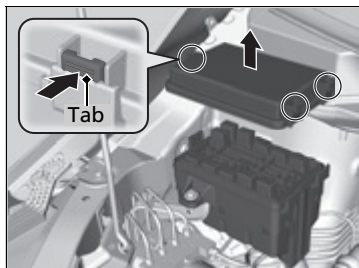

■ Circuit protected and fuse rating

	Circuit Protected	Amps
1	–	–
2	–	–
3	–	–
4	IG1 VB SOL	10 A
5	VSA/ABS	5 A
6	Wiper	30 A
7	IG1 DBW	15 A
8	TCU	15 A
9	IGP1	15 A
10	Sub Fan Motor	30 A
11	Rear Driver's Side Power Window	30 A
12	Ignition Coil/Injector	30 A
13	TCU 2	10 A
14	TCU 3	10 A
15	PDM LT2	30 A
16	ST CUT	30 A
17	Shutter Grill	(10 A)
18	Back Up	10 A
19	Stop*	(10 A)
20	PDM LT1	30 A
21	Rear Passenger's Side Power Window	30 A
22	ACM	30 A
23	Hazard	15 A
24	Washer	15 A

	Circuit Protected	Amps
25	Main Fan Motor	30 A
26	STRLD	5 A
27	IGPS	5 A
28	Stop	(10 A)
29	Right Headlight Low Beam	10 A
30	Left Headlight Low Beam	10 A
31	Injector	20 A
32	Ignition Coil	15 A
33	FET Module	5 A

* Not available on all models

■ Fuse box B

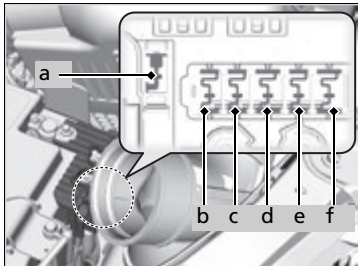
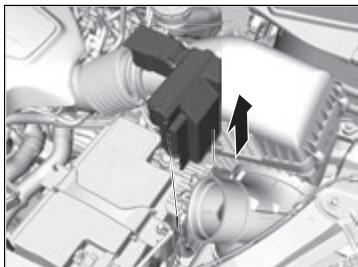

Handling the Unexpected

1. Remove the engine compartment cover and the air intake duct.
 - ❑ Engine Compartment Cover P. 675
 - ❑ Checking the Battery P. 706
2. Remove the cover on the ⊕ terminal (as shown).
Replacement of engine compartment fuses should be done by a dealer.

■ Circuit protected and fuse rating

	Circuit Protected	Amps
a	Battery Main	150 A
b	FET	70 A
c	R/B Main 1	70 A
d	R/B Main 2	70 A
e	EPS	70 A
f	VAC*	60 A

■ Driver's Side Interior Fuse Box

Located under the dashboard.

■ Fuse box A

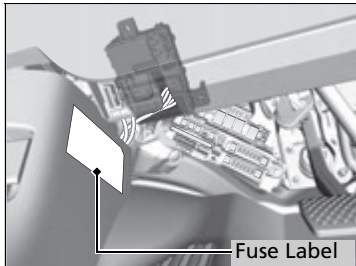

Fuse locations are shown on the label on the side panel.

Locate the fuse in question by the fuse number and label number.

■ Circuit protected and fuse rating

	Circuit Protected	Amps
1	Meter	10 A
2	Starter Motor	(10 A)
3	Option	10 A
4	–	–
5	–	–
6	Moonroof*	(20 A)
7	–	–
8	Rear Fuse Box	10 A
9	IG1 Front	15 A
10	Rear Passenger's Door Lock	10 A
11	Driver's Door Lock	10 A
12	Front Passenger's Door Lock	10 A
13	Front Passenger's Door Unlock	10 A
14	Driver's Door Unlock	(10 A)
15	Rear Wiper	10 A
16	SMART	10 A
17	Driver's Power Seat Reclining	20 A
18	Heated Steering Wheel*	(10 A)
19	Front Passenger's Power Seat Reclining	20 A
20	SRS	10 A
21	Fuel Pump	20 A

	Circuit Protected	Amps
22	Front Accessory Power Socket	20 A
23	Left Headlight High Beam	10 A
24	Right Headlight High Beam	10 A
25	Driver's Power Window	20 A
26	Rear Passenger's Door Unlock	10 A
27	ACC	10 A
28	SRS2	10 A
29	Driver's Power Seat Lumbar Support*	(10 A)
30	Front Passenger's Power Seat Sliding	20 A
31	Driver's Power Seat Sliding	20 A
32	Tailgate Lock*	(10 A)
33	–	–
34	ACG	15 A
35	DRL	10 A
36	A/C	10 A
37	Radio	20 A ^{*1} 15 A ^{*2}
38	Door Lock Main	20 A
39	Front Passenger's Power Window	20 A

*1: Models with color audio system

*2: Models without color audio system

* Not available on all models

■ Fuse box B

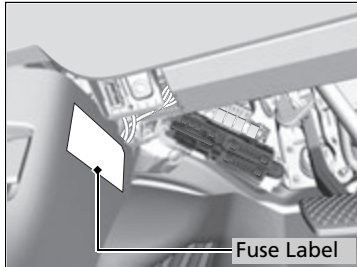

Handling the Unexpected

■ Circuit protected and fuse rating

	Circuit Protected	Amps
1	DC/DC2	(30 A)
	DC/DC1	(30 A)
	EBB	40 A
	Fuse Box Main1	50 A
	Fuse Box Main2	50 A
	Rear Fuse Box Main1	50 A
	Rear Fuse Box Main2	50 A
	Vacuum*	(60 A)
2	IG Main1	30 A
3	AC Outlet*	(30 A)
4	IG Main2	30 A
5	–	–
6	Rear Blower	30 A
7	Audio Amp2*	(20 A)
8	Audio Amp1*	(20 A)
9	Rear Defogger	40 A
10	–	–
11	Heated Windshield*	(15 A)
12	BMS	5 A
13	Audio Amp3*	(30 A)
14	Front Passenger's Power Seat Lumbar Support*	(10 A)
15	–	–
16	VSA Motor	40 A
17	Front Blower	40 A

	Circuit Protected	Amps
18	–	–
19	Horn	10 A
20	–	–
21	3rd Row Accessory Power Socket*	(20 A)
22	Shift By Wire	10 A
23	VBUM	10 A
24	VSA	40 A

■ Fuse box C

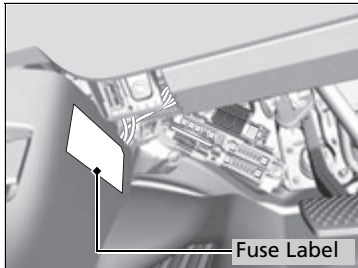

■ Circuit protected and fuse rating

	Circuit Protected	Amps
a	Meter	(10 A)
b	VSA	(10 A)
c	ACG	(10 A)
d	Body Control Module	(10 A)
e	RADIO* ¹ _ * ²	20 A _
f	Back Up	(10 A)
g	ACC	(10 A)

* 1: Models with color audio system

* 2: Models without color audio system

■ Rear Side Interior Fuse Box

Located on the left side of cargo area. Take off the cover to open.

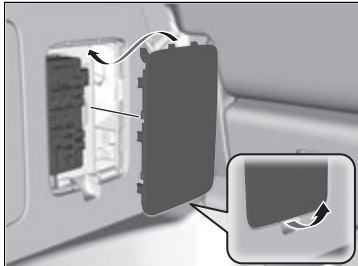

Fuse locations are shown on the fuse box cover.

Locate the fuse in question by the fuse number and box cover number.

■ Circuit protected and fuse rating

	Circuit Protected	Amps
1	Rear Driver's Side Door Lock	10 A
2	Passenger's Side Power Sliding Door Closer*	(20 A)
3	Power Tailgate Closer Motor*	(20 A)
4	Cargo Area's Accessory Power Socket	20 A
5	Fuel Fill Door	10 A
6	USB*	(5 A)
7	Driver's Side Power Sliding Door Closer*	(20 A)
8	–	–
9	–	–
10	–	–
11	–	–
12	–	–
13	–	–
14	Passenger's Side Power Sliding Door Motor*	(30 A)
15	–	–
16	Power Tailgate Motor*	(40 A)
17	–	–
18	–	–
19	Driver's Side Power Sliding Door Motor*	(30 A)

Inspecting and Changing Fuses

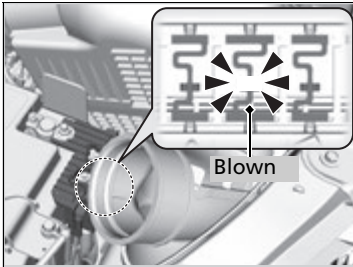

Fuse Box on the Battery

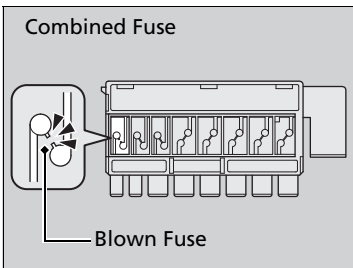
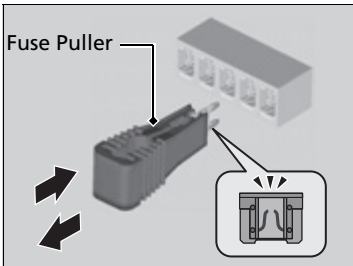

1. Set the power mode to VEHICLE OFF. Turn headlights and all accessories off.
2. Check the fuses on the battery in the engine compartment.
 - ▶ If the fuse is blown, have it replaced by a dealer.
3. Remove the fuse box cover.
4. Inspect the small fuses in the engine compartment and the vehicle interior.
 - ▶ If there is a blown fuse, remove it with the fuse puller and replace it with a new one.
5. Check the large fuse in the vehicle interior.
 - ▶ If the fuse is blown, use a Phillips-head screwdriver to remove the screw and replace it with a new one.

Inspecting and Changing Fuses

NOTICE

Replacing a fuse with one that has a higher rating greatly increases the chances of damaging the electrical system.

Use the charts to locate the fuse in question and confirm the specified amperage on the fuse label.

➤ **Fuse Locations** P. 745

Replace fuses with a spare fuse of the same specified amperage.

There is a fuse puller on the back of the engine compartment fuse box cover.

Call a professional towing service if you need to tow your vehicle.

■ Flat bed equipment

The operator loads your vehicle on the back of a truck.

This is the only way you can safely transport your vehicle.

Any other towing method will damage the vehicle's drive system.

» Emergency Towing

NOTICE

Trying to lift or tow your vehicle by the bumpers will cause serious damage. The bumpers are not designed to support the vehicle's weight.

NOTICE

Improper towing such as towing behind a motorhome or other motor vehicle can damage the transmission.

Never tow your vehicle with just a rope or chain. It is very dangerous since ropes or chains may shift from side to side or break.

■ What to Do If Unable to Unlock the Fuel Fill Door

If you cannot unlock the fuel fill door, use the following procedure.

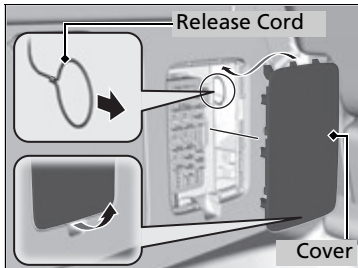

1. Open the tailgate and remove the cover on the left side of cargo area.
2. Pull the yellow release cord (as shown).
 - ▶ The release cord opens the fuel fill door when it is pulled.

▣ What to Do If Unable to Unlock the Fuel Fill Door

After taking these steps, contact a dealer to have the vehicle checked.

What to Do If Unable to Open the Tailgate

If you cannot open the tailgate or power tailgate, use the following procedure.

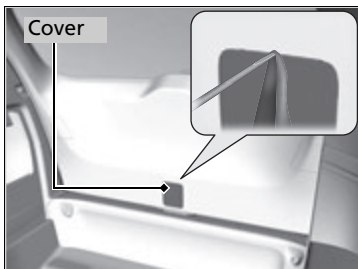

1. Use a flat-tip screwdriver and remove the cover on the back of the tailgate.
 - ▶ Wrap the flat-tip screwdriver with a cloth to prevent scratches.

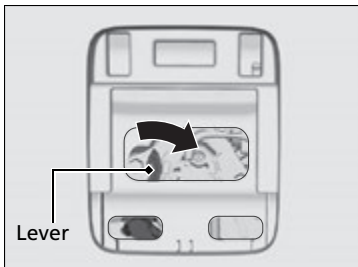

Models with power tailgate

2. To open the tailgate, push the tailgate while pushing the lever to the right.

What to Do If Unable to Open the Tailgate

Following up:

After taking these steps, contact a dealer to have the vehicle checked.

When you open the tailgate from inside, make sure there is enough space around the tailgate, and it does not hit anyone or any object.

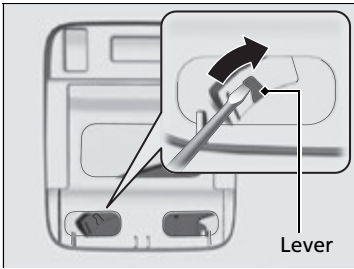

Models without power tailgate

2. To open the tailgate, push the tailgate while pushing the lever to the right with the flat-tip screwdriver.

When You Cannot Close the Power Sliding Doors*

When You Cannot Close the Power Sliding Doors*

What to Do When Unable to Close the Power Sliding Doors

If either power sliding door does not latch when closed, use the following procedure.

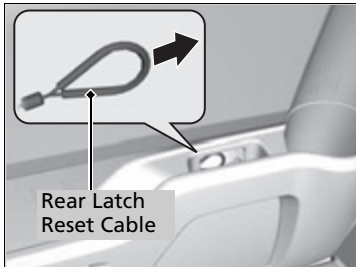
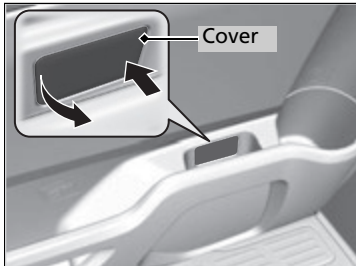

1. Set the sliding door main switch in the OFF position.
 - **Switching between manual and automatic operations** P. 185
2. Push front edge of the cover on hand pocket of the power sliding door to pop it out, and remove it as shown in the image.
3. Pull the rear latch reset cable (yellow) towards the front of the vehicle until it bottoms out (about 9/16 inch [15 mm]).
4. Manually close the door and confirm latches engage.

After taking these steps, contact a dealer to have your vehicle checked.

Refueling From a Portable Fuel Container

If you have run out of fuel and need to refuel your vehicle from a portable fuel container, use the funnel provided with your vehicle.

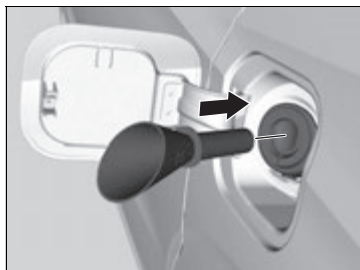
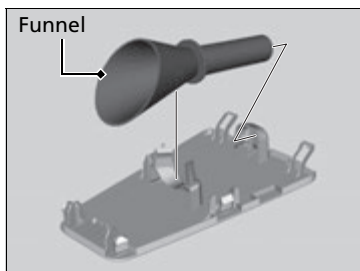
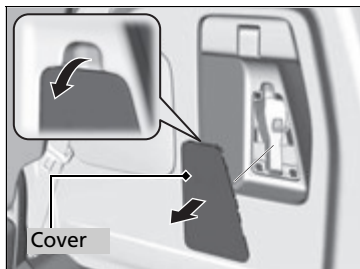

1. Turn off the engine.
2. Press on the edge of the fuel fill door to make it pop up slightly.
 - ▶ The fuel fill door opens.
3. Remove the cover on the right side panel of the cargo area.

4. Pick up the funnel from the cover (as shown).

🔧 **Types of Tools** P. 722

5. Place the end of the funnel on the lower part of filler opening, then insert it slowly and fully.
 - ▶ Make sure that the end of the funnel goes down along with the filler pipe.

⚠ Refueling From a Portable Fuel Container

⚠ WARNING

Fuel is highly flammable and explosive. You can be burned or seriously injured when handling fuel.

- Stop the engine, and keep heat, sparks, and flame away.
- Handle fuel only outdoors.
- Wipe up spills immediately.

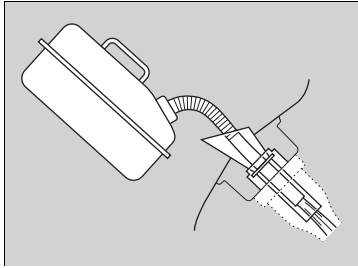

6. Fill the tank with fuel from the portable fuel container.
 - ▶ Pour fuel carefully so you do not spill any.
7. Remove the funnel from the filler neck.
 - ▶ Wipe up any fuel from the funnel before storing it.
8. Shut the fuel fill door by hand.

▶▶ Refueling From a Portable Fuel Container

NOTICE

Do not insert the nozzle of a portable fuel container or any funnel other than the one provided with your vehicle. Doing so can damage the fuel system. Do not try to pry open or push open the sealed fuel tank with foreign objects. This can damage the fuel system and its seal.

Make sure the fuel in the portable fuel container is gasoline before you refuel.

Information

This chapter includes your vehicle's specifications, locations of identification numbers, and other information required by regulation.

Specifications	760
Identification Numbers	
Vehicle Identification Number (VIN), Engine Number, and Transmission Number	762
Devices that Emit Radio Waves	763
Reporting Safety Defects	764
Emissions Testing	
Testing of Readiness Codes	765
Warranty Coverages	767
Authorized Manuals	770
Customer Service Information	771

■ Vehicle Specifications

Model	Odyssey
No. of Passengers:	
Front	2
Rear	2nd Row 3 (2 ¹)
	3rd Row 3
Total	8 (7 ¹)
Weights:	
Gross Vehicle Weight Rating	See the certification label on the driver's doorjamb
Gross Axle Weight Rating (Front)	See the certification label on the driver's doorjamb
Gross Axle Weight Rating (Rear)	See the certification label on the driver's doorjamb
Gross Combined Weight Rating	
Rating	U.S.: 8,565 lbs (3,885 kg) Canada: 3,885 kg

*1: Models without second row center seat

■ Air Conditioning

Refrigerant Type	HFO-1234yf (R-1234yf)
Charge Quantity	20.3 - 22.0 oz (575 - 625 g)
Lubricant Type	ND-OIL14 (POE)
Quantity	7.3 - 8.2 cu-in (120 - 135 cm ³)

■ Engine Specifications

Displacement	212 cu-in (3,471 cm ³)
Spark Plugs	NGK DILZKR7B11G

■ Fuel

Fuel:	Unleaded gasoline, Pump octane number
Type	of 87 or higher
Fuel Tank Capacity	19.5 US gal (73.8 L)

■ Washer Fluid

Tank Capacity	U.S.: 2.6 US qt (2.5 L) Canada: 4.8 US qt (4.5 L)
---------------	--

■ Light Bulbs

Headlights (Low Beam)	LED
Headlights (High Beam)	LED
Fog Lights*	LED
Front Turn Signal Lights	28/8W (Amber)
Front Side Marker Lights	3CP
Parking/Daytime Running Lights	LED
Side Turn Signal Lights* (on Door Mirrors)	LED
Brake Lights	21W
Rear Side Marker/Taillights	LED
Rear Turn Signal Lights	21W
Back-Up Lights	21W
Taillights	LED
High-Mount Brake Light	LED
Rear License Plate Light	LED
Interior Lights	
Front Map Lights	5W
Rear Map Lights	5W
Cargo Area Light	8W
Vanity Mirror Lights	1.4W
Door Courtesy Lights	3.8W (2CP)
Glove Box Light	1.4W
Foot Lights*	LED
Console Compartment Light*	1.4W
Door Inner Handle Lights*	LED
Door Tray Ambient Lights*	LED
Instrument Panel Ambient Lights*	LED
Pass Through Light*	LED

■ Brake Fluid

Specified	Honda Heavy Duty Brake Fluid DOT 3
-----------	------------------------------------

■ Automatic Transmission Fluid

Specified	Honda ATF-Type 2
-----------	------------------

■ Engine Oil

Recommended	-Genuine Honda Motor Oil 0W-20	
	-API Premium-grade 0W-20 detergent oil	
Change	5.4 US qt (5.1 L)	
	Capacity	
Capacity	Change including filter	5.7 US qt (5.4 L)

■ Engine Coolant

Specified	Honda Long-Life Antifreeze/Coolant Type2	
Ratio	50/50 with distilled water	
Capacity	1.69 US gal (6.38 L)	
	(change including the remaining 0.19 US gal (0.73 L) in the reserve tank)	

■ Tire

Regular	Size*1	235/60R18 103H 235/55R19 101H
	Pressure psi (kPa [kgf/cm ²])	35 (240 [2.4]) ^{*2} 36 (250 [2.5]) ^{*3}
Compact Spare	Size	T135/80D17 103M
	Pressure psi (kPa [kgf/cm ²])	60 (420 [4.2])
Wheel Size	Regular	18 x 7 1/2J ^{*2} 19 x 7 1/2J ^{*3}
	Compact Spare	17 x 4T

*1: Original tire size is mentioned on the tire information label on the driver's doorjamb.

*2: Models with 235/60R18 tires

*3: Models with 235/55R19 tires

Vehicle Identification Number (VIN), Engine Number, and Transmission Number

Your vehicle has a 17-digit vehicle identification number (VIN) used to register your vehicle for warranty purposes, and for licensing and insuring your vehicle. The locations of your vehicle's VIN, engine number, and transmission number are shown as follows:

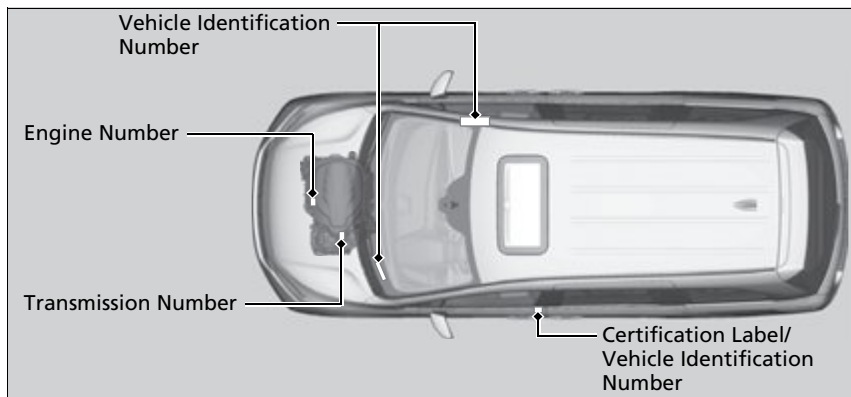

Vehicle Identification Number (VIN), Engine Number, and Transmission Number



The interior vehicle identification number (VIN) is located under the cover.

Each radio frequency device installed in the vehicle conforms to the requirements and standards of the regulation listed below:

As required by the FCC:

This device complies with Part 15 of the FCC rules. Operation is subject to the following two conditions: (1) This device may not cause harmful interference, and (2) this device must accept any interference received, including interference that may cause undesired operation.

Changes or modifications not expressly approved by the party responsible for compliance could void the user's authority to operate the equipment.

This device complies with Industry Canada licence-exempt RSS standard(s).

Operation is subject to the following two conditions: (1) this device may not cause interference, and (2) this device must accept any interference, including interference that may cause undesired operation of the device.

In the U.S.

If you believe that your vehicle has a defect which could cause a crash or could cause injury or death, you should immediately inform the National Highway Traffic Safety Administration (NHTSA) in addition to notifying American Honda Motor Co., Inc.

If NHTSA receives similar complaints, it may open an investigation, and if it finds that a safety defect exists in a group of vehicles, it may order a recall and remedy campaign. However, NHTSA cannot become involved in individual problems between you, your dealer, or American Honda Motor Co., Inc.

To contact NHTSA, you may call the Vehicle Safety Hotline toll-free at 1-888-327-4236 (TTY: 1-800-424-9153); go to <http://www.safercar.gov>; or write to: Administrator, NHTSA, 1200 New Jersey Avenue, SE., Washington, DC 20590. You can also obtain other information about motor vehicle safety from <http://www.safercar.gov>.

In Canada

If you believe that your vehicle has a defect which could cause a crash or could cause injury or death, you should immediately inform Honda Canada Inc. and you may also inform Transport Canada.

If Transport Canada receives similar complaints, it may open an investigation, and if it finds that a safety defect exists in a group of vehicles, it may lead to a recall and remedy campaign. However, Transport Canada cannot become involved in individual problems between you, your dealer, or Honda Canada Inc.

To contact Transport Canada's Defect Investigations and Recalls Division, you may call 1-800-333-0510. For more information on reporting safety defects or about motor vehicle safety, go to <http://www.tc.gc.ca/roadsafety>.

Testing of Readiness Codes

Your vehicle has readiness codes as part of the onboard self diagnostic system.

Some states use these codes for testing to verify whether your vehicle's emissions components are working properly.

The codes may not be read properly if testing is performed just after the battery has gone dead or been disconnected.

To check if they are set, set the power mode to ON, without starting the engine. The malfunction indicator lamp will come on for several seconds. If it then goes off, the readiness codes are set. If it blinks five times, the readiness codes are not set.

If you are required to have your vehicle tested before the readiness codes are ready, prepare the vehicle for retesting by doing the following:

1. Fill the gas tank to approximately 3/4 full.
2. Park the vehicle and leave the engine off for 6 hours or more.
3. Make sure the ambient temperature is between 40°F and 95°F (4°C and 35°C).
4. Start the engine without touching the accelerator pedal, and let it idle for 20 seconds.
5. Keep the vehicle in **P**. Increase the engine speed to 2,000 rpm, and hold it there for about 3 minutes.
6. Let the engine idle with your foot off the accelerator for 20 seconds.

Testing of Readiness Codes

The readiness codes are erased when the battery is disconnected, and set again only after several days of driving under a variety of conditions.

If a testing facility determines that the readiness codes are not set, you may be requested to return at a later date to complete the test.

If the testing facility determines the readiness codes are still not set, see a dealer.

7. Select a nearby, lightly traveled major highway where you can maintain a speed of 50 to 60 mph (80 to 97 km/h) for at least 20 minutes. Drive on the highway in **D**. Do not use cruise control. When traffic allows, drive for 90 seconds without moving the accelerator pedal. (Vehicle speed may vary slightly; this is okay.) If you cannot do this for a continuous 90 seconds because of traffic conditions, drive for at least 30 seconds, then repeat it two more times (for a total of 90 seconds).
8. Drive in city or suburban traffic for at least 10 minutes. When traffic conditions allow, let the vehicle coast for several seconds without using the accelerator pedal or the brake pedal.
9. Park the vehicle and leave the engine off for 30 minutes.

■ U.S. Owners

Your new vehicle is covered by these warranties:

New Vehicle Limited Warranty – covers your new vehicle, except for the emissions control systems and accessories, against defects in materials and workmanship.

Emissions Control Systems Defects Warranty and Emissions Performance Warranty – these two warranties cover your vehicle's emissions control systems. Time, mileage, and coverage are conditional. Please read your warranty booklet for exact information.

Seat Belt Limited Warranty – a seat belt that fails to function properly is covered by a limited warranty. Please read your warranty booklet for details.

Rust Perforation Limited Warranty – all exterior body panels are covered against rusting from the inside out for the specified time period, regardless of mileage.

Accessory Limited Warranty – Honda accessories are covered under this warranty. Time and mileage limits depend on the type of accessory and other factors. Please read your warranty booklet for details.

Replacement Parts Limited Warranty – covers all Honda replacement parts against defects in materials and workmanship.

Replacement Battery Limited Warranty – provides prorated coverage for a replacement battery purchased from a dealer.

Replacement Muffler Lifetime Limited Warranty – provides coverage for as long as the purchaser of the muffler owns the vehicle.

Restrictions and exclusions apply to all these warranties. Please read the Honda warranty information booklet that came with your vehicle for precise information on warranty coverages. Your vehicle's original tires are covered by their manufacturer. Tire warranty information is in a separate booklet.

■ **Statement on Warranty Coverage for Aftermarket and Recycled Parts**

The Magnuson-Moss Warranty Act, 15 U.S.C. s.2301 et seq., makes it illegal for motor vehicle manufacturers to void a motor vehicle warranty or deny warranty coverage solely because an aftermarket or recycled part has been used to repair the vehicle or someone other than the authorized service provider performed service on the vehicle. This provision does not apply to a new motor vehicle purchased solely for commercial or industrial use.

Under federal law, a manufacturer may deny warranty coverage and charge for repairs to a vehicle if it is discovered that an aftermarket or recycled part installed on the vehicle is defective or was installed incorrectly and caused damage to another part of the vehicle otherwise covered under warranty. The Federal Trade Commission requires that a manufacturer demonstrate that an aftermarket or recycled part or service performed by a person other than an authorized service provider caused damage to another part of the vehicle otherwise covered under warranty before denying warranty coverage. Additionally, federal law allows a manufacturer to void a motor vehicle warranty or deny warranty coverage if the manufacturer provides the article or service to consumers free of charge under the warranty or the manufacturer has secured a waiver from the Federal Trade Commission.

■ **Canadian Owners**

Please refer to the warranty manual that came with your vehicle.

■ **EPA Contact Information**

An owner may obtain further information concerning emission warranties or report violations of the terms of the emission warranties by contacting:

Director,
Light-Duty Vehicle Center,
U.S. Environmental Protection Agency,
Attention: Warranty Claim
2000 Traverwood Drive,
Ann Arbor, MI 48105;
complianceinfo@epa.gov

■ Service Express

For electronic copies of service publications, you can purchase a subscription to Service Express. Visit www.techinfo.honda.com for pricing and options.

■ For U.S. Owners

Manuals can be purchased from Helm Incorporated. You can order a manual by phone at 1 (800) 782-4356 (credit card orders only), or online at www.helminc.com.

■ For Canadian Owners

Please contact a dealer to order any manuals that you may require.

Honda dealership personnel are trained professionals who should be able to deal with any problems you may encounter with your vehicle. If, however, you are faced with a problem that they cannot resolve to your satisfaction, contact Honda Customer Services.

U.S. Owners

American Honda Motor Co., Inc.
Honda Automobile Customer Services
Mail Stop CHI-5
1919 Torrance Blvd.
Torrance, CA 90501-2746
Tel: 1 (800) 999-1009

Canadian Owners

Honda Canada Inc.
Customer Relations
180 Honda Boulevard
Markham, ON
L6C 0H9
Tel: 1-888-9-HONDA-9
Fax: 1-877-939-0909
E-mail: Honda_cr@ch.honda.com

In Puerto Rico and the U.S. Virgin Islands

Bella International
P.O. Box 190816
San Juan, PR 00919-0816
Tel: 1 (787) 620-7546

Customer Service Information

When you call or write, please give us the following information:

- Vehicle Identification Number
 - ▣ **Vehicle Identification Number (VIN), Engine Number, and Transmission Number P. 762**
- Date of purchase
- Odometer reading of your vehicle
- Your name, address, and telephone number
- A detailed description of the problem
- Name of the dealer who sold the vehicle to you

A

- ABS (Anti-lock Brake System)..... 644
- AC Power Outlet..... 252
- Accessories and Modifications..... 718
- Accessory Power Sockets..... 250
- Adaptive Cruise Control (ACC) with Low Speed Follow..... 600
- Additives
 - Coolant..... 681
 - Engine Oil..... 676
 - Washer..... 685
- Additives, Engine Oil..... 676
- Adjusting
 - Armrest..... 238
 - Front and Second Row Outer and Third Row Outer Head Restraints Positions..... 235
 - Front Seats..... 222
 - Mirrors..... 219
 - Second Row Seats..... 225
 - Steering Wheel..... 218
 - Third Row Seats..... 230
- Agile Handling Assist..... 576
- Air Conditioning System (Climate Control System)..... 260, 265
 - Changing the Mode..... 260, 265
 - Defrosting the Windshield and Windows..... 261, 267
 - Dust and Pollen Filter..... 711
 - Recirculation/Fresh Air Mode..... 260
 - Sensors..... 264, 271
 - Using Automatic Climate Control 260, 265
- Air Pressure..... 698, 761
- Airbags..... 49
 - Advanced Airbags..... 55
 - Airbag Care..... 66
 - Event Data Recorder..... 1
 - Front Airbags (SRS)..... 52
 - Indicator..... 63, 95
 - Knee Airbags..... 57
 - Passenger Airbag Off Indicator..... 64
 - Sensors..... 49
 - Side Airbags..... 60
 - Side Curtain Airbags..... 62
- AM/FM Radio..... 289, 333
- Android Auto..... 376
- Anti-lock Brake System (ABS)..... 644
 - Indicator..... 95
- Apple CarPlay..... 373
- Armrest..... 238
- AT&T Hotspot..... 371
- Audio Remote Controls..... 279
- Audio System..... 274
 - Adjusting the Sound..... 287, 327
 - Audio/Information Screen..... 283, 301
 - Auxiliary Input Jack..... 277
 - Display Setup..... 288, 328
 - Error Messages..... 380
 - File Manager..... 321
 - General Information..... 385
 - Home Screen..... 307
 - How to Delete a File..... 324
 - How to Transfer a File..... 321
- How to Update Wirelessly..... 315
- How to Update with a USB Device..... 319
- Limitations for Manual Operation..... 329
- MP3/WMA/AAC..... 294, 347, 353, 356
- My Honda Music..... 356
- Playing a CD..... 347
- Playing Social Playlist..... 362
- Reactivating..... 278
- Recommended CDs..... 386
- Remote Controls..... 279
- Security Code..... 278
- Selecting an Audio Source..... 329
- Status Area..... 312
- System Updates..... 315
- Theft Protection..... 278
- USB Flash Drives..... 388
- USB Ports..... 275
- Wallpaper Setup..... 285, 305
- Audio/Information Screen..... 283, 301
- Authorized Manuals..... 770
- Auto Door Locking/Unlocking..... 170
 - Customize..... 149, 477
- Auto High-Beam..... 207
 - Indicator..... 95
- Auto Idle Stop Indicator (Green)..... 100
- Auto Idle Stop OFF Indicator..... 100
- Auto Idle Stop Suspend Indicator..... 101
- Auto Idle Stop System Indicator (Amber)..... 100
- Automatic Brake Hold
 - Indicator..... 91

Automatic Brake Hold System			
Indicator	91		
Automatic Operation (automatic lighting control)	203		
Automatic Transmission	557		
Creeping.....	557		
Fluid	683		
Kickdown	557		
Shift Operation	560		
Shifting.....	558		
Auxiliary Input Jack	277		
Average Fuel Economy	133		
B			
Battery	706		
Charging System Indicator	92, 740		
If the Battery Is Dead.....	735		
Maintenance (Checking the Battery)	706		
Maintenance (Replacing).....	708, 709		
Belts (Seat)	40		
Beverage Holders	244		
Blank	139		
Blind spot information System	581		
Bluetooth® Audio	297, 360		
Bluetooth® HandsFreeLink®	485, 510		
Blu-ray/DVD Rear Entertainment System	409		
Audio Sources for Front and Rear Seats...	430		
Auxiliary Console Panels.....	411		
DVD or Blu-ray™ Player Error Messages...	455		
Front Control Panel Operation	422		
HDMI™ Port	412		
How Much Farther?™.....	429		
Media Servers.....	429		
Operating the System	413		
Overhead Screen	412		
Playable Disc Region Codes	453		
Playable Disc Types	453		
Playable Discs	431		
Playing a Disc in the Rear.....	427		
Playing a DVD/Blu-ray™.....	416		
Playing a Video Using the HDMI™	428		
Playing an iPod and a USB Flash Drive in the Rear.....	427		
Playing Apps.....	425		
Rear DVD or Blu-ray™ Menu.....	417		
Rear System Setup.....	423		
Recommended Discs.....	454		
Selecting the Audio Source using Front Control Panel	422		
Setting the DVD or Blu-ray™ Menu.....	424		
System Controls	416, 426		
System Settings	420		
Video Accessibility	414		
Wireless Headphones	410		
Booster Seats (For Children)	84		
Brake System	638		
Anti-lock Brake System (ABS).....	644		
Brake Assist System	645		
Fluid	684		
Foot Brake	641		
Indicator (Amber)	89, 90, 742		
Indicator (Red).....	88, 741, 742		
Parking Brake	638		
Brightness Control (Instrument Panel)	215		
Built-in Key	157		
Bulb Replacement	686		
Back-Up Lights/Taillights.....	691		
Brake, Rear Turn Signal Lights, and Rear Side Marker/Taillights.....	689		
Front Side Marker Lights.....	688		
Front Turn Signal Lights.....	687		
High-Mount Brake Light.....	692		
Parking/Daytime Running Lights	686		
Rear License Plate Light	692		
Side Turn Signal/Emergency Indicator Lights	688		
Bulb Specifications	760		
C			
CabinTalk®	536		
CabinWatch®	535		
Car Wash Mode	562		
Carbon Monoxide Gas	85		
Cargo Hooks	247		
Carrying Cargo	539, 541		
CD Player	347		
Center Pocket	243		
Certification Label	762		
Changing Bulbs	686		
Charging System Indicator	92, 740		

Child Safety	67	Adding to the Reserve Tank.....	681	Locking/Unlocking the Doors from the	
Childproof Door Locks.....	169	Overheating.....	737	Outside.....	159
Child Seat	67	Temperature Gauge.....	127	Lockout Prevention System.....	165
Booster Seats.....	84	Creeping (Automatic Transmission)	557	DOT Tire Quality Grading	700
Child Seat for Infants.....	69	Cup Holders	244	Driver Information Interface	128
Child Seat for Small Children.....	70	Customer Service Information	771	Accessing Content.....	130
Installing a Child Seat with a Lap/Shoulder Seat		Customized Features	143, 457, 463	Warning and Information Messages.....	108
Belt.....	77			Driving	537
Larger Children.....	83			Automatic Transmission.....	557
Rear-facing Child Seat.....	69	D		Braking.....	638
Selecting a Child Seat.....	71	Daytime Running Lights	206	Shifting Gear.....	558
Using a Tether.....	79	Dead Battery	735	Starting the Engine.....	550
Childproof Door Locks	169	Defaulting All the Settings	481	Driving Position Memory System	216
Cleaning the Exterior	715	Defrosting the Windshield and		Dust and Pollen Filter	711
Cleaning the Interior	712	Windows	261, 267		
Climate Control System	260, 265	Detachable Anchor	45		
Changing the Mode.....	260, 265	Devices that Emit Radio Waves	763	E	
Defrosting the Windshield and		Dimming		Eco Assist® System	13
Windows.....	261, 267	Headlights.....	202	Econ Mode	
Dust and Pollen Filter.....	711	Rearview Mirror.....	219	Indicator.....	99
Recirculation/Fresh Air Mode.....	260, 267	Dipstick (Engine Oil)	677	Electric Power Steering (EPS) System	
Sensors.....	264, 271	Directional Signals (Turn Signal)	201	Indicator.....	96, 743
Using Automatic Climate Control.....	260, 265	Door Mirrors	220	Electronic Stability Control (ESC)	574
Clock	154	Doors	156	Emergency	752
Coat Hooks	246	Auto Door Locking.....	170	Emergency Engine Stop	734
Compact Spare Tire	723, 761	Auto Door Unlocking.....	170	Emissions Testing (Readiness Codes)	765
Console Box	242	Door and Tailgate Open Message.....	39	Engine	762
Console Compartment with Lid	243	Keys.....	156	Coolant.....	681
Controls	153	Locking/Unlocking the Doors from the		If the Battery Is Dead.....	735
Coolant (Engine)	681	Inside.....	166	Oil.....	676
Adding to the Radiator.....	682			Starting.....	550

Engine Coolant	681
Adding to the Radiator	682
Adding to the Reserve Tank	681
Overheating	737
Temperature Gauge	127
Engine Oil	676
Adding	678
Checking	677
Displaying Maintenance Minder Information	668
Low Oil Pressure Warning	739
Recommended Engine Oil	676
ENGINE START/STOP Button	198
Exhaust Gas Hazard (Carbon Monoxide) ..	85
Exterior Care (Cleaning)	715
Exterior Mirrors	220
F	
Features	273
File Manager	321
Filters	
Dust and Pollen	711
Oil	679
Flat Tire	723
Floor Mats	713
Fluids	
Automatic Transmission	683
Brake	684
Engine Coolant	681
Windshield Washer	685

FM/AM Radio	289, 333
Fog Light Indicator	98
Folding Down the Rear Seats	226, 231
Foot Brake	641
Front Airbags (SRS)	52
Front Seat Heaters	257
Front Seat Heaters and Seat Ventilation	258
Front Seats	222
Adjusting	222
Fuel	28, 659
Economy	662
Gauge	127
Instant Fuel Economy	133
Low Fuel Indicator	94
Range	133
Recommendation	659
Refueling	659
Fuel Economy	662
Fuel Fill Door	28, 660
Fuses	745
Inspecting and Changing	751
Locations	745, 747, 750
G	
Gasoline (Fuel)	
Economy	662
Gauge	127
Information	659
Instant Fuel Economy	133

Low Fuel Indicator	94
Refueling	659
Gauges	127
Gear Position Indicator	92
Glass (care)	712, 717
Glove Box	241
Grocery Bag Hooks	248
H	
Handling the Unexpected	721
HandsFreeLink® (HFL)	485, 510
Automatic Import of Cellular Phonebook and Call History	499, 519
Automatic Transferring	518
Caller's ID Information	497
Displaying Messages	529
Favorite Contacts	520
HFL Buttons	485, 510
HFL Menus	487, 513
HFL Status Display	486, 512
In Case of Emergency	533
Limitations for Manual Operation	486, 512
Making a Call	504, 522
Options During a Call	509, 525
Phone Setup	491, 515
Receiving a Call	508, 525
Receiving a Text Message	527
Ring Tone	497, 518
Selecting a Phone	528
Speed Dial	500

To Clear the System.....	498
To Set Up a Text Message Options.....	526
Hazard Warning Button	6
HD Radio™	336
HDMI™ Port	412
Head Restraints	235
Headlights	202
Aiming.....	686
Auto High-Beam.....	207
Automatic Operation.....	203
Dimming.....	202, 206
Operating.....	202
Heated Steering Wheel	256
Heated Windshield Button	214
Heaters (Seat)	257, 258
HFL (HandsFreeLink®)	485, 510
High Beam Indicator	97
HomeLink® Universal Transceiver	482
Honda App License Agreement	389
Honda Sensing®	586
HondaLink®	364

I

Identification Numbers

Engine and Transmission.....	762
Vehicle Identification.....	762
Illumination Control	
Knob.....	215
Immobilizer System	191
Indicator.....	98

Indicators	88
Adaptive Cruise Control (ACC) with Low Speed Follow (Amber).....	103
Adaptive Cruise Control (ACC) with Low Speed Follow (White/Green).....	103
Anti-lock Brake System (ABS).....	95
Auto High-Beam.....	95
Auto Idle Stop (Green).....	100
Auto Idle Stop OFF.....	100
Auto Idle Stop Suspend.....	101
Auto Idle Stop System (Amber).....	100
Automatic Brake Hold.....	91
Automatic Brake Hold System.....	91
Charging System.....	92, 740
Cruise Mode (White/Green).....	104
Econ Mode.....	99
Electric Power Steering (EPS) System.....	96, 743
Fog Light.....	98
Gear Position.....	92
Hazard Warning.....	97
High Beam.....	97
Immobilizer System.....	98
Lane Keeping Assist System (LKAS) (Amber).....	102
Lane Keeping Assist System (LKAS) (White/Green).....	102
Lights On.....	98
Low Fuel.....	94
Low Oil Pressure Warning.....	739
Low Tire Pressure/TPMS.....	97, 579, 743

Malfunction Indicator Lamp.....	91, 740
Normal Mode.....	99
Parking Brake and Brake System (Amber).....	89, 90, 742
Parking Brake and Brake System (Red).....	88, 741, 742
Safety Support (Amber).....	104
Safety Support (Green/Gray).....	107
Seat Belt Reminder.....	41, 94
Security System Alarm.....	98
Snow Mode.....	99
Supplemental Restraint System.....	63, 95
System Message.....	99
Transmission System.....	93, 744
Turn Signal.....	97
Vehicle Stability Assist™ (VSA®) System.....	96, 574
VSA® OFF.....	96, 575
Information	759
Instant Fuel Economy	133
Instrument Panel	87
Brightness Control.....	215
Integrated Sunshades	259
Interior Lights	239
Interior Rearview Mirror	219
iPad	388
iPhone	388
iPod	291, 350, 388

J

Jack (Wheel Nut Wrench).....	726
Jump Starting.....	735

K

Key Number Tag.....	157
Keyless Access with Push Button Start System.....	159
Keyless Lockout Prevention.....	165
Keys.....	156
Lockout Prevention.....	165
Number Tag.....	157
Rear Door Won't Open.....	169
Remote Transmitter.....	163
Types and Functions.....	156
Kickdown (Automatic Transmission).....	557
Knee Airbags.....	57

L

Lane Keeping Assist System (LKAS).....	616
LaneWatch™.....	584
LATCH (Child Seats).....	72
Lights.....	202, 686
Automatic.....	203
Bulb Replacement.....	686
Daytime Running Lights.....	206
Fog Lights.....	205
High Beam Indicator.....	97
Interior.....	239

Light Switches.....	202
Lights On Indicator.....	98
Turn Signals.....	201
Load Limits.....	541
Locking/Unlocking.....	156
Auto Door Locking/Unlocking.....	170
Childproof Door Locks.....	169
From Inside.....	166
From Outside.....	159
Keys.....	156
Using a Key.....	164
Lockout Prevention System.....	165
Low Battery Charge.....	740
Low Fuel Indicator.....	94
Low Keyless Remote Signal Strength.....	158
Low Oil Pressure Warning.....	739
Lower Anchors.....	72
Luggage (Maximum Load Limit).....	541

M

Magic Slide® 2nd-Row Seats.....	229
Maintenance.....	137, 663
Battery.....	706
Brake Fluid.....	684
Cleaning.....	712
Climate Control System.....	711
Coolant.....	681
Maintenance Minder™.....	667
Oil.....	677
Precautions.....	664

Radiator.....	682
Remote Control and Wireless.....	
Headphones.....	709
Remote Transmitter.....	708
Replacing Light Bulbs.....	686
Safety.....	665
Service Items.....	670
Tires.....	697
Transmission Fluid.....	683
Under the Hood.....	673
Malfunction Indicator Lamp.....	91, 740
Map Light Switches.....	240
Maximum Load Limit.....	541
Meters, Gauges.....	127
Mirrors.....	219
Adjusting.....	219
Door.....	220
Exterior.....	220
Interior Rearview.....	219
Modifications (and Accessories).....	718
Moonroof.....	197
MP3/WMA/AAC.....	294, 347, 353, 356
Multi-View Rear Camera.....	657
My Honda Music.....	356

N

Navigation.....	134
Now Playing.....	139
Numbers (Identification).....	762

- O**
- Odometer 129
 - Oil (Engine) 676
 - Adding 678
 - Checking 677
 - Displaying Maintenance Minder Information 668
 - Low Oil Pressure Warning 739
 - Oil Life 137
 - Recommended Engine Oil 676
 - Viscosity 676
 - One-Motion 60/40 Split 3rd-Row Magic Seat® 231
 - Open Source Licenses 403
 - Opening/Closing
 - Hood 674
 - Moonroof 197
 - Power Windows 194
 - Sliding Doors 182
 - Tailgate 171
 - Outside Temperature Display 129
 - Overheating 737
- P**
- Panic Mode 193
 - Parking 646
 - Parking Brake 638
 - Parking Brake and Brake System Indicator (Amber) 89, 90, 742
 - Parking Brake and Brake System Indicator (Red) 88, 741, 742
 - Parking Sensor System 648
 - Passenger Airbag Off Indicator 64
 - Passing Indicators 202
 - Phone 138
 - Playing *Bluetooth*® Audio 297, 360
 - Power Sliding Doors 184
 - Unable to Close 756
 - Power Tailgate 174
 - Unable to Open 754
 - Power Windows 194
 - Precautions While Driving
 - Rain 556
 - Pregnant Women 47
 - Puncture (Tire) 723
- R**
- Radiator 682
 - Radio (FM/AM) 289, 333
 - Radio (SiriusXM®) 337
 - Radio Data System (RDS) 290, 335
 - Range 133
 - RDS (Radio Data System) 290, 335
 - Readiness Codes (Emissions Testing) 765
 - Rear Defogger/Heated Door Mirror
 - Button 213
 - Rear Entertainment System 409
 - Rear Seat Reminder 233
 - Rear Seats (Folding Down) 226, 231
 - Rearview Mirror 219
 - Refueling 659
 - Fuel Gauge 127
 - Gasoline 659, 760
 - Low Fuel Indicator 94
 - Regulations 579, 700, 763
 - Remote Transmitter 163
 - Removing a Second Row Outer Seat 228
 - Removing the Second Row Center Seat 227
 - Replacement
 - Battery 708, 709
 - Bulbs 686
 - Front Wiper Blade Rubber 693
 - Fuses 745, 747, 750
 - Tires 703
 - Reporting Safety Defects 764
- S**
- Safe Driving 35
 - Safety Check 39
 - Safety Labels 86
 - Safety Message 3
 - Seat Belts 40
 - Adjusting the Shoulder Anchor 44
 - Automatic Seat Belt Tensioners 42
 - Checking 48
 - Detachable Anchor 45
 - Fastening 43

Installing a Child Seat with a Lap/Shoulder Seat Belt.....	77	SiriusXM® Radio.....	337	Temperature	
Pregnant Women.....	47	Sliding Doors.....	182	Gauge.....	127
Reminder.....	41	Power Sliding Doors.....	184	Outside Temperature Display.....	129
Warning Indicator.....	41, 94	Snow Mode Indicator.....	99	Temperature Gauge.....	127
Seat Heaters.....	257, 258	Snow Tires.....	705	Temperature Sensor.....	129, 264, 271
Seats.....	222	Social Playlist.....	362	Third Row Seat Access.....	226
Adjusting.....	222	Spare Tire.....	723, 761	Time (Adjusting).....	154
Front Seats.....	222	Spark Plugs.....	760	Tire Pressure.....	137
Seat Heaters.....	257, 258	Specifications.....	760	Tire Pressure Monitoring System (TPMS)	
Second Row Seats.....	225	Specified Fuel.....	659, 760	Indicator.....	97, 743
Third Row Seats.....	230	Speedometer.....	128	Tires.....	697
Second Row Seats		SRS Airbags (Airbags).....	52	Air Pressure.....	698, 761
Adjusting.....	225	Starting the Engine.....	550	Checking and Maintaining.....	697
Security System.....	191	Does Not Start.....	732	Inspection.....	697
Immobilizer System Indicator.....	98	If the Battery Is Dead.....	735	Labeling.....	698
Security System Alarm Indicator.....	98	Steering Wheel		Puncture (Flat Tire).....	723
Select Buttons.....	25, 558	Adjusting.....	218	Regulations.....	700
Operation.....	560	Stopping.....	646	Rotation.....	704
Selecting a Child Seat.....	71	Summer Tires.....	705	Spare Tire.....	723, 761
Selector Knob (Audio).....	282	Sunglasses Holder.....	249	Summer.....	705
Settings		Supplemental Restraint System (SRS).....	52	Tire Chains.....	705
Arrange Apps.....	141	Switches (Around the Steering		Wear Indicators.....	702
Show Tachometer.....	142	Wheel).....	6, 7, 198	Winter.....	705
Shifting (Transmission).....	558	System Message Indicator.....	99	Tools.....	722
Shoulder Anchor.....	44	System Updates.....	315	Towing a Trailer.....	544
Show Tachometer.....	142	T		Equipment and Accessories.....	545
Show/Hide Apps.....	140	Tachometer.....	128	Load Limits.....	544
Side Airbags.....	60	Tailgate.....	171	Towing Your Vehicle.....	549
Side Curtain Airbags.....	62	Unable to Open.....	754	Emergency.....	752
Siri Eyes Free.....	372			TPMS (Tire Pressure Monitoring System)	
				Indicator.....	97, 743

Traffic Sign Recognition System	630
Transmission.....	558
Automatic	557
Fluid	683
Gear Position Indicator.....	92
Number	762
Transmission System	
Indicator.....	93, 744
Trip Computer.....	132
Trip Meter	133
Troubleshooting	721
Blown Fuse.....	745, 747, 750
Brake Pedal Vibrates	32
Buzzer Sounds When Opening Door	33
Emergency Towing	752
Engine Won't Start	732
Noise When Braking	33
Overheating.....	737
Puncture/Flat Tire.....	723
Sliding Door Won't Open.....	32, 169
Warning Indicators	88, 739
Turn Signals.....	201
Indicators (Instrument Panel).....	97

U

Units	138
Unlocking the Doors.....	159
Unlocking the Front Doors from the	
Inside	166
USB Flash Drives.....	294, 353, 388

USB Ports.....	275
Using the Keyless Access with Push Button	
Start System	159

V

Vanity Mirrors.....	9
Vehicle Customization	143
Vehicle Identification Number	762
Vehicle Stability Assist™ (VSA®)	
Off Button.....	574
Off Indicator.....	575
System Indicator	96
Ventilation	96
Ventilation	260
Viscosity (Oil)	676, 761
Voice Control Operation.....	330
Audio Commands	332
Phone Commands.....	332
Voice Portal Screen.....	331
Voice Recognition	330
VSA® (Vehicle Stability Assist™)	574

W

Wallpaper	285, 305
Warning and Information Messages.....	108
Warning Indicator On/Blinking	739
Warning Labels.....	86
Warnings.....	136
Warranties (Warranty Manual provided	
separately)	767

Watts	760
Wear Indicators (Tire)	702
Wheel Nut Wrench (Jack Handle).....	726
Wi-Fi Connection	369
Window Washers	210
Adding/Refilling Fluid	685
Switch	210
Windows (Opening and Closing)	194
Windshield	210
Cleaning.....	712, 717
Defrosting.....	261, 267
Washer Fluid.....	685
Wiper Blades.....	693
Wipers and Washers	210
Winter Tires	
Snow Tires	705
Tire Chains.....	705
Wipers and Washers	210
Checking and Replacing the Front Wiper	
Blades	693
Checking and Replacing the Rear Wiper	
Blade	695
Wireless Charger	253
Worn Tires	697



HONDA

owners.honda.com (U.S.)
honda.ca (Canada)

31THR640
OM-15673
00X31-THR-6400

2022 Honda Odyssey Owner's Manual
© 2020 Honda Motor Co., Ltd. — All Rights Reserved

Printed in U.S.A.