



MASERATI

*GranTurismo Convertible*

Owner's manual





**WARNING:**

Operating, servicing and maintaining a passenger vehicle or off-road vehicle can expose you to chemicals including engine exhaust, carbon monoxide, phthalates, and lead, which are known to the State of California to cause cancer and birth defects or other reproductive harm. To minimize exposure, avoid breathing exhaust, do not idle the engine except as necessary, service your vehicle in a well-ventilated area and wear gloves or wash your hands frequently when servicing your vehicle.

For more information go to: [www.P65Warnings.ca.gov/passenger-vehicle](http://www.P65Warnings.ca.gov/passenger-vehicle).







MASERATI

**GranTurismo Convertible**

**Owner's Manual**



Dear Customer,

Thank you for choosing a Maserati.

This vehicle represents the result of Maserati's great experience in the design and production of sports, touring and racing vehicles.

With this manual you will acquaint yourself with the equipment and options of your Maserati in order to take advantage of its full potential.

The updated version of the onboard documentation can be consulted by accessing the section "SERVICES" on the website [www.maserati.com](http://www.maserati.com) or by using the specific apps developed for the more common Tablet and Smartphone.

In a dedicated section of this manual you will also find instructions for basic maintenance procedures, in order to ensure steady levels of performance, quality and safe driving.

Keep in mind that proper maintenance is an essential factor to help preserve the value of the vehicle over time and protect the environment.

For "Scheduled Maintenance" or any other operation, contact your **Authorized Maserati Dealer**: you can trust our trained technical staff, who is constantly updated and provided with the required equipment in order to ensure that all service operations are performed properly and reliably.

The Quick guide and other documents contained in onboard documentation kit are integral part of the vehicle and should always be kept on board.



### **WARNING!**

#### **California Proposition 65**

**Operating, servicing and maintaining a passenger vehicle or off-road vehicle can expose you to chemicals including such as, engine exhaust, carbon monoxide, phthalates and lead, that which are know to the State of California to cause cancer and birth defects or other reproductive harm. To minimize exposure, avoid breathing exhaust, do not idle the engine except as necessary, service your vehicle in a well-ventilated area and wear gloves or wash your hands frequently when servicing your vehicle.**



**Introduction**

**1**

**Before Starting**

**2**

**Understanding the Vehicle**

**3**

**Dashboard Instruments and Controls**

**4**

**Driving**

**5**

**In an Emergency**

**6**

**Maintenance and Care**

**7**

**Features and Specifications**

**8**

**Index**

**9**





## **1 – Introduction**

Consulting the Manual .....	6
Abbreviations .....	7
Updating .....	7
Service and Warranty .....	8
Suggestions for Obtaining Service for Your Vehicle .....	8
If You Need Assistance .....	9
Warranty Information .....	10
Reporting Safety Defects .....	10
Parts Service .....	11
Aftermarket Parts & Accessories Statement .....	11
Towing the Vehicle .....	12
Symbols .....	12
Warnings when driving .....	14
Maserati Roadside Assistance Program (available for USA and Canada only) .....	15
Vehicle Identification Data .....	17



### Consulting the Manual

This Owner's Manual illustrates use and maintenance information related to all versions of this model. If not otherwise specified, the information is valid for all versions.

For an easy identification of the topics, this Manual is divided into sections and chapters: each chapter can have more paragraphs.

Within the text, important warnings and notes are also easily identifiable through icons.



#### **WARNING!**

**California Proposition 65**  
**Operating, servicing and maintaining a passenger vehicle or off-road vehicle can expose you to chemicals including such as, engine exhaust, carbon monoxide, phthalates and lead, that which are know to the State of California to cause cancer and birth defects or other reproductive harm. To minimize exposure, avoid breathing exhaust, do not idle the engine except as necessary, service your vehicle in a well-ventilated area and wear gloves or wash your hands frequently when servicing your vehicle. For more information go to:**

[www.P65Warnings.ca.gov/passenger-vehicle](http://www.P65Warnings.ca.gov/passenger-vehicle)



#### **WARNING!**

**Failure to comply with the instructions could cause HAZARDOUS SITUATIONS involving personal and vehicle safety.**



#### **ENVIRONMENTAL!**

**This note indicates the correct behavior when using the vehicle to protect the environment.**



#### **CAUTION!**

Aimed at preventing any damage to the vehicle and thus hazards involving the safety of persons.

#### **NOTE:**

*Additional information regarding the subject and/or the operation described.*

- “Left” and “right” in this manual, always refer to the driving direction.
- All indications and images in this Manual refer to a vehicle with left-hand drive. On right-hand drive

vehicles, some controls are ordered differently than shown in the illustrations.

#### **NOTE:**

*Unless otherwise specified, pictures refer to Sport model.*



## Abbreviations

Some descriptions and terms with particular meanings are found in this manual in abbreviated form.

<b>A/C</b>	Air-Conditioning System.
<b>ABS</b>	Anti-Lock Braking System.
<b>ALC</b>	Adaptive Light Control.
<b>ALR</b>	Automatic Locking Retractor.
<b>ASR</b>	Anti-Slip Regulation.
<b>BOS</b>	Brake Override System.
<b>CAN</b>	Controller Area Network.
<b>CC</b>	Cruise Control.
<b>CRS</b>	Child Restraint System.
<b>DRL</b>	Daytime Running Lights.
<b>EBD</b>	Electronic Brake-force Distribution.
<b>ECU</b>	Electronic Control Unit.
<b>EDR</b>	Event Data Recorder.
<b>EPB</b>	Electric Parking Brake.
<b>ESC</b>	Electronic Stability Control.
<b>ETD</b>	Emergency Tensioning Device.
<b>FTP</b>	Flash To Pass.
<b>HBA</b>	Hydraulic Brake Assistance.
<b>ICE</b>	Increase Control and Efficiency.

<b>LATCH</b>	Lower Anchors and Tether for CHILDren.
<b>MIL</b>	Malfunction Indicator Light.
<b>MTC+</b>	Maserati Touch Control Plus.
<b>OBD</b>	On Board Diagnostics.
<b>ORC</b>	Occupant Restraint Controller.
<b>RHD</b>	Right-Hand Drive.
<b>SBR</b>	Seat Belt Reminder.
<b>TFT</b>	Thin Film Transistor.
<b>TPMS</b>	Tire Pressure Monitoring System.
<b>VIN</b>	Vehicle Identification Number.

## Updating

Constant improvements are being performed to maintain this vehicle's high level of quality. Therefore, there may be differences between this manual and your vehicle. Maserati reserves the right to carry out design and functional changes and to provide updates or improvements. This Owner's Manual illustrates and describes all versions of the current vehicle model. Therefore, some of the equipment and accessories in this publication may not appear on your vehicle; please only consider the information related to your vehicle. All specifications and illustrations contained in this manual are as of the Manual publishing date.

### **NOTE:**

*The updated version of the on-board documentation can be consulted by accessing the section "SERVICES" on the website [www.maserati.com](http://www.maserati.com) or by using the specific apps developed for the more common Tablet and Smartphone.*



### 1 Service and Warranty

The information provided in this manual is limited to instructions and indications that are strictly required for vehicle use and proper maintenance.

By following these instructions carefully, the vehicle will meet the owner's satisfaction and best results. We advise to have all service and inspections completed only by an **Authorized Maserati Dealer**, where you will find a specially trained staff and the proper equipment to repair your vehicle.

Please visit the [www.maserati.com](http://www.maserati.com) to find the nearest **Authorized Maserati Dealer**.

All features and accessories installed on the vehicle have been designed by Maserati engineers and have successfully passed rigorous tests, submitted in all conditions of use.

Installing aftermarket components or accessories not approved by Maserati may interfere with the vehicle electronics and compromise driving safety.

For details and information about the warranty, please refer to the "Warranty Card".

An **Authorized Maserati Dealer** is at your complete disposal for any information and questions you may have.

### Suggestions for Obtaining Service for Your Vehicle

#### Prepare for the Appointment

If warranty work is required, be sure to have the right papers with you and take your warranty folder. Not all work being performed may be covered by the warranty: therefore discuss additional charges with the service manager. It is advisable to keep a maintenance log of your vehicle's service history, as this can often provide a clue to the current problem.

#### Prepare a List

Make a written list of your vehicle's problems or the specific work you wish to be performed. If the vehicle has had an accident or work done that is not indicated on the maintenance log, please communicate this to the service advisor.

#### Optimize the Requests

If there are a number of items needing attention, it is advisable to discuss this with your service advisor to agree on the order of priorities.

At many **Authorized Dealers/Service Centers**, it is possible to obtain a loaner vehicle or a rental vehicle at a





minimal daily charge. If you need a rental vehicle, it is advisable to make these arrangements prior to the visit, for example when you call to set the appointment.

## If You Need Assistance

The manufacturer/**Maserati** and its **Authorized Dealers** set highest priority to the client's satisfaction with the products and services.

Warranty service must be performed by an **Authorized Maserati Dealer/Service Center**.

Should there be any issues, please keep in mind that most matters can be resolved with the following process.

- If for some reason you are still not satisfied, please contact the general manager or owner of the Service Center, it is their responsibility to assist you.
- If a Service Center is unable to resolve the issue, you may contact **Maserati Customer Center**.

Any communication to the **Maserati Consumer Affairs** should include the following information:

- Owner's name and address.
- Owner's telephone number (home and office).
- Maserati Service Center name.
- Vehicle Identification Number (VIN).
- Vehicle delivery date and mileage.

Contact:

**MASERATI North America, Inc.**

250 Sylvan Avenue

Englewood Cliffs

NJ 07632

Phone:

**Maserati Customer Care**

1-877-MY-MASERATI (877-696-2737) or

1-201-510-2369



## Warranty Information

1 Please refer to the Warranty booklet, included in the Owner's documentation kit, for the terms and provisions of Maserati warranties applicable to this vehicle and market.

## Reporting Safety Defects

### NHTSA's Toll-free Auto Safety Hotline

If you believe that your vehicle has a defect which could cause a crash, injury or death, immediately inform the National Highway Traffic Safety Administration (NHTSA) in addition to notifying Maserati North America, Inc. If NHTSA receives similar complaints, it may open an investigation, and if it finds that a safety defect exists in a group of vehicles, it may order a recall and remedy campaign. However, NHTSA cannot become involved in individual problems between you, your dealer, or Maserati North America, Inc. To contact NHTSA, you may call the Vehicle Safety Hotline toll-free at 1-888-327-4236 (TTY: 1-800-424-9153), go to <http://www.safercar.gov>; or write to: Administrator, NHTSA, Washington, D.C. 20590. You can also obtain other information about motor vehicle safety from <http://www.safercar.gov>.

### Reporting safety defects in Canada

If you believe your vehicle has a defect that could cause a crash or could cause injury or death, you should immediately inform Transport Canada

in addition to notifying Maserati North America, Inc.

**Transport Canada can be contacted at:**

1-800-333-0510

Teletypewriter (TTY): 613 990-4500

Fax: 1-819-994-3372

Mailing Address: Transport Canada - Road Safety, 80 rue Noël, Gatineau, (Quebec) J8Z 0A1.

### In Canada

If you believe that your vehicle has a safety defect, contact the Customer Service Department immediately. Canadian customers who wish to report a safety defect to the Canadian government should contact Transport Canada, Motor Vehicle Defect Investigations and Recalls at 1-800-333-0510 or go to <http://www.tc.gc.ca/roadsafety/>



## Parts Service

Genuine parts keep the reliability, comfort and performance of your new car unchanged throughout its life. For service and scheduled maintenance Maserati suggests you to ask for genuine parts since they are the result of constant research and development, reliability test and new technologies, as well as they are specifically designed for this vehicle.



### **WARNING!**

**California Proposition 65**  
**Operating, servicing and maintaining a passenger vehicle or off-road vehicle can expose you to chemicals including such as, engine exhaust, carbon monoxide, phthalates and lead, that which are known to the State of California to cause cancer and birth defects or other reproductive harm. To minimize exposure, avoid breathing exhaust, do not idle the engine except as necessary, service your vehicle in a well-ventilated area and wear gloves or wash your hands frequently when servicing your vehicle.**

## Aftermarket Parts & Accessories Statement

Modification of the vehicle or installation of any accessory or components attached to the vehicle which alters the original engineering and/or vehicle operating specifications, or which result in damage to the other original components, electrical interference, electrical short(s), radio static, water leaks and wind noise may result in damage to genuine components, compromise the safety of the vehicle and affect the validity of the new car warranty on the vehicle.

### **Non-genuine Maserati Parts**

Non-genuine Maserati Parts (while you may elect to use non-genuine Maserati parts for maintenance or repair services), Maserati North America, Inc. is not obligated to pay for repairs that include non-genuine Maserati parts or for any damage resulting from the use of non-genuine parts.

Maserati will not accept any liability for any parts and accessories not approved by Maserati, including Dealer-installed accessories not

distributed by Maserati North America, Inc.



1

## Towing the Vehicle

The vehicle has not been designed, developed and homologated to be used as a towing vehicle for other means (e.g. trailers, campers, etc.).

## Symbols

There are specific colored plates on or near some of the components on your Maserati designed to attract user's attention. The related symbols are important warnings that the user must follow when using the component involved.

All symbols reported on the plate and inside the vehicle, as well as the component for which the symbols stand, are summarized in the following list. These symbols are divided into categories according to their meaning.

### Danger Symbols



**Battery**  
Corrosive liquid.



**Battery**  
Explosion.



**Blower**  
May start automatically even with engine off.



**Coolant expansion reservoir**  
Do not open cap with engine warm.



**Coil - headlights**  
High voltage.



**Belts and pulleys**  
Moving parts, keep body and clothing clear.



**Air-conditioning lines**  
High pressure gas, do not open.

## Symbols of Prohibitions and Compulsory Measures



**Battery**  
Keep away from flames.



**Battery**  
Keep out of children's reach.



**Heat guards - belts - pulleys - fans**  
Do not touch.



**Battery**  
Wear eye protection.



**Battery - jack**  
Refer to the owner manual.

**WARNING!****California Proposition 65**

Operating, servicing and maintaining a passenger vehicle or off-road vehicle can expose you to chemicals including such as, engine exhaust, carbon monoxide, phthalates and lead, that which are know to the State of California to cause cancer and birth defects or other reproductive harm. To minimize exposure, avoid breathing exhaust, do not idle the engine except as necessary, service your vehicle in a well-ventilated area and wear gloves or wash your hands frequently when servicing your vehicle. For more information go to: [www.P65Warnings.ca.gov/passenger-vehicle](http://www.P65Warnings.ca.gov/passenger-vehicle)

**Warning Symbols****Catalytic converter**

Do not park the vehicle over flammable materials. Refer to chapter "Pollution Control Devices" in section "Driving".

**Engine - Engine Oil Filler Cap**

Engine oil. We recommend you use oil with the characteristics indicated in chapter "Refillings" in section "Features and Specifications".

**Hydraulic steering reservoir**

Power steering fluid. Do not exceed max. level. We recommend you use liquid with the characteristics indicated in chapter "Refillings" in section "Features and Specifications".

**Brake fluid reservoir**

Brake fluid type DOT 4. Do not exceed max. level. We recommend you use fluid with the characteristics indicated in chapter "Refillings" in section "Features and Specifications".

**Radiator coolant expansion reservoir**

Use antifreeze liquid for radiators with the characteristics indicated in chapter "Refillings" in section "Features and Specifications".

**Windshield washer fluid reservoir**

Windshield washer. We recommend you use liquid with the characteristics indicated in chapter "Refillings" in section "Features and Specifications".



### *Vehicle using lead-free gasoline*

Only "Premium gasoline" with an AKI (Anti Knock Index) rating not lower than 91 (approximately 96 R.O.N.) must be used. Refer to chapter "Fuel Requirements" in section "Driving".



### **WARNING!**

#### **California Proposition 65**

**Operating, servicing and maintaining a passenger vehicle or off-road vehicle can expose you to chemicals including such as, engine exhaust, carbon monoxide, phthalates and lead, that which are know to the State of California to cause cancer and birth defects or other reproductive harm. To minimize exposure, avoid breathing exhaust, do not idle the engine except as necessary, service your vehicle in a well-ventilated area and wear gloves or wash your hands frequently when servicing your vehicle. For more information go to:**

[www.P65Warnings.ca.gov/passenger-vehicle](http://www.P65Warnings.ca.gov/passenger-vehicle)

## Warnings when driving

Your driving skills will improve with experience, but be especially careful at the beginning. Always comply with local traffic regulations wherever you drive.

Failure to operate this vehicle correctly may result in loss of control or a collision.

Operating this vehicle at excessive speed or in an altered state or while intoxicated may result in loss of control, going off the road, or overturning. In all these situations a collision with other vehicles or objects is more likely to happen with the risk to cause an accident that may lead to serious injury.

In case of an accident, failure to use seat belts causes the driver and passengers a greater risk of injury or death.

This Owner's Manual contains warnings against operating procedures that could result in a collision or injury or damage to the environment. It also contains cautions against procedures that could damage the vehicle.

If you do not read this manual in its entirety, you may miss important information. Consider carefully all warnings and cautions.

**WARNING!**

- It is the driver's responsibility to operate the vehicle in a safe way: if you are distracted while driving you can lose control and cause serious accidents.
- Maserati strongly recommends to use particular care when operating the features and tools that may take the attention off the road.
- Mobile phones, PC, portable audio device or other features should not be operated while the vehicle is in motion. This can be very dangerous and can cause serious accidents.
- It is very dangerous to send text messages while driving, do so only when the vehicle is not moving.
- In some Countries/States the use of mobile phone when driving is forbidden: it is the driver's sole responsibility to respect local regulations.

**CAUTION!**

If battery charge is too low, proper function of some electric/electronic components may not be guaranteed. It is necessary to recharge the battery

in order to allow all vehicle's components and systems to function correctly.

**WARNING!**

**California Proposition 65**  
**Operating, servicing and maintaining a passenger vehicle or off-road vehicle can expose you to chemicals including such as, engine exhaust, carbon monoxide, phthalates and lead, that which are know to the State of California to cause cancer and birth defects or other reproductive harm. To minimize exposure, avoid breathing exhaust, do not idle the engine except as necessary, service your vehicle in a well-ventilated area and wear gloves or wash your hands frequently when servicing your vehicle. For more information go to:**  
[www.P65Warnings.ca.gov/passenger-vehicle](http://www.P65Warnings.ca.gov/passenger-vehicle)

## Maserati Roadside Assistance Program (available for USA and Canada only)

Welcome to Maserati and the benefits and security of the Maserati Roadside Assistance Program. Please take a moment to review the benefits listed below and available to you through the Maserati Roadside Assistance Program.

### Emergency Roadside Services

In the event you require Roadside Assistance, please call 1-888-371-1802, 24 hours a day, 365 days a year. You will be connected with a Roadside Assistance representative who will dispatch a local towing vendor.

### Information needed for when you call

When you call, please be prepared to provide the following information:

- Your Name.
- Vehicle Identification Number (VIN).
- Location of your vehicle.
- Nature of your call (for example; you require a tow, vehicle will not start, out of gas, tire service, etc.).



### 1 Summary of Program Benefits and Services

- Towing of a disabled registered Maserati vehicle. In the event a registered vehicle becomes disabled in connection to a warranty related concern it will be transported to the nearest **Authorized Maserati Dealership**. You may request that the vehicle be taken to a different **Authorized Maserati Dealer**, as long as it is no more than 50 miles further away from the nearest authorized dealer (one tow per disablement).
- Battery jump start.
- Flat tire change providing the vehicle is equipped with a spare tire.
- Fuel delivery (up to 2 gallons).
- Lockout Services.
- Service Loaner Vehicle: For warranty repairs, your dealer may provide you with a Maserati Service Loaner Vehicle (if available) or provide you with Rental Car allowance: in the event your vehicle is disabled due to a warranty related concern, we will reimburse you up to \$50 per day. A five (5) day or \$250 maximum applies. In order to receive reimbursement, you must supply the following information within 20 days

of the rental car transaction to the address listed below; the original pre-printed rental car receipt, which must include your name, address, telephone number, VIN, rental dates and the corresponding warranty repair order.

Maserati Roadside Assistance ATTN:  
Maserati Rental Car Claims Dept.  
P.O. Box 8140 Ft.  
Washington, PA 19034

#### **NOTE:**

*An authorized licensed driver must be driving at the time of the disablement.*

Items excluded from coverage:

- Parts, labor, tire repair, rental of towing equipment, storage fees, or any labor performed at the service facility.
- Any form of impound towing, or towing by someone other than a licensed service station or garage.
- Assistance from a private citizen.

#### **NOTE:**

*Membership is intended to cover emergencies and is not intended to be a substitute for proper vehicle maintenance or repair. Repeated calls which are considered by Maserati North America, Inc. Signature Motor Club, Inc. or Signature Motor Club of California, Inc. to be excessive may, at our discretion, result in cancellation of the membership.*

Emergency road service providers are independent contractors and are not employees, agents or representatives of Maserati North America, Inc. Signature Motor Club, Inc. or Signature Motor Club of California, Inc.

#### **Under this Agreement**

- You will not be required to pay any sum for services up to the mileage limit on towing.
- Your registered Maserati vehicle is the vehicle covered. The Vehicle Identification Number (VIN) that appears on the vehicle represents your identification number with Signature Motor Club, Inc. or Signature Motor Club of California, Inc.





- **NEW VEHICLES:** Your membership begins on the date the Registered Vehicle was originally sold (in service date) and continues until the expiration date of the New Car Limited Warranty or unless terminated by Maserati North America, Inc. for cause.
- **PRE OWNED VEHICLES:** Your membership begins on the date the registered vehicle was sold (in service date) and continues until the expiration date of the Maserati Certified Pre-Owned Limited Warranty or unless terminated by Maserati North America, Inc for cause.

#### Address Inquiries to

##### **General Inquiries:**

Maserati Roadside Assistance  
P.O. Box 968008  
Schaumburg, IL 60173

##### **Rental Car Reimbursements:**

Within 20 days of your rental car transaction, the original pre-printed rental car receipt, which must include your name, address, telephone number, VIN, rental dates and the corresponding warranty repair order should be submitted to:

Maserati Roadside Assistance ATTN:  
Maserati Rental Car Claims Dept.  
P.O. Box 8140  
Ft. Washington, PA 19034

## Vehicle Identification Data

### Vehicle Identification

#### Vehicle Identification Number (VIN)

The VIN is punched on the foot platform, in front of the right-hand front seat.

To read the number, lift the removable carpet and remove the guard by unscrewing the four retaining screws.





1

The VIN number is also indicated on the label applied to the lower rear end of the driver's door.

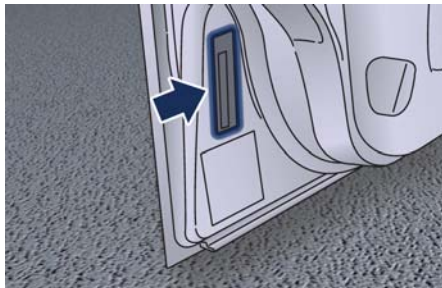

The VIN number is also visible from the outside through the windshield on the front left corner of the dashboard.

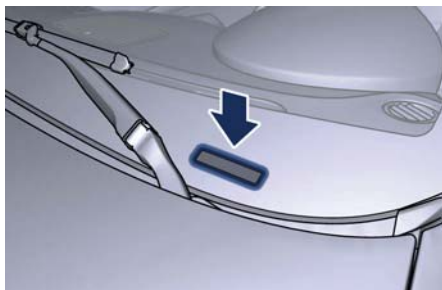

**NOTE:**

*When ordering spare parts or making inquiries, always quote the Vehicle Identification Number.*

## Homologation Labels

### Safety Standard Label

This label is applied on the driver door's pillar.

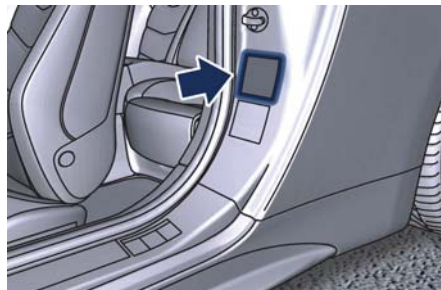

### Emission Control Label

This label is applied inside the hood lid, on the right-hand side.

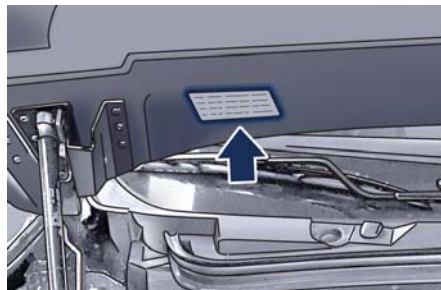

## Warning and Information Labels

### Passenger Air bag Labels

The labels are applied on the external side of the sun visors and below it, on the dome.

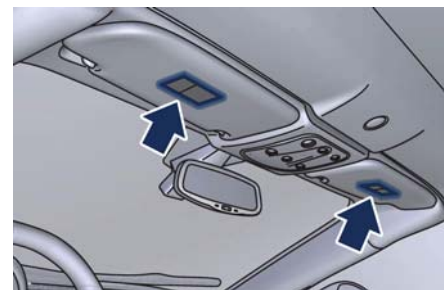
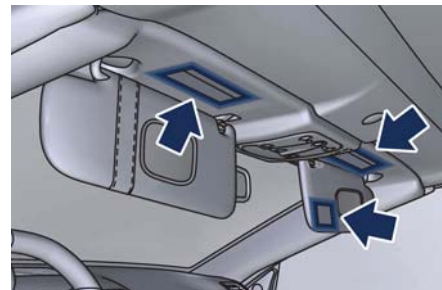

An other label is applied on the dashboard indicate that air bag system is installed.

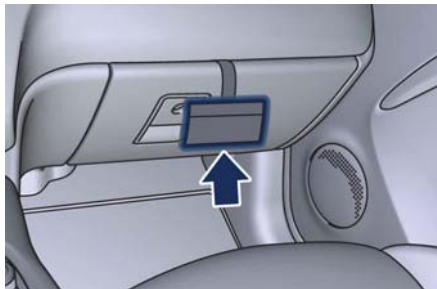

The label applied on the right-hand side of the dashboard bears the air bag system expiration date.

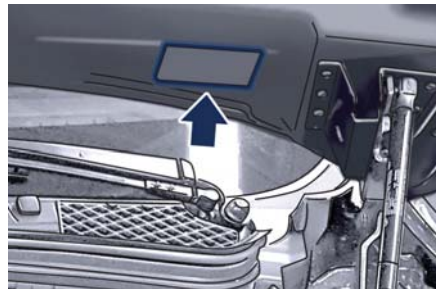

#### Fuel Warning Label

The labels are applied inside the fuel filler door.

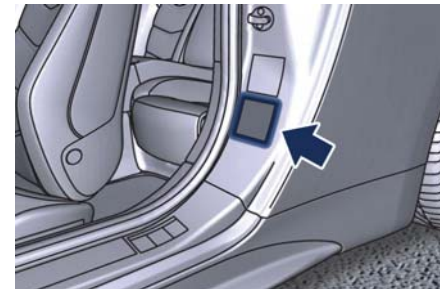

#### Tire and Loading Information Label

This label is applied on the driver's side at the base of the rear door pillar.

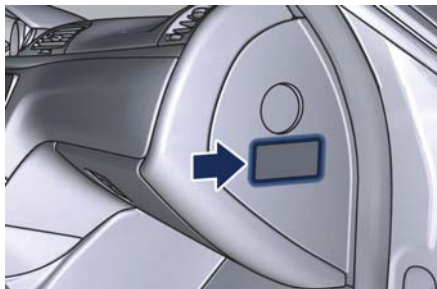

#### Paint Information Label

The label is applied inside the hood lid, on the left-hand side.

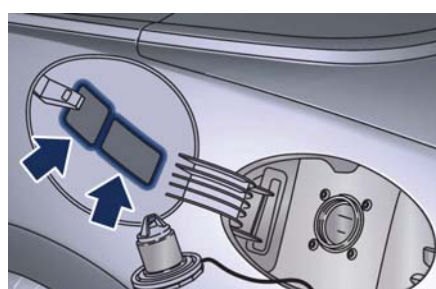

#### Mercury Content Warning Label

This label is applied to the lower end of the driver's door.

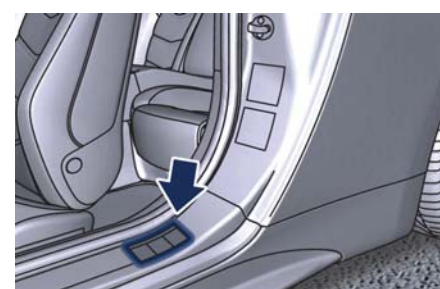

#### Lubricant Information Label

This label is applied on the covering in the right-hand side of the engine compartment.



1

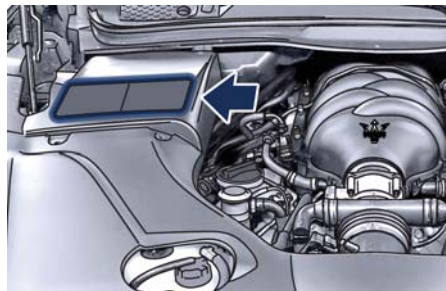

### Engine Coolant Information Label

This label is applied in correspondence of the coolant filling cap, in the engine compartment.

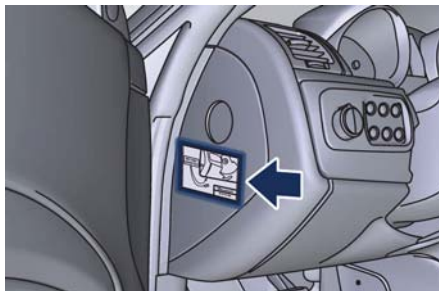

### OBDII Socket Information

This label is applied on the left-hand side of the dashboard.

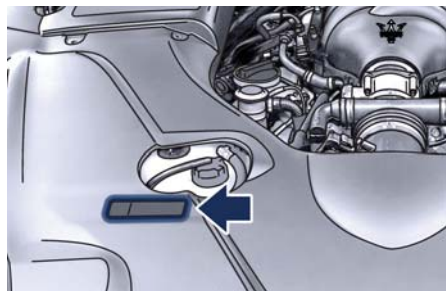



## **2 – Before Starting**

Keys . . . . .	22
Immobilizer System . . . . .	24
Vehicle Security Alarm . . . . .	26
Requiring and Setting Additional Key . . . . .	28
Doors . . . . .	30
Power Windows . . . . .	33
Open and Close the Trunk Lid . . . . .	35
Trunk Safety . . . . .	37
Open and Close the Hood . . . . .	37
Occupants Restraint Systems . . . . .	38
Supplemental Restraint System - Air bags . . . . .	46
Active Roll Bars. . . . .	53
Child Restraint Systems . . . . .	54
Transporting Pets . . . . .	59
Park Assist . . . . .	60
Rear Parking Camera . . . . .	63
Safety Tips . . . . .	65



## Keys

Two keys with radio control are supplied with the vehicle.



The key is used for:

- starting the engine;
- activating the central door locking system;
- opening the trunk lid electrically;
- activating/deactivating the alarm system;
- locking/unlocking the glove compartment on the dashboard.



### WARNING!

**California Proposition 65**  
Operating, servicing and maintaining a passenger vehicle or off-road vehicle can expose you to chemicals including such as, engine exhaust, carbon

**monoxide, phthalates and lead, that which are know to the State of California to cause cancer and birth defects or other reproductive harm. To minimize exposure, avoid breathing exhaust, do not idle the engine except as necessary, service your vehicle in a well-ventilated area and wear gloves or wash your hands frequently when servicing your vehicle. For more information go to: [www.P65Warnings.ca.gov/passenger-vehicle](http://www.P65Warnings.ca.gov/passenger-vehicle)**

## Ignition Switch

The key in the ignition switch can turn in 4 positions:

- STOP (OFF)** Engine off, engine immobilizer and steering wheel lock activated, connected devices disabled, apart from those that are not key-controlled (e.g. centralized door lock, trunk compartment opening, etc.). The key is removable.
- ACC** Steering lock release and position for cigarette lighter and power outlet activation. The key is removable.

**MAR (ON)** Driving position: all electrical devices can operate. The key is removable.

**AVV** Engine starting.

Upon exceeding a speed a 3 mph (5 km/h), if one or more doors/lids are open or not properly closed, a warning buzzer will be activated.

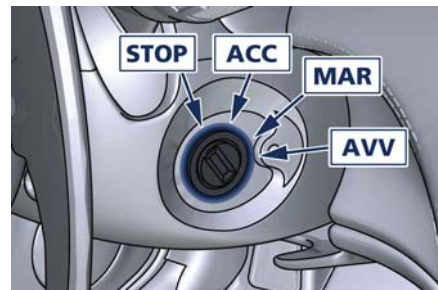

### WARNING!

- When you get out of the vehicle, always remove the key to prevent someone from accidentally activating the controls.
- When leaving the vehicle, always remove the key from the ignition switch and lock your vehicle.





- Never leave children alone in a vehicle, or with access to an unlocked vehicle.
- Allowing children to be in a vehicle unattended is dangerous for a number of reasons. A child or others could be seriously or fatally injured. Children should be warned not to touch the parking brake switch, brake pedal or the shift lever.
- Do not leave the key in or near the vehicle, and do not leave the key in the ignition switch in the ACC or MAR (ON) position. A child could operate power windows, other controls, or move the vehicle.
- Do not leave children or animals inside parked vehicles in hot weather. Interior heat build-up may cause serious injury or death.
- An unlocked car is an invitation to thieves. Always remove the key from vehicle, cycle the ignition switch to STOP (OFF) and lock all doors when leaving the vehicle unattended.
- In the event of tampering with the starter switch (e.g. attempted theft), have it checked by an Authorized Maserati Dealer before restarting the vehicle.

The key can be removed from the ignition switch only when the transmission shift lever is in position P (Park).

If the transmission shift lever is shifted to P (Park) after turning off the engine, the key can only be removed within 30 seconds from turning it to **STOP (OFF)** position.

If you do not remove the key within 30 seconds, you will need to turn it back to **MAR (ON)** and then to **STOP (OFF)** position to have a further 30 seconds within which to remove the key.

In the event that the key unlocking system fails or if it is not possible to shift the transmission shift lever to P (Park) position, to remove the key from the ignition switch you must turn it to **STOP (OFF)** position, then:

- remove the cap indicated in the picture using a pen or sufficiently pointed tool;
- press the button just uncovered and at the same time extract the key;
- once the key has been removed, refit the cap.

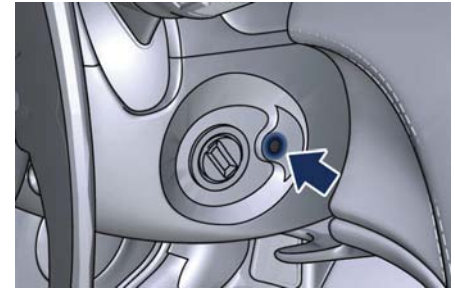

### WARNING!

After stopping the vehicle, always shift the transmission shift lever to P (Park).



# Immobilizer System

## The Maserati CODE System

In order to increase protection against theft, the vehicle is equipped with an electronic engine immobilizer system (Maserati CODE), which is automatically activated when the key is removed from the ignition switch. Each starter key contains an electronic device which transmits a code signal to the Maserati CODE control unit, and engine ignition is enabled only if the key code is recognized by the system. Using the key inserted in the driver's outboard door lock, you can also control the soft top opening/closing strategy referred to as "Summer open". This strategy is described in chapter "Soft Top" of section "Understanding the Vehicle".

## Key Codes

A CODE card is supplied with the keys. This card indicates the following:

- the "ELECTRONIC CODE" to be used for emergency starting (see "Emergency Starting with Maserati Code" in section "In an Emergency");
- the "MECHANICAL CODE" to be provided to an **Authorized Maserati**

Dealer if you request duplicates of the keys.

### NOTE:



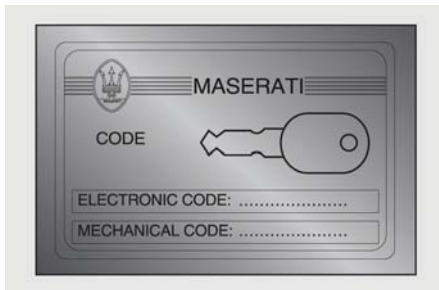

- *The code numbers shown on the CODE card should be kept in a safe place.*
- *You are advised to always keep the CODE card number with you, as it is absolutely necessary in the event of "Emergency Starting".*
- *In the event of a vehicle ownership transfer, it is essential that the new owner is provided with all the keys and with the CODE card.*
- *It is advisable to write down and keep the codes listed on the plates delivered with the keys and the remote control in a safe place (not in the vehicle) in order to request duplicates if needed.*



## CODE System Operation

Each time the key in the ignition switch is removed in the **STOP (OFF)** position, protection system activates the engine immobilizer.

When the engine is started and the key is turned to **MAR (ON)** position:



- If the code is recognized, the CODE  warning light on the instrument cluster turns off within a second, while the MIL  warning light, once the ECU diagnosis has been completed, goes off after about four seconds. In these conditions, the protection system recognizes the key code and deactivates the engine immobilizer. When the key in the ignition switch is turned to **AVV** position, the engine starts.
- If the CODE  warning light remains on and the MIL  warning light goes off after four seconds (ECU diagnostics) and illuminates again immediately afterward, the code has not been recognized and the message "Electronic key not recognized" is displayed. If this occurs, turn the key in the ignition switch to **STOP (OFF)** and then back to **MAR (ON)** position. If the immobilizer stays on, try with the other keys. If you still cannot start





the engine, try the emergency start procedure (see "Emergency Starting with Maserati Code" in section "In an Emergency") and contact an **Authorized Maserati Dealer**.

While driving, with the key in the ignition switch in **MAR (ON)** position:

- If the CODE  warning light comes on, it means that the system is running a self-diagnostic cycle. At the first stop you can test the system: turn the key in the ignition switch in **STOP (OFF)** position to stop the engine and then back to **MAR (ON)** position: the CODE  warning light will illuminate and should turn off in one second. If the warning light stays on, repeat the procedure described previously leaving the key at **STOP (OFF)** position for more than 30 seconds. If the problem persists, contact an **Authorized Maserati Dealer**.
- If the CODE  warning light flashes, it means that the vehicle is not protected by the immobilizer device. Immediately contact an **Authorized Maserati Dealer** to have all the keys stored in the memory.



### CAUTION!

- Strong impacts can damage the electronic components in the key.
- Each key supplied has its own specific code, which must be stored in the memory of the system control unit.

## Duplicating the Keys

When ordering additional keys, remember that the storage procedure (up to maximum of 7 keys) must be performed for all the keys, including those already in your possession. Contact the **Authorized Maserati Dealer** directly, bringing with you all the keys in your possession, the Maserati CODE card, the electronic alarm system CODE CARD, a personal ID and the identification and registration documents proving ownership of the vehicle. The codes of any keys that are not available when the new storage procedure is performed will be deleted from the memory to prevent any lost or stolen keys from being used to start the vehicle. When ordering additional keys, remember that the storage procedure (up to maximum of 7 keys)

must be performed for all the keys, including those already in your possession. Contact the **Authorized Maserati Dealer** directly, bringing with you all the keys in your possession, the Maserati CODE card, the electronic alarm system CODE CARD, a personal ID and the identification and registration documents proving ownership of the vehicle.

The codes of any keys that are not available when the new storage procedure is performed will be deleted from the memory to prevent any lost or stolen keys from being used to start the vehicle.



### Vehicle Security Alarm

The vehicle security alarm system performs the following functions:

- remote control of the centralized door locking/unlocking system;
- perimeter surveillance, detecting the opening of doors, engine/trunk compartment lids;
- motion surveillance, detecting intrusion in the passenger compartment;
- vehicle movement surveillance.

#### NOTE:

*The engine immobilizer operation is guaranteed by the Maserati CODE system, which is automatically activated when the key is removed from the ignition switch.*

### Alarm System Activation

Press the  lock button on the key to activate the security alarm system.

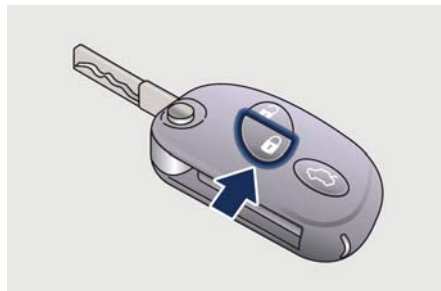

- The turn signals flash once.
  - The system beeps.
  - The red LEDs on the front door panels flash.
  - The vehicle centralized door locking is activated and the doors are locked.
- The system becomes operative after approximately 25 seconds and the alarm is activated when:
- a door is opened;
  - the trunk compartment lid is opened;
  - the engine compartment lid is opened;
  - someone attempts to enter the vehicle from a window;
  - the power supply is disconnected;
  - the siren is disconnected;
  - the vehicle is moved.

When the vehicle security alarm is active, the user may request the trunk compartment opening; in this case, the

motion and inclination sensors are temporarily deactivated.

If the trunk compartment lid is then closed, the sensors will be reactivated. Should the turn signals flash 9 times when you activate the security alarm system, this means that one of the doors or lids is not properly closed and therefore is not protected by the perimeter surveillance.

Check for correct closing of doors, engine/trunk compartment lids and close the open one without deactivating the security alarm system: the turn signals flashing once indicate that now the door, engine/trunk compartment lids are closed properly and are protected by the perimeter surveillance.



#### CAUTION!

If the turn signals flash 9 times when the security alarm system is activated with doors, front and rear lids properly closed, this means that the self-diagnostic function has detected a malfunction in the system and that you should contact an **Authorized Maserati Dealer** to have the system checked.



## Alarm System Deactivation

Press the lock button on the key to activate the security alarm system.

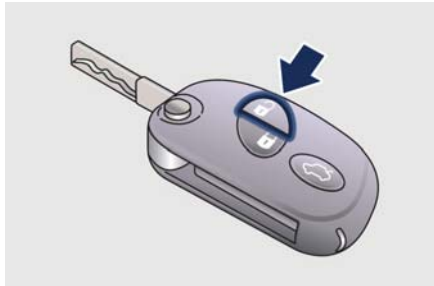

- The turn signals flash twice.
- The system emits a double beep.
- The red LEDs on the front door panels turn off.
- The centralized door locking system is activated and the doors are unlocked.

The security alarm system is off and it is therefore possible to get into the vehicle and start the engine.

Pressing the unlock button twice unlocks the doors and also switches on the low beams for 30 seconds.

### NOTE:

*The security alarm system is not deactivated when the key is turned in the locks.*

## Getting into the Vehicle with Alarm On

When the battery on the radio control case is dead, to access the vehicle you must insert the key in the lock on one of the two front doors and turn it clockwise to unlock it.

The alarm will sound but you will have to continue with the normal starting procedure. The alarm will turn off.

## Anti-intrusion and Anti-lift Protection

The anti-intrusion/anti-lift alarm device may be deactivated by pressing the button, on the dome console, when the key in the ignition switch is in **MAR (ON)** position or within 1 minute from turning the engine off (key in the **STOP (OFF)** position). Deactivation is signaled by the LED on the button flashing for 3 seconds.



### CAUTION!

Anti-intrusion and anti-lift protections override is memorized until the alarm is next activated: therefore, if these protections are overridden but the alarm is not activated immediately, the override will remain memorized until the next time it is activated, regardless of turning the vehicle on/off.

## Security Alarm Memory

If the CODE warning light appears on the display when the vehicle is started, accompanied by the message "Break-in attempt detected" this means that an intrusion has been attempted during your absence. The security alarm system memory is reset when you turn the ignition key.



## Requiring and Setting Additional Key

In order to purchase additional keys with radio control you need to bring with you at the **Authorized Maserati Dealer**:

- all keys with radio control in your possession;
- the Maserati CODE card;
- a personal ID;
- the identification and registration documents proving ownership of the vehicle.

Setting new keys with radio control or re-setting the original ones may only be performed at the **Authorized Maserati Dealer**.

### NOTE:

*The codes of any key with radio control that are not available when the new setting procedure is carried out will be deleted from the memory to prevent any lost or stolen key with radio control being used to disarm the electronic alarm system.*

## Radio Control Battery Replacement

If you press one of the three buttons and this does not activate the corresponding function, before replacing the batteries, check for correct operation of the security alarm system functions using the other remote control.

The recommended replaced battery type is a: CR2032.

To replace the battery proceed as follows:

- Extract the key by pushing the indicated button.



**WARNING!**  
California Proposition 65  
Operating, servicing and maintaining  
a passenger vehicle or off-road vehicle

can expose you to chemicals including such as, engine exhaust, carbon monoxide, phthalates and lead, that which are know to the State of California to cause cancer and birth defects or other reproductive harm. To minimize exposure, avoid breathing exhaust, do not idle the engine except as necessary, service your vehicle in a well-ventilated area and wear gloves or wash your hands frequently when servicing your vehicle. For more information go to: [www.P65Warnings.ca.gov/passenger-vehicle](http://www.P65Warnings.ca.gov/passenger-vehicle)

- Undo the lateral screw securing the battery holder with a small cross-head screwdriver.
- Extract the battery holder.

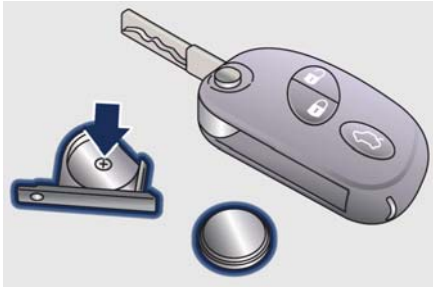

- Remove the battery from its retaining ring.

**ENVIRONMENTAL!**

Batteries contain dangerous materials that could harm the environment. Please dispose of them according to local regulations or at an Authorized Maserati Dealer.

**WARNING!**

**California Proposition 65**  
Operating, servicing and maintaining a passenger vehicle or off-road vehicle can expose you to chemicals including such as, engine exhaust, carbon monoxide, phthalates and lead, that which are know to the State of California to cause cancer and birth defects or other reproductive harm. To minimize exposure, avoid breathing exhaust, do not idle the engine except

as necessary, service your vehicle in a well-ventilated area and wear gloves or wash your hands frequently when servicing your vehicle. For more information go to:  
[www.P65Warnings.ca.gov/passenger-vehicle](http://www.P65Warnings.ca.gov/passenger-vehicle)

**NOTE:**

*Avoid touching the new battery with your fingers. Skin oils may cause battery deterioration. If you touch a battery, clean with alcohol.*

- Fit a new battery of the same type, observing the indicated polarity: match the "+" sign on the battery to the "+" sign on the inside of the battery holder.
- Fit the battery holder into the radio control case and secure it by tightening the retaining screw.

### Radio Frequency Transmitter - General Information

Some countries do not require a specific domestic homologation in the event that the vehicle has already obtained other European homologations.

The homologation number (EEC regulations) of the radio control device is indicated in the picture.

CE 0678

The current device feature is subject to following conditions:

- This device may not cause harmful interference.
- This device must accept any interference received, including interference that may cause undesired operation.

If your transmitter device fails to operate from a normal distance, check for these two conditions:

- A weak battery in the transmitter device. The expected life of the battery in normal use is a minimum of three years.
- Closeness to a radio transmitter such as a radio station tower, airport



transmitter, and some mobile or CB radios.

## Doors



### WARNING!

- For personal security and safety in the event of an accident, or robbery lock the vehicle doors before you drive as well as when parking and leaving the vehicle unattended.
- When leaving the vehicle, always remove the key and lock your vehicle.
- Do not allow children to be in a vehicle unattended or with access to an unlocked vehicle. A child or others could be seriously or fatally injured. Children should be warned not to touch the parking brake trigger, brake pedal or the shift lever.
- Do not leave the key in or near the vehicle, and do not leave ignition switch in the ACC or MAR (ON) position. A child could operate power windows, other controls, or start the engine and the vehicle.
- Before opening a door, make sure the maneuver can be performed safely.

## Opening from the Outside

Turn off the security alarm system and the centralized door locking system by pressing the  unlock button on the radio control case (see chapter “Vehicle Security Alarm” in this section) or insert and turn the key in the lock on one of the front doors.

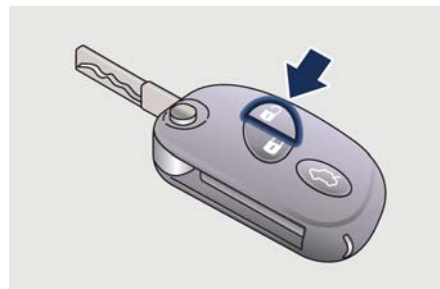

To open the door, press the front button inside each handle. The vehicle is equipped with power locks which move the mechanical parts when pressing this button. As these are electric locks, a slight pressure on the front button will unlock the doors.

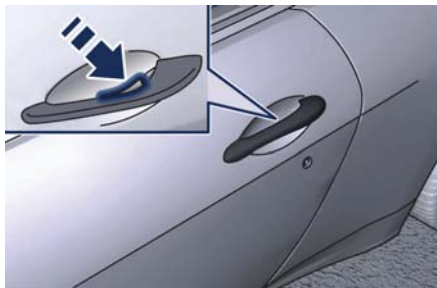

In the event of an emergency (vehicle dead battery or electric system failure) to open the doors, with the locks released, press the rear button inside each handle. Otherwise, if the doors are locked, you must release them by turning the key in the lock to open them, then press the rear button. In this case, being a conventional mechanism, hold the rear button pressed down longer.

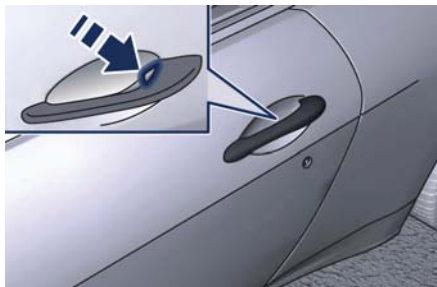

On the door panels, in a position which is visible from the outside, there is a dual-color (green/red) LED E which indicates the status of the locks (locked/unlocked). The red LEDs illuminate for 3 seconds after the locks are engaged and the green LEDs for the same amount of time when they are unlocked.

**NOTE:**

*The door LEDs remain illuminated for approximately 3 seconds and therefore, in normal conditions, they are off.*

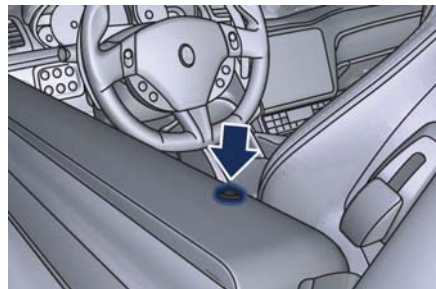

When the security alarm system is turned on and the doors are locked, the LEDs on the doors flash. The radio control device allows you to operate the centralized opening of all the doors or of the driver's door only, depending on the Maserati Touch

Control Plus (MTC+) settings (see "MTC+ Settings" in section "Dashboard Instrument and Controls").

If one or more doors are not properly closed when locking the doors from the outside, they will not be locked, while if the trunk compartment is not properly closed, the doors will in any case be locked.

In both cases, the malfunction will be indicated by the turn signals flashing for a few seconds.

**NOTE:**

- *The interior door locking/unlocking, trunk compartment lid opening and fuel tank door opening buttons are disabled when the doors are locked from the outside.*
- *In the event that the inertia switch activates, the doors are electrically unlocked and the vehicle can be accessed by pressing the rear button inside each handle.*





## Opening from the Inside

To open the door, even if the lock is engaged, pull the internal handle.

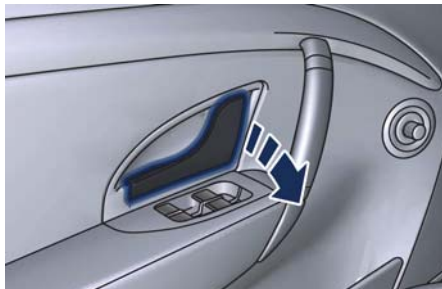

There are two buttons in front of the transmission lever which operate the door locking and unlocking functions:

- : door locking;
- : door unlocking.

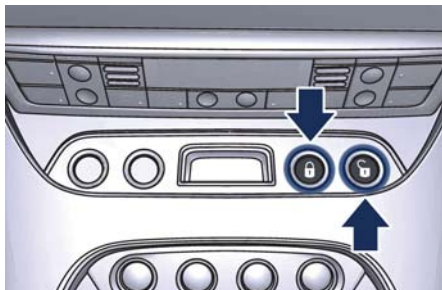

### NOTE:

*By pulling the internal handle on the driver's door, all the locks can be released at the same time or just the driver's door, depending on the MTC+ settings (see "MTC+ Settings" in section "Dashboard Instrument and Controls").*

## Door Open Warning Lights

If the doors and the engine/luggage compartment lids are not closed properly, this is signaled by the illumination of relative symbols on the instrument panel display, accompanied by the messages "Door open" or "Doors open" shown in the picture.

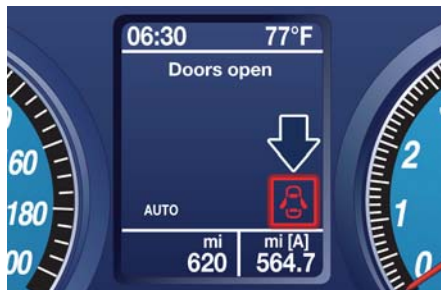

## Door Lock ECU Initialization

Every time the battery is connected or a fuse replaced, you must perform the system initialization procedure to

ensure proper system operation. To perform this procedure, lock and then unlock the doors using the buttons and on the radio control device. For more details, see "Maintenance-Free Battery" in section "Maintenance and Care".

## Door Open Indicator Light

Each door is provided with a reflector fitted on the rear side of the door panel that makes it visible when illuminated by the headlights of a vehicle.

## Signal

Upon exceeding a speed of 3 mph (5 km/h), if one or more doors/lid are open or not properly closed, a warning signal will be activated.

## Door Courtesy Light

Each door panel is fitted with a courtesy light, on the lower part of the door framework, to illuminate the area where passengers enter/exit the vehicle.

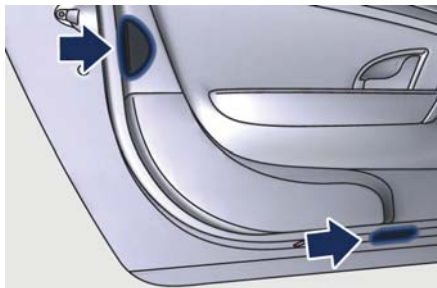

**WARNING!**

Gearshifting is always active and may be performed even when one or more doors, the engine compartment lid or the trunk lid are open. Therefore, in these conditions, take great care to avoid moving the transmission shift lever and so accidentally engage gears.

## Power Windows

The power windows can only be activated when the key in the ignition switch is in the **MAR (ON)** position. The controls for all power windows are located in the armrest of the door on the driver's side. The external switch commands the power window driver's side; the inner switch commands the power window passenger's side.

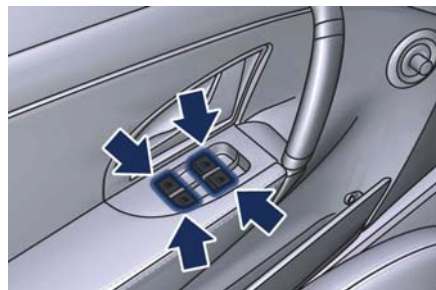

The door on the passenger side only has control for the window on the passenger side.

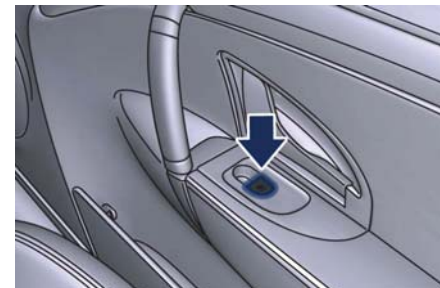
**NOTE:**

- The power window switches will remain active for up to 10 minutes after the key in the ignition switch is turned to the **STOP (OFF)** position. Opening either door will cancel this feature.
- Frequent activations of the power windows could result in a temporary lock out of the motors. In this case, wait a moment before a new activation.
- If the power window is closed when the door is open, the window stops before the upper limit so as not to interfere with the seal when the door is closed.



### WARNING!

- When the door is opened, the window is automatically lowered slightly; when the door is closed again, the window is automatically raised. Always ensure that passengers (especially children) are clear of the windows when opening/closing the doors.
- Improper use of the power windows can be dangerous. Ensure that passengers are clear of the windows before closing them. When leaving the vehicle, always remove the key from the ignition switch to prevent the power windows from being accidentally activated: this could endanger any passengers remaining in the vehicle.
- Never leave unattended children in a vehicle.
- Failure of the soft top temporarily (for approx. 10 mins) prevents movement of the electric windows. Once this period has elapsed, the windows function normally.

## Auto-Down Feature

The driver door power window switch and some model passenger door power window switches have an auto-down feature.

Press the window switch to the second detent, release, and the window will go completely down automatically.

To open the window part way, press the window switch to the first detent and release it when you want the window to stop.

To stop the window from going all the way down during the auto-down operation, pull up on the switch briefly.

## Auto-Up Feature

Lift the window switch to the second detent, release, and the window will go all the way up automatically.

To stop the window from going all the way up during the auto-up operation, push down on the switch briefly.

To close the window part way, lift the window switch to the first detent and release it when you want the window to stop.

### NOTE:

- Any impact due to rough road conditions may trigger the auto reverse function unexpectedly during auto-closure. If this happens, pull the switch lightly to the first detent and hold to close the window manually.
- Before activating the alarm, ensure that all the windows are closed; this will help prevent the alarm being triggered accidentally.



## Reset Auto-Up/Down

Should the auto-up/down feature stop working, the window probably needs to be reset.

To reset auto-up/down, pull the window switch up to close the window completely and push the window switch down to open the window completely.

## If You have to Disconnect the Battery

Before disconnecting the battery, lower the side windows by at least 1-2 in (4-5 cm) to avoid damaging the soft top strip when opening and closing the door.

When the battery is connected, this operation is performed automatically when the door is opened and closed. The windows must remain lowered until the charged battery is reconnected. If the battery is completely discharged when the windows are fully raised, only open the door if absolutely necessary, with the utmost care; do not close the door again until it is possible to lower the window.

## Open and Close the Trunk Lid

### Opening

The trunk compartment lid can be opened from inside or outside the vehicle.

Button which opens the lid from inside, is located to the left of the steering wheel.

It can only be operated when the key is removed from the ignition switch or turned to **STOP (OFF)** or **ACC** position.

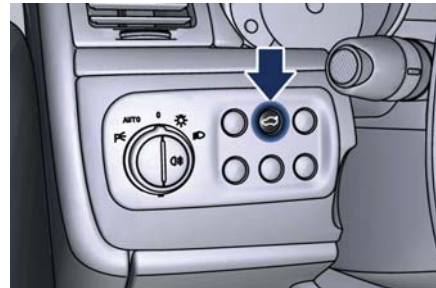

To open the trunk compartment lid from outside, press button on the radio control case: this opens the lock and the trunk lid rises slightly.



To open the trunk lid from the outside, when the security alarm is deactivated and the key is inside the vehicle, simply press the button underneath the license plate light frame.



To avoid accidental activation while the vehicle is moving, it is only possible to open the trunk compartment when the key is removed from the ignition switch or turned to **STOP (OFF)** or **ACC** position.



## Before Starting

Two gas struts facilitate the lid opening. The struts are calibrated to ensure they function correctly with the weights specified by the manufacturer. The arbitrary addition of objects (spoiler, luggage rack etc.) may impair the lid's correct operation and safety.



### WARNING!

When using the trunk compartment, never exceed the maximum loads allowed (see "Technical Data" in section "Features and Specifications"). Also check that the objects contained in the luggage compartment are arranged properly.

The trunk compartment is illuminated by a light that comes on automatically when the lid is opened; switching off is timed.

If the trunk compartment lid is left open, the light switches off after a few minutes. To turn it on again, close the lid and then reopen it.

### NOTE:

*The soft top automatic movement is disabled when the trunk compartment is open.*

## Closing

To close the trunk lid grasp one of the handles as indicated on the inner covering and lower the lid. Then press gently on the outside of the lid, in correspondence of the lock, until hearing it click in place.

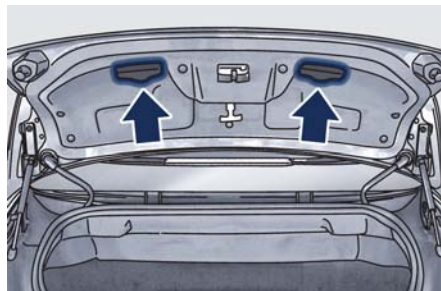

## Emergency Opening

If necessary, the trunk compartment lid can be opened by pulling the small cable, located underneath the left rear seat.

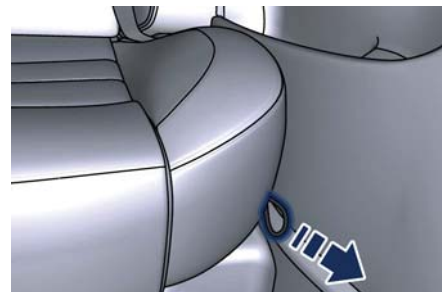

Once you have located the cable and pulled it out from the seat, pull it forward to open the trunk compartment lid.

## Independent Trunk Lid Unlocking

To allow the user to hold only the trunk lid unlocked compared to the doors condition, there is a dedicated feature which can be activated by MTC+ in "Doors & Locks" menu (see "MTC+ Settings" in section "Dashboard Instruments and Controls").



## Trunk Safety



### WARNING!

Do not allow children to have access to the trunk. Always close the trunk lid when your vehicle is unattended. Once in the trunk, young children may not be able to escape. If trapped in the trunk, children can die from suffocation or heat stroke.

### Trunk Lid Emergency Release from inside the Trunk

As a security measure, an internal trunk emergency release lever is connected to the trunk latching mechanism. In the event of a person trapped inside the trunk, the trunk lid can be simply opened by pulling on the phosphorescent handle shown in figures.

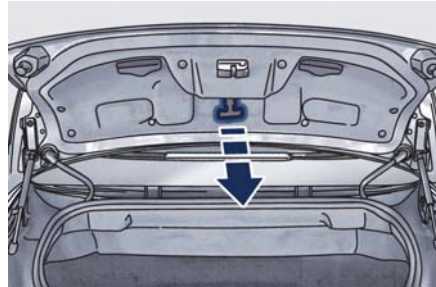

## Open and Close the Hood

### Opening

From inside the vehicle, pull the hood release lever located under the left lower side of the dashboard.

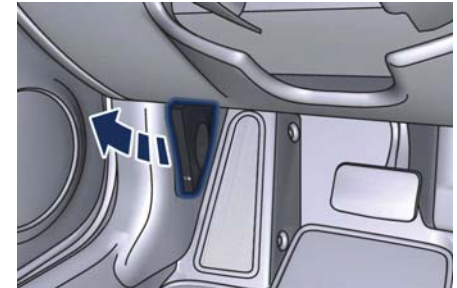

Move to the outside and stand in front of the vehicle front grille. Slightly lift the hood and lift the safety lever as indicated by the arrow. The safety lever is located in the center of the front lid contact area.



Lift the hood completely: this operation is facilitated by two gas struts keeping the fully open position. With the key in the ignition switch in **MAR (ON)** position, the specific red warning light will display on the instrument cluster with the message indicating that the hood is open (see chapter "Instrument Cluster" in section "Dashboard Instrument and Controls").

### Closing

Lower the hood to about 20 cm (8 in) from the contact area of the engine compartment and then drop it. This should secure the inclusion of the latch.



#### CAUTION!

To prevent possible damage, do not slam the hood to close it.



#### WARNING!

- **Be sure the hood is fully latched before driving your vehicle. If the lid is not fully latched, it could open when the vehicle is in motion and block your vision. Failure to follow this warning could result in serious injury or death.**
- **Gear shifting is always active and may be performed even when one or more doors, the hood or the trunk lid are open. Therefore, in these conditions, take great care to avoid moving the transmission shift lever and so accidentally engage gears.**

## Occupants Restraint Systems

The listed occupants restraint systems are some of the most important safety features in your vehicle:

- Three-point seat belts (also called lap and shoulder belts) for the driver and all passengers.
- Front air bags for driver and passenger.
- Seat-mounted side air bags for the driver and front passenger.
- An energy-absorbing steering column and steering wheel.
- Front seat belts incorporate a pretensioner (Emergency Tensioning Device - ETD) that may enhance occupant protection by managing the energy created during an impact.
- Front seat belt retractors are equipped with load limiting devices which control the seat belt reeling out so as to adjust the force exerted on the shoulders while the seat belt is in restraining mode.
- All seat belts system (except the driver's) include Automatic Locking Retractors (ALR), which lock the seat belt webbing into position by extending the belt all the way out



and then adjusting the belt to the desired length to restrain a child seat or secure a large item in a seat. Please pay close attention to the information in this section. It tells you how to use your restraint system properly, to keep you and your passengers as safe as possible. If you are carrying children too small for adult-sized seat belts, the seat belts or the Lower Anchors and Tether for CHildren (LATCH) feature also can be used to hold infant and child restraint systems. For more information on LATCH, refer to “Lower Anchors and Tether for CHildren (LATCH)” in this section.

**WARNING!**

To help provide maximum protection, you are advised to keep the seatback in the most upright position possible and the seat belt close to your chest and pelvis. If the seat belt is loose, in the event of an accident you could move too far forward and could be injured. Travelling with the seatback too far reclined could also be dangerous: even if the seat belts are fastened, they may not work correctly. In fact, the belt itself may not be close enough to your body

and, if it is in front of you, it could cause neck wounds or other injuries in an accident. Additionally, in an accident, the lower section of the belt could press against the upper part of your stomach rather than the pelvic area, causing serious internal injuries.

Here are some simple steps you can take to minimize the risk of harm from a deploying air bag:

- Children 12 years old and under should always ride buckled up in a rear seat.

**WARNING!**

Infants in rear facing child restraints should never ride in the front seat of a vehicle with a passenger front air bag. An air bag deployment can cause severe or fatal injury to infants in that position.

Do not use child seats or child booster cushions/backrests in the front passenger seat. Occupants in the front passenger seat must never sit on the edge of the seat, leaning toward the dashboard or otherwise sit out of position. The occupants' back must be as upright as comfort allows, and must rest against the seatback with the seat belt properly fastened. Feet

must be on the floor (i.e. not on the dashboard, seat or out of the window).

Children that are not big enough to wear the vehicle seat belt properly (see “Child Restraints System” in this section) should be secured in the rear seat in child restraints seats or belt-positioning booster seats. Older children who do not use child restraints seats or belt-positioning booster seats should ride properly buckled up in the rear seat. Never allow children to slide the shoulder belt behind them or under their arm. The safest place for a child that has outgrown the child safety seat is in the rear seat using the standard seat belt in combination with a suitable booster seat if needed so the seat belt is properly located on the child. You should read the instructions provided with your child restraint system to make sure that you are using it properly.

- All occupants should always wear their lap and shoulder belts properly.
- The driver and front passenger seats should be moved back as far as possible to allow the front air bags room to inflate.





- Do not lean against the door or window. Your vehicle has seat-mounted side air bag and, if deployment occurs, they will inflate forcefully into the space between you and the door.
- If the air bag system in this vehicle needs to be modified to accommodate a disabled person, contact an **Authorized Maserati Dealer**.



### **WARNING!**

**In an accident, all occupants can suffer much greater injuries if not properly buckled up. You can strike the interior of your vehicle or other occupants or you can be thrown out of the vehicle. Always be sure you and others in your vehicle are buckled up properly. Buckle up even though you are an excellent driver, even on short trips. Someone on the road may be a poor driver and cause an accident that includes you. This can happen far away from home or on your own street.**

Statistics report that seat belts save lives and help reduce the seriousness of injuries in an accident. Some of the worst injuries happen when people are

thrown from the vehicle. Seat belts reduce the possibility of ejection and the risk of injury caused by striking the inside of the vehicle. Everyone in a motor vehicle should be belted at all times.

### **Three-Point Seat Belts**

All seating positions in your vehicle are equipped with combination lap and shoulder belts.

The belt retractor is designed to lock during very sudden stops or impacts. This feature allows the shoulder part of the belt to move freely with you under normal conditions, conforming to the body of the occupants. However, in an accident, the belt will lock and reduce your risk of striking the inside of the vehicle or being thrown out.

The driver is responsible for respecting, and ensuring that all the other occupants of the car also observe the local regulations concerning the use of seat belts. Always fasten the seat belts before starting the vehicle.

Seat belts are designed to be used by persons whose physical characteristics (age, height, weight) are provided for by established legislation in each country. Anyone who does comply with these provisions may not travel in

the front passenger seat. This also applies to children. Their heads are proportionally heavier and larger than those of adults, while their bones and muscles are relatively undeveloped. To help protect them in case of a collision, they must use special restraint or safety systems, even in the rear seat area.



### **WARNING!**

- **It is forbidden and dangerous to ride in a cargo area. In an accident, people riding in these areas are more likely to be seriously injured or killed.**
- **Do not allow any person to ride in any area of your vehicle that is not equipped with seats and seat belts.**
- **Be sure all passengers are in a seat and using a seat belt properly.**
- **Wearing your belt improperly could make your injuries in an accident much worse. You might suffer internal injuries, or you could even slide out of part of the belt. Follow these instructions to wear your seat belt properly and to keep your passengers safe, too.**





- Two people should never be belted into a single seat belt. People belted together can crash into one another in an accident, hurting one another severely. Never use a lap/shoulder belt for more than one person.
- Remember that, in the event of an accident, the rear seat passengers not wearing the seat belts are not only subject to personal injuries but also represent a serious danger for the front seat occupants.

### Three-Point Seat Belts Use Instructions

- Enter the vehicle and close the door. Sit back and adjust the seat.
- The seat belt latch plate is on the rear door pillar, above the seat on the external side (for front seats) or on the internal side (for rear seats).



#### WARNING!

Before fastening the seat belts, make sure they are correctly fitted into the guide on the front seat backrest, indicated in picture.

- Hold the latch plate and pull the belt across you, make the belt go around your body and when the belt is long enough to fit, insert the latch plate

into the buckle until you hear a "click."

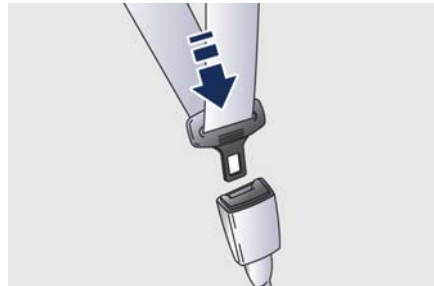
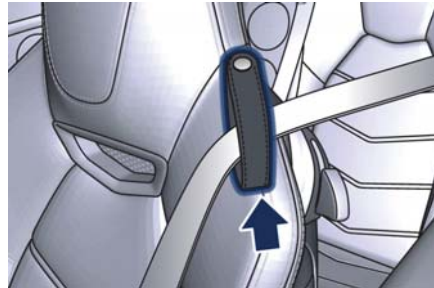

#### WARNING!

- The seat belts height must be adjusted only with the vehicle stationary.
- Do not bring sharp edges in contact with a seat belt. This could reduce their initial strength and cause them

to tear in the event of a crash.

- If a seat belt has been brought in contact with a sharp edge, or has been used to pin something to it, have it immediately replaced by our Authorized Maserati Dealer.
- A belt that is latched into the wrong buckle will not protect you properly. The lap portion of the belt could ride too high on your body, possibly causing internal injuries. Always latch your belt into the corresponding buckle.
- A belt that is too loose will not protect you properly. In a sudden stop, you could move too far forward, increasing the possibility of injury. Wear your seat belt comfortably.
- A belt that is worn under your arm is dangerous. Your body could strike the inside surfaces of the vehicle in an accident, increasing head and neck injury. A belt worn under the arm can also cause internal injuries.
- The lower part must adhere to the pelvis rather than the abdomen of the occupant. To fasten the lap belt pull slightly up the diagonal portion of the shoulder belt. To loosen the lap belt if too tight, tilt the latch



plate and pull on the lap belt. A snug belt reduces the risk of sliding under the belt in an accident.



### WARNING!

- A lap belt worn too high can increase the risk of internal injury in an accident. The belt forces won't impact on the strong hip and pelvic bones, but across your abdomen. Always wear the lap belt as low as possible and keep it comfortable.
- A twisted belt will not protect you properly. In a collision, it could even cut into you. Be sure the belt is straight. If you can't straighten a belt in your vehicle, take it to a Service Center immediately.
- Do not use devices (clips, fastenings etc.) that prevent the seat belts from laying close to the occupants bodies.
- Never carry children on a passengers lap.
- Position the shoulder belt on your chest so that it is comfortable and not resting on your neck. The retractor will withdraw any slack in the belt.
- To release the belt, push the red button on the buckle. The belt will

automatically retract to its stowed position. If necessary, guide the seat belt with your hand while it is rewinding, to prevent it from twisting.



### WARNING!

A frayed or torn belt could break in an accident and leave you with no protection. Inspect the belt system periodically, checking for cuts, frays, or loose parts. Damaged parts must be replaced immediately. Do not disassemble or modify the system. Seat belt/retractor assemblies must be replaced by an Authorized Maserati Dealer after an accident if they have been damaged (bent retractor, torn belt, etc.).

## Three-Point Seat Belt Untwisting Procedure

Use the following procedure to untwist a twisted three point belt.

- Position the latch plate as close as possible to the anchor point.
- At about 0.5 to 1 ft (15 to 30 cm) above the latch plate, grasp and twist the belt 180 degrees to create a

fold that begins immediately above the latch plate.

- Slide the latch plate upward over the folded belt. The folded belt must enter the slot at the top of the latch plate.
- Continue to slide the latch plate up until it clears the folded belt.

## Rear Passengers Seat Belts

The rear seat belts, as the front ones, are automatic with three fastening points and an emergency inertia locking device on the winding unit.

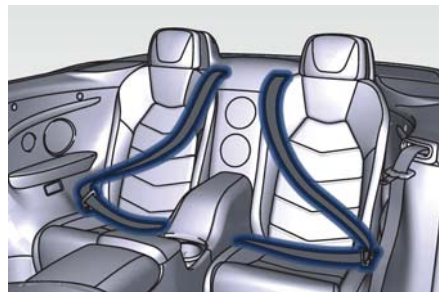

Rear passengers seat belts are equipped with Automatic Locking Retractors (ALR) and can be used to secure a child restraint system. For additional information, see "Installing Child Restraint Systems using the Vehicle Seat Belt equipped with ALR"



under “Child Restraint Systems” in this section.

When the passenger seating position with ALR is being used for normal usage, only pull the belt out far enough to comfortably wrap around the occupant so as to not activate the ALR. If the ALR is activated, you will hear a ratcheting sound as the belt retracts. In this case, allow the belt to retract completely and then carefully pull out only the amount of belt necessary to comfortably wrap around the seat occupant.

Slide the latch plate into the buckle until you hear a “click”.



### WARNING!

- Remember that, in the event of a violent impact, the passengers in the rear seats that are not wearing the seat belts are not only subject to personal injury but they also represent a danger for passengers sitting in the front seats.
- Always fasten the seat belts.
- Traveling without the seat belts fastened significantly increases the risk of serious injury in the event of a collision, even with the air bags.

- In the event of a collision, the seat belts help reduce the possibility of the vehicle’s occupants being thrown against the structures of the passenger compartment or out of the vehicle.
- The air bags are designed to work together with the seat belts, not to substitute them. The front air bags only deploy in the event of certain head-on collisions of sufficient intensity. They may not be activated if the vehicle rolls over, or in the event of rear bumps or minor frontal collisions, or non-frontal collisions.

The belts for the rear seats must be worn as shown in the illustration. The seat belts must be worn keeping your chest in the upright position and lying against the backrest.

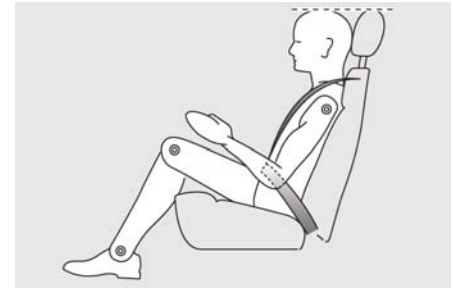
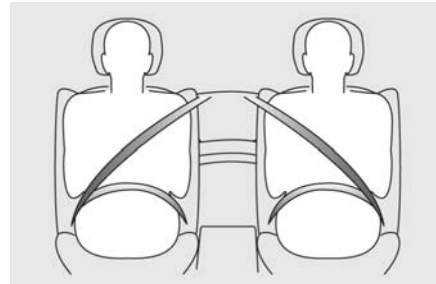

### Using Rear Seat Belt in Automatic Locking Retractor (ALR) Mode

Use the seat belt automatic locking mode anytime a child safety seat is installed in a seating position that has a belt with this feature. Children up to 12 years old or under 5 ft (1,5 m) in height, should be properly buckled up in a child restraint system.

#### Automatic Locking Mode Setting

- Buckle the lap and shoulder belt.
- Grasp the shoulder portion and pull downward until the entire belt is extracted.
- Allow the belt to retract. As the belt retracts, you will hear a clicking sound. This indicates the safety belt is now in the automatic locking mode.



### Automatic Locking Mode Unsetting

Unbuckle the three point seat belt and allow it to retract completely to disengage the automatic locking mode and activate the vehicle emergency locking mode.



#### WARNING!

- **The belt and retractor assembly must be checked by an Authorized Maserati Dealer and must be replaced if the Automatic Locking Retractor (ALR) feature or any other seat belt function is not working properly.**
- **Failure to replace the belt and retractor assembly could increase the risk of injury in collisions.**

### Seat Belt Pretensioners

To further enhance the seat belt efficiency, the vehicle front seat belts are equipped with ETD (Emergency Tensioning Device) pretensioners. These devices “detect”, by means of a sensor, that a violent crash is occurring and retract the belts by a few centimeters. This ensures that the belt properly adheres to the occupants’

bodies before its restraining action starts.

The seat belt locking indicates that the device has activated; a small amount of smoke may be released. The smoke is not toxic and does not indicate the presence of a fire.

The pretensioners are activated in the event of an impact of a certain severity.

The pretensioner only activates when the seat belt is fastened.

After a pretensioner activation, the seat belt can be unfastened as usual, by pressing the button on the buckle. The pretensioner does not require any maintenance or lubrication.

Any change to its original condition invalidates its efficiency. If, in the event of exceptional natural events (e.g. floods, heavy storms, etc.), the device has been in contact with water and sludge, it is mandatory to replace it.

To help ensure the best protection from the pretensioners, wear the belt in such a way that it fits snugly against your chest and pelvis.



#### WARNING!

- **The pretensioners can be deployed only once and activate only when**

**the seat belts are fastened. After activation, contact an Authorized Maserati Dealer to have the pretensioners replaced and for properly discarding the old components.**

- **Do not tamper with the pretensioner components. Any operation must be performed only by qualified and authorized personnel. Always contact an Authorized Maserati Dealer.**



#### CAUTION!

Work on the vehicle which involves, vibrations or localized heating (over 212°F/100°C for 6 hours max.) in the area of the pretensioners may damage or activate them: vibrations due to uneven road surfaces or small obstacles, such as impacts with curbs, do not affect the units. Please contact an **Authorized Maserati Dealer** if any interventions must be carried out.

### Load Limiting Devices

To enhance passive safety, the front seat belt retractors are equipped with load limiting devices which control the seat belt reeling out so as to adjust the





force exerted on the shoulders while the seat belt is in restraining mode.

## Seat Belt Reminder System (SBR)

The SBR system has the function to remind the driver and the front passenger to fasten the seat belts. The function activates with engine running. If the driver or front seat passenger is unbelted, the seat belt reminder light  and related message will turn on in the instrument cluster and remain on until both front seat belts are fastened.



The warning sequence begins after the vehicle speed is over 5 mph (8 km/h) for more than 19 seconds, by blinking the seat belt reminder light  and by sounding an intermittent chime.

Once the sequence starts, it will continue for the entire duration. After the sequence completes, the seat belt reminder light  remain illuminated until the respective seat belts are fastened.

If the opened door on the driver or passenger side is closed and the occupant presence sensor detects a status change from occupant not present to occupant present the system will repeat the warning sequence.

The driver should instruct all other occupants to fasten their seat belts. If a front seat belt is unbuckled while traveling at speeds greater than 5 mph (8 km/h), SBR system will provide both audio and visual notification on the instrument cluster. The front passenger seat SBR is not active when the front passenger seat is not occupied. SBR may be triggered when an animal or heavy object is on the front passenger seat. It is recommended to restrain pets in the rear seat, in pet harnesses or pet carriers that are secured by seat belts, and properly stow cargo.

## Maintaining the Seat Belts

- Always use the seat belts with the belt completely flat, not twisted.

Make sure that the belt can move freely without jamming.

- The seat belts must be replaced following every pretensioner activation and whenever the belt itself shows visible damages or abrasions.
- Wash the seat belts by hand using water and neutral soap, rinse them and let them dry in the shade. Do not use strong detergents, bleaches or colorants and any other chemical substance that may weaken the fibers.
- Make sure the seat belt retractors do not get wet: they will operate properly only if they do not undergo water infiltration.

## Seat Belts and Pregnant Women

Seat belts should also be worn by pregnant women: the risk of injury in the event of an accident is greatly reduced for them and the unborn child if they are wearing a seat belt. The best way to protect the fetus is to protect the mother.

Pregnant women must position the lower part of the belt very low down so that it passes over the pelvis and under the abdomen (see figure).



2



When a safety belt is worn properly, it is more likely that baby will not be hurt in a crash. For pregnant women, as for anyone, the key to making safety belts effective is wearing them properly.



### WARNING!

Pregnant women must carefully observe the above indications, as well as local regulation concerning the use of seat belts.

## Supplemental Restraint System - Air bags

This vehicle has front and side air bags for both the driver and front passenger as a supplement to the seat belt restraint systems.

The driver's front air bag is mounted in the center of the steering wheel in the area shown in the picture. The word "AIRBAG" is embossed on this area for easier recognition.

The passenger's front air bag is mounted in the dashboard, above the glove compartment in the area shown in the picture. The word "AIRBAG" is embossed on this area for easier recognition.

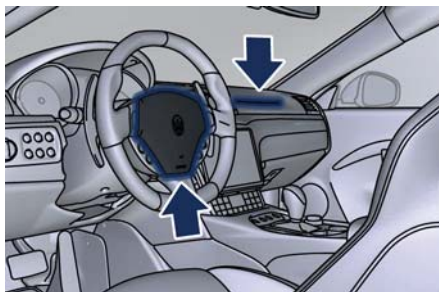

This vehicle is also equipped with side air bag for driver and passenger chest-head protection during a side

impact. The side air bags are mounted in the front seat backrests. The word "AIRBAG" is embossed on this area for easier recognition.



### NOTE:

After any accident, the vehicle should be taken to an **Authorized Maserati Dealer** immediately.

## Air bag System Components

Your vehicle is equipped with the following air bag system components:

- Occupant Restraint Controller (ORC).
- Driver and passenger front air bag.
- Pretensioner for front seat belts.
- Driver and passenger side bag.
- Front and side impact sensors.
- Air bag system failure warning light.
- Diagnostic socket.
- Fuel cut-out inertia switch.



**CAUTION!**

- The Occupant Restraint Controller (ORC) provides for the activation of the pretensioners, front air bags or side air bags, according to the type of impact. Failure of one or more systems to activate is not indicative of a system malfunction.
- The front and/or side air bags may inflate if the vehicle suffers a violent impact involving the underbody area, for example in case of violent impacts against steps, sidewalks, speed bumps, or when the vehicle falls into potholes, or similar.
- The air bags release a small amount of powder during deployment. This powder is not harmful and does not indicate the presence of a fire; in addition, the surface of the deployed air bag and the interior of the vehicle may be covered with a powdery residue: this powder may irritate your skin and eyes. In case of contact, wash the affected parts with running water and neutral soap.

**Front Air bags****WARNING!**

**The air bag is not a substitute for the seat belts. Correct use of the seat belts, in combination with the air bag, will offer protection for the driver and passenger in the front seat in the event of a head-on collision.**

The air bag system is composed of two cushions that are designed to inflate almost instantaneously. One is on the driver's side, in the center of the steering wheel, and the other is on the passenger side, inside the dashboard.

The front air bags of your vehicle have been designed to inflate in two stages. This allows the air bag to have different rates of inflation based on the crash severity, as assessed by the air bag control unit.

The **driver's air bag** is designed to be deployed in certain head-on collisions according to the following strategy.

- For low severity crashes, the air bag control unit will not deploy the air bag.

- For crashes of higher severity, the control unit will deploy the driver air bag in low energy mode.
  - For crashes of even higher severity, the control unit will deploy the driver air bag in high energy mode.
- The **front passenger's air bag** is designed to be deployed in certain head-on collisions according to the following strategy.

- For low severity crashes, the air bag control unit will not deploy the air bags.
- For crashes of higher severity, the control unit will deploy the air bag in low energy mode.
- For crashes of even higher severity, the control unit will deploy the air bag in high energy mode.

**WARNING!**

- **Never place an object over or near the driver and passenger air bags. In the event that the passenger air bag is deployed, it will project any object over it, or near it, in the passenger compartment at very high speed. The object will be transformed into a projectile propelled in the passenger compartment. This could**

*(Continued)*



*(Continued)*  
cause serious injuries.

- Do not tamper or damage the air bag modules. If, for any reason, an air bag cover gets damaged, have the air bag module immediately checked by an Authorized Maserati Dealer.
- Activation of a damaged module could cause serious or fatal injuries. Please note that your vehicle is not capable of automatically detecting damage to the air bag cover.

### Operation and Replacement

The air bags are controlled by the OCR that is designed to activate them in the case of a head-on collision of sufficient force.

In the event of a collision with an impact force that causes deceleration exceeding the value set for the internal sensor, the OCR will transmit a signal to deploy the air bags. The air bags will begin to inflate, breaking the cover along the breakage line and will inflate completely in a few milliseconds. Once inflated, they will serve as a protection between the driver and/or passenger and structures that could cause injury.

The air bags deflate immediately afterward.

### NOTE:

*When the system starts operating, gases are released in the form of fumes, together with the gas used for inflating the air bags. These gases are not harmful.*



### WARNING!

**California Proposition 65 Operating, servicing and maintaining a passenger vehicle or off-road vehicle can expose you to chemicals including such as, engine exhaust, carbon monoxide, phthalates and lead, that which are know to the State of California to cause cancer and birth defects or other reproductive harm. To minimize exposure, avoid breathing exhaust, do not idle the engine except as necessary, service your vehicle in a well-ventilated area and wear gloves or wash your hands frequently when servicing your vehicle. For more information go to:**  
[www.P65Warnings.ca.gov/passenger-vehicle](http://www.P65Warnings.ca.gov/passenger-vehicle)



### CAUTION!

- Do not cut or tamper with the connectors of the air bag harness or on the air bag modules.
- Do not cover the steering wheel and the top part on the instrument cluster on the passenger's side with any tape or label, or treat it in any way.
- Never remove the steering wheel. If necessary, this procedure should only be performed by an **Authorized Maserati Dealer**.
- All the air bag system components must be replaced after an accident that has caused air bag deployment. Following an accident not involving air bag activation, you must contact an **Authorized Maserati Dealer** to have the system checked and replace any system components that may be damaged or malfunctioning.



### WARNING!

**Damaged or defective components of the air bag system cannot be repaired and must be replaced.**





Improper intervention involving the system components can cause failures or undesired activation of the air bags with damage resulting.

The air bag system components have been specially designed for this specific vehicle model. Do not attempt to use them on other vehicles, as this could cause serious injuries to passengers in the event of an accident. To scrap the vehicle, please contact an **Authorized Maserati Dealer** to have the air bag system disposed of properly.

If the vehicle has been stolen or there has been an attempted theft, have the air bag system checked by an **Authorized Maserati Dealer**.



### WARNING!

The air bag modules must be replaced at the expiration date indicated in the label on the right-hand side of the dashboard, even if the vehicle was not involved in collisions.

Please contact an **Authorized Maserati Dealer** for replacement of the air bag system when this date approaches.

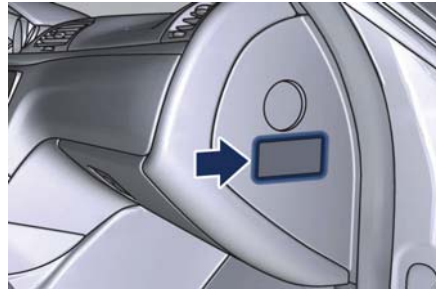

The labels applied on the external side of the sun visors and on dashboard indicate that the air bag system is installed.

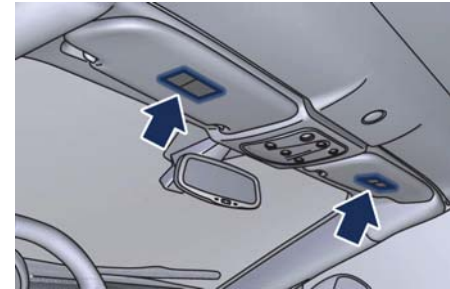
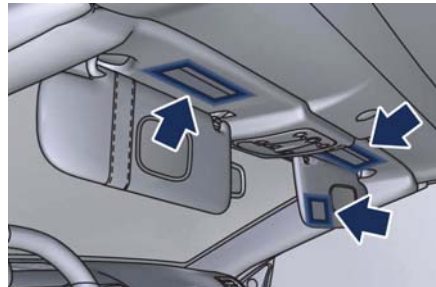

The label hanging from the glove box can be removed.

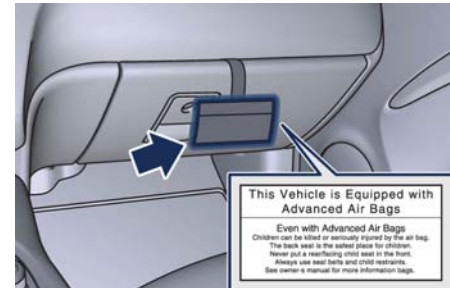

### Side Air bags

The side air bags have been designed to help enhance the protection level provided to occupants traveling in the front seats in the event of certain medium-high severity collisions.

They consist of an instantaneously inflating air bag (side bag) housed in the front seat backrests.



In the event of a side impact, the Occupant Restraint Controller (ORC) processes the signals coming from side sensors and activates air bag deployment when necessary.

The air bag deploys almost instantaneously, placing itself between the occupants and the side of the vehicle. The air bag deflates immediately afterward.

In the case of low-severity side collisions (for which the restraining action of the seat belts provides adequate protection), the air bags do not deploy.

The side air bags are not a substitute of the seat belts but rather act in combination with them. As a consequence, the seat belts must always be worn as provided for by applicable legislation in Europe and in most non-European countries.



### WARNING!

- If the  warning light comes on while driving (fault signal), stop the vehicle and contact an Authorized Maserati Dealer to have the system checked.
- In the event of a collision with consequent air bag deployment,

**contact an Authorized Maserati Dealer for replacement of the entire safety system, Occupant Restraint Controller (ORC), seat belts, pretensioners, and to have the vehicle electrical system checked.**

- **Any and all inspections, repairs and replacements regarding the air bag must be performed by an Authorized Maserati Dealer.**

### NOTE:

- *To scrap the vehicle, please contact an **Authorized Maserati Dealer** in order to have the air bag system deactivated.*
- *If the vehicle is sold, the new owners must read the above described instructions for use and warnings on this "Owner's Manual" that is an integral part of the car.*



## Occupant Restraint Controller (ORC)

The Occupant Restraint Controller (ORC) determines if deployment of the front air bags and/or side air bags in a frontal or side collision is required. Based on the impact sensor's signals, the central electronic ORC deploys the front air bags, the side air bags and

seat belt pretensioners, as required, depending on the severity and type of impact.

The ORC monitors the readiness of the electronic parts of the air bag system whenever the key in the ignition switch is in the **MAR (ON)** position. If the key is in the **STOP (OFF)** position, in the **ACC** position, or not active, the air bag system is not activated and the air bags will not inflate.

The ORC contains a backup power supply system that may deploy the air bags even if the battery has low power or it becomes disconnected prior to deployment. When starting the vehicle, ORC turns on the  air bag warning light on the instrument cluster for approximately 4 to 8 seconds for a test.

After the test, the  air bag warning light will turn off. If the ORC, during the diagnosis phase detects a malfunction that could affect the air bag system, it turns on the  air bag warning light and the "Airbag failure go to dealer" message either momentarily or continuously. The diagnostics also record the nature of the malfunction. A beep will sound if the  air bag warning light illuminates again after initial startup.



The <sup>AIR BAG</sup> air bag warning light monitors the internal circuits and interconnecting wiring associated with air bag system electrical components.



### WARNING!

Ignoring the <sup>AIR BAG</sup> air bag warning light and message in your instrument cluster could mean you won't have the air bags to protect you in a collision. If the light does not come on as a bulb check when the ignition is first turned on, stays on after you start the engine, or if it comes on as you drive, have an authorized Service Centre service the air bag system immediately.

## General Warnings



### WARNING!

- When the key in the ignition switch is turned to the MAR (ON) position, the <sup>AIR BAG</sup> warning light illuminates, but it must turn off after approx. 5 seconds. If this warning light does not illuminate, if it remains permanently on or if it illuminates while driving, contact an Authorized Maserati Dealer immediately.
- Always drive keeping your hands on the steering wheel rim so that, in the case of activation, the air bag can deploy without encountering obstacles which may cause serious injuries.
- Do not drive with your body bent forward but keep the seatback in the upright position and fully resting your back against it.
- Do not apply stickers or other objects to the steering wheel or the passenger's air bag compartment.
- Do not travel with objects in your lap, in front of your chest or especially with a pipe, pencil or other object held in your mouth; In the event of a collision with air bag deployment these objects may cause serious injuries.
- Do not cover the front seat backs with clothes or covers.
- Note that with the key in the ignition switch turned to MAR (ON) position, even with the engine off, the air bags may activate even if the vehicle is stationary, if it is run into by another vehicle. Therefore, even with the vehicle stationary, children must be secured by the specific child restraint systems installed on the passenger seat. In addition, the air bags will not activate in the event of a collision with the vehicle stationary and the key removed from the ignition switch; failure of the air bags to deploy in these circumstances is not indicative of a system malfunction.
- If the vehicle was stolen or its theft attempted, if it was vandalized or involved in flooding, contact an Authorized Maserati Dealer to have the air bag system checked.
- If incorrect operations are performed on the electrical system, the air bag may activate and cause injuries to anyone in the vicinity.
- The air bags are not a substitute of

*(Continued)*



*(Continued)*  
 the seat belts but provide supplementary protection. Moreover, in the event of head-on collisions at low speed, side impacts, rear collisions or rollovers, the passengers are protected only by the seat belts, which therefore must always be fastened.

- The air bags are not a substitute of the seat belts but provide supplementary protection. Moreover, in the event of head-on collisions at low speed, side impacts, rear collisions or rollovers, the passengers are protected only by the seat belts, which therefore must always be fastened.
- Do not wash the seats with water or pressurized steam (by hand or in the automatic seat wash stations).
- Do not hang rigid objects on the cloth hooks and on the handholds.
- Do not fit sunshades of any kind on the windows or door panels.



### WARNING!

California Proposition 65  
 Operating, servicing and maintaining a passenger vehicle or off-road vehicle

can expose you to chemicals including such as, engine exhaust, carbon monoxide, phthalates and lead, that which are know to the State of California to cause cancer and birth defects or other reproductive harm. To minimize exposure, avoid breathing exhaust, do not idle the engine except as necessary, service your vehicle in a well-ventilated area and wear gloves or wash your hands frequently when servicing your vehicle. For more information go to:  
[www.P65Warnings.ca.gov/passenger-vehicle](http://www.P65Warnings.ca.gov/passenger-vehicle)

### Transport of persons with disability

If it is necessary to modify the advanced air bag system of your vehicle to accommodate a person with disabilities, contact the **Authorized Maserati Dealer**.



### WARNING!

- The air bag system of your vehicle is not designed to protect adults with disabilities that require deactivation of the passenger or driver air bag.
- If you are or another occupant is an adult with a medical condition that

requires air bag deactivation, please contact an Authorized Maserati Dealer.

- As long as the air bag is activated, persons with disabilities are advised not to travel in the front seat in order to avoid the risk of serious injuries or death, even in minor crashes.

### Event Data Recorder (EDR)

This vehicle is equipped with an event data recorder (EDR). The main purpose of an EDR is to record, in certain crash or near crash-like situations, such as an air bag deployment or hitting a road obstacle, data that will assist in understanding how a vehicle's systems have performed.

The EDR is designed to record data related to vehicle dynamics and safety systems for a short period of time, typically 5 seconds or less.

The EDR in this vehicle is designed to record such data as:

- how various systems in your vehicle were operating;
- whether or not the driver and passenger safety belts were buckled/fastened;



- how far (if at all) the driver was depressing the accelerator and/or brake pedal; and
  - how fast the vehicle was traveling.
- These data can help provide a better understanding of the circumstances in which crashes and injuries occur.

**NOTE:**

*EDR data are recorded by your vehicle only if a non-trivial crash situation occurs; no data are recorded by the EDR under normal driving conditions and no personal data (e.g., name, gender, age, and crash location) are recorded. However, other parties, such as law enforcement, could combine the EDR data with the type of personally identifying data routinely acquired during a crash investigation.*

To read data recorded by an EDR, special equipment is required, and access to the vehicle or the EDR is needed.

In addition to the vehicle manufacturer, other parties, such as law enforcement, that have the special equipment, can read the information if they have access to vehicle or the EDR.

## Active Roll Bars

The active roll bars that equip the vehicle have been designed for protecting passengers in the event of a vehicle rollover.

They are fitted behind the rear seat headrests, usually in a hidden position, and are activated by a specific ECU which, only in the case of high-severity rollover, deploys them in a few tenths of a second. A cross member then locks them in this position.

The roll bars have been designed in such a way that they can be fully deployed also with the soft top closed. This is ensured by a device which breaks the rear window when it comes in contact with it.

In combination with the windshield outer frame, they help creating an anti-intrusion safety cell.

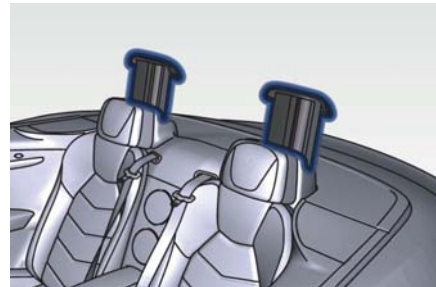

In addition to being deployed in the case of rollovers around the vehicle longitudinal axis (as shown in the figure) the active roll bars activate as a precautionary measure in the event of sufficiently severe side and rear collisions, and in all cases where the battery might be disconnected. They do not activate in the event of spinning.

**WARNING!**

- **The active roll bars do not prevent the risk of the occupants being thrown out of the vehicle or hitting against its internal structures. Only the seat belts are designed for these purposes and must always be properly fastened when traveling.**

*(Continued)*



(Continued)

- Passengers traveling in the rear seats must never travel with their head resting on the roll bars or sitting on them. If the roll bars are deployed, passengers traveling in these positions would be exposed to the risk of severe injuries.
- We recommend that you do not place stickers or other objects on top or in the vicinity of the roll bars, as these could delay or inhibit roll bar deployment. In addition, these objects could be propelled inside the passenger compartment at very high speeds, which may jeopardize the occupants personal safety.
- Active roll bar is a device with pyrotechnic activation: it cannot be repaired. After activation, the roll bar must be replaced. Contact an Authorized Maserati Dealer to have the system properly repaired.
- As a consequence of incorrect repairs on the electric system, the active roll bars could possibly activate causing injuries to persons in the vicinity.
- Never remove or tamper with the system components. Any and all operations must be performed only by qualified and authorized personnel. Always contact an Authorized Maserati Dealer.
- If the vehicle was stolen or its theft attempted, if it was vandalized or involved in flooding, contact an Authorized Maserati Dealer to have the active roll bar system checked.

## Child Restraint Systems

### NOTE:

*A child restraint system can help protect a child in a vehicle so ensure that the child restraint selected has a certification label applicable to FMVSS 213 and 225 in the U.S., or CMVSS 213 and 210.2 in Canada.*

Everyone in your vehicle must be buckled up all the time, including babies and children. Every state in the United States and all Canadian provinces require that small children ride in proper restraint systems. Please be reminded that you can be prosecuted for ignoring this law. Children 12 years or younger should ride properly buckled up in a rear seat, if available. According to crash statistics, children are safer when properly restrained in the rear seats rather than in the front.



### WARNING!

**In a collision, an unrestrained child, even a baby, can become a projectile inside the vehicle. The force required to hold even an infant on your lap could become so great that you could**





**not hold the child, no matter how strong you are. The child and others could be badly injured. Any child riding in your vehicle should always be in a proper restraint system suitable for the child's size.**

There are different sizes and types of restraint systems for children from newborn size to the child almost large enough for an adult safety belt. Always refer to the manual provided with child seat to ensure it is the proper type according to the travelling child. Use the restraint system that is correct for your child.

## Infants and Child Restraints

Safety experts recommend that children ride rearward-facing in the vehicle until they are two years old or until they reach either the height or weight limit of their rear-facing child seat.

Two types of child restraint systems can be used rearward-facing: infant carriers and convertible child seats. The infant carrier is only used rearward-facing in the vehicle. It is recommended for children from birth until they reach the weight or height limit of the infant carrier.

Convertible child seats can be used either rearward-facing or forward-facing in the vehicle. Convertible child seats often have a higher weight limit in the rearward-facing direction than infant carriers do, so they can be used rearward-facing by children who have outgrown their infant carrier but are still younger than at least two years old. Children should remain rearward-facing until they reach the highest weight or height allowed by their child seat. Both types of child restraint systems are fixed to the car by the lap/shoulder belt or the LATCH child restraint anchor system. Refer to "Lower Anchors and Tether for Children (LATCH)" in this section.



### WARNING!

- **Never place a rear-facing infant seat in front of an air bag. A deploying of the passenger front air bag can cause death or serious injury to a child 12 years or younger, including a child in a rearward-facing infant seat.**

- **Only use a rearward-facing child restraint in a vehicle with a rear seat.**

## Older Children and Child Restraints

Children who are two years old or who have outgrown their rear-facing child seat can ride forward-facing in the vehicle. Forward-facing child seats and convertible child seats used in the forward-facing direction are for children who are over two years old or who have outgrown the rear-facing weight or height limit of their rear-facing child seat.

Children should remain in a forward-facing child seat with a harness for as long as possible, up to the highest weight or height allowed by the child seat. These child seats are also fixed to the car by the lap/shoulder belt or the LATCH child restraint anchorage system. Refer to "Lower Anchors and Tether for Children (LATCH)" in this section. All children whose weight or height is above the forward-facing limit for the child seat should use a belt-positioning booster seat until the vehicle's seat belts fit properly. If the child cannot sit with knees bent over



the vehicle's seat cushion while the back is against the seatback, they should use a belt-positioning booster seat.

The child and belt-positioning booster seat are fixed to the car by the lap/shoulder belt.

### Children Too Large for Booster Seats

Children who are large enough to wear the shoulder belt comfortably and whose legs are long enough to bend over the front of the seat when their back is against the seatback should use the lap/shoulder belt in a rear seat.

- Make sure that the child is upright in the seat.
- The lap portion should be low on the hips and as snug as possible.
- Check belt fit periodically. A child's squirming or slouching can move the belt out of position.
- If the shoulder belt contacts the face or neck, move the child closer to the center of the vehicle. Never allow a child to put the shoulder belt under an arm or behind their back.

#### NOTE:

For additional information, refer to [www.seatcheck.org](http://www.seatcheck.org) or call 1-866-SEATCHECK. Canadian residents should refer to Transport Canada's website for additional information: <http://www.tc.gc.ca/roadsafety/safedrivers/childsafety/index.htm>



#### WARNING!

- **Improper installation can lead to failure of an infant or child restraint. It could come loose in a collision. The child could be badly injured or killed. Follow the restraint manufacturer's directions exactly when installing an infant or child restraint.**
- **A rearward-facing child restraint should only be used in a rear seat. A rearward-facing child restraint in the front seat may be struck by a deploying passenger air bag, which may cause severe or fatal injury to the infant.**

### Here are Some Tips on Getting the Most Out of Your Child Restraint

- Before buying any restraint system, make sure that it has a label

certifying that it meets all applicable Safety Standards. Maserati also recommends that you make sure that you can install the child restraint in the vehicle where you will use it before you buy it.

- The restraint system must be appropriate for your child's weight and height.
- Check the label on the restraint system for weight and height limits.
- Carefully follow the instructions that come with the restraint system.
- If installed improperly, it may not work when needed.
- Fit the child into the seat according to the child restraint manufacturer's directions.



#### WARNING!

**When your child restraint system is not in use, secure it in the vehicle with the seat belt or remove it from the vehicle. Do not leave it loose in the vehicle. In a sudden stop or accident, it could strike the occupants or seatbacks and cause serious personal injury.**





## Installing Child Restraint Systems using the Vehicle Seat Belt equipped with ALR

All the passenger seat belts are equipped with an Automatic Locking Retractor (ALR) to secure child protection through a Child Restraint System (CRS). These types of seat belts are designed to keep the lap portion of the seat belt tight around the child restraint seat avoiding to use a locking clip.

The ALR will make a ratcheting noise if the entire belt is pulled out of the retractor in order to enable the belt to retract subsequently. For additional information on ALR, see "Using Seat Belt in Automatic Locking Retractor (ALR) Mode" in "Occupants Restraint Systems" in this section.

To install a Child Restraint System with ALR, pull enough of the belt out of the retractor leading it through the belt path of the protection device. Slide the latch into the buckle until it clicks, then remove the entire safety belt from the retractor in order to rewind. While rewinding a click will indicate the safety belt is now in Automatic Locking mode.

Exert then a traction on the exceeded lap section of the belt in order to

tighten it around the child restraint seat. All seat belts will loosen over time, it is therefore necessary to check them periodically and set them properly.

## Lower Anchors and Tether for Children (LATCH)

Your vehicle's rear outboard seats are all equipped with the child restraint anchorage system called LATCH. The LATCH system allows the child restraint systems to be fixed without using the vehicle's seat belts, instead fixing the child restraint system to the vehicle structure, using lower anchorages shown in picture.



LATCH-Compatible child restraint systems are now available. You should never install LATCH child seats so that two seats share a common lower anchorage.

If your child restraints are not LATCH-Compatible, install the restraints using the vehicle's seat belts.

### NOTE:

- You can install a standard and a LATCH system child seat at the same time (one in each outer rear seat).
- No more than two standard child seats or two LATCH system type child seats can be installed on the rear seats.
- Only standard type child seats can be mounted on the front passenger seat.

## Installing a LATCH- Compatible Child Restraint System

The lower LATCH anchorages are "U-shaped" metal rings located on the rear seat where the cushion meets the seatback just below the symbol shown in the picture, but are not visible. You will find them if you run your finger along the intersection of the seatback and seat cushion surfaces.

Follow the child restraint manufacturer's instructions provided with the child restraint system. The lower Isofix anchorages are "U" metal rings located on the rear seat in the area between cushion and seatback, but are not visible. You will



easily feel them if you run your finger along the intersection of the seatback and seat cushion surfaces.

To install a LATCH-Compatible child restraint seat **facing-backwards** proceed as follows:

- Make sure that the release lever on the back of child seat is in the standby position (retracted).
- Align the anchoring points on the child seat to the "U" lower metal rings on the vehicle seat then push the child seat backward until you hear it click and lock into place.
- Check that the child seat is correctly locked by trying to move it with strength. The incorporated safety mechanisms prevent the child seat from being improperly fitted if only one of the attachment fittings is locked.

The child must be then secured by the child seat harness.



For installation **facing-forward** of a child seat to the "U" lower metal rings of the vehicle rear seat, proceed as indicated for the facing-backwards child seat.



**NOTE:**

*For any further details on installation and/or use, refer to the instructions provided with the child seat.*



**WARNING!**

- Fit the child seat when the car is stationary. The child seat is correctly fixed to the anchorages when hearing a click. Follow the instructions for assembly, disassembly and positioning that the manufacturer must supply with the child restraint system.
- An incorrectly anchored tether strap could lead to increased head motion and possible injury to the child. Use only the anchor position directly behind the child seat to secure a child restraint top tether strap.

**NOTE:**

*When using a LATCH-Compatible child restraint system, please ensure that all seat belts not being used for occupant restraints are stowed and out of reach of children.*



**WARNING!**

- Improper installation of a child restraint system to the LATCH anchorages can lead to failure of an infant or child restraint. The child



could be badly injured or killed. Follow the child restraint manufacturer's directions exactly when installing an infant or child restraint system.

- Child restraint anchorages are designed to withstand only those loads imposed by correctly fitted child restraints. Under no circumstances are they to be used for adult seat belts, harnesses, or for attaching other items or equipment to the vehicle.

### Important Safety Notice for Transporting Children

- Install the child seat on the rear seat as this is the safest position in case of collisions.
- Keep the instructions in the vehicle together with the documents and this owner's manual. Do not use a child restraint system which does not contain instructions for use.
- Every child has to use one child restraint system; never carry two children using only one child seat.
- If using the vehicle seat belt, always check that the belt does not restrain the child's throat.

- Firmly pull the seat belt to check that it is correctly buckled.
- Never allow a child to seat improperly or to unbuckle the seat belt while driving.
- Never allow a child to wear the shoulder portion of the belt under the arms or behind the back.
- Never carry children on your lap, not even newborns. No one can restrain a child in the event of an accident.
- In case of accident, replace the child seat with a new one.

### Transporting Pets

Air bags deploying in the front seat could harm your pet. An unrestrained pet will be thrown about and possibly injured, or injure a passenger during panic braking or in an accident. Pets should be restrained in the rear seat in pet harnesses or pet carriers that are secured by vehicle seat belts.



## Park Assist

To assist the driver during parking maneuvers, the vehicle is equipped with four sensors housed in the rear bumper and four sensors in the front bumper.

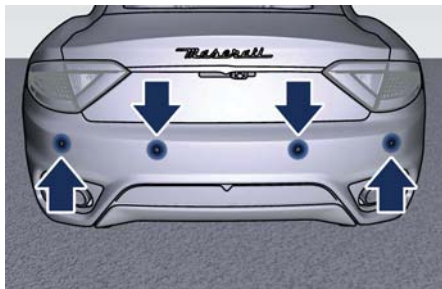
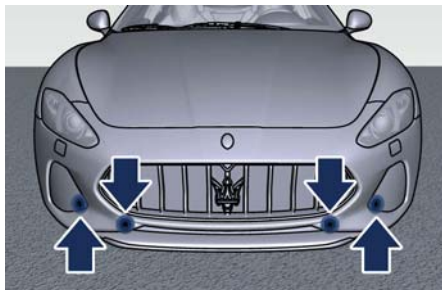

Besides the use of the sensors available on the bumpers, the vehicle is also equipped with a rear parking camera.

For more details, see chapter "Rear Parking Camera" in this section. During parking maneuvers, the parking sensors provide the driver with information on the distance between obstacles found behind and in front of the vehicle. The information about the obstacle distance is given to the driver by means of acoustic and visual signals. The acoustic signals generated by the system add to the driver's field of vision, allowing him to avoid hitting any obstacles during maneuvers.



### WARNING!

- However, the driver remains responsible during parking maneuvers and in other potentially dangerous situations. The system has actually been designed only as a supplementary aid during parking maneuvers, since it allows the driver to detect obstacles outside his field of vision.
- Extreme caution is required in case of obstacles whose shape and volume are susceptible to be incorrectly detected. When starting the vehicle after parking, these obstacles might not be detected if they are already close to the bumper.

**Always stop when the acoustic signal becomes steady.**

## Stop & Go Feature

This function is enabled by the manufacturer and it can be disabled by the MTC+ (see chapter "MTC+ Settings" in section "Dashboard Instruments and Controls"), select and tick the "Stop & Go Parking Sensors" feature.

When vehicle speed is equal to or lower than 6 mph (10 km/h), this function helps the driver under special traffic conditions as it signals that the vehicle before you is at a min. distance.

## System with Enabled Stop & Go Feature

When the "Stop & Go" feature is enabled through the MTC+, all sensors are automatically enabled with the key in the ignition switch turned to **MAR (ON)** position, but they are not displayed on the instrument cluster. When the R (Reverse) gear is engaged or an obstacle is detected, the corresponding detection areas are displayed on the instrument cluster. As soon as the R (Reverse) gear is disengaged, all sensors are still active:



the rear ones for approx. 10 seconds or until a speed of approx. 6 mph (10 km/h) is exceeded, and the front ones until a speed of approx. 6 mph (10 km/h) is exceeded. When driving at a speed equal to or lower than 6 mph (10 km/h), as soon as the system detects an obstacle, the front sensor detection areas are displayed, and the acoustic signals start to be emitted. If no obstacle is detected for 10 seconds, the displayed information disappears. Front sensors can be temporarily disabled by pressing **P** button in the control panel next to the steering wheel. The system will emit an acoustic signal, and the button LED will turn off. If **P** button is pressed again, the acoustic signal and the LED coming on will warn the driver that sensors are now active again.

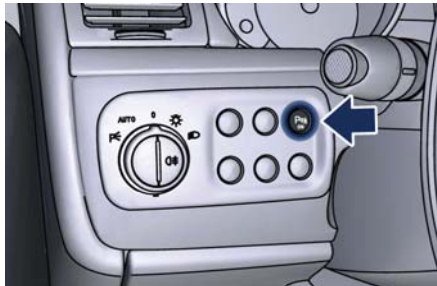

## System with Disabled Stop & Go Feature

With the "Stop & Go" feature disabled through the MTC+, rear sensor enabling/disabling logic is kept unchanged. As for front sensors, the "Stop & Go" function signal status will not be changed if the **P** button in the control panel next to the steering wheel is pressed and front sensors will be active and displayed on the instrument cluster until speed will be equal to or lower than 6 mph (10 km/h).

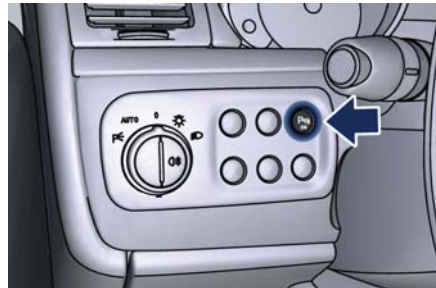

Once this speed limit is exceeded, if vehicle slows down below 6 mph (10 km/h), sensors will not be enabled. To enable them again, press **P** button.

### NOTE:

Front sensors are enabled only when **P** button LED is illuminated. In addition, any pressing of **P** button when vehicle speed is above 6 mph (10 km/h) will be ignored by the system.

## Obstacle Signalling

The acoustic signals are emitted by two buzzers, one under the dashboard and one in proximity of the luggage shelf.

When the obstacle is located at a distance of less than 14 in (35 cm) from the bumper, the beep is continuous. The warning beep stops immediately if the distance between the vehicle and the obstacle increases.

The tone cycle is constant if the distance measured by the central sensors remains unaltered. If this occurs with the lateral sensors, the signal stops after approximately 7 seconds, to prevent for example continuous beeps in the event of maneuvers alongside walls.

The distance from the obstacles can also be graphically shown on the instrument cluster display by means of an image that shows the vehicle surrounded by explanatory symbols of



the distance (maximum/average/minimum) and the position (front/rear/central/side) of the obstacle detected.

The color represents the distance, while the field represents the position. The green color represents the maximum distance detected, the yellow color the medium distance and the red color the minimum one. The rear sensors are not shown in the image on the instrument cluster display if only the front sensors are active.



### WARNING!

**For the system to operate correctly the sensors positioned on the bumper must be kept clean (remove any mud, dirt, snow or ice).**



## Sensor Range

The sensors allow the system to monitor the front and rear of the vehicle; they are positioned so as to monitor the central and lateral zones at the front and at the rear of the vehicle.

In the event of an obstacle located in a central area, this will be detected at distances of less than 35 in (0,9 m) at the front and 59 in (1,50 m) at the rear, depending on the type of obstacle and its dimensions.

If the obstacle is located in a lateral position, it will be detected at distances of less than 31 in (0,8 m).

## Failure Indicators

The system ECU checks all the components every time R (Reverse) gear is engaged.

In the event that the parking sensors fail, the relative **P** warning light and message illuminate on the instrument cluster display.

In the event of a failure signal, stop the vehicle and turn the key in the ignition switch to **STOP (OFF)** position. Then try cleaning the sensors or moving the vehicle away from any possible ultrasound sources (e.g. pneumatic truck brakes or pneumatic

hammers) and rotate the key to the **MAR (ON)** position. So, if the operating failure cause has been eliminated, system full operation will be recovered. If however, the failure beep continues, contact an **Authorized Maserati Dealer** to have the system checked.

## Cleaning the Park Assist Sensors

When cleaning the sensors, take special care not to scratch or damage them; therefore, do not use dry, rough or hard cloths.

The sensors must be washed with clean water, possibly adding car shampoo. Should you need to repaint the bumper or in case of paint touch-ups in the sensor area, please contact exclusively the **Authorized Maserati Dealer**. Incorrect paint application could affect the parking sensors operation.

## Park Assist System Usage Precautions

### NOTE:

- *Jackhammers, large trucks, and other vibrations could affect the performance of Park Assist.*





- Objects such as bicycle carriers, trailer hitches, etc., must not be placed within 12 in (30 cm) from the rear bumper while driving the vehicle. Failure to do so can result in the system misinterpreting a close object as a sensor problem, causing the service Park Assist message to be displayed in the instrument cluster.

**CAUTION!**

- Park Assist is only a parking aid and it is unable to recognize every obstacle, including small obstacles. Parking curbs might only be temporarily detected or not detected at all. Obstacles located above or below the sensors will not be detected when they are in close proximity.
- The vehicle must be driven slowly when using Park Assist in order to be able to stop in time when an obstacle is detected. When backing up, it is recommended that the driver looks over his/her shoulder when using Park Assist.

**WARNING!**

**Drivers must be careful when backing up even when using the Park Assist system. Always check carefully behind your vehicle, look behind you, and be sure to check for pedestrians, animals, other vehicles, obstructions, and blind spots before backing up. You are responsible for safety and must continue to pay attention to your surroundings. Failure to do so can result in serious injury or death.**

## Rear Parking Camera

Your vehicle is equipped with a rear parking camera that allows you to see an image on the MTC+ screen of the rear surroundings of your vehicle whenever the shift lever is put into R (Reverse).

When “Parkview Backup Camera Delay” mode is enabled on MTC+, the rear view image shall be displayed for up to 10 seconds after shifting out of R (Reverse).

The rear parking camera is located on the rear of the vehicle above the rear license plate.



When the shift lever is shifted out of R (Reverse), the rear camera mode is exited and the navigation or audio screen appears again.

When displayed, dynamic grid lines (if the function is set to “MTC+ Settings”)



## Before Starting

2

will illustrate the width of the vehicle while a dashed center-line will indicate the center of the vehicle to assist with parking or aligning to a hitch/receiver. The dynamic grid lines will show separate zones in different color that will help indicate the distance to the rear of the vehicle.

The following table shows the approximate distances for each zone and color:

Zone	Distance to the rear of the vehicle
Red	11 - 12 in (28 - 30 cm)
Yellow	12 - 78 in (30 cm - 2 m)
Green	78 - 157 in (2 - 4 m)

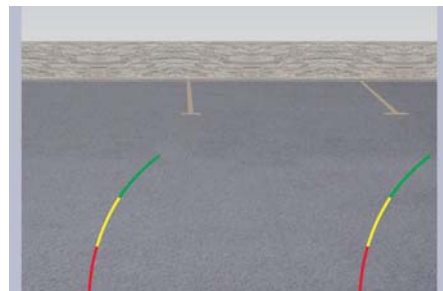

**WARNING!**  
Drivers must be careful when reversing even when using the rearview camera. Always check carefully behind your vehicle, and be sure to check for pedestrians, animals, other vehicles, obstructions, or blind spots before reversing. You are responsible for the safety of your surroundings and must continue to be careful while reversing. Failure to do so can result in serious injury or death.



- CAUTION!**
- To avoid vehicle damage, the rear parking camera should only be used as a parking aid, as the rear camera is unable to view every obstacle or object in your drive path.
  - To avoid vehicle damage, the vehicle must be driven slowly when using the rear parking camera to be able to stop in time when an obstacle is seen. It is recommended that the driver looks frequently over his/her shoulder when using this system.

### NOTE:

*If snow, ice, mud, or any other substance builds up on the camera lens, clean the lens, rinse with water, and dry with a soft cloth. Do not cover the lens.*





## Safety Tips

### Transporting Passengers



#### WARNING!

- Do not leave children or animals inside parked vehicles in hot weather. Interior heat build-up may cause serious injury.
- Never ride in a cargo area, inside of a vehicle.
- Do not allow people to ride in any area of your vehicle that is not equipped with seats and seat belts.
- Be sure everyone in your vehicle is in a seat and using a seat belt properly.

### Exhaust Gas



#### WARNING!

Exhaust gases can injure. They contain carbon monoxide (CO), which is colorless and odorless. Breathing it can make you unconscious and can eventually poison you. To avoid breathing (CO), follow these safety tips:

- Do not run the engine in a closed garage or in confined areas any longer than needed to move your vehicle in or out of the area.
- If it is necessary to sit in a parked vehicle with the engine running, adjust your heating or cooling controls to force outside air into the vehicle. Set the blower at high speed.
- If you are required to drive with the trunk lid open, make sure that all windows are closed and the climate control blowers switch is set at high speed. DO NOT use the recirculation mode.

The best protection against carbon monoxide entry into the passenger compartment is a properly maintained engine exhaust system.

Whenever detecting a change in the sound of the exhaust system or eventual exhaust fumes inside the vehicle have the **Authorized Maserati Dealer** inspect the complete exhaust system and adjacent body areas for broken, damaged, deteriorated, or mispositioned parts.

Open seams or loose connections could permit exhaust fumes to seep into the passenger compartment.



#### WARNING!

**California Proposition 65**  
Operating, servicing and maintaining a passenger vehicle or off-road vehicle can expose you to chemicals including such as, engine exhaust, carbon monoxide, phthalates and lead, that which are know to the State of California to cause cancer and birth defects or other reproductive harm. To minimize exposure, avoid breathing exhaust, do not idle the engine except as necessary, service your vehicle in a well-ventilated area and wear gloves or wash your hands frequently when servicing your vehicle. For more information go to:  
[www.P65Warnings.ca.gov/passenger-vehicle](http://www.P65Warnings.ca.gov/passenger-vehicle)





### Vehicle Safety Checks

#### Seat Belts

- Inspect the belt system periodically, checking for cuts, frays, and loose parts. Damaged parts must be replaced immediately.
- Do not disassemble or modify the system.
- If the belt has been sharply pulled, for example as the result of an accident, the safety belt, together with the anchoring devices, the anchoring device mounting screws and the pretensioner must be completely replaced. Even if the belt does not present any exterior signs of wear or damage, it may have lost its restraining properties.

#### Air bag Warning Light

The  warning light should illuminate and remain lit for a few seconds bulb checking when the key in the ignition switch is turned in **MAR (ON)** position (see “Supplemental Restraint System (SRS) — Air bags” chapter in this section).

- If the  warning light does not illuminate while starting, contact an **Authorized Maserati Dealer**.

- If the  warning light stays on, flickers, or comes on while driving, have the system checked by an **Authorized Maserati Dealer**.

#### Defroster

Check operation by selecting the defrost mode and place the fan system on high speed (see “Air Conditioning Controls” chapter in section “Dashboard Instruments and Controls”).

You should be able to feel the air directed against the windshield and front side windows. Contact an **Authorized Maserati Dealer** for service if your defroster is inoperable.

#### Floor Mat

Always use floor mats designed to fit the footwell of your vehicle. Use only floor mats that leave the pedal area unobstructed and that are firmly secured so that they cannot slip out of position and interfere with the pedals or impair safe operation of your vehicle.

#### NOTE:

*The **Authorized Maserati Dealer** can provide you with any information about the available Maserati floor mats included in the “Genuine Accessories” range.*



#### WARNING!

**Pedals that cannot move freely can cause loss of vehicle control and increase the risk of serious personal injury.**

- **Always make sure that floor mats are properly attached to the proper fasteners.**
- **Never place or install floor mats or other floor coverings in the vehicle that cannot be properly secured to prevent them from moving and interfering with the pedals.**
- **Never put floor mats or other floor coverings on top of already installed floor mats. Additional floor mats and other coverings will reduce the size of the pedal area and interfere with the pedals.**
- **Check mounting of mats on a regular basis. Always properly reinstall and secure floor mats that have been removed for cleaning.**
- **Always make sure that objects cannot fall into the driver footwell while the vehicle is moving. Objects can become trapped under the brake pedal and accelerator pedal causing a loss of vehicle control.**



- **Mounting posts must be properly installed, if not equipped from the factory. Failure to properly follow floor mat installation or mounting can cause interference with the brake pedal and accelerator pedal operation causing loss of control of the vehicle.**

### Tires

- Examine tires for excessive tread wear and uneven wear patterns.
- Check for stones, nails, glass, or other objects lodged in the tread or sidewall.
- Inspect the tread for cuts and cracks.
- Inspect sidewalls for cuts, cracks and bulges.
- Check the wheel nuts for tightness.
- Check the tires (see “Tire Inflation Pressure” chapter in section “Features and Specifications”) for proper cold inflation pressure.

### Lights and Indicator Lights

- Have someone observe the operation of exterior lights while you operate the controls (see “Lights” chapter in section “Understanding the Vehicle”).
- Check turn signal and high beam indicator lights on the instrument

cluster (see “Instrument Cluster” chapter in section “Dashboard Instruments and Controls”).

### Door Latches

- Check for positive closing, latching, and locking of doors and trunk lid (see chapter “Doors” and “Open and Close the Trunk Lid” in this section).

### Fluid Leaks

- Check area under vehicle after overnight parking for recent fluid leaks (oil, fuel, etc.).
- If gasoline fumes are detected or fluid leaks are suspected, contact an **Authorized Maserati Dealer.**



### **WARNING!**

**California Proposition 65  
Operating, servicing and maintaining a passenger vehicle or off-road vehicle can expose you to chemicals including such as, engine exhaust, carbon monoxide, phthalates and lead, that which are know to the State of California to cause cancer and birth defects or other reproductive harm. To minimize exposure, avoid breathing exhaust, do not idle the engine except as necessary, service your vehicle in a well-ventilated area and wear gloves**

**or wash your hands frequently when servicing your vehicle. For more information go to:  
[www.P65Warnings.ca.gov/passenger-vehicle](http://www.P65Warnings.ca.gov/passenger-vehicle)**





### **3 – Understanding the Vehicle**

Interior Components	70
Front Seats	74
Comfort Pack Front Seats	76
Rear Seats	78
Steering Wheel Adjustment	79
Rearview Mirrors	80
Lights	82
Windshield Wipers and Washers	89
Soft Top	92
Windstop (optional)	100
Interior Features	102
Cargo Area	107
HomeLink (for versions/markets, where provided)	108
Air Conditioning Distribution	112
Sport Skyhook Suspension (for versions/markets, where provided)	114



## Interior Components

### Dashboard Components

3

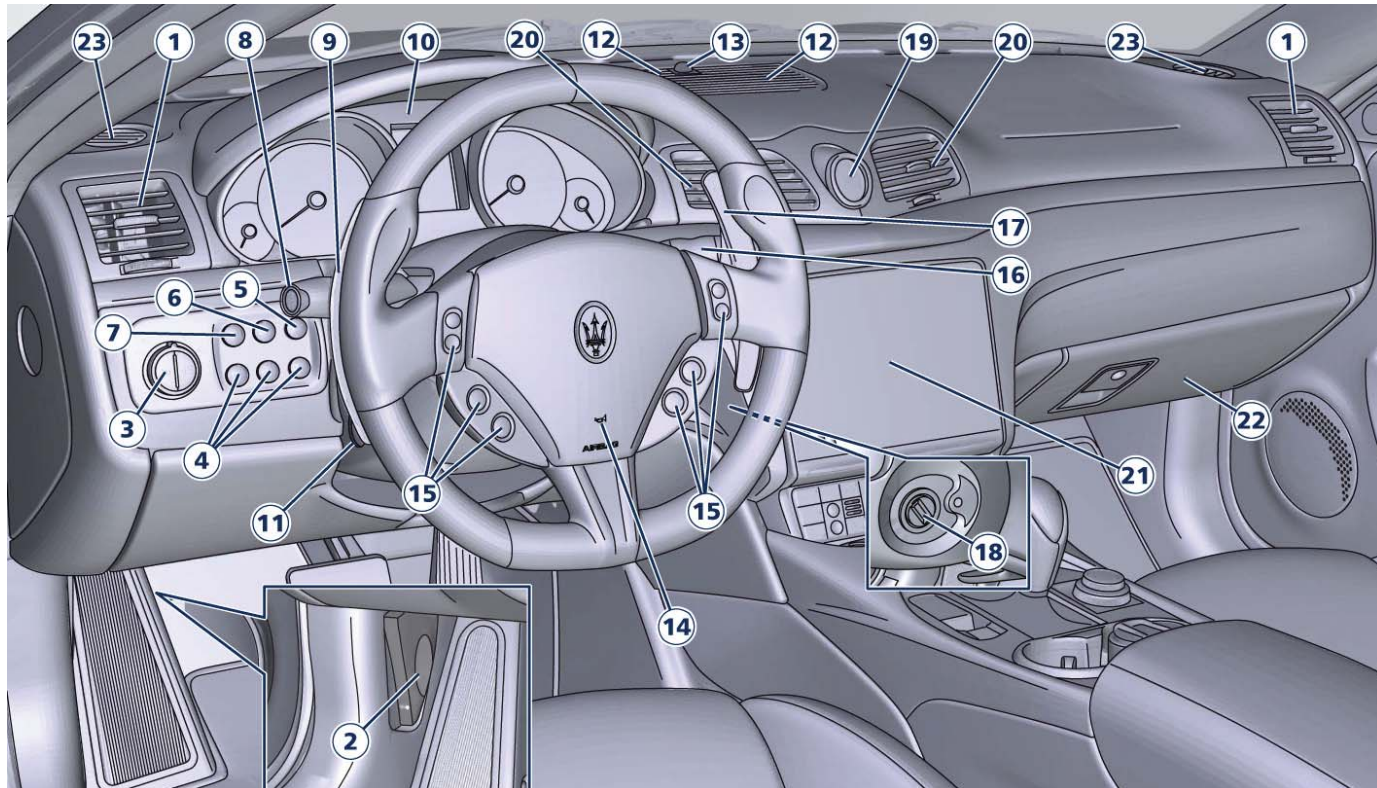



- |   |   |   |
|---|---|---|
| <ul style="list-style-type: none"> <li>1 Adjustable side air vents.</li> <li>2 Hood lid opening lever.</li> <li>3 Headlight and fog light switch.</li> <li>4 "Mode" and adjust "+" and "-" buttons.</li> <li>5 Front parking sensors disabling/enabling.</li> <li>6 Trunk lid opening button.</li> <li>7 Fuel tank door opening button (see "Refueling" in section "Driving" for operation).</li> <li>8 Multifunction lever (Cruise Control, turn signals, headlight washer and headlight selection).</li> <li>9 Lower gearshift paddle "DOWN".</li> <li>10 Instrument cluster.</li> <li>11 Steering wheel height and depth adjustment lever.</li> <li>12 Upper air vent.</li> <li>13 Sun radiation sensor.</li> <li>14 Horn control.</li> <li>15 Multimedia controls repeated on the steering wheel.</li> <li>16 Windshield/headlight wiper/washer control lever.</li> </ul> | <ul style="list-style-type: none"> <li>17 Upper gearshift paddle "UP".</li> <li>18 Ignition switch.</li> <li>19 Clock.</li> <li>20 Central adjustable air vents.</li> <li>21 MTC+ display.</li> <li>22 Glove compartment.</li> <li>23 Side window vents.</li> </ul> | <ul style="list-style-type: none"> <li>5 Anti-lift and anti-intrusion alarm system deactivation button.</li> <li>6 Paired phone hands-free microphone.</li> </ul> |
|---|---|---|

### Front Dome Console Components

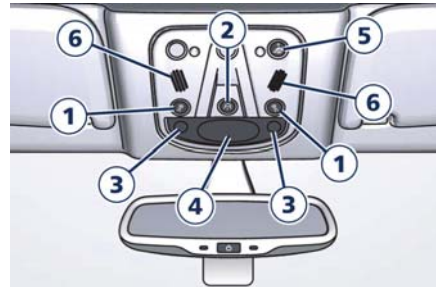

- 1 Reading lights control button.
- 2 Central light control button.
- 3 Reading lights.
- 4 Central light.



## Doors Components

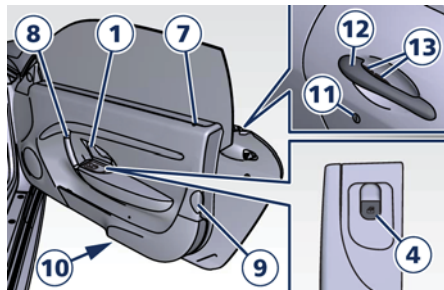
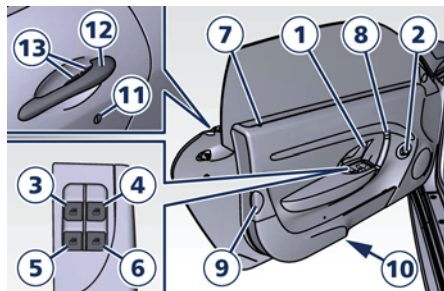



- 1 Inside door handle.
- 2 Rearview mirrors switch.
- 3 Drive power window switch.
- 4 Front passenger power window switch.
- 5 Rear driver's side power window switch.

- 6 Rear passenger's side power window switch.
- 7 Dual-color LED to indicate door status (locked/unlocked).
- 8 Door panel grip.
- 9 Reflex reflector.
- 10 Door courtesy light.
- 11 Door outboard opening lock.
- 12 Outside door handle.
- 13 External door unlock buttons.





## Central Console Components

- |   |  |   |
|---|--|---|
| <ul style="list-style-type: none"> <li>1 SPORT mode button.</li> <li>2 ICE low-grip mode button.</li> <li>3  ESC OFF System deactivation button.</li> <li>4 PARK OFF function button.</li> <li>5 Air conditioning controls.</li> </ul> | <ul style="list-style-type: none"> <li>6 Hazard button.</li> <li>7 Centralized locking  button.</li> <li>8 Centralized unlocking  button.</li> <li>9 Gear display.</li> <li>10 Electric parking brake engagement/disengagement lever.</li> </ul> | <ul style="list-style-type: none"> <li>11 Automatic transmission shift lever.</li> <li>12 Rotary selectors and buttons for the multimedia navigation.</li> <li>13 Handle to lift front armrest.</li> <li>14 Glove compartment cover (with armrest function).</li> <li>15 Front passengers cupholder.</li> <li>16 Air conditioning rear vents.</li> <li>17 Rear passengers cupholder (with removable ashtray inserted).</li> <li>18 USB ports for charging of connected device.</li> <li>19 Soft top closing button.</li> <li>20 Soft top opening button.</li> </ul> |
|---|--|---|

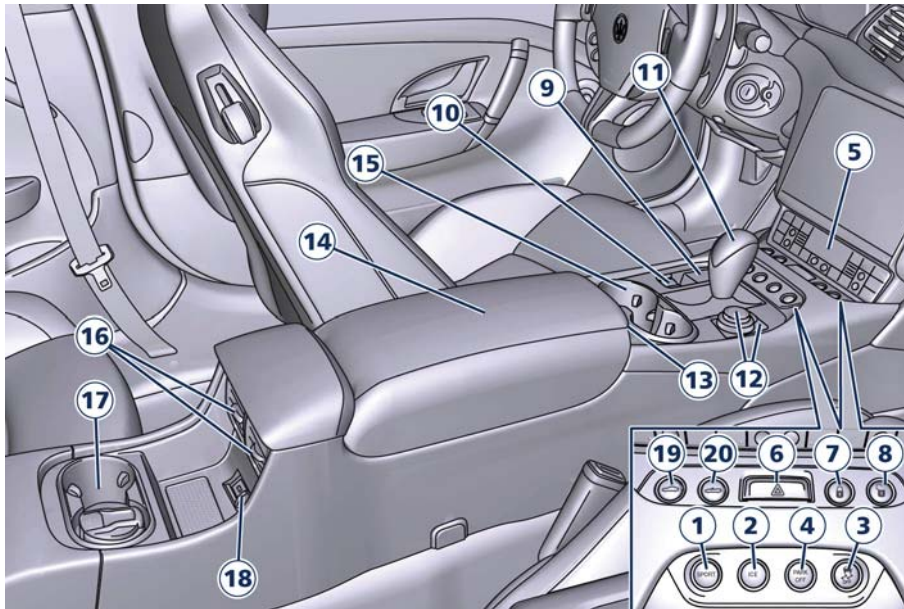



## Front Seats

Seats and seat belts are part of the Occupant Restraint System of the vehicle. For further information, see chapter "Occupant Restraint System" in Section "Before Starting".

3



**Be sure everyone in your vehicle is in a seat and using a seat belt properly.**

### Seat Adjustments

The seats can only be adjusted with the key in the ignition switch in **MAR (ON)** position.

It is however possible, when the door is closed, to operate the seat for approx. 15 seconds after turning the key to **STOP (OFF)** position and then for other 15 seconds after the last operation.

The power seats switches are located on the outboard side of the seat cushion.

Use the front switch **1** to move the seat up or down, forward or rearward or to recline the seat cushion.

Use the switch **2** to adjust the lumbar support and recline the seatback.



### Seat Forward/Rearward Adjustment

The seat can be adjusted both forward and rearward.

Push the seat switch **1** forward or rearward, the seat will move in the direction of the switch.

Release the switch **1** when the desired position is reached.

### Seat Up/Down Adjustment

The height of the seat can be adjusted up- or downward.

Grip switch **1** from the center and push it down or up.

Release the switch **1** when the desired position is reached.



### CAUTION!

If the seat's movement does not work, make sure that the corresponding fuse is not tripped (see chapter "Fuse

Replacement" in section "Maintenance and Care").

### Seat Tilt Control (Up/Down)

The angle of the seat cushion can be adjusted in four directions.

Pull upward or push the front of the switch **1**, to move the front cushion seat in the direction of the switch.

Release the switch **1** when the desired position is reached.

Perform the same maneuver by acting on the back of the switch **1**.

### Seatback Inclination Control

The angle of the seatback can be adjusted forward or rearward.

Push the seatback switch **2** forward or rearward, the upper seatback will move in the direction of the switch.

Release the switch **2** when the desired position is reached.



### WARNING!

**Sitting in a reclined position while the vehicle is in motion could be dangerous. The seatback should not be tilted back too far.**

**The 3-point shoulder/lap belt must be firmly secured against the occupant's body in order to function properly. Therefore, both the driver's and**



passenger's reclining seatbacks must always be in an upright position while the vehicle is in motion; otherwise the 3-point shoulder/lap belt would not remain firmly positioned against the occupant's body. Serious injury could result!

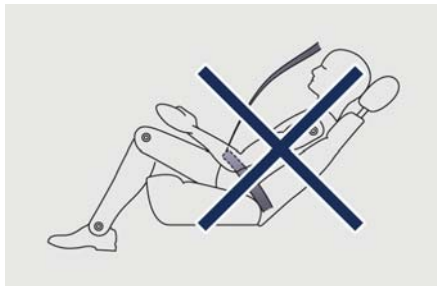

### Power Lumbar

Move the switch 2 upward or downward to raise or lower the lumbar support.



### WARNING!

- Never adjust the seat while driving. You could lose control of the vehicle. Moving the seat could distract you or make you press a pedal unintentionally.

- Seats should be adjusted before fastening the seat belts and while the vehicle is parked.
- Do not ride with the seatback reclined so that the shoulder belt is no longer resting against your chest. In a collision you could slide under the seat belt, which could result in serious injury or death.



### CAUTION!

Do not place any object under a power seat or obstruct its movement as it may cause damage to the seat controls. Seat movement may become limited if there is an obstruction in the way.

### Seatback Tilt

To tilt the front seatback, lift lever on the outer side of the backrest and move the backrest forward.

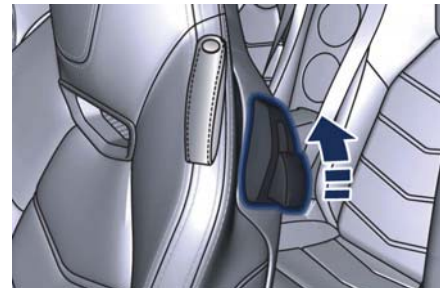

The front seats are equipped with a function to facilitate access to the rear seats and for exiting the vehicle.

### NOTE:

*The system (excluding the driver's seat with memory function) incorporates a safety device which stops the seat travel and then moves it forward slightly when the seatback touches the passengers seated in the rear seats. To stop the seat when it is automatically moving forward or backward, operate any control.*



### WARNING!

When the seatback is reclined forward or moved to the upright position, the front seat must not be occupied. Passengers shall get in or out of the

*(Continued)*



*(Continued)*  
rear seats only when the front seat is stopped. Make sure that passengers in the rear seats (especially children) do not touch the seat or any of its components when it's moving.

### Comfort Pack Front Seats

This includes:

- heating of the front seats;
- driver seat, steering wheel and outside rearview mirrors memory position (see paragraph "Driver Memory Seat" in this chapter).

### Front Heated Seats

The front seats are equipped with heaters in both seat cushions and seatbacks.



#### WARNING!

- Persons with low skin sensitivity because of advanced age, chronic illness, diabetes, spinal cord injury, medication, alcohol use, exhaustion or other physical conditions must be careful when using the seat heater. It may cause irritation even at low temperatures, especially if used for long periods of time.
- Do not place anything on the seat that insulates against heat, such as a blanket or cushion. This may cause the seat heater to overheat.

#### NOTE:

Seat heating also works with engine off and key in ignition switch in ACC or **MAR (ON)** position. To avoid discharging the battery, it is recommended to activate the feature with engine running.

The heating is activated by turning control on the outer side of the seat cushion.



When this function is active for one or more seats, the relative warning light will illuminate on the display. Using this control, heating can be adjusted to 3 different levels.

#### NOTE:

- Turn off the heating system when not required, to prevent unnecessary power wastage.



- Once a heat setting is selected, heat will be felt within 2 to 5 minutes.

### Comfort Screen Page

If the vehicle is equipped with "Comfort Pack Front Seats" option, press the "MODE" button to display the screen page showing the operating status of the heating system for each seat.

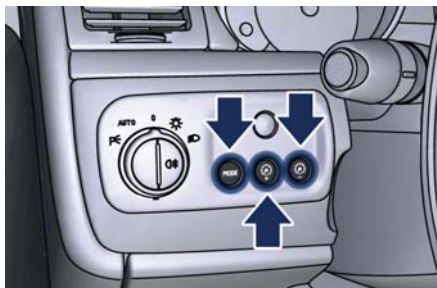

The user can view the following information:

- Seat indication.
- Heating level.

This screen page remains displayed for 10 seconds, as shown in figure.



Once you have chosen the seat to be heated, press "+" or "-" buttons to change the heating level.

### Driver Memory Seat

This feature allows the driver to store up to three different memory profiles for easy recall through the buttons on the outer side of the seat cushion. Each memory profile contains desired position settings for the driver seat, outside side mirrors and power tilt and telescopic steering column.

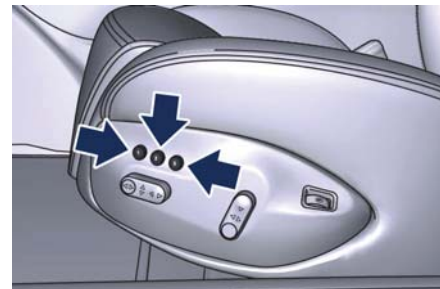

The memory procedure is only possible with the key in the ignition switch turned in **MAR (ON)** position.

Adjust the position of the seat, the outside rearview mirrors and the steering wheel.

Engage R (Reverse) gear and position the passenger's outside mirror again to ensure the best possible visibility for reversing, then disengage R (Reverse) gear.

Next press one of the three buttons "1", "2" or "3", each corresponding to a memorizable position, for more than 3 seconds until you hear a confirmation tone.

Lumbar support adjustment is not included in the seat position storage procedure.

The memorization of a new seat position cancels the one previously stored with that particular button.



To recall one of the stored positions with the door open, press the relative button "1", "2" or "3" briefly.

To recall a stored position with the door closed, press the corresponding button until hearing a tone that confirms the seat has stopped.

### NOTE:

- To stop the seat, press one of the buttons - "1", "2" or "3" -, or one of the adjustment controls.
- Malfunctioning of the seat control unit is indicated by a sequence of 5 tones emitted when the key in the ignition switch is turned to **STOP (OFF)** position. Contact an **Authorized Maserati Dealer** to have the malfunction corrected.

Each system is independent of the others and can be operated separately using specific buttons for each seat.

### System Initialization Procedure

Following any power cut-out (e.g. after using the battery master switch or dead battery), check the seats to ensure that they are operating properly when the power supply is available.

Perform the following procedures on both seats in the event of a malfunction.

The key in the ignition switch must be in **STOP (OFF)** position and the door on the side of the seat concerned closed.

Open the door and begin the following procedure within 5 seconds, then complete it within 10 seconds:

- forward - STOP;
- backward - STOP;
- forward - STOP;
- backward - STOP;
- tilt the seatback fully forward and wait until the seat performs two complete travels (forward and backward);
- move the seatback to its normal upright position.

### NOTE:

*If you need to disconnect the battery, wait at least 30 seconds from the last seat movement. If you disconnect the battery before, you will have to run the initialization procedure.*

### Seatback Facilitated Tilt

This function only active when the door is open, moves the seat forward automatically when the seatback is reclined forward to facilitate access to the rear seat or exiting the vehicle. The seat returns to their original position when the seatback is tilted back again.

## Rear Seats

Rear seats can fit two passengers. Seats and seat belts are parts of the occupant restraint system of the vehicle.



### WARNING!

**Be sure everyone in your vehicle is in a seat and using a seat belt properly.**

### NOTE:

See chapter "Occupants Restraint Systems" in section "Before Starting" for seat belt positioning.

## Rear Head Restraints

Rear seats are equipped with fixed head restraints.

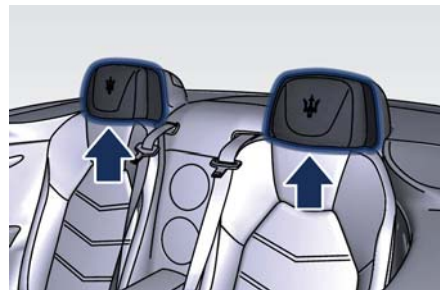





## Rear Armrest

It is located between the two seats and cannot be moved.

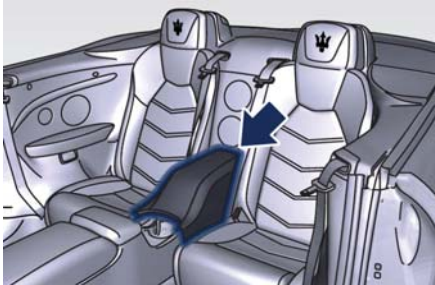

## Steering Wheel Adjustment

This feature allows you to tilt the steering column upward or downward or to lengthen or shorten it in order to adjust the steering wheel to an optimized position.



### WARNING!

**Do not adjust the steering column/wheel while driving. Adjusting the steering column/wheel while driving could cause the driver to lose control of the vehicle. Be sure the steering column/wheel is adjusted before driving your vehicle. Failure to follow this warning may result in serious injury or death.**

## Power Adjustment

The power tilt/telescoping steering column/wheel switch is located on the lower left side of the steering column. It can only be adjusted if the key in the ignition switch is in **MAR (ON)** position.

To adjust the tilt of the steering column/wheel, move the switch up or down as desired.

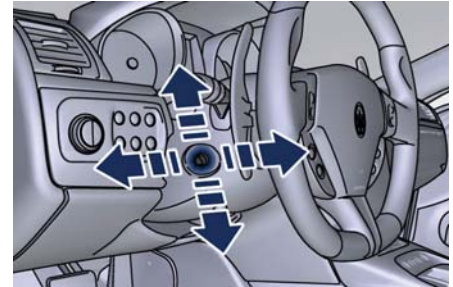

To lengthen or shorten the steering column/wheel, pull the switch toward you or push the switch away from you as desired.

The steering wheel position is memorized, together with the position of the outside rearview mirrors, when the driver's seat position is stored.

## Driver's "Easy Entry/Exit" Function

The "Easy Entry/Exit" function helps the driver when entering/exiting the vehicle.

This function is activated when the door is opened only if the key has been extracted from the ignition switch or is in **STOP (OFF)** position. When the driver exits the vehicle, the steering wheel moves upward.



On re-entry the driver finds the power steering wheel raised. After sitting down and closing the door, upon turning the key to **MAR (ON)** position, the power steering wheel moves back to the normal driving position.

### Rearview Mirrors

#### Outside Mirrors

Outside mirrors can be adjusted electrically.

The mirrors can be closed electrically and will yield in both directions in case of a collision.

The outside mirrors are electrochromic, which means, they automatically operate an anti-glare function by gradually shading as the light hitting the mirrors increases.

The outside rearview electrochromic mirrors work in conjunction with the inside rearview electrochromic mirror.

#### **NOTE:**

*The mirrors can be adjusted electrically only with key in the ignition switch in **MAR (ON)** position.*

#### Mirrors Positioning

The power mirror control is located on the driver's door trim panel.

The power mirror control consist of an external selector dial and a four-way mirror control switch.

To adjust a rearview mirror, turn the external selector dial in the L (left) or R (right) position to select the mirror that you want to adjust.

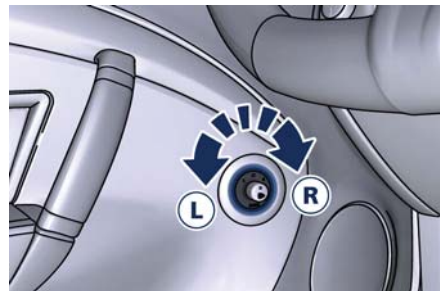

Move the mirror control switch corresponding to the direction of the mirror desired movement (up - down - right - left).

Bring the external selector dial back to the center position to avoid changing the position of the mirror involuntarily.

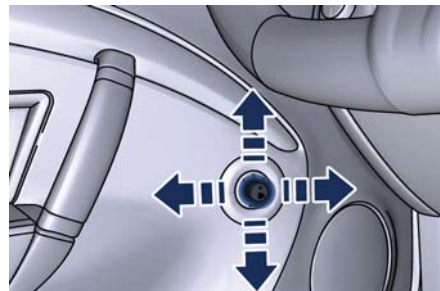

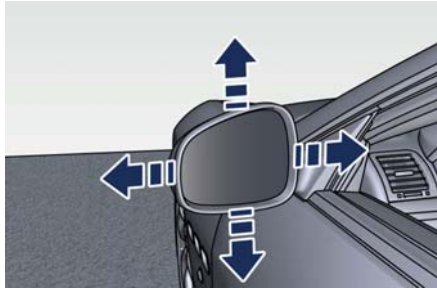

**WARNING!**

Vehicles and other objects seen in the outside convex mirror will look smaller and farther away than they really are. Relying too much on your passenger side convex mirror could cause you to collide with another vehicle or object. Use the inside mirror to judge the size or distance of a vehicle seen in the outside convex mirror.

**Folding Mirrors**

Turn the external selector dial to the lower central position "CLOSE", both mirrors fold inward to facilitate parking in narrow spaces. If the selector dial is returned to the upper central position, the mirrors return to the open position.

**WARNING!**

The mirrors must always be in the open position while driving.

**CAUTION!**

Never retract or open the mirrors manually: it could damage the power mechanism.

**Outside Rearview Mirror Memory Position**

The outside rearview mirror position, both for the normal driving direction and for reversing, is automatically memorized together with each seat position ("Comfort Pack Front Seats" function). See chapter "Comfort Pack Front Seats" in this section for further information.

**Inside Rearview Mirror**

The position of inside rearview mirror can be manually adjusted, and is endowed with an accident-prevention release system operating in the event of a collision.

The electrochromic rearview mirror automatically operates an anti-glare function by gradually darkening as the light reflected on its surface increases.

This function is automatically deactivated when reversing, to ensure optimal visibility of obstacles.

Inside rearview mirror is equipped at its base with a button for switching electrochromic feature on/off and a LED, on button left-hand side, indicating feature on/off status.

The LED on button right-hand side is not active.





The table indicates the possible on/off conditions, according to the position of the light switch, when R (Reverse) gear is not engaged.

Initial conditions			Possible action	
Light switch position	Electrochromic function	Status of LED	Button	Status of LED
0	Off	Off	-	-
	On	On	Press to disable	Off
	On	On	Press to disable	Off



### CAUTION!

To avoid damage to the mirror during cleaning, never spray any cleaning solution directly onto the mirror. Apply the solution onto a clean cloth and wipe the mirror clean.

## Lights

The external lights and turn signals turn on only with the key in the ignition switch in **MAR (ON)** position. Only the parking lights can be turned on at any time.

The external lights can be turned on and off manually or automatically, according to the brightness of the light outside.

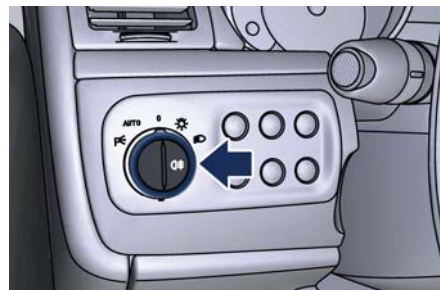

## Light Switch

The light switch is placed in the control panel next to the steering wheel.









Light switch has five positions:

- 0** DRL (\*) on (if enabled);
-  LED position lights, side marker and license plate lights on;
-  Low beam lights, LED position lights, side marker and license plate lights on;
-  Parking lights on;
- AUTO** Automatic activation and deactivation of the external lights, depending on the light outside.

(\*) On vehicles for the Canadian market DRL are always enabled.

## Daytime Running Lights (DRL)

DRL are normally enabled. Under special conditions, with light switch in  and  position, LED headlight can be turned on to full power (DRL), low power (position lights) or off. Status change of these lights is explained below.

Light switch position	Key position	Engine	DRL	Front position lights	Rear position, side marker and license plate lights
	<b>MAR (ON)</b>	OFF	OFF	ON	ON
		ON	ON	OFF	
		OFF	OFF	ON	



### Adaptive Bi-Xenon Headlights

The gas-discharge (xenon) headlights operate with an electric arc saturated with Xenon gas under pressure, instead of the incandescent filament. The light produced is assuredly higher compared to traditional light bulbs, in terms of quality (brighter light) as well as of the span and positioning of the illuminated area.

In addition, the headlights are equipped with an ALC system (Adaptive Light Control).

This system combines the light beam with the steering angle to assure better visibility of the road surface when driving in a curve, steering or in the event of road deviations.

The advantages offered by improved lighting system are perceived especially in case of bad weather, fog and/or insufficient road indications providing broader illumination of the side zones, which are normally left in the dark, and for highway driving (see comparison rendered below).

This surely increases driving safety as it offers less eye strain and increased orientation for the driver and better detection of other persons on the road sides (pedestrians, bicycle riders and motorcycle drivers).

The electric arc requires very high voltage for activation, but afterward power is supplied at a lower voltage.

The headlights reach maximum brightness about 0,5 seconds after being turned on.

The strong light produced by this type of headlight requires the use of an automatic system to keep the position of the headlights constant and to prevent dazzling approaching cars, in the case of braking, acceleration or load transport.



#### **WARNING!**

**If xenon headlamp replacement is necessary, contact the Authorized Maserati Dealer only: DANGER - RISK OF ELECTRICAL SHOCK.**

### Parking Lights

The parking lights only work with the key in the ignition switch turned to **STOP (OFF)** or **ACC** position, or with the key removed.

They are activated by turning the light switch to  $\text{P}$  position.

It is harder to turn the switch to  $\text{P}$  position than to the other positions. This is to avoid activating

the parking lights unintentionally and wasting power.

When the parking lights are on, the  $\text{P}$  warning light on the instrument cluster illuminates.

With parking lights on, move down left-hand multifunction lever to switch on position lights on left-hand side, and move it up to switch on only the ones on right-hand side.

### Automatic Headlights

When the light switch is turned to "AUTO" position and the key in the ignition switch is in **MAR (ON)** position, the position lights, low beam lights and license plate lights turn on and off automatically, depending on the light outside.

#### **NOTE:**

*The high beams can only be turned on manually by pushing the left-hand multifunction lever forward.*



#### **WARNING!**

- **If the low beams are activated, they will come on automatically every time the lights are turned on. You are therefore advised to turn off the high beams every time the twilight**



sensor deactivates the external lights.

- In case of fog during the day, position lights and low beam lights are not turned on automatically. The driver must always be ready to turn the lights on manually, including rear fog lights, if necessary.
- The driver is always responsible for turning on the external lights, depending on the light outside and in compliance with the applicable legislation in the country of use. The automatic system for activating/deactivating the external lights must be considered an aid for the driver. If necessary, turn the lights on and off manually.

#### NOTE:

After external lights turn on automatically, driver can always manually turn on rear fog lights. When external lights turn off automatically, rear fog lights will turn off automatically too, if on. Upon the following automatic switch-on driver must manually turn on rear fog lights, if necessary.

## Rear Fog Lights

Press  button on the light switch to turn on the rear fog lights.

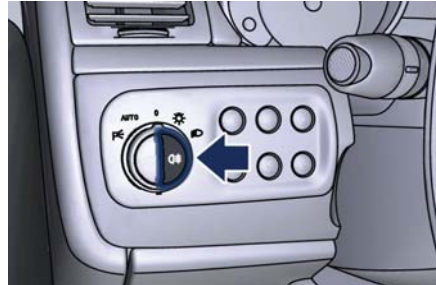

Fog lights only work when the low beams are on by operating the light switch in  (low beam) or "AUTO" position.

The symbol on the button and the dedicated indicator light in the instrument cluster illuminate when the lights are on.



#### WARNING!

**Do not use the rear fog lights in normal visibility conditions to avoid dazzling vehicles behind.**

Pressing again the  button will deactivate the rear fog lights.

## Twilight Sensor

This device consists of two sensors: a global sensor, capable of measuring the light intensity above and a directional sensor, which measures the light intensity in the vehicle's traveling direction, enabling it to recognize tunnels and driveways.

You can adjust the sensing range of the twilight sensor by means of the MTC+, by selecting the "Settings" menu and "Safety & Driving Assistant" function (see chapter "MTC+ Settings" in section "Dashboard instruments and Controls").

In the event of a sensor failure, the system will turn on the low beams and the position lights, regardless of the light outside, and a failure message will appear on the instrument cluster display.

The failure indication will be displayed as long as the light switch is turned to "AUTO" position.

In this case, we recommend that you deactivate the automatic system and turn on the external lights manually if necessary; contact an **Authorized Maserati Dealer** as soon as possible.



## Left-hand Multifunction Lever

The multifunction lever on the left side of the steering column controls the operation of the turn signals, headlight beam selection and overtaking lights.

This multifunction lever also controls the Cruise Control. See chapter "Cruise Control" in section "Driving" for further information.

### Turn Signals

Move the left-hand multifunction lever all the way up or down until the stop trigger.

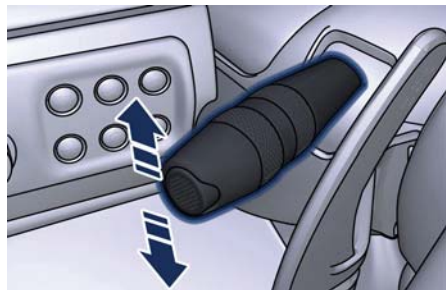

The left or right arrow indicator on respectively the speedometer and tachometer instrument cluster, flashes to show proper operation of the front and rear turn signal lights.

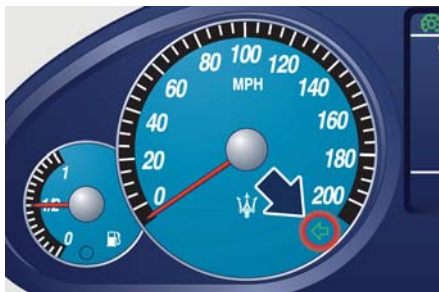

To activate lane change function, tap the lever up or down once, without moving beyond the detent. The turn signals (right or left) will flash three times then automatically turn off.

This function is useful when overtaking or changing lanes.

### NOTE:

*If either light remains on and does not flash, or flashes at a fast rate, check for a defective outside light bulb. If an indicator on instrument cluster fails while moving the lever, then the indicator bulb is probably defective.*

### High Beams and Flashing

To switch on the high beams with the light switch in headlamp  or "AUTO" position, shift the left-hand multifunction lever onward.

A related  blue telltale will illuminate on the tachometer.

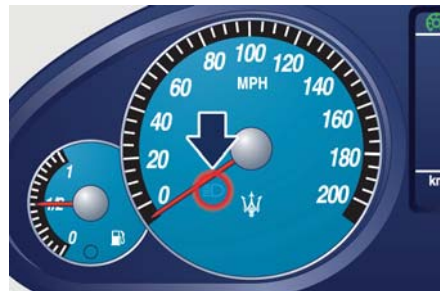

By pulling the lever backward (toward the steering wheel) you switch off the high beams and switch on the low beams.



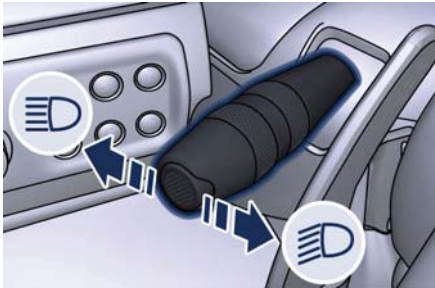

You can signal another vehicle with your headlights by lightly pulling the left-hand multifunction lever toward you. This will turn on the high beams until the lever is released.

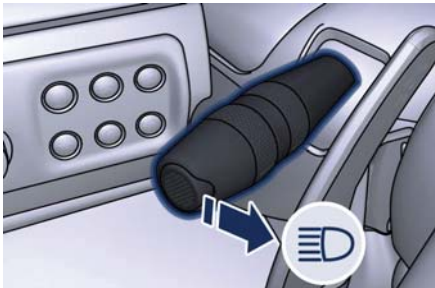

Flashing occurs also with lights off (light switch in position "0") if the key in the ignition switch is in **MAR (ON)** position.



#### CAUTION!

The high beams can only be switched on manually by pushing the left-hand multifunction lever forward.



#### WARNING!

If the high beams are activated, they will turn on automatically every time the low beams are switched on either manually or automatically. We recommend therefore that you switch them off when they are no longer necessary and every time the twilight sensor deactivates the external lights.

#### "Follow me Home" Function

This function allows you to set a timing for activation of the position lights and low beams, so that they may remain on for a set time after turning off the vehicle.

This function is activated by pushing the left-hand multifunction lever on the steering column, used to flash the headlights.

The position lights and low beams turn on for 30 seconds, the message "Follow me" appears on the instrument cluster display for 20

seconds, and the light activation time is displayed.

When this function is active, every time the left-hand multifunction lever for flashing the headlights is operated, the time the lights remain on is increased by 30 seconds, with a maximum total time of 210 seconds. The display will show the time set. If the left-hand multifunction lever for flashing the headlights is operated for more than 2 seconds, the function is deactivated, and the indicator on the instrument cluster display goes off. When the function is active, turning the key in the ignition switch back to **MAR (ON)** position deactivates the system.

#### Front Domelights

The front domelight includes a central and two reading lights.

The central light automatically turns on together with the two lights on the sides of the rear seats (see "Rear Side Interior Lights" in this chapter) when one of the doors is opened and turns off when the door is closed (timed switching off). These lights may be switched on manually by pressing the central button

The reading lights are controlled by the respective side buttons.



If they are turned on by pressing the button, both central and reading lights and the rear side interior lights will stay on for about 15 minutes after turning the engine off, and will then turn off gradually.



In the event of a collision causing the inertia switch activation, the domelights turn on automatically for approx. 15 minutes.



If one or more doors are opened, the front domelights and rear side interior lights will turn on for approx. 3 minutes. If the door is closed before this time, the lights will dim and subsequently switch off after about 10 seconds.

Upon removing the key from the ignition switch and activating the centralized door locking system with the remote control buttons, the domelights and the rear side interior lights turn on for about 10 seconds.

### Cargo Light

To illuminate the cargo area there is a light inside the trunk, at the top. This light turn on when trunk lid is opened and turn off when it is closed.

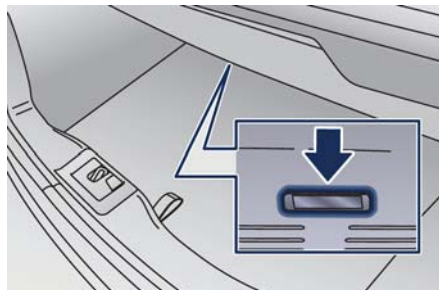

If trunk lid is left open for a long time, lights will turn off after a few minutes to save battery charge.

### Hazard Warning Flashers

Press the indicated button on the central console to turn on the hazard warning flashers. The operation is independent from the key position in the ignition switch.

Press the button again to turn them off.

When these lights are on, the turn signals, the related arrow indicator on the instrument cluster and the button itself will flash.

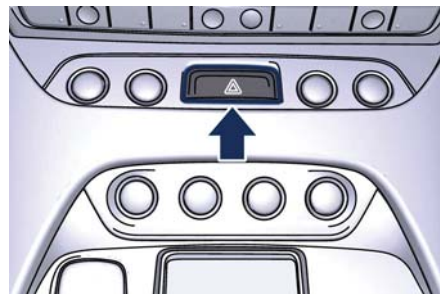

#### NOTE:

When the hazard warning flashers are activated, the turn signals control is disabled.

### Door Courtesy Light

Each door panel is fitted on the lower side with a courtesy light to illuminate

3





the area where passengers enter/exit the vehicle.

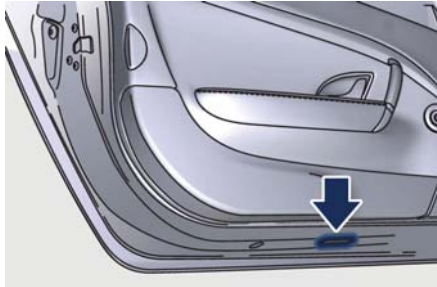

## Windshield Wipers and Washers

The multifunction lever on the right-hand side of the steering column operates the windshield wipers and washer when the key in the ignition switch is turned in **MAR (ON)** position. The windshield washer and headlight washer share the same fluid reservoir, and a low fluid level is indicated by the  same warning light and by the message on the instrument cluster.

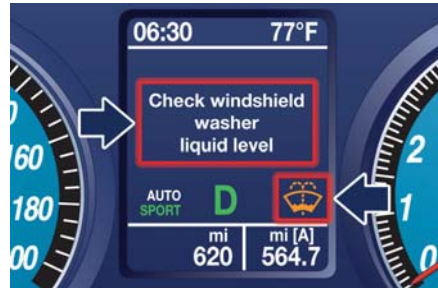

To refill the fluid, see “Maintenance Procedures” in section “Maintenance and Care”.

### Windshield Wipers

Starting from the not-active position “OFF”, the right-hand multifunction lever can be moved downward (three

stable positions) or upward (one unstable position).

**AUTO** Automatic operation. In this position the rain sensor adapts the windshield wiper frequency to the intensity of the rain.

- 1 Slow continuous operation.
- 2 Fast continuous operation.
- Fast temporary operation by pushing the multifunction lever upward.

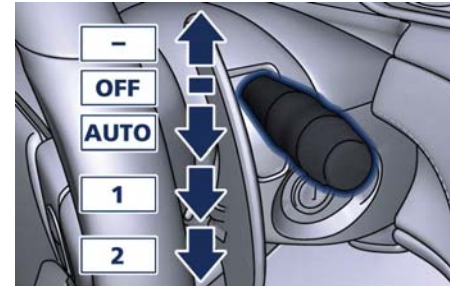

### CAUTION!

- Turn the windshield wipers off when driving through an automatic car wash. The windshield wipers may be

*(Continued)*



3

### (Continued)

damaged if the wiper control is left in any position other than "OFF".

- In cold weather, always turn off the wiper switch and allow the wipers to return to the park position before turning off the engine. If the wiper switch is left on and the wipers freeze to the windshield, the wiper motor may be damaged when the vehicle is restarted.
- Always remove any buildup of snow that prevents the windshield wiper blades from returning to the off position. If the windshield wiper control is turned off and the blades cannot return to the off position, the wiper motor may be damaged.

## Rain Sensing Wipers

This feature detects moisture on the windshield through an inside rearview mirror integrated sensor.

The rain sensor adapts the frequency of the windshield wiper strokes (in the intermittent operation mode) to the intensity of the rain.

All the other functions controlled by the right-hand multifunction lever (windshield wipers off, in continuous slow and fast operation mode and in

temporary fast operation mode) remain the same.

The rain sensor is activated automatically by moving the right-hand multifunction lever to "AUTO" position. The sensor has a setting range that varies progressively: from the windshield wiper stationary position - when the windshield is dry - to the windshield wiper second speed - in conditions of pouring rain.



To regulate the frequency of intermittent operation, with the right-hand multifunction lever in "AUTO" position, turn the end section of the lever.

Rotating the end section clockwise, intermittent operation varies from fast intermittent wipe (max.) to slow intermittent wipe (min).

If the engine is turned off during automatic windshield wiper operation,

with the right-hand multifunction lever in "AUTO" position, to reactivate the function the next time the engine is started, the lever must be moved to "OFF" (stop position) then back to "AUTO" position.



### CAUTION!

- The rain sensing feature may not function properly by ice or dried salt water on the windshield.
- Use on the windshield of RainX® or products containing wax or silicone may reduce rain sensor performance.

## Rain Sensor Failure

When the rain sensor is activated, in the event that it is malfunctioning, the windshield wiper will be switched on in intermittent operation mode and the sensing range will be set by the user, regardless of whether or not there is rain on the windshield.

The  symbol appears on the instrument cluster display.

In this case, we recommend that you cut-out the rain sensor and turn on the wiper, if necessary, in continuous mode. Contact the **Authorized Maserati Dealer** as soon as possible.



## Windshield Washers and Headlight Washers

To use the washer, pull toward the steering wheel the right-hand multifunction lever (toward the steering wheel) and hold it as long as washer spray is desired.

If you activate the washer while the windshield wiper control is in the automatic intermittent range, the wipers will operate for a few wipe cycles after releasing the lever and then resume the previously selected intermittent interval.

If you activate the washer while the windshield wiper is turned off (OFF) the wipers will operate for three wipe cycles and then turn off.

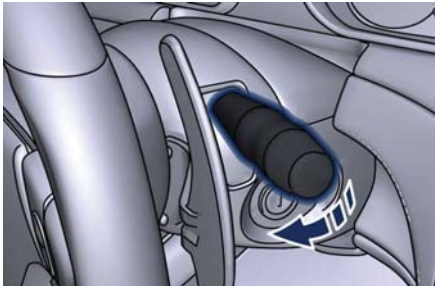

### WARNING!

- Do not start the windshield washer during the cold months until the windshield has warmed up. If it has not warmed up, the liquid could freeze on the glass and block your view.
- Sudden loss of visibility through the windshield could lead to a collision. You might not see other vehicles or other obstacles. To avoid sudden icing of the windshield during freezing weather, warm the windshield with the defroster before and during windshield washer use.



### WARNING!

California Proposition 65 Operating, servicing and maintaining a passenger vehicle or off-road vehicle can expose you to chemicals including such as, engine exhaust, carbon monoxide, phthalates and lead, that which are know to the State of California to cause cancer and birth defects or other reproductive harm. To minimize exposure, avoid breathing exhaust, do not idle the engine except

as necessary, service your vehicle in a well-ventilated area and wear gloves or wash your hands frequently when servicing your vehicle. For more information go to: [www.P65Warnings.ca.gov/passenger-vehicle](http://www.P65Warnings.ca.gov/passenger-vehicle)

## Headlight Washers

The right-hand multifunction lever also operates the headlight washers when the key in the ignition switch is in **MAR (ON)** position and the headlights are turned on.

The headlight washers will spray a timed high pressure spray of washer fluid when the windshield washer is started.

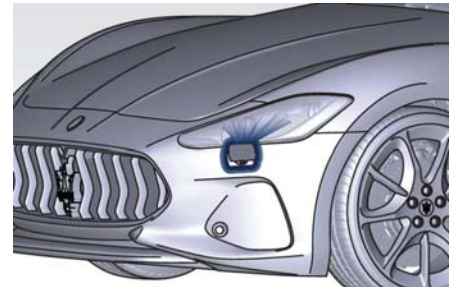

The headlight washers are deactivated if the vehicle speed exceeds 75 mph (120 km/h).



## Soft Top

### NOTE:



By soft top “opening” we mean folding the soft top into the rear luggage compartment.



By soft top “closing” we mean the opposite.

3

## Precautions

Before and during the soft top operation observe the following precautions.



### WARNING!

- Before opening or closing the soft top, always check that no one is in the way, as impact with the soft top may cause injury. Also check that no objects stand in the way of the soft top, as impact may cause damage to both the soft top and the object.
- The movement of the soft top with the engine running must be performed outdoor. Exhaust gases contain carbon monoxide which is strongly toxic and potentially lethal.



### CAUTION!

- In case of hazard, release the soft top button, which stops its movement.
- Keep your hands away from the soft top levers, the soft top compartment and the upper edge of the windshield.
- Before operating the soft top, make sure that no passengers are sitting in the rear seats.
- Never operate or act on a soft top that is performing an automatic movement cycle.
- Do not open the soft top when it is wet, as the damp that would form in the soft top housing might cause permanent damage to the structure or stains or mold in the canvas. Should it need to be opened, do not leave it sitting in the housing for more than a day.
- Open the soft top when it is dirty, as both the canvas and the rear window might be damaged when it is folded.
- Do not open the soft top if there is ice or snow on it. Should it need to be opened, remove the snow or ice and do not use sharp or pointed objects.
- Do not place objects on the soft top as they might fall and cause damage and injury when it is moved.
- Do not place any objects in the soft top housing.
- Do not fasten roof-racks or similar on the soft top.
- When closing the soft top, never start driving before the soft top has completed the closing cycle and has locked on the windshield frame.
- Only open or close the soft top when the vehicle is stationary, otherwise it might not fully open or close. For example, if you start moving the soft top when you are standing at a traffic light and you start driving before the soft top has completed its opening or closing cycle, you can complete the operation by driving slowly (do not exceed 19 mph - 30 km/h) and holding the soft top movement switch pushed until the process has been completed.
- If you are driving at high speeds, vacuum might be created in the passenger compartment and the soft top might start “wobbling”; to solve



this problem let more air into the passenger compartment.

- It is advisable to close the soft top when parking the vehicle. This not only protects the passenger compartment against weather agents, but is also a safeguard against theft.
- If possible, park in the shade as prolonged exposure to the sun will alter the canvas fiber and color.
- Before disconnecting the battery, lower the side windows by about 1.6 - 2 in (4 - 5 cm) to prevent damaging the soft top strip when the doors are opened and closed. When the battery is connected and fully charged, this operation is performed automatically whenever the doors are opened or closed. The windows must remain lowered until the recharged battery is reconnected. If the battery is dead and the windows are fully up, only open the doors when strictly necessary and being extremely careful: do not close them again until the windows can be lowered.
- Cover the soft top with a protective cloth when it is going to be parked outdoor for a long period of time.

- To avoid damaging the soft top, the vehicle must not be washed with high-pressure water jet systems, be it a manual nozzle or an automatic car wash with turning rollers.
- Organic residues must be immediately removed, as they may damage both the soft top fabric and its strips.
- Do not use solvents, alcohol, petrol or other generic detergents to clean the soft top.

### "Summer open" Strategy

Using the key inserted in the external driver's door lock, you can control the soft top opening/closing strategy referred to as "Summer open".

#### NOTE:

- *The opening and closing cycle can be interrupted at any time, moving the key back to its initial position.*
- *The following operations are performed with the engine off. This involves an extremely high power consumption, which causes the battery to discharge faster.*

With the soft top **fully closed**:

- insert the key in the external driver's door lock;

- turn the key clockwise until unlocking the doors and hold it in this position. The automatic soft top opening cycle will begin after approx. 2 seconds;
- do not move the key for the entire opening cycle.

With the soft top **fully open**:

- insert the key in the external driver's door lock;
- turn the key counterclockwise until locking the doors and hold it in this position. The automatic soft top closing cycle will begin after approx. 2 seconds;
- do not move the key for the entire closing cycle.

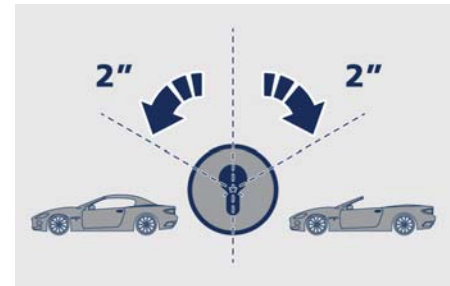



## Soft Top Operation

The soft top must be opened and closed with the vehicle stationary and, as a rule, with the engine running at idle speed.

If necessary (e.g. in closed places) the operation can be performed with the engine off and the key in the ignition switch in **MAR (ON)** position. This operation involves an extremely high power consumption, which causes the battery to discharge faster.

For moving the soft top, use the two buttons on the central console:

(C): soft top closing button.

(O): soft top opening button.



### Opening Cycle

Press the (O) soft top opening button and hold it pressed for the entire opening cycle.

The soft top will perform the following steps which are also shown on the instrument cluster display (see picture).

- 1 Side window lowering; first the front and then the rear windows will lower. Soft top released from the windshield frame.
- 2 Rear shelf edge raising.
- 3 Soft top compartment cover opening.
- 4 Soft top folding back inside its compartment.
- 5 Soft top compartment cover closing.







The movement cycle can be interrupted at any time by pressing again the (O) opening button. If you hold the (O) opening button and you push it again within 2 seconds after releasing it, when the soft top has reached its target position the system will automatically close all the windows.

### Closing Cycle

Press the (C) soft top closing button and hold it pressed for the entire closing cycle.

The soft top will perform the following steps which are also shown on the instrument cluster display (see picture).

- 1 Side window lowering; first the rear and then the front windows will lower. Soft top compartment cover opening.
- 2 Soft top unfolding.
- 3 Soft top compartment closing.
- 4 Soft top rear edge lowering on the rear shelf.
- 5 Soft top locking on the windshield frame.

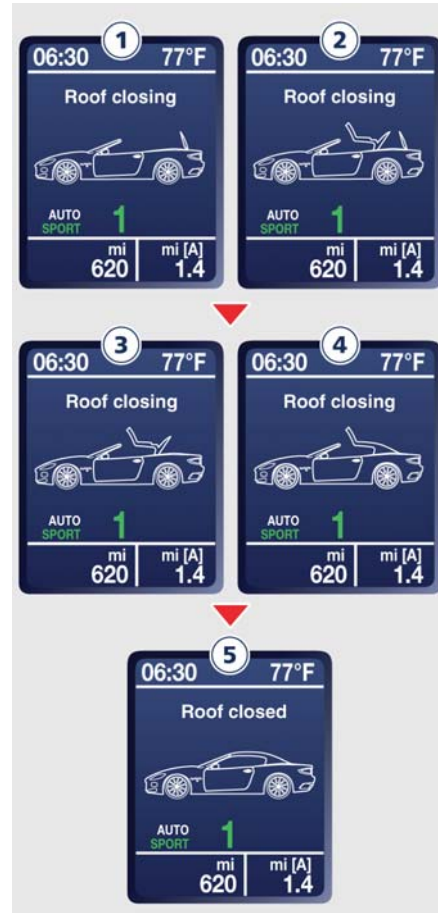

The movement cycle can be interrupted at any time by pressing again the (C) closing button. If you hold the (O) opening button and you push it again within 2 seconds after releasing it, when the soft top has reached its target position the system will automatically close all the windows.



### CAUTION!

At the beginning of the soft top opening or closing cycle, always ensure that the door windows have lowered automatically. If not, release the soft top movement button.



## Interruption/Inhibition of Soft Top Movement

Automatic movement of the soft top is interrupted in the following cases:

- If the button is released before the soft top has completed its movement cycle.



- Exceeding a speed of 30 km/h (19 mph).



Automatic movement of the soft top is inhibited in the following cases:

- Vehicle moving (at a speed above 19 mph/30 km/h).



- Trunk compartment open or not properly closed.

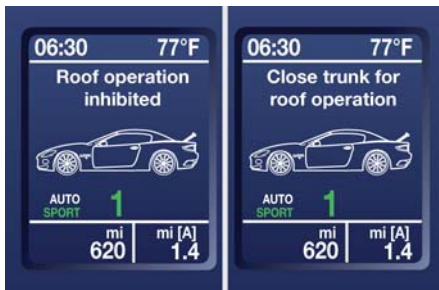

- Failure of the front windows.



**CAUTION!**

Contact the **Authorized Maserati Dealer** to have the system properly repaired.



- Movement system overheated.



- Low battery voltage.



**CAUTION!**

Contact the **Authorized Maserati Dealer** to have the battery voltage corrected.





- Outside temperature too low.



- The system cannot read the vehicle speed.



**CAUTION!**

Contact the **Authorized Maserati Dealer** to have the system properly repaired.



## Soft Top Failure

In the event of a failure of the hydraulic and electric soft top movement systems, the relative position symbol will illuminate on the instrument cluster display accompanied by a message indicating that automatic movement is not available.

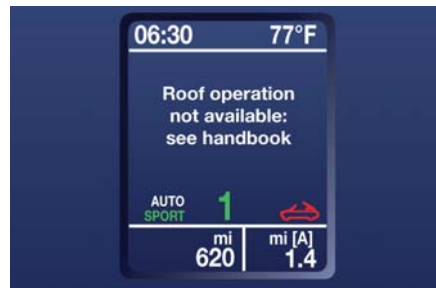

In these cases, check that the soft top is in a safe position, and if not, complete the movement manually (see

"Soft Top Manual Closing Operation" in this chapter).



**CAUTION!**

If a soft top failure is signalled, contact the **Authorized Maserati Dealer** to have the problem corrected.



**WARNING!**

If the soft top has jammed in an intermediate position, because its movement was intentionally stopped or due to a failure of the hydraulic and electric systems, after remaining in this position for approx. 10 minutes the hydraulic circuit loses pressure. This condition allows the soft top and the relative housing cover (driven by their weight) to reach a resting position. Therefore, take the greatest care to avoid that people or objects in the vicinity may interfere with the soft top travel during this time. In this case, do not operate the soft top using the buttons until the system has reached a steadily balanced position (fully open or fully closed).



## NOTE:

The soft top failure temporarily disables, for approx. 10 minutes, the power windows' operation. After this time, the power windows will resume normal functioning.

## Soft Top Manual Closing Operation

In case of need, the soft top may be closed manually.



### WARNING!

- Manual operation of the soft top for emergency closing requires the presence of two persons in order to prevent personal injury or damage to the car.
- When moving the soft top by hand, take the greatest care as its movable parts could squeeze or trap objects or parts of your body.



### CAUTION!

The emergency procedure described below must be used to close the soft top if it is not possible for you to contact the **Authorized Maserati Dealer** immediately and you cannot keep the soft top open.

If the failure occurs when the opening procedure is already in progress, do not attempt to complete the procedure - close back the soft top manually according to the following instructions. After depressurizing the hydraulic circuit by turning the key in the ignition switch to **STOP (OFF)** position, perform the emergency procedure starting from the point at which the opening stage jammed.



### WARNING!

After depressurizing the system, the soft top will move freely. Therefore, if it is not in a balanced position, it will close or open as a consequence of its weight. Take the greatest care to avoid being squeezed or trapped by its levers and mechanisms.

### Before Starting

#### NOTE:

- During emergency closing, the side windows must be lowered.
- To move the soft top manually, you must depressurize the hydraulic system by turning the key in the ignition switch to **STOP (OFF)** position and waiting approx. 10 minutes.

- To avoid unintentional activations, we recommend that you remove the key from the ignition switch. Take the flat-head screwdriver and the wrench to lock/unlock the soft top hinges out of the tool kit located in the trunk compartment (see "Tool Kit" in section "In an Emergency").

### Soft Top Closing

- Using a flat head screwdriver, remove the access covers (housed on both sides of the compartment) turning the relative fastening screws counterclockwise by a quarter of a turn.

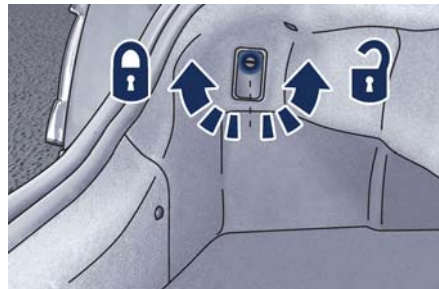

- Reach the small cables through the slots and pull them to unlock the soft top cover locks.
- Reassemble the access covers and lock them turning the following screw clockwise.

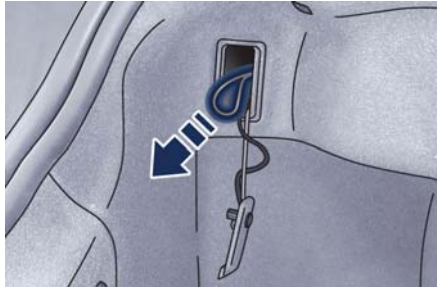

- Manually raise the soft top cover, placing your hands as shown in the figure, and hold it in a vertical position resting it on your shoulder for example.

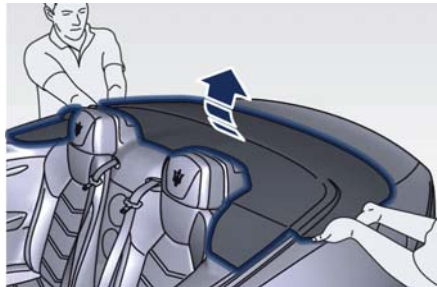

- Remove the soft top from its compartment by moving the front section to approx. half its travel, until reaching a balanced position.

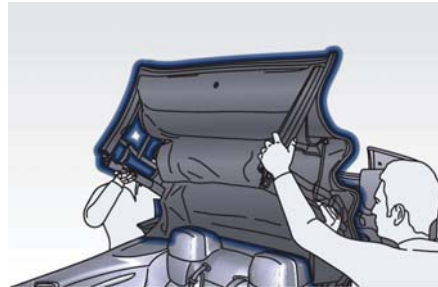

- Lower the soft top cover until latching the locks.

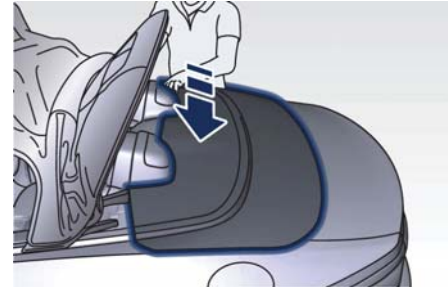
**CAUTION!**

Before proceeding with the closing procedure, ensure that the two soft top cover locks are properly latched.

- Place the rear section of the soft top on the soft top cover.

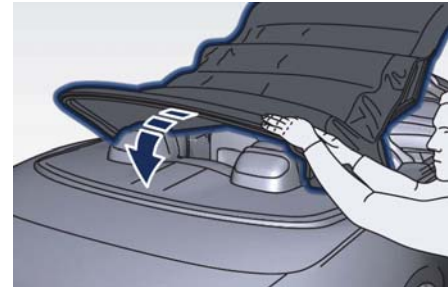

- Insert the soft top unlocking/ locking wrench in its seating.



- Turn the wrench clockwise to move the soft top edge closer to the windshield, and fasten the fastening latches inside the locks.



- Remove the unlocking/locking wrench from the soft top seat and place it in the tool kit box together with the screwdriver.

### Windstop (optional)

The Windstop consists of a panel fitted behind the front seats, which prevents the wind from creating turbulence in the passenger compartment when the soft top is open. The Windstop can also be left installed with soft top closed.



#### WARNING!

**With Windstop installed you can not carry passengers in the rear seats.**

The Windstop is normally stored in a protective bag inside the trunk compartment. This bag is secured inside the compartment by means of a strap.



#### CAUTION!

- It is recommended not to place sharp and pointed objects which may contact the protective bag in the trunk compartment, unless they are firmly secured.
- You should not place objects on the Windstop protective bag, even if they are secured, as they may

damage the Windstop with their weight.

#### NOTE:

*If the vehicle is equipped with spare wheel (optional), it may not house in the trunk compartment the Windstop inside its bag.*

### Fitting the Windstop

- Take the Windstop out of its bag.
- Turn the lower left-hand part, until it is fully laid out.

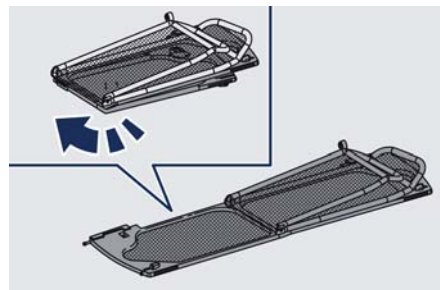

- Join the rear section to the base of the Windstop.

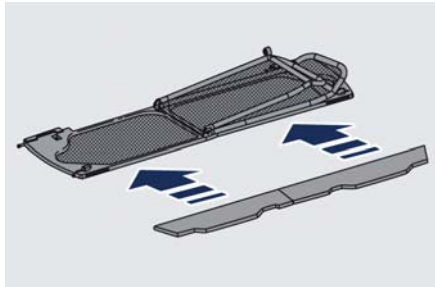

- If already extracted, retract the rear pins on the sides of the Windstop base by sliding inward the relative guide.
- Lift the upper left-hand part of the windbreaker until it is fully opened.
- By acting on the bottom of the Windstop base, push outward the red lever shown in the detail of picture and release it in order to insert the coupling pin on the end ring of the upper part of the windbreaker.

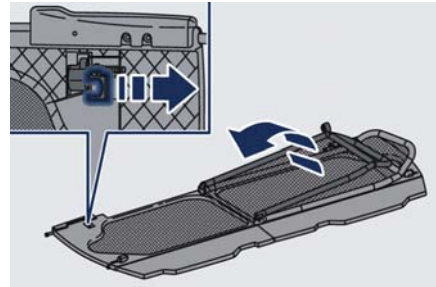
**CAUTION!**

During the following installation operations, take the greatest care to avoid damaging the internal trims of the vehicle.

- Bring the front part of the Windstop base in position on the vehicle.
- Fit the pin in the relative seat on the rear right-hand panel of the vehicle by sliding out the guide pin.

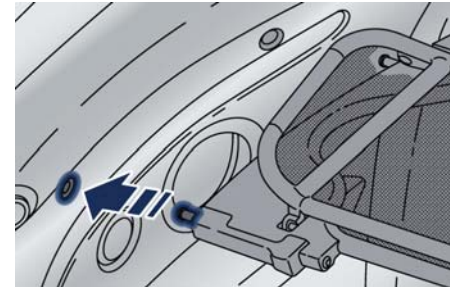

- Perform the same operation to engage the opposite pin on the left side of the Windstop base.
- Keep the rear pins in the retracted position moving the pin's handle in the direction of the arrows shown in the detail of picture.
- Let the pins go. In this way the Windstop base will result firmly fixed to the vehicle.
- Align the pins on their seats on the rear panels of the vehicle and let the pins go. In this way the Windstop base will result firmly fixed to the vehicle.





3

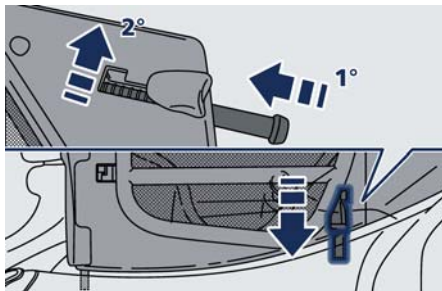

- Raise the upper section until it is in a vertical position.

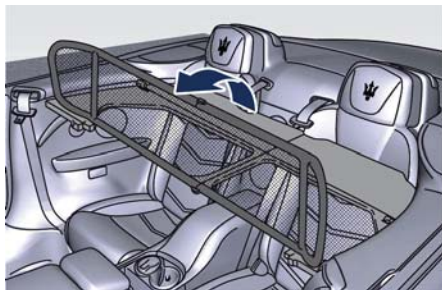

**CAUTION!**

- Do not fasten any object to the Windstop.
- Never place any object on the Windstop.
- When the Windstop is fitted, if you tilt the backrest or move the seat

backward you must take the greatest care to avoid that the two parts touch each other and so cause damages.

- Never place pointed or sharp objects on the rear seats, under the Windstop when fitted.

## Windstop Removal

Perform the operations opposite to those outlined above and in reverse order.

### NOTE:

*To be able to fold up the upper part of the windbreaker, unlock the pin by pushing the small lever indicated in the picture.*

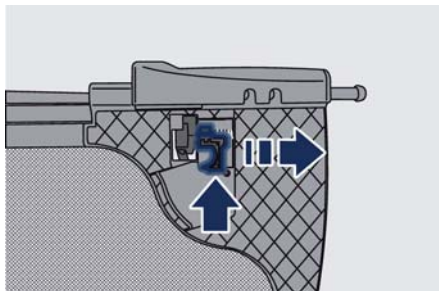

## Interior Features

### Electric Power Outlets

The vehicle is equipped with two 12 Volt (13 Amp) electric power outlets. One in passenger compartment on the central console, under the cover with armrest function, using the socket of the cigarette lighter as power outlet and one fitted in the trunk.

All power outlets are supplied only when the engine is started or the key in the ignition switch is turned in **ACC** or **MAR (ON)** position.

Power outlets are protected by a fuse. Insert a cigarette lighter or accessory plug into the power outlets to ensure proper operation. Otherwise, check the matching fuse integrity, see "Fuse Replacement" in section "Maintenance and Care" for further information.



**CAUTION!**

- Do not plug in accessories that exceed the maximum power of 160 Watts (13 Amps) at 12 Volts.
- Power outlets are designed for accessory plugs only. Do not insert any other object in the power outlets as this will damage the outlet and



blow the fuse. Damages caused by improper use of the power outlet are not covered by the New Vehicle Limited Warranty.



### WARNING!

To avoid serious injury or death:

- Only devices designed for use in this type of outlet should be inserted into any 12 Volt outlet.
- Replacing the fuses that protect power outlets with others of higher amperage, there is the risk of fire.
- Do not touch with wet hands.
- If this outlet is mishandled, it may cause an electric shock and failure.

### Power Outlet on Central Console

To access the power outlet on the central console lift the cover with armrest function by pushing the inside handle.

Remove the cigarette lighter and use its socket as power outlet.



### WARNING!

High power consumption items plugged into this outlet for long

periods may discharge the battery and/or prevent the engine from starting.



### Power Outlet inside the Trunk

The power outlet is positioned on the right side of the trunk compartment.



### Cupholders

The vehicle is equipped with two cupholders.



### CAUTION!

- Use light and shatterproof containers.
- Do not forcefully push unsuitable containers into the cupholders to prevent damage to the containers.
- Do not store hot drinks.

### Cupholders for Front Passengers

The front cupholders are located behind the transmission shift lever.



3

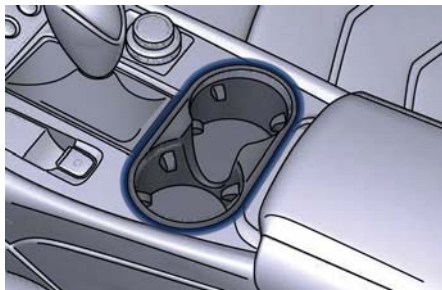

## Cupholders for Rear Passengers

The rear cupholders are available on the rear part of the central console, between the rear seats.

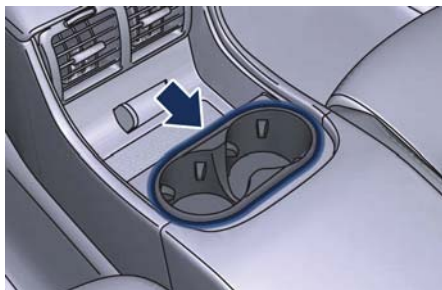

## Multimedia Ports and Phone Housing Compartment

Multimedia ports and the housing for the phone are located in a compartment inside the central console. To access this compartment

lift the cover with armrest function as previously described.

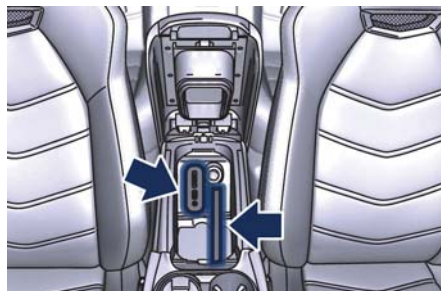

If the front passenger wants to use the phone connected to the USB port, you can route the cable to the right-hand side of the hooking area of the cover opening handle shown in picture.

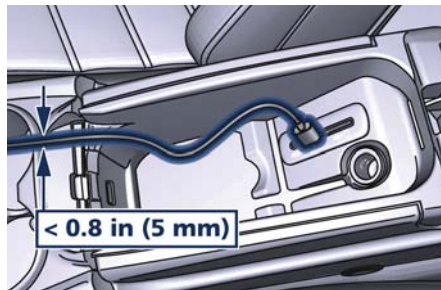

To avoid the risk of being pinched when closing the cover, the cable diameter that properly fits in this area must not exceed 0.8 in (5 mm) and

must pass as close as possible to the side walls of the containment compartment, avoiding the hooking area of the handle.

The AUX auxiliary port features:

- typical port impedance between AUX-IN and AUX\_REF: 13 Kohm;
- max. applicable voltage: 0.75 Vrms at 1 kHz;
- port compatible only with 3.5 mm jack connectors (not included).

Any player with these characteristics and analog audio output (headset output type) can be served by the MTC+ System. The system can recognize the connection to a player outlet autonomously, by enabling access to the audio functions connected to this source.

This USB port can be used for data exchange and charge of the connected source (refer to the MTC+ guide for further details).

Through this USB input is possible to recharge the connected device for about an hour from when the key in the ignition switch is turned in **STOP (OFF)** position ("Active Charging" feature). When this feature is enabled, the USB port will be backlit.

In this compartment there is also an SD memory card input. Once inserted into





the slot, to extract it press lightly on the card.

Other two USB ports are present for rear seat passengers, on the rear part of the central console.

To access the USB port, open the outside cover. These USB ports allow charging the connected source.



When you turn the key in the ignition switch in **STOP (OFF)** position, these USB ports remain active for 10 minutes to allow the charging of connected devices.

### iPod® Connection

An iPod® can be connected to the system via USB and AUX ports by means of a special cable (optional). The MTC+ will then control the following functions: play, pause, fast forward, rewind, next track, previous track, random or repeat mode,

selection and navigation of playlist/genre/singer/album/Podcast.



### CAUTION!

Do not leave your USB device, iPod® or an external audio source in the vehicle for extended period of time: extreme temperatures and humidity can occur in the vehicle.

### NOTE:

Visit [www.maserati.com](http://www.maserati.com) or an **Authorized Maserati Dealer** for a list of iPod® devices compatible with the MTC+ and their level of compatibility.

### Sun Visors

Sun visors can be folded to the front and to the side of the vehicle. To move the visor laterally, lower and release it from its catch as indicated.

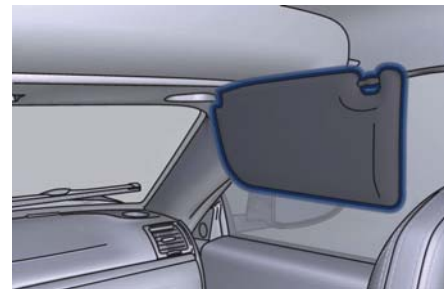
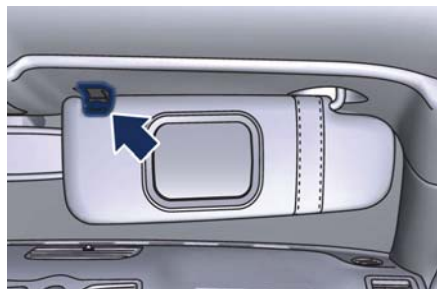

By lowering the visor you can access the courtesy mirror with incorporated light illuminating automatically (with the key in the ignition switch in **MAR (ON)** position) by raising the mirror protective cover. Before raising the visor, close the mirror cover. A paper holder is fitted inside each sun visor.

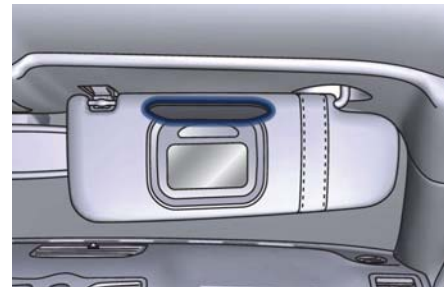



## Smoking Kit

The kit includes a lighter and a removable ashtray with cover. The cigarette lighter is located inside the compartment under the armrest between the front seat. The removable ashtray can be inserted into the front or rear cupholder. To access the cigarette lighter lift the cover with the armrest function as previously described.

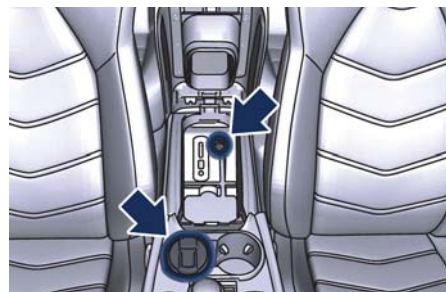

Pressing the central button activates the cigarette lighter. After about 20 seconds the button returns automatically to the initial position and stops the heating; now the cigarette lighter is ready for use.



### CAUTION!

After use, always make sure that the cigarette lighter is switched off.



### WARNING!

The cigarette lighter reaches high temperatures. Handle it carefully and do not allow children to use to avoid risk of fire and injury!

## Cloth Hooks

A cloth hook is located on the upper part of the seatback of the front seats.

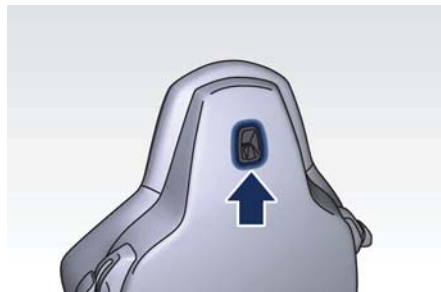

## Mobile Phone Pocket

Central console on passenger's side is fitted with a pocket for housing a mobile phone or small objects.

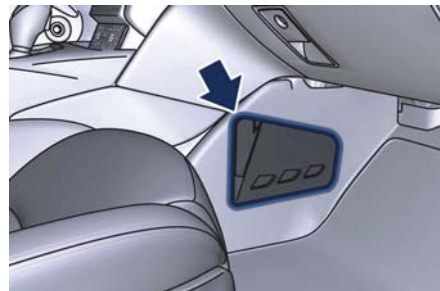

### CAUTION!

Do not put heavy or sharp objects in the pocket.

## Cargo Area



### WARNING!

To help protect against personal injury, passengers must not be seated in the rear cargo area. The rear cargo space is intended for load carrying purposes only, not for passengers, who should sit in seats and use seat belts.

## Vehicle Load Carrying Capacity

The load carrying capacity of your vehicle is shown on the "Tire and Loading Information Label" positioned on the rear driver door's pillar.

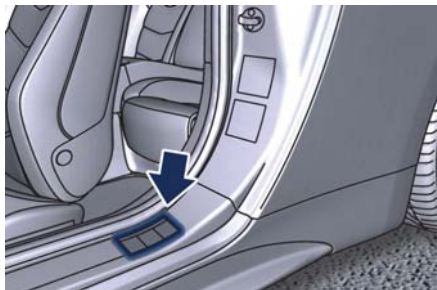

The information indicated on the label concerns passengers and luggage loading operations.

Do not exceed the specified Gross Vehicle Weight Rating (GVWR) or the Gross Axle Weight Rating (GAWR) for either the front or rear axle. The GVWR is the total allowable weight of your vehicle. This includes driver, passengers, and cargo. The maximum load which may be carried in the rear luggage compartment is 66 lbs (30 kg).



### WARNING!

Do not exceed the GVWR, or front or rear GAWR. Exceeding these limits may lead to poor handling, vehicle instability or tire damage which could cause a crash in which you or others could be seriously injured or killed.



### WARNING!

- Improper weight distribution can have an adverse effect on the way the vehicle steers, handles and the way the brakes operate.
- Never drive with the trunk lid open. Exhaust gases can enter the passenger compartment.

The trunk is the most suitable place to load bulky and heavy objects onboard the vehicle.

To load your vehicle properly, store heavier items below and be sure you distribute their weight as evenly as possible.

Stow all loose items securely before start driving as they could move during the trip.

## Carrying Luggage on Rear Seats

Light luggage may be transported on the rear seats only if they are securely anchored on the seats using the tethers provided (upon request).

### Installation

- Fasten one end of the tether to the "U" metal ring positioned in the center of the seat, between the cushion and the backrest.

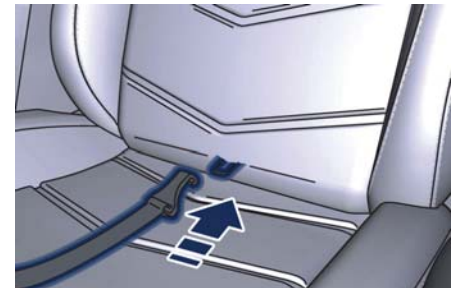



- Lay provisionally the tether vertically on the backrest and on the headrest.
  - Place the suitcase on the cushion.
  - Secure the suitcase with the tether, which must be wound all around the suitcase and passed through its handles.
- Using the buckle tension the tether until the suitcase is firmly secured on the seat.

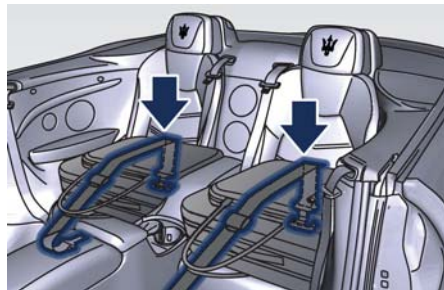

- Fasten the other end of the tether to the "U" metal ring located underneath the covering at the base of the seat.

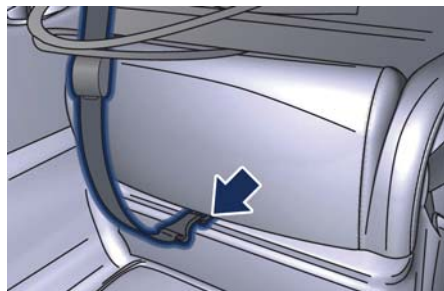

## HomeLink® (for versions/markets, where provided)

HomeLink® replaces up to three hand-held transmitters operating the automatic devices that open garage doors and gates, enable/disable the lighting or security systems. The HomeLink® unit is powered by your vehicle's 12 Volt battery. The HomeLink® buttons that are located in the control panel behind the driver's side sun visor designate the three different HomeLink® channels. The HomeLink® LED is located above the central button.

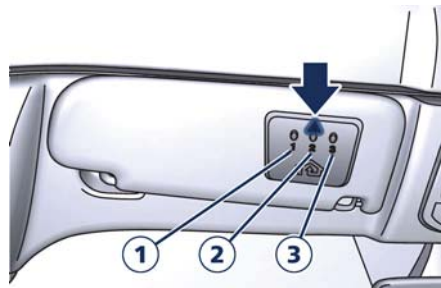

HomeLink® is disabled when the vehicle security alarm is active (see "Vehicle security alarm" in section "Before Starting").

**WARNING!**

Vehicle exhaust contains carbon monoxide, a dangerous gas. Do not run your vehicle in the garage while programming the transceiver. Exhaust gas can cause serious injury or death.

**Customer Service**

If you have problems with training the HomeLink Universal Transceiver, or would like information on home products that can be operated by the transmitter, call (800) 355-3515. On the Internet, go to [www.HomeLink.com](http://www.HomeLink.com).

**Safety Precautions**

Always refer to the operating instructions and safety information that came with your garage door opener or other equipment you intend to operate with the HomeLink Universal Transceiver. If you do not have this information, you should contact the manufacturer of the equipment.

While training or using HomeLink, make sure you have a clear view of the garage door or gate, and that no one will be injured by its movement.

**General Information**

While programming HomeLink®, it is advisable to disconnect the drive motor of the gate/door to be remote controlled, since the numerous driving pulses launched for this operation might damage it.

If the battery fails or is disconnected, the stored settings are not deleted. If the gate/door was manufactured prior to April 1982 (not equipped with safety systems or automatic stop in the event of an obstacle in the range of action), the gate/door cannot be controlled by HomeLink®. If you have questions, call (800) 355-3515.

**WARNING!**

**California Proposition 65 Operating, servicing and maintaining a passenger vehicle or off-road vehicle can expose you to chemicals including such as, engine exhaust, carbon monoxide, phthalates and lead, that which are know to the State of California to cause cancer and birth defects or other reproductive harm. To minimize exposure, avoid breathing exhaust, do not idle the engine except as necessary, service your vehicle in a**

**well-ventilated area and wear gloves or wash your hands frequently when servicing your vehicle. For more information go to: [www.P65Warnings.ca.gov/passenger-vehicle](http://www.P65Warnings.ca.gov/passenger-vehicle)**

**Programming**

- Press and hold buttons "1" and "3".
- After about 20 seconds, the LED starts flashing.
- Release the buttons.
- Hold the remote control for the device to be controlled close to the HomeLink® control panel (0-30 cm/ 0-12 in).
- Simultaneously press and hold the button on the hand-held remote control and one of the three HomeLink® buttons "1", "2" or "3".
- Successful programming is signaled by the LED flashing faster.
- Release the buttons.

To program the other buttons, repeat the operations skipping the first three steps.



### Use

- When the signal of the device to be activated reaches its operating range, press the dedicated HomeLink® button.
- The LED remains on while the signal is being transmitted.

The devices controlled through the HomeLink® function can always be activated using the original remote controls.

Should the so programmed HomeLink® not activate the system to be controlled, this may be due to the fact that this system is controlled by a remote control with a rolling code. A rolling activation code can be recognized in the following ways:

- consulting the instruction manual provided with the device to be controlled;
- despite the fact that the HomeLink® programming procedure has been carried out correctly, the HomeLink function does not activate the device;
- holding the dedicated HomeLink® button pressed down, the LED briefly flashes fast and then remains on for 2 seconds; this sequence is repeated for about 20 seconds.

### Programming Devices Controlled by Rolling Code

- Locate the specific setting button by consulting the user manual of the system to be controlled. This button is normally located on the motor which drives the device.
- Press the button and, in normal conditions, a LED will illuminate.

#### **NOTE:**

*Normally, after this operation you have 30 seconds to start the next one.*

- Briefly press the HomeLink® button you have chosen to control the device.
- Press it a second time; when it is released the operation should be completed. For some types of motors, the button might have to be pressed a third time.

### Reprogramming an Individual Button

If you wish to program activation of a new system on an already used HomeLink® button, proceed as follows:

- press and hold the HomeLink® button selected;

- after about 20 seconds, the LED starts flashing; hold the button down;
- hold the original remote control of the device to be controlled close to the HomeLink® control panel (0-30 cm/0-12 in);
- press and hold the button on the original remote control;
- successful programming is signaled by the LED flashing faster;
- release both buttons.

The system previously programmed on HomeLink® has thus been replaced with the new programming and is ready to be used.

This operation has no impact on the other HomeLink® buttons.

### Deleting the Programmed Buttons

Unlike programming, which is performed for each individual button, all three buttons are deleted simultaneously.

To delete proceed as follows:

- press and hold buttons "1" and "3";
- after about 20 seconds, the LED starts flashing;
- release the buttons.



**NOTE:**

It is advisable to perform the HomeLink® deletion procedure when selling the vehicle.

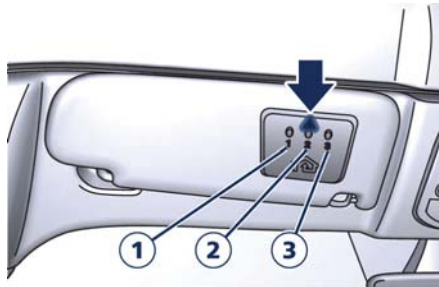

3

**Regulations Compliance**

This device complies with Part 15 of the FCC rules (US) and Canada Standard RSS-210 (Canada). Operation is subject to the following two conditions:

- This device may not cause harmful interference.
- This device must accept any interference received, including interference that may cause undesired operation.

Changes or modifications not expressly approved by the party responsible for compliance could void the user's authority to operate the equipment.





## Air Conditioning Distribution

3

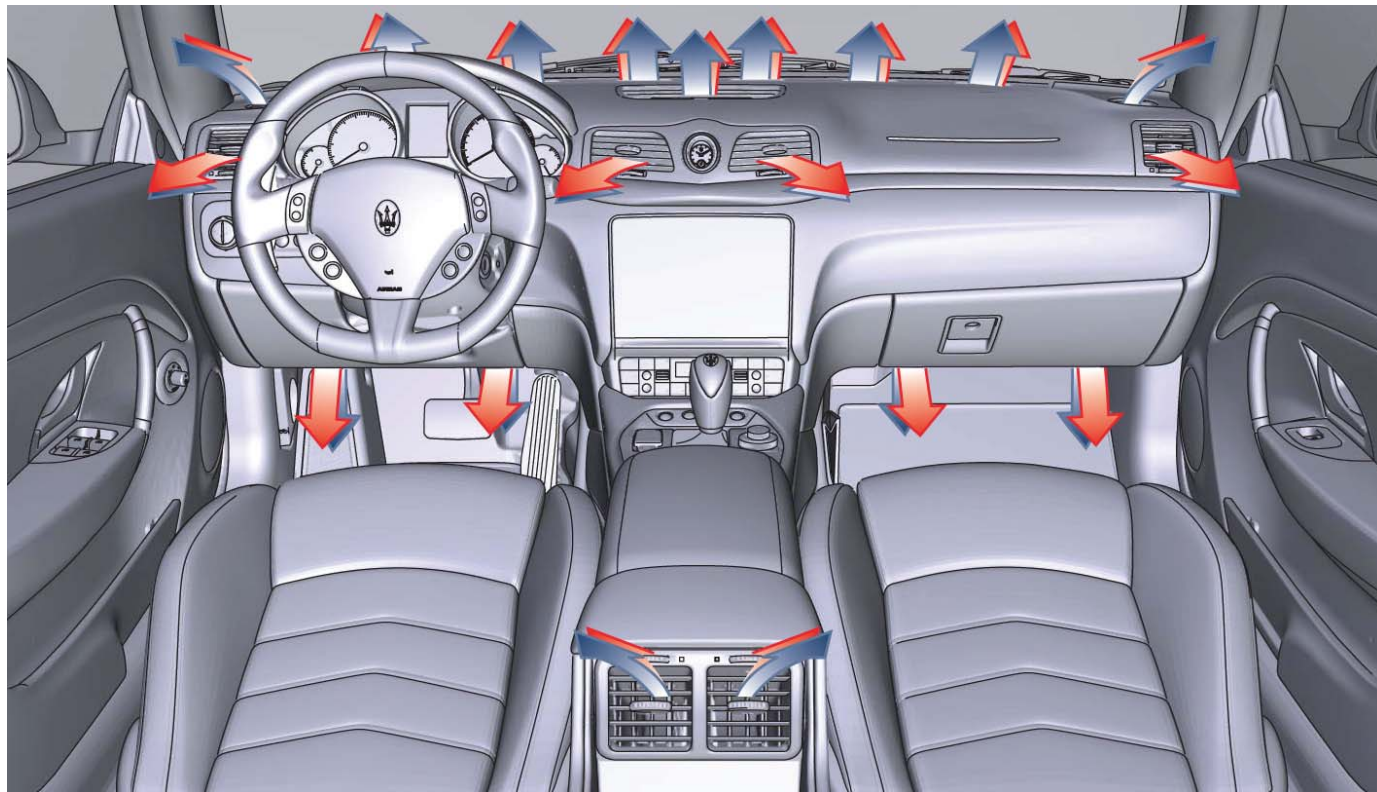



Adjustable and fixed air vents allow passengers to achieve the optimal comfort conditions.

### Fixed Air Vents

- The fixed vents, positioned on the upper part of the dashboard, beneath the windshield are meant to guarantee the defogging and defrosting of the windshield and the side windows.

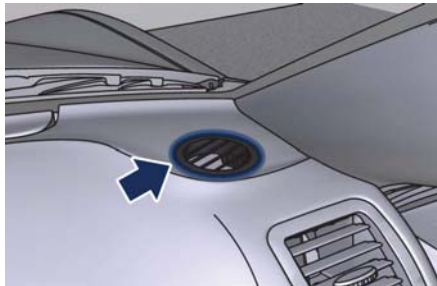
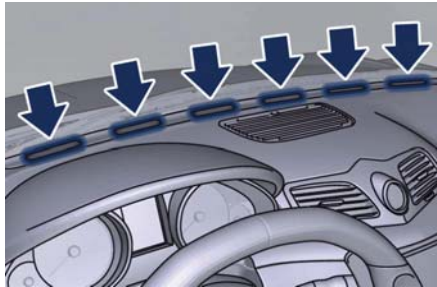

- The fixed vents under the dashboard aim to ventilate the lower part of the passenger compartment.

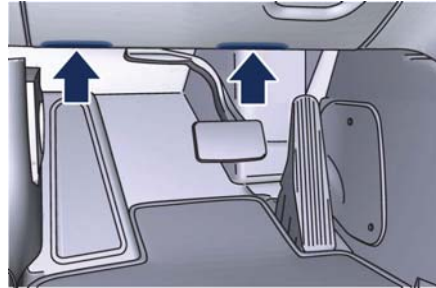

### Adjustable Air Vents

- The adjustable vents are located at the center and at the side ends of the dashboard. They have the purpose of ventilating the upper part of the passenger compartment. There are also adjustable vents placed at the rear end of the central console. These vents can be adjusted in vertical and horizontal direction, by operating on the central handle **1**, indicated in the following pictures. The rotary control **2**, located under each vent, allows to partialize the air flow.

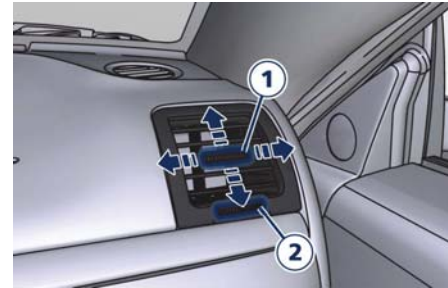

#### NOTE:

*In order not to obstruct the air conditioning inlet, the defrosting or the defogging function of the glass surfaces, avoid covering vents with clothing or other items.*



### Sport Skyhook Suspension (for versions/markets, where provided)

The electronic system controlling the vehicle suspension uses the sophisticated on board sensors and is aimed at optimizing vehicle performance.

The system is capable of constantly monitoring suspension damping by means of the actuator fitted on each shock absorber (Skyhook type). This way, the shock absorber setting is suited to the road surface conditions and vehicle dynamics, thus improving passenger comfort and road-holding. By pressing button "SPORT" on the central console the driver can choose, even while driving, a normal or dynamic-type setting for the suspension, depending on their own driving style.



This way, the system operates with a shock absorber "softer" setting in NORMAL drive mode, and a "harder" setting if SPORT drive mode is selected (see "Drive Mode" in section "Driving").

The strategy used by the system controlling suspension damping is aimed at reducing the vertical oscillations of the vehicle (rolling and pitching) to a minimum.

The activation of SPORT drive mode sets the suspension for sports-style driving and acts on the ASR and gearbox systems as well, modifying their setting for dynamic-style driving.

#### System Components

The system is controlled by an ECU which manages the solenoid valves on each shock absorber in response to the sensor signals, thus adjusting suspension damping and setting.

The sensors which enable the ECU to calculate the vehicle speed, vertical and side acceleration, as well as the instantaneous braking system pressure, thereby controlling suspension damping, are the following:

- front left-hand vertical acceleration sensor;
- front right-hand vertical acceleration sensor;
- rear vertical acceleration sensor;
- front left-hand wheel acceleration sensor;
- front right-hand wheel acceleration sensor;
- lateral acceleration sensor;
- driving speed sensor;
- brake pedal switch.

#### Self-diagnostics

Whenever the engine is started, the system performs a self-diagnostic cycle. If a malfunction is found, the  amber warning light is displayed accompanied by the message "Check suspensions" (see paragraph "Malfunction Indicators" in this chapter).



## Calibration Selection

The driver can select, in relation to road surface conditions, vehicle speed, driving style and comfort, one of the two calibration levels provided by the system: normal or sports-style.

- **Normal calibration**, active when SPORT drive mode is disabled ("SPORT" button not pressed), favors comfort and higher driving stability with low and average grip conditions.
- **Sport-style calibration**, active when SPORT drive mode is enabled ("SPORT" button pressed), favors wheel drive and permits a dynamic-style driving with optimal road holding.

Whenever the engine is started, the system automatically activates NORMAL drive mode, even if SPORT drive mode was selected before the engine was last turned off.

The sport-style calibration can be selected only with the key in the ignition switch in **MAR (ON)** position and it is enabled by pressing button "SPORT", even while driving. When SPORT drive mode is activated, the word "SPORT" on the instrument cluster display and the LED on the button illuminate.



### WARNING!

**SPORT drive mode should not be activated if the road surface is rough or slippery.**

The electronic suspension control system works in combination with the ESC system. When the suspension is set to normal calibration, stability is increased under medium and low grip conditions, while when it is set to sport-style calibration, the ESC system optimizes a sportier driving.



### WARNING!

**In low- and medium-grip conditions (e.g., rain, snow, ice, sand, etc.) it is advisable not to use SPORT drive mode, even with the ESC system enabled.**

## Malfunction Indicators

If one or more electric components in the system prove to be malfunctioning while driving, the ECU illuminates the  amber warning light accompanied by the message "Check suspensions" on the display. In addition, the ECU calibrates the shock absorbers to a

preset value, thus ensuring a safe vehicle set up.

Should the malfunction involve one shock absorber only, this will no longer be controlled by the ECU and will therefore remain set as it was when the fault occurred. It is therefore possible for one of the four shock absorbers to work with a fixed calibration, different from that of the other ones.

In any case, safe and secure vehicle driving is always ensured at low speeds.





### CAUTION!

**In the event of a malfunction in the suspension control electronic system, which will be indicated by the illumination of the amber warning light on the display while driving, keep a moderate speed and have the vehicle checked as soon as possible by an Authorized Maserati Dealer.**

If a malfunction occurs while driving, and this is signaled by the illumination of the  amber warning light on the display, it is advisable to stop the vehicle as soon as possible, turn the key in the ignition switch to **STOP (OFF)** position and then restart the engine.



If the malfunction is no longer present and the  amber warning light on the display does not illuminate again, the electronic suspension system will resume normal operation. On the other hand, if the problem persists, the  amber warning light on the instrument cluster display will turn on again.

3

In both cases, the system must be checked by the **Authorized Maserati Dealer**.

The fault found is memorized by the ECU and can be diagnosed at an **Authorized Maserati Dealer** even if it has disappeared spontaneously.



## **4 – Dashboard Instruments and Controls**

Instrument Cluster . . . . .	118
Infotainment System . . . . .	130
Audio Controls . . . . .	138
Audio System . . . . .	140
MTC+ “Controls” Screen . . . . .	141
MTC+ Settings . . . . .	141
Glove Compartments . . . . .	149
Analog Clock . . . . .	150
Air Conditioning Controls . . . . .	151
Phone and Voice Controls on Steering Wheel . . . . .	155



## Instrument Cluster

The instrument cluster is divided into three main areas displaying information, signs and text and/or icon messages.

- A Fuel level gage with low fuel indicator and analog speedometer showing the vehicle speed.
- B Analog tachometer and coolant thermometer with high temperature warning light.
- C TFT display. In addition to other information, in this area the odometer display shows the total distance covered by the vehicle.

4

Speedometer and tachometer display the main warning lights (see "Warning and Indicator Lights on Analog Instruments" in this chapter). The other warning and indicator lights are displayed on the TFT display together with mode and drive function indicators (see "TFT Display: Warning/Indicator Lights" in this chapter).

**NOTE:**

*The image shows the instrument cluster after the initial check cycle.*

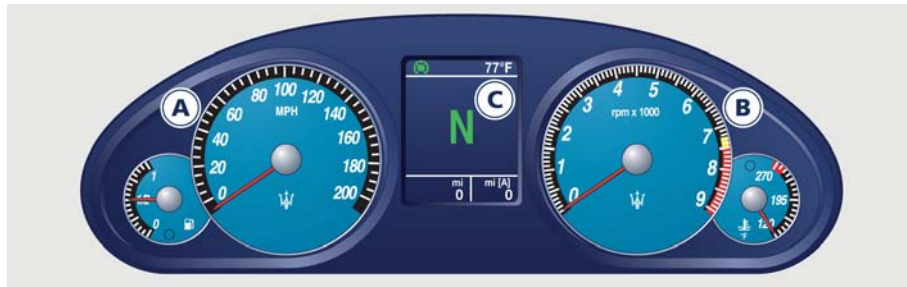

Sport Version



MC Version





## Warning and Indicator Lights on Analog Instruments

### Low Fuel Indicator on Fuel Gage

The illumination of the red indicator inside the gage indicates that there are approx. 4.7 Gallons (18 liters) of fuel in the tank.

If the pointer positions on "0" (beginning of scale) and the fuel reserve indicator flashes, it means that there is a system malfunction.

In this case, contact an **Authorized Maserati Dealer** to have the system checked.



### Telltale on Speedometer

Following telltales are displayed on the fuel level gage and speedometer, and related messages are visible for 10 seconds on the central sector of the display, unless otherwise indicated.

The telltales indicated with (\*) are also displayed on the TFT display (see "TFT Display" paragraph in this chapter).



### Charging System Warning Light



This warning light shows the status of the electrical charging system. If the light stays on or comes on while driving, turn off some of the vehicle's non-essential electrical devices or increase engine speed (if at idle). If the charging system warning light remains on, it means that the vehicle is experiencing a problem with the charging system. Require **IMMEDIATE** service at an **Authorized Maserati Dealer**.

If jump starting is required, refer to "Jump Start Procedures" in section "In an Emergency".

### Malfunction Indicator Light (\*)



The Malfunction Indicator Light (MIL) is part of an onboard diagnostic system that monitors engine and automatic transmission control systems.

Under normal conditions, this indicator light should switch on when the key in the ignition switch is in **MAR (ON)** position and switch off soon after the engine is started.

This is a sign of the indicator light working properly. If the indicator remains lighted up or switches on while driving, there is a failure in the fuel supply/ignition and emission control systems.

The failure could cause high exhaust emissions, loss of performance, poor vehicle handling and high consumption levels.

Under these conditions you can proceed slowly without forcing the engine or driving at high speeds. The indicator light will switch off if the problem is solved.

The error will be registered by the system in any case.



## CAUTION!

- When the key on the key in the ignition switch is in the **MAR (ON)** position and if the indicator light does not switch on or if it switches on while driving, contact an **Authorized Maserati Dealer** as soon as possible.
- Prolonged driving with the MIL on could cause damage to the engine control system. It also could affect fuel economy and drivability. If the MIL is flashing, severe catalytic converter damage and power loss will soon occur. Immediate service is required.

### Parking Lights Indicator



With the key removed from the ignition switch, it indicates that the parking lights are on.

### Transmission Failure Warning Light (\*)



Depending on the message displayed it signals:

- a transmission failure. If the failure permits, slowly drive to the nearest **Authorized Maserati Dealer**;

- a too high temperature of the transmission oil. In this case, slow down until the temperature goes down to the normal values for use (the warning light goes off).

For further information see chapter "Automatic Transmission" in section "Driving".



## CAUTION!

Continuous driving with the transmission temperature warning light illuminated will eventually cause severe transmission damage or failure.



## WARNING!

If the transmission temperature warning light is illuminated and you continue operating the vehicle, in some circumstances you could cause the fluid to boil over, come in contact with hot engine or exhaust components and cause a fire.

### High Beam Indicator



This indicator lights up when the high beams are switched on or when blinking.

### Low Oil Pressure Warning Light (\*)



Under normal conditions, the warning light illuminates when the key in the ignition switch is turned to **MAR (ON)**

position and goes off as soon as the engine is started.

If the warning light stays or turns on while driving, the engine oil pressure is too low. The warning light is combined with a displayed message. In this case, turn the engine off immediately and carry out the necessary checks.

Do not operate the vehicle until the problem has been solved. This light does not indicate the oil level. The engine oil level must be checked with the dipstick located under the hood (see "Maintenance Procedures" in section "Maintenance and Care"). If the problem persists, contact an **Authorized Maserati Dealer**.

### Headlight On Indicator



This indicator will illuminate when the position lights or headlights are turned on.

For further details, see

"Lights" in section "Understanding the Vehicle".



### Left Turn Signal Indicator Light



The indicator lights up when the left turn signals or the hazard flashers are turned on.

The indicator light will flash at the same frequency of the turn signals and is controlled by the left multifunction lever.

If the vehicle electronics sense that the vehicle drives for more than 1 mile (1.6 km) with either turn signal on, a continuous sound will alert the driver to turn the signal off.

If the indicator flashes at a rapid rate, check for a defective exterior light bulb.

### Rear Fog Light Indicator



This indicator lights up when the rear fog lights are switched on.

### Tire Pressure Monitoring Light (\*)



This indicator light is connected to the Tire Pressure Monitoring System (TPMS).

Under normal conditions, the warning light should illuminate when the key in the ignition switch is in **MAR (ON)** position and should go off as soon as the engine is started. If the warning light remains lit or illuminates while driving, the pressure

of one or more tires is too low: the related message will be displayed. If the warning light flashes prior to remain on, it indicates that the system is temporarily unavailable.

This warning light illuminates even when you calibrate the TPMS and remains lit until the system is calibrated.

Please refer to “Tire Pressure Monitoring System (TPMS)” in section “Driving” for further information.

### Telltale on Tachometer

Following telltales are displayed on the tachometer and related messages are visible for 10 seconds on the central sector of the display, unless otherwise indicated (see “TFT Display” in this chapter).

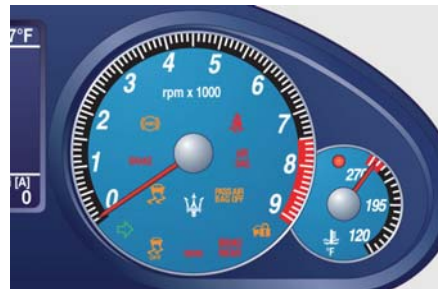

### Anti-Lock Brake Light (\*)



This light, and its related message, indicate possible malfunctions of the Anti-Lock Brake System (ABS).

The light will turn on when the key in the ignition switch is in **MAR (ON)** position and may stay on for 4 seconds. If the ABS light remains lit or turns on while driving, the Anti-Lock portion of the brake system is not functioning and requires service. However, the conventional brake system will continue to operate normally if the **BRAKE** indicator light is switched off. If the ABS light turns on while driving, or if it does not switch on when the key in the ignition switch is in **MAR (ON)** position, please visit as soon as possible an **Authorized Maserati Dealer** in order to restore the Anti-Lock brakes functions.

### Seat Belt Reminder Light (\*)



When the key in the ignition switch is in **MAR (ON)** position, the seat belt reminder light will light up for a few seconds as a bulb check.

During the bulb check, you will hear an acoustic signal if one or both front seat belts are unbuckled.



After the bulb check or while driving, if driver or front passenger seat belt is unbuckled, together with the acoustic signal the seat belt reminder light will light up.



### **WARNING!**

Maserati urges you to use the seat belts correctly fastened and adjusted at all times. Correct use of the seat belts can help reduce the risk of serious injury in the event of an accident. Do not pass seat belts over sharp edges: they could tear. Do not pin anything to the seat belts. This could reduce their initial strength and cause them to tear in the event of a crash.

Refer to “Occupants Restraint Systems” in section “Before Starting” for further information.

### **Low Brake Fluid Warning Light (\*)**



This warning light illuminates when the brake fluid level drops below the minimum level. If accompanied by a specific message, it indicates an EBD system failure.

In this case, do not apply the brakes suddenly, since this may cause an early

locking of the rear wheels. Driving extremely carefully, immediately go to the nearest **Authorized Maserati Dealer** to have the system checked.



### **WARNING!**

If the warning light illuminates while driving, immediately check the brake fluid level. If the fluid is below the minimum level, there may be a leak in the circuit. Contact an **Authorized Maserati Dealer** before driving further.

### **Air bag/Pretensioner Warning Light (\*)**



This warning light will illuminate for a few seconds for a bulb check when the key in the ignition switch is in **MAR (ON)** position. If the light does not illuminate while starting the engine, stays lit, or switches on while driving, have the system checked at an **Authorized Maserati Dealer** as soon as possible.

In the latter case, the message will remain displayed.

See “Supplemental Restraint System (SRS) – Air bags” in section “Before Starting” for further information.



### **WARNING!**

If the indicator light remains ON or if it does not illuminate or illuminates while driving, contact an **Authorized Maserati Dealer** as soon as possible.

### **Electronic Stability Control (ESC) Malfunction Indicator Light (\*)**



This indicator light on the instrument cluster will display when the key in the ignition switch is in **MAR (ON)** position.

It should switch off by starting the engine.

If the light stays on with the engine running, there is a malfunction in the ESC system.

If the light still stays on after several ignition cycles, and the vehicle has been driven for several kilometers at more than 30 mph (48 km/h) speed, visit an **Authorized Maserati Dealer** as soon as possible to have the problem diagnosed and restored.

### **NOTE:**

Each time the key in the ignition switch is turned in **MAR (ON)** position:

- The ESC off indicator light and the ESC malfunction indicator light illuminate temporarily.



- The ESC system will be on, even if it was turned off previously. The ESC system will make buzzing or clicking sounds when active. This is normal; the sounds will stop when ESC becomes inactive by solving the problem that caused the ESC activation.

### Air Bag Malfunction Warning Light (\*)



The warning light flashes to indicate a malfunction of the AIR BAG warning light.



#### WARNING!

- Turning the key in the ignition switch to MAR (ON) position, the air bag malfunction warning light illuminates but should go off after a few seconds with the engine running.
- If the air bag malfunction warning light remains on or stays on or if it does not illuminate or if it illuminates while driving, contact your Authorized Maserati Dealer as soon as possible.

### Right Turn Signal Indicator



This indicator lights up when the right turn signals or the hazard flashers are switched on.

The indicator will flash at the same frequency of the turn signals and is controlled by the left multifunction lever.

If the vehicle electronics sense that the vehicle drives for more than 1 mile (1.6 km) with either turn signal on, a continuous sound will advise the driver to turn the signal off.

If the indicator flashes at a fast rate, check for a defective outside indicator light bulb.

### Maserati CODE Warning Light (\*)



With the key in the ignition switch in MAR (ON) position, the amber warning light in the instrument cluster and on

the display illuminates when the system detects the following faults:

- alarm system not available;
- electronic key not detected;
- have the vehicle protection system checked.

Or when the user is informed of the following events:

- vehicle break-in detected;

- electronic key not recognized.

### Electronic Stability Control (ESC) OFF Indicator Light



This indicator notifies that the Electronic Stability Control (ESC) is disabled; the linked message will be displayed.

### Parking Brake Engaged Indicator



This indicator light illuminates when the parking brake is applied.

### Brake Pads Worn Warning Light (\*)



This warning light illuminates on the instrument cluster when the brake pads have reached their wear limit.

Please contact an **Authorized Maserati Dealer**.

### High Coolant Temperature Warning Light

The thermometer in the instrument cluster indicates the temperature of the coolant. If the needle indicates high temperatures and at the same time the warning light comes on, stop the vehicle immediately and have the cooling system checked by an **Authorized Maserati Dealer**.



- 5 total odometer;
- 6 trip odometer "A", "B" or vehicle speed repeated;
- 7 other indicators or warning lights that may be displayed as icons (see "TFT Display: Warning/Indicator Lights" in this chapter);
- 8 outside temperature.

## TFT Display: Menus and Settings

The TFT display performs the following functions:

- provides general information while driving;
- signals failures and warnings.

The user can interact with the system by setting the parameters for the information that can be recalled.

The screen page displayed following the initial check cycle, in normal operating conditions, (standard screen page) contains the following information:

- 1 date;
- 2 time;
- 3 gear engaged;
- 4 driving mode;



From the "Settings" menu in the MTC+, the user can also choose to have the information displayed for the trip, audio, media, navigator and phone repeated on the instrument cluster. For the relevant procedures and instructions, see the chapter "MTC+ Settings", in this section, and "On Board Computer (Trip)" in section "Driving".

## TFT Display: Controls

### Mode Button

The screen page activation and setting are controlled by pressing the "MODE", "+" and "-" buttons on the left control panel next to the steering column.

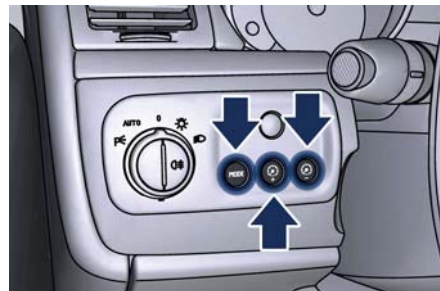

Pressing the "MODE" button briefly will switch to the following screen pages in sequence:

- Trip A.
- Trip B.
- Tire pressure.
- TPMS calibration.
- Front left seat comfort.
- Front right seat comfort.
- Standard.





### “+” and “-” Buttons

By means of the “+” and “-” buttons, the user can adjust the instrument cluster brightness.

When a screen page is viewed, these buttons can be used to select the available options (see paragraph “TFT Display: Screen Pages” in this chapter).

## TFT Display: Screen Pages

### Trip Screen Page

The Trip screen page is recalled by pressing the “MODE” button. Each Trip screen page “A” or “B” is timed, i.e. it is displayed for a maximum of 10 seconds, after which the screen page previously active is displayed once again.

Before the 10 second timing has elapsed, pressing the “MODE” button briefly (less than 2 seconds) will reset the trip information relating to the flashing odometer “A” or “B”.

When the “Trip A” or “Trip B” feature is active, the following information is viewed on the display:

- traveled distance (shown in the lower right area);
- average fuel consumption (Avg. cons.);
- average traveling speed (Avg. speed);

- trip time;
  - fuel range (Range);
- The unit for this data can be adjusted by the user from the MTC+ Settings menu.



#### NOTE:

*Trip and Service information can be viewed by accessing the “Trip” menu on the MTC+ screen (see “On Board Computer Trip (Trip)” in section “Driving”).*

### Tire Pressure Screen Page

If the vehicle is equipped with the Tire Pressure Monitoring System (TPMS), by pressing the “MODE” button the user will display information about the tire pressure.

This screen page is displayed for 10 seconds and, in normal conditions (calibrated system and no faults), it will appear as shown in the picture.



In addition, the system acknowledges the following conditions:

- low pressure or puncture in one or more tires;
- system not calibrated;
- system failure.

For further details, see “Tire Pressure Monitoring System - TPMS” in section “Driving”.

### TPMS Calibration Page

Select the “TPMS CALIBRATION” screen page by pressing the “MODE” button to calibrate the system. This operation is necessary after replacement or reversal of one or more tires: in these cases the (⚠) warning light will illuminate on the instrument cluster and the display will show the message warning the driver to calibrate the system.





## NOTE:

The TPMS calibration operation is possible even with the engine running but the vehicle must be stationary (0 mph-km/h).

See "Tire Pressure Monitoring System (TPMS)" in section "Driving" to calibrate the system.



### Comfort Screen Page

Repeatedly press the "MODE" button to display the screen page showing the operating status of the heating system for each seat.

The user can view the following information:

- seat indication;
- heating level.



This screen page remains displayed for 10 seconds.

### RPM Indicator Page (MC version only)

The "RPM INDICATOR" screen page allows the user to display, within the standard screen page, also a virtual RPM gage.

The screen page can be recalled by pressing the "MODE" button repeatedly. The options available are the following:

- ON (display enabled);
- OFF (display disabled).

The chosen option is activated if the user presses the "MODE" button to confirm it.



If the audio or navigation data repetition option is active on the MTC+, when the user sets the virtual RPM indicator this setting shall be ignored until the repetition function is disabled (see "NTC+ Settings" in this section).

### TFT Display: Warning/Indicator Lights

Besides some warning/indicator lights shown inside the analog instruments (indicated by (\*)) in the "Warning and Indicator Lights on Analog Instruments" paragraph of this chapter) the TFT display shows in the dedicated area other warning/indicator lights with the relevant messages for 10 seconds, unless otherwise specified.



### Low Engine Oil Level Warning Light



This warning light and the related displayed message, indicate a low engine oil level.

The engine oil level must be checked with the dipstick fitted under the hood (see "Maintenance Procedures" in section "Maintenance and Care").

### Power Steering Failure Warning Light



This warning light, and the related message, illuminate when the power steering is not operating and needs

service.

Drive slowly by to the nearest **Authorized Maserati Dealer**, being extremely careful as steering effort may increase.

### Catalyst Over Temperature Warning Light



This warning light, and the related message, light up if the engine runs irregularly with consequent high

temperature in the exhaust system.



### WARNING!

**California Proposition 65**  
Operating, servicing and maintaining a passenger vehicle or off-road vehicle can expose you to chemicals including such as, engine exhaust, carbon monoxide, phthalates and lead, that which are know to the State of California to cause cancer and birth defects or other reproductive harm. To minimize exposure, avoid breathing exhaust, do not idle the engine except as necessary, service your vehicle in a well-ventilated area and wear gloves or wash your hands frequently when servicing your vehicle. For more information go to:  
[www.P65Warnings.ca.gov/passenger-vehicle](http://www.P65Warnings.ca.gov/passenger-vehicle)



### WARNING!

- If the warning light is accompanied by the message "High catalyts temperature slow down": the temperature of the catalytic converters is too high. The driver must slow down immediately until the warning light turns off.
- If the message "Excessive catalyts temperature do not drive on" appears after decelerating: the temperature in the catalytic converters has reached a dangerous level and the catalytic converters could be damaged. Drive slowly to the nearest Authorized Maserati Dealer.
- Maserati declines all responsibility for whatever damage deriving from non compliance with the above mentioned warnings.



## Engine Temperature Warning Light



This warning light coupled with the light on the coolant thermometer notifies when the engine is overheated. If

the temperature reaches critical levels this warning light will illuminate in red color combined with the related message on display.

If the indicator light switches on while driving, safely pull over and stop the vehicle. If the A/C system is on, turn it off. Also, shift the transmission into N (Neutral) and idle the vehicle. If the temperature does not return to normal, immediately turn the engine off and contact an **Authorized Maserati Dealer**.

Check "Engine Overheating" in section "In an Emergency" for more information.

## Doors and Lids Open Warning Light



This warning light indicates that the doors or lids are open or not properly closed. The instrument cluster display also

shows an image of the vehicle with the part not closed highlighted in red and the related message.



### **WARNING!**

**Before starting off, close any doors and lids that are open or not properly closed.**

## Soft Top Failure Warning Light



This warning light illuminates if the hydraulic and electric soft top movement systems fail.

## Fuel Cutout Enabled Warning Light



This warning light illuminates when a collision activates the inertia switch, thus cutting off the fuel supply.



### **WARNING!**

**After a collision, if you smell fuel or note leakages from the fuel system, do not reactivate the switch in order to prevent the risk of fire.**

## Windshield and Headlights Washer Low Fluid Indicator



This indicator will illuminate for 10 seconds to indicate a low level of the windshield and headlights washer fluid. A related message will be displayed.

See "Maintenance Procedures" in section "Maintenance and Care" for fluid filling.

## Lighting System Failure Warning Light



This warning light illuminates in the case of a system failure or burning-out of the position, turn signal, rear fog and license plate light bulbs.

See "Bulb Replacement" in section "Maintenance and Care" for further details.

## Stop Light Failure Warning Light



This warning light illuminates in the case of a system failure or burning-out of the stop light bulbs.

See "Bulb Replacement" in section "Maintenance and Care" for further details.

## Twilight Sensor Failure Warning Light



This warning light illuminates in the case of a failure of the twilight sensor.

Contact an **Authorized Maserati Dealer** to have the vehicle checked.



### Adaptive Light Control System Failure Warning Light



This warning light, and the related message, indicate a failure of the automatic headlight aiming system.

Please contact an **Authorized Maserati Dealer** to check the system.

### ASR System Failure Warning Light



This warning light indicates the deactivation or failure of the ASR system.

In the event of a failure, contact an **Authorized Maserati Dealer**.

### Rain Sensor Failure Warning Light



This warning light indicates that the rain sensor of the windshield wiper system is faulty.

Please contact an **Authorized Maserati Dealer** to check the system.

### Park Assist Sensor Failure Warning Light



This warning light indicates that the sensor of the park assist system is faulty.

Please contact an **Authorized Maserati Dealer** to check the system.

### Suspensions Failure Warning Light



This warning light and the related message turn on while driving if there is a failure of the suspension system.

Please contact an **Authorized Maserati Dealer** to check the system.

### Ice Hazard Indicator



When the external temperature falls below 3°C (38°F), the temperature value blinks for a few seconds, the

warning light turns on and a message is displayed to warn the driver of the risk of icy roadbed.

Under such conditions, we recommend using the ICE drive mode (see “Automatic Transmission” in section “Driving”) drive carefully and slow down as the grip of the tires may be significantly reduced.

The warning light switches off when the temperature reaches 6°C (43°F) or higher.

### EPB Automatic Operation Disabled Warning Light



This warning light and related message illuminate when the EPB automatic activation/deactivation function is

disabled.

The failure could also completely or partially block the vehicle because the parking brake could remain on even after it has been automatically or manually disengaged though its controls.

If it is still possible to use the vehicle (parking brake not engaged) drive to the nearest **Authorized Maserati Dealer** and remember to perform each operation/command during which the electric parking brake does not work.

### Seat Heating Indicator



It indicates that the heating function is activated on one or more seats.

### Maintenance Schedule Indicator



Depending on the accompanying message, this indicates that service schedule deadlines are either

approaching or due. Upon reaching a deadline, contact an **Authorized Maserati Dealer**.

### Cruise Control (CC) set indicator



This green light indicator will illuminate when the CC is set. For further information, check “Electronic Cruise Control” in section “Driving”.



## Maintenance Schedule Indicator



Depending on the accompanying message, this indicates that service schedule deadlines are either

approaching or due.

Upon reaching a deadline, contact an **Authorized Maserati Dealer**.

## Cruise Control (CC) set indicator



This green light indicator will illuminate when the CC is set.

For further information, check "Electronic Cruise Control" in section "Driving".

## SPORT Drive Mode Indicator



This indicator illuminates when the button that sets the vehicle to the SPORT mode is pressed.

### NOTE:

- *SPORT mode changes the vehicle driving features.*
- *SPORT mode should not be activated if the road surface is in poor conditions or slippery.*
- *In low- and medium-grip conditions (e.g., rain, snow, ice, sand, etc.) it is advisable not to activate SPORT mode, even with the ESC enabled.*

## ICE Drive Mode Indicator



This indicator illuminates when the low grip function is active.

## Fuel Economy Indicator



While driving, the system will indicate that you should shift gears in order to optimize fuel consumption when the required speed is reached.

The recommended gearshift indicator will only work when the transmission is set to manual sequential operation.

## AUTO Drive Mode Indicator



This indicator illuminates when the automatic drive mode is active.

## MANUAL Drive Mode Indicator



This indicator illuminates when the manual drive mode is active.

## Infotainment System

The vehicle is equipped with the Infotainment Maserati Touch Control Plus (MTC+) System, an advanced user interface which incorporates the on-board computer and combines innovative and exclusive technical features integrating entertainment, user settings, satellite navigation system (with digital maps where available), communication and information features within a single system.

The MTC+ System features an audio system which is acoustically optimized for this specific vehicle.



### WARNING!

**The navigation system assists the driver while driving, providing advice and suggestions, by voice guidance and graphic information, for the best route to reach the set destination. The suggestions provided by the navigation system do not relieve the driver from full responsibility for the maneuvers made through traffic while driving, or from compliance with road regulations and other provisions regarding road traffic. The person**

**driving the vehicle is always and in any case responsible for safe driving on the road.**

The vehicle is provided with a specific add to the owner's manual, describing the MTC+ System features and listing all warnings and precautions, which are essential for a safe use of the system. Maserati advises you to read this add carefully and thoroughly. The MTC+ display is positioned in the central part of the dashboard and the manual controls and devices for connecting external sources are positioned on the central console.

- 1 MTC+ touch display.
- 2 Ports for SD card, AUX and USB inside the central console glove compartment (for further details, refer to "Interior features" in section "Understanding the Vehicle").
- 3 ≡ "Browse" and "Mute" button.
- 4 ↶ "Back" button.
- 5 "Enter" button and shutdown/restart MTC+ system.
- 6 Volume control.
- 7 Tune/scroll control.

In addition to these commands, in "Radio", "SiriusXM Satellite Radio" (if available) and "Media" mode you can use the audio controls on the steering wheel (see "Audio Controls" in this section for further information).

**NOTE:**

*"SiriusXM Satellite Radio" is the US service only available in the 48 Continental United States and Canadian markets. Subscription is required. For further details refer to the Maserati Touch Controls Plus (MTC+) guide.*

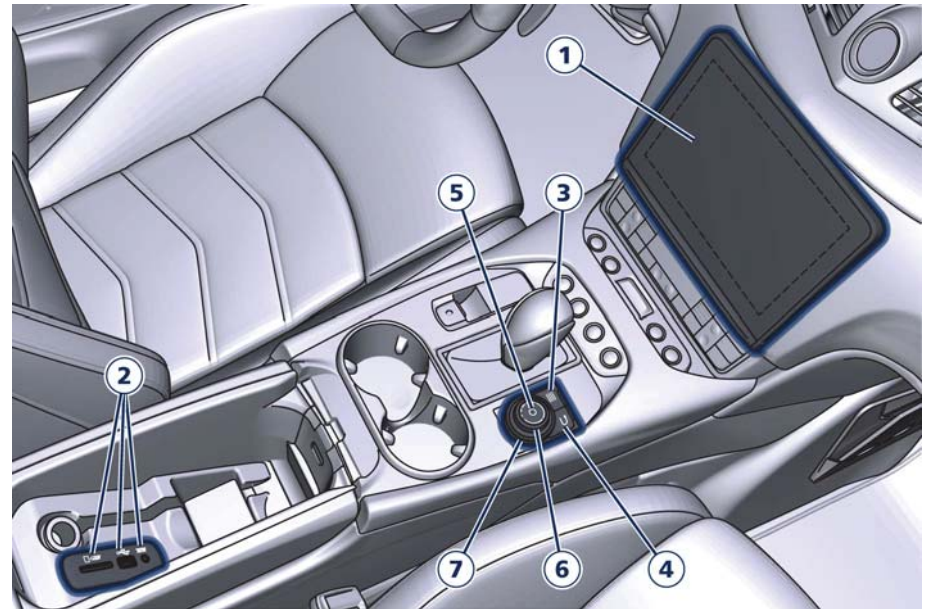





### Manual Controls and Devices

#### SD, AUX and USB Ports

When an SD card is inserted into its housing, the MTC+ is able to read it and select multimedia files (music and images) from the device.

By using the AUX and USB (full) inputs it is possible to connect external devices to the MTC+ (see chapter "Interior features" in section "Understanding the Vehicle").

After connecting the device, by using the MTC+ display softkeys, knobs on the central console and controls at the steering wheel, user can navigate through the content of the connected device and set its playing mode.

#### Multimedia Navigation Controls on Central Console

The manual controls located on the central console are a further interface for the driver and nearby passenger, that adds to the MTC+ display softkeys. Using the manual controls, the MTC+ display will work as a graphic display of the inputs from the controls.

#### Volume Control

By working this knob in "Radio", "SiriusXM Satellite Radio" (if available) or "Media" mode, user can adjust the

volume of the radio or audio files, from minimum to maximum and vice versa. Turn knob clockwise to increase the volume, anti-clockwise to decrease it. The volume status will be indicated in the top part of the MTC+ display.

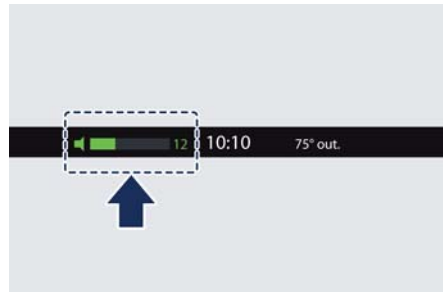

#### Tune/Scroll Control

By working this knob in "Radio", "SiriusXM Satellite Radio" (if available) or "Media" mode, user can shift through the radio stations/channels or scroll the tracks inside connected external devices and confirm the selection by pressing enter button. In any other mode of the MTC+, use this knob to scroll the list of available options or to manage the cursor movement in the lower bar of the main menus. Then press enter button to confirm the function or setting highlighted on MTC+ display.

#### ≡ Browse/Mute Button

After selecting a function, using the tune/scroll knob or softkeys on MTC+ display, press this button to see the detail of the items/options of the selected function. This button is also used as short cut to display the phone book, when the "Phone" menu is selected, or the favorites when the "Nav (Navigation)" menu is selected. Press and hold this button for 2-3 seconds to mute the volume of the radio or media files. The volume mute status will be indicated in the top part of the MTC+ display.

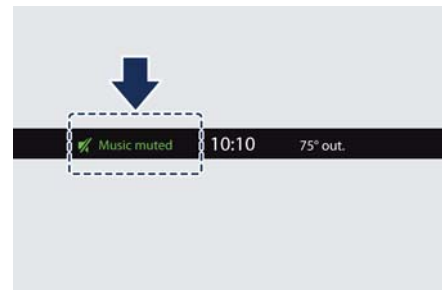

#### ⇨ Back Button

Press this button to go back to previous menu or previous screen. Press this button to shift the navigation one level backward on MTC+ screen. If it is pressed and held





for at least 2 seconds, it brings the cursor back in the lower bar of the main menus.

### Enter Button

To confirm the function or setting highlighted on MTC+ display. When in "Radio" mode and the key in the ignition switch in **MAR (ON)** position, holding this button you can save your preset stations.

With key not inserted in the ignition switch or in **STOP (OFF)** position, pressing and holding this button for 2-3 seconds will turn off the MTC+ system. If pressed again and held for 2-3 seconds, the MTC+ will turn back on.

### Main Menu Bar on MTC+ Display

The softkeys located on the lower part of the MTC+ display represent the main menu modes/functions, which are briefly indicated below.



Main menu bar is set up by Maserati: it can be customized according to personal requirements, as explained in "Customizing the Main Menu Bar" in this chapter.

For further information refer to the dedicated booklet included in the owner documentation.

1. **"Radio"** softkey  
Touch this softkey to enter the Radio mode. The different tuner modes: FM, AM, SiriusXM Satellite Radio (if equipped) and "Aha" App (for countries where it is supported) can be selected by touching the related softkeys in the Radio mode.
2. **"Media"** softkey  
Touch this softkey to access media sources such as: USB Device, AUX, Bluetooth and SD card as long as the requested media is present.
3. **"Controls"** softkey  
Touch this softkey to access the "Screen Off" and "Settings" features. Features can be selected and turned on/off or adjusted by touching the related softkey (see "MTC+ "Controls" Screen" in this section).
4. **⌘ (Apps)** softkey  
Touch this softkey to access connected phone connection options and user functions settings.
5. **"Trip"** softkey  
Touch this softkey to access the trip features. Refer to "Onboard Computer (Trip)" in section "Driving" to choose from the available options.
6. **"Nav"** softkey  
Touch this softkey to access the Navigation feature. Refer to the MTC+ instruction manual for further details.



## 7. "Phone" softkey

Touch this softkey to access the MTC+ Phone feature that can be set or monitored via MTC+.

Touch one of these softkeys to access the list of functions that the user can set.

## Touchscreen Display Warnings



### CAUTION!

- Do NOT attach any object to the touchscreen, doing so can result in damage to the touchscreen.
- Do not press the screen with any hard or sharp objects (pen, USB stick, jewelry, etc.) which could scratch the touchscreen surface.
- Do not spray any liquid or caustic chemicals directly on the screen. Use a clean and dry micro fiber lens cleaning cloth in order to clean the touchscreen.
- If necessary, use a lint-free cloth dampened with a cleaning solution, such as isopropyl alcohol, or an isopropyl alcohol and water solution ratio of 50:50. Be sure to follow the solvent manufacturer's precautions and directions.

## Switch OFF Touch screen Backlight

If the screen backlight becomes annoying when driving, it is possible to switch it off.

Switch off the screen backlight by touching "Screen OFF" softkey in the "Controls" screen of MTC+ display.

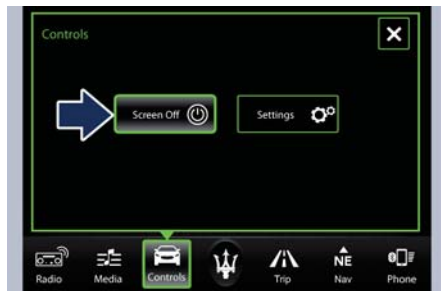

## Customizing the Main Menu Bar

The softkeys for the main functions of the MTC+ system, indicated at the bottom of the MTC+ display, can be easily customized to suit user's requirements, as follows:

- press  $\Psi$  button to open applications/settings screen;
- hold depressed and drag the icon corresponding to the selected function until it overlaps the one to be replaced on the bottom bar.



Once it is set in the menu bar, the new connection will be immediately operational.

## Use the MTC+ Display as Projection Device

If your smartphone is properly connected to the vehicle via the USB (full) port, in the  $\Psi$  (Apps) screen in place of "Phone" softkey and in the source list of "Media" screen you can find the "Apple CarPlay" (example shown in picture) or the "Android Auto" app softkey (according to the MTC+ System installed). "Android Auto" app needs to be downloaded on your mobile device.



These applications use the MTC+ display as projector of the functions available on the connected device. "Apple CarPlay" allows the best use of your iPhone® in the car and perfect integration with the MTC + display and with the controls of the car, including Siri voice control. You can make phone calls, access to music, send and receive messages, get real-time directions on traffic conditions, staying focused on the road.

The "Android Auto" app lets you share information while driving and make it easier to access Google. The interface is equipped with Google Maps with voice guided navigation, traffic information in real time, on-demand access to millions of songs in Google Play Music. It also offers the possibility to make phone calls or send and receive messages without taking



your hands off the steering wheel. You can also request Google to make any type of research. Android Auto will give an easier access to applications and content from the MTC+ system display. The following tables show the "Screen" and "Audio" source (of projection device  or of MTC+ System ) when a smartphone is connected, a session is established and the device (Table A) or the MTC+ System (Table B) is performing an action.



























































Table A: device is performing an action

Action	MTC+ System  : Active Mode				
	 Radio	 Media	 Navigation	 Phone	 Voice Rec.
No App active	Screen: Audio:	Screen: Audio:	Screen: Audio:	Screen: Audio:	Screen: Audio:
Start Media Player	Screen: Audio:	Screen: Audio:	Screen: Audio:  +		Screen: Audio:
Start Navigation	Screen: Audio: + Audio priority	Screen: Audio: + Audio priority	Popup to ask which Nav to use		Screen: Audio: + Audio priority
Start Phone Call	Screen: Audio:				
Start Voice Rec.	Screen: Audio:	Screen: Audio:	Screen: Audio:	Screen: Audio:	Screen: Audio:

4



Table B: MTC+ is performing an action

Action 	Device  : Active Mode				
	No App active	 Media	 Navigation	 Phone Call	 Voice Rec.
Start Radio	Screen:  Audio: 	Screen:  Audio: 	Screen:  Main Audio:  + mix  prompt nav	Screen:  Audio: 	Screen:  Audio: 
Start Media Player	Screen:  Audio: 	Screen:  Audio: 	Screen:  Main Audio:  + Audio priority	Screen:  Audio: 	Screen:  Audio: 
Start Navigation	Screen:  Audio: 	Screen:  Main Audio:  + Audio priority	Popup to ask which Nav to use	Screen:  Audio:  + Audio priority	Screen:  Audio:  + Audio priority
Start Phone Call	Screen:  Audio: 				
Start VR 	Screen:  Audio: 	Screen:  Audio:  + Audio priority	Screen:  Audio:  + Audio priority	Cannot start VR during Call	Screen:  Audio: 
Start Rearview Camera	Screen:  Audio: 	Screen:  Audio: 	Screen:  Audio: 	Screen:  Audio: 	Screen:  Audio: 



## Audio Controls

The vehicle is equipped with audio controls that allow both driver and front passenger to operate the audio system. These controls can be used to adjust audio volume, change radio station/channel or mode (FM, AM, USB, etc).

### Steering Wheel Audio Controls

#### On Front Side of Steering Wheel

The audio controls are rocker-type switches and buttons located in the front side of the steering wheel. The function of these controls is the following:

- + Increases the sound system volume.
- Decreases the sound system volume.

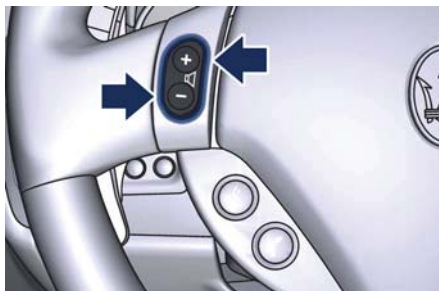

- ⏮ "Radio" mode: if pressed briefly, search for the first tunable station with higher frequency.
- ⏮ "SiriusXM Satellite Radio" mode (if available): if pressed briefly goes to the next category starting from the one currently selected.
- ⏮ "Media" mode: if pressed briefly, track fast forward.

- ⏭ "Radio" mode: if pressed briefly, search for the first station with a lower frequency that can be tuned in to.
- ⏭ "SiriusXM Satellite Radio" mode (if available): if pressed briefly goes to the previous category starting from the one currently selected.
- ⏭ "Media" mode: if pressed briefly, goes to the previous track if selected within the first 3 seconds of track playing. Otherwise the track is played again from the beginning.
- ⏭ "Media" mode: if pressed longer, track fast forward.

**SRC** Mode selection: "Radio" or "Media".

🔇 Mute function on/off.



**NOTE:**

*“SiriusXM Satellite Radio” is the US service only available in the 48 Continental United States and Canadian markets. Subscription is required. For further details refer to the Maserati Touch Controls Plus (MTC+) guide.*

**On Rear Side of Steering Wheel**

These audio controls are rocker-type switches with a button in the center and are located on the rear side of the steering wheel, right behind the front audio switches (the picture shows the audio controls on the left side).

These controls replicate the functionality of the tune/scroll bottom rotary knob on the central console. The functionalities are the same on both rocker-type switches.

By working these rocker-type switches in “Radio” or “Media” mode, user can shift through the radio stations/channels or scroll the tracks inside connected external devices and confirm the selection by pressing the central button.

In any other mode of the MTC+, use these controls to scroll the list of available options or to manage the cursor movement in the lower bar of

the main menus. Then press the central button to confirm the function or setting highlighted on MTC+ display.

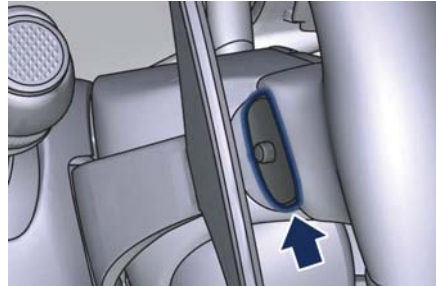
**Audio Controls on Central Console**

In “Radio” or “SiriusXM Satellite Radio” (if available) mode, turn the volume upper knob to set the audio volume, or turn the tune/scroll bottom knob to tune station.

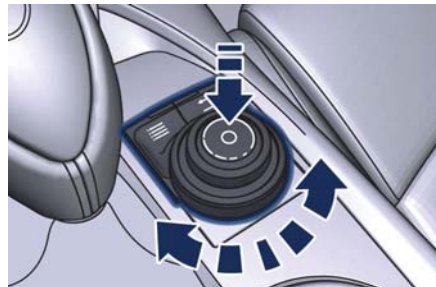

For further details, refer to “Infotainment System” in this section. When in “App” or “Settings” mode, the tune/scroll bottom knob and the browse ≡ and enter buttons allow you to scroll through the menus and change the user’s settings (see “MTC+ Settings” in section “Dashboard Instruments and Controls”). When in “Radio”, “SiriusXM Satellite Radio” (if available) or “Media” mode the browse ≡ and enter buttons allow you respectively to mute the audio volume and to turn off the MTC+ system.





### Audio System

The vehicle is equipped with an audio system that offers superior sound quality, higher sound pressure levels and reduced energy consumption. The system maximizes the amplifier and speaker technology delivering substantially higher components and system efficiency.

#### Premium System

The vehicle is equipped with a "Premium" sound system which features 9 speakers and can develop a sound output of 900 W.

#### System Components

The "Premium" system includes:

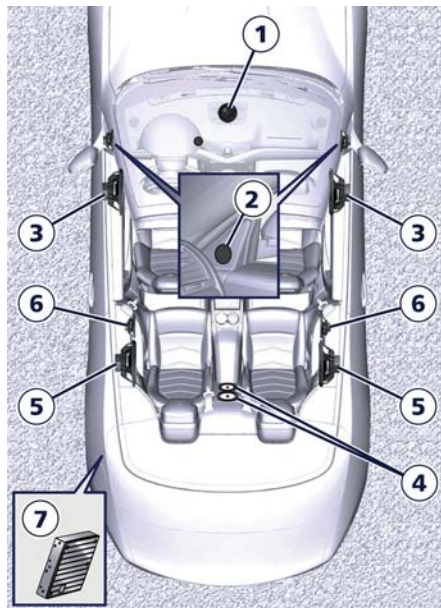

- 1 One 3.1 in (80 mm) Centerfill positioned centrally on the dashboard.
- 2 Two 1 in (25 mm) Tweeter positioned in the passenger compartment, near the outside rearview mirrors.
- 3 Two 6.5 in (165 mm) Mid-Woofer on each of the door panels.

- 4 One Sub-Woofer powered by two amplifiers and housed in a central position between the two rear seats.
- 5 Two 6.5 in (165 mm) Mid-Woofer on the side panels of the rear seats.
- 6 Two 1 in (25 mm) Tweeter on the side panels of the rear seats.
- 7 12-Channel located on inner left-hand side of trunk compartment.

4



## MTC+ “Controls” Screen

Touch the “Controls” softkey on the lower part of the MTC+ display you to turn off the MTC+ screen and to access the “Settings” menu.



### NOTE:

- For further details refer also to the “Maserati Touch Control Plus (MTC+)” guide.
- All settings must be edited with the key in the ignition switch in **MAR (ON)** position.
- **Screen Off**  
This feature allows you to switch off the MTC+ screen backlight if it becomes annoying when driving. See “Infotainment System” in this section for further details.
- **Settings**  
This menu allows you to access the

customer programmable features (see “MTC+ Settings” in this section).

## MTC+ Settings

### Customer Programmable Features

The MTC+ System uses a combination of keys able to access and change the customer programmable features. Access “Settings” menu touching “Controls” softkey on the lower part of the MTC+ display, centrally of the dashboard, or using manual controls on central console (refer to “Infotainment System” in this section). Turn the tune/scroll knob to scroll through menus and change settings on MTC+ display, press the enter upper button to confirm the selection.





## NOTE:

- For further details refer to the “Maserati Touch Control Plus (MTC+)” guide.
- All settings must be edited with key in the ignition switch in **MAR (ON)** position.

To display the programmable features menu on MTC+ touch the “Settings” softkey on “Controls” screen.



In this mode the MTC+ System allows you to access the following programmable features (some of them are optional and may not be available on your vehicle): Display, Units, Voice Commands, Clock, Safety & Driving Assistant, Lights, Doors & Locks, Audio, Phone/Bluetooth, SiriusXM Setup, Restore Settings, Clear Personal Data and System Information.

## NOTE:

- Only one touchscreen area/softkey may be selected at a time.
- Menu navigation indications refer to the use of softkeys on MTC+ display: the same operations can be performed using the manual controls on central console.

To make a selection, and enter the desired feature, touch the corresponding softkey on the menu (the picture shown is “Clock”).

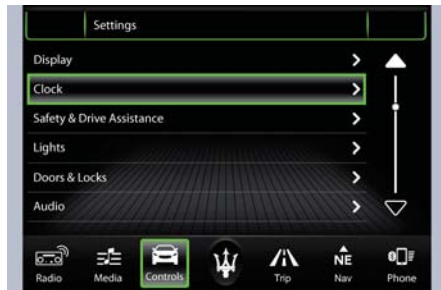

To scroll through the features, move the cursor up or down, or touch the arrow ▼ or ▲. Once the desired mode is entered, press and release the touchscreen area of the setting that you wish to modify. The new setting will be highlighted with one or more boxes to indicate status or possible variants of the feature status. A check

mark in a box indicates the current status of the feature. Touch the check mark to cancel, or the empty box to insert the check mark, and change the status of the feature.



Once the procedure is completed (for example, Display mode) touch the ← back arrow softkey to return to the previous menu or touch the upper right “X” softkey, to close the settings screen. Touching the ▲ or ▼ softkeys and the cursor on the right side of the screen will allow you to scroll up or down through the available settings.



## Display

After pressing the "Display" softkey the following mode settings will be available.

- **Display Mode**

When in this display you can select one of the auto display settings. To change mode status, checkmark "Night", "Day" or "Auto".

- **Display Brightness Night**

When in this display, you can select the brightness with the headlights on. Adjust the brightness from level 0 to 10 with the "+" and "-" setting softkeys or by selecting any point on the scale between the "+" and "-" softkeys.

- **Display Brightness Day**

When in this display, you can select the brightness with the headlights off. Adjust the brightness as previously explained for "Night" setting.

- **Set Language**

When in this display, you can select one language for all display descriptions, including the trip features and the navigation system. The available languages are specific to the target markets.

- **Keyboard**

Selecting this feature, the display shows the alphanumeric keyboard to enter address, stations, etc..

- **Touch screen Beep**

When in this display, you can turn on or shut off the sound activated

by pressure of a touch screen softkey.

- **Controls Screen Time-Out**

When this mode is selected, the "Controls" screen will remain displayed for 5 seconds. If this mode is not selected, the screen will remain displayed until closed manually.

- **Nav Next Turn Pop-ups in Cluster**

By selecting this feature, the next turn direction will appear on the instrument cluster along a programmed route until the desired destination is reached (see picture).



- **Phone Pop-ups Displayed In Cluster**

When this mode is selected, the display will show the pop-ups messages with the number and state of the call in progress.



## • AutoShow Smartphone Display Upon Connection

This feature allows to use the MTC+ display as a projection device connected via USB port in order to browse the Apple CarPlay and Android Auto apps. By setting this feature, automatic switch from native screen to projection device will happen every time you connect your smartphone. For further details refer to the “Maserati Touch Control Plus (MTC+)” guide.

## Units

After pressing the “Units” and then “Custom” softkey on the touch screen you may select between Metric and Imperial units of measure. Each unit of measure can be independently displayed in the TFT Display and in the navigation system. The following selectable units of measure are listed below:

- **Speed unit:**  
select from: “mph” or “km/h”.
- **Consumption unit:**  
select from: “mpg US”, “mpg UK”, “l/100km” and “km/l”.
- **Distance unit:**  
select from: “mi or km”.

- **Pressure unit:**  
select from: “PSI” or “BAR”.
- **Temperature unit:**  
select from: “°F” or “°C”.

## Voice Commands

After pressing “Voice” softkey the following modes will be available.

- **Voice Response Length**  
When in this display, you can change the voice response length settings. To change the voice response length, touch the “Brief” or “Detailed” softkey.
- **Show Command List**  
When this feature is selected, it is possible to select options during a voice control session. Options for available controls are: “Always”, “w/Help” or “Never”.

## Clock

Time is always visible on the dashboard analog clock (see “Analog Clock” in this section) and in digital format on the instrument cluster and on the MTC+ display.



With this feature it is possible to view and set the following modes.

- **Sync with GPS Time**  
Time is normally automatically synchronized with the radio signal. It is also possible to set automatic synchronization mode using GPS signal instead.



### • Set Time Hours

With “Sync with GPS Time” feature unchecked and this mode selected, you can set the hours manually from 1 to 24. To select, touch the “+” or “-” softkeys to adjust the hours.

### • Set Time Minutes

With “Sync with GPS Time” feature unchecked and this mode selected, you can set the minutes manually from 0 to 59. To select, touch the “+” or “-” softkeys as done for the hours.

### • Time Format

When in this mode, you can select the time format display. To change the current setting, touch and release the “12 Hrs” or “24 Hrs” softkey.

### • Show Time In Status Bar

This feature will allow you to turn on or shut off the digital clock in the status bar.

### • Set Date in Cluster

When in this mode, you can set the date manually on the instrument cluster display. Tick the soft-key to enable the feature and enter the setting page. Touch than the “+” or “-” soft-keys to set the day, the month and the year”.



## Safety & Driving Assistant

Touch this softkey to set the following modes.

### • Stop & Go Parking Sensors

This feature allows you to disable

the parking sensors signal under special traffic conditions.

See “Park Assist” in section “Before Starting” for further information.

### • ParkView Camera with Dynamic Guidelines

When this feature is selected, by moving the transmission lever in R (Reverse) position, the rearview image with dynamic guidelines will appear on MTC+ display.

The feature can be set to “On” or “Off”.

### • ParkView Camera Off Delay

By selecting this feature, when the transmission lever is moved out of R (Reverse), the rear view image with dynamic guidelines will be displayed for up to 10 seconds after shifting unless the forward vehicle speed exceeds 8 mph (12 km/h), or the transmission is shifted into P (Park) or the key in the ignition switch is turned in **STOP (OFF)** position.

The feature can be set to “On” or “Off”.

### • Instrument Panel Buzzer Volume

This feature allows adjusting the volume of the acoustic signal that accompanies some instrument panel warnings (EPB overheating, seat





and rearview mirror position storage).

The volume can be set to 7 levels identified by numbers from "1" to "7" by pressing the "+" or "-" softkey.

### • Light Sensor

This feature allows to adjust the sensitivity of the twilight sensor for turning on the lights.

The feature can be set to 3 levels: "Low", "Medium" (default setting) and "High".



### • Speed Limit

This feature allows to set a speed limit and activate an alarm signal which will sound when the

maximum speed limit set is exceeded.

Checkmarked the softkey to enable the feature.

Press then the "+" or "-" softkey to increase or decrease the speed limit. Each touch increases/decreases the value by 5 units.

## Lights

Press the "Lights" softkey to set the following modes.

- **Daytime Lights (DRL, for versions/markets where provided)**  
If activated, this feature allows the automatic switching on of the DRL upon switching off of the position lights and vice versa. When the position lights switch on, the DRL switch off.  
See "Lights" in section "Understanding the Vehicle" for further information.

## Doors & Locks

Press the "Doors & Locks" softkey to set the following modes.

- **Auto Door Locks (Autoclose)**  
When this feature is selected, all doors will automatically lock when

the vehicle is in motion. The feature can be set to "On" or "Off".





### • Independent Trunk Lid Unlocking

When this feature is selected and checkmarked, only the trunk compartment lid remains unlocked and can be opened by pressing the button between the license plate lights.

When there is not checkmark, the trunk lid unlocking follows the logic of the doors.

### • Key Fob Unlocks

By selecting this feature you may set up only the driver's door or all doors mode will unlock on the first press of the  button on the radio control case (key fob). When "Driver Door" is selected, you must press the key fob  button twice to unlock also the passenger's door. When





unlocking "All Doors" by first press selection mode, all doors will unlock on the first press of the key fob button.

## Audio

This feature enables to view and set the available audio modes.

- **Balance/Fade**

Use this screen to adjust the balance and fade settings. Touch and drag the speaker icon, use the arrows to adjust, or tap the "C" icon to readjust to the center.



- **Equalizer**

Use this screen to adjust the "Bass", "Mid" and "Treble" settings. Adjust the settings with the "+" and "-" setting softkeys or scroll and touch the slider in any point on the scale between the "+" and "-" softkeys.



- **Speed Adjusted Volume**

This feature increases or decreases volume combined to vehicle speed. To change the speed adjusted volume touch the "Off", "1", "2" or "3" softkey.



- **Auto Play**

When a portable device is connected to MTC+ system, it plays automatically the songs if this feature is set to "On".



## Phone/Bluetooth®

Press this softkey to select and connect phones and audio sources.

- **Paired Phones and Audio Devices**

By selecting this feature you will be notified which audio source are combined to the Phone/Bluetooth® system.



For each option, you can also add a device and change the PIN code of the device you wish to connect. For



further information, see the MTC+ guide.

### NOTE:

On the Maserati website, at [www.maserati.com](http://www.maserati.com), or through the Authorized Maserati Dealer you may consult the list of telephones that are compatible with the MTC+, and their level of compatibility.

### • Do Not Disturb

Settings available for this feature:

#### • Auto Reply

To change the mode status, touch the "Text", "Call" or "Both" softkey.

#### • Auto Reply Message

To change the mode status, touch the "Custom" or "Default" softkey.

#### • Customize Auto Reply Message

This feature allows you to customize the "Auto Reply Message". Text messages are limited to 160 characters (key pad is not available while vehicle is in motion).



### SiriusXM Setup

After pressing the "SiriusXM Setup" softkey the following settings will be available.

### • Tune Start

"Tune Start" begins playing the current song from the beginning when you tune to a music channel, so you can enjoy the complete song. "Tune Start" works in the background, so you will not even realize it's on, except that you will miss the experience of joining your favorite song with only a few seconds left to play.

### • Channel Skip

SiriusXM can be programmed to designate a group of channels that are the most desirable to listen to or to exclude undesirable channels while scanning. To make your

selection, touch the Channel Skip softkey, select the channels you would like to skip followed by pressing the arrow ◀ softkey.

### • Subscription Information

SiriusXM Satellite Radio requires a user-paid subscription to access these stations.

It will be necessary to access the information on the Subscription Information Screen in order to subscribe.

Touch the "Subscription Information" soft key to access your receiver ID number. Write down the SiriusXM ID numbers for your radio. To activate SiriusXM service, either call the number listed on the screen or visit SiriusXM online at [www.siriusxm.com/subscriptions](http://www.siriusxm.com/subscriptions) or call the number listed.





## Restore Settings

When this feature is selected, it will reset the “Display”, “Clock”, “Audio”, and “SiriusXM Setup” to their default settings.

Run this feature and a pop-up will appear asking user to confirm default settings resetting. Select “Yes” to restore, or “Cancel” to exit. Once the settings are restored, a pop-up appears confirming that settings have been reset to default.

## Clear Personal Data

When this feature is selected, it will remove personal data concerning settings and/or options that have been modified compared to factory settings and will also remove from system memory Bluetooth® devices and presets.

To remove personal information, select this feature and a pop-up will appear asking confirmation to delete all personal data. Select “OK” to clear, or “Cancel” to exit. Once the data have been cleared, a pop up appears confirming that personal data have been cleared.

## System Information

When this feature is selected, the display shows an information screen with the software version installed on MTC+.

## Glove Compartments

The glove compartments may be used to store devices, small items or documents.



### WARNING!

- Do not operate the vehicle with the lid of glove compartment in the open position.
- To help ensure passenger safety, the glove compartment must always remain closed while driving.
- Store objects or devices in glove compartment to ensure they will not move during the trip and prevent them from hitting any person on board.



### CAUTION!

Do not place objects weighing over 22 lb (10 kg) in the glove compartment.

## Glove Box on Passenger Side

To open the glove box on the passenger side of the dashboard, pull the handle as shown in the picture.



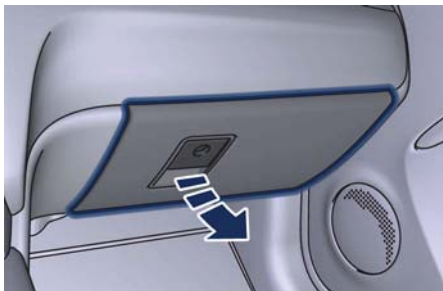

The compartment is illuminated by a courtesy light when open (the light will automatically switch off when the compartment is closed).

compartment it is possible to house a half-liter bottle or a smartphone.

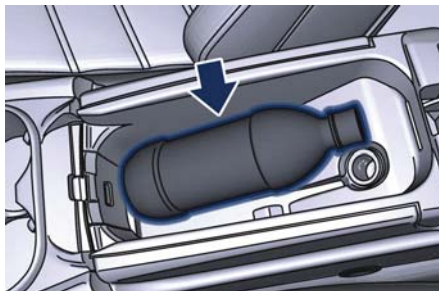

**NOTE:**

*To prevent to damage the smartphone put it into its housing shown in figure below (see also the label applied under the cover with armrest function).*

### Glove Compartment inside Central Console

To access this compartment, lift the cover with armrest function pressing the inside handle.



In addition to the multimedia ports and the power outlet, in this

## Analog Clock

To adjust the analog clock located on the center of the dashboard above the MTC+ display, use the MTC+ System (see "MTC+ Settings" in this section).



The time can be visualized also on the MTC+ status bar and on the instrument cluster display (see "MTC+ Settings" in this section).

Clock lighting is aligned with the backlighting status of the MTC+ display (refer to "MTC + Settings" in section "Dashboard Instruments and Controls").



## Air Conditioning Controls

The vehicle is equipped with an automatic dual-zone air conditioning system that allows to adjust separately the air temperature and the airflow distribution in the left and in the right zone of the passenger compartment, according to the requests of the driver and the front passenger.

A humidity sensor, positioned on the inner surface of the windshield, over the rearview mirror, allows the A/C system to prevent/ eliminate fogging of the windshield and side windows.

The best efficacy in preventing fogging is obtained by selecting the AUTO function, described later.

A dual zone solar sensor, positioned on the center of the dashboard upper surface, helps to achieve the best comfort in presence of solar radiation.



### CAUTION!

To ensure proper functioning of the solar sensor, do not apply adhesive parking stickers, etc. in the checking area between the sensor and the windshield. Therefore, keep the windshield and the sensor clean to

prevent accumulation of dust or other impurities.



### Climate Controls

- 1 Left-hand side temperature setting.
- 2 Right-hand side temperature setting.
- 3 Fan speed adjustment control.
- 4 Air distribution selectable in 7 different modes to the left-hand side.
- 5 Air distribution to the right-hand side, selectable in 7 different modes.
- 6 Air conditioning system compressor activation/deactivation button.
- 7 Single/dual zone selection button.
- 8 Defrosting/defogging activation/deactivation button (MAX DEF function).
- 9 Air recirculation activation/deactivation button.
- 10 Automatic/manual system control button.
- 11 Heated rear window activation/deactivation button.
- 12 Opening/closing of air duct leading to rear vents.
- 13 Air conditioning display, showing the following information:
  - left- and right-hand side temperature;
  - fan speed, represented by a bar-graph diagram;
  - AUTO/FULL AUTO functionality, for each side;
  - left- and right-hand side airflow distribution.

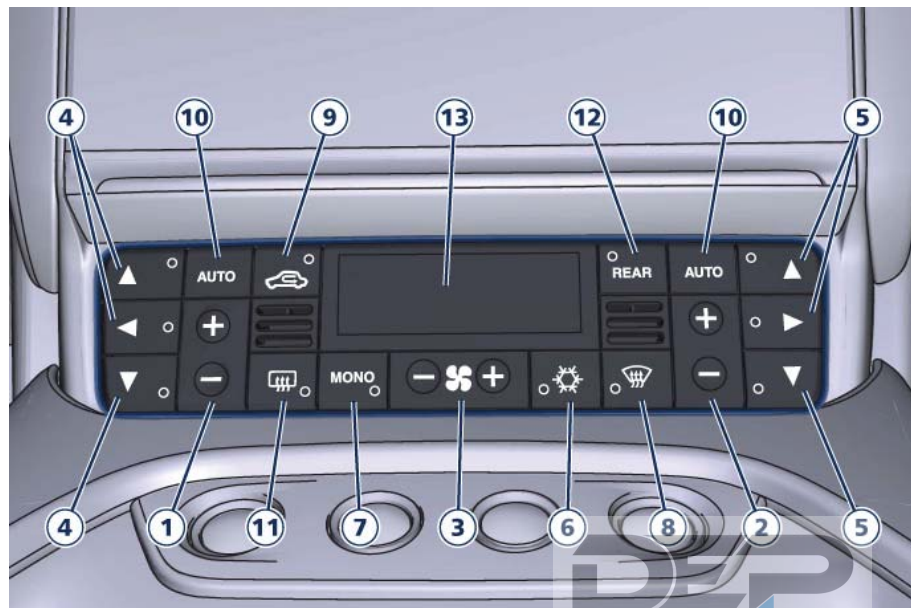

When the system is in OFF condition, no indications appear on the display.

### Climate Control Functions

Through the panel incorporated in the center console the user can control the following parameters/functions:

- left-hand/right-hand vent air temperature;

4







- left-hand/right-hand vent air distribution;
- fan speed (stepless change);
- compressor activation;
- air recirculation.

All the functions listed above can be modified manually, i.e. the user can select one or more of these functions as desired, using the control panel. The manual selections always have priority over the automatic ones and are memorized until the user chooses the automatic control again. When a function has been set manually, the other automatic functions will not be affected. The following parameters/functions can be set/modified manually:

- left-hand/right-hand side air temperature;
- fan speed;
- air distribution on 7 positions (left-hand/ right-hand);
- compressor activation;
- single/dual-zone distribution priority;
- defrosting/defogging function (MAX DEF);
- air recirculation;
- automatic/manual control of the system;

- heated rear window;
- system deactivation;
- opening/closing of air duct leading to rear vents.

### Activation

The system can be started up in a number of ways. It is however advisable to begin by pressing one of the buttons **10** AUTO and using the buttons **1** or **2** to set the desired temperature. This way the system will operate in fully automatic mode so that the temperatures set will be reached as quickly as possible. In this condition, manual operations will activate the following functions:

- MONO button **7** adjusts the air temperature and distribution in the two heating/air conditioning areas;
- REAR button **12** enables/disables the air flow to the rear vents;
- button **6** turns off the compressor;
- button **8** activates/deactivates the defrosting/defogging function on the front side windows;
- button **11** activates/deactivates the heated rear window.



By altering any other parameter manually, such as the air temperature or distribution, these features switch from the fully automatic control mode (FULL AUTO) to manual mode (AUTO). On starting the vehicle after stopping, the various parameters are controlled manually or automatically, depending on the options selected by the user before turning the engine off. Therefore all the manual operations performed before the vehicle is turned off are stored and maintained for the next start up. This also applies to the OFF function described below.

### System Deactivation (OFF Function)

Press button **3** at the symbol “-” to reset the fan speed: in this condition the A/C system is disabled (OFF). It is possible to manage both recirculation





and heated rear window even when the system is off.

To activate the A/C system again, select one of the following options:

- Fan speed “+” (button 3);
- A/C compressor (button 6);
- MAX DEF (button 8);
- AUTO (button 10).



### Recirculation

It is enabled by pressing button  and allows using only the air of the passenger compartment. The recirculation can operate in the following modes:

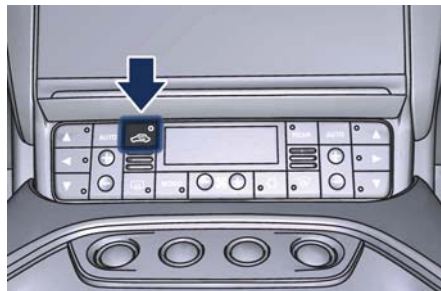

### Automatic Mode

When the compressor is deactivated or outside temperatures are below 37 °F (3 °C), the automatic recirculation function is deactivated automatically. After prolonged operation (over 15 minutes in a row), the system deactivates the recirculation function automatically for safety reasons, allowing the exchange of air once again.

### Forced Closed Recirculation

In this operating mode, the illumination of the amber LED indicates that the recirculation vent is closed.

### Forced Open Recirculation

In this operating mode, the LED turned off indicates that the outside air intake is open.

### AUTO Mode

When this button is pressed (one button per zone), automatic mode will control the following functions once again:

- air distribution (for the side concerned);
- fan speed;
- compressor operation (illumination of the ECON LED);
- air recirculation.

### REAR Mode

Press the button REAR 12 (relative LED illuminated) to open/close the air flow to the rear vents.

This function is active in both “MONO” and “DUAL-ZONE” modes.

### System Initialization Procedure

Every time the battery is reconnected, when the vehicle is started the system must be initialized by activating the compressor. The display automatically shows the passenger compartment temperatures set to 72 °F (22 °C). The system is configured as follows:

- AUTO (automatic operation, the words “FULL AUTO” appear on the display);



- compressor enabled (the LED on the button is illuminated);
- defrosting/defogging function (MAX DEF) deactivated (the LED on the button is off);
- heated rear window deactivated (the LED on the button is off);
- open recirculation (the LED on the button is off);
- air ventilation and distribution are set by the system;
- REAR disabled (the LED on the button is off), the air flows to the rear vents.

## A/C Filter

The climate control system filters outside air containing dust, pollen and some odors. Strong odors cannot be totally removed by A/C filter at the entrance of the air climate system. See “Maintenance Procedures” in section “Maintenance and Care” for filter replacement instructions.

## Phone and Voice Controls on Steering Wheel

The buttons on the left side of the steering wheel activate/deactivate the phone mode and the voice controls functions.

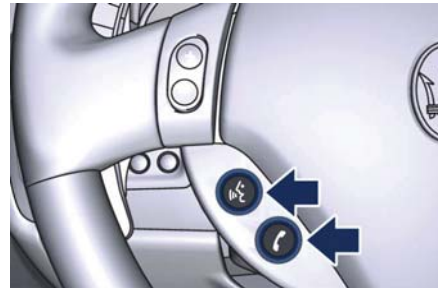

These functions are only available when one or more Bluetooth® compatible mobile phones are paired with the MTC+ System connection: to pair a phone and to learn all available functions refer to the MTC+ guide.

### NOTE:

On the Maserati website, at [www.maserati.com](http://www.maserati.com), or through the **Authorized Maserati Dealer** you may consult the list of telephones that are compatible with the MTC+, and their level of compatibility.



The voice command communication system is fully integrated with the vehicle's audio system.

The voice command volume can be adjusted from the upper knob on the central console (see “Infotainment System” in this section or from the steering wheel audio controls (see “Audio Controls” in this section). The system will automatically mute the radio when using the phone mode.

When activating the phone mode using voice commands with speakerphone, you should talk quietly in a normal conversational tone by keeping the driving position and turning to the microphone of the voice command system located in the front dome console.

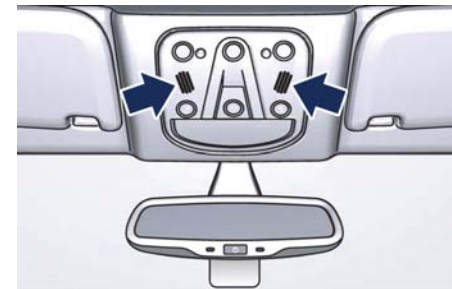

The ability of the system voice control to recognize the user's voice



commands can be invalidated when speaking too quickly or too loudly.



### WARNING!

Any voice-controlled system should be used only in safe driving conditions following all applicable regulations. Full attention should be kept on driving. Failure to do so may result in a collision causing serious injury or death.

4

## Phone Mode

By using the Phone button  on the steering wheel it is possible to: activate the phone mode, start a call, show recent incoming and outgoing calls, show contacts list, etc.

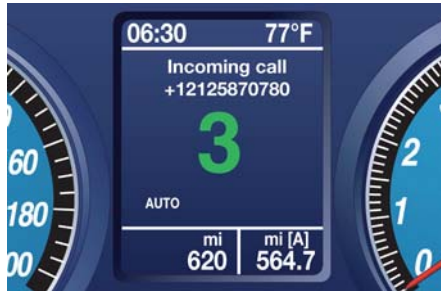

All these functions can also be reached by using the touchscreen commands on the MTC+ display in "Phone" mode. When pressing the button  an audible sound will invite you to impart a command. Information on incoming call is indicated in a pop-up on instrument panel display main area if this feature is checkmarked on MTC+ (see "MTC+ Settings" in this section). Said information will stay displayed until a control is executed (e.g.: answer, reject, etc.) for the incoming call. The screen will only display the phone number or name of caller (if available) as long as this complies with system specifications in terms of font and number of characters.

## Voice Commands

By using voice commands, after pressing the  button on the steering wheel, it is possible to control the AM and FM radio, the SiriusXM Satellite Radio (if available) and all devices connected and managed by the "Media" mode (i.e SD card, USB/iPod player).

When pressing the button  an acoustic signal will invite to give a voice command.

### NOTE:

For further details refer to the *Maserati Touch Control Plus (MTC+) guide*.

## Siri Smart Personal Assistant

When a compatible iPhone or iPad that supports Siri voice recognition is paired to the vehicle, the  button also activates the Siri Smart Personal Assistant.

Siri requires mobile internet access and its functionality might change depending on the geographical area. Through simple voice commands, without taking your eyes off the road, it may be possible to send messages, make phone calls, create notes and reminders, etc.





## 5 – Driving

- Normal Starting of the Engine . . . . . 158
- Automatic Transmission . . . . . 160
- Onboard Computer (Trip) . . . . . 167
- Drive Mode . . . . . 169
- Parking Brake . . . . . 174
- Parking . . . . . 176
- Brake and Stability Control System . . . . . 177
- Using the Brakes . . . . . 181
- Use of the Engine . . . . . 183
- Cruise Control (CC) . . . . . 185
- Tires - General Information . . . . . 187
- Tire Pressure Monitoring System - TPMS . . . . . 194
- Fuel Requirements . . . . . 199
- Refueling . . . . . 202
- Driving Conditions . . . . . 204
- Pollution Control Devices . . . . . 207





## Normal Starting of the Engine



### WARNING!

It is dangerous to run the engine in an enclosed area. The engine consumes oxygen and discharges carbon dioxide, carbon monoxide and other toxic gases in the atmosphere.



### WARNING!

California Proposition 65 Operating, servicing and maintaining a passenger vehicle or off-road vehicle can expose you to chemicals including such as, engine exhaust, carbon monoxide, phthalates and lead, that which are known to the State of California to cause cancer and birth defects or other reproductive harm. To minimize exposure, avoid breathing exhaust, do not idle the engine except as necessary, service your vehicle in a well-ventilated area and wear gloves or wash your hands frequently when servicing your vehicle. For more information go to:

[www.P65Warnings.ca.gov/passenger-vehicle](http://www.P65Warnings.ca.gov/passenger-vehicle)

When you open a door to get into the car, the instrument cluster turns on. The TFT displays the complete odometer, time, outside temperature and the  open doors indicator.

Before starting the engine, close the doors, adjust your seat, the inside and outside mirrors, fasten your seat belt and instruct all other occupants to buckle their seat belts.

Make sure that the Electric Parking Brake (EPB) is applied.

The shift lever must be in P (Park) or N (Neutral) position before you can start the engine. Apply the brakes before shifting into any driving gear (see “Automatic Transmission” in this section).



### CAUTION!

- Before starting the engine, switch off the electrical devices with a high power consumption (air-conditioning and heating system, heated rear window, headlights, etc.).
- Do not start the engine if the fuel level in the tank is low.

Press the brake pedal and turn the key in the ignition switch to **MAR (ON)** position.

Instrument cluster displays the initial sequence with warning light and analog instruments test routine. Turn the key into **AVV** position and release it when the engine starts. The key will return to **MAR (ON)** position automatically.

Do not hold the key in **AVV** position for a long time.

If the engine fails to start, the starter will disengage automatically after 10 seconds. If you wish to stop the cranking of the engine prior to starting it, turn the key to **STOP (OFF)** position.

If the engine does not start, turn the key to **STOP (OFF)** position and wait for the gear display to go off. Then repeat the entire procedure.

### NOTE:

*Normal starting of either a cold or a warm engine is obtained without pumping or pressing the accelerator pedal.*





## Engine Start Failure



### CAUTION!

- Do not attempt to push or tow your vehicle to get it started. Vehicles equipped with an automatic transmission cannot be started this way.
- If the vehicle battery is dead, booster cables may be used to obtain a start from a booster battery or the battery in another vehicle. This type of start can be dangerous if done improperly. See "Auxiliary Jump Start Procedure" in section "In an Emergency" for further information.

### Starting by cold engine

Start-off slowly, avoiding sudden acceleration and rev the engine up at low medium speeds. High-performance driving should be avoided until the engine temperature reaches 149-158°F (65-70°C).

### Engine Turn-Off

- Place the shift lever in P (Park) (see "Automatic Transmission" in this section).
- With the engine at idle, turn the key in the ignition switch to **STOP (OFF)**

position. A burst on the accelerator pedal before turning off the engine has no purpose and increases fuel consumption.



### WARNING!

**Never leave a vehicle out of the P (Park) position, as it could move.**

The key can only be removed from the ignition switch when the transmission is in P (Park) position and within 30 seconds after turning the key to **STOP (OFF)** position. If you do not remove the key within 30 seconds, you will need to turn it back to **MAR (ON)** and then to **STOP (OFF)** position to have a further 30 seconds within which to remove the key from the ignition switch.

In the event that the key unlocking system fails or if it is not possible to shift the transmission to P (Park) position, to remove the key you must turn it to **STOP (OFF)** position, then remove the cap shown in picture using a pen or sufficiently pointed tool. Then press the button just uncovered and at the same time extract the key from the ignition switch. Once the key has been removed, refit the removed cap.

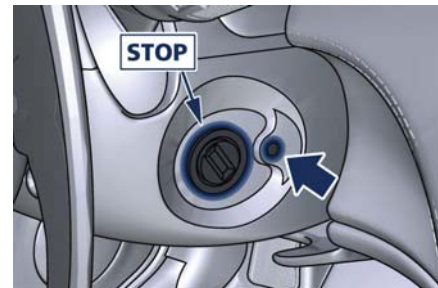



## Automatic Transmission

The electronic shift lever replaces the conventional mechanical lever and has no mechanical connection to the transmission. The transmission is operated by electrical actuators on the hydraulic system and all commands to the control system are transmitted by the CAN network.

The automatic transmission has six forward gear ratios and one reverse gear. The gears can also be engaged manually once you have shifted the transmission shift lever to the sector provided.



### CAUTION!

In order to properly use the automatic transmission, it is essential that you read through the whole chapter, so that you can understand right from the start what the correct and permitted operations are.

Damage to the transmission may occur if the following precautions are not observed:

- Shift into P (Park) only after the vehicle has come to a complete stop. This is the default position of the lever and should be used every time

- the key in the ignition switch is turned to **STOP (OFF)** position.
- Shift into or out of R (Reverse) only after the vehicle has come to a complete stop and the engine is at idle speed.
- Do not shift between P (Park), R (Reverse), N (Neutral) or D (Drive) when the engine is above idle speed.
- To effect any change from vehicle stop to R (Reverse), D (Drive), 1<sup>st</sup> or 2<sup>nd</sup> gear, it is necessary to keep the brake pedal fully depressed.



### WARNING!

- It is dangerous to move the shift lever out of P (Park) or N (Neutral) if the engine speed is higher than idle speed. Only shift into gear when the engine is idling normally and when your foot is firmly pressing on the brake pedal.
- As with all vehicles, you should never exit a vehicle while the engine is running. Before exiting a vehicle, always apply the electronic parking brake, shift the transmission into P (Park), and turn the engine off.
- When leaving the vehicle, always remove the key from the ignition

**switch and lock your vehicle.**

- Do not leave the key in or near the vehicle.

The transmission system is equipped with "Shift-Lock" and "Key-Lock" safety functions.

### Shift-Lock

This safety function allows you to shift from P (Park) to another position only if the brake pedal is depressed. This prevents the vehicle from involuntarily jumping forward or backward.

### Key-Lock

This function allows you to remove the key from the ignition switch only when the transmission shift lever is in P (Park) position and within a maximum time of 30 seconds. When this time has elapsed, the key can no longer be removed.

## Automatic Transmission Lever

Automatic transmission is operated by a lever with unlock button to engage R (Reverse) and P (Park) located on the central console.

By using the transmission shift lever it is possible to select following positions, indicated on the gear display at the side of the transmission shift





lever. The selected position will illuminate in white light.

- P (Park);
- R (Reverse);
- N (Neutral);
- D (Drive) automatic forward speed (6 ranges);
- -/+ to downshift or upshift in sequential manual mode (see "Drive Mode" in this section).



Transmission status (example shown in picture: D (Drive)) is visible also on the central part of the instrument cluster display.

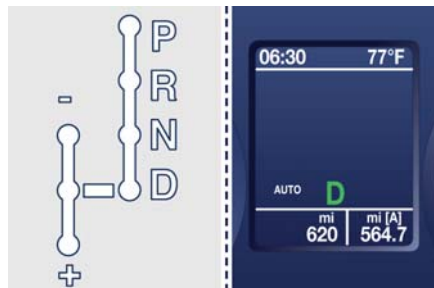

### Starting the Engine

The engine can only be started when the transmission shift lever is in P (Park) or N (Neutral) position.



### WARNING!

**Always start the engine holding the brake pedal depressed.**

### NOTE:

*After starting the engine and setting off, do not depress the accelerator pedal before and while shifting the transmission shift lever. This is particularly important when the engine is cold.*

### Driving the Vehicle

After starting the vehicle, with the engine idling and the brake pedal depressed ("Shift-Lock" safety), move

the transmission shift lever to D (Drive) position or in the position for sequential manual shifting "+" or "-". Release the brake pedal and gradually depress the accelerator pedal.

### NOTE:

*The transmission shift lever can be moved to P (Park) position only when the key in the ignition switch is in the **MAR (ON)** position and both the unlock button on the transmission lever and the brake pedal are pushed (Shift-lock safety).*

For safety reasons, the transmission shift lever can be moved from D (Drive) position to R (Reverse) and P (Park) position only when unlock button on the transmission shift lever is pushed. It is also advisable to depress the brake pedal during this maneuver.

### NOTE:

- Do not run the engine at top RPM until it has reached stable operating temperature.
- In the case of performance starting, check that the Electric Parking Brake (EPB) is disengaged.
- For more comfortable starting (with the transmission lever in D (Drive), R

**(Continued)**



*(Continued)*

*(Reverse) or MANUAL and the Electric Parking Brake (EPB) engaged), push the brake pedal, manually deactivate the EPB system by pulling up the lever on the central console, and push the accelerator pedal.*



### Hill Holder Strategy

The Hill Holder strategy helps the driver when starting-off on uphill slopes. It activates only following a vehicle stop when the brake pedal is released, keeping the vehicle stationary for a moment, so as to allow the driver to move his foot from the brake to the accelerator pedal. This strategy is activated on slopes with a gradient of more than 15°.

### Stopping the Vehicle

Regardless of the position of the transmission lever, you must only depress the brake pedal to stop the vehicle.



#### WARNING!

- When the transmission shift lever is in D (Drive, R (Reverse) or MANUAL position, the engine idling and the vehicle on an even surface, if the brake pedal is not depressed, the vehicle can move.
- Gearshifting is always active and may be performed even when one or more doors, the trunk or the liftgate are open. Therefore, in these conditions, take great care to avoid moving the transmission shift lever and so accidentally engage gears.

The key can be removed from the ignition switch only when the transmission lever is in P (Park) position and within 30 seconds from turning the key to **STOP (OFF)** position. The letter "P" ("Key-Lock" safety) is displayed on the instrument cluster for this entire time. For further information see "Normal Starting of the Engine" in this section.

### Selecting AUTO or MANUAL Operating Mode

The transmission can be used both in fully automatic mode (position "D") and in sequential manual mode (positions "+" or "-").

To select the mode, shift the transmission shift lever to: "D": automatic gearshifting (AUTO); "+" or "-": sequential manual gearshifting (MANUAL).

The transmission shift lever can always be shifted from one position to the other, even when the vehicle is moving.

The transmission shift lever can continuously be shifted from D (Drive) to "+" or "-". If automatic gearshifting has been set, the word "AUTO" and the letter "D" will be shown on the instrument cluster display, while if sequential manual mode has been set, the word "MANUAL" and the gear engaged will be shown on the same display.

### Automatic Transmission Range

#### P (Park)

Use this position to park the vehicle. A transmission device will lock the driving wheels. The transmission can be shifted from P (Park) position only with the brake





pedal pressed. To move the shift lever from P (Park) position to any other position, the engine must be switched on. The engine can be regularly started in P (Park) range. Never attempt to use P (Park) while the vehicle is in motion.

When parking on a level surface, you may place the shift lever in the P (Park) position first, and then apply the electronic parking brake by pulling the trigger upward.



The Instrument cluster will display the related **P** light indicator that flashes until the maximum engagement force has been reached.

When parking on a hill, apply the parking brake before placing the shift lever in P (Park).

For enhanced security, turn the front wheels toward the kerb on a downhill

and away from the kerb on an uphill grade.



### WARNING!

- **Never use the P (Park) position as a substitute for the Electric Parking Brake (EPB). Always apply the parking brake fully when parked to prevent vehicle movement and possible injury or damage.**
- **Make sure the transmission is in P (Park) before leaving the vehicle.**



### CAUTION!

- **DO NOT** race the engine when shifting from P (Park) or N (Neutral) into another gear range, as this can damage the drivetrain.
- Shift the lever to P (Park) position only when the vehicle is stationary. Therefore, it is advisable to perform this maneuver with the brake pedal depressed.
- To prevent accidental engagement, the transmission shift lever can only be shifted from P (Park) to any other position when the unlock button on the transmission shift lever and the brake pedal are depressed.

- **Before getting out of the vehicle, check that the Electric Parking Brake (EPB) is engaged. Shift the transmission shift lever to P (Park) position even when you need to get out of the vehicle only for a few seconds, leaving the engine running.**

If you turn off the engine with the transmission shift lever in a position different from P (Park), an acoustic signal will sound for a few seconds and a message will be displayed indicating to shift the lever to P (Park) position.

When the driver's door is opened with the transmission shift lever in a position different from P (Park), an acoustic signal will sound for a few seconds and a message warning the driver that the transmission shift lever is not in P (Park) position will be displayed.

### R (Reverse)

This range is used to move the vehicle backward.

We recommend to shift into R (Reverse) only after the vehicle has come to a complete stop.

- **Vehicle halted:** switching between P (Park), R (Reverse) and D (Drive) requires pressing the unlock button



on the lever and brake pedal: N (Neutral) is reached only by pressing the unlock button on the lever.

- Vehicle moving: the driver can switch from R (Reverse) to N (Neutral), or vice versa, by pressing the unlock button on the shift lever.

When the transmission shift lever is in R (Reverse) position, the system emits an acoustic signal for a few seconds. You can also shift the transmission shift lever to R (Reverse) position when the vehicle is not completely stationary, however, this does not mean that reverse gear is actually engaged, since there is a limit speed above which the gear may not be engaged. When the speed goes below this limit, reverse gear is engaged.



### CAUTION!

To prevent accidental engagement, the transmission shift lever can only be moved from R (Reverse) to any other position when the unlock button is pressed. It is advisable to also depress the brake pedal when shifting to this position.

### N (Neutral)

This range should be used when you need to move the vehicle.

- Vehicle halted and engine started: switching from N (Neutral) to R (Reverse), P (Park) and/or D (Drive) requires brake pedal and unlock button pressed.
- Vehicle moving: switching from N (Neutral) to R (Reverse) and/or D (Drive) requires pressing the unlock button. Switching to R (Reverse) starting from N (Neutral) is only possible if the vehicle is moving backward, while switching to D (Drive) starting from N (Neutral) is only possible if the vehicle is moving forward.

Set the parking brake and shift the transmission into P (Park) if you must leave the vehicle.



### WARNING!

**Do not switch to N (Neutral) and/or never turn off the ignition to coast downhill. These are unsafe practices that limit driver's response to changing traffic or road conditions. It is possible to lose control of the vehicle and have a collision.**



### CAUTION!

**Towing the vehicle, coasting, or**

**driving for any other reason with the transmission in N (Neutral) can result in transmission damage. See "Towing a Disabled Vehicle" in section "In an Emergency" for further information.**

### D (Drive)

This range should be used for most city and highway driving. It provides the smoothest upshifts and downshifts and the best fuel economy. The transmission automatically shifts up and down through all gears. When this automatic forward gear is set, the letter "D" illuminates on the gear display and on the instrument cluster.

The D (Drive) position provides optimum driving characteristics under all normal operating conditions of the vehicle.

- Vehicle stationary: switching from D (Drive) to R (Reverse) and/or to P (Park) requires brake pedal and unlock button pressed: reaching N (Neutral) starting from D (Drive) is allowed by only pressing the unlock button on the shift lever.
- To enable special operations while the car is moving at a low speed, such as getting out of marsh or snow, it is possible to run quickly from D





(Drive) to R (Reverse), and vice versa, by pressing the unlock button on the transmission shift lever.

- Vehicle moving: switching to N (Neutral) from D (Drive) requires the unlock button on the shift lever pressed.
- From D (Drive) selected mode it is always possible to switch to MANUAL mode by shifting the transmission shift lever to "+" or "-" position.

The gears will be engaged in relation to the traveling speed, engine RPM, accelerator position, speed with which the pedal is depressed as well as the traveling conditions (uphill, downhill, curves).

The system has been programmed to classify all driving styles, in relation to the above mentioned parameters, and to associate them with the various vehicle settings, which go from extremely comfortable and economic driving to racing-style driving. The setting is selected automatically. At extremely cold temperatures (-23°F/-30°C or below), transmission may be affected by the low temperature of the engine and transmission. Normal operation will resume once the transmission

temperature has risen to a normal level.

## Transmission Strategy in Particular Driving Situations

### Downhill Driving

When the accelerator pedal is released, the transmission system detects that the vehicle is moving downhill and deactivates upshifting.

When the accelerator pedal is depressed, upshifting is reactivated but will be delayed by a few seconds. When the brake pedal is depressed, the transmission system downshifts to provide enhanced engine braking power.

In other words, when driving downhill, the transmission system operates so as to avoid upshifting and shifting gears when the accelerator pedal is released, and delays gear engagement by a few seconds when the accelerator pedal is depressed. In addition, when the brakes are applied, it engages the lowest gear in order to provide enhanced engine braking power.

This strategy is aimed at making downhill driving safer.



### Driving in Curves

The system detects when the vehicle goes into a curve through the lateral acceleration and the steering angle. Detecting this condition, it controls gearshifting using a specific mode. This mode is exited when the vehicle comes out of the curve, at a distance that varies depending on the vehicle speed.

### Fast-off Strategy

When the accelerator pedal is fully released, the system deactivates upshifting.

The next time the pedal is depressed, upshifting will be reactivated only after a few seconds.

Upshifting is also deactivated when the accelerator pedal is partially released; the system waits the time necessary to evaluate if the release action is completed.

### Hot-mode Situations

In the event that the engine oil or coolant temperature is too high or both, the transmission system reduces the maximum engine speed to 4000 rpm.

Therefore, upshifting will occur at this limit.

This strategy does not apply to downhill driving, so as to always have



the efficiency of engine braking together with the standard braking system.

### ESC System Operations

In order to prevent unstable driving conditions, the ESC system may request the transmission system to deactivate gearshifting. The system handles this request depending on the gear engaged and on the rpm, and decides whether to accept it or not.

### Driving with Cruise Control

With the Cruise Control function activated, the transmission system selects such settings as to provide enhanced comfort and fuel-economy.

### MC Start Strategy (for MC version only)

With the aim of optimizing standing starts for performance driving (only recommended for use in areas closed to traffic and in accordance with the Highway Code), the automatic transmission system is equipped with quick start strategy.

This strategy is activated when the following conditions occur simultaneously:

- AUTO and SPORT modes active;
- ESC mode off;
- brake pedal depressed.

In these conditions, the driver has the possibility to accelerate and, keeping the brake pedal depressed, keep the vehicle standing until reaching an engine speed between 2300 and 2500 rpm. Then, upon releasing the brake pedal, have the best standing start performance.



**WARNING!**  
This strategy must only be used on vehicles in areas closed to traffic, in accordance with the Highway Code and only by skilled drivers.

## Transmission Malfunction and Overheating Conditions

### Transmission Failure

Transmission function is electronically monitored to detect abnormal conditions. If a condition that could result in transmission damage is detected, Transmission Limp Home Mode will be activated. In this situation, the transmission may operate only in certain gears, or may not shift at all.



**CAUTION!**  
In these conditions, we recommended

that you stop the vehicle and turn off the engine for at least one minute. When restarting the engine, the self-diagnosis system may cancel the malfunction, which will in any case be recorded by the ECU.

A message and the  warning light in the instrument cluster will inform the driver about the transmission failure.

In failure conditions, the transmission shift lever can however be shifted to the (Reverse), N (Neutral) and D (Drive) position.

When shifting to D (Drive) position, only a few gears will be available, depending on the malfunction found.



**CAUTION!**  
If a transmission failure is signaled, take your vehicle to the nearest Authorized Maserati Dealer as soon as possible to have the problem corrected.

If the failure is signaled when the engine is started, it means that the transmission ECU detected a fault when the vehicle was last used. Also in this case, take your vehicle to the nearest Center of the Authorized







Maserati Dealer to have the transmission checked.





### WARNING!

**When the transmission is malfunctioning, drive very carefully considering that vehicle performance is reduced. In addition, the reverse gear safety lock may not be active: absolutely do not shift the lever to R (Reverse) when the vehicle is moving.**

### Transmission Oil Overtemperature

If the transmission oil temperature exceeds the operating limit, a message and the  red warning light illuminates on the instrument cluster.

In this case, slow down until temperature returns to normal level (the light will turn off).

If this is not sufficient, we recommend to stop the vehicle, shift the lever to position P (Park) or N (Neutral) and keep the engine idle until the  red temperature warning light turns off and the message disappears from the display. Resume driving without demanding high engine performance. If the  red warning light and the related message turns on again, it is advisable to stop the vehicle, turn off the engine and wait for the

engine/transmission assembly to fully cool down.

### Transmission Manual Release of P (Park) Position

See chapter "Transmission Manual Release of P (Park) Position" in section "In an Emergency".

## Onboard Computer (Trip)

The trip computer screen pages are accessible through the "Trip" softkey in the lower bar of the MTC+ main menus.

The selectable submenus are the following:

- Current Trip.
- Trip A.
- Trip B.
- Service.

### Current Trip

In this screen are displayed the range and the distance of destination for the current trip.

The unit for these submenus can be adjusted by the user from MTC+ setting menu (see "MTC+ Settings" in this section).







## Trip A - Trip B

In these screens are displayed the detailed data on "Trip A" and "Trip B". These data are also displayed in the Trip pages of the instrument cluster (see paragraph "TFT Display: Screen Pages" of chapter "Instrument Cluster" of this section).

For each of these submenus the screen will display the following data:

- Distance traveled.
- Average fuel consumption.
- Average speed.
- Duration.



The unit for these submenus can be adjusted by the user from MTC+ setting menu (see "MTC+ Settings" in this section).

In addition to these, there is also the "reset" softkey to reset the "Trip A" and/or the "Trip B".



## Service

When checking this item, the MTC+ displays mileage and days remaining before the execution of schedule maintenance service and warns when it is expired.

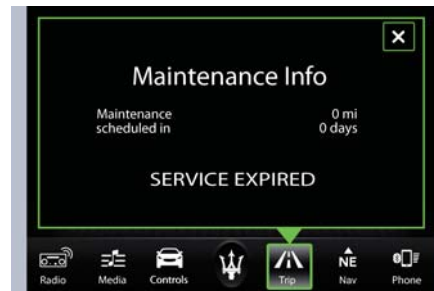
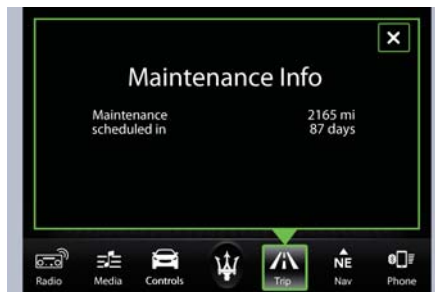

For further details, see "Scheduled Maintenance Service" in section "Maintenance and Care".



## Drive Mode

### Controls Preview

Drive modes can be set using the buttons on central console, below the A/C controls.



Buttons on the central console have following functions:

- **SPORT:** to activate/deactivate a sportier drive mode. In this mode, the vehicle has a faster throttle response and suspension/ESC sport calibration (not recommended on wet/slippery surfaces).
- **ICE (low-grip):** to activate/deactivate the drive mode to ensure increased control on slippery surfaces as well as higher energy efficiency.
- **ESC Off:** to exclude/reactivate the ESC system.

- **PARK OFF:** to deactivate/reactivate the automatic activation of the Electric Parking Brake (EPB).

The active mode (in the example: SPORT) is shown on the instrument cluster display.



The drive mode can be selected only with the key in the ignition switch in **MAR (ON)** position, even while driving. For each mode there are various vehicle settings, that are automatically set by the system in relation to the traveling speed, engine rpm, accelerator position, speed with which the pedal is depressed as well as the traveling conditions (uphill, downhill, curves).

### Use the Drive Mode Buttons

Drive modes can be set using the buttons on central console.

Buttons only have two statuses: OFF and ON. The OFF status (button released) is the standard function mode. The ON status is activated by pressing the button, the dedicated LED on the button will illuminate. Unlike the others, the  (ESC Off) button must be pressed for at least 2 seconds. The SPORT and ICE (low-grip) modes can be selected both when the transmission is set to automatic (AUTO) and to sequential manual (MANUAL) operation.

### NORMAL/SPORT Mode

SPORT mode is activated by pressing the button "SPORT" on the central console; the word "SPORT" will illuminate on the instrument cluster display.

To return to NORMAL mode from SPORT mode, press the button again. Whenever the engine is started, the system automatically activates NORMAL mode, even if SPORT mode was selected before the engine was last turned off.

NORMAL mode is intended specifically for comfortable and fuel-economy driving (low longitudinal and lateral acceleration); the gears are shifted with minimum rpm in lowest noise



(gears are shifted at low engine speeds).

In NORMAL mode, the system controlling suspension damping uses a shock absorber "softer" setting (see "Skyhook Suspension" in section "Understanding the Vehicle").

As SPORT mode has a lower priority than ICE (low-grip) mode, if this is already active when activating SPORT mode, the system will ignore the command.



### CAUTION!

- Vs NORMAL mode, SPORT mode is characterized by faster gearshifting, electronic suspension management (Skyhook), opening of by-pass exhaust valves (above 3000 rpm with the vehicle in motion).
- In addition to enhancing performance, opening of the exhaust also increases noise levels of the vehicle.

In SPORT mode, fast gearshifting however, always depends on the accelerator pedal travel and on the engine rpm, as in NORMAL mode. When in SPORT mode, the system controlling suspension damping uses a shock absorber "harder" setting (see

"Skyhook Suspension" in section "Understanding the Vehicle").

In MANUAL mode, DOWN-shifts with the accelerator pedal released, will have a braking effect approaching the skidding limit of the driving wheels on dry asphalt.

Under sports-style driving conditions with gearshifts at high engine rpm, double-clutching when up-shifting is performed automatically.



### WARNING!

**It is advisable not to use SPORT mode on roads with low or medium grip conditions (e.g. ice, snow, or wet roads) as the driving wheels could skid during gearshifts.**

**Therefore, excessive use of the vehicle in SPORT mode is advisable only on race tracks.**

If you use MANUAL and SPORT mode in combination for sports-style driving, when starting-off or shifting gears, you may perceive an initial slipping of the driving wheels even on dry roads.

### ICE (low-grip) Mode

This mode can be used on particularly slippery road surfaces (e.g., rain, snow, ice). To activate/deactivate this mode,

press button "ICE" on the central console. The word "ICE" will illuminate on the instrument cluster display.

In "low-grip" mode, the system uses 2nd instead of 1st gear; this means that 2nd gear will automatically be engaged (gearshift lever in D (Drive) position) in the event of standing starts in automatic mode; on the other hand, when in sequential manual mode (transmission lever in MANUAL "+"), moving the transmission lever from N (Neutral), or R (Reverse) or when the vehicle stops, 2nd gear will automatically be engaged.

When sequential manual mode is selected with 2nd gear engaged, a downshift request will be ignored. While driving, the system automatically switches to the upper gear if the engine reaches the preestablished speed rate (3000 rpm). ICE (low-grip) mode has priority over SPORT mode and assists the ESC system.



### WARNING!



**A downshift request from 6th to 5th gear will only be accepted if the engine speed rate in 5th gear is lower than 3000 rpm. As ICE (low-grip) mode**



can be activated at any time and the system limits the engine speed rate to 3000 rpm in all gears except for the 6th, unrequested gearshifts could take place.

In any case, it is advisable to deactivate SPORT mode before selecting ICE (low-grip) mode. When sequential manual gearshifting is active, regardless of the mode set (NORMAL / SPORT / ICE), the transmission will automatically upshift or downshift when reaching the minimum and maximum rpm. This is to prevent engine overrevving or underrevving.



#### (ESC Off) Mode

The ESC system is designed to automatically activate every time the engine is started and can be deactivated by pressing  (ESC Off) button on the central console for about 2 seconds. The  (ESC Off) amber warning light illuminates on the instrument cluster as well as on the display, where it is accompanied by a specific message.

The ESC (Electronic Stability Control) antiyawing system incorporates all of the vehicle control systems: ABS, EBD, ASR and MSR (see "Brake and Stability

Control System" in this section for further information).





The system is fitted with a unit that predicts the vehicle behavior with extreme accuracy. The system can detect when the driver is about to lose control of the vehicle. In this case, it can activate the brake calipers individually and engine control, in order to create a torque sufficient to resist the vehicle's yawing moment. Press  (ESC Off) button again to reactivate the system.

The  (ESC On) amber warning light on the instrument cluster flashes during all the operating phases. , the system is automatically disabled and cannot be re-activated. While driving, this condition is signaled by the  (ESC On) amber warning light, that illuminates both on the instrument cluster as well as on the multi-function display, where it is accompanied by the message "ESC unavailable go to dealer".

When the engine is started, the system malfunction is indicated by the illumination of the  (ESC On) amber warning light.



#### CAUTION!

- In the event of a fault, and with the ESC system disabled ( (ESC Off) button pressed), the vehicle behaves as if it were not equipped with this system: however, we recommend you contact the **Authorized Maserati Dealer** as soon as possible to have the system checked.
- If you have to tow the vehicle with 2 wheels raised, make sure the key in the ignition switch is in the **STOP (OFF)** position. Otherwise, with the ESC system active ( (ESC Off) button not pressed), the control unit will store a malfunction with consequent illumination of the  (ESC On) amber warning lights on the instrument cluster and on the display. Should this occur, contact the **Authorized Maserati Dealer** to have the system repaired.
- In low- and medium-grip conditions (e.g., rain, snow, ice, sand, etc.) it is advisable not to activate SPORT mode, even with the ESC system active ( (ESC Off) button not pressed).





## (Continued)

- Driving on parabolic curves will deactivate the system.

## PARK OFF Mode

To deactivate manual operation of the parking brake, with the engine on, press the "PARK OFF" button on the central console. The words "PARK OFF" appear on the instrument cluster display for 5 seconds, after which they remain displayed but in smaller size. To reactivate automatic operation, press the "PARK OFF" button once again, the words "PARK ON" appear on the display for 5 seconds.



## CAUTION!

- In certain conditions when the battery voltage is low, the electric parking brake system may temporarily be deactivated for safety reasons. Therefore, typically upon starting the engine, when the battery voltage drops, the message "PARK OFF" may temporarily be displayed on the instrument cluster, indicating that automatic operation is temporarily disabled.

- In the case of performance starting, check that the electric parking brake is disengaged.

For further information see "Parking Brake" in this section.

## Sequential Manual Operation (MANUAL)

In this mode, the transmission interacts with the driver in order to allow manual shift and ensure increased control of the vehicle. The current mode allows the gear system to optimize the engine brake action, remove undesired shifting into higher and lower gears and improve the overall performance of the vehicle. With automatic transmission selected (D (Drive) position), shift the transmission shift lever to position "+" or "-".

When this mode is selected, the symbol "+" or "-" illuminates on the gear display, based on the position of the transmission shift lever, and the gear engaged is shown on the instrument cluster display.



## WARNING!

**When sequential manual operation is selected, upshifting or downshifting must be performed manually.**

To engage the gears, shift the transmission shift lever to one of the following two positions:  
 "+" (UP) to engage a higher gear;  
 "-" (DOWN) to engage a lower gear.



## CAUTION!

- However, some conditions will remain automatically controlled, for example, when the engine is overrevving or underrevving, the system automatically engages a higher or lower gear.
- If you request a gearshift in conditions where the engine is overrevving or underrevving, the system will not accept the command.
- The ECU is programmed to control one gearshift at a time, therefore, fast and repeated actions will not necessarily result in a gearshift. A higher or lower gear is engaged only if the previous procedure requested has been completed.



When the system refuses to engage a gear, an acoustic signal will sound for a few seconds.

Sequential manual operation can only be selected from the D (Drive) position whatever the function (SPORT, NORMAL) active at the time of the request. The gear selected by the automatic transmission will remain engaged when the transmission shift lever is moved.

Shifting the lever back to D (Drive), automatic operation will instantly be resumed, and a gear will be engaged based on the driving style and mode selected.

In the event of a failure of the sequential manual gearshift system, the transmission ECU will select automatic operation.

### Gearshift Paddles Operation

In sequential manual operating mode (MANUAL), upshifting and downshifting can be controlled not only with the transmission shift lever but also with the two paddles positioned behind the steering wheel. "+" : (UP): upper gearshift paddle. "-" : (DOWN): lower gearshift paddle.



Also in automatic transmission mode, when the transmission lever is in position D (Drive), you can shift to a different gear by moving one of the paddles. This action will temporarily switch the system to sequential manual operation.

If you then keep to a constant driving style (low longitudinal and lateral acceleration), the gearbox automatically switches back to automatic operation.

### Gear Shift Indicator Light

In order to improve fuel economy, we recommend that you shift gears when the system prompts you to do so. This will help reduce fuel consumption without significantly affecting vehicle performance.

The arrow icon beside the displayed gear will light up to indicate the moment the gear change is required.

This indicator lights up just before reaching the required speed for gear change.



When the new gear is engaged, the indicator turns off. If the shift runs late or is not performed at all, the indicator remains lit for a few seconds then turns off. As soon as new conditions requiring further gear change occur, the indicator light will illuminate again.

### NOTE:

*The gearshift indicator will only work when the transmission is set to manual sequential operation (see paragraph "Sequential Manual Operation (MANUAL)" in this chapter).*





## Parking Brake

The vehicle is equipped with an electric automatic parking brake, also called EPB (Electric Parking Brake). It can be automatically engaged when the engine is turned off and it is disengaged when, with the engine running, the accelerator pedal is depressed.

When the parking brake is applied (with the key in the ignition switch in **STOP (OFF)** position), the

**PARK** indicator lights up on the rev. counter display and the related message is displayed on the instrument cluster for 5 seconds (see "Instrument Cluster" in section "Dashboard Instruments and Controls").



During engagement and disengagement procedures, the **PARK** indicator flashes until the

parking brake has reached its maximum activation force and is respectively fully released.

The parking brake is automatically applied when the engine is turned off and the vehicle is stationary. It can only be disengaged when the engine is restarted.

If the key has been removed from the ignition switch or is turned in **STOP (OFF)** position, it cannot be disengaged.

### Manual Engagement/Disengagement

The parking brake can also be manually engaged or disengaged when the engine is running and when the vehicle is moving or the key in the ignition switch is in **MAR (ON)** position, by pressing the brake pedal and raising the lever located next to the transmission shift lever.

When the parking brake is applied, the **PARK** indicator lights up on the rev. counter and the related message will be displayed on the instrument cluster. If the engine was turned off when the automatic engagement device was deactivated (see "Deactivating Automatic Operation" in this chapter) it is possible to shift the parking brake simply by pulling the lever upward.



#### CAUTION!

The main function of the EPB is to allow safe parking of the vehicle, therefore it must only be applied when the vehicle is already stationary. If the EPB is used while the vehicle is moving and decelerating until a speed lower of 3 mph (5 km/h) and, in particular, until complete stop (typically in a sudden brake), it is necessary to have the EPB system checked by an **Authorized Maserati Dealer**.



#### WARNING!

- Always hold the brake pedal pressed during engagement or disengagement of the parking brake.





If you attempt to disengage the parking brake without having depressed the service brake pedal, a message will be displayed to warn you to do so.

- The EPB command activation while running, generates a deceleration of the vehicle with strong deceleration (Dynamic Braking). It is therefore recommended to use of this feature only in case of emergency. The stability of the car is guaranteed by the action of the activated ESC system.

## Deactivating Automatic Operation

To deactivate automatic operation of the parking brake, with the engine on, press the "PARK OFF" button on the central console.



The words "PARK OFF" appear on the display for 5 seconds, after which they remain displayed but in smaller size.



To reactivate automatic operation, press the "PARK OFF" button once again, the words "PARK ON" appear on the display for 5 seconds.



**CAUTION!**

- In certain conditions when the battery voltage is low, the electric parking brake system may temporarily be deactivated for safety reasons. Therefore, typically upon starting the engine, when the battery voltage drops, the message "PARK OFF" may temporarily be displayed on the instrument cluster, indicating that automatic operation is temporarily disabled.

- In the case of performance starting, check that the parking brake is disengaged.

## Failure Indication

In the event of electric parking brake system failure, the **BRAKE** warning light on the display will light up.

Depending on the message displayed, it signals the following failures of the EPB system:

- "Parking brake failure: go to dealer" If the message warning you to go to the nearest **Authorized Maserati Dealer** is displayed, drive slowly and remember that the electric parking brake device is not functioning.
- "EPB is overheated" If the vehicle has been stationary (key in the ignition switch to **STOP (OFF)** position) for about 15 minutes without using the parking brake, and the warning light illuminates again after restarting the engine, slowly drive to the nearest **Authorized Maserati Dealer**.
- "EPB failure only manual unlock allowed: see handbook" In this case, follow the manual emergency deactivation procedure in order to release the parking brake (see "Emergency Release of the



Parking Brake” in section “In an Emergency”).

- “Parking Brake system revision: go to dealer”

The EPB system requires maintenance, therefore contact an **Authorized Maserati Dealer** to have the system corrected.



### WARNING!

**In the event of an EPB failure, take your vehicle to the nearest Authorized Maserati Dealer as soon as possible.**

5

### Initialize the EPB System after a Battery Disconnecting

After the detachment and the subsequent connection of the battery, on the instrument cluster display the **BRAKE** warning light will light up. To initialize the EPB system lift, release and lift again the lever located next to the transmission shift lever.

### Emergency Disengagement

In case of brake lock with complete electrical system failure, it is necessary to act on the electric actuator using the special tool provided in the tool kit to release the pressure of the parking brake shoes (see “Emergency Release

of the Parking Brake” chapter in section “In an Emergency”).

### EPB Operation with Overheated Brakes

Driving on mountain roads with steep slopes or a sports use of the vehicle could overheat the brake system components. In these conditions, parking brake must not be used since the push of the power actuator might not be sufficient to ensure vehicle braking, especially on a slope. Drive normally without braking to allow the brakes to cool down a few minutes before stopping. In this way, the automatic or manual activation of the parking brake will ensure vehicle braking.

## Parking

Straighten the wheels and turn off the engine.

Before leaving the vehicle, make sure that the parking brake is fully applied in automatic or manual mode and place the transmission lever in the P (Park) position. Remove the key from the ignition switch.



### WARNING!

- **Always check that the vehicle is locked before leaving it.**
- **Never leave children unattended in the vehicle.**
- **Do not park the vehicle on paper, grass, dry leaves or other flammable materials. They could catch fire if they come into contact with hot parts of the exhaust system.**
- **Do not leave the engine running while the vehicle is unattended.**



### CAUTION!

When you need to park the vehicle on a steep slope, both with the engine on and off, it is recommended not only to





engage the parking brake, but also to shift the transmission shift lever to P (Park) before leaving the vehicle.

When parking on hill roads, it is important to turn the front wheels toward the curb on a downhill grade and away from the curb on an uphill grade.

Apply the parking brake before placing the shift lever in P (Park), otherwise the load on the transmission locking mechanism may make it difficult to move the shift lever out of P (Park).

In certain conditions, it is however advisable to disengage the parking brake manually and slightly apply the service brake for starting off. This is advisable when there are obstacles very close to the vehicle in the direction in which you intend to move.

## Brake and Stability Control System

The vehicle is equipped with an Electronic Stability Control (ESC) anti-yawing system, which helps to maintain directional control in the event of loss of grip of the tires. The system is able to detect potentially dangerous situations for the stability of the vehicle and automatically sets the brakes on all four wheels in a differentiated manner, in order to provide a torque settlement of the vehicle.

ESC includes the following subsystems:

- ASR (Anti-Slip Regulation)
- ABS (Anti-lock Braking System)
- EBD (Electronic Brake-force Distribution)
- HBA (Hydraulic Brake Assistance)
- BOS (Brake Override System)



### WARNING!

- **These systems cannot prevent the natural laws of physics from affecting the vehicle, nor can they increase traction, braking or steering efficiency beyond that afforded by the condition of the vehicle brakes and tires.**

- **These systems cannot prevent collisions, including those resulting from excessive speed in turns, following another vehicle too closely, or hydroplaning.**
- **The capabilities of a vehicle equipped with these systems must never be exploited in a reckless or dangerous manner that could jeopardize the driver's and the passenger's safety or the safety of others.**

## Electronic Stability Control (ESC)

This system enhances directional control and stability of the vehicle under various driving conditions. The ESC corrects over steering and under steering of the vehicle by applying the brake to the appropriate wheel.

Engine power may also be reduced to assist in counteracting the conditions of instability and maintain the right direction. The system is also able to reduce the engine power.

Through sensors fitted on the vehicle, the ESC system detects the driver's chosen direction comparing it to the one maintained while running. In case of discrepancy between the required trajectory and the current one, the



ESC system brakes the appropriate wheel to counteract over or under steering.

- Oversteer - when the vehicle is turning more than appropriate for the steering wheel position.
- Understeer - when the vehicle is turning less than appropriate for the steering wheel position.

The ESC system has two available operating modes:

### ESC On

This is the normal ESC operating mode. At each start-up of the vehicle, the ESC system is set in this mode and should be used for most driving conditions. The ESC should only be turned off for specific reasons as pointed out in the following paragraphs.

### ESC Off



The "ESC Off" mode is aimed for a more spirited driving experience but also purposeful for driving in deep snow, sand, or gravel. The current mode disables the traction control portion of the ESC and raises the threshold for ESC activation, allowing higher wheel spin than normally granted by the ESC system. The  (ESC Off) button is fitted in front of the transmission shift lever: to deactivate

the system see "Drive Mode" in this section.



**WARNING!**  
In SPORT mode the ESC control thresholds are higher for maximum performance on dry road surface. To ensure maximum security of the ESC is recommended not to activate SPORT mode on surfaces with medium- and low-grip (e.g., wet, snow, dirt, etc..) with ESC system active (button  (ESC Off) not pressed).

### NOTE:

*To improve the vehicle's traction when driving with snow chains, or when starting off in deep snow, sand, or gravel, it may be desirable to switch to the "ESC Off" mode by pressing the  (ESC Off) button and remain in this operational mode no longer than needed. Once the situation requiring "ESC Off" mode is overcome, turn the ESC on again by pressing the  (ESC Off) button. This may also be performed while in motion.*



### Anti-Slip Regulation (ASR)

The ASR incorporated in the ESC system avoids skidding of the driving wheels during acceleration by means of the engine control unit (spark advance delay, engine throttle opening reduction and fuel injection cut) and the rear brakes.

The ASR system is designed to enhance vehicle stability and active safety while driving, especially under the following conditions:

- internal wheel skidding on curves due to the load dynamic variations or excessive acceleration;
- excessive power transmitted to the wheels, also in relation to the road surface conditions;
- acceleration on slippery, snowy or icy road surfaces;







- in the event of loss of grip on wet roads (aquaplaning).

The ASR system works in combination with the electronic suspension control system: in normal conditions (SPORT mode off), stability in low and medium grip conditions has priority, while with SPORT mode active, the system favors traction, thereby optimizing vehicle performance on dry asphalt.

The ASR system is automatically activated every time the engine is started and can be deactivated by pressing  (ESC Off) button (see "Drive Mode" in this section).

### ASR System Failure

In the event of a fault, the system is automatically disabled and cannot be re-activated. While driving, this condition is signaled by the : amber warning light on the instrument cluster display, which illuminates together with the message "ASR unavailable go to dealer". Also the  (ESC On) amber warning light illuminates inside the tachometer with the message indicating that the ESC system is unavailable. In this case drive with the greatest care and have the system immediately checked by the nearest **Authorized Maserati Dealer**.

### MSR Function

The ASR system also controls the engine braking torque when the accelerator pedal is released under low grip conditions (e.g., snow, ice, etc.): in these conditions, the high braking torque provided by the engine may cause instability of the vehicle.

The system, using the same sensors as the ABS, detects skidding of one or both driving wheels when the accelerator is released and opens the motor-driven throttle of the engine fuel system thereby reducing the braking torque and re-establishing the maximum grip conditions for the driving wheels.



#### WARNING!

**The maximum deceleration that can be obtained with the engine brake always depends on the tire grip on the road surface. Snow or ice obviously reduce grip values.**



#### WARNING!

**California Proposition 65  
Operating, servicing and maintaining  
a passenger vehicle or off-road vehicle**

**can expose you to chemicals including such as, engine exhaust, carbon monoxide, phthalates and lead, that which are know to the State of California to cause cancer and birth defects or other reproductive harm. To minimize exposure, avoid breathing exhaust, do not idle the engine except as necessary, service your vehicle in a well-ventilated area and wear gloves or wash your hands frequently when servicing your vehicle. For more information go to:  
[www.P65Warnings.ca.gov/passenger-vehicle](http://www.P65Warnings.ca.gov/passenger-vehicle)**

### Anti-Lock Braking System (ABS) and Electronic Brake-force Distribution (EBD)

The Anti-Lock Brake System (ABS) provides increased vehicle stability and brake performance under most braking conditions. The system automatically "pumps" the brakes during severe braking to prevent wheel lock-up.

The Electronic Brake-force Distribution (EBD) prevents the rear wheels from over-braking and provides greater control of available braking forces applied to the rear axle.



## WARNING!

The ABS helps prevent the wheels from locking, but it does not increase the physical grip limits between the tires and the road. Therefore, always keep a safe distance from the vehicle in front of yours and reduce your speed when entering a curve.

## NOTE:

- When the vehicle's speed is higher than 7 mph (11 km/h), you may also hear a slight clicking sound as well as other motor noises. The system is performing a self-check cycle to ensure that the ABS is working properly.
- This self-check occurs each time the vehicle is started and accelerated past 7 mph (11 km/h).

ABS is activated during braking under certain road or stopping conditions. ABS-inducing conditions can include ice, snow, gravel, bumps, railroad tracks, loose debris.

You may also experience the following when the brake system goes into Anti-Lock:

- The ABS motor running (it may continue to run for a short time after the vehicle stops).
- The clicking sound of solenoid valves.
- Brake pedal pulsations.
- A slight drop or fall away of the brake pedal at the end of the stop. These are all normal characteristics of ABS functioning.



## WARNING!

- The ABS contains sophisticated electronic equipment that may be susceptible to interference caused by improperly-installed or high-output radio transmitting equipment. This interference can cause possible loss of anti-lock braking capability. Installation of such equipment should be performed by qualified Maserati personnel.
- Pumping the Anti-Lock Brakes will diminish their effectiveness and may lead to a collision. Pumping brakes makes the stopping distance longer. Just press firmly and continuously on your brake pedal when you need to slow down or stop

## ABS and EBD System Failure

In the event of a failure the ABS system will be deactivated, but this will not affect the efficiency of the standard braking system.

The failure will be indicated by the illumination of the  amber warning light on the instrument cluster.

An EBD system failure is indicated by the illumination of the **BRAKE** red warning light on the instrument cluster.

In this case we recommend that you contact the nearest **Authorized Maserati Dealer** in order to identify the fault as soon as possible, by means of the system self-diagnostic function.



## WARNING!

- The  failure warning light usually illuminates with the engine running to indicate a malfunction in the ABS system only. In this case, the braking system will remain fully functioning, but will not use the ABS. In these conditions, also the EBD system efficiency may be affected. Drive with the greatest care in order to avoid sudden braking and have the system immediately checked by the







nearest Centre of the Authorized Maserati Dealer.

- The **BRAKE** warning light illuminates when the engine is running to indicate an EBD system malfunction. In this case, sharp braking may cause an early locking of the rear wheels, and the vehicle may skid. Drive with the greatest care and have the system immediately checked by the nearest Centre of the Authorized Maserati Dealer.

## Hydraulic Brake Assistance (HBA)

HBA completes the ABS system by optimizing the vehicle braking capacity during emergency braking. In the event of a critical situation, where the vehicle must stop in the shortest possible distance, the driver usually depresses the brake pedal quickly, but often not strongly enough: this increases the braking distance. HBA has been designed to solve this problem and acts by applying the maximum braking force during emergency braking, in order to stop the vehicle in the shortest possible distance.

HBA recognizes the emergency condition by analyzing some

parameters, such as the pressure on the brake servo, the wheel speed and activation of the third stop. The ABS control unit cross-checks this data and substitutes the driver by activating the braking system's full power and so ensures optimal braking performance in the shortest possible distance.

## Brake Override System (BOS)

To complete the range of systems that assist braking, the vehicle is equipped with **BOS**, which is designed to stop the vehicle even when it is being accelerated. If the brake pedal is depressed together with the accelerator, the engine power should be automatically reduced and, if the driver continues to depress the accelerator, the system may even cause the vehicle to come to a complete stop.

Additionally, if the brake pedal is released when the accelerator is still depressed, the corresponding engine torque can be reached gradually.



## Using the Brakes



### CAUTION!

To obtain a good performance of brake pads and discs, avoid sudden braking during the first 190 mi (300 km).

The pad wear limit is indicated by the illumination of the **BRAKE WEAR** warning light, on the instrument cluster display. In this event, please contact an **Authorized Maserati Dealer**.



### WARNING!

- **Riding the brakes can lead to brake failure and possibly an accident. Driving with your foot resting or riding on the brake pedal can result in abnormally high brake temperatures, excessive lining wear, and possible brake damage. In an emergency full braking capacity may be impaired.**
- If the **BRAKE** red warning light illuminates when the engine is running with the message that indicates an insufficient brake fluid level, stop the vehicle and check the

*(Continued)*





**(Continued)**  
**brake fluid level immediately (see "Maintenance Procedure" in section "Maintenance and Care"). If fluid is below the minimum level, top up with the recommended fluid and contact an Authorized Maserati Dealer immediately to have the system checked. Brake fluid leaks affect the operation of the braking systems.**

- **The brake system performance in terms of active safety is not a reason for the driver to run unnecessary risks. The driving style shall always be suited to weather conditions, range of visibility and traffic.**
- **The maximum deceleration that can be obtained always depends on the tire grip on the road surface. With snow or ice on the road the grip is obviously reduced and the braking distance is very high, even with the ABS system.**

### Brake Pads and Brake Discs

Wear on the brake pads and brake discs depends to a great extent on the driving style and the conditions of use and therefore cannot be expressed in actual kilometers driven on the road.

The high-performance brake system is designed for optimal braking effect at all speeds and temperatures.

Certain speeds, braking forces and ambient conditions (e.g. temperature, humidity and long outdoor stopping periods) can therefore cause the brakes to "squeal". This is normal and will cease after a few brakings.

### New Brake Pads and/or Brake Discs

New brake pads have to be "broken in", and therefore only attain optimal friction to the brake disc when the vehicle has covered several hundreds km.

During this first period, the slightly reduced braking ability must be compensated for by pressing the brake pedal harder. This applies whenever the brake pads and/or brake discs are replaced.

### Brake Overheating

Driving on mountain roads with steep slopes or a sports use of the vehicle could overheat the brake system components. In these conditions, parking brake must not be used since the push on the brake shoes of the power actuator might not be sufficient

to ensure vehicle braking, especially on a slope.

Drive normally without braking to allow the brakes to cool down a few minutes before stopping. In this way, the automatic or manual activation of the parking brake will ensure vehicle braking.





## Use of the Engine

### Breaking-In

Today's most modern production methods are designed to provide extremely precise construction and assembly of components. However, moving parts do undergo a settling process, basically in the first hours of vehicle operation.

Do not drive keeping at a constant high speed rate for a prolonged time. While cruising, brief full-throttle acceleration within the limits of local traffic laws contributes to a good break-in. Wide-open throttle acceleration in low gear can be detrimental and should be avoided.

The engine oil installed in the engine at the factory is a high-quality energy conserving type lubricant. Oil changes should be consistent with anticipated climate conditions under which vehicle operations will occur. For the recommended viscosity and quality grades, see "Refillings" in section "Features and Specifications".

A new engine may consume some oil during its first few thousand kilometers of operation. This should be considered as a normal part of the

break-in and not interpreted as an indication of malfunction.

Avoid exceeding 5000 rpm for the first 620 trip mi (1000 km).

After starting the vehicle, do not exceed 4000 rpm until the engine has warmed up sufficiently (coolant temperature: 149-158°F/65-70°C).

### While Driving

Never travel with the tachometer indicator approaching the peak rpm, not even downhill. When the tachometer indicator is approaching the peak rpm (red colored zone), take precautions to avoid exceeding that limit.



Ensure proper operation of different devices checking their respective control telltales.



### CAUTION!

- Under normal conditions, all red warning lights on the instrument cluster display should be off. When they come on, they indicate a malfunction. Refer to "Instrument Cluster" in section "Dashboard Instruments and Controls".
- Continuing to drive when a red warning light is on could cause serious damage to the vehicle and affect its performance.



### WARNING!

Do not travel downhill with the engine off, as the servo brake will no longer function due to the vacuum decrease and thus after a few braking attempts, the system becomes totally inefficient. The power steering will also lose its efficiency under these conditions.

### Onboard Diagnostic System

Your vehicle is equipped with a sophisticated onboard diagnostic system. This system monitors the performance of the emissions, engine,





and automatic transmission control systems. When these systems are operating properly, your vehicle will provide excellent performance and fuel economy, as well as engine emissions well within current local regulations of various countries. If any of these systems require service, the system will turn on the  Malfunction Indicator Light (MIL). It will also store diagnostic codes and other information, which your **Authorized Maserati Dealer** will use to service your vehicle. Although the vehicle will still be driveable and not need towing, contact the **Authorized Maserati Dealer** for service as soon as possible.

5



## CAUTION!



- Prolonged driving with the  Malfunction Indicator Light (MIL) on could cause further damage to the emissions control system. It could also affect fuel economy and drivability. The vehicle must be serviced before any emissions tests can be performed.
- If the  Malfunction Indicator Light (MIL) is flashing while the engine is running, severe catalytic converter damage and power loss will soon occur. Immediate service is required at an **Authorized Maserati Dealer**.
- After the problem has been solved, the **Authorized Maserati Dealer** personnel will perform specific tests on the test bench for a complete check of the system and, if necessary, also road tests, even on long distances.

In addition, the system is equipped with a diagnostics connector that, when interfaced with suitable instruments, makes it possible to read the error codes stored in the ECU, together with a set of specific parameters for engine operation

diagnostics cycle, on compliance with CARB, EPA OBDII rules.



## CAUTION!

- Once the engine is started, the  Malfunction Indicator Light (MIL) will remain on for approximately 18 seconds before turning off. This is a normal condition and part of the operating strategy.
- When the key in the ignition switch is turned to **MAR (ON)** position if the  Malfunction Indicator Light (MIL) does not illuminate or if it illuminates while driving, contact your local **Authorized Maserati Dealer** as soon as possible.



## WARNING!

**California Proposition 65**  
Operating, servicing and maintaining a passenger vehicle or off-road vehicle can expose you to chemicals including such as, engine exhaust, carbon monoxide, phthalates and lead, that which are know to the State of California to cause cancer and birth defects or other reproductive harm. To minimize exposure, avoid breathing



exhaust, do not idle the engine except as necessary, service your vehicle in a well-ventilated area and wear gloves or wash your hands frequently when servicing your vehicle. For more information go to: [www.P65Warnings.ca.gov/passenger-vehicle](http://www.P65Warnings.ca.gov/passenger-vehicle)

### Position of the Diagnostic Connector

The diagnostic connector is positioned underneath the dashboard, next to the hood opening lever. It can be accessed without removing any cover.

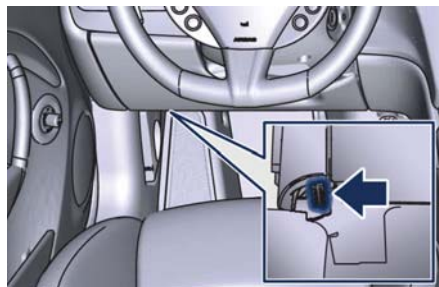

## Cruise Control (CC)

The CC enables the driver to maintain the desired vehicle speed without pressing the accelerator pedal, reducing driving fatigue on highways, especially long trips, as the set speed is automatically maintained. A firm press on the accelerator pedal or the braking pedal will temporarily deactivate the cruise control function.



### CAUTION!

The device can only be switched on at speeds exceeding 19 mph (30 km/h) and it switches off automatically when the brake pedal is pressed or when a speed of 125 mph (200 km/h) is exceeded.





### WARNING!

The Cruise Control function must only be activated when traffic and the route permit a constant speed to be maintained safely for a sufficiently long distance.

## Controls

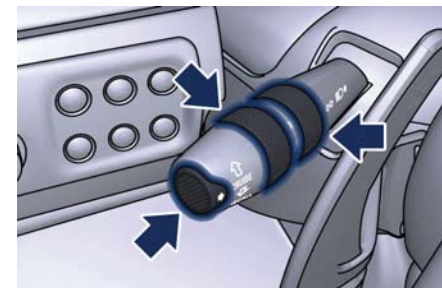
The controls of the CC are located on the multifunction lever, on the left side of the steering wheel.



- The innermost ON/OFF switch has two positions:
  - OFF: the CC is deactivated;
  - ON: the CC is active. When the CC is activated, the  green warning light on the display illuminates together with the message "Cruise control on".
- The rotating section in the middle of the left multifunction lever is used to store the vehicle speed, to keep it constant or to increase or decrease the speed stored. Turn the rotating section to position "+" to save the speed reached or to increase the speed stored. Turn the rotating section to position "-" to decrease



the speed stored. Every time rotating section is reset, the speed is increased or decrease by approx. 0.6 mph (1 Km/h). Keep the rotating section turned to vary the speed continuously. When a new speed is reached, it will automatically remain constant.

- Button "RCL" at end of left multifunction lever is used to resume the speed stored.

### NOTE:

- *When the key in the ignition switch is turned to STOP (OFF) position or ON/OFF switch is in the "OFF" position, the speed stored is erased and the system deactivated.*
- *The CC must be deactivated when not in use.*



### WARNING!

**Leaving the Cruise Control system when not in use is dangerous. You could accidentally set the system or cause it to go faster than you want. Always leave the CC off when you are not using it.**

### Storing a Speed

Turn the ON/OFF switch to "ON" and reach the desired speed driving normally. Turn the rotating section in the middle of the left multifunction lever to "+" for at least 3 seconds and then release it.

The vehicle speed is stored and the accelerator pedal can be released. The vehicle will proceed at the constant speed stored until the brake pedal is pressed.

If necessary, (for example, to pass another vehicle), you can accelerate by simply pressing the accelerator pedal. Afterward, when you release the accelerator pedal, the vehicle will return to the speed previously stored.

### Resuming the Speed Stored

If the CC has been deactivated after braking, the speed previously stored can be resumed as follows:

- gradually accelerate until you reach a speed close to that stored;
- engage the gear selected when the speed was stored (4th, 5th or 6th gear);
- press button "RCL".

### Increasing the Speed Stored

The speed stored can be increased in two ways:

- by pressing the accelerator and then storing the new speed reached (turn the rotating section in the middle of the left multifunction lever for more than 3 seconds); or
- by turning the rotating section to position "+": each impulse transmitted by the rotating section will cause a slight increase in speed (about 0.6 mph/1 Km/h), whereas a constant pressure on the same rotating section will cause a continuous increase in speed. When the rotating section is released, the new speed will be automatically stored in the memory.

### Decreasing the Speed Stored

The speed stored can be reduced in two ways:

- by deactivating the CC, pressing the brake pedal and then storing the new speed (turning the rotating section to position "+" for at least 3 seconds); or
- by keeping the rotating section turned to position "-" until reaching the new speed, which will be stored automatically.

### Resetting the Speed Stored

The speed stored is automatically reset:





- by turning the engine off; or
- by turning ON/OFF switch to "OFF" position.

### Warnings while Driving with CC



#### WARNING!

- When driving with CC activated, do not shift to N (Neutral) position. It is advisable to activate CC only when traffic and road conditions permit safe use of this device, that is: on straight and dry roads, expressways or highways, smooth flowing traffic and smooth asphalt. Do not activate this device when driving in town or in heavy traffic.
- CC can only be activated at speeds exceeding 19 mph (30 km/h).
- CC can only be activated in 4th, 5th or 6th gear, depending upon the vehicle speed.
- When driving downhill with the CC activated, the vehicle may pick up speed slightly exceeding the speed stored, due to the change in the engine load.
- In the event of malfunctioning or failure of CC, turn ON/OFF switch to "OFF" position and contact the Authorized Maserati Dealer after

having checked that the relative fuse is in proper working order.

- ON/OFF switch can be always left at "ON" position without damaging the CC. In any case, it is advisable to deactivate the CC when it is not in use. Turn ON/OFF switch to "OFF" position to prevent any speeds from being unintentionally stored.

## Tires - General Information

### Tire Safety Information

#### Tire Markings

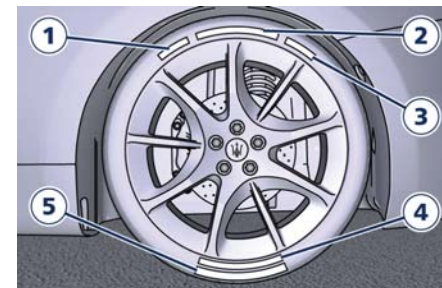

1. U.S. DOT Safety Standards Code (TIN).
2. Size Designation.
3. Service Description.
4. Maximum Pressure and Maximum Load.
5. Treadwear, Traction and Temperature Grades (see "Department of Transportation Uniform Tire Quality Grades" in this section).







## Tire Sizing Chart

**EXAMPLE: P285/40 ZR19 (100Y) XL or 285/40 ZR19 (Y100) XL**

<b>Size Designation:</b>
<b>P</b> = Passenger car tire size based on U.S. design standards <b>"...blank..."</b> = Passenger car tire based on European design standards
<b>285</b> = Section width in millimeters (mm)
<b>40</b> = Aspect ratio in percent (%) — Ratio of section height to section width of tire
<b>ZR</b> = Construction Code <ul style="list-style-type: none"> <li><b>Z:</b> means a tire usable at speeds greater than 150 mph (240 km/h)</li> <li><b>R:</b> means radial construction</li> </ul>
<b>19</b> = Rim diameter in inches (in)

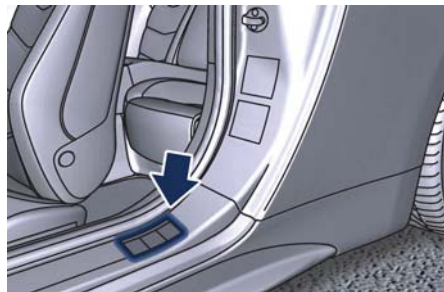

### Service Description:

**100** = Load Index — A numerical code associated with the maximum load a tire can carry

**Y** = Speed Symbol — A symbol indicating the range of speeds at which a tire can carry a load corresponding to its load index under certain operating conditions. The maximum speed corresponding to the speed symbol should only be achieved under specified operating conditions (i.e., tire pressure, vehicle loading, road conditions, and posted speed limits)

### Load Identification:

**"...blank..."** = Absence of any text on the sidewall of the tire indicates a Standard Load (SL) tire

**XL** = Extra Load (or reinforced) tire

**LL** = Light Load tire

### Tire Identification Number (TIN)

The TIN may be found on one or both sides of the tire, however the date code may only be on one side. Tires with white sidewalls will have the full TIN, including the date code, located on the white sidewall side of the tire.

Look for the TIN on the outboard side of black sidewall tires as mounted on the vehicle. If the TIN is not found on the outboard side, then you will find it on the inboard side of the tire.

### EXAMPLE: DOT MA L9 ABCD 0313

**DOT** = Department of Transportation — This symbol certifies that the tire is in compliance with the U.S. Department of Transportation tire safety standards and is approved for highway use.

**MA** = Code representing the tire manufacturing location (two digits).

**L9** = Code representing the tire size (two digits).

**ABCD** = Code used by the tire manufacturer (one to four digits).

**03** = Number representing the week in which the tire was manufactured (two digits). In this case, 03 means the 3<sup>rd</sup> week.

**13** = Number representing the year in which the tire was manufactured (two digits). In this case, 13 means the year 2013.





## Tire and Loading Information Label

The proper cold tire inflation pressure is listed on the driver's side rear door pillar.

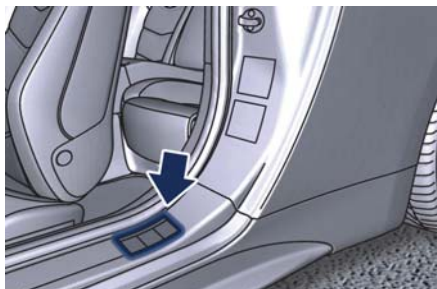

This label tells you important information about the:

- Number of people that can be carried in the vehicle.
- Total weight the vehicle can carry.
- Tire size designed for the vehicle.
- Cold tire inflation pressures for the front, rear, and spare tires.

## Loading

The vehicle maximum load on the tire must not exceed the load carrying capacity of the tire on your vehicle. You will not exceed the tire's load carrying capacity if you adhere to the loading conditions, tire size, and cold tire inflation pressures specified on

the "Tire and Loading Information Label" and in the "Features and Specifications" section.

### NOTE:

*Under a maximum loaded vehicle condition, gross axle weight ratings (GAWRs) for the front and rear axles must not be exceeded.*

## Tires

Driving over rough or damaged road surfaces, as well as debris, curbs and other obstacles can cause serious damage to wheels, tires, and suspension parts.

This is more likely to occur with low-profile tires, which provide less cushioning between the wheel and the road.

Be careful to avoid road hazards and reduce your speed, especially if your vehicle is equipped with low profile tires.

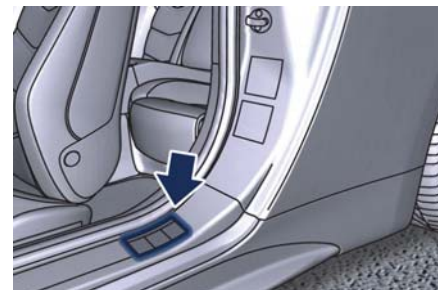

### WARNING!

**Overloading of your tires is dangerous. Overloading can cause tire failure, affect vehicle handling, and increase the stopping distance. Use tires of the recommended load capacity for your vehicle. Never overload them.**

## Department of Transportation Uniform Tire Quality Grades

The following tire grading categories were established by the National Highway Traffic Safety Administration. The specific grade rating assigned by the tire's manufacturer in each category is shown on the sidewall of the tires on your vehicle.





All passenger car tires must conform to Federal safety requirements in addition to these grades.

### Treadwear

The Treadwear grade is a comparative rating, based on the wear rate of the tire when tested under controlled conditions on a specified government test course. For example, a tire graded 150 would wear one and one-half times as well on the government course as a tire graded 100. The relative performance of tires depends upon the actual conditions of their use, however, and may depart significantly from the norm due to variations in driving habits, service practices, and differences in road characteristics and climate.

### Traction Grades

The Traction grades, from highest to lowest, are AAA, A, B, and C. These grades represent the tire's ability to stop on wet pavement, as measured under controlled conditions on specified government test surfaces of asphalt and concrete. A tire marked C may have poor traction performance.



**WARNING!**  
The traction grade assigned to this tire is based on straight-ahead braking traction tests, and does not include acceleration, cornering, hydroplaning, or peak traction characteristics.

### Temperature Grades

The temperature grades are A (the highest), B, and C, representing the tire's resistance to the generation of heat and its ability to dissipate heat, when tested under controlled conditions on a specified indoor laboratory test wheel. Sustained high temperature can cause the material of the tire to degenerate and reduce tire life, and excessive temperature can lead to sudden tire failure. The grade C corresponds to a level of performance, which all passenger car tires must meet under the Federal Motor Vehicle Safety Standard No. 109. Grades B and A represent higher levels of performance on the laboratory test wheel, than the minimum required by law.



**WARNING!**  
The temperature grade for this tire is established for a tire that is properly inflated and not overloaded. Excessive speed, under-inflation, or excessive loading, either separately or in combination, can cause heat buildup and possible tire failure.

### Tire Pressure

Proper tire inflation pressure is essential for safety and best performance of your vehicle. The tire pressure monitoring system "TPMS" setup on the vehicle (see "Tire Pressure Monitoring System" in this section) may alert the driver about insufficient tire pressure even though the driver is responsible for regularly checking the tire pressure. Radial tires fitted on the vehicle may look properly inflated even when they actually are under inflated. Do not make a visual judgment when determining proper inflation. Three primary driving aspects are affected by improper tire pressure:

### Safety





### WARNING!

- **Improperly inflated tires can be dangerous.**
- **Under-inflation increases tire flexing and can result in tire overheating.**
- **Over-inflation reduces a tire's ability to cushion shock. Objects on the road and potholes can cause damage that results in tire failure.**
- **Over-inflated or under-inflated tires can affect vehicle handling and can fail suddenly, resulting in loss of vehicle control.**
- **Unequal tire pressures can cause steering problems.**
- **Unequal tire pressures from one side of the vehicle to the other can cause the vehicle to drift to the right or left.**
- **Always drive with each tire inflated to the recommended cold tire inflation pressure.**

### Economy

Improper inflation pressures may cause uneven wear patterns to develop across the tire tread. These abnormal wear patterns will reduce tread life resulting in a need for earlier tire replacement. Under-

inflation also increases tire rolling resistance resulting in higher fuel consumption.

### Ride comfort and vehicle stability

Proper tire inflation contributes to a comfortable ride. Over-inflation produces a jarring and uncomfortable ride.

### Tire Pressure Checkup

The proper cold tire inflation pressure is indicated on the driver's side rear door pillar and on the table "Tire Inflation Pressure" in section "Features and Specifications". Inflation pressure specified on the table always refers to "cold tire inflation pressure". Cold tire inflation pressure is defined as the tire pressure after the vehicle has not been driven for at least three hours, or driven less than 1 mi (1,6 km) after a three hour period.

Check tire pressures more often in case of significant outside temperature changes, as tire pressure varies according to temperature changes.

The pressure should be checked and if necessary adjusted; tire wear and overall conditions should also be checked monthly. Tire pressures

change by approximately 1 PSI (0,07 bar) per 12°F (7°C) of air temperature change. Keep this in mind when checking tire pressure inside a garage, especially in winter.

Example: If garage temperature = 68°F (20°C) and the outside temperature = 32°F (0°C) then the cold tire inflation pressure should be increased by 3 PSI (0,21 bar) for every 12°F (7°C) for this outside temperature condition.

Tire pressure may increase from 2 to 6 PSI (0,13 to 0,4 bar) during operation. DO NOT reduce this normal pressure build-up or your tire pressure will be too low. After inspecting or adjusting the tire pressure, always reinstall the valve stem cap. This will prevent moisture and dirt from entering the valve stem, which could damage the valve stem and the TPMS sensor connected to it.

### Tread Wear Indicators

Tread wear indicators are in the original equipment tires to help you determine when your tires should be replaced.

These indicators are molded into the bottom of the tread grooves. When the tread is worn to one of the tread wear indicators, the tire should be replaced.



## WARNING!

The wet performance (aquaplaning resistance) will decrease proportionally to the thickness of the tread.

## Tires Durability

The service life of a tire depends on various factors including, but not limited to:

- driving style;
- tire pressure;
- distance driven.



## WARNING!

Tires and the spare tire (if equipped) should be replaced after six years, regardless of the remaining tread. Failure to follow this warning could result in tire failure.

## Replacement Tires

### NOTE:

*In order to maintain high performance and safety level under all driving conditions, Maserati strongly recommends to use tires equivalent to the originals in size, quality and performance when replacement is needed.*

For the size designation of your tire see the label on the driver's side rear door pillar or see table "Wheels" in section "Features and Specifications". The "Load Index" and "Speed Symbol" for your tire will be found on the original equipment tire sidewall. It is recommended to replace the two front tires or two rear tires as a pair. Replacing just one tire can seriously affect your vehicle's handling. If you ever replace a wheel assembly, make sure that the wheel's specifications (valve, TPMS sensor and tire) match those of the original wheels. Failure to use equivalent replacement tires may adversely affect the safety, handling, and ride of your vehicle.

Your Authorized Maserati Dealer is available to provide suggestions as to

the types of tires most suited to the use foreseen by the Customer.



## WARNING!

- Do not use a tire, wheel size or rating other than that specified for your vehicle. Some combinations of unapproved tires and wheels may change suspension dimensions and performance characteristics, resulting in altered steering, handling, and braking operations of the vehicle. This can cause unpredictable handling and stress to steering and suspension components. Use only the tire and wheel sizes with load ratings appointed for your vehicle.
- Never use a tire with a smaller load index or capacity, other than what was originally equipped on your vehicle. Using a tire with a smaller load index could result in tire overloading and failure.
- Always check the maximum speed rating on the tire sidewall on any tire on the vehicle.





- **Never exceed the maximum speed rating of the tires. Risk of accident and serious personal injury due to excessive speed.**
- **Failure to equip your vehicle with tires having adequate speed capability can result in tire failure.**

**CAUTION!**

Replacing original tires with tires of a different size may result in false speedometer and odometer readings.

**Winter Tires**

These tires are specially designed for driving on snow and ice and are fitted to replace the ones supplied with the vehicle. Winter or all-season tires can be identified by the M+S (Mud & Snow) or 3PMSF (3 Peaks Mountain Snow Flake) designation on the tire sidewall.

Before mounting winter tires, contact an **Authorized Maserati Dealer** to receive the technical information necessary to advise you on wheel and tire compatibility.

As to the type of tires to use, inflation pressures and winter tires specifications, carefully follow the indications as reported in the

“Technical Data” and “Tire Inflation Pressure” chapters in section “Features and Specifications”.

**WARNING!**

**The standard tires profile and rubber mixture are optimized for wet and dry driving conditions. Standard tires may not prove favorable for snow conditions.**

**NOTE:**

*Snow tires should have the same load capacity as original equipment tires and should be mounted on all four wheels.*

**Snow Chains**

Maserati approved traction devices (or snow chains) may be used to improve traction on compacted snow in heavy snow conditions.

The use of snow chains is specified by local regulations of each country. Use snow chains of reduced dimensions, with a maximum projection of 0.35 in (9 mm) beyond the tire tread.

Maserati recommended to use snow chains KONIG, type “Supermagic”.

The snow chains may be fitted only on rear wheel tires.

Please, contact your Service for further information.

Check the snow chain tension after driving for a distance of about 55 yd (50 m) with the chains fitted.

With the snow chains fitted, it is advisable to deactivate the ESC system (see chapter “Drive Mode” in this section).

**CAUTION!**

- **The use of non-recommended snow chains may damage the vehicle.**
- **Broken chains can cause serious damage. Stop the vehicle immediately if noise occurs that could indicate chain breakage. Remove the damaged parts of the chain before further use.**
- **Do not exceed 30 mph (50 km/h).**
- **Drive cautiously and avoid severe turns and large bumps, especially with a loaded vehicle.**
- **Avoid holes in the road, do not drive over steps or sidewalks and do not drive on long stretches without snow. This will prevent damage to the vehicle and the roadbed.**



## NOTE:

The Authorized Maserati Dealer can provide you with all information about the Maserati Snow Chains, available in the "Genuine Accessories" range.

## Tire Pressure Monitoring System - TPMS

### Guidelines

Each tire (including the spare tire, if provided) should be checked monthly. Tires should be checked when cold and inflated to the inflation pressure recommended by the vehicle manufacturer indicated on tire inflation pressure label (applied on the driver's rear door pillar) and in "Tire Inflation Pressure" of section "Features and Specifications".

If your vehicle has tires of a different size than the size indicated on the vehicle placard or tire inflation pressure label, you should determine the proper tire inflation pressure for those tires.



As an added safety feature, your vehicle has been equipped with a tire pressure monitoring system (TPMS) that illuminates a low tire pressure telltale when one or more of your tires is significantly under-inflated. Accordingly, when the low tire pressure telltale illuminates, you should stop and check your tires as soon as possible, and inflate them to the proper pressure. Driving on a

significantly under-inflated tire causes the tire to overheat and can lead to tire failure. Under-inflation also reduces fuel efficiency and tire tread life, and may affect the vehicle's handling and stopping ability. Please note that the TPMS is not a substitute for proper tire maintenance, and it is the driver's responsibility to maintain correct tire pressure, even if under-inflation has not reached the level to trigger illumination of the TPMS low tire pressure telltale.

Your vehicle has also been equipped with a TPMS malfunction indicator to indicate when the system is not operating properly.

The TPMS malfunction indicator is combined with the low tire pressure telltale. When the system detects a malfunction, the telltale will flash for approximately one minute and then remain continuously illuminated. This sequence will continue upon subsequent vehicle start-ups as long as the malfunction exists. When the malfunction indicator is illuminated, the system may not be able to detect or signal low tire pressure as intended. TPMS malfunctions may occur for a variety of reasons, including the installation of replacement or alternate tires or wheels on the vehicle



that prevent the TPMS from functioning properly. Always check the TPMS malfunction telltale after replacing one or more tires or wheels on your vehicle to ensure that the replacement or alternate tires and wheels allow the TPMS to continue to function properly.

## General Information

The Tire Pressure Monitoring System (TPMS) will warn the driver of a low tire pressure according to the vehicle recommended cold pressure indicated on the table "Tire Inflation Pressure" in section "Features and Specifications" and on the label applied on the driver's side at the base of the rear door pillar.

The cold tire inflation pressure must not exceed the maximum inflation pressure molded into the tire sidewall. Check "Tires – General Information" in section "Driving" for information on how to properly inflate the tires.

The tire pressure will also increase as the vehicle is driven - this is normal and there is no adjustment required when this occurs.

The TPMS will warn the driver of a low tire pressure if the tire pressure falls below the low-pressure warning limit for any reason, including low

temperature effects and natural pressure loss of the tire.

The TPMS will continue to warn the driver of low tire pressure as long as the condition persists and will not turn off until the tire pressure is equal or above the recommended cold inflation pressure.

The TPMS monitors the tire pressure by means of special sensors fitted inside the wheel rims, in position with the inflation valve.

These sensors transmit a signal that is detected by the antenna integrated in the ECU.

The ECU processes this information and, via the CAN line, transmits a series of tire pressure data and system errors, if any, to the instrument cluster. The display may show the information received by means of specific screen pages, which can be recalled by pressing briefly the "MODE" button (see "TFT Display: Controls" in chapter "Instrument Cluster" of the section "Dashboard Instruments and Controls").

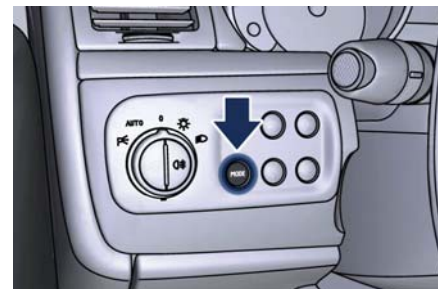

### WARNING!

The TPMS warns the driver that the tire pressure has decreased. This warning does not exempt the driver from periodically checking the tires and from complying with the prescribed tire pressure levels.



### CAUTION!

- The TPMS has been optimized for the original equipment tires and wheels. TPMS pressures and warning have been established for the tire size equipped on your vehicle. Undesirable system operation or sensor damage may occur when using replacement equipment that is not of the same size, type, and/or

*(Continued)*





## (Continued)

style. Aftermarket wheels can cause sensor damage. Do not use aftermarket tire sealants or balance beads, as damage to the sensors may result.

- The system can temporarily experience radio-electric interference emitted by devices using similar frequencies.
- After inspecting or adjusting the tire pressure, always reinstall the valve stem cap. This will prevent moisture and dirt from entering the valve stem and damage the TPMS internal sensor.

### NOTE:

- Driving on a significantly underinflated tire causes the tire to overheat and may lead to tire failure. Under-inflation also reduces fuel efficiency and tire tread life, and may affect the vehicle's handling and stopping ability.
- The TPMS is not a substitute for proper tire maintenance, and it is the driver's responsibility to maintain correct tire pressure using an accurate tire pressure gage, even if under-inflation has not reached the

level to trigger illumination of the TPMS light (⚠).

- Seasonal temperature changes will affect tire pressure, and the TPMS will monitor the actual tire pressure in the tire.

## Viewing Messages on the Display

By pressing repeatedly the "MODE" button of the control panel on left side of the steering column, the user can access the information page that shows the pressure values of each tire ("Tire Pressure" screen page: see paragraph "TFT Display: Screen Pages" in chapter "Instrument Cluster" of section "Dashboard Instruments and Controls").



If system faults or low pressure is detected on a not inflated tire,

"Check Tire Pressure" or "TPMS Malfunction" pop-up message will be displayed for 10 seconds. The (⚠) amber warning light will permanently illuminate on the right side of the instrument cluster display. With a malfunction detected, the "Tire Pressure" screen page will not be available while will be available the calibration screen page. The "Tire Pressure" screen page becomes available again, until the malfunction is corrected.

### Low Tire Pressure Conditions

The signal transmitted by the ECU activates messages and symbols on the TFT display with two priority levels corresponding to the following thresholds:

- Soft Warning: if the pressure is 10% lower than the rated pressure;
  - Hard Warning: if the pressure is 17% lower than the rated pressure.
- The system refers to the rated pressure acquired after calibration. The two alarm thresholds for monitoring the tire pressure respectively activate the following alerts:
- "Check tire pressure" illuminates on the display when the pressure of one





or more tires falls below the low-pressure alarm threshold (Soft Warning). The tire with its low pressure value will be highlighted in amber color for 30 seconds.



- The tire with its low pressure value in amber color, the message “Low inflation pressure tire” and “Do not drive on” in rolling mode with the (L) amber warning light always on activates when the pressure of one or more tires is below the minimum pressure alarm threshold (Hard Warning).



The TPMS screen page is displayed for 30 seconds and then the screen page that was previously displayed reappears. If the malfunction persists, the TPMS screen page shown in the picture will be automatically displayed for 30 seconds the next time the engine is started.

The driver can call up the TPMS screen page at any time to display which tires have low pressure.

Occasionally, the system may not detect which wheel signals a malfunction. If this is the case, then only the message “Check tire pressure” will be displayed on the TFT display.

#### Punctured Tire

When the instrument cluster receives a signal from the tire pressure ECU indicating that the pressure level of one or more tires is below the alarm

threshold or there is a sudden pressure loss (punctured tire). The (L) amber warning light will permanently illuminate on the instrument cluster and screen pages shown in the picture will alternate on the display for 30 seconds: then the screen page that was previously displayed reappears on the TFT display.



If the malfunction persists, the display will show these screen pages for 30 seconds every time the key in the ignition switch is subsequently turned back to **MAR (ON)** position. These screen pages will be displayed until the situation is corrected and the system is calibrated again as required by the system.

#### System Not Calibrated

The system must be calibrated:

- after replacing one or more tires;



- after inverting the wheels;
- if you are not sure whether at least one of the operations above was performed.

If you simply corrected the tire inflation pressure, you do not need to recalibrate the system.

In the event that the system has not been calibrated or calibration has been performed incorrectly and following replacement or reversal of one or more tires, the (⚠) amber warning light will flash for 85 seconds on instrument cluster, and the TFT display will show screen page with dashes "--,--" in the place of the pressure levels of each tire.



When the TPMS display cycle ends (30 seconds), the car symbol with message will disappear and reappears the screen page that was previously displayed will reappear: the (⚠) amber

warning light remains on until the system has been calibrated. To calibrate the system, select the screen page "TPMS calibration" by pressing the "MODE" button. A message will tell you to press and hold button "+" to activate the calibration procedure.

**NOTE:**

*The TPMS calibration operation is possible even with the engine running but the vehicle must be stationary (0 mph-km/h).*

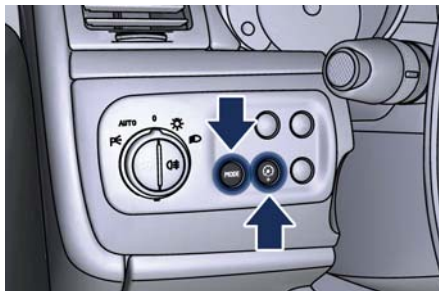

The system may take up to 10 minutes, by driving at speed lying between 6 mph (10 km/h) and 80 mph (130 km/h), to complete the process. During this time the (⚠) amber symbol and the message "Calibration activated" will be displayed for 10 seconds.



During calibration, if the user recalls the information page showing the pressure levels of each tire, dashes



“--,” will be displayed in the place of the values.

#### NOTE:

- The system will not perform calibration if the pressure is below 2 bar (29 psi).
- To allow the system to acquire the sensors’s data, after the startup of the car, if possible avoid to stop. During this interval the TFT display can show screen page with dashes “--,” in the place of the pressure levels of each tire.
- If calibration is not completed within 10 minutes of driving the car, the instrument cluster shows “TPMS Malfunction” pop-up message and “Tire Pressure” screen disappear. The (⚠) warning light remains light on.

### TPMS Malfunction

Screen page shown in picture may appear in the following cases:

- malfunction in the ECU system/wiring;
- no signal reception by one or more sensors due to malfunctioning, broken or dead battery;
- ECU malfunction.



The display procedure follows the usual logic of malfunctions. Therefore, after 30 seconds, the display will show the screen page that was active before the malfunction occurred. In addition to screen page being displayed, the (⚠) amber warning light, which is permanently illuminated on the instrument cluster, will flash for 85 seconds, after which it will remain permanently on until the situation is corrected. The information page that shows the pressure value for each tire cannot be recalled.

## Fuel Requirements

The engines are designed to meet all environmental regulations and provide excellent fuel economy and performance when using unleaded premium gasoline with an AKI octane rating of 91 or above. AKI (Anti Knock Index) is an average on the Research Octane Number, RON, and the Motor Octane Number, MON (RON + MON/2 gives you the AKI).

For vehicle top performance, use unleaded premium gasoline with no less than 93 minimum AKI octane rating.

Poor quality gasoline can cause problems such as hard starting, stalling, and hesitations. If you experience these symptoms, try another brand of gasoline before considering service for the vehicle at an **Authorized Maserati Dealer**. Besides using unleaded gasoline with the proper octane rating, gasoline that contain detergents, anti-corrosion and stability additives are recommended. Using gasoline that have these additives may help improve fuel economy, reduce emissions, and maintain vehicle performance.



## CAUTION!

- Maserati strongly recommends the use of Premium unleaded fuel **ONLY**. Use of lesser grade fuel (other than Premium) will lead to reduced engine performance, and poor fuel economy and can lead to the  Malfunction Indicator Light (MIL) illuminating on the instrument cluster. Continued use of lesser grade fuel (other than Premium fuel) can lead to engine misfire problems and possible catalytic converter damage.
- The anti-pollution devices of the vehicle require unleaded fuel to be used at all times. Under no circumstance, not even in an emergency, should leaded fuel be supplied to the fuel tank, not even a minimum quantity. This would irreparably damage the catalytic converters. An inefficient catalytic converter results in noxious exhaust emissions which damage the environment.

## Reformulated Gasoline

Many areas of the country require the use of cleaner burning gasoline, referred to as "Reformulated

Gasoline". Reformulated gasoline contains oxygenates and are specifically blended to reduce vehicle emissions and improve air quality. Maserati supports the use of reformulated gasoline. Properly blended reformulated gasoline will provide excellent performance and durability of engine and fuel system components.

## Gasoline/Oxygenate Blends

Some fuel suppliers blend unleaded gasoline with oxygenates such as Ethanol. Fuels blended with oxygenates may be used in your vehicle.



## CAUTION!

**DO NOT** use gasoline containing Methanol or gasoline containing more than 10% Ethanol. Use of these blends may result in starting and driveability problems, damage critical fuel system components, cause emissions to exceed the applicable standard, and/or cause the  Malfunction Indicator Light (MIL) to illuminate (see "Instrument Cluster" in section "Dashboard Instruments and Controls". Pump labels should clearly communicate if a fuel contains greater than 10% Ethanol.

Problems that result from using gasoline containing Methanol or gasoline containing more than 10% Ethanol are not the responsibility of Maserati and may not be covered under warranty.

## MMT in Gasoline

MMT (Methylcyclopentadienyl Manganese Tricarbonyl) is a manganese containing metallic additive that is blended into some gasoline to increase octane. Gasoline blended with MMT provides no performance advantage beyond gasoline of the same octane number without MMT.

Maserati recommends gasoline **without** MMT to be used in your vehicle. The MMT content of gasoline may not be indicated on the gasoline pump; therefore, you should ask the gasoline station operator whether or not the gasoline contains MMT. It is even more important to look for gasoline without MMT in Canada, because MMT can be used at levels higher than those allowed in the United States. MMT is prohibited in Federal and California reformulated gasoline.







## Materials Added to Fuel

All gasoline sold in the United States is required to contain effective detergent additives. Use of additional detergents or other additives is not needed under normal conditions and they would result in additional cost. Therefore, you should not have to add anything to the fuel.

## Fuel System Warnings



### WARNING!

Follow these guidelines to maintain your vehicle's performance:

- The use of leaded gasoline is prohibited by Federal and Provincial law. Using leaded gasoline can impair engine performance and damage the emissions control system.
- The use of fuel additives, which are now being sold as octane enhancers, is not recommended. Most of these products contain high concentrations of methanol. Fuel system damage or vehicle performance problems resulting from the use of such fuels or additives is not the responsibility of Maserati.

### NOTE:

*Intentional tampering with the emissions control system can result in civil penalties civil penalties and could void the vehicle warranty.*

## Carbon Monoxide Warnings



### WARNING!

Carbon monoxide (CO) in exhaust gases is deadly. Follow the precautions below to prevent carbon monoxide poisoning:

- Do not inhale exhaust gases. They contain carbon monoxide, a colorless and odorless gas, which can kill. Never run the engine in a closed area, such as a garage, and never sit in a parked vehicle with the engine running for an extended period. If the vehicle is stopped in an open area with the engine running for more than a short period, adjust the ventilation system to force fresh, outside air into the vehicle.
- Guard against carbon monoxide with proper maintenance. Have the exhaust system inspected every time the vehicle is raised. Have any

abnormal conditions repaired promptly. Until repaired, drive with all side windows fully open.



### WARNING!

California Proposition 65

Operating, servicing and maintaining a passenger vehicle or off-road vehicle can expose you to chemicals including such as, engine exhaust, carbon monoxide, phthalates and lead, that which are know to the State of California to cause cancer and birth defects or other reproductive harm. To minimize exposure, avoid breathing exhaust, do not idle the engine except as necessary, service your vehicle in a well-ventilated area and wear gloves or wash your hands frequently when servicing your vehicle. For more information go to: [www.P65Warnings.ca.gov/passenger-vehicle](http://www.P65Warnings.ca.gov/passenger-vehicle)



## Refueling

### Fuel Filler Neck Access

The fuel filler door is found on the rear, left-hand side of the vehicle. To open the fuel filler door, press button on the left control panel next to the steering wheel.

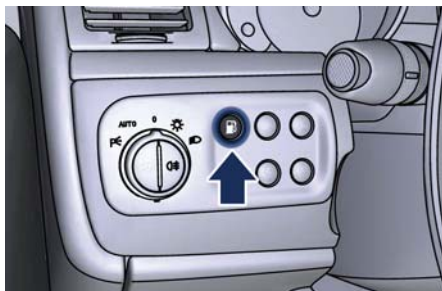

It can be operated only when the key is removed from the ignition switch or turned to **STOP (OFF)** position.

### Refill the Tank

The fuel filler neck is provided with external cap.

- Rotate counterclockwise and remove the fuel filler cap. The cap hermetic seal may result in a slight pressure increase inside the tank. Any hissing noise while the cap is being opened is therefore completely normal. The

cap is linked to the filler neck with a strap, to prevent it from being lost while refueling.

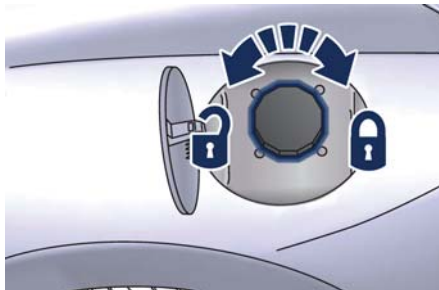

- When refueling, the cap must remain attached to the door by means of the hook provided.

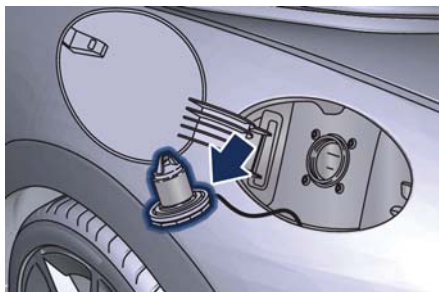

- Insert the fuel nozzle fully into the filler.



### WARNING!

- To avoid the risk of fire, do not approach the filler with open flames or cigarettes!
- To avoid the risk of inhaling noxious fumes, do not breathe close to the fuel filler door, when opened.
- Never have any smoking materials lit in or near the vehicle when the fuel filler door is open or the tank is being filled.
- Never add fuel when the engine is running. This violates most fire-prevention regulations and may cause the  Malfunction Indicator Light (MIL) to turn on (see "Instrument Cluster" in section "Dashboard Instruments and Controls").
- Fill the vehicle with fuel. Fuel tank capacity is indicated in the "Refillings" table in section "Features and Specifications". When the fuel nozzle "clicks" or shuts off, the fuel tank is basically full: it is possible to further ensure refueling by enabling the fuel nozzle additional fuel supply until two clicks. After the two additional clicks,





the amount of fuel allowed by the system is very low, we recommend therefore not to persist further.

- Wait approximately 10 seconds before removing the fuel nozzle in order to ensure completed supply of residual fuel and restrict the risk of fouling the fuel filler door area.
- Remove the fuel nozzle.
- Insert the cap on the fuel filler neck.
- Tighten the cap, turning it clockwise until it stops.
- Close the fuel tank door.



### CAUTION!

To avoid fuel spillage and overfilling, do not “top off” the fuel tank after filling.

## Emergency Fuel Filler Door Release

If you are unable to unlock the fuel filler door using the dedicated button, use the fuel filler door emergency release located in the trunk.

- Open the trunk lid (see “Open and Close the Trunk Lid” in section “Before Starting”).
- Remove the access cover on the left side of the trunk compartment

turning the fastening screw indicated in the picture counterclockwise by a quarter of a turn.



- Pull the release cable moderately to avoid its possible break. It's not possible to feel or hear the unlocking of the fuel filler door actuator.

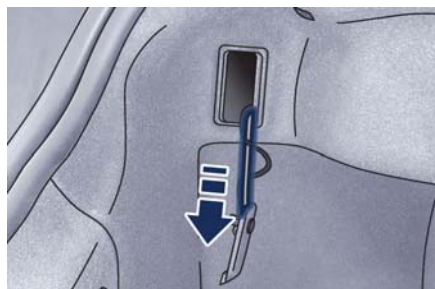

- Then open normally the fuel filler door.

- Reassemble the access cover and lock it by turning the fastening screw clockwise.



### WARNING!

#### California Proposition 65

Operating, servicing and maintaining a passenger vehicle or off-road vehicle can expose you to chemicals including such as, engine exhaust, carbon monoxide, phthalates and lead, that which are known to the State of California to cause cancer and birth defects or other reproductive harm. To minimize exposure, avoid breathing exhaust, do not idle the engine except as necessary, service your vehicle in a well-ventilated area and wear gloves or wash your hands frequently when servicing your vehicle. For more information go to: [www.P65Warnings.ca.gov/passenger-vehicle](http://www.P65Warnings.ca.gov/passenger-vehicle)



## Driving Conditions

### Before the Trip

Check the following at regular intervals and always before long trips:

- tire pressure and condition;
- levels of fluids and lubricants;
- conditions of the windshield wiper blades;
- clean the glass on the external light and all other glass surfaces;
- proper operation of the indicator lights and of the external lights.



#### CAUTION!

It is however advisable to perform these checks at least every 500 mi (800 km) and always following the maintenance schedule reported in section "Maintenance and Care".

Before you drive:

- adjust seat position, steering wheel and rearview mirrors in order to have the best driving position;
- ensure that nothing (mat covers, etc.) is obstructing the pedals movement;
- carefully arrange and secure any objects in the trunk, to prevent them

from moving forward in case of sudden stops;

- avoid heavy meals before a trip. A light snack helps keep your reflexes sharp. In particular, avoid drinking alcohol.



#### WARNING!

**Beyond being prohibited by law, it is extremely dangerous to ride inside the trunk or on the hood. In the event of an accident, passengers sitting here are more exposed to the risk of serious injury. Passengers must only travel seated in the vehicle seats, with the seat belts fastened. Always check that the driver and all passengers have the seat belts correctly fastened.**

### Safe Driving

Although the vehicle is equipped with active and passive safety devices, the driver's conduct is always a decisive factor for road safety.

Some simple rules for traveling safely in different conditions are listed below. Some of them will probably already sound familiar but, in any case, it would be useful to read them carefully.



### Driving at Night

The main guidelines to follow when driving at night are set out below.

- Drive carefully. Night conditions demand more focus and attention.
- Reduce your speed, especially on roads with no streetlights.
- Stop at early signs of drowsiness. Continuing to drive would be a risk for yourself and for others. Have a rest before continuing your trip.
- Keep the vehicle at a greater distance from vehicles in front of you than you would during the day: it is difficult to assess the speed of other vehicles when you only see the lights.
- Use the high beams only outside of densely-populated areas and when you are sure that they will not disturb other drivers.
- When another vehicle is approaching, switch from high beams (if on) to low beams.
- Keep lights and headlights clean.
- Outside of densely-populated areas, beware of animals crossing the road.

### Driving in the Rain

Rain and wet roads are dangerous. On a wet road all maneuvers are more difficult since wheel grip on the



asphalt is significantly reduced. This means that braking distances increase considerably and road grip decreases. Some advices for driving in the rain are listed below.

- Reduce your speed and keep a greater safety distance from the vehicles in front of you. High speed may result in a loss of vehicle control.
- When driving on wet or slushy roads, it is possible for a wedge of water to build up between the tire and road surface. This is known as aquaplaning and may cause partial or complete loss of vehicle control and stopping ability. To reduce this possibility: slow down if the road has standing water or puddles.
- Heavy rain substantially reduces visibility. In these circumstances, even during the day, turn on the low beams, to be more visible to other drivers.
- Set the air conditioning and heating system controls on the defogging function, in order to avoid any visibility problem.
- Periodically check the conditions of the windshield wiper blades.

- In low grip conditions use “ICE” drive mode (see chapters “Drive Mode” in this section).

### Driving in Fog

If the fog is dense, avoid traveling if possible.

When driving in mist, blanket fog or when there is the possibility of banks of fog, please consider some advices listed below.

- Keep a moderate speed.
- Even in daytime, turn on the low beams and rear fog lights. Do not use the high beams.
- Remember that fog creates dampness on the asphalt and thus any type of maneuver is more difficult and braking distances are extended.
- Keep a safe distance from the vehicle in front of you.
- Avoid sudden changes in speed as much as possible.
- Whenever possible, avoid overtaking.
- If you are forced to stop the vehicle (breakdowns, impossibility of proceeding due to poor visibility, etc.), first of all, try to stop off of the travel lane. Then turn on the hazard

warning flashers and, if possible, the low beams.

- Sound the horn rhythmically if you hear another vehicle approaching.
- When you get out of the vehicle, put on the high-visibility vest (if equipped).



### CAUTION!

Be aware that rear fog lights can bother the drivers following your vehicle: when visibility is back to normal, turn off these lights.

### Driving in the Mountains

Mountain roads usually have many narrow turns and curves, tunnels and steep uphill or downhill slopes: please consider some advices listed below.

- Drive at a moderate speed, avoid “cutting” corners.
- When driving inside a tunnel in daylight turn on the low beams in advance; avoid high beams and be aware of the rapid brightness change. Avoid abrupt maneuvers that could be dangerous for the following vehicle.
- Never coast downhill with the engine off or in neutral, and never



with the key removed to the ignition switch.

- Remember that passing other vehicles when driving uphill is slower and thus requires more free distance on the road. If you are being overtaken on a hill, slow down and allow the other vehicle to pass.

## Driving on Snow or Ice

Please consider some general advice for driving in these conditions, listed below.

- Maintain a very moderate speed.
- Fit snow chains or specific tires if the road is covered with snow: see the paragraphs "Tires – General Information" in this section.
- We recommend you to activate the "ICE" drive mode (see chapters "Drive Mode" in this section).
- During the winter season, even apparently dry roads can have icy sections. Be careful when crossing bridges, viaducts and roads that have little exposure to the sun and are bordered by trees and rocks. They may be icy.
- Keep an ample safe distance from the vehicles in front of you.
- Avoid sharp braking, sharp changes in direction and rapid acceleration.

Rapid acceleration on snow covered or icy surfaces may cause the driving wheels to pull erratically to the right or left. This phenomenon occurs when there is a difference in the surface traction under the rear (driving) wheels.



**WARNING!**  
Rapid acceleration on slippery surfaces is dangerous. Unequal traction can cause sudden pulling of the rear driving wheels. You could lose control of the vehicle and possibly have a collision. Accelerate slowly and carefully whenever there is likely to be poor traction (ice, snow, wet mud, loose sand, etc.).

## Driving through Flooded Sections

Driving through more than a centimeters deep shallow standing water section will require extra caution to ensure passenger safety and prevent damage to your vehicle.



**WARNING!**  
Do not drive on or across a road or path where water is flowing and/or rising (as in storm run-off). Flowing water can wear away the road or path surface and cause your vehicle to sink into deeper water. Furthermore, flowing and/or rising water can carry your vehicle away swiftly. Failure to follow this warning may result in injuries that are serious or fatal to you, your passengers, and others around you.

Although your vehicle is capable of driving through shallow standing water, consider the following Caution and Warning before doing so.



- Always check the depth of the standing water before driving through it. Never drive through standing water that is deeper than the bottom of the tire rims mounted on the vehicle.
- Determine the condition of the road or the path that is under water and if there are any obstacles in the way





- before driving through the standing water.
- Do not exceed 5 mph (8 km/h) when driving through standing water. This will minimize wave effects.
- Driving through standing water may cause damage to your vehicle drivetrain components. After driving through standing water, do not drive if you are not sure about drivetrain condition. Such damage is not covered by the New Vehicle Warranty.
- Getting water inside your vehicle engine can cause it to lock up and stall out, and cause serious internal damage to the engine. Such damage is not covered by the New Vehicle Warranty.
- After driving through standing water always have the fluids (engine oil, transmission oil, etc) checked for contamination at an **Authorized Maserati Dealer**.
- **Driving through standing water limits your vehicle braking capabilities, which increases stopping distances. Therefore, after driving through standing water, drive slowly and lightly press on the brake pedal several times to progressively dry the brakes discs and pads.**
- **Getting water inside your vehicle engine can cause it to lock up and stall out.**
- **Failure to follow these warnings may result in injuries that are serious or fatal to you, your passengers, and others around you.**



### WARNING!

- **Driving through standing water limits your vehicle traction capabilities. Do not exceed 5 mph (8 km/h) when driving through standing water.**



## Pollution Control Devices

Even if the vehicle is fitted with antipollution devices, the environment deserves the greatest respect from every one of us.

By following a few simple rules, the driver can avoid damaging the environment and very often can reduce fuel consumption as well. In this regard, some useful information is listed here below; please read it carefully.

- The first precaution is to follow the Scheduled Service Plan scrupulously (see "Scheduled Service Plan" in section "Maintenance and Care").
- The correct operation of the antipollution devices not only helps respect for the environment, but also has an impact on vehicle efficiency. Keeping these devices in good working conditions is the first rule for driving both ecologically sound and economically.
- Always use unleaded fuel.
- If starting is difficult, do not make prolonged attempts. In particular, avoid push starts, towing or downhill starts: these are all maneuvers that can damage the catalytic converters. For any



emergency starting, only use an auxiliary battery.

- While driving, if the engine does not run smoothly, you may continue driving but reducing engine performance to a minimum; you should then contact the **Authorized Maserati Dealer** as soon as possible.
- Never run the engine, even if only for testing, with one or more spark plugs disconnected.
- Do not warm up the engine letting it idle before starting off, except in the event that the external temperature is very low and, even then, for no longer than 30 seconds.

## Catalytic Converter Warnings

During normal operation the catalytic converter produces high temperatures. Failure to comply with following rules can create fire hazards.

- Do not park the vehicle on flammable materials (e.g. grass, dry leaves, pine needles, etc.).
- Do not install heat guards and do not remove those already fitted to the catalytic converter and to the exhaust manifold.
- Do not spray anything on the catalytic converter, Oxygen sensor and exhaust manifold.

In addition to the catalytic converter system, the vehicles are equipped with a system for controlling fuel vapor emissions. This system, called ORVR, has been designed to help reduce atmospheric pollution by the evaporation from the fuel system during the refueling process. Also, specific to these vehicles is the fuel filler neck which comes equipped with a sealed plug that is grounded to avoid possible sparking during re-fueling.



### WARNING!

**California Proposition 65 Operating, servicing and maintaining a passenger vehicle or off-road vehicle can expose you to chemicals including such as, engine exhaust, carbon monoxide, phthalates and lead, that which are know to the State of California to cause cancer and birth defects or other reproductive harm. To minimize exposure, avoid breathing exhaust, do not idle the engine except as necessary, service your vehicle in a well-ventilated area and wear gloves or wash your hands frequently when servicing your vehicle. For more information go to:**

[www.P65Warnings.ca.gov/passenger-vehicle](http://www.P65Warnings.ca.gov/passenger-vehicle)

## Other Tips

- Do not warm up the engine when the vehicle is stationary: in these conditions the engine heats up much more slowly, thus increasing fuel consumption and emissions. It is advisable to move off slowly, avoiding high engine rpm.
- As soon as traffic conditions and the route permit it, use a higher gear.
- Avoid depressing the accelerator repeatedly during stops at traffic lights or before turning off the engine.
- Keep your speed as regular as possible, avoiding unnecessary braking and acceleration, which cause fuel wastage and strongly increase exhaust emissions.
- Turn the engine off if the vehicle remains stationary for a long time.
- Check the tire pressure regularly: if the pressure is too low, fuel consumption increases and the tires are damaged.
- Do not transport unnecessary heavy objects in the trunk compartment.





The weight of the vehicle affects fuel consumption considerably.

- Use the vehicle devices or accessories which absorb electrical power only as long as necessary. The power required increases fuel consumption.







## 6 – In an Emergency

Tool Kit . . . . .	212
Hazard Warning Flashers . . . . .	212
In the Event of an Accident . . . . .	213
Engine Overheating . . . . .	214
In case of a Punctured Tire . . . . .	214
Emergency Release of the Parking Brake . . . . .	220
Transmission Manual Release of P (Park) Position . . . . .	221
Freeing the Stuck Vehicle . . . . .	223
Emergency Starting with Maserati Code . . . . .	224
Auxiliary Jump-Start Procedure . . . . .	225
Towing a Disabled Vehicle . . . . .	228
Fuel Cut-out Inertia Switch . . . . .	229





## Tool Kit

The tool bag and other first aid equipment are located in the trunk compartment and are available by lifting the floor panel.

The tools in the bag are the following:

- 8 + 10 mm open end wrench;
- 13 + 17 mm open end wrench;
- double flat + cross-head screwdriver;
- tow hook;
- tool for electric parking brake actuator release;
- soft top hinge locking/unlocking tool.

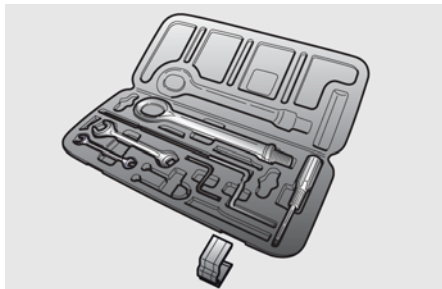

## Hazard Warning Flashers

The hazard warning flashers switch is located in the central console under the A/C controls.

Press the switch to turn on the hazard warning flashers to warn oncoming traffic of an emergency. When these lights illuminate, the turn signals, the related indicator lights on the instrument cluster and the button start flashing.

Press the switch a second time to turn off the hazard warning flashers.

Hazard warning flashers operation does not depend on the position of the key in the ignition switch.

This is an emergency warning system and it should not be used when the vehicle is in motion. Use it when your vehicle is disabled and it is creating a safety hazard for other motorists.

When you must leave the vehicle to seek assistance, the hazard warning flashers will continue to operate even though the key has been removed from the ignition switch.

- The extended use of the hazard warning flashers may wear down your battery.

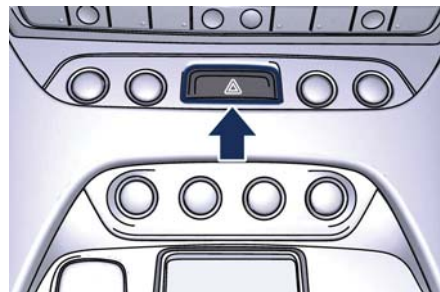

**CAUTION!**

- When the hazard warning flashers are activated, the turn signals control is disabled.



## In the Event of an Accident

It is important always to keep calm.

- If not directly involved, stop at a safe distance of at least 10 yards away from the accident area.
- If on a highway, stop without obstructing the emergency lane and be especially careful if you need to exit the vehicle.
- Turn off the engine and switch on the hazard warning flashers.
- At night, illuminate the accident area with the headlights.
- Always act with caution to avoid the risk of being crashed into by other drivers.
- Indicate that an accident has occurred by placing the emergency triangle (if equipped) in a well visible position and at the prescribed distance.
- Call the emergency services, providing as much information as possible. On the highway, use the special call boxes.
- Remove the ignition key (if present) from the vehicles involved.
- If fuel or other chemical products can be smelled, do not smoke and

ask people around you to put their cigarettes out.

- To extinguish fires, even small ones, use a fire extinguisher, blankets, sand or earth. Never use water.
- In multiple accidents occurred on highways, particularly where visibility is poor, there is a high risk of being involved in other collisions. Leave the vehicle immediately and move away from the area.

### In case of Injured Persons

- Never leave the injured person alone. Persons not directly involved in the accident are also required to give assistance.
- Do not crowd around injured persons.
- Reassure the injured person that help is on the way.



#### **WARNING!**

**California Proposition 65  
Operating, servicing and maintaining  
a passenger vehicle or off-road vehicle  
can expose you to chemicals including  
such as, engine exhaust, carbon  
monoxide, phthalates and lead, that  
which are know to the State of  
California to cause cancer and birth**

**defects or other reproductive harm. To minimize exposure, avoid breathing exhaust, do not idle the engine except as necessary, service your vehicle in a well-ventilated area and wear gloves or wash your hands frequently when servicing your vehicle. For more information go to: [www.P65Warnings.ca.gov/passenger-vehicle](http://www.P65Warnings.ca.gov/passenger-vehicle)**



## Engine Overheating

To reduce potentially overheating of the engine in city traffic, while stationary, place the transmission in N (Neutral), but do not increase the engine idle speed.

### NOTE:

*There are steps that you can take to slow down an impending overheat condition:*

- If your air conditioner (A/C) is on, turn it off. The A/C system adds heat to the engine cooling system and turning the A/C off can help remove this heat.
- You can also turn the temperature control to maximum heat, the mode control to floor and the blower control to high. This allows the heater core to act as a supplement to the radiator and aids in removing heat from the engine cooling system.



### CAUTION!

Driving with a hot cooling system could damage the engine. If the temperature gauge is positioned on the red zone (refer to "Instrument Cluster" in section "Dashboard

Instruments and Controls"), pull over and stop the vehicle. Idle the vehicle with the air conditioner turned off until the temperature gauge drops back into the normal range. If the temperature gauge remains on the red zone turn the engine off immediately and contact the **Authorized Maserati Dealer**.



### WARNING!

**You or others can be badly burned by hot engine coolant (antifreeze) or steam from your radiator. If you see or hear steam coming from under the hood, do not open it until the radiator has had time to cool.**

**Never try to open a coolant bottle pressure cap (refer to "Maintenance Procedures" in section "Maintenance and Care") when the radiator is overheated.**

## In case of a Punctured Tire

The vehicle can be equipped with a tire repair kit or with a compact spare wheel.

### Using Tire Repair Kit

Small punctures up to 1/4" (6 mm) in the tire tread can be sealed using the tire repair kit, fitted beneath the floor panel of the trunk compartment. The kit comes in a bag and consists of two parts:

- an electric compressor with pressure gage, hose to be connected to the punctured tire and power cable;
- a gas cylinder containing sealant.

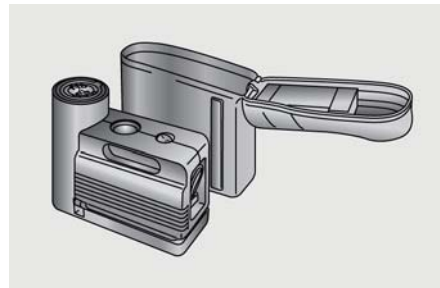

**WARNING!**

California Proposition 65 Operating, servicing and maintaining a passenger vehicle or off-road vehicle can expose you to chemicals including such as, engine exhaust, carbon monoxide, phthalates and lead, that which are know to the State of California to cause cancer and birth defects or other reproductive harm. To minimize exposure, avoid breathing exhaust, do not idle the engine except as necessary, service your vehicle in a well-ventilated area and wear gloves or wash your hands frequently when servicing your vehicle.

**NOTE:**

For the tire repair procedures with tire repair kit see instructions included in the kit.

This kit will provide a temporary tire seal, allowing you to drive your vehicle up to 6 miles (10 km) with a maximum speed of 50 mph (80 km/h).

**CAUTION!**

- Intruding objects (e.g., screws or nails) should not be removed from

the tire, which could compromise the repair with the tire repair kit.

- Do not use the tire repair kit if the tire shows lateral damages and/or the rim is damaged by driving with flat tire.
- Tire repair kit can be used in outside temperatures down to approximately -4°F (-20°C).
- Replace the tire repair kit sealant gas cylinder prior to the expiration date (printed on the gas cylinder label) to assure optimum operation of the system.

**NOTE:**

- The compressor power plug can be inserted either in the 12 V power outlet housed in the trunk or inside the passenger compartment (see “Interior Features” in section “Understanding the Vehicle”).
- When having the tire serviced, advise the **Authorized Maserati Dealer** or service center that the tire has been sealed using the tire repair kit.

## Using the Compact Spare Wheel (for versions/markets where provided)

Upon request, the vehicle may come equipped with a compact spare wheel (emergency wheel), jack and tools for replacing a wheel.

The compact spare wheel is stored in the trunk and housed in a bag: it is supplied deflated in order to limit the amount of space occupied. An electric compressor is also provided for inflating.

The bag covering the compact spare wheel has a side pocket containing the protective bag for the standard wheel that has been removed along with a pair of gloves.

In the event of a tire puncture, proceed as follows.

- Stop the vehicle in a place that does not constitute a danger to traffic and where the wheel can be changed safely. The vehicle must be level and on firm ground.
- Select the P (Park) mode and then engage manually the electric parking brake and turn the key in the ignition switch to **STOP (OFF)** position.





## In an Emergency

- If necessary, turn the hazard warning flashers on and place the warning triangle at the required distance.



### WARNING!

- The jack should be used on level firm ground wherever possible.
- It is recommended that the wheels of the vehicle be chocked, and that no person should remain in a vehicle that is being jacked.
- If the vehicle has been stopped on a slope or an uneven surface, place chocks or other suitable items in front of or behind the wheels to stop the vehicle from moving.
- Never start or run the engine with the vehicle on a jack.
- No person should place any portion of their body under a vehicle that is supported by a jack.
- Take the bag with compact spare wheel and tools out of the trunk compartment and remove it from the bag.

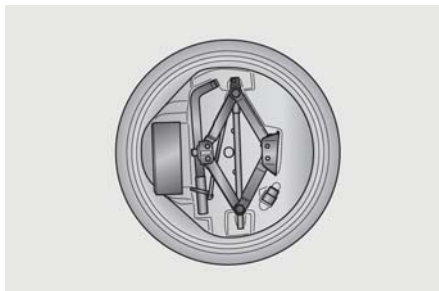

- Remove the bag covering the compact spare wheel.
- Keep locked the knob on the support rod indicated in the picture.

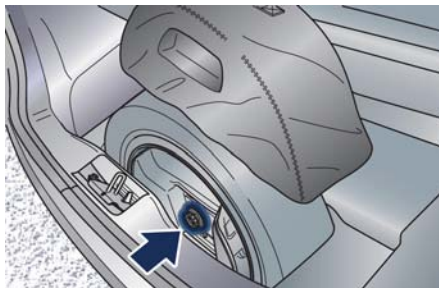

- From the inner side of compact spare wheel, unscrew and remove the knob on the other end of the rod.

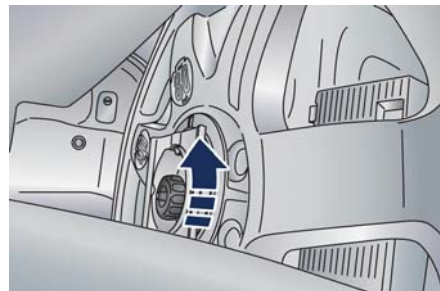

- Pull out the rod slightly to release the compact spare wheel from the internal retaining clamp.
- Remove the entire spare wheel and tools from the trunk compartment.
- Remove the rod completely from the cover.
- Remove the cover by unscrewing the two wing nuts with washer. Both the cover and the plastic support with pins will be freed.

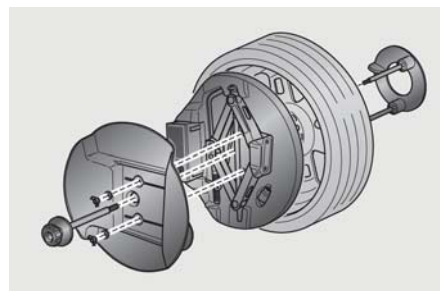



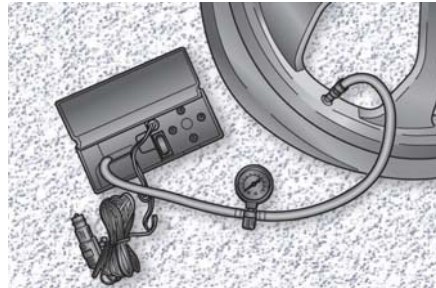

- Remove from the compressor case the inflation hose and the cable with a plug for the power outlet.
- Unscrew the valve cap of the compact spare wheel and screw the fitting of the inflation hose onto the valve.
- Insert the plug in one of the available power outlets fitted in the trunk or passenger compartment.
- Turn the key in the ignition switch in **MAR (ON)** position.
- Turn the compressor on by pressing the switch.
- Stop the compressor pressing switch again, when the pressure indicated by the gage reaches the recommended level (see “Tire Inflation Pressure” in section “Features and Specifications”) and screw the cap on the compact spare wheel valve.

**CAUTION!**

- In order to obtain a more accurate reading, the compressor should be switched off when checking the tire pressure of the compact spare wheel on the pressure gage.
- Do not run the compressor for more than 20 minutes: there is a risk it could overheat. Also, prolonged power absorption may discharge the battery, subsequently preventing the engine from starting.
- The compressor has been designed exclusively to inflate compact spare wheels; do not use it to inflate air mattresses, dinghies etc.
- Fit the adapter on the wrench. Extend the wrench as shown, then loosen by approximately one turn,

the five bolts on the wheel to be changed.

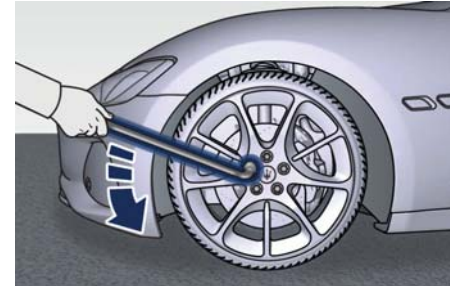

- Open the jack partially, releasing and turning the control lever clockwise.
- Place the jack near the wheel to be changed in one of the indicated positions.
- Make sure that the head of the jack is correctly inserted in one of the slots beneath the sole bar.

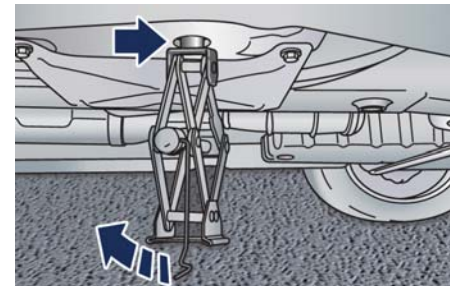



## WARNING!

- Never position yourself under a jacked vehicle.
- The lifted vehicle may fall and damage the vehicle's body if the jack is not positioned correctly.

- Never use the jack to carry out maintenance or repairs under the vehicle.
- Turn the jack lever until the wheel is raised a few centimeters off the ground.
- Completely unscrew the five bolts and remove the wheel. In case a "Wheel Security Stud Bolt" is installed, it can only be removed by

using the specific fitting wrench provided with the "Wheel Security Stud Bolt Kit", available in the Genuine Accessories range.

- Fit the compact spare wheel with the valve stem facing outward, securing it with the five bolts previously removed.
- Turn the lever of the jack to lower the vehicle and remove the jack.
- Fully tighten the bolts, alternately tightening diametrically opposite following the sequence shown in the picture.

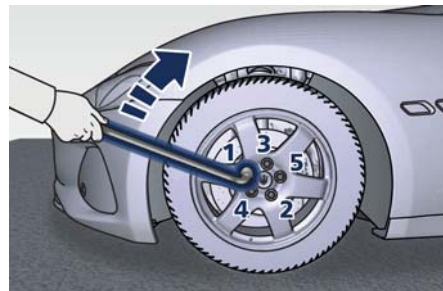
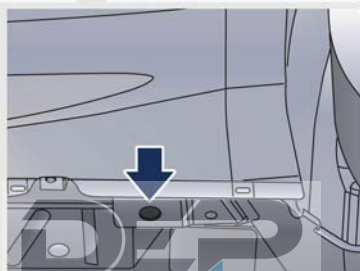
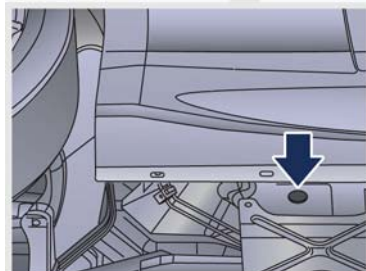
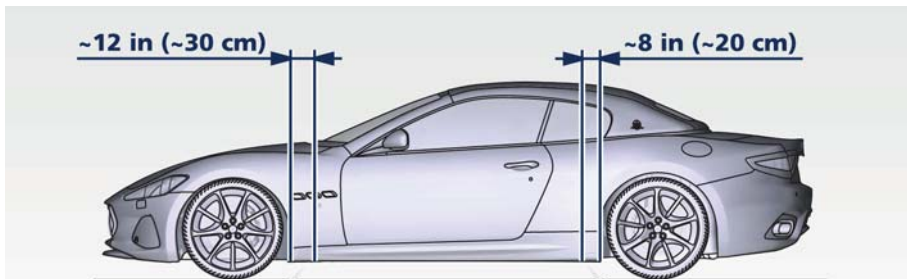

## WARNING!

- Observe the tightening torque for the bolts securing the wheels ( $72 \pm 7$  lbf·ft /  $98 \pm 10$  Nm). This is equivalent to a load of



approximately 44 lb (20 kg) being placed on the handle of the wrench supplied when extended for use.

- After refitting the standard wheel, check the tire pressure.



### WARNING!

- The spare wheel is narrower than standard wheels and must only be used to travel the distance required to reach a service station, where the punctured tire can be repaired or replaced.
- Do not exceed a maximum speed of 50 mph (80 km/h) when using the compact spare wheel; when this limit is exceeded, the stability, road holding and braking of the vehicle will be compromised. Avoid accelerating to full speed, heavy braking and fast cornering.
- The compact spare wheel must be inflated to the recommended tire pressure (see "Tire Inflation Pressure" in section "Features and Specifications").
- For safety reasons, it is absolutely forbidden to drive with more than one compact spare wheel fitted on the vehicle.

- Snow chains cannot be fitted on the compact spare wheel.
- The spare wheel can travel a maximum of 1,800 mi (3,000 km).

### NOTE:

The used wheel may soil the mats if it is housed in the car: insert the used wheel in the protective bag housed in the side pocket of the covering bag.

### To Refit the Standard Wheel with Repaired or Replaced Tire

- Following the procedure and the caution described above, raise the vehicle and remove the compact spare wheel reusing the supplied wrench with adapter, suitably extended.
- Fit the standard wheel with repaired or replaced tire.
- Tighten the original bolts on the wheel.
- Lower the vehicle and remove the jack.
- Fully tighten the bolts, alternately tightening diametrically opposite.

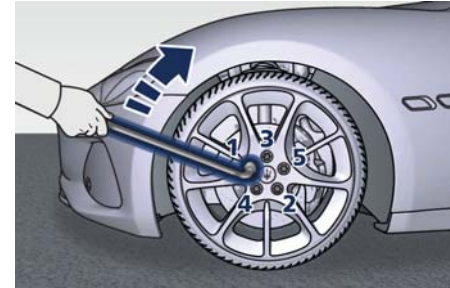

### WARNING!

- Observe the tightening torque for the bolts securing the wheels ( $72 \pm 7$  lb-ft /  $98 \pm 10$  Nm). This is equivalent to a load of approximately 44 lb (20 kg) being placed on the handle of the wrench supplied when extended for use.
- After refitting the standard wheel, check the tire pressure.

Once finished:

- completely deflate the compact spare wheel by pressing on the valve with the overhang of the valve cap;
- wrap the power cable and the inflation hose inside the compressor case;
- place the compressor, the jack, the wrench and the adapter in the



container inside the compact spare wheel;

- using the support with pins, refit the cover, tightening the wing nuts with washer;
- insert the rod with the knob in the cover;

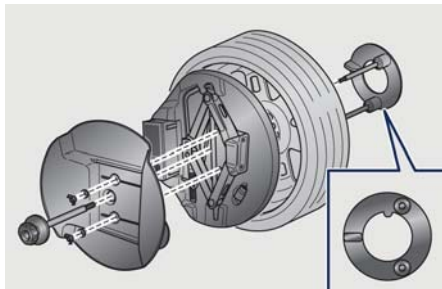

- place the compact spare wheel in the trunk compartment and make sure that the tooth X, on the support with pins, is inserted in the upper opening of the retaining clamp;
- push the rod forward by inserting the threaded end into the vehicle bracket;
- tighten the other knob on the end of the rod;

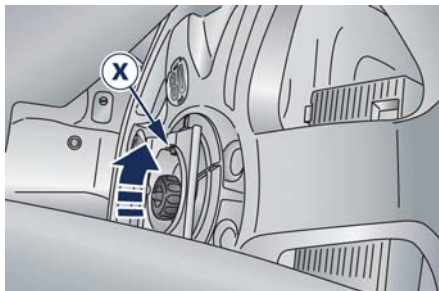

- cover the compact spare wheel with the bag, as shown in the picture.

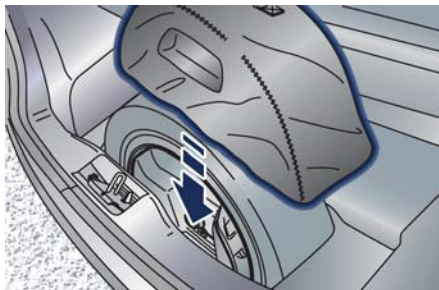

## Emergency Release of the Parking Brake

In the event the electric parking brake locks due to a total system failure (see "Parking Brake" in section "Driving"), it is not possible to move the vehicle, since the thrust action of the brake shoes will lock the rear wheels. For moving the vehicle it is therefore necessary to manually act on the electric actuator to release the pressure of the brake shoes on the rear wheels by performing the following operation.



### CAUTION!

If the parking brake has been activated in manual or automatic mode and it is not possible to release it by operating on the lever of the central console, do not move the vehicle since rear brake calipers might be damaged. If you are not able to perform the following operation, to move the vehicle, load it on a rescue vehicle, avoiding to move it. For more information on vehicle towing, see "Towing a Disabled Vehicle" chapter in this section.



## Manual Release Procedure

To manually release the parking brake, you need to use the special tool provided in the tool kit (see "Tool Kit" in this section).

Proceed as follows:

- remove any luggage and/or the bag containing the compact spare wheel (if equipped) from the trunk compartment;
- remove the floor panel from the trunk compartment;
- remove the inside covering panel from the battery compartment;
- remove the container in the rear part of the trunk compartment unscrewing its fastenings;

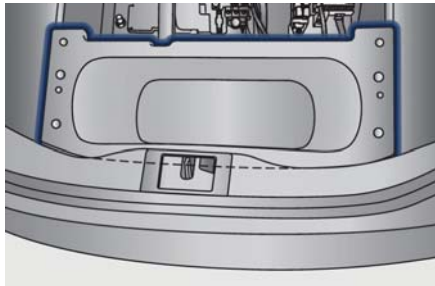

- remove the cap on the right-hand side of the EPB actuator;
- insert the flexible end of the special tool into place;

- turn the special tool handle clockwise until it is released;

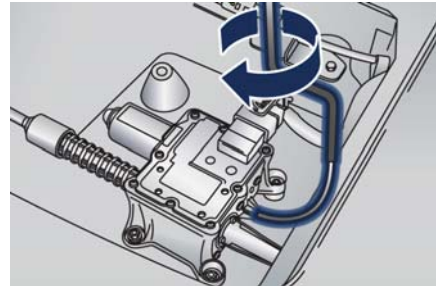

- remove the flexible end of the tool from its seat on the actuator and close it with the cap;
- reinstall the coverings and the equipment removed for the operation.



### WARNING!

After each manual emergency release procedure, the electric parking brake system remains non functioning until the situation is corrected by an Authorized Maserati Dealer.



## Transmission Manual Release of P (Park) Position

The manual disengagement of the shift from P (Park) has the purpose to allow pushing or towing the vehicle if not normally possible using the shift lever (such as in the event of a battery failure with inability to start the engine).

The current procedure is exclusively intended for emergency situations, but not for frequent use.



### WARNING!

Before performing the manual release of P (Park) position, if possible, always secure your vehicle by fully applying the parking brake. Performing this operation will allow your vehicle to roll away if it is not secured by the parking brake. Performing the manual release of P (Park) position on an unsecured vehicle could lead to serious injury or death for those in or around the vehicle.

- Move in the rearmost position the driver's seat.





## In an Emergency

- Detach the covering panel from driver side of the central console levering with a protected tool in the points shown in picture, in correspondence to the retaining pins.
- Remove the covering panel by pulling it toward the rear to release it from the couplings.

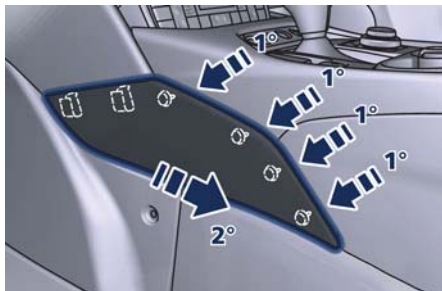

- With a screwdriver with stem along at least 8 in (20 cm), lift the gear display keeping it connected to the vehicle electrical wiring.

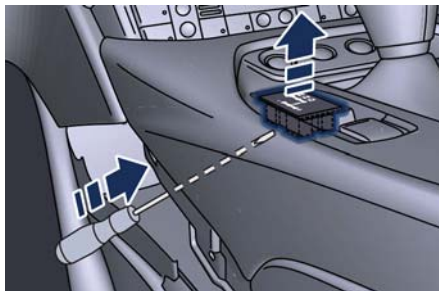

- Using the opening of gear display, pry under the drive mode panel and lift it from the central console. Do not disconnect the drive mode panel to the vehicle electrical wiring.

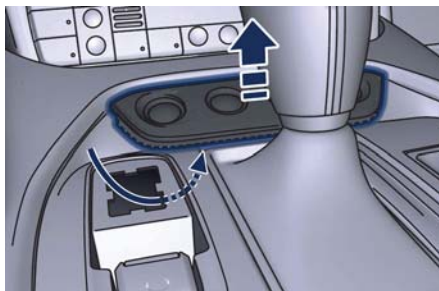

- Using the opening of drive mode panel, pry under the hand control with the hazard button and lift it from the front part of the central console. Do not disconnect the hand control to the vehicle electrical wiring.

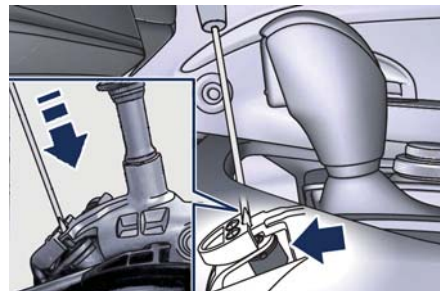

- Through the opening of the hand control, push on the transmission shift lever locking mechanism with the tip of the screwdriver.
- At the same time slightly shift the transmission shift lever toward the N (Neutral) position, in order to free the lever locking mechanism. While moving the transmission shift lever, remember to press the unlock button on the lever.

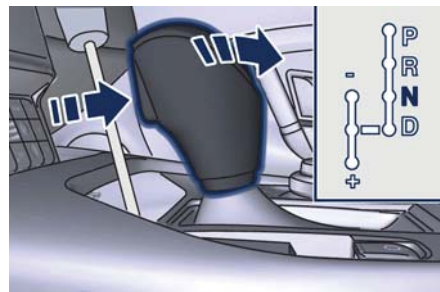



- Remove the screwdriver from the hole, being careful not to move the transmission shift lever.
- Shift the lever fully into N (Neutral). This position will allow vehicle towing.
- Reinstall all the removed electrical parts pushing it in the central console seat until you hear the locking click.
- Reinstall the covering panel on the external side of the central console press it until all pins are engaged in their clips and “click” in place.

**CAUTION!**

Work extremely carefully so as not to damage the central console trim panels.

## Freeing the Stuck Vehicle

If your vehicle is stuck in mud, sand, or snow, it can probably be moved backward and forward by a simple rocking motion.

Steer the wheel right and left to clear the area around the front wheels. Shift then between D (Drive) or MANUAL mode and R (Reverse) (see chapter “Automatic Transmission” and “Drive Mode” in section “Driving”).

Shifting to MANUAL mode, try to free the car starting in second gear.

At low speed motion of the vehicle, you can switch quickly from D (Drive) to R (Reverse), and vice versa, just by pressing the release button on the shift lever.

For more effectiveness press lightly on the accelerator pedal in order to avoid wheel slippage.

If unable to release the vehicle in one of the previously described ways, enter the low-grip driving mode, by pressing the “ICE” button, and completely exclude the yaw and slip control system, by pressing the  (ESC Off) button for at least 2 seconds.

Moving the shift lever between D (Drive) and R (Reverse) to start.

**CAUTION!**

Racing the engine or spinning the drive wheels may lead to transmission overheating and failure. Allow the engine to idle with the shift lever in N (Neutral) for at least one minute after every five rocking-motion cycles. This will minimize overheating and reduce the risk of transmission failure during prolonged efforts to free a stuck vehicle.



**WARNING!**

Fast spinning tires can be dangerous. Forces generated by excessive drive wheel speeds may cause damage, or even failure, of the drivetrain and tires.





## Emergency Starting with Maserati Code

If the Maserati CODE fails to deactivate the engine immobilizer, the  CODE warning light will illuminate permanently, while the  MIL warning light will go off after four seconds and will turn on again immediately afterward: the engine will not start.

To start the engine, follow the emergency starting procedure.

### Emergency Starting Procedure

#### NOTE:





*We recommend that you carefully read the entire procedure before performing it. If you make a mistake, turn the key in the ignition switch to **STOP (OFF)** position and repeat the operations from the first step.*







#### WARNING!

**California Proposition 65**  
Operating, servicing and maintaining a passenger vehicle or off-road vehicle can expose you to chemicals including such as, engine exhaust, carbon monoxide, phthalates and lead, that

which are known to the State of California to cause cancer and birth defects or other reproductive harm. To minimize exposure, avoid breathing exhaust, do not idle the engine except as necessary, service your vehicle in a well-ventilated area and wear gloves or wash your hands frequently when servicing your vehicle. For more information go to: [www.P65Warnings.ca.gov/passenger-vehicle](http://www.P65Warnings.ca.gov/passenger-vehicle)

- Read the 5-digit electronic code found on the CODE card.
- Turn the key in the ignition switch to **MAR (ON)** position: at this moment the  CODE and  MIL warning lights are on.
- Push and hold down the accelerator pedal. Approximately 8 seconds later, the  MIL warning light will go off. Release the accelerator and get ready to count the number of times the  MIL warning light flashes.
- Wait until the number of flashes is equal to the first digit of your CODE card, then push and hold down the accelerator pedal until the  MIL warning light goes off, after about 4 seconds, then release the accelerator pedal.

- The  MIL warning light starts flashing again. As soon as the displayed number of flashing is equal to the second digit of your CODE card, press down the accelerator pedal and hold it.
  - Proceed in the same manner for the remaining digits in the code on the CODE card.
  - When the last digit has been entered, hold the accelerator pedal pushed down. The  MIL warning light comes on for 4 seconds and then goes off; you can now release the accelerator pedal.
  - When the  MIL warning light flashes fast (for about 4 seconds) it confirms that the procedure has been performed correctly.
  - Start the engine by turning the key in the ignition switch from **MAR (ON)** position to **AVV** position.
- If the  MIL warning light remains on, turn the key to **STOP (OFF)** position and repeat the procedure from the first step. This procedure can be repeated an unlimited number of times.



**NOTE:**

After an emergency starting, you should contact an **Authorized Maserati Dealer** as the emergency starting procedure will have to be carried out every time you want to start the engine.

## Auxiliary Jump-Start Procedure

---

If your vehicle has a discharged battery it can be jump-started using a set of jumper cables and a battery of another vehicle or by using a portable battery booster. It is necessary to have proper jumper cables in order to connect the booster battery to the remote posts of the discharged battery. Booster cables have usually positive and negative terminal clamps and are identified by a different sheath color (red = positive, black = negative). Maserati provides on request jumper cables created for its models and content in a practical case.

**NOTE:**

*The Authorized Maserati Dealer can provide you with information about the "Maserati Jumper Cables Kit", available in the "Genuine Accessories" range.*

Jump-starting can be dangerous if done improperly so please follow the procedures in this section carefully.

**NOTE:**

When using a portable battery booster pack, follow the battery manufacturer's operating instructions and precautions.

**CAUTION!**

- To jump start a vehicle do not use a portable battery, a booster pack or any other booster source with a system voltage greater than 14 Volts or damage to the battery, starter motor, alternator or electrical system of the vehicle with the discharged battery may occur.
- Do not use a battery charger for emergency starting under any circumstances. You could damage the electronic systems, particularly the control units managing the ignition and fuel supply functions.
- If the battery is completely discharged when the windows are fully raised, open the door with the utmost care; do not close the door again until it is possible to lower the window.



## **WARNING!**

- Using booster packs that have not been checked, which could therefore release a too high charging voltage (higher than 14 V), in extreme environmental conditions (for example: closed areas or without proper ventilation and temperatures higher than 122°F/50°C or lower than -4°F/-20°C) create the right conditions for ignition which could then cause the battery to explode. Therefore you shall always perform jump-starting operations using the adequate tools and in the best environmental conditions, taking all necessary precautions.
- Do not attempt jump-starting if the discharged battery is frozen. It could rupture or explode during jump start and cause personal injury.
- Do not carry out this procedure if you have not done it before: incorrect maneuvers can originate high electrical discharges and even cause the battery to explode.
- To avoid the risk of explosion or fire, do not approach the battery with

**open flames or cigarettes that could generate sparks.**

### **NOTE:**

*If you need to disconnect the battery from the vehicle electrical system, see "Maintenance - Free Battery" in section "Maintenance and Care".*

## **Access the Battery**

The battery is stored in the trunk.

- Open the trunk lid (see "Open and Close the Trunk Lid" in section "Before Starting").
- Remove any luggage from the trunk compartment.
- Remove the floor panel from the trunk compartment.

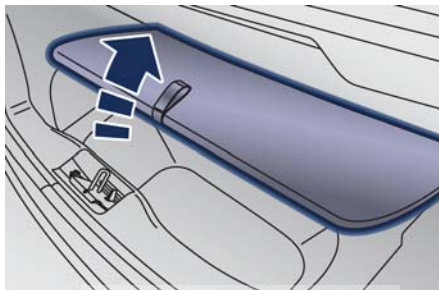

- Remove the inside covering panel from the battery compartment.

Remove the cover from the right side of the battery which protects the positive pole.

## **Jump-Start Procedure**

### **WARNING!**

- The battery is secured to the vehicle with a metal clamp (indicated in the picture), so be extremely careful not to let the clips on the end of the cables come into contact with it.
- Remove any metal jewelry such as watch bands or bracelets that might make an inadvertent electrical contact. You could be seriously injured.
- Do not allow the vehicles involved in the jump-starting operation to touch each other as this could establish a ground connection and cause personal injury.
- Turn off the heater, radio, and all unnecessary electrical accessories.
- Set the parking brake, shift the automatic transmission into P (Park) and turn the key in the ignition switch to **STOP (OFF)** position.
- If using another vehicle to jump start the battery, park the vehicle within



the jumper cables reach and set the parking brake and make sure the ignition is off.

- Connect one terminal clamp of the positive jumper cable to the positive (+) pole of the discharged battery.

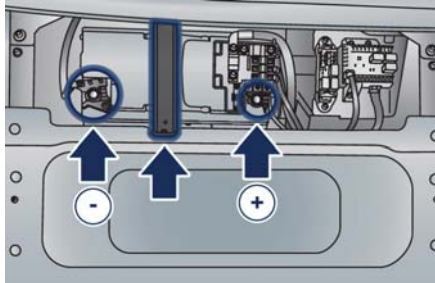

- Connect the opposite terminal clamp of the positive (+) jumper cable to the positive (+) pole of the booster battery.
- Connect one terminal clamp of the negative jumper cable to the negative (-) pole of the booster battery.
- Connect the opposite terminal clamp of the negative (-) jumper cable to the negative (-) pole of the discharged battery.
- Start the engine in the vehicle that has the booster battery, let the engine idle a few minutes, and then start the engine in the vehicle with

the discharged battery. If using a portable battery booster, wait a few seconds after connecting the cables, before starting the booster vehicle. Once the engine is started, remove the jumper cables in the reverse sequence.

- Disconnect the terminal clamp of the negative (-) jumper cable from the negative (-) pole of the discharged battery.
- Disconnect the opposite terminal clamp of the negative jumper cable from the negative (-) pole of the booster battery.
- Disconnect the terminal clamp of the positive (+) jumper cable from the positive (+) pole of the booster battery.
- Disconnect the terminal clamp of the positive jumper cable from the positive (+) pole of the discharged battery.
- After starting the engine of the vehicle with a discharged battery, avoid turning it off immediately because the engine running can help recharge the battery if the latter is not broken and if the charging system is not faulty.

#### NOTE:

*If frequent jump-starting is required to start your vehicle you should have the battery and charging system inspected at an **Authorized Maserati Dealer**.*



#### WARNING!

**California Proposition 65**  
**Operating, servicing and maintaining a passenger vehicle or off-road vehicle can expose you to chemicals including such as, engine exhaust, carbon monoxide, phthalates and lead, that which are know to the State of California to cause cancer and birth defects or other reproductive harm. To minimize exposure, avoid breathing exhaust, do not idle the engine except as necessary, service your vehicle in a well-ventilated area and wear gloves or wash your hands frequently when servicing your vehicle. For more information go to:**  
[www.P65Warnings.ca.gov/passenger-vehicle](http://www.P65Warnings.ca.gov/passenger-vehicle)



## Towing a Disabled Vehicle

Proper towing or lifting equipment is required to prevent damage to your vehicle. Use only towing bars and other equipment designed for the purpose, following equipment manufacturer's instructions.

Safety chains are mandatory. Except for the front threaded seat to fix the supplied hook (see "Tool Kit" chapter in this section), the vehicle is not equipped with other connection points for towing operations with tow truck.



### CAUTION!

Any improper maneuver and use of unsuitable equipment for recovering vehicle in an emergency from off road location could seriously damage the vehicle. Contact the **Authorized Maserati Dealer** or anyone having suitable equipment and the required expertise to safely and properly carry out any required operations.

Make sure you comply with local towing regulations.

- If the vehicle's battery is discharged, it is necessary to shift the automatic transmission out of the P (Park)

Position and release the parking brake (see "Transmission Manual Release of P (Park) position" and "Emergency Release of the Parking Brake" in this section).

- If the vehicle battery is still charged, turn off the engine and disengage the parking brake manually (if automatically engaged) by using the command at the side of the transmission shift lever (see "Parking Brake" chapter in section "Driving"). Shift then manually the transmission out of P (Park) as described in "Transmission Manual Release of P (Park) Position" chapter of this section. If you need to use the accessories (wipers, defrosters, etc.) while being towed, the key in the ignition switch must be turned in **MAR (ON)** position, do not use the **ACC** position.

## Vehicle Towing Conditions

Maserati only allows vehicle towing either on a flatbed or with all four wheels off the ground.

If flatbed equipment is not available, and the transmission is still operable, the vehicle may be flat towed (with all four wheels on the ground) under the following conditions.

- The shift lever must be in N (Neutral).
- The distance to be traveled must not exceed 30 mi (50 km).
- The towing speed must not exceed 30 mph (50 km/h).

If the transmission is not operable, or the vehicle must be towed faster than 30 mph (50 km/h) or farther than 30 mi (50 km) (for example on a highway), tow with the rear driving wheels off the ground and on a platform of a rescue vehicle, or with the rear wheels raised using a wheel lift.



### CAUTION!

If you have to tow the vehicle with 2 wheels raised, ensure that the key in the ignition switch is in the **STOP (OFF)** position. If this is not observed, when the ESC is active, the ECU will store a malfunction and the relative indicator light  will illuminate on the instrument cluster display. This requires the intervention of an **Authorized Maserati Dealer** to reset the system.





## Use the Vehicle Tow Hook of the Tool Kit



### CAUTION!

The tow hook should only be used for towing the car on flat roads. Do not use the tow hook to remove the car that is stuck on off road stretches.

The tow hook can also be used to tow the vehicle on the platform of a tow truck.

It is necessary to inform the operators of the rescue vehicle about the vehicle minimum height to avoid, during its loading, any contact of the lower ends of the front or rear bumper with the tow truck loading ramp.

The tow hook is contained in the tool kit (see "Tool Kit" in this section) and must be screwed in its seat accessible behind the front grille, right-hand side.

- Remove the protective cap by levering with the tip of a screwdriver in the point shown in picture.



- Carefully clean the threaded seat before screwing the hook.
- Screw the tow hook into its seat for at least 11 turns.

### NOTE:

*Maximum work angle of towing cable or bar: 15°.*

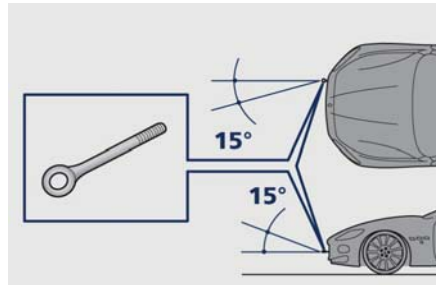

## Fuel Cut-out Inertia Switch

The vehicle is equipped with a safety switch which activates in the event of a collision, cutting off the fuel supply and consequently causing the engine to stop. It also prevents fuel spreading if the fuel lines are damaged during the accident.

Activation of the safety switch is signaled by the illumination of the  warning light on the instrument cluster display.

The switch is positioned underneath the driver seat.

In order to operate the inertia switch, lift the seat in the highest position.



### WARNING!

**After a collision, if you smell fuel or note any leakage from the fuel supply system, do not reactivate the switch in order to prevent any fire risks.**

The activation of the inertia switch causes all the doors and the trunk lid to unlock, the lighting of the internal dome light and the hazard warning flashers.





## WARNING!

California Proposition 65  
Operating, servicing and maintaining a passenger vehicle or off-road vehicle can expose you to chemicals including such as, engine exhaust, carbon monoxide, phthalates and lead, that which are know to the State of California to cause cancer and birth defects or other reproductive harm. To minimize exposure, avoid breathing exhaust, do not idle the engine except as necessary, service your vehicle in a well-ventilated area and wear gloves or wash your hands frequently when servicing your vehicle. For more information go to:  
[www.P65Warnings.ca.gov/passenger-vehicle](http://www.P65Warnings.ca.gov/passenger-vehicle)

## Resetting the Inertia Switch

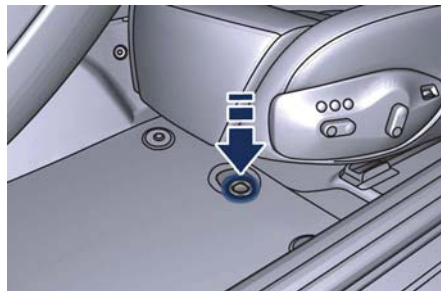
- Turn the key in the ignition switch to **STOP (OFF)** position.
- Check that there is no leakage from the fuel system.
- If no leaks are found, reset the inertia switch which stops the fuel pump operation by pressing button on the switch.



- Turn the key in the ignition switch to **MAR (ON)** position: wait a few seconds and turn it to **ACC** position.
- Check that the  warning light on the instrument cluster display is off.
- Check once again that there are no fuel leaks.

### NOTE:

*After resetting the inertia switch, please contact an **Authorized Maserati Dealer**.*





## **7 – Maintenance and Care**

Scheduled Maintenance Service . . . . .	232
Scheduled Service Plan . . . . .	234
Maintenance Procedures . . . . .	239
Maintenance-Free Battery . . . . .	247
Fuse Replacement . . . . .	251
Bulb Replacement . . . . .	257
A/C System Maintenance . . . . .	262
Wheels Maintenance . . . . .	263
Bodywork Maintenance and Care . . . . .	265
Interior Maintenance and Care . . . . .	268
Vehicle Stored for Long Periods . . . . .	269
Restarting the Vehicle. . . . .	269
Battery Statement . . . . .	270





## Scheduled Maintenance Service

Correct maintenance is clearly the best way to guarantee vehicle performance and safety features, ensure respect for the environment and low operating costs.

### NOTE:

*Also remember that the scrupulous observance of the maintenance procedures is essential for keeping your vehicle operating properly. Not adhering to the "Scheduled Service Plan" can impact your vehicle's warranty.*

## Interval Running Coupons

Maserati has therefore provided for a series of checks and maintenance operations involving the 1<sup>st</sup> service when the vehicle mileage reaches 12500 mi (20000 km) or after 2 years of the vehicle's life, and subsequently every 12500 mi (20000 km) or every 2 years. After the 12<sup>th</sup> service, maintenance must be restarted with the operations scheduled for the 1<sup>st</sup>, 2<sup>nd</sup> and 3<sup>rd</sup> service.



### CAUTION!

The Scheduled Maintenance services are prescribed by the Manufacturer. Failure to have the services carried out can affect your warranty.

The Scheduled Maintenance service is provided by the whole **Authorized Maserati Dealer**. In the event that, when a service is performed, further replacements or repairs are found to be necessary in addition to the scheduled operations, these can be carried out only with the specific consent of the Customer.



### CAUTION!

You are advised to notify the **Authorized Maserati Dealer** of any minor operating problem, without waiting for the next scheduled service.

### NOTE:

- Change your vehicle's oil if it has been 2 years since your last oil change.
- Change your engine oil more often if you drive your vehicle off-road for an extended period of time or short

trips without reaching operation temperature.

- Under no circumstances should oil change intervals exceed 12500 mi (20000 km) or at least after 2 years.



### CAUTION!

Failure to perform the required maintenance items may result in damage to the vehicle.

## Scheduled Maintenance (Service) Indicator

When the deadlines for maintenance Scheduled Maintenance services are approaching, a message on the instrument cluster display indicates that service is due. The deadline may be expressed in miles/Km or days, whichever comes first. The message is displayed only once, upon activating the instrument cluster, at decreasing intervals expressed in mi/km (100, 50..... 1800, 1600,) or in days (27, 24, ..... 6, 3), accompanied by the specific symbol.



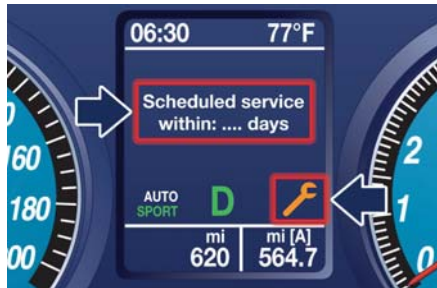

Once the set limit in kilometers or the expiry date is reached, every time the instrument cluster is turned on thereafter, the message "Service coupon expired" will be displayed.

Selecting the function "Service" in the "Trip" menu of the MTC+, you can display the next service deadline (see "Onboard Computer (Trip)" in section "Driving"). The residual mileage left to the service deadline is always indicated. The days remaining before the scheduled service date instead, are only indicated starting from the 511th day (approximately 17 months).

**NOTE:**

*Every time the battery is disconnected, the date and time must be set (see "MTC+ Settings" in section "Dashboard Instruments and Controls").*



**CAUTION!**

- Failure to reset the system may cause it to malfunction and indicate wrong maintenance service intervals.
- If you incorrectly set a date earlier than the last service coupon, the system updates the indication "Scheduled service within... days" automatically entering a later date considering the maximum number of days allowable for the next service coupon.



## Scheduled Service Plan

The Scheduled Maintenance services listed in this chapter must be done within the times or mileages specified to protect your vehicle warranty and ensure the best vehicle performance and reliability.

More frequent maintenance may be needed for vehicles in severe

operating conditions, such as dusty areas and very short trip driving. Inspection and service should also be done anytime a malfunction is suspected.

Maserati recommends that these maintenance intervals be performed at the **Authorized Maserati Dealer**. The

technicians at your dealership know your vehicle best, and have access to factory-approved information, genuine Maserati parts, and specially designed electronic and mechanical tools that can help prevent future costly repairs.

## Main Operations/Service Coupons

Service coupons	1°	2°	3°	4°	5°	6°	7°	8°	9°	10°	11°	12°
<b>Main operations</b>	<b>Maintenance schedules: every 12500 mi (20000 km) or 2 years</b>											
Belt for alternator, air conditioning compressor and hydraulic steering control	I	I*	I	I*	I	I*	I	I*	I	I*	I	I*
<b>Replace at least every 2 years</b>												
Poly-V flexible control belt for water pump	I	I	I	I	R	I	I	I	I	R	I	I
<b>Replace every time the part is removed</b>												
Engine oil and filter	R	R	R	R	R	R	R	R	R	R	R	R
<b>Replace at least every 2 years</b>												
Cooling system connections and lines	I	I*	I*	I*	I*	I*	I*	I*	I*	I*	I*	I*
Air filter	R	R*	R	R*	R	R*	R	R*	R	R*	R	R*
Fuel injection system's connections and lines	I		I*		I		I*		I		I*	
Ignition system: cables and connections	I		I*		I		I*		I		I*	
Spark plugs						R						R
Active carbon filter and Lambda sensors							R					
<b>Replace at least every 4 years</b>												





Service coupons	1°	2°	3°	4°	5°	6°	7°	8°	9°	10°	11°	12°
<b>Main operations</b>	<b>Maintenance schedules: every 12500 mi (20000 km) or 2 years</b>											
Air injection system: connections and pipes valves												
Blow-by system												
Fuel emission control system: lines, connections and valves												
Automatic transmission oil level												
Differential oil level												
Hydraulic steering fluid level (bleed if necessary)												
	<b>Replace at least every 2 years</b>											
Engine coolant level												
	<b>Replace at least every 2 years</b>											
Brake fluid level (bleed if necessary)												
	<b>Replace at least every 2 years</b>											
Brake system: lines, calipers, connections - Efficiency of the dashboard warning lights - Parking brake operation												
Wear condition of the braking parts (rotors, pads); replace if necessary												
Joints for front and rear suspensions, front and rear under-chassis – Tightening torques												
Steering system components, joint protection, rack trunks on the steering levers and on the axle shafts												





Service coupons	1°	2°	3°	4°	5°	6°	7°	8°	9°	10°	11°	12°
<b>Main operations</b>	<b>Maintenance schedules: every 12500 mi (20000 km) or 2 years</b>											
Tightening of screws, nuts and bolts (including those for the exhaust system), connections, retaining clips and clamps	I	I	I	I	I	I	I	I	I	I	I	I
Pollen filter	R	R	R	R	R	R	R	R	R	R	R	R
	<b>Replace every 2 years. In the event that the vehicle is frequently used in dusty or strongly polluted environments, a more frequent replacement is recommended</b>											
Starter motor and alternator: power absorption and charge			I		I		I		I		I	
Vehicle geometry check	I	I	I	I	I	I	I	I	I	I	I	I
Controls and adjustment systems in general, hinges, doors, front and rear lid	I	I	I	I	I	I	I	I	I	I	I	I
Correct operation and reliability of the seats and seat belts	I	I	I	I	I	I	I	I	I	I	I	I
Fastening screws and nuts on the bodywork	I		I		I		I		I	I	I	I
Headlight aiming	I	I	I	I	I	I	I	I	I	I	I	I
Chassis and protected area intactness	I	I	I	I	I	I	I	I	I	I	I	I
	<b>Check every 2 years</b>											
Treatment of the leather interiors and soft top canvas	I		I		I		I		I		I	
Soft top: check operation and sealing strips	I	I	I	I	I	I	I	I	I	I	I	I
Vehicle road test (any time this may be necessary)	I	I	I	I	I	I	I	I	I	I	I	I





Service coupons	1°	2°	3°	4°	5°	6°	7°	8°	9°	10°	11°	12°
<b>Main operations</b>	<b>Maintenance schedules: every 12500 mi (20000 km) or 2 years</b>											
Check with diagnostics system	I	I	I	I	I	I	I	I	I	I	I	I
Update navigation maps with the latest version available	I	I	I	I	I	I	I	I	I	I	I	I
I = Inspect and carry out any other necessary operation A = Adjust R = Replace												

**NOTE:**

All the operations marked with an asterisk (\*) in the "Scheduled Service Plan" are not compulsory but rather recommended, in the event that the vehicle is frequently used in heavy-traffic conditions or on dusty or sandy roads. The warranty concerning emissions and the Manufacturer's responsibility to recall the vehicle in case of problems shall not be invalidated if the Customer does not carry out the operations marked with the asterisk (\*).

**Periodic Maintenance**

Every 300 mi (500 km) or before long journeys

Check:

- engine coolant;
- windshield washer fluid level;

- tire inflation pressure and condition;
- operation of lighting system (headlights, turn signals, hazard warning flashers, etc.);
- operation of windshield washer/wiper system and wear of windshield wiper blades.

**Every 1900 mi (3000 km)**

Check and top up, if required, the engine oil level.



**WARNING!**

**California Proposition 65**  
**Operating, servicing and maintaining a passenger vehicle or off-road vehicle can expose you to chemicals including such as, engine exhaust, carbon monoxide, phthalates and lead, that which are known to the State of California to cause cancer and birth**

**defects or other reproductive harm. To minimize exposure, avoid breathing exhaust, do not idle the engine except as necessary, service your vehicle in a well-ventilated area and wear gloves or wash your hands frequently when servicing your vehicle. For more information go to: [www.P65Warnings.ca.gov/passenger-vehicle](http://www.P65Warnings.ca.gov/passenger-vehicle)**

**Heavy-Duty Vehicle Use**

If the car is mainly used under one of the following conditions:

- dusty roads;
- short, repeated journeys (less than 4-5 mi/7-8 km) at sub-zero outside temperatures;
- engine often idling or driving long distances at low speeds or long periods of idleness;





you should perform the following inspections more frequently than recommended on the "Scheduled Service Plan":

- check front disc brake pad conditions and wear;
- check cleanliness of hood and trunk locks, cleanliness and lubrication of linkage;
- visually inspect conditions of: engine, transmission, pipes and hoses (exhaust - fuel system - brakes) and rubber elements (trunks - sleeves - bushes - etc.);
- check battery charge;
- visually inspect condition of the accessory drive belts;
- check and, if necessary, change engine oil and replace oil filter;
- check and, if necessary, replace pollen filter of the A/C system;
- check and, if necessary, replace air cleaner filter.



### CAUTION!

All maintenance operations for the vehicle must be carried out by the **Authorized Maserati Dealer**. For routine and minor maintenance operations which you can carry out

yourself, make sure that you have the necessary experience and always use suitable equipment, original **Maserati** spare parts (or equivalent) and the prescribed fluids. Shall this not be the case, do not carry any operation on your own and contact an **Authorized Maserati Dealer**.



## Onboard Diagnostic System

Your vehicle is equipped with a sophisticated onboard diagnostic system. This system monitors the performance of the emissions, engine, and automatic transmission control systems. When these systems are operating properly, your vehicle will provide excellent performance and fuel economy, as well as engine emissions suited to current government regulations. If any of these systems require service, the system will turn on the  Malfunction Indicator Light on the instrument cluster display (refer to "Instrument Cluster" in section "Dashboard Instruments and Controls"). The system stores as well diagnostic codes and other information to assist your service technician by performing repairs.

Although the vehicle will be driveable and will not need towing, contact an **Authorized Maserati Dealer** for service as soon as possible.



### CAUTION!

- Prolonged driving with the  MIL on could cause further damage to the emissions control system. It could also affect fuel economy and drivability. The vehicle must be serviced before any emissions tests can be performed.
- If the  MIL is flashing while the engine is running, severe catalytic converter damage and power loss will soon occur. Immediate service at the **Authorized Maserati Dealer** is required.

## Spare Parts

Use of genuine parts for normal or scheduled maintenance and repairs is highly recommended to ensure excellent performance. Damage or failures caused by non-genuine spare parts used for maintenance and repairs will not be covered by the manufacturer's warranty.





## Maintenance Procedures

The following pages contain the “required” maintenance standards determined by Maserati engineers. Besides those maintenance items specified in the “Scheduled Service Plan”, there are other components which may require service or replacement in the future. To perform most of the services, it is necessary to open the hood (see “Open and Close the Hood” in section “Before Starting”). The following images show the position of all components involved in the maintenance service.



### CAUTION!

- Failure to properly maintain your vehicle or perform repairs and service when necessary could result in more costly repairs, damage to other components or negatively impact vehicle performance. Immediately have potential malfunctions examined by an **Authorized Maserati Dealer** or a qualified repair center.
- Your vehicle has been equipped with improved fluids that protect the performance and durability of your

vehicle and also allow extended maintenance intervals. Do not use chemical flushes for washing as the chemicals can damage your engine, transmission, power steering or air conditioning. Such damages are not covered by the New Vehicle Limited Warranty. If a flush is needed because of component malfunction, use only a specific product for the flushing procedure.





### Maintenance Service Components

- 1 Engine oil dipstick.
- 2 Engine oil filler neck.
- 3 Engine coolant expansion reservoir cap.
- 4 Brake fluid reservoir cap.
- 5 Power steering fluid reservoir cap.
- 6 Windshield/headlight washer fluid reservoir cap.

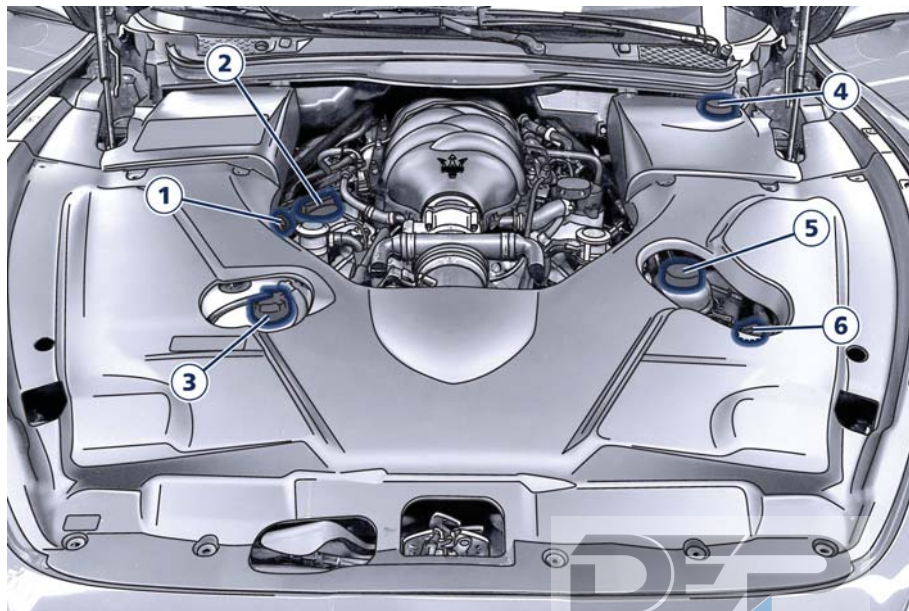

### Level Checks



#### ENVIRONMENTAL!

- The engine oils and fluids used contain substances that are dangerous for the environment. For replacement you are advised to contact an Authorized Maserati Dealer, where all the necessary equipment is available to dispose of the used oil and fluids in compliance with the regulations in force and in an environment-friendly manner.
- All equipment used for fluids replacement (gloves, cloths, containers, etc) must be disposed in compliance with the regulations in force.

### Engine Coolant Level Check

Your vehicle has been equipped with an improved engine coolant (antifreeze) that offers high protection against corrosion, freezing and allows extended maintenance intervals. To prevent reducing extended maintenance periods, it is important to use original engine coolant (antifreeze) when adding coolant throughout the life of your vehicle.



When adding engine coolant (antifreeze) use pure water only, such as distilled or deionized water when mixing the water/engine coolant (antifreeze) solution. The use of impure water will reduce the amount of corrosion protection in the engine cooling system.

- Mix a minimum solution of 50% engine coolant (antifreeze) and distilled water. Use higher concentrations (do not exceed 70%) if temperatures below -35°F (-37°C) are forecast.

Please note that it is the owner's responsibility to maintain the proper level of protection against freezing according to the temperatures occurring in the circulation area of the vehicle.

The coolant tank provides a quick visual method to determine that the coolant level is adequate. As long as the engine operating temperature is satisfactory, the coolant bottle only needs to be checked once a month. With the engine off and cold, the level of the coolant in the tank on the right side of the engine compartment should be between the MIN or MAX reference notches indicated on the tank.

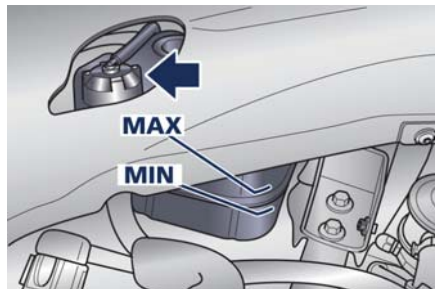

- When additional engine coolant (antifreeze) is needed to maintain the proper level, it should be added to the coolant bottle after removing the cap. Do not overfill.
- Once the desired level is reached, reassemble and firmly close cap of the tank.
- If frequent engine coolant (antifreeze) additions are required, or if the level in the coolant recovery tank does not drop when the engine cools, the cooling system should be pressure-tested for leaks by a **Service Center**
- Keep the front of the radiator and the condenser clean.



#### WARNING!

- **Never add engine coolant (antifreeze) when the engine is hot.**

DEALER ePROCESS

**Do not loosen or remove the cap of the engine coolant bottle to cool a hot engine. Heat causes pressure to build up in the cooling system. To prevent scalding or injury, do not remove the pressure cap while the system is hot or under pressure.**

- **When adding coolant do not use a pressure cap other than the one specified for your vehicle. Personal injury or engine damage may result.**



#### WARNING!

**California Proposition 65**  
Operating, servicing and maintaining a passenger vehicle or off-road vehicle can expose you to chemicals including such as, engine exhaust, carbon monoxide, phthalates and lead, that which are known to the State of California to cause cancer and birth defects or other reproductive harm. To minimize exposure, avoid breathing engine exhaust, do not idle the engine except as necessary, service your vehicle in a well-ventilated area and wear gloves or wash your hands frequently when servicing your vehicle. For more information go to:



(Continued)  
[www.P65Warnings.ca.gov/passenger-vehicle](http://www.P65Warnings.ca.gov/passenger-vehicle)

## Brake Fluid Level Check

Check the fluid level immediately if the brake system **BRAKE** red warning light and the related message turn on indicating a low level of brake fluid.

- Clean the brake fluid reservoir area around the cap before removing it.
- Add fluid to bring the level up to the "MAX" mark on the side of the master cylinder reservoir. Use only manufacturer's recommended brake fluid (see "Refillings" in section "Features and Specifications").

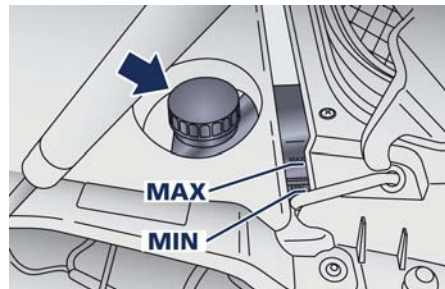

- Once the correct level is reached, firmly close the cap.
- The brake pads wear could cause the fluid level to fall. However, low fluid level may be caused by a leak and a

requires accurate checkup of the braking system.



### CAUTION!

The symbol  on the tank cap identifies the synthetic type of brake fluid, distinguishing it from the mineral type. Using mineral fluids damages the special rubber linings of the brake system irreparably.



### WARNING!

**California Proposition 65**  
Operating, servicing and maintaining a passenger vehicle or off-road vehicle can expose you to chemicals including such as, engine exhaust, carbon monoxide, phthalates and lead, that which are know to the State of California to cause cancer and birth defects or other reproductive harm. To minimize exposure, avoid breathing engine exhaust, do not idle the engine except as necessary, service your vehicle in a well-ventilated area and wear gloves or wash your hands frequently when servicing your vehicle. For more information go to:



[www.P65Warnings.ca.gov/passenger-vehicle](http://www.P65Warnings.ca.gov/passenger-vehicle)



### WARNING!

- To avoid contamination from foreign materials or moisture, use only new brake fluid or fluid that has been in a tightly closed container. Keep the master cylinder reservoir cap secured at all times. Brake fluid in an open container absorbs moisture from the air resulting in a lower boiling point. This may cause it to boil unexpectedly during hard or prolonged braking, resulting in sudden brake failure. This could result in an accident.
- Overfilling the brake fluid reservoir can result in spilling brake fluid on hot engine parts, causing the brake fluid to catch fire. Brake fluid can also damage painted and vinyl surfaces, make sure it does not spill over these surfaces.
- Do not allow petroleum based fluid to contaminate the brake fluid. Brake seal components could be damaged, causing partial or complete brake failure. This could result in an accident.



## Adding Windshield/Headlight Washer Fluid

The reservoir on the left side of the engine compartment contains the fluid to wash the windshield and headlights.

During scheduled services or when the message of low level of the washer fluid appears together with the  related telltale add more fluid as soon as possible.

The fluid reservoir may contain nearly 1.58 US gallons (6 liters) of windshield/headlight washer fluid.

- Remove the reservoir cap in the engine compartment and lift the filler neck extension.

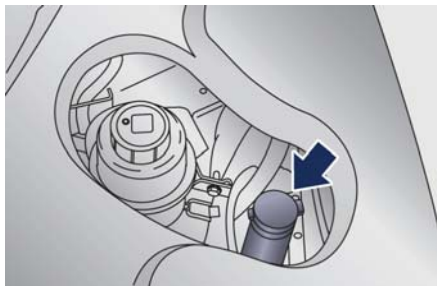

- Fill the reservoir with windshield washer solvent (refer to "Refillings" in section "Features and Specifications") and operate the

system for a few seconds to flush out the residual water.

- When refilling the washer fluid reservoir, apply some washer fluid to a cloth or towel and wipe the wiper blades clean. This will help blade performance.

To prevent freeze-up of your windshield washer system in cold weather, select a solution or mixture that meets or exceeds the temperature range of your climate. This rating information can be found on most washer fluid containers.

### NOTE:

*The Authorized Maserati Dealer can provide you with information about the "Maserati recommended Windshield Washer Fluid" with antifreeze, available in the "Genuine Accessories" range.*



### WARNING!

- **Commercially available windshield washer solvents are flammable. They could ignite and burn you. Care must be exercised when filling or when working around the windshield/headlight washer system.**

- **Do not drive with the windshield/headlight washer reservoir empty: the action of the washer is essential for improving visibility when driving.**



### WARNING!

**California Proposition 65**  
Operating, servicing and maintaining a passenger vehicle or off-road vehicle can expose you to chemicals including such as, engine exhaust, carbon monoxide, phthalates and lead, that which are know to the State of California to cause cancer and birth defects or other reproductive harm. To minimize exposure, avoid breathing exhaust, do not idle the engine except as necessary, service your vehicle in a well-ventilated area and wear gloves or wash your hands frequently when servicing your vehicle. For more information go to:  
[www.P65Warnings.ca.gov/passenger-vehicle](http://www.P65Warnings.ca.gov/passenger-vehicle)

## Engine Oil Level Check

To assure proper lubrication of your vehicle's engine, the engine oil must be maintained at the correct level. If the  warning light illuminates and





the related message of low oil level displays, or during scheduled services (see “Scheduled Maintenance Service” in this section) it is necessary to check the engine oil level.

The vehicle should be parked on level ground to improve the accuracy of the oil level readings.



### CAUTION!

- Do not top up with oil with different characteristics than the engine one (refer to “Refillings” in section “Features and Specifications”).
- Overfilling or underfilling the oil pan will cause aeration or loss of oil pressure. This could damage your engine.
- Do not add any supplemental materials to the engine oil, other than leak detection dyes. Engine oil is an engineered product, and its performance may be impaired by supplemental additives.



### WARNING!

**California Proposition 65**  
Operating, servicing and maintaining a passenger vehicle or off-road vehicle

**can expose you to chemicals including such as, engine exhaust, carbon monoxide, phthalates and lead, that which are know to the State of California to cause cancer and birth defects or other reproductive harm. To minimize exposure, avoid breathing exhaust, do not idle the engine except as necessary, service your vehicle in a well-ventilated area and wear gloves or wash your hands frequently when servicing your vehicle. For more information go to: [www.P65Warnings.ca.gov/passenger-vehicle](http://www.P65Warnings.ca.gov/passenger-vehicle)**

- Start the vehicle and warm it up until the temperature stabilizes.
- Turn off the engine, remove the filler neck cap and wait 5 minutes to allow the oil to flow into the oil pan.

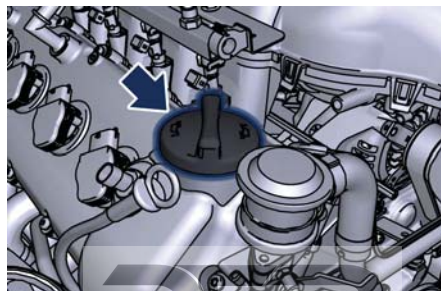

- Remove the dipstick and clean it with a dry and clean cloth.

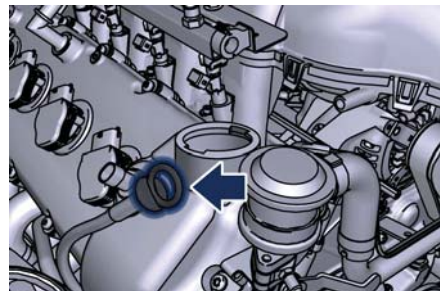

- Re-insert the dipstick completely and remove: the oil level should maintain between the “MIN” and “MAX” reference ranges (SAFE range).

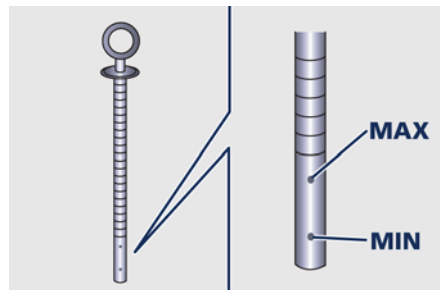

- If a refilling is necessary, adding 0.4 US gallons (1,5 liters ) of oil when the level is at the bottom of the SAFE range will result in the level being at the top of the SAFE range.





- Return the cap and dipstick to their position and wait for a few minutes to allow the oil to reach the oil pan.
- Check the level again.

After topping up, the  engine oil level warning light may not go off for some time while the system is performing the necessary checks. This is normal.

### Engine Oil Filter Replacement

The engine oil filter should be replaced with a new filter at every oil change.

Contact an **Authorized Maserati Dealer** to perform this service.

### Automatic Transmission Oil Check

Contact an **Authorized Maserati Dealer** for the oil level check.

### Power Steering Fluid Level Check

With the vehicle on a level ground and the engine cold, check the fluid level of the power steering reservoir.

- To carry out the check, unscrew the cap, clean the dipstick with a dry and clean cloth.
- Retighten the cap then unscrew it again and check the level: it should match the “MAX” notch marked on the dipstick. In hot oil conditions,

the level may even exceed the “MAX” notch.

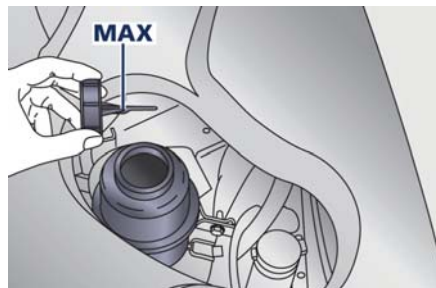

- If necessary, top up with fluid making sure that it has the same characteristics as the one already used in the system (refer to “Refillings” in section “Features and Specifications”).



### CAUTION!

Make sure that the power steering fluid does not come in touch with the engine hot parts as it is flammable.

### Engine Air Filter Replacement

Contact an **Authorized Maserati Dealer** to have the air filters replaced.



## Wiper Maintenance and Blades Replacement



### WARNING!

It is dangerous to operate or service the wiper blades with the wipers in an active position (right multifunction lever in any position different than “OFF”) and with the key in the ignition switch in the MAR (ON) position. The rain sensors may suddenly activate the wipers.

### Windshield Wiper Maintenance

Life expectancy of wiper blades varies depending on the geographical area's weather conditions where the car is used and frequency of use. Poor performance of blades may be present with chattering, marks, water lines or wet spots. If any of these conditions are present, clean the wiper blades or replace if necessary.

Clean the rubber edges of the wiper blades and the windshield periodically with a sponge or soft cloth and a mild nonabrasive cleaner. This will remove accumulations of salt or road film.

Operation of the wipers on dry glass for long periods may cause deterioration of the wiper blades.



Always use washer fluid when using the wipers to remove salt or dirt from a dry windshield.

Avoid using the wiper blades to remove frost or ice from the windshield. Keep the blade rubber out of contact with petroleum products such as engine oil, gasoline, etc.

### Spray nozzles

If the jet does not work, first check that there is fluid in the pan (see paragraph "Level checks" in this section) then check that the nozzles are not clogged.

### Blades Replacement

- Move the right multifunction lever into "OFF" position, (see chapter "Windshield Wipers and Washers" in section "Understanding the Vehicle").
- Lift the end of the arm provided with the blade from the windshield.
- Rotate the blade on the arm in order to access the release latch, shown in the detail of picture.
- Press the release latch to free the blade.
- Turn and slip off the blade from the arm and replace it.

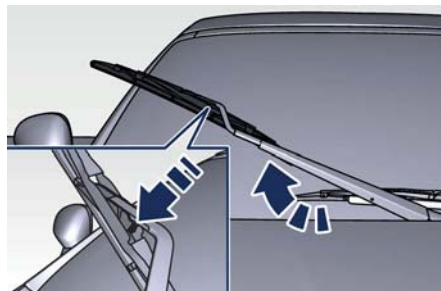

- Return the blade to its original position on the windshield.

### NOTE:

*Due to the difficulty of this operation, we recommend that you contact an **Authorized Maserati Dealer** for replacement of the blades.*

### Body Lubrication

Locks and all body pivot points, including such items as seat tracks, door hinge pivot points and rollers, trunk lid and hood, sliding doors and hood hinges, should be lubricated periodically with a lithium based grease, to assure quiet, easy operation and to protect against rust and wear. Prior to the application of any lubricant, the parts concerned should be wiped clean to remove dust and grit; after lubricating excess oil and

grease should be removed. Particular attention should also be given to hood latching components to ensure proper function. When performing other underhood services, the hood latch, release mechanism and safety catch should be cleaned and lubricated. The coupling pin of the lock on the rear driver door pillar should be lubricated twice a year, preferably in the Fall and Spring. Apply a small amount of high quality lubricant directly into the lock cylinder.



## Maintenance-Free Battery

This vehicle is equipped with a sealed type maintenance-free battery. You will never have to add water, nor is periodic maintenance required.



### WARNING!

- **Battery fluid is a corrosive acid solution and can burn or damage the eyes. Do not allow battery fluid to contact your eyes, skin, or clothing. Do not lean with the face over a battery. If acid splashes in eyes or on skin, flush the area immediately with large amounts of water.**
- **Battery gas is flammable and explosive. Keep flame or sparks away from the battery. Do not use a booster battery or any other booster source with an output greater than 12 Volts. Do not allow cable clamps to touch each other.**
- **Battery posts, terminals, and related accessories contain lead and lead compounds. Wash hands after handling the battery.**
- **The battery in this vehicle has a vent hose that should not be disconnected and should only be**

**replaced with a component of the same type (vented).**

## To Disconnect the Battery

The battery is fitted in the trunk compartment.

To access the battery it is necessary to remove the floor panel of the trunk compartment and the inside covering panel on the battery compartment as already described in the chapter "Auxiliary Jump-Start Procedure" in section "In an Emergency".



### WARNING!

**California Proposition 65 Operating, servicing and maintaining a passenger vehicle or off-road vehicle can expose you to chemicals including such as, engine exhaust, carbon monoxide, phthalates and lead, that which are know to the State of California to cause cancer and birth defects or other reproductive harm. To minimize exposure, avoid breathing exhaust, do not idle the engine except as necessary, service your vehicle in a well-ventilated area and wear gloves or wash your hands frequently when servicing your vehicle. For more information go to:**

**[www.P65Warnings.ca.gov/passenger-vehicle](http://www.P65Warnings.ca.gov/passenger-vehicle)**



### CAUTION!

- **Before disconnecting the battery, open the trunk lid and lower the windows by about 1.6-2 in (4-5 centimeters), to avoid damaging the seal when opening and closing the door. When the battery is connected, this operation is performed automatically when the door is opened and closed. The windows must remain lowered until the charged battery is reconnected.**
- **If you need to disconnect the battery, wait at least 30 seconds from the last seat movement. If disconnecting the battery before, you will have to run the initialization procedure described in the following paragraph "To Reconnect the Battery".**
- **Never disconnect the battery from the electrical system when the engine is running.**
- **To temporarily disconnect the vehicle electrical system from the battery, simply remove the cable end with**



**(Continued)**

quick coupling from the negative pole (-) of the battery.

If the battery needs to be removed from its compartment, you must first detach the terminal clamp from negative pole (-) and then the other terminal clamp from positive pole (+), after removing the protective cover. Battery poles are marked positive (+) and negative (-) and are identified on the battery case.

Remove the metal clamp indicated in the picture and then remove the battery from the trunk compartment.

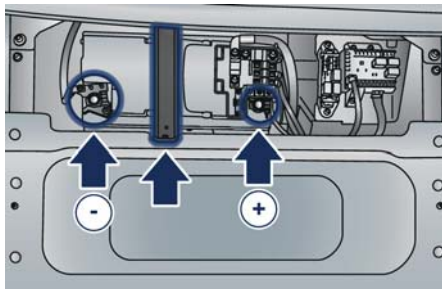

## To Reconnect the Battery

### NOTE:

*When the battery cables have been disconnected and the trunk lid has been locked, it is necessary to pull the emergency release cable in order to re-open it. To access the trunk and operate the emergency release (see "Open and Close the Trunk Lid" chapter in section "Before Starting").*



### CAUTION!

- It is essential when replacing the cables on the battery that the positive cable is precisely attached to the positive pole (+) and the negative cable is attached to the negative pole (-).
- Cable clamps should be tight on the terminal poles and free of corrosion.

After the battery has been disconnected and re-connected and before starting the engine it is necessary to proceed as follows:

- Unlock and lock the doors using the radio control buttons on the key.
- Unlock the trunk lid with the radio control button on the key and then lock it manually.

- Check the seats are working correctly: in the event of malfunction, carry out the initialization operations described in the chapter "Front Seats" of the section "Understanding the Vehicle".
- Initialize the climate control system by activating the compressor as described in chapter "Air Conditioning Controls" of the section "Dashboard Instruments and Controls".
- Turn on the MTC+ and set the date and time (see "MTC+ Setting" in section "Dashboard Instruments and Controls").
- Lift, release and lift again the lever located next the shift lever to initialize the electric parking brakes. In this way the **BRAKE** warning light on the instrument cluster will turn off.



### CAUTION!

- Every time the battery is reconnected, wait at least 30 seconds with the key in the ignition switch turned to **MAR (ON)** position before starting the engine, in order to allow the electronic system that manages the motor-driven throttles to run a



self-learning cycle. At the same time, you can run the date and time set up procedure for the MTC.

- Every time the battery is reconnected the **BRAKE** and **PARK** warning lights will flash for about 10 seconds and then go off.



### WARNING!

**California Proposition 65**  
Operating, servicing and maintaining a passenger vehicle or off-road vehicle can expose you to chemicals including such as, engine exhaust, carbon monoxide, phthalates and lead, that which are know to the State of California to cause cancer and birth defects or other reproductive harm. To minimize exposure, avoid breathing exhaust, do not idle the engine except as necessary, service your vehicle in a well-ventilated area and wear gloves or wash your hands frequently when servicing your vehicle. For more information go to:  
[www.P65Warnings.ca.gov/passenger-vehicle](http://www.P65Warnings.ca.gov/passenger-vehicle)

## Useful Advice to Extend Battery Life

When parking the vehicle, make sure that the doors, front, rear lids and flaps are properly closed. All interior lights should be off.

When the engine is turned off, do not keep the connected devices switched on for a long time (such as radio, hazard warning flashers, fan, etc.).



### CAUTION!

If the battery charge remains below 50% for a long period of time, it will be damaged due to sulfation; its performance and starting power will be reduced and it will be more subject to freezing (this can happen even at 14°F/-10°C).

We recommend you to have the battery charge condition checked, preferably at the beginning of the cold season, to prevent the electrolyte from freezing.

This check should be carried out more frequently if the vehicle is used mainly for short trips or if it is equipped with power absorbing devices that remain permanently on even when the ignition switch is off. This applies

above all if these devices have been retrofitted ("Aftermarket" services). If the vehicle is not used for long periods of time, please see "Vehicle Stored for Long Periods" in this section.

## Battery Recharge



### WARNING!

The process of charging or recharging the battery produces hydrogen, a flammable gas that can explode and cause serious injuries. When charging or recharging the battery, follow the recommended precautions at all times.

- Before using a charger device always check that this tool is suitable for the installed battery, with constant voltage (lower than 14.8 V) and low amperage (maximum limit 15 A).
- Recharge the battery in a well-ventilated environment.
- Never charge or recharge a frozen battery: it can explode due to hydrogen trapped inside the ice crystals.
- Ensure that any sparks or open

(Continued)



*(Continued)*

flames are kept well away from the battery while it is charging.

- Before using a charger to charge or maintain the battery charge status, carefully follow the instructions provided to ensure the charger is connected to the battery safely and correctly.

It is possible to recharge the battery without disconnecting the cables of the vehicle electrical system.

- To access the battery remove the floor panel from the trunk compartment and remove the inside covering panel on the battery compartment as previously shown (see "Auxiliary Jump-Start Procedure" in section "In an Emergency").
- Remove the protection cover and connect the terminal clamp of the charger positive cable (typically in red) to the positive pole (+) of the battery, indicated in the picture.
- Connect the terminal clamp of the charger negative cable (typically in black) to the negative pole (-) of the battery, indicated in the picture.

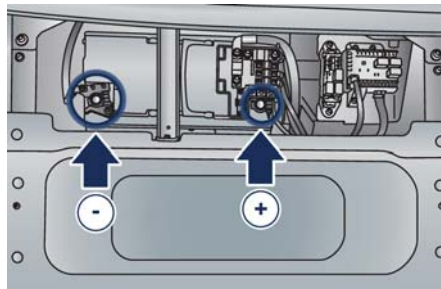

- Turn the charger on and follow the instructions on its user manual to completely recharge the battery.
- When the battery is recharged, turn off the battery charger before disconnecting it from the battery.
- Disconnect first the terminal clamp of the charger black cable from the battery and then the terminal clamp of the red cable.
- Reassemble the protection cover on the battery positive pole and reinstall the components removed for this operation.



**WARNING!**

**California Proposition 65**  
**Operating, servicing and maintaining**  
**a passenger vehicle or off-road vehicle**  
**can expose you to chemicals including**  
**such as, engine exhaust, carbon**

monoxide, phthalates and lead, that which are know to the State of California to cause cancer and birth defects or other reproductive harm. To minimize exposure, avoid breathing exhaust, do not idle the engine except as necessary, service your vehicle in a well-ventilated area and wear gloves or wash your hands frequently when servicing your vehicle. For more information go to:  
[www.P65Warnings.ca.gov/passenger-vehicle](http://www.P65Warnings.ca.gov/passenger-vehicle)



## Fuse Replacement

### Used Fuses Characteristics

When an electrical device is not functioning, check that the corresponding fuse is in proper working order (intact).

- A Fuse intact
- B Fuse blown

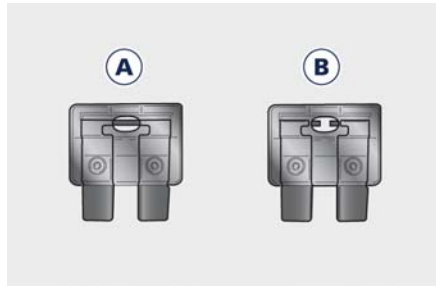

Replace the faulty fuse with a new one featuring the same rating, by using appropriate forceps.

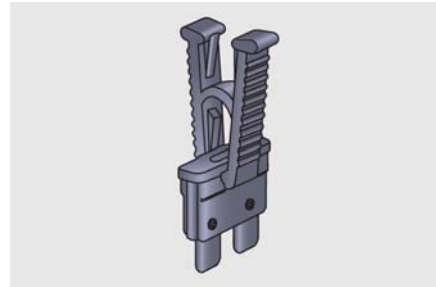

The color identifies the value of the fuses in amperes which is also reported on them.

The vehicle is endowed with mini- and maxi-fuses.

The table shows the match between color and amperage of mini and maxi fuses.

Type	
Mini Fuse	Maxi Fuse
Beige - 5	Yellow - 20
Brown - 7.5	Green - 30
Red - 10	Orange - 40
Blue - 15	Red - 50
Yellow - 20	Blue - 60
White - 25	
Green - 30	



### CAUTION!

- Never replace a blown fuse with anything other than a new and suitable fuse (same rating).
- After replacing a fuse, if the fault recurs, contact an **Authorized Maserati Dealer**.

### Position of Fuses

The fuses are located in three parts of the vehicle, namely:

- On the right hand side of the engine compartment.
- Behind the glove compartment, to the left of the steering wheel.
- In the trunk compartment next to the battery.

### Fuses Inside Engine Compartment

- To access the fuses, lift the hood and remove the covering panel.



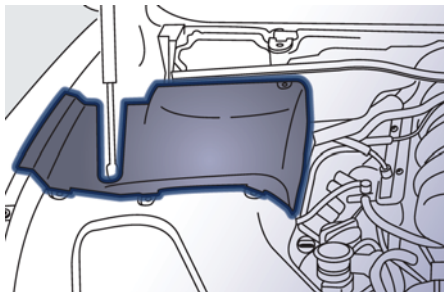

- Undo the four retaining screws and remove the cover.

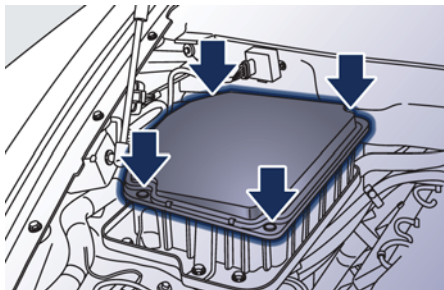

The fuses are housed in three control boxes.

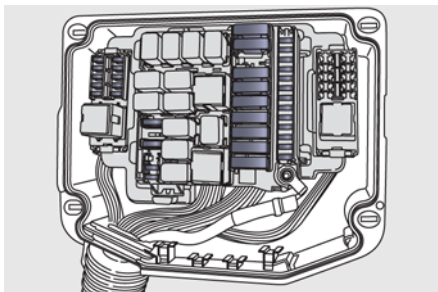

The following table points out the position as featured in the picture, the type and function of the fuses included in these control boxes.



### CAUTION!

If you need to wash the engine compartment, do not direct the jet of water for too long directly on the engine compartment ECU.

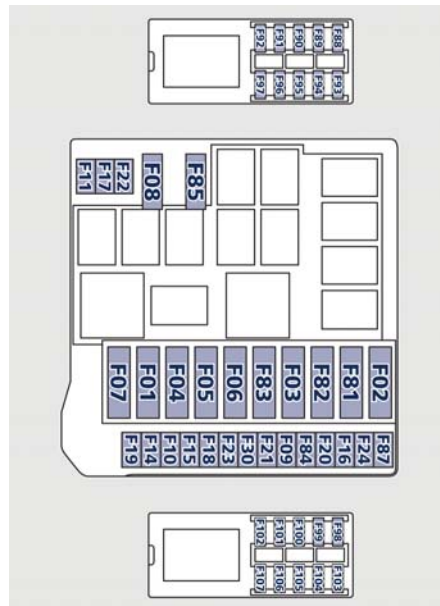

### Engine Compartment Fuses

Pos.	Amp. – Color	System / Component
F01	Maxi 60 A – Blue	Fan 1 relay
F02	Maxi 30 A – Green	ABS valves
F03	Maxi 20 A – Yellow	T03 spot lights relay



Pos.	Amp. – Color	System / Component
F04	Maxi 40 A – Orange	ABS cylinder
F05	Maxi 40 A – Orange	A.C. Node
F06	Maxi 60 A – Blue	Fan 2 relay
F07	30 A – Green	T07 I.E. main relay
F08	7.5 A – Brown	T08 - Air conditioner compressor relay
F09	7.5 A – Brown	T05 stop light control relay
F10	15 A – Blue	T06 horn relay
F11	10 A – Red	LH high-beam
F14	7.5 A – Brown	Third stop
F15	15 A – Blue	Alternator sensing
F16	10 A – Red	LH spot light
F17	10 A – Red	RH high-beam
F18	7.5 A – Brown	I.E. bank
F19	7.5 A – Blue	T02 DRL lights relay

Pos.	Amp. – Color	System / Component
F20	10 A – Red	T17 Key lock solenoid relay
F21	-	Not used
F22	-	Not used
F23	10 A – Red	ABS Electronics
F24	10 A – Red	RH spot light
F30	30 A – Green	T20 ignition relay
F81	Maxi 50 A – Red	CPL2
F82	-	Not used
F83	Maxi 50 A – Red	Air pump relay
F84	20 A – Yellow	Ignition switch.
F85	30 A – Green	Headlight washers
F87	-	Not used
F88	15 A – Blue	Main injector/coil relay - cylinders 1-4
F89	15 A – Blue	Main injector/coil relay - cylinders 5-8

Pos.	Amp. – Color	System / Component
F90	15 A – Blue	Main I.E. relay, secondary connected devices
F91	10 A – Red	Main relay, I.E. ECU
F92	15 A – Blue	Main relay, oxygen sensors
F93	-	Not used
F94	7.5 A – Brown	NCS
F95	7.5 A – Brown	CSG
F96	7.5 A – Brown	Alternator
F97	10 A – Red	I.E. ECU
F98	-	Not used
F99	-	Not used
F100	-	Not used
F101	-	Not used
F102	-	Not used
F103	-	Not used
F104	-	Not used
F105	-	Not used
F106	-	Not used



Pos.	Amp. – Color	System / Component
F107	-	Not used

## Fuses in Passenger Compartment

- To access the fuses lift the guard on the left side of the steering wheel.



The fuses are housed in two control boxes.

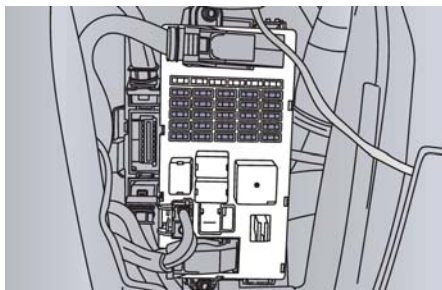

The following table points out the position as featured in the picture, the type and function of the fuses included in these control boxes.

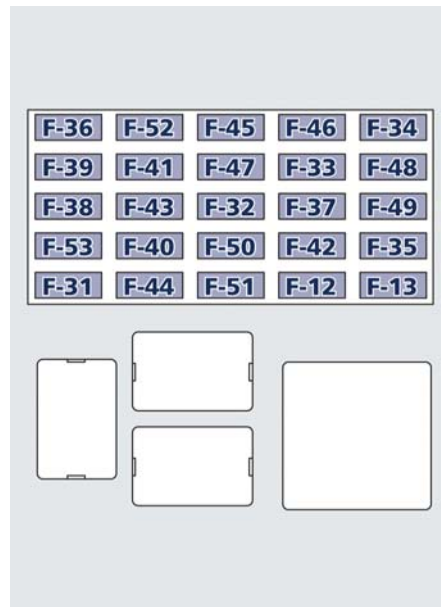

## Passenger Compartment Fuses

Pos.	Amp. – Color	System / Component
F12	15 A – Blue	Right-hand low beam
F13	15 A – Blue	Left-hand low beam
F31	7.5 A – Brown	A/C unit, NBC (Body Computer Node), high beam relay
F32	10 A – Red	Domelights, step lights, CAV, driver- and passenger-side footwell lights, outside mirror lights
F33	30 A – Green	Driver's seat (movement)
F34	30 A – Green	Passenger's seat (movement)
F35	7.5 A – Brown	ACC, FN and LF relay coil
F36	10 A – Red	NQS
F37	10 A – Red	NQS (Instrument Cluster Node), CPP, CPD
F38	15 A – Blue	Rear lid lock



Pos.	Amp. – Color	System / Component
F39	15 A – Blue	NIM (Inside Roof Node), NCL (Air conditioning and heating system node), OBD socket, CSA (Alarm system siren ECU), CAV (Motion sensing alarm ECU), radio, NAVTRAK
F40	30 A – Green	Heated rear window
F41	-	Not used
F42	7.5 A – Brown	NCL and windshield wiper control
F43	30 A – Green	Windshield wiper/washer (Connected Devices Relay INT/A)
F44	20 A – Yellow	Front and rear power outlets (INT/A device relay) front seat heating (passenger side)
F45	-	Not used
F46	20 A – Yellow	NPG/NPP locks

Pos.	Amp. – Color	System / Component
F47	30 A – Green	NPG (Driver's door node)
F48	30 A – Green	NPP (Passenger's door node)
F49	7.5 A – Brown	NVO (Steering wheel node), CSG (Power steering ECU), CSP (Twilight/rain sensor ECU), NIM (Inside Roof Node), NCL, Radio, CEM, CRP, domelight molding, NAVTRAK
F50	7.5 A – Brown	Air bag system
F51	7.5 A – Brown	NCA (Automatic Gearbox Node)
F52	15 A – Blue	Front seat heating (driver side) (INT/A device relay)
F53	10 A – Red	Rear fog lights

### Fuses in Trunk Compartment

- To access the fuses, remove the floor panel.

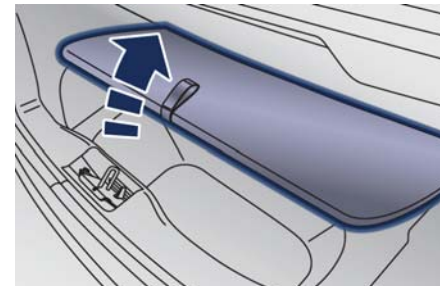

- Remove the inside covering panel of the battery compartment. There are two control boxes.

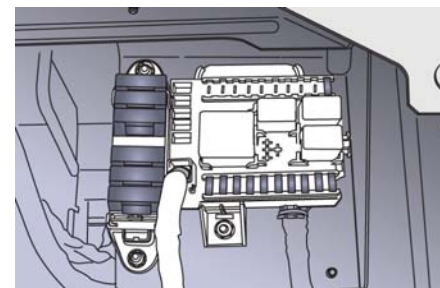

- To access the fuses inside the control boxes, remove the covers by levering up the fastening tabs.

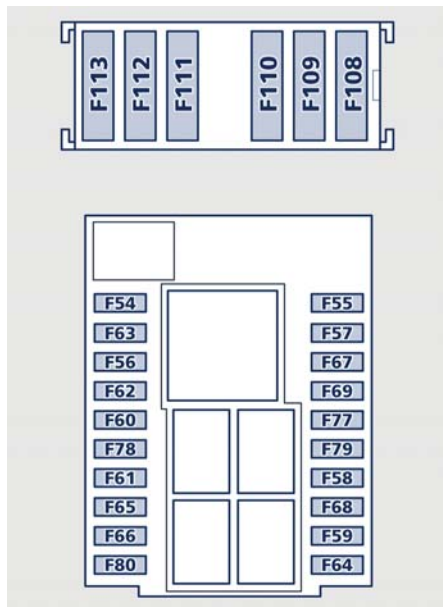

The following table points out the position as featured in the picture, the type and function of the fuses included in these control boxes.



## Trunk Compartment Fuses

Pos.	Amp. – Color	System / Component
F54	30 A – Green	HI-Fi amplifier
F55	7.5 A – Brown	Lights
F56	10 A – Red	+30 NAG, NAVTRAK, Harman tuner, MTC+ (Japan)
F57	-	Not used
F58	7.5 A – Brown	Reverse
F59	15 A – Blue	Fuel tank door power supply from T22
F60	7.5 A – Brown	NSP
F61	20 A – Yellow	Rear RH ACE
F62	20 A – Yellow	NCA
F63	15 A – Blue	+30 battery charge
F64	-	Not used
F65	20 A – Yellow	Rear LH ACE

Pos.	Amp. – Color	System / Component
F66	20 A – Yellow	Fuel pumps
F67	-	Not used
F68	-	Not used
F69	-	Not used
F77	-	Not used
F78	20 A – Yellow	Power outlet
F79	-	Not used
F80	30 A – Green	Bass box
F108	40 A – Orange	+30 NCP hydraulic pump
F109	40 A – Orange	+30 NCP ECU/front latch
F110	-	Not used
F111	-	Not used
F112	-	Not used
F113	-	Not used



## Bulb Replacement

The signal failure of an external light (turn signal, low beam and high beam, license plate light, reverse light, brake light and rear fog light) is communicated to the instrument cluster that displays on the TFT screen the  or  amber warning light and a text message indicating which light is faulty.

### Front Headlights

The light bulbs of the headlight clusters are arranged as follows:

- 1 Bi-Xenon low-beam/high-beam bulb.
- 2 Position light and DRL (\*) LED.
- 3 Turn signal light bulb.
- 4 FTP bulb, headlight flashing.
- 5 Side marker bulb.

(\*) On vehicles for the Canadian market DRL are always enabled.

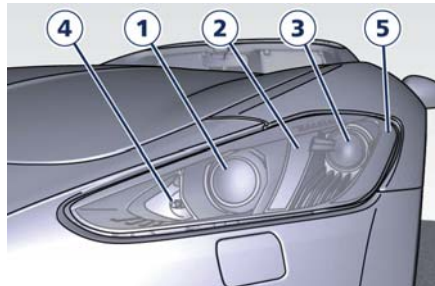

### Tail-Light Clusters Light Bulbs

The taillight bulbs are arranged as follows:

- 1 Position light guide LED.
- 2 Stop light LED.
- 3 Turn signal LED.
- 4 Reverse light bulb.
- 5 Rear fog light bulb.



#### CAUTION!

Due to the complexity of the operation, for the replacement of the headlight clusters light bulbs, we recommend that you contact an **Authorized Maserati Dealer**.



#### WARNING!

The headlamps are a type of high voltage discharge tube. High voltage can remain in the circuit even with the headlamp switch and the ignition switch off. Because of this, you should not attempt to replace a headlamp bulb yourself, but take the vehicle to an **Authorized Maserati Dealer** for service.

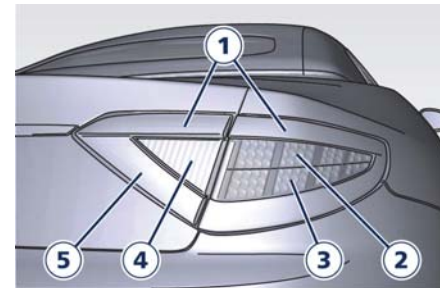

### Tail-Light Clusters Bulbs Replacement

Most of the lamps of the taillight are LED powered and cannot be replaced individually. The only exceptions are the reverse and the rear fog light bulbs for which you find below the replacement procedure.

Contact an **Authorized Maserati Dealer** to locate the correct parts and replace them.





### Reverse and Rear Fog Light

To replace a bulb of these lights:

- Lift the trunk compartment lid.
- Remove the panel from the trunk lid.
- Rotate the bulb holder counterclockwise and slide it out of the light cluster.
- Remove the bulb by gently pushing it and rotating it counterclockwise.

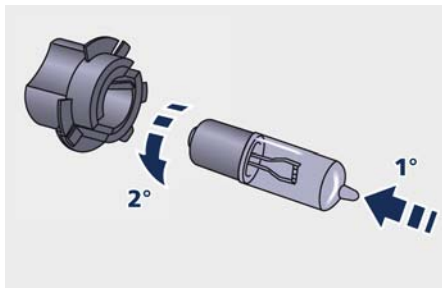

- Insert the new bulb in the holder by slightly pushing it and rotating it clockwise.
- Insert the bulb holder in the light cluster and rotate it clockwise.
- Close the door on the covering panel.

### Side Turn Signal Light (Sport version)

To replace the side turn signal light bulb (5W) on the rear part of the front mudguard:

- Push the turn signal forward to compress the retaining spring clip.
- Take out the rear part of the turn signal by releasing the retaining tab and remove the unit.



- Remove the bulb holder from the turn signal lens turning it counterclockwise.

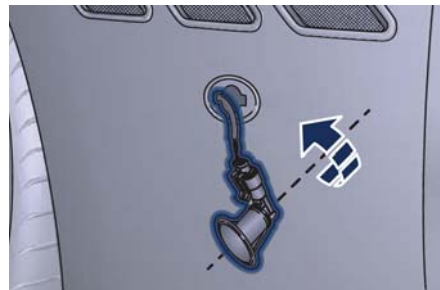

- Extract the bulb from the holder by turning it clockwise.
- Replace the bulb.



- Refit the bulb holder in the turn signal lens turning it clockwise.
- Refit the turn signal in the seat of the mudguard, inserting first the retaining tab on the rear part of the turn signal lens.





- Press the front part of the turn signal lens until hearing the spring clip click into position.

**CAUTION!**

Proceed with care when removing the side turn signal light to avoid damaging to the vehicle body or the turn signal itself.

### Side Turn Signal Lights (MC version)

To replace side turn signal light bulb (5W) on the rear part of the front mudguard:

- Gently pry the turn signal light off the vehicle body by levering with a non-metal tool under the rubber part.

**CAUTION!**

Proceed with care when removing side turn signal light to avoid damaging the vehicle body or to the turn signal itself.

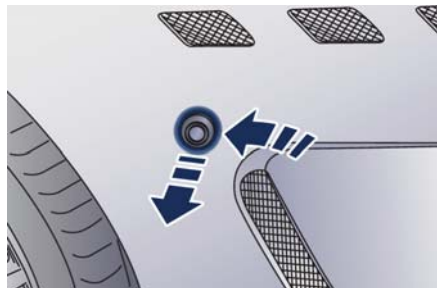

- Pull turn signal light off its seat enough to gain access to bulb holder cap.
- Separate the outer lens along with the rubber mount from the bulb holder cap.



- Pull back the bulb holder cap and remove the bulb by turning it counterclockwise while pulling it off the bulb holder seat.



- Replace the bulb.
- Fit the new bulb to the bulb holder by pushing it into cap while turning it clockwise.
- Fit the cap over the bulb holder and assemble with the turn signal light.
- Push the turn signal light into place until firmly seated against the body.

### Third Stop Light

In order to replace the bulb, the light cluster must be removed. To perform this operation, it is therefore recommended that you contact an **Authorized Maserati Dealer**.



## License Plate Lights

To replace the license plate light bulb (C 5W):

- Undo the two fastening screws for the lens/bulb holder unit.
- Remove the unit from the trunk lid and replace the bulb.

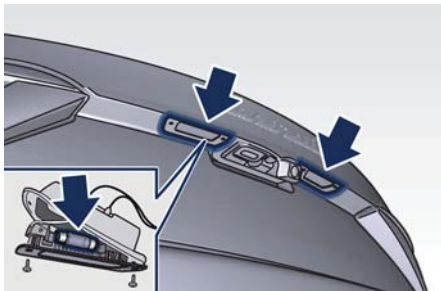

## Interior Lights



### CAUTION!

Before replacing a bulb, ensure that the matching fuse is intact. For replacement, use only original new light bulbs having the same rating as the old one.

## Courtesy Lights (below Door)

To replace the bulb (W5W):

- use a screwdriver positioned at the indicated point to lever out the light fixing frame;



- rotate the bulb holder and take it out;

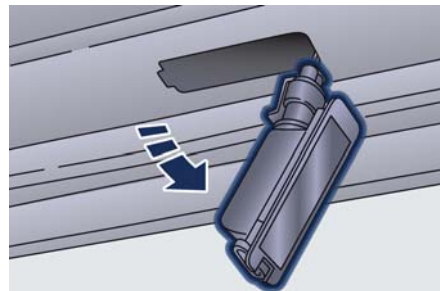

- replace the pressure-fitted bulb;

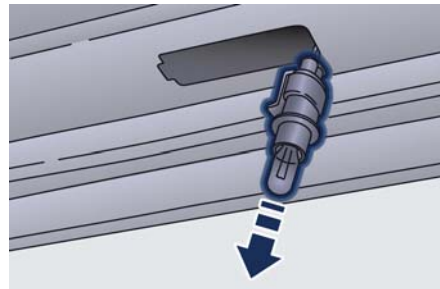

- refit the bulb holder inserting first the electrical connector side and then pressing on the other side to hook up the clip.

## Front Domelight

To replace the light bulbs:

- Gently pry with a screwdriver at points indicated in picture and remove the molding.

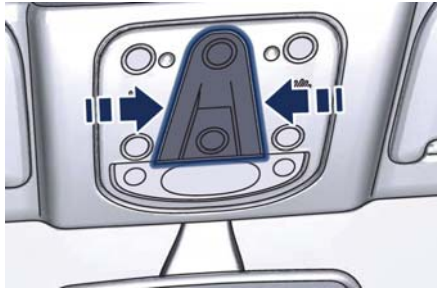

- Undo the three screws just uncovered (indicated in picture) and take out the domelight.
- Replace the timed or reading light bulb by rotating it.



- Refit the domelight following performing the operations opposite to those outlined above and in reverse order.

**CAUTION!**

When refitting the domelight, make sure that the electric wires are correctly positioned and do not interfere with the domelight edges and with the retaining tabs.

**Courtesy Mirror Light**

To replace the bulb (12V - 5W "torpedo" type):

- Remove the fixing frame from the sun visor by levering it out gently at points indicated in picture.

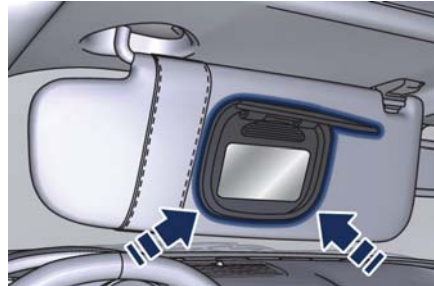

- Replace the bulb located on the back of the mirror frame.
- Refit the fixing frame by pressing it on the sun visor.

**Trunk Compartment Light**

To replace the bulb (W5W) inside the trunk compartment, proceed as follows after trunk lid opening.

- Remove the light fixing frame by levering it out gently at the indicated point with a screwdriver.

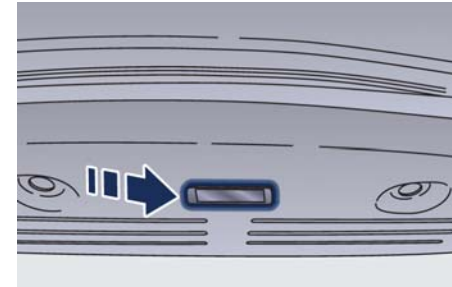

- Raise the lens cover.

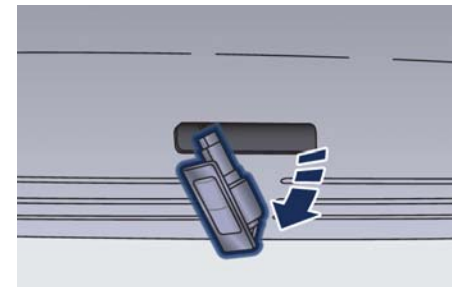

- Replace the pressure-fitted bulb.



- Refit the lens cover, inserting first the electrical connector side and then pressing on the other side.

### A/C System Maintenance

For the best performance, the air conditioning system should be checked and serviced by an **Authorized Maserati Dealer** at the beginning of the warm season.

This service should include cleaning of the condenser, check of the drive belt tension and a performance test. During the winter, the air conditioning system should be operated at least once a month for about 10 minutes.



#### CAUTION!

Do not use chemical flushes in your air conditioning system as the chemicals can damage your air conditioning components. Such damage is not covered by the New Vehicle Limited Warranty.



#### WARNING!

California Proposition 65 Operating, servicing and maintaining a passenger vehicle or off-road vehicle can expose you to chemicals including such as, engine exhaust, carbon monoxide, phthalates and lead, that which are know to the State of

California to cause cancer and birth defects or other reproductive harm. To minimize exposure, avoid breathing exhaust, do not idle the engine except as necessary, service your vehicle in a well-ventilated area and wear gloves or wash your hands frequently when servicing your vehicle. For more information go to: [www.P65Warnings.ca.gov/passenger-vehicle](http://www.P65Warnings.ca.gov/passenger-vehicle)



#### WARNING!

- Use only refrigerants and compressor lubricants approved by the manufacturer for your air conditioning system. Some refrigerants are flammable and can explode, causing injuries. Other unapproved refrigerants or lubricants can cause the system to fail, requiring costly repairs.
- The air conditioning system contains refrigerant under high pressure. To avoid risk of personal injury or damage to the system, adding refrigerant or any repair requiring lines to be disconnected should be done by an experienced technician.



Periodically remove any leaves and insects that may build up and obstruct the inlet of external air in the air conditioning system through the grille present underneath the rear part of the hood.

To access the grille, lift the hood as described in “Open and Close the Hood” in section “Before Starting”.

## A/C Air Filter Replacement

This filter performs mechanic/ electrostatic air filtering, provided that windows and doors are perfectly closed.

Have your filter replaced at least once a year at an **Authorized Maserati Dealer**, preferably at the beginning of the summer period.

If the vehicle is mainly used in the city traffic, on highways or dusty roads, we recommend that you replace the filters more frequently than prescribed in the "Scheduled Service Plan" of this section.



### CAUTION!

Failure to replace the filter may considerably reduce the air conditioning and heating system efficiency.



### WARNING!

**California Proposition 65**  
**Operating, servicing and maintaining a passenger vehicle or off-road vehicle can expose you to chemicals including such as, engine exhaust, carbon monoxide, phthalates and lead, that which are know to the State of California to cause cancer and birth defects or other reproductive harm. To minimize exposure, avoid breathing exhaust, do not idle the engine except as necessary, service your vehicle in a well-ventilated area and wear gloves or wash your hands frequently when servicing your vehicle. For more information go to:**  
[www.P65Warnings.ca.gov/passenger-vehicle](http://www.P65Warnings.ca.gov/passenger-vehicle)



## Wheels Maintenance

### Tires Maintenance



### CAUTION!

To obtain the best performances and the longest mileage from the tires, take the following precautions during the first 310 mi (500 km):

- do not drive at the vehicle's maximum speed;
- drive at low speed on curves;
- avoid sudden steering;
- avoid sudden braking;
- avoid sudden acceleration;
- do not drive at high speeds for too long.

The tires inflation pressure must correspond to the prescribed values (see the chapter “Tire Inflation Pressure” in section “Features and Specifications”) and should be checked only when the tires have cooled down. In fact, the pressure increases as the tire temperature progressively increases.

Never reduce the pressure if tires are hot (see “Tires – General Information” chapter in section “Driving”).



Insufficient tire inflating pressure can cause tire overheating and possible internal damage, which may even lead to the tire destruction.



### CAUTION!

After inspecting or adjusting the tire pressure, always reinstall the valve stem cap. This will prevent moisture and dirt from entering the valve stem, which could damage it.

Impacts with curbs, holes, and obstacles in the road, and prolonged trips on rough roads can cause tire damage which may not be visible to the naked eye.

Check your tires regularly for any signs of damage (e.g. scratches, cuts, cracks, bulges, etc.). If sharp objects penetrate the tires, they can cause structural damage which is only visible when the tire is removed.

In any case, any possible damage must be inspected by an experienced tire fitter, as it may seriously reduce the tire life.

Remember that tires deteriorate with time, even if used little or not at all. Cracks in the tire tread and sides, alongside possible bulging, are a sign of deterioration.



### WARNING!

- Check the inflating pressure of the tires when cold, at least every two weeks and before long trips.
- Have the old tires inspected by an experienced technician, to make sure they can still be used safely. If the same tire has been on your vehicle for 4 or 5 years, have it inspected anyway by an experienced technician.
- Never fit tires of uncertain origin.
- “Directional” tires have an arrow on their side showing the rolling direction. To keep the best performance when replacing a tire, make sure that the rolling direction corresponds to the one shown by the arrow.
- During the tire life, the rolling direction used for the first fitting shall always be observed, also in case of “nondirectional” tires.
- Check the depth of the tire tread at regular intervals. The minimum allowed value is 0.06 in (1,6 mm) at that point the wear indicators on the tire will be visible (see “Tires – General Information” in section

“Driving”). The thinner is the tread, the greater is the risk of skidding.

- Drive carefully on wet roads to decrease the risk of aquaplaning.

### Winter Tires

These tires are specially designed for driving on snow and ice and are fitted to replace the ones supplied with the vehicle.

The features of these tires are significantly reduced in winter when tread depth is less than 0.157 in (4 mm). In this case, they should be replaced.

The specific features of the winter tires lead to lower performance under normal environmental conditions or on long highway trips, compared to the standard tires.

Therefore, their use should be limited to the situations and performance for which they have been type-approved. The Authorized Maserati Dealer can provide all necessary information about fitting winter tires on the vehicle.

**NOTE:**

- We recommend fitting winter tires on the vehicle at temperatures 45 °F (7 °C) since the driving performance of summer tires is reduced at low temperatures. Summer tires may be permanently damaged at extremely low temperatures.
- Comply with all state and local laws governing snow tire and tread depth requirements.

**Wheel Rims Maintenance**

All wheel trims should be cleaned regularly with a mild soap and water. To remove heavy soil and/or excessive brake dust, use a nonabrasive, non-acidic cleaner. Do not use scouring pads, steel wool, a bristle brush, or metal polishes. Do not use oven cleaner that may affect and damage the brake calipers. Avoid automatic car washes that use acidic solutions or harsh brushes that may damage the wheel rim protective finish.

**Bodywork Maintenance and Care****Protection from Atmospheric Agents**

The main causes of corrosion are:

- atmospheric pollution;
- salinity and humidity in the atmosphere (marine areas or a damp climate);
- seasonal environmental conditions;
- salt scattered on the roadbed to melt ice and snow.

The abrasive action of wind-carried atmospheric dust and sand, mud and stones should not be underestimated. On this vehicle, Maserati has adopted the best technological solutions to protect the bodywork from corrosion. The main measures are:

- paint products and systems that give the vehicle particular resistance to corrosion and abrasion;
- use of galvanized (or pre-treated) metal sheets which are highly resistant to corrosion in the most exposed parts;
- spraying of the underbody, engine compartment, insides of wheel housings, and other structures with

wax products having high protective power;

- spraying of plastic materials, with a protective function, in the most exposed points: underneath the doors, inside part of the mud guards, edges, etc.;
- use of ventilated box sections, coated with protective wax products, to avoid condensation and trapped water which could encourage the formation of internal rust.

**Useful Advice to Keep the Bodywork in Good Condition****Paint**

The paintwork does not only have an aesthetic function but also protects the underlying metal sheets. In the event of abrasions or deep scratches, we recommend to have the necessary touch-ups made immediately, to avoid any rust formation. Touch-ups do not feature particular difficulties, even on metallic finishes.

For all paint touch-ups, use only original products indicated on the plate applied inside the hood.





Normal paint maintenance consists in washing, the frequency of which depends on the conditions of use and of the environment. For example, if driving the vehicle in areas where there is high atmospheric pollution or the roads are spread with anti-freeze salt, it is advisable to wash the vehicle more frequently.



### ENVIRONMENTAL!

Detergents pollute water. Therefore the vehicle should be washed in areas equipped for the collection and purification of the fluids used for washing.

### NOTE:

The use of alcohol-based products for cleaning the metal plates in the engine compartment and/or the trunk may deteriorate the painted surface. It is recommended to use water-based products and neutral surfactants.

### Car Wash

For correct washing:

- wet the bodywork with a low pressure water jet;
- pass a sponge with a light detergent solution over the bodywork, frequently rinsing the sponge;
- rinse well with water and dry with an air jet or chamois leather.

When drying, take particular care with the parts that are less visible, such as the door and lid bays, headlight edges, in which water can be trapped more easily.

You are recommended not to take the vehicle immediately into an enclosed environment, but leave it in the open air so as to allow the water to evaporate.

Do not wash the vehicle after it has been left in the sun or when the hood is hot: the paint gloss could be affected.

External plastic parts must be cleaned with the same procedure followed for the normal washing of the bodywork. Avoid, as far as possible, parking the vehicle under trees; the resinous substances that very often drop from the trees give the paint a dull appearance and increase the possibility of originating corrosive processes. It is important that the drain holes in the lower sides of the doors, rocker panels, and trunk bottom be kept clear and open.



### CAUTION!

- Bird droppings must be washed off immediately and thoroughly, since their acidity is particularly corrosive.
- To provide better protection for the paint, polish the vehicle at intervals with a suitable product leaving a protective film on the paint.
- If the vehicle is washed using high-pressure water jets or cleaners, it is important that the nozzle of the jet be kept at a distance of at least 16 in (40 cm) from the bodywork to avoid damaging it.
- If you are washing the vehicle with roller brushes, you must protect the edges of the rear, lateral brand





symbol with tape, to prevent it from being detached by the revolving brushes.

### Glass Surfaces

All glass surfaces should be cleaned on a regular basis with any commercial household-type glass cleaner.

Never use an abrasive type cleaner. Use caution when cleaning the inside rear window equipped with electric defrosters. Do not use scrapers or other sharp instrument that may scratch the electric elements.

When cleaning the rearview mirror, spray cleaner on the towel or rag that you are using. Do not spray cleaner directly on the mirror.

Labels can be peeled off after soaking with warm water.

Keep all objects a safe distance from the window.

### Cleaning Headlights

Your vehicle has plastic headlights that are lighter and less susceptible to stone breakage than glass headlights. Plastic is not as scratch resistant as glass and therefore different lens cleaning procedures must be followed. To minimize the possibility of scratching the lenses and reducing light output, avoid wiping with a dry

cloth. To remove road dirt, wash with a mild soap solution followed by rinsing.

Do not use abrasive cleaning components, solvents, steel wool or other aggressive material to clean the lenses.

### Moldings and Aluminum Trims

- For cleaning moldings and aluminum trims, avoid the use of acidic or alkaline cleaning agents that can destroy the protecting surface treatment.
- After washing aluminum trim with warm water, apply the cleaning agent with a clean tissue or a soft sponge on the surface. Do not use any other equipment such as brushes, steel wool, abrasives or any other equipment for cleaning.
- After cleaning, please rinse the aluminum trim with a lot of clear water.
- While cleaning in the car, please make sure that the moldings and aluminum trims only get in contact with soft brushes or textiles.

### Engine Compartment

At the end of each winter season, carefully wash the engine compartment, remembering to avoid

directing the jet of water for too long on the ECUs and other electric parts. To perform this operation, you must contact an **Authorized Maserati Dealer**.



## Interior Maintenance and Care

Interior trim should be cleaned starting with a damp cloth. Do not use harsh cleaners.

The leather upholstery can be best preserved by regular cleaning with a damp soft cloth. Small particles of dirt can act as an abrasive and damage the leather upholstery and should be removed promptly with a damp cloth. Stubborn soils stains can be removed easily with a soft cloth and appropriate products. Avoid soaking the leather upholstery with any liquid. Please do not use polishes, oils, cleaning fluids, solvents, detergents, or ammonia-based cleaners to clean your leather upholstery.

Application of a leather conditioner is not required to maintain the original condition.

Check at regular intervals that there is no water trapped under the mats (due to drips off shoes, umbrellas etc.) which may cause the metal parts to oxidize.



### CAUTION!

Do not use alcohol, petrol or solvents to clean the instrument cluster's

transparent dome, the MTC+ display, the analog clock and the leather upholstery. We recommended the use of "Car Care" products approved by Maserati for the maintenance and care of the interior.

### Leather Upholstery Treatment

Have the leather upholstery only treated, as provided in the Scheduled Service Plan, by an **Authorized Maserati Dealer** which has the required specific products.

### Parts in Premium Quality Wood

Remove any dirt with a buckskin leather or damp cloth.

#### NOTE:

*The **Authorized Maserati Dealer** can provide you with any information about the Maserati approved "Car Care" products, available in the "Genuine Accessories" range.*



### WARNING!

**California Proposition 65**  
**Operating, servicing and maintaining a passenger vehicle or off-road vehicle can expose you to chemicals including such as, engine exhaust, carbon**

**monoxide, phthalates and lead, that which are know to the State of California to cause cancer and birth defects or other reproductive harm. To minimize exposure, avoid breathing exhaust, do not idle the engine except as necessary, service your vehicle in a well-ventilated area and wear gloves or wash your hands frequently when servicing your vehicle. For more information go to: [www.P65Warnings.ca.gov/passenger-vehicle](http://www.P65Warnings.ca.gov/passenger-vehicle)**



## Vehicle Stored for Long Periods

If the vehicle is going to be stored for over a month, follow the below precautions:

- Wash and dry the vehicle thoroughly.
- Store the vehicle in a covered, dry and, if possible, ventilated area.
- Select P (Park) and turn off the engine.
- Turn the key in the ignition switch in **STOP (OFF)** position.
- Disconnect the battery (refer “Maintenance-Free Battery” in this section) or connect a battery charger (refer to paragraph “Maintaining Battery Charge” of chapter “Battery Statement” in this section).
- Check the battery charge status. During parking, this check must be carried out every three weeks. Recharge the battery if the open circuit voltage is lower than 12.2 V.
- Check that the parking brake is NOT engaged.
- Do not empty the engine cooling system.
- Clean and protect the painted parts applying protective wax.

- Clean and protect polished metal parts with special products available on the market.
- Talc the windshield wiper blades and raise them from the windshield.
- Cover the vehicle with a long cloth in breathable fabric (available from the **Authorized Maserati Dealer**). Do not use thick plastic sheets, which do not allow the humidity on the vehicle surface to evaporate.
- Inflate the tires up to a pressure which must be 1 bar (14.5 psi) higher than the normally prescribed one, and check it at regular intervals.

### NOTE:

*The **Authorized Maserati Dealer** can provide you with any information about the available “Indoor and Outdoor Car Covers”, available in the “Genuine Accessories” range.*



### WARNING!

**The tire pressure must be brought back to the prescribed value before reusing the vehicle (see “Tire Inflation Pressure” in section “Features and Specifications”).**



## Restarting the Vehicle

Before restarting the vehicle after a long period of inactivity, we recommend that you carry out the following operations.

- Check the tires for pressure and for any damages, cuts or cracks. If this is the case, have them replaced.
- Do not dry-rub the external surface of the vehicle.
- Visually inspect if there are any fluid leaks (oil, brake and clutch fluid, engine coolant etc.).
- Have the engine oil and filter replaced.
- Check the fluid levels in the brake system, as well as the engine coolant level.
- Check the air filter and have them replaced if necessary.
- Reconnect the battery after checking the charge status (refer to “Maintenance-Free Battery” in this section) and perform the initializing procedure if applicable.
- With the transmission in N (Neutral), let the engine idle for several minutes.



### WARNING!

The engine idle must be performed outdoors. Exhaust gases contain carbon monoxide which is strongly toxic and potentially lethal.



### WARNING!

**California Proposition 65**  
Operating, servicing and maintaining a passenger vehicle or off-road vehicle can expose you to chemicals including such as, engine exhaust, carbon monoxide, phthalates and lead, that which are known to the State of California to cause cancer and birth defects or other reproductive harm. To minimize exposure, avoid breathing exhaust, do not idle the engine except as necessary, service your vehicle in a well-ventilated area and wear gloves or wash your hands frequently when servicing your vehicle. For more information go to:  
[www.P65Warnings.ca.gov/passenger-vehicle](http://www.P65Warnings.ca.gov/passenger-vehicle)

## Battery Statement

### Battery Statement Status of Charge

To avoid problems with ignition and/or the electrical system in general when you are driving, the battery charge status is constantly maintained and guaranteed by the vehicle's recharge circuit; the main component of which is the alternator. This circuit is only able to supply voltage to the battery when the vehicle is traveling. The  warning light on the instrument cluster (see "Instrument Cluster" in section "Dashboard Instruments and Controls"), will indicate any malfunctions in the recharge circuit or an insufficient battery charge status (flashing). The vehicle is fitted with advanced electronic systems, such as, for example, the alarm system and various electronic control modules, which consume power even when the key in the ignition switch is in the **STOP (OFF)** position and the vehicle is not being used. Therefore, it is fundamental that the battery is properly charged to ensure that the engine starts properly and

that all the electrical/electronic systems in the vehicle work efficiently.

### Maintaining Battery Charge

If you perform short daily trips (approximately 10 miles/16 km), which correspond to an annual total of 4000 miles/6000 km, or when the vehicle is not going to be used for one week or more, Maserati recommends connecting the vehicle to a battery charger, to save you the trouble of having to recharge the battery (see "Battery Charge Maintainer Operation" in this chapter). The battery charge maintainer will keep the battery charged properly and at the correct voltage levels required by the systems and devices in the vehicle. Before using the battery charge maintainer, carefully follow the instructions provided. If you do not use a battery charge maintainer to prevent the battery from going dead when you are not going to use the vehicle for long periods of time, you need to check and recharge the battery at least once every three weeks. Make this check if you perform short daily trips (approximately 10 mi/16 km) which correspond to an annual total of 4000





miles/6000 km. Please note that allowing the battery to go dead repeatedly can cause premature wear on the internal cells and greatly reduce their life, leading to problems with the ignition system and other electrical/electronic systems. The **Authorized Maserati Dealer** is available to advise you on how to recharge your battery correctly and give you useful information on battery care and maintenance.

**NOTE:**

*The **Authorized Maserati Dealer** can provide you with any information about the Maserati approved "Battery Charger and Conditioner", available in the "Genuine Accessories" range.*



**WARNING!**

The process of charging or recharging the battery produces hydrogen, a dangerous gas that can explode and cause serious injuries. When charging or recharging the battery, follow the recommended precautions at all times:

- always charge or recharge the battery in a well-ventilated environment;

- never charge or recharge a battery that has frozen: it can explode due to hydrogen trapped inside the ice crystals;
- ensure that any sparks or open flames are nowhere near the battery while it is charging;
- before using a charger to charge or maintain the battery charge status, carefully follow the instructions provided to ensure the charger is connected to the battery safely and correctly.

## Battery Charge Maintainer Operation

### Charge Maintainer Socket

Charge maintainer socket is located inside the trunk compartment, on the right-hand side.



**NOTE:**

*The **Authorized Maserati Dealer** can give you all details concerning the battery charge maintainer, available from the "Genuine Accessories" range with four types of socket, and its use.*

### Instructions for Use

First connect the battery charge maintainer to vehicle socket: this trigger the "Active" stage and the maintainer can stay connected to vehicle for a few months with no problem.

Position the device outside the vehicle, leaving trunk lid slightly open, avoiding to squeeze the cable that gets out of the luggage compartment and/or damaging the edge seal.

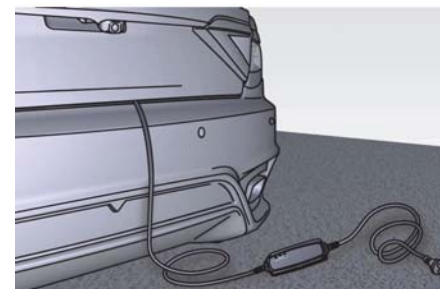



## WARNING!

Set the battery maintainer in view, away from any heat source and out of reach of children.

Battery charge maintaining process can be stopped at any time by disconnecting the power cable from the mains.

Always disconnect the power cable mains end first and then remove it from vehicle socket.

The battery maintainer features three LED identified by the following symbols:

ⓘ : error light;

🔌 : active stage light: indication;

🔋 : maintaining light: charge maintenance.

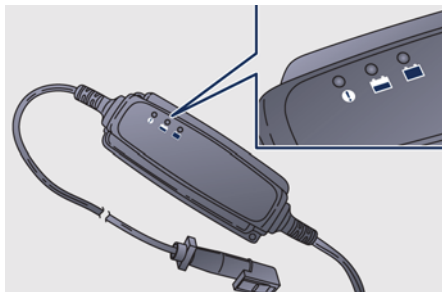

When LED ⓘ is steady on: it indicates a fault of the vehicle electric system or battery.

When LED 🔌 is steady on: it indicates that maintainer is in "Active" stage. At this stage the battery is brought from a poor charge level to an excellent charge level.

When LED 🔋 is steady on: it indicates that the battery is fully charged and maintainer is in "Passive" stage. At this stage the device keeps battery charged to an excellent level.

When LED 🔌 and LED 🔋 are alternatively blinking:

- if they blink a few times per second, probably the battery is sulfated;
- if blinking continues for over 60 minutes, the battery must be replaced;
- if they blink with an interval of a few minutes, it means that the percentage of battery self-discharge is considerable and it might be necessary to replace it.

When no light is on, you might find the following scenarios:

- maintainer cables are disconnected;
- the battery is not duly connected to vehicle system;
- the battery is faulty;

- battery voltage is insufficient or simply there is no power at the mains socket.

Check maintainer connections (to mains and vehicle socket) and power availability at the mains socket; if LED 🔌 or LED 🔋 for "Active" or "Passive" stage does not turn on within a few seconds from proper maintainer connection, contact an **Authorized Maserati Dealer** to have vehicle electrical system inspected.

## Precautions and Warnings

- Make sure that cables are not pinched or reach hot surfaces or cutting edges.
- Do not cover battery maintainer.
- Make sure that mains connector is not exposed to water/rain.
- Connection to the mains must comply with prevailing regulations on high voltage.
- Always check maintainer cables before use: make sure that cables and external sheath are free of cracks.
- Never use a maintainer if cables are damaged.
- Store and use the maintainer out of reach of children; do not allow







children to play with the battery charge maintainer.

### **Protection from Overheating**

The supplied battery charge maintainer features a protection against overheating.

In case ambient temperature increases, output power is reduced.

### **Service**

- Battery maintainer does not require any maintenance.
- Do not disassemble the battery maintainer.
- The maintainer case can be cleaned with a soft damp cloth or using mild detergent.
- Always disconnect the maintainer from the mains before cleaning it.





## **8 – Features and Specifications**

Refillings .....	276
Fuel Consumption .....	278
Technical Data .....	279
Tire Inflation Pressure .....	284





## Refillings

### NOTE:

Maserati reserves the right to change or revise specifications without prior notification.



### CAUTION!

To guarantee vehicle's integrity and maintain performance level always use genuine parts approved and recommended by Maserati.

## Refillings and Recommended Products

Parts to be refilled	Quantity	Product specifications
Fuel tank	20 US gal/75 liters (including 2 US gal/ 7,5 liters of reserve)	Premium unleaded fuel with no less than 95 RON/85 MON (91 CLC or AKI).
Engine	2.37 US gal/9,0 liters (max) (MIN – MAX difference: 0.4 US gal/1,5 liters)	Synthetic multigrade lubricants SAE 5W/40 that meet API SL/CF and ACEA A3, B3, B4 specifications. Recommended oil: PENNZOIL Platinum Euro 5W-40.
Windshield and headlight washer fluid reservoir	1.72 US gal/6,5 liters	Mix of water and detergent fluid, in the proportions indicated on the product package. If the temperature is below -4°F (-20°C), use pure detergent fluid. Detergent fluid: Mix of CUNA NC 956-II surfactants and alcohols. Recommended fluid: WUERTH Windshield Washer Fluid with antifreeze or AREXONS DP1.





Parts to be refilled	Quantity	Product specifications
Engine cooling circuit	3.43 US gal/13 liters	Mixture of water and coolant, proportionally 50/50%. Coolant: protective, antifreeze action and ethylene glycol-based with organic inhibitors compatible with regulations: <ul style="list-style-type: none"> <li>• ASTM D 3306, ASTM D 2570</li> <li>• ASTM D 4340, ASTM D 2809</li> <li>• SAE J 1034</li> <li>• CUNA NC 956/16.</li> </ul> Recommended fluid: SHELL GlycoShell or GlycoShell Long Life.
Hydraulic power steering	0.26 US gal/1,0 liters +/-4%	Oil: ATF Type A - MB 236.2. Recommended oil: SHELL Donax TM.
Automatic transmission	2.63 US gal/10,03 liters	Recommended oil: SHELL M1375.4 DEXTRON III.
Differential	2.4 lb/1,1 kg	Recommended oil: SHELL Spirax S 75W140.
Braking system	0.29 US gal/1,1 liters +/-4%	Synthetic fluid: FMVSS 116-DOT 4, ISO 4925 Class 4, ENSAYOS INTA-UNE 26-109-88, SAE J1703, SAE J1704, CUNA NC 956-01. Recommended fluid: PETRONAS Tutela TOP 5 FF.
 <b>CAUTION!</b> For each oil refilling and/or replacement, please contact an <b>Authorized Maserati Dealer</b> .		
Air conditioning system	1.32 lb +/-0.045 lb 600 g +/-20 g	Coolant: R134a.
Air Conditioning compressor	0.053 US gal +/- 0.0026 US gal 200 ml +/- 10 ml	Oil Type: PS-D1.





## WARNING!

**California Proposition 65**  
**Operating, servicing and maintaining a passenger vehicle or off-road vehicle can expose you to chemicals including such as, engine exhaust, carbon monoxide, phthalates and lead, that which are know to the State of California to cause cancer and birth defects or other reproductive harm. To minimize exposure, avoid breathing exhaust, do not idle the engine except as necessary, service your vehicle in a well-ventilated area and wear gloves or wash your hands frequently when servicing your vehicle. For more information go to:**  
[www.P65Warnings.ca.gov/passenger-vehicle](http://www.P65Warnings.ca.gov/passenger-vehicle)

## Engine Oil Identification Symbol



This symbol means that the oil has been certified by the American Petroleum Institute (API). Maserati only recommends API Certified engine oils.



## CAUTION!

Do not use chemical flushes in your engine oil as the chemicals can damage your engine. Damage caused by use of non-approved chemicals is not covered by the new Vehicle Limited Warranty.

## Engine Oil Viscosity (SAE Grade)

SAE 5W-40 engine oil is recommended for all operating temperatures. The engine oil filler cap also shows the recommended engine oil viscosity for your engine. For information on engine oil filler cap location, refer to chapter "Maintenance Procedures" in section "Maintenance and Care". Lubricants that do not have both the engine oil certification mark and the correct SAE viscosity grade number should not be used.

## Fuel Consumption

### NOTE:

- *The technical data, values and specifications in this Owner's Manual are provided as guidance only. The vehicle specific data can deviate from the information provided, for example, as a result of optional or special equipment ordered with the vehicle, vehicle loads, and country specific measurement methods.*
- *The specifications described below can change without prior notification.*

The fuel consumption values shown (Miles Per Gallon - MPG) are established using EPA test guidelines.

**City:** 13 MPG

**Highway:** 20 MPG

**Combined:** 15 MPG



## CAUTION!

- **Actual fuel economy results will vary for many reasons, including driving conditions and how you drive and maintain your vehicle.**
- **The type of route, traffic and weather conditions, driving style, general condition of the vehicle,**





equipment/accessories in the vehicle, use of the air conditioning system, vehicle load and other items or situations which may negatively affect the vehicle aerodynamics or wind resistance lead to consumption ratios differing from the indicated ones.

## Technical Data

---

**NOTE:**

*The technical data, values and specifications in this Owner's Manual are provided as guidance only. The vehicle specific data can deviate from the information provided, for example, as a result of optional or special equipment ordered with the vehicle, vehicle loads, and country specific measurement methods.*





### Engine Data

Cylinder number and position	8 - 90° V
Number of valves per cylinder	4
Bore x stroke	94 x 84,5 mm
Total displacement	4691 cu.cm
Compression ratio	11.2 +/- 0.2 : 1
Maximum power output (EC) - corresponding rpm	(* ) 338 kW – 460 CV 7000 rpm
Maximum torque (EC) - corresponding rpm	520 Nm – 53 kgm 4750 rpm
(*) Values obtained in SPORT drive mode with 98 R.O.N.	

<b>Timing System</b>	The timing system uses two overhead camshafts. The camshafts are equipped with timing variator. The timing control is done by two chains.
<b>Lubrication System</b>	The lubrication system is controlled by the wet sump system through an oil pump and the relative suction screen, incorporated in the crankcase.
<b>Cooling System</b>	Engine cooling is ensured by an anti-freeze mixture circulating inside a circuit equipped with radiator, centrifugal pump and expansion tank.
<b>Injection – Ignition System</b>	High-pressure direct fuel injection system. Static ignition with digital electronic control system included and controlled by a single microprocessor ECU.



## Brakes

Self-ventilating disc brakes on the four wheels.

- Front disc diameter: 14.1 in (360 mm).
  - Rear disc diameter: 13 in (330 mm).
  - 6-piston front brake caliper (Dual-cast technology).
  - 4-piston rear brake caliper.
- The Electric Parking Brake (EPB) acts on the rear wheels.

## Transmission

Electro-hydraulically controlled automatic transmission with 6 gears (plus reverse), torque converter, lock-up clutch and anti-slip function. TRANSAXLE-type transmission. Traction system equipped with rear self-locking differential.

## Suspension

Front and rear articulated quadrilateral suspensions. Skyhook adjustable damping suspension (optional on MC version) that allows the driver to choose two settings for the shock absorbers, depending on the road surface conditions, speed and comfort.

## Steering

Hydraulic speed-sensitive steering with cooling exchanger system. Steering diameter = 11.7 yd (10,7 m). No. of steering wheel turns = 1.5 (to the left and right).

## Wheels

### NOTE:

*In order to maintain high performance and safety level, Maserati recommends to use tires equivalent to the original size.*



### WARNING!

- **The maximum speed reachable with the tires (including winter tires) is indicated by the tire manufacturer. Always comply with the regulations in force in the Country you are driving in.**
- **Never exceed the maximum speed indicated for the tires (including winter tires): failure to respect the max. speed may damage these tires. Danger: risk of accident!**



### CAUTION!

- **While respecting the specified sizes, for the safe operation of the vehicle it is also essential that it is equipped with the same brand and type of tires on all wheels.**
- **Do not use an inner tube with Tubeless tires.**

## Standard Wheel Dimension

Light alloy rims	20" x 8.5J (front) 20" x 10.5J (rear)
- Front tires	245/35 ZR 20
- Rear tires	285/35 ZR 20
- Front winter tires	245/35 ZR 20
- Rear winter tires	285/35 ZR 20
Light alloy spare rim (optional)	18" x 6J
- Spare tire	175/55 R 18





### Performance

**NOTE:**

- The specifications described can change without prior modification.
- The values are obtained in SPORT drive mode with 98 R.O.N. unleaded gasoline.

	Sport Version	MC Version
Maximum speed	179 mph (288 km/h)	181 mph (291 km/h)
Accelerations from 0 to 100 km/h	5,0 seconds	4,9 seconds

### Weights

**NOTE:**

*The specifications described can change without prior modification.*

Unladen vehicle weight (with tank and reservoirs filled, tools and accessories)	4390 lb / 1990 kg (*)
Weight with full load (4 persons plus luggage)	5048 lb / 2290 kg
(*) Base configuration without options.	





## Dimensions

	<b>Sport Version</b>	<b>MC Version</b>
Wheel base	115.82 in (2942 mm)	115.82 in (2942 mm)
Total length	193.30 in (4910 mm)	193.70 in (4920 mm)
Width without mirrors	75.39 in (1915 mm)	75.39 in (1915 mm)
Front track	62.44 in (1586 mm)	62.44 in (1586 mm)
Rear track	62.59 in (1590 mm)	62.59 in (1590 mm)
Front overhang	35.59 in (904 mm)	35.98 in (914 mm)
Rear overhang	41.88 in (1064 mm)	41.88 in (1064 mm)
Height	54.33 in (1380 mm)	54.33 in (1380 mm)
Trunk compartment volume	45.7 US gal (173 l)	45.7 US gal (173 l)



### Tire Inflation Pressure

Tire	Pressure
Front and rear	220 kPa - 2,2 bar - 32 psi
Spare wheel (optional)	350 kPa - 3,5 bar - 51 psi

#### NOTE:

- For more information about the pressure check methods, see “Tires – General Information” in section “Driving”.
- The tire inflation pressure value are also indicated on the driver's side at the base of the rear door pillar.



#### WARNING!

- Improperly inflated tires are dangerous and can cause collisions.
- Under-inflation increases tire flexing and can result in tire overheating and failure.
- Over-inflation reduces a tire's ability to cushion shock. Objects on the road and potholes can cause damage that result in tire failure.
- Over-inflated or under-inflated tires

can affect vehicle handling and can fail suddenly, resulting in loss of vehicle control.

- Unequal tire pressures can cause steering problems. You could lose control of your vehicle.
- Unequal tire pressures from one side of the vehicle to the other can cause the vehicle to drift to the right or left.
- Always drive with each tire inflated to the recommended cold tire inflation pressure.



## 9 – Index





Abbreviations . . . . .	7	To Reconnect the Battery . . . . .	248	Console	
ABS (Anti-lock Braking System) . . . . .	179	Bluetooth, Customer settings . . . . .	147	Central Console Components . . . . .	73
A/C Air Filter Replacement . . . . .	263	Bodywork Maintenance and Care . . . . .	265	Front Dome Console	
Accessories		Protection from Atmospheric		Components . . . . .	71
Aftermarket Parts and Accessories		Agents . . . . .	265	Cruise Control . . . . .	185
Statement . . . . .	11	Useful Advice to Keep the		Cupholders	
Accident, in the event of . . . . .	213	Bodywork in Good Condition . . . . .	265	Front Seats Cupholders . . . . .	103
A/C System Maintenance . . . . .	262	Brakes		Rear Seats Cupholders . . . . .	104
Air bag . . . . .	46	Brake and Stability Control			
Air bag System Components . . . . .	46	System . . . . .	177	Dashboard Components . . . . .	70
Air bag Warning Light . . . . .	66	Brake Fluid Level Check . . . . .	242	Data, Technical . . . . .	279
Passenger Air bag Labels . . . . .	18	Brake Overheating . . . . .	182	Defroster . . . . .	66
Supplemental Restraint System		Parking Brake . . . . .	174	Doors Components . . . . .	72
(SRS) . . . . .	46	Parking Brake - Manual		Drive Mode, Controls . . . . .	169
Air Conditioning Controls . . . . .	151	Release . . . . .	220	Driving Conditions	
Air Conditioning Distribution . . . . .	112	Using the Brakes . . . . .	181	Before the Trip . . . . .	204
Alarm, Vehicle Security . . . . .	26	Bulb Replacement . . . . .	257	Driving at Night . . . . .	204
ALR (Automatic Locking Retractor) . . . . .	43			Driving in Fog . . . . .	205
Assistance . . . . .	9	Cargo Area . . . . .	107	Driving in the Mountains . . . . .	205
Assistance, if you need . . . . .	9	Child Restraint Systems		Driving in the Rain . . . . .	204
Audio Controls . . . . .	138	Children too large for Booster		Driving on Snow or Ice . . . . .	206
Steering Wheel Audio Controls . . . . .	138	Seats . . . . .	56	Driving through Flooded	
Audio, Customer Setting . . . . .	147	Infants and Child Restraints . . . . .	55	Sections . . . . .	206
Audio System . . . . .	140	Lower Anchors and Tether for		Safe Driving . . . . .	204
Automatic Transmission . . . . .	160	Children (LATCH) . . . . .	57	DRL (Daytime Running Light) . . . . .	83
Automatic Transmission Range . . . . .	162	Older Children and Child			
AUX, USB and SD Memory Card		Restraints . . . . .	55	Easy Entry/Exit function . . . . .	79
Ports . . . . .	132	Tips on getting the most out of		EDR (Event Data Recorder) . . . . .	52
Battery . . . . .	247	your child restraint . . . . .	56	Emergency	
Access the Battery . . . . .	226	Clock, analog . . . . .	144	Emergency Fuel Filler Door	
Jump Start Procedure . . . . .	226	Comfort Pack Front Seats . . . . .	76	Release . . . . .	203
Maintenance - Free Battery . . . . .	247	Driver Memory Seat . . . . .	77	Hazard Warning Flasher . . . . .	88
		Front Heated Seats . . . . .	76	In the Event of an Accident . . . . .	213







Jump Starting Procedure . . . . .	.225	Hood, Open and Close . . . . .	.37	Adaptive Bi-Xenon Headlights . . .	.84
Tool Kit . . . . .	.212	Indicator Lights		Automatic Headlights . . . . .	.84
Towing a Disabled Vehicle . . . . .	.228	Air bag Warning Light . . . . .	.66	Bulb Replacement . . . . .	.257
Engine		Indicator Lights/Warning Lights		Cargo Light . . . . .	.88
Engine Air Filter Replacement . . .	.245	TFT Display: Warning/Indicator		DRL, Daytime Running Lights. . .	.83
Engine Coolant Level Check . . . . .	.240	Lights . . . . .	.126	Front Domelights . . . . .	.87
Engine Oil Level Check . . . . .	.243	Warning and Indicator Lights on		Hazard Warning Flasher . . . . .	.88
Engine Overheating . . . . .	.214	Analog Instrument . . . . .	.119	Headlights . . . . .	.84
Engine Start Failure . . . . .	.159	Inertia Switch, Fuel Cut-out . . . . .	.229	High Beams and Flashing . . . . .	.86
Engine Turn Off . . . . .	.159	Infotainment System . . . . .	.130	Light Switch . . . . .	.82
Hood, Open and Close . . . . .	.37	Manual Controls and Devices . . .	.132	Parking Lights . . . . .	.84
Normal Starting of the Engine . . .	.158	Installing a LATCH-Compatible		Rear Fog Lights . . . . .	.85
Use of the Engine . . . . .	.183	Child Restraint System . . . . .	.57	Turn Signals. . . . .	.86
EPB (Electric Parking Brake). . . . .	.174	Instrument Cluster . . . . .	.118	Twilight Sensor . . . . .	.85
ESC (Electronic Stability Control) . .	.177	Interior Components . . . . .	.70	Loading the Vehicle	
Filters		Interior Maintenance and Cure . . .	.268	Vehicle Load Carrying Capacity. .	.107
A/C Air Filter Replacement . . . . .	.263	Interiors Features. . . . .	.102	Maintenance	
Engine Air Filter Replacement . . .	.245	Jump Start Procedure . . . . .	.226	A/C System Maintenance . . . . .	.262
Fuel		Keys . . . . .	.22	Bodywork Maintenance and	
Carbon Monoxide Warning . . . . .	.201	Level Checks . . . . .	.240	Care . . . . .	.265
Emergency Fuel Filler Door		Adding Windshield/Headlight		Interior Maintenance and Care. .	.268
Release . . . . .	.203	Washer . . . . .	.243	Maintenance Procedures . . . . .	.239
Fuel Consumption Data . . . . .	.278	Brake Fluid Level Check . . . . .	.242	Periodic Maintenance . . . . .	.237
Fuel Requirements . . . . .	.199	Engine Coolant Level Check . . . . .	.240	Scheduled Maintenance	
Fuel System Warnings . . . . .	.201	Engine Oil Level Check . . . . .	.240	Service . . . . .	.232
Gasoline/Oxygenate Blends . . . . .	.200	Power Steering Fluid Level		Scheduled Service Plan . . . . .	.234
Materials Added to Fuel . . . . .	.201	Check . . . . .	.245	Wheels Maintenance . . . . .	.263
MMT in Gasoline . . . . .	.200	Transmission Oil Check . . . . .	.245	Maserati Roadside Assistance	
Reformulated Gasoline . . . . .	.200	Lights . . . . .	.82	Program . . . . .	.15
Fuses Position and Replacement. . .	.251			MIL (Malfunction Indicator Light). .	.119
HomeLink . . . . .	.108			Mirrors	
				Folding Mirrors . . . . .	.81



Inside Rearview Mirror . . . . .	.81	Refueling . . . . .	.202	Seats, Rear . . . . .	.78
Mirrors Positioning . . . . .	.80	Reporting Safety Defects. . . . .	.10	Rear Armrest . . . . .	.79
Outside Mirrors . . . . .	.80	Restraint System		Rear Head Restraints. . . . .	.78
MTC+ "Controls" Screen . . . . .	.141	Child Restraint Systems . . . . .	.54	Rear Seats Cupholders . . . . .	.104
MTC+ Settings - Customer		Occupant Restraint System. . . . .	.38	Service and Warranty . . . . .	.8
Programmable Features . . . . .	.141	Roadside Assistance Program. . . . .	.15	Siri Smart Personal Assistant . . . . .	.156
MTC+ System (Maserati Touch		Safety		Skyhook Suspension . . . . .	.114
Control Plus), Controls . . . . .	.138	Child Restraint Systems . . . . .	.54	Smoking Kit. . . . .	.106
Onboard Computer (Trip) . . . . .	.167	Occupant Restraint System. . . . .	.38	Snow Chains . . . . .	.193
Onboard Diagnostics System . . . . .	.183	Safety Tips . . . . .	.65	SRS (Supplemental Restraint System) -	
ORC		Supplemental Restraint System -		Air Bags . . . . .	.46
(Occupant Restraint Controller) . . . . .	.50	Air bags . . . . .	.46	Start the Engine	
Park Assist. . . . .	.60	Scheduled Maintenance Service . . . . .	.232	Engine Start Failure. . . . .	.159
Parking. . . . .	.176	Scheduled Service Plan . . . . .	.234	Normal Starting of the Engine . . . . .	.158
Parking Brake . . . . .	.174	SD Memory Card, USB and AUX		Steering Wheel Adjustment. . . . .	.79
Emergency Release of Parking		Ports. . . . .	.132	Phone and Voice Controls on	
Brake . . . . .	.220	Seat Belt		Steering Wheel. . . . .	.155
Parking (Camera). . . . .	.63	Load Limiting Devices . . . . .	.44	Stored, Vehicle. . . . .	.269
Part Service. . . . .	.11	Loking Retractor (ALR) Mode . . . . .	.43	Stuck Vehicle, Freeing . . . . .	.223
Pets, transporting . . . . .	.59	Rear Passenger Seat Belts. . . . .	.42	Symbols . . . . .	.12
Phone/Bluetooth		Seat Belt Reminder Light . . . . .	.121	Tank, Fuel Refill . . . . .	.202
Phone and Voice Controls on		Seat Belt Reminder System (SBR). . . . .	.45	Technical Data . . . . .	.279
Steering Wheel. . . . .	.155	Seat Belts and Pregnant Women . . . . .	.45	Telltales	
Phone/Bluetooth, Customer		Seat Belts Pretensioners. . . . .	.44	Telltales on Speedometer. . . . .	.119
settings . . . . .	.147	Three-Point Seat Belts . . . . .	.40	Telltales on Tachometer . . . . .	.121
Phone Mode . . . . .	.156	Three-Point Seat Belts Untwisting		TFT Display: Warning/Indicator	
Voice Commands . . . . .	.156	Procedure . . . . .	.42	Lights . . . . .	.124
Pollution Control Devices . . . . .	.207	Seats, Front. . . . .	.74	TFT Display	
Power Outlets . . . . .	.102	Front Seats Cupholders . . . . .	.103	Controls. . . . .	.124
Refillings. . . . .	.276	Power Lumbar . . . . .	.75	Menus and Settings. . . . .	.124
		Seat Adjustment. . . . .	.74	Screen Pages . . . . .	.125
		Seatback Tilt . . . . .	.75	Tire Repair Kit . . . . .	.214





Tires	Trunk Lid	Windshield Wipers . . . . .	.89
Department of Transportation	Trunk Lid Emergency Release from	Wiper Maintenance and Blades	
Uniform Tire Quality Grades. . . . .	inside the Trunk. . . . .	Replacement . . . . .	.245
General Information . . . . .			
Inflation Pressure . . . . .	Updating . . . . .		.7
Punctured Tire . . . . .	USB, AUX and SD Memory Card		
Replacement Tires . . . . .	Ports . . . . .		.132
Snow Chains . . . . .			
Tire Pressure . . . . .	Vehicle Identification Data		
Tire Pressure Checkup . . . . .	Homologation Labels . . . . .		.18
Tire Repair Kit . . . . .	Vehicle Identification Number		
Tire Safety Information . . . . .	(VIN) . . . . .		.17
Tires Durability. . . . .	Warning and Information Labels .		.18
TPMS - Tire Pressure Monitoring	Voice Commands . . . . .		.156
System . . . . .			
Tread Wear Indicators . . . . .	Warning Icons. . . . .		.6
Winter Tires. . . . .	Warning/Indicator Lights on TFT		
Tool Kit . . . . .	Display. . . . .		.126
Towing the Vehicle . . . . .	Warnings when Driving . . . . .		.14
TPMS System. . . . .	Warranty and Service. . . . .		.8
Transmission, Automatic	Warranty Information . . . . .		.10
Automatic Transmission Lever . .	Wheels		
Malfunction and Overheating	Tires Maintenance . . . . .		.263
Conditions. . . . .	Wheels Rims Maintenance. . . . .		.265
Transmission Manual Release of	Windows		
P (Park) Position. . . . .	Auto Down/Auto Up Feature . . . .		.34
Trip - Onboard Computer . . . . .	Reset Auto-Up/Down . . . . .		.35
Trunk	Windshield Wipers and Washers . .		.89
Trunk Safety . . . . .	Adding Washer, Headlight Washer		
Trunk Compartment Lid . . . . .	Fluid. . . . .		.243
	Rain Sensing Wipers . . . . .		.90
	Windshield and Headlight		
	Washers . . . . .		.91

Maserati S.p.A. & Maserati North America, Inc. reserve the right to make changes and/or modifications to the content and all technical information and specifications without prior notification.

Therefore, the user is not entitled to any claims based on the contents (texts, data, illustrations, explanations and regulations) in this manual, which are based on the data known at the time of going to print.

© 2018. Maserati S.p.A. All rights reserved.

Publication n. 89408600 - 1<sup>st</sup> Edition - 08/2018

This document may not be reproduced, printed or translated, even partially, without the written consent of MASERATI S.p.A.





\*89408600\*



WWW.MASERATI.COM

MASERATI SPA · VIALE CIRO MENOTTI, 322 · I-41121 MODENA

DEALER ePROCESS