



owner.ford.com



ford.ca

January 2021  
Second Printing  
Litho in U.S.A.



MIPJ 19A321 AA



2021 **BRONCO SPORT** Owner's Manual



**BRONCO**  
SPORT



Vehicle shown with aftermarket accessories.



The information contained in this publication was correct at the time of going to print. In the interest of continuous development, we reserve the right to change specifications, design or equipment at any time without notice or obligation. No part of this publication may be reproduced, transmitted, stored in a retrieval system or translated into any language in any form by any means without our written permission. Errors and omissions excepted.

© Ford Motor Company 2020

All rights reserved.

Part Number: 202007 20201207163328

## California Proposition 65



**WARNING:** Operating, servicing and maintaining a passenger vehicle or off-highway motor vehicle can expose you to chemicals including engine exhaust, carbon monoxide, phthalates, and lead, which are known to the State of California to cause cancer and birth defects or other reproductive harm. To minimize exposure, avoid breathing exhaust, do not idle the engine except as necessary, service your vehicle in a well-ventilated area and wear gloves or wash your hands frequently when servicing your vehicle. For more information go to [www.P65Warnings.ca.gov/passenger-vehicle](http://www.P65Warnings.ca.gov/passenger-vehicle).



**WARNING:** Battery posts, terminals and related accessories contain lead and lead compounds, chemicals known to the State of California to cause cancer and reproductive harm.  
**Wash your hands after handling.**



# Table of Contents

---

## Introduction

About This Manual .....	9
Symbols Glossary .....	9
Data Recording .....	11
Perchlorate .....	15
Ford Credit .....	15
Replacement Parts Recommendation .....	16
Special Notices .....	16
Mobile Communications Equipment .....	17
Export Unique Options .....	18

## Environment

Protecting the Environment .....	19
----------------------------------	----

## At a Glance

Instrument Panel .....	20
------------------------	----

## Child Safety

General Information .....	21
Installing Child Restraints .....	23
Booster Seats .....	28
Child Restraint Positioning .....	30
Child Safety Locks .....	32

## Seatbelts

Principle of Operation .....	34
Fastening the Seatbelts .....	35
Seatbelt Height Adjustment .....	37
Seatbelt Warning Lamp and Indicator Chime .....	38
Seatbelt Reminder .....	38
Child Restraint and Seatbelt Maintenance .....	40
Seatbelt Extensions .....	40

## Personal Safety System™

Personal Safety System™ .....	41
-------------------------------	----

## Supplementary Restraints System

Principle of Operation .....	42
Driver and Passenger Airbags .....	43
Front Passenger Sensing System .....	44
Side Airbags .....	46
Driver Knee Airbag .....	47
Safety Canopy™ .....	48
Crash Sensors and Airbag Indicator .....	49
Airbag Disposal .....	50

## 911 Assist

What Is 911 Assist .....	51
Emergency Call Requirements .....	51
Emergency Call Limitations .....	52

## Keys and Remote Controls

General Information on Radio Frequencies .....	53
Remote Control .....	53
Replacing a Lost Key or Remote Control .....	58

## MyKey™

Principle of Operation .....	59
Creating a MyKey .....	60
Clearing All MyKeys .....	61
Checking MyKey System Status .....	61
Using MyKey With Remote Start Systems .....	62
MyKey – Troubleshooting .....	62

## Doors and Locks

Locking and Unlocking .....	64
Keyless Entry .....	67

## Liftgate

Opening the Liftgate .....	70
Closing the Liftgate .....	70

# Table of Contents

Opening and Closing the Liftgate Window .....	71
---	----

## Security

Passive Anti-Theft System .....	72
Anti-Theft Alarm .....	72

## Steering Wheel

Adjusting the Steering Wheel .....	74
Audio Control .....	74
Voice Control .....	75
Cruise Control - Vehicles With: Lane Centering .....	75
Cruise Control .....	75
Information Display Control .....	75
Horn .....	75
Switching the Heated Steering Wheel On and Off .....	76

## Wipers and Washers

Windshield Wipers .....	77
Autowipers .....	77
Windshield Washers .....	78
Rear Window Wiper and Washers .....	79

## Lighting

General Information .....	80
Lighting Control .....	80
Autolamps .....	81
Instrument Lighting Dimmer .....	81
Headlamp Exit Delay .....	81
Daytime Running Lamps - Vehicles With: Configurable Daytime Running Lamps .....	82
Daytime Running Lamps - Vehicles With: Daytime Running Lamps (DRL) .....	82
Front Fog Lamps .....	82
Cornering Lamps .....	83
Direction Indicators .....	84
Interior Lamps .....	84
Ambient Lighting .....	85

Rear Floodlamps .....	85
-----------------------	----

## Automatic High Beam Control

What Is Automatic High Beam Control .....	86
Switching Automatic High Beam Control On and Off .....	86
Automatic High Beam Control Indicators .....	86
Overriding Automatic High Beam Control .....	87

## Windows and Mirrors

Power Windows .....	88
Global Opening and Closing .....	89
Exterior Mirrors .....	89
Interior Mirror .....	90
Sun Visors .....	90
Moonroof .....	91

## Instrument Cluster

Gauges - Vehicles With: 4.2 Inch Instrument Cluster Display Screen .....	92
Gauges - Vehicles With: 6.5 Inch Instrument Cluster Display Screen .....	93
Warning Lamps and Indicators .....	95
Audible Warnings and Indicators .....	98

## Information Displays

General Information .....	99
Personalized Settings .....	103
Information Messages .....	104

## Remote Start

What Is Remote Start .....	118
Remote Start Precautions .....	118
Remote Start Limitations .....	118
Enabling Remote Start .....	118

# Table of Contents

Remotely Starting and Stopping the Vehicle .....	118
Extending the Remote Start Duration .....	118
Remote Start Remote Control Indicators .....	119
Remote Start Settings .....	119

## **Climate Control - Vehicles With: Dual Automatic Temperature Control (DATC)**

Identifying the Climate Control Unit .....	121
Switching Climate Control On and Off .....	121
Switching Recirculated Air On and Off .....	121
Switching Air Conditioning On and Off .....	121
Switching Maximum Defrost On and Off .....	121
Switching Maximum Cooling On and Off .....	121
Switching the Heated Wiper Park On and Off .....	122
Switching the Heated Rear Window On and Off .....	122
Switching the Heated Mirrors On and Off .....	122
Setting the Blower Motor Speed .....	122
Setting the Temperature .....	122
Directing the Flow of Air .....	123
Auto Mode .....	123
Climate Control – Troubleshooting .....	124

## **Climate Control - Vehicles With: Electronic Automatic Temperature Control (EATC)**

Identifying the Climate Control Unit .....	125
Switching Climate Control On and Off .....	125

Switching Recirculated Air On and Off .....	125
Switching Air Conditioning On and Off .....	125
Switching Maximum Defrost On and Off .....	125
Switching Maximum Cooling On and Off .....	125
Switching the Heated Wiper Park On and Off .....	126
Switching the Heated Rear Window On and Off .....	126
Switching the Heated Mirrors On and Off .....	126
Setting the Blower Motor Speed .....	126
Setting the Temperature .....	126
Directing the Flow of Air .....	127
Auto Mode .....	127
Climate Control – Troubleshooting .....	128

## **Climate Control - Vehicles With: Manual Temperature Control**

Identifying the Climate Control Unit .....	129
Switching Climate Control On and Off .....	129
Switching Recirculated Air On and Off .....	129
Switching Air Conditioning On and Off .....	129
Switching Maximum Defrost On and Off .....	129
Switching Maximum Cooling On and Off .....	129
Switching the Heated Wiper Park On and Off .....	130
Switching the Heated Rear Window On and Off .....	130
Setting the Blower Motor Speed .....	130
Setting the Temperature .....	130
Directing the Flow of Air .....	130
Climate Control – Troubleshooting .....	131

# Table of Contents

---

## Interior Air Quality

What Is the Cabin Air Filter .....	132
Locating the Cabin Air Filter .....	132
Replacing the Cabin Air Filter .....	132

## Seats

Sitting in the Correct Position .....	133
Head Restraints .....	133
Manual Seats .....	136
Power Seats .....	137
Rear Seats .....	138
Heated Seats .....	139

## Rear Occupant Alert System

What is the Rear Occupant Alert System .....	140
How Does the Rear Occupant Alert System Work .....	140
Rear Occupant Alert System Precautions .....	140
Rear Occupant Alert System Limitations .....	140
Switching Rear Occupant Alert System On and Off .....	140
Rear Occupant Alert System Indicators .....	141
Rear Occupant Alert System Audible Warnings .....	141

## Power Outlet - Vehicles With: 12V Power Outlet

What Is the Power Outlet .....	142
Power Outlet Precautions .....	142
Locating the Power Outlet .....	142

## Power Outlet - Vehicles With: 110V Power Outlet

What Is the Power Outlet .....	143
Power Outlet Precautions - 1.5L EcoBoost™ .....	143

Power Outlet Precautions - 2.0L EcoBoost™ .....	143
Locating the Power Outlet .....	143
Power Outlet Indicators .....	143

## Wireless Accessory Charger

What Is the Wireless Accessory Charger .....	144
Wireless Accessory Charger Precautions .....	144
Locating the Wireless Accessory Charger .....	144
Charging a Wireless Device .....	144

## Storage

Cup Holders .....	146
Under Seat Storage .....	146
Glasses Holder .....	146
Map Pocket .....	146

## Starting and Stopping the Engine

General Information .....	148
Ignition Switch .....	148
Keyless Starting .....	148
Starting a Gasoline Engine .....	149
Engine Block Heater .....	151

## Unique Driving Characteristics

Auto-Start-Stop .....	153
-----------------------	-----

## Fuel and Refueling

Safety Precautions .....	155
Fuel Quality .....	155
Fuel Filler Funnel Location .....	156
Running Out of Fuel .....	156
Refueling .....	158
Fuel Consumption .....	160

# Table of Contents

---

## Engine Emission Control

Emission Law .....	162
Catalytic Converter .....	163

## Transmission

Automatic Transmission .....	166
------------------------------	-----

## Four-Wheel Drive

Principle of Operation .....	172
Using Four-Wheel Drive .....	172

## Brakes

General Information .....	176
Hints on Driving With Anti-Lock Brakes .....	176
Electric Parking Brake .....	177
Hill Start Assist .....	178
Auto Hold .....	179

## Traction Control

Principle of Operation .....	181
Using Traction Control .....	181

## Stability Control

Principle of Operation .....	182
Using Stability Control .....	183

## Trail Control

What Is Trail Control .....	184
Switching Trail Control On and Off .....	184
Setting the Trail Control Speed .....	184
Canceling the Set Speed .....	185
Trail Control Indicators .....	185
Trail Control – Troubleshooting .....	185

## Parking Aids

Principle of Operation .....	186
Rear Parking Aid .....	187
Rear View Camera .....	188

180 Degree Camera .....	191
-------------------------	-----

## Cruise Control

What Is Cruise Control .....	193
Switching Cruise Control On and Off .....	193
Setting the Cruise Control Speed .....	193
Canceling the Set Speed .....	194
Resuming the Set Speed .....	194
Cruise Control Indicators .....	194

## Adaptive Cruise Control

How Does Adaptive Cruise Control With Stop and Go Work .....	195
What Is Adaptive Cruise Control With Lane Centering .....	195
What Is Intelligent Adaptive Cruise Control .....	195
Adaptive Cruise Control Precautions .....	195
Adaptive Cruise Control Limitations .....	196
Switching Adaptive Cruise Control On and Off .....	198
Setting the Adaptive Cruise Control Speed .....	199
Setting the Adaptive Cruise Control Gap .....	200
Canceling the Set Speed .....	201
Resuming the Set Speed .....	201
Overriding the Set Speed .....	201
Adaptive Cruise Control Indicators .....	201
Switching From Adaptive Cruise Control to Cruise Control .....	202
Switching Lane Centering On and Off .....	202
Switching Intelligent Mode On and Off .....	203
Adjusting the Set Speed Tolerance .....	204
Adaptive Cruise Control – Troubleshooting .....	204



# Table of Contents

## Driving Aids

Driver Alert .....	206
Lane Keeping System .....	207
Blind Spot Information System .....	211
Cross Traffic Alert .....	213
Speed Sign Recognition .....	216
Steering .....	218
Pre-Collision Assist .....	218

## Drive Mode Control

What Is Drive Mode Control .....	223
Selecting a Drive Mode - 1.5L EcoBoost™ .....	223
Selecting a Drive Mode - 2.0L EcoBoost™ .....	224
Drive Modes .....	224

## Load Carrying

Roof Racks and Load Carriers .....	227
Load Limit .....	227

## Luggage Compartment

Adjusting the Luggage Compartment Load Floor .....	233
Adjusting the Luggage Compartment Divider .....	233

## Towing

Towing a Trailer .....	235
Trailer Sway Control .....	236
Recommended Towing Weights .....	236
Essential Towing Checks .....	237
Towing the Vehicle on Four Wheels .....	240

## Driving Hints

Off-Road Driving .....	241
Breaking-In .....	248
Driving Economically .....	248
Floor Mats .....	248

## Roadside Emergencies

Roadside Assistance .....	250
Hazard Flashers .....	251
Fuel Shutoff .....	251
Jump Starting the Vehicle .....	252
Post-Crash Alert System .....	253
Transporting the Vehicle .....	253
Towing Points .....	254

## Customer Assistance

Getting the Services You Need .....	255
In California (U.S. Only) .....	256
The Better Business Bureau (BBB) Auto Line Program (U.S. Only) .....	257
Utilizing the Mediation/Arbitration Program (Canada Only) .....	258
Getting Assistance Outside the U.S. and Canada .....	258
Ordering Additional Owner's Literature .....	260
Reporting Safety Defects (U.S. Only) .....	260
Reporting Safety Defects (Canada Only) .....	260

## Fuses

Fuse Box Locations .....	262
Fuse Specification Chart .....	262
Changing a Fuse .....	269

## Maintenance

General Information .....	271
Opening and Closing the Hood .....	271
Under Hood Overview - 1.5L EcoBoost™ .....	272
Under Hood Overview - 2.0L EcoBoost™ .....	273
Engine Oil Dipstick .....	274
Engine Oil Check .....	274
Oil Change Indicator Reset .....	275
Changing the Engine Air Filter .....	276

# Table of Contents

Engine Coolant Check .....	277
Automatic Transmission Fluid Check .....	281
Brake Fluid Check .....	281
Power Steering Fluid Check .....	282
Changing the 12V Battery .....	282
Adjusting the Headlamps .....	284
Washer Fluid Check .....	285
Fuel Filter .....	285
Checking the Wiper Blades .....	286
Changing the Front Wiper Blades .....	286
Changing the Rear Wiper Blades .....	286
Changing a Bulb .....	287

## Vehicle Care

General Information .....	289
Cleaning Products .....	289
Cleaning the Exterior .....	290
Waxing .....	291
Cleaning the Engine .....	291
Cleaning the Windows and Wiper Blades .....	292
Cleaning the Interior .....	292
Cleaning the Instrument Panel and Instrument Cluster Lens .....	293
Repairing Minor Paint Damage .....	294
Cleaning the Wheels .....	294
Vehicle Storage .....	294

## Wheels and Tires

General Information .....	297
Tire Care .....	299
Using Snow Chains .....	312
Tire Pressure Monitoring System .....	312
Changing a Road Wheel .....	316
Technical Specifications .....	322

## Capacities and Specifications

Engine Specifications - 1.5L EcoBoost™ .....	323
Engine Specifications - 2.0L EcoBoost™ .....	323
Vehicle Dimensions .....	324
Motorcraft Parts - 1.5L EcoBoost™ .....	325
Motorcraft Parts - 2.0L EcoBoost™ .....	325
Bulb Specification Chart .....	326
Engine Oil Capacity and Specification - 2.0L EcoBoost™ .....	328
Engine Oil Capacity and Specification - 1.5L EcoBoost™ .....	329
Cooling System Capacity and Specification - 2.0L EcoBoost™ .....	331
Cooling System Capacity and Specification - 1.5L EcoBoost™ .....	332
Fuel Tank Capacity .....	332
Air Conditioning System Capacity and Specification - 2.0L EcoBoost™ .....	333
Air Conditioning System Capacity and Specification - 1.5L EcoBoost™ .....	334
Washer Fluid Specification .....	334
Brake Fluid Specification .....	335

## Vehicle Identification

Vehicle Identification Number .....	336
-------------------------------------	-----

## Connected Vehicle

What Is a Connected Vehicle .....	337
Connected Vehicle Requirements .....	337
Connected Vehicle Limitations .....	337
Connecting the Vehicle to a Mobile Network - Vehicles With: Modem .....	337
Connecting the Vehicle to a Wi-Fi Network - Vehicles With: SYNC 3 .....	337
Connected Vehicle – Troubleshooting - Vehicles With: Modem .....	338
Connected Vehicle – Troubleshooting - Vehicles With: SYNC 3 .....	339

# Table of Contents

---

## Vehicle Wi-Fi Hotspot

Creating a Vehicle Wi-Fi Hotspot .....	341
Changing the Vehicle Wi-Fi Hotspot Name or Password .....	341

## Audio System

General Information .....	342
Audio Unit .....	342
Digital Radio .....	344
Satellite Radio .....	346
USB Port .....	349

## SYNC™ 3

General Information .....	350
Using Voice Recognition .....	352
Entertainment .....	359
Phone .....	369
Navigation .....	370
Apps .....	376
Settings .....	378
SYNC™ 3 Troubleshooting .....	380

## Accessories

Accessories .....	393
-------------------	-----

## Ford Protect

Ford Protect .....	394
--------------------	-----

## Scheduled Maintenance

General Maintenance Information .....	396
Normal Scheduled Maintenance .....	399
Special Operating Conditions Scheduled Maintenance .....	402

## Appendices

Electromagnetic Compatibility .....	405
End User License Agreement .....	408
Declaration of Conformity .....	433
Type Approvals .....	434

# Introduction

## ABOUT THIS MANUAL

Thank you for choosing Ford. We recommend that you take some time to get to know your vehicle by reading this manual. The more that you know about your vehicle, the greater the safety and pleasure you will get from driving it.



**WARNING:** Driving while distracted can result in loss of vehicle control, crash and injury. We strongly recommend that you use extreme caution when using any device that may take your focus off the road. Your primary responsibility is the safe operation of your vehicle. We recommend against the use of any hand-held device while driving and encourage the use of voice-operated systems when possible. Make sure you are aware of all applicable local laws that may affect the use of electronic devices while driving.

**Note:** This manual describes product features and options available throughout the range of available models, sometimes even before they are generally available. It may describe options not fitted to the vehicle you have purchased.

**Note:** Some of the illustrations in this manual may show features as used in different models, so may appear different to you on your vehicle.

**Note:** Always use and operate your vehicle in line with all applicable laws and regulations.

**Note:** Pass on this manual when selling your vehicle. It is an integral part of your vehicle.

This manual may qualify the location of a component as left-hand side or right-hand side. The side is determined when facing forward in the seat.

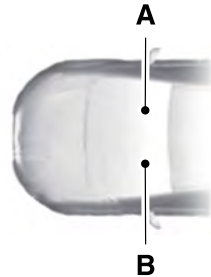

- A Right-hand side.
- B Left-hand side.

## SYMBOLS GLOSSARY

These are some of the symbols you may see on your vehicle.



Air conditioning system



Air conditioning system lubricant type



Anti-lock braking system



Avoid smoking, flames or sparks



Battery



Battery acid



Brake fluid - non petroleum based



Brake system

# Introduction



Brake system



Flammable



Cabin air filter



Front airbag



Check fuel cap



Front fog lamps



Child safety door lock or unlock



Fuel pump reset



Child seat lower anchor



Fuse compartment



Child seat tether anchor



Hazard flashers



Cruise control



Heated rear window



Do not open when hot



Windshield defrosting system



Engine air filter



Interior luggage compartment release



Engine coolant



Jack



Engine coolant temperature



Keep out of reach of children



Engine oil



Lighting control



Explosive gas



Low tire pressure warning



Fan warning



Maintain correct fluid level



Fasten seatbelt



Note operating instructions

# Introduction



Horn control



Panic alarm



Parking aid



Parking brake



Power steering fluid



Power windows front/rear



Power window lockout



Requires registered technician



Safety alert



See Owner's Manual



See Service Manual



Service engine soon



Passenger airbag activated



Passenger airbag deactivated



Side airbag



Shield the eyes



Stability control



Hill descent control



Trail control



Windshield wiper system



Windshield wash and wipe

## DATA RECORDING



**WARNING:** Do not connect wireless plug-in devices to the data link connector. Unauthorized third parties could gain access to vehicle data and impair the performance of safety related systems. Only allow repair facilities that follow our service and repair instructions to connect their equipment to the data link connector.

We respect your privacy and are committed to protecting it. The information contained in this publication was correct at the time of going to print, but as technology rapidly changes, we recommend that you visit the regional Ford website for the latest information.

# Introduction

---

Your vehicle has electronic control units that have data recording functionality and the ability to permanently or temporarily store data. This data could include information on the condition and status of your vehicle, vehicle maintenance requirements, events and malfunctions. The types of data that can be recorded are described in this section. Some of the data recorded is stored in event logs or error logs.

**Note:** *Error logs are reset following a service or repair.*

**Note:** *We may provide information in response to requests from law enforcement, other government authorities and third parties acting with lawful authority or through a legal process. Such information could be used by them in legal proceedings.*

Data recorded includes, for example:

- Operating states of system components, for example, fuel level, tire pressure and battery charge level.
- Vehicle and component status, for example, wheel speed, deceleration, lateral acceleration and seatbelt status.
- Events or errors in essential systems, for example, headlamps and brakes.
- System responses to driving situations, for example, airbag deployment and stability control.
- Environmental conditions, for example, temperature.

Some of this data, when used in combination with other information, for example, an accident report, damage to a vehicle or eyewitness statements, could be associated with a specific person.

## Service Data

Service data recorders in your vehicle are capable of collecting and storing diagnostic information about your vehicle. This potentially includes information about the performance or status of various systems and modules in the vehicle, such as engine, throttle, steering or brake systems. In order to properly diagnose and service your vehicle, Ford Motor Company (Ford of Canada in Canada), and service and repair facilities may access or share among them vehicle diagnostic information received through a direct connection to your vehicle when diagnosing or servicing your vehicle. Additionally, Ford Motor Company (Ford of Canada, in Canada) may, where permitted by law, use vehicle diagnostic information for vehicle improvement or with other information we may have about you, for example, your contact information, to offer you products or services that may interest you. Data may be provided to our service providers such as part suppliers that may help diagnose malfunctions, and who are similarly obligated to protect data. We retain this data only as long as necessary to perform these functions or to comply with law. We may provide information where required in response to official requests to law enforcement or other government authorities or third parties acting with lawful authority or court order, and such information may be used in legal proceedings. For U.S. only (if equipped), if you choose to use connected apps and services, you consent that certain diagnostic information may also be accessed electronically by Ford Motor Company and Ford authorized service facilities, and that the diagnostic information may be used to provide services to you, personalizing your experience, troubleshoot, and to improve products and services and offer you products and services that may interest

# Introduction

---

you, where permitted by law. For Canada only, for more information, please review the Ford of Canada privacy policy at [www.ford.ca](http://www.ford.ca), including our U.S. data storage and use of service providers in other jurisdictions who may be subject to legal requirements in Canada, the United States and other countries applicable to them, for example, lawful requirements to disclose personal information to governmental authorities in those countries.

## Event Data

This vehicle is equipped with an event data recorder. The main purpose of an event data recorder is to record, in certain crash or near crash-like situations, such as an airbag deployment or hitting a road obstacle; this data assist in understanding how a vehicle's systems performed. The event data recorder is designed to record data related to vehicle dynamics and safety systems for a short period of time, typically 30 seconds or less.

The event data recorder in this vehicle is designed to record such data as:

- How various systems in your vehicle were operating.
- Whether or not the driver and passenger seatbelts were buckled/fastened.
- How far (if at all) the driver was depressing the accelerator and/or the brake pedal.
- How fast the vehicle was traveling.
- Where the driver was positioning the steering wheel.

This data can help provide a better understanding of the circumstances in which crashes and injuries occur.

**Note:** *Event data recorder data is recorded by your vehicle only if a non-trivial crash situation occurs; no data is recorded by the event data recorder under normal driving conditions and no personal data or information (e.g., name, gender, age, and crash location) is recorded. However, other parties, such as law enforcement, could combine the event data recorder data with the type of personally identifying data routinely acquired during a crash investigation.*

To read data recorded by an event data recorder, special equipment is required, and access to the vehicle or the event data recorder is needed. In addition to the vehicle manufacturer, other parties, such as law enforcement, that have such special equipment, can read the information if they have access to the vehicle or the event data recorder.

## Comfort, Convenience and Entertainment Data

Your vehicle has electronic control units that have the ability to store data based on your personalized settings. The data is stored locally in the vehicle or on devices that you connect to it, for example, a USB drive or digital music player. You can delete some of this data and also choose whether to share it through the services to which you subscribe. See **Settings** (page 378).

## Comfort and Convenience Data

Data recorded includes, for example:

- Seat and steering wheel position.
- Climate control settings.
- Radio presets.



# Introduction

---

## Entertainment Data

Data recorded includes, for example:

- Music, videos or album art.
- Contacts and corresponding address book entries.
- Navigation destinations.

## Services That We Provide

If you use our services, we collect and use data, for example, account information, vehicle location and driving characteristics, that could identify you. We transmit this data through a dedicated, protected connection. We only collect and use data to enable your use of our services to which you have subscribed, with your consent or where permitted by law. For additional information, see the terms and conditions of the services to which you have subscribed.

## Services That Third Parties Provide

We recommend that you review the terms and conditions and data privacy information for any services to which you subscribe. We take no responsibility for services that third parties provide.

## Vehicles With a Modem (If Equipped)



The modem has a SIM. The modem was enabled when your vehicle was built and periodically sends messages to stay connected to the cell phone network, receive automatic software updates and send vehicle-related information to us, for example, diagnostic information. These messages could include information that identifies your vehicle, the SIM and the electronic serial number of the modem. Cell phone network

service providers could have access to additional information, for example, cell phone network tower identification. For additional information about our privacy policy, visit [www.FordConnected.com](http://www.FordConnected.com) or refer to your local Ford website.

**Note:** *The modem continues to send this information unless you disable the modem or stop the modem from sharing vehicle data by changing the modem settings. See **Connected Vehicle** (page 337).*

**Note:** *The service can be unavailable or interrupted for a number of reasons, for example, environmental or topographical conditions and data plan coverage.*

**Note:** *To find out if your vehicle has a modem, visit [www.FordConnected.com](http://www.FordConnected.com).*

## Vehicles With SYNC

### Mobile Device Data

If you connect a mobile device to your vehicle, you can display data from your device on the touchscreen for example, music and album art. You can share your vehicle data with mobile apps on your device through the system. See **Apps** (page 376).

The mobile apps function operates by your connected device sending data to us in the United States. The data is encrypted and includes, for example, the vehicle identification number of your vehicle, odometer, SYNC module number, anonymous usage statistics and debugging information. We retain it only as long as necessary to provide the service, to troubleshoot, for continuous improvement and to offer you products and services that may be of interest to you according to your preferences and where allowed by law.

# Introduction

---

If you connect a cell phone to the system, the system creates a profile that links to that cell phone. The cell phone profile enables more mobile features and efficient operation. The profile contains, for example, data from your phonebook, read and unread text messages and call history, including history of calls when your cell phone was not connected to the system.

If you connect a media device, the system creates and retains a media device index of supported media content. The system also records a short diagnostic log of approximately 10 minutes of all recent system activity.

The cell phone profile, media device index and diagnostic log remain in your vehicle unless you delete them and are generally accessible only in your vehicle when you connect your cell phone or media device. If you no longer plan to use the system or your vehicle, we recommend you use the master reset function to erase the stored information. See **Settings** (page 378).

System data cannot be accessed without special equipment and access to your vehicle's module.

For additional information about our privacy policy, refer to your local Ford website.

**Note:** *To find out if your vehicle has connectivity technology, visit [www.FordConnected.com](http://www.FordConnected.com).*

## Vehicles With an Emergency Call System

When the emergency call system is active, it may disclose to emergency services that your vehicle has been in a crash involving the deployment of an airbag or activation of the fuel pump shut-off. Certain versions or updates to the emergency call system may also be capable of electronically or verbally disclosing to emergency services operators your vehicle location or other

details about your vehicle or crash to assist emergency services operators to provide the most appropriate emergency services. If you do not want to disclose this information, do not activate the emergency call system.

**Note:** *You cannot deactivate emergency call systems that are required by law.*

## PERCHLORATE

Certain components in your vehicle such as airbag modules, seatbelt pretensioners and remote control batteries may contain perchlorate material. Special handling may apply for service or vehicle end of life disposal.

**For more information visit:**

Web Address
<a href="http://www.dtsc.ca.gov/hazardouswaste/perchlorate">www.dtsc.ca.gov/hazardouswaste/perchlorate</a>

## FORD CREDIT

### US Only

Ford Credit offers a full range of financing and lease plans to help you acquire your vehicle. If you have financed or leased your vehicle through Ford Credit, thank you for your business.

For assistance call 1-800-727-7000, or for more information about Ford Credit and access to the online Account Manager tool, visit [www.ford.com/finance](http://www.ford.com/finance).

# Introduction

## REPLACEMENT PARTS RECOMMENDATION

We have built your vehicle to the highest standards using quality parts. We recommend that you demand the use of genuine Ford and Motorcraft parts whenever your vehicle requires scheduled maintenance or repair. You can clearly identify genuine Ford and Motorcraft parts by looking for the Ford, FoMoCo or Motorcraft branding on the parts or their packaging.

## Scheduled Maintenance and Mechanical Repairs

One of the best ways for you to make sure that your vehicle provides years of service is to have it maintained in line with our recommendations using parts that conform to the specifications detailed in this Owner's Manual.

Genuine Ford and Motorcraft parts meet or exceed these specifications.

## Collision Repairs

We hope that you never experience a collision, but accidents happen sometimes.

Genuine Ford replacement collision parts meet our stringent requirements for fit, finish, structural integrity, corrosion protection and dent resistance. During vehicle development we validate that these parts deliver the intended level of protection as a whole system. A great way to know for sure you are getting this level of protection is to use genuine Ford replacement collision parts.

## Warranty on Replacement Parts

Genuine Ford and Motorcraft replacement parts are the only replacement parts that benefit from a Ford Warranty.

The Ford Warranty may not cover damage caused to your vehicle as a result of failed non-Ford parts.

For additional information, refer to the terms and conditions of the Ford Warranty.

## SPECIAL NOTICES

### New Vehicle Limited Warranty

For a detailed description of what is covered by your New Vehicle Limited Warranty, see your warranty guide that is available online. For more information, refer to our website and download your copy of the warranty guide.

### Special Instructions

For your added safety, your vehicle is fitted with sophisticated electronic controls.



**WARNING:** You risk death or serious injury to yourself and others if you do not follow the instruction highlighted by the warning symbol. Failure to follow the specific warnings and instructions could result in personal injury.



**WARNING:** NEVER use a rearward facing child restraint on a seat protected by an ACTIVE AIRBAG in front of it, DEATH or SERIOUS INJURY to the CHILD can occur.

# Introduction

## On Board Diagnostics Data Link Connector



**WARNING:** Do not connect wireless plug-in devices to the data link connector. Unauthorized third parties could gain access to vehicle data and impair the performance of safety related systems. Only allow repair facilities that follow our service and repair instructions to connect their equipment to the data link connector.

Your vehicle has an OBD Data Link Connector (DLC) that is used in conjunction with a diagnostic scan tool for vehicle diagnostics, repairs and reprogramming services. Installing an aftermarket device that uses the DLC during normal driving for purposes such as remote insurance company monitoring, transmission of vehicle data to other devices or entities, or altering the performance of the vehicle, may cause interference with or even damage to vehicle systems. We do not recommend or endorse the use of unapproved aftermarket plug-in devices. The vehicle Warranty will not cover damage caused by an aftermarket plug-in device.

## Notice to Owners of Pickup Trucks and Utility Type Vehicles



**WARNING:** Utility vehicles have a significantly higher rollover rate than other types of vehicles.

Before you drive your vehicle, please read this Owner's Guide carefully. Your vehicle is not a passenger car. As with other vehicles of this type, failure to operate this vehicle correctly may result in loss of vehicle control, vehicle rollover, personal injury or death.

## Using Your Vehicle With a Snowplow

**Do not use this vehicle for snowplowing.**

Your vehicle does not have a snowplowing package.

## Using Your Vehicle as an Ambulance

**Do not use this vehicle as an ambulance.**

Your vehicle does not have the Ambulance Preparation Package.

## MOBILE COMMUNICATIONS EQUIPMENT



**WARNING:** Driving while distracted can result in loss of vehicle control, crash and injury. We strongly recommend that you use extreme caution when using any device that may take your focus off the road. Your primary responsibility is the safe operation of your vehicle. We recommend against the use of any hand-held device while driving and encourage the use of voice-operated systems when possible. Make sure you are aware of all applicable local laws that may affect the use of electronic devices while driving.

Using mobile communications equipment is becoming increasingly important in the conduct of business and personal affairs. However, you must not compromise your own or others' safety when using such equipment. Mobile communications can enhance personal safety and security when appropriately used, particularly in emergency situations. Safety must be paramount when using mobile

# Introduction

---

communications equipment to avoid negating these benefits. Mobile communication equipment includes, but is not limited to, cellular phones, pagers, portable email devices, text messaging devices and portable two-way radios.

## EXPORT UNIQUE OPTIONS

For your particular global region, your vehicle may be equipped with features and options that are different from the features and options that are described in this Owner's Manual. A market unique supplement may be supplied that complements this book. By referring to the market unique supplement, if provided, you can properly identify those features, recommendations and specifications that are unique to your vehicle. This Owner's Manual is written primarily for the U.S. and Canadian Markets. Features or equipment listed as standard may be different on units built for export. **Refer to this Owner's Manual for all other required information and warnings.**

# Environment

---

## **PROTECTING THE ENVIRONMENT**

You should play your part in protecting the environment. Correct vehicle usage and the authorized disposal of waste, cleaning and lubrication materials are significant steps toward this aim.

For additional information about our sustainability progress and initiatives, visit [www.sustainability.ford.com](http://www.sustainability.ford.com).

# At a Glance

## INSTRUMENT PANEL

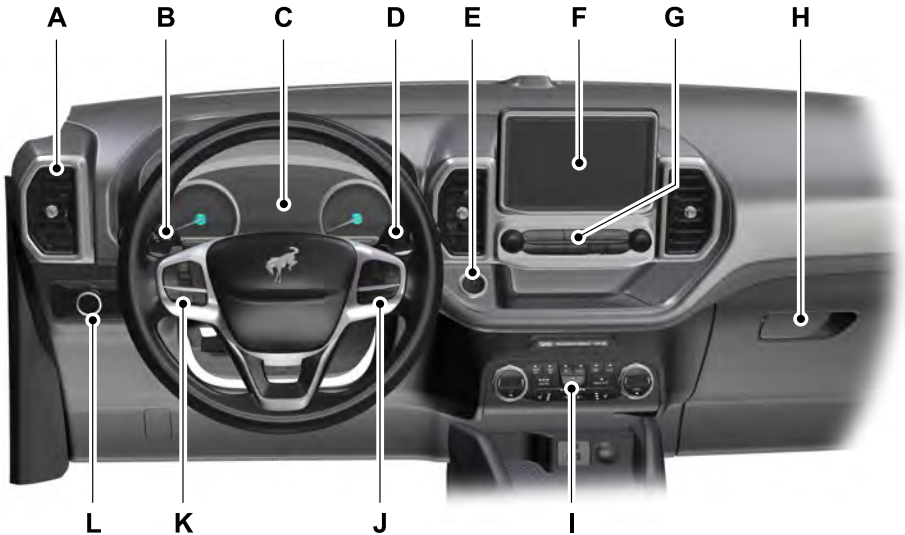

- A Air vents.
- B Direction indicators. See **Direction Indicators** (page 84).
- C Information display. See **Information Displays** (page 99).
- D Wiper lever. See **Wipers and Washers** (page 77).
- E Push button ignition switch. See **Keyless Starting** (page 148).
- F Touchscreen display.
- G Audio unit controls. See **Audio System** (page 342).
- H Glove compartment.
- I Climate controls. See **Climate Control** (page 121).
- J Cruise controls. See **Adaptive Cruise Control** (page 195).
- K Information display controls and audio controls. See **Information Display Control** (page 75). See **Audio Control** (page 74).
- L Lighting control. See **Lighting Control** (page 80).

# Child Safety

## GENERAL INFORMATION

See the following sections for directions on how to properly use safety restraints for children.



**WARNING:** Always make sure your child is secured properly in a device that is appropriate for their height, age and weight. Child safety restraints must be bought separately from your vehicle. Failure to follow these instructions and guidelines may result in an increased risk of serious injury or death to your child.



**WARNING:** All children are shaped differently. The National Highway Traffic Safety Administration and other safety organizations, base their recommendations for child restraints on probable child height, age and weight thresholds, or on the minimum requirements of the law. We recommend that you check with a NHTSA Certified Child Passenger Safety Technician

(CPST) to make sure that you properly install the child restraint in your vehicle and that you consult your pediatrician to make sure you have a child restraint appropriate for your child. To locate a child restraint fitting station and CPST, contact NHTSA toll free at 1-888-327-4236 or go to [www.nhtsa.dot.gov](http://www.nhtsa.dot.gov). In Canada, contact Transport Canada toll free at 1-800-333-0371 or go to [www.tc.gc.ca](http://www.tc.gc.ca) to find a Child Car Seat Clinic in your area. Failure to properly restrain children in child restraints made especially for their height, age and weight, may result in an increased risk of serious injury or death to your child.



**WARNING:** On hot days, the temperature inside the vehicle can rise very quickly. Exposure of people or animals to these high temperatures for even a short time can cause death or serious heat related injuries, including brain damage. Small children are particularly at risk.



# Child Safety

## Recommendations for Safety Restraints for Children

Child	Child Size, Height, Weight, or Age	Recommended Restraint Type
Infants or toddlers	Children weighing 40 lb (18 kg) or less (generally age four or younger).	Use a child restraint (sometimes called an infant carrier, convertible seat, or toddler seat).
Small children	Children who have outgrown or no longer properly fit in a child restraint (generally children who are less than 57 in (1.45 m) tall, are greater than age four and less than age 12, and between 40 lb (18 kg) and 80 lb (36 kg) and upward to 100 lb (45 kg) if recommended by your child restraint manufacturer).	Use a belt-positioning booster seat.
Larger children	Children who have outgrown or no longer properly fit in a belt-positioning booster seat (generally children who are at least 57 in (1.45 m) tall or greater than 80 lb (36 kg) or 100 lb (45 kg) if recommended by child restraint manufacturer).	Use a vehicle seatbelt having the lap belt snug and low across the hips, shoulder belt centered across the shoulder and chest, and seat backrest upright.

- You are required by law to properly use child restraints for infants and toddlers in the United States, Canada and Mexico.
- Many states and provinces require that small children use approved booster seats until they reach age eight, a height of 57 in (1.45 m) tall, or 80 lb (36 kg). Check your local and state or provincial laws for specific requirements about the safety of children in your vehicle.
- When possible, properly restrain children 12 years of age and under in a rear seating position of your vehicle. Accident statistics suggest that children are safer when properly restrained in the rear seating positions than in a front seating position. See **Front Passenger Sensing System** (page 44).
- When installing a rear facing child restraint, adjust the vehicle seats to avoid interference between the child restraint and the vehicle seat in front of the child restraint.

# Child Safety

## INSTALLING CHILD RESTRAINTS

### Child Restraints



E142594

Use a child restraint (sometimes called an infant carrier, convertible seat, or toddler seat) for infants, toddlers, or children weighing 40 lb (18 kg) or less (generally age four or younger).

### Using Lap and Shoulder Belts



**WARNING:** Do not place a rearward facing child restraint in front of an active airbag. Failure to follow this instruction could result in personal injury or death.



**WARNING:** Properly secure children 12 years old and under in a rear seating position whenever possible. If you are unable to properly secure all children in a rear seating position, properly secure the largest child on the front seat. If you must use a forward facing child restraint on the front seat, move the seat as far back as possible. Failure to follow these instructions could result in personal injury or death.



**WARNING:** Depending on where you secure a child restraint, and depending on the child restraint design, you may block access to certain seatbelt buckle assemblies and LATCH lower anchors, rendering those features potentially unusable. To avoid risk of injury, make sure occupants only use seating positions where they are able to be properly restrained.

When installing a child restraint with combination lap and shoulder belts:

- Use the correct seatbelt buckle for that seating position.
- Insert the belt tongue into the proper buckle until you hear a snap and feel it latch. Make sure the tongue is securely fastened in the buckle.
- Keep the buckle release button pointing up and away from the child restraint, with the tongue between the child restraint and the release button, to prevent accidental unbuckling.
- Place the vehicle seat in the upright position before you install the child restraint.
- Put the seatbelt in the automatic locking mode. See Step 5. This vehicle does not require the use of a locking clip.

Perform the following steps when installing the child restraint with combination lap and shoulder belts:

**Note:** *Although the child restraint illustrated is a forward facing child restraint, the steps are the same for installing a rear facing child restraint.*

# Child Safety



1. Position the child restraint in a seat with a combination lap and shoulder belt.



2. Pull down on the shoulder belt and then grasp the shoulder belt and lap belt together.



3. While holding the shoulder and lap belt portions together, route the tongue through the child restraint according to the child restraint manufacturer's instructions. Make sure you did not twist the belt webbing.

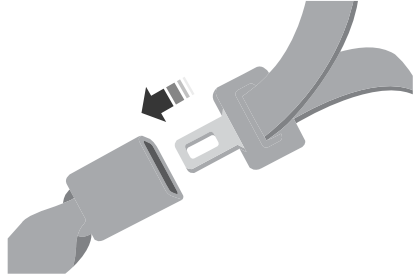

4. Insert the belt tongue into the proper buckle (the buckle closest to the direction the tongue is coming from) for that seating position until you hear a snap and feel the latch engage. Make sure the tongue is latched securely by pulling on it.



5. To put the retractor in the automatic locking mode, grasp the shoulder portion of the belt and pull downward until you pull all of the belt out.

**Note:** *The automatic locking mode is available on the front passenger and rear seats.*

# Child Safety

6. Allow the belt to retract to remove slack. The belt clicks as it retracts to indicate it is in the automatic locking mode.
7. Try to pull the belt out of the retractor to make sure the retractor is in the automatic locking mode. You should not be able to pull more belt out. If the retractor is not locked, unbuckle the belt and repeat Steps 5 and 6.

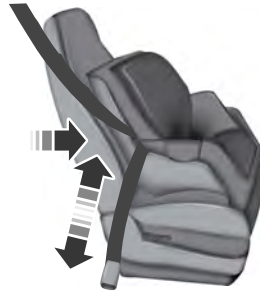

8. Remove remaining slack from the belt. Force the seat down with extra weight, for example, by pressing down or kneeling on the child restraint while pulling up on the shoulder belt in order to force slack from the belt. This is necessary to remove the remaining slack that exists once you add the extra weight of the child to the child restraint. It also helps to achieve the proper snugness of the child restraint to your vehicle. Sometimes, a slight lean toward the buckle will additionally help to remove remaining slack from the belt.
9. If the child restraint has a tether strap, attach it.

10. Before placing the child in the seat, forcibly move the seat forward and back to make sure the seat is securely held in place. To check this, grab the seat at the belt path and attempt to move it side to side and forward and back. There should be no more than 1 in (2.5 cm) of movement for proper installation.

We recommend checking with a NHTSA Certified Child Passenger Safety Technician to make certain the child restraint is properly installed. In Canada, check with Transport Canada for referral to a Child Car Seat Clinic.

## Using Lower Anchors and Tethers for Children (LATCH)



**WARNING:** Do not attach two child safety restraints to the same anchor. In a crash, one anchor may not be strong enough to hold two child safety restraint attachments and may break, causing serious injury or death.

# Child Safety



**WARNING:** Depending on where you secure a child restraint, and depending on the child restraint design, you may block access to certain seatbelt buckle assemblies and LATCH lower anchors, rendering those features potentially unusable. To avoid risk of injury, make sure occupants only use seating positions where they are able to be properly restrained.

The LATCH system has three vehicle anchor points: two lower anchors where the seat backrest and seat cushion meet (called the seat bight) and one top tether anchor behind that seating position.

LATCH compatible child restraints have two rigid or webbing mounted attachments that connect to the two lower anchors at the LATCH equipped seating positions in your vehicle. This type of attachment method eliminates the need to use seatbelts to attach the child restraint. However, you can still use the seatbelt to attach the child restraint. For forward-facing child restraints, you must attach the top tether strap to the proper top tether anchor, if a top tether strap has been provided with your child restraint.



Your vehicle has LATCH lower anchors for child restraint installation at the seating positions marked with the child restraint symbol.



E144054

The LATCH anchors are at the rear section of the rear seat between the cushion and seat backrest below the symbols as shown. Follow the child restraint manufacturer's instructions to properly install a child restraint with LATCH attachments.

Attach LATCH lower attachments of the child restraint only to the anchors shown.

## Use of Inboard Lower Anchors from the Outermost Seating Positions (Center Seating Use)



**WARNING:** The standardized spacing for LATCH lower anchors is 11 in (280 mm) center to center. Do not use LATCH lower anchors for the center seating position unless the child restraint manufacturer's instructions permit and specify using anchors spaced at least as far apart as those in this vehicle.

The lower anchors at the center of the second row rear seat are spaced 18 in (46 cm) apart. You cannot install a child restraint with rigid LATCH attachments at the center seating position. LATCH compatible child restraints (with

# Child Safety

attachments on belt webbing) can only be used at this seating position provided that the child restraint manufacturer's instructions permit use with the anchor spacing stated. Do not attach a child restraint to any lower anchor if an adjacent child restraint is attached to that anchor.

Each time you use the child restraint, check that the seat is properly attached to the lower anchors and tether anchor, if applicable. Tug the child restraint from side to side and forward and back where it is secured to your vehicle. The seat should move less than 1 in (2.5 cm) when you do this for a proper installation.

If you did not properly anchor the child restraint, the risk of a child being injured in a crash greatly increases.

## Combining Seatbelt and LATCH Lower Anchors for Attaching Child Restraints

When used in combination, you may attach either the seatbelt or the LATCH lower anchors first, provided a proper installation is achieved. Attach the tether strap afterward, if included with the child restraint.

## Using Tether Straps



Many forward-facing child restraints include a tether strap which extends from the back of the child restraint and hooks to an anchoring point called the top tether anchor. Tether straps are available as an accessory for many older child restraints.

Contact the manufacturer of your child restraint for information about ordering a tether strap, or to obtain a longer tether strap if the tether strap on your child restraint does not reach the appropriate top tether anchor in your vehicle.

Once you install the child restraint using either the seatbelt, the lower anchors of the LATCH system, or both, you can attach the top tether strap.

The tether strap anchors in your vehicle are in the following positions (shown from top view):



Perform the following steps to install a child restraint with tether anchors:

**Note:** If you install a child restraint with rigid LATCH attachments, do not tighten the tether strap enough to lift the child restraint off your vehicle seat cushion when the child is seated in it. Keep the tether strap just snug without lifting the front of the child restraint. Keeping the child restraint just touching your vehicle seat gives the best protection in a severe crash.

1. Route the child restraint tether strap over the back of the seat. For the outermost seating positions, route the tether strap under the head restraint and between the head restraint posts. For the center seating positions, route the tether strap over the top of the head restraint. If needed, you can also remove the head restraints.

# Child Safety

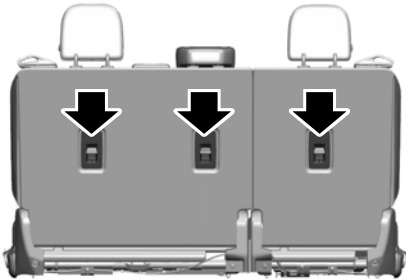

2. Locate the correct anchor on the back panel of the rear seat for the selected seating position. The anchors are labeled with the tether strap symbol.



3. Clip the tether strap to the anchor as shown.
4. Tighten the child restraint tether strap according to the manufacturer's instructions.

If your child restraint system has a tether strap, and the child restraint manufacturer recommends its use, we also recommend its use.

## BOOSTER SEATS

**WARNING:** Do not put the shoulder section of the seatbelt or allow the child to put the shoulder section of the seatbelt under their arm or behind their back. Failure to follow this instruction could reduce the effectiveness of the seatbelt and increase the risk of injury or death in a crash.

Use a belt-positioning booster seat for children who have outgrown or no longer properly fit in a child safety restraint (generally children who are less than 57 in (1.45 m) tall, are greater than age 4 and less than age 12, and between 40 lb (18 kg) and 80 lb (36 kg) and upward to 100 lb (45 kg) if recommended by your child restraint manufacturer). Many state and provincial laws require that children use approved booster seats until they reach age eight, a height of 57 in (1.45 m) tall, or 80 lb (36 kg).

Booster seats should be used until you can answer YES to ALL of these questions when seated without a booster seat:

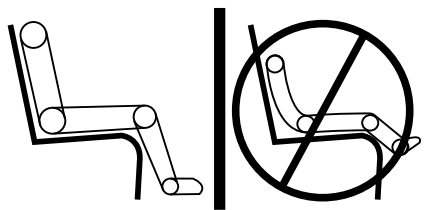

- Can the child sit all the way back against their vehicle seat backrest with knees bent comfortably at the edge of the seat cushion?
- Can the child sit without slouching?

# Child Safety

- Does the lap belt rest low across the hips?
- Is the shoulder belt centered on the shoulder and chest?
- Can the child stay seated like this for the whole trip?

Always use booster seats in conjunction with your vehicle lap and shoulder belt.

## Types of Booster Seats



- Backless booster seats

If your backless booster seat has a removable shield, remove the shield. If a vehicle seating position has a low seat backrest or no head restraint, a backless booster seat may place your child's head (as measured at the tops of the ears) above the top of the seat. In this case, move the backless booster to another seating position with a higher seat backrest or head restraint and lap and shoulder belts, or consider using a high back booster seat.



- High back booster seats

If, with a backless booster seat, you cannot find a seating position that adequately supports your child's head, a high back booster seat would be a better choice.

Children and booster seats vary in size and shape. Choose a booster that keeps the lap belt low and snug across the hips, never up across the stomach, and lets you adjust the shoulder belt to cross the chest and rest snugly near the center of the shoulder. The following drawings compare the ideal fit (center) to a shoulder belt uncomfortably close to the neck and a shoulder belt that could slip off the shoulder. The drawings also show how the lap belt should be low and snug across the child's hips.



# Child Safety



If the booster seat slides on the vehicle seat upon which it is being used, placing a rubberized mesh sold as shelf or carpet liner under the booster seat may improve this condition. Do not introduce any item thicker than this under the booster seat. Check with the booster seat manufacturer's instructions.

## CHILD RESTRAINT POSITIONING



**WARNING:** Do not place a rearward facing child restraint in front of an active airbag. Failure to follow this instruction could result in personal injury or death.



**WARNING:** Properly secure children 12 years old and under in a rear seating position whenever possible. If you are unable to properly secure all children in a rear seating position, properly secure the largest child on the front seat. If you must use a forward facing child restraint on the front seat, move the seat as far back as possible. Failure to follow these instructions could result in personal injury or death.



**WARNING:** Always carefully follow the instructions and warnings provided by the manufacturer of any child restraint to determine if the restraint device is appropriate for your child's size, height, weight, or age. Follow the child restraint manufacturer's instructions and

# Child Safety

warnings provided for installation and use in conjunction with the instructions and warnings provided by your vehicle manufacturer. A safety seat that is improperly installed or utilized, is inappropriate for your child's height, age, or weight or does not properly fit the child may increase the risk of serious injury or death.



**WARNING:** Do not allow a passenger to hold a child on their lap when your vehicle is moving. Failure to follow this instruction could result in personal injury or death in the event of a sudden stop or crash.



**WARNING:** Do not use pillows, books or towels to boost your child's height. Failure to follow this instruction could result in personal injury or death.



**WARNING:** Properly secure child restraints or booster seats when they are not in use. They could become projectiles in a sudden stop or crash. Failure to follow this instruction could result in personal injury or death.



**WARNING:** Do not put the shoulder section of the seatbelt or allow the child to put the shoulder section of the seatbelt under their arm or behind their back. Failure to follow this instruction could reduce the effectiveness of the seatbelt and increase the risk of injury or death in a crash.



**WARNING:** Do not leave children or pets unattended in your vehicle. Failure to follow this instruction could result in personal injury or death.

# Child Safety

## Recommendations for Attaching Child Safety Restraints for Children

Restraint Type	Combined Weight of Child and Child Restraint	Use Any Attachment Method as Indicated Below by X				
		LATCH (Lower Anchors and Top Tether Anchor)	LATCH (Lower Anchors Only)	Seatbelt and Top Tether Anchor	Seatbelt and LATCH (Lower Anchors and Top Tether Anchor)	Seatbelt Only
Rear facing child restraint	Up to 65 lb (29.5 kg)		X			X
Rear facing child restraint	Over 65 lb (29.5 kg)					X
Forward facing child restraint	Up to 65 lb (29.5 kg)	X		X	X	
Forward facing child restraint	Over 65 lb (29.5 kg)			X	X	

**Note:** The child restraint must rest tightly against the vehicle seat upon which it is installed. It may be necessary to lift or remove the head restraint. See **Seats** (page 133).

## CHILD SAFETY LOCKS

When these locks are set, you cannot open the rear doors from the inside.

# Child Safety

---

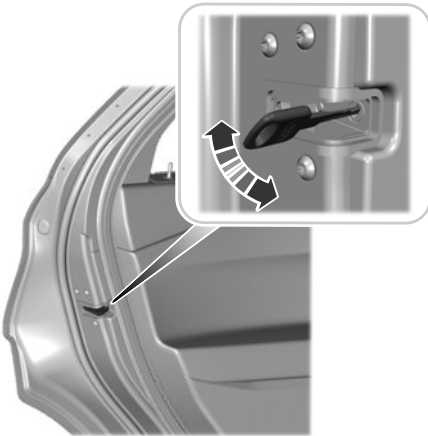

A child safety lock is on the rear edge of each rear door. You must set the child safety lock separately on each door.

## **Left-Hand Side**

Turn the key clockwise to switch the child lock on and counter clockwise to switch it off.

## **Right-Hand Side**

Turn the key counter clockwise to switch the child lock on and clockwise to switch it off.

# Seatbelts

## PRINCIPLE OF OPERATION



**WARNING:** Always drive and ride with your seatback upright and the lap belt snug and low across the hips.



**WARNING:** Children must always be properly restrained.



**WARNING:** Do not allow a passenger to hold a child on their lap when your vehicle is moving. Failure to follow this instruction could result in personal injury or death in the event of a sudden stop or crash.



**WARNING:** All occupants of your vehicle, including the driver, should always properly wear their seatbelts, even when an airbag supplemental restraint system is provided. Failure to properly wear your seatbelt could seriously increase the risk of injury or death.



**WARNING:** It is extremely dangerous to ride in a cargo area, inside or outside of a vehicle. In a crash, people riding in these areas are more likely to be seriously injured or killed. Do not allow people to ride in any area of your vehicle that is not equipped with seats and seatbelts. Make sure everyone in your vehicle is in a seat and properly using a seatbelt. Failure to follow this warning could result in serious personal injury or death.



**WARNING:** In a rollover crash, an unbelted person is significantly more likely to die than a person wearing a seatbelt.



**WARNING:** Each seating position in your vehicle has a specific seatbelt assembly made up of one buckle and one tongue designed to be used as a pair. Use the shoulder belt on the outside shoulder only. Never wear the shoulder belt under the arm. Never use a single seatbelt for more than one person.



**WARNING:** Even with advanced restraints systems, properly restrain children 12 and under in a rear seating position. Failure to follow this could seriously increase the risk of injury or death.



**WARNING:** Seatbelts and seats may be hot in a vehicle that is in the sunshine. The hot seatbelts or seats may burn a small child. Check seat covers and buckles before you place a child anywhere near them.

All seating positions in your vehicle have lap and shoulder seatbelts. All occupants of the vehicle should always properly wear their seatbelts, even when an airbag supplemental restraint system is provided.

The seatbelt system consists of:

- Lap and shoulder seatbelts.
- Shoulder seatbelt with automatic locking mode, (except driver seatbelt).
- Height adjuster at the front outermost seating positions.
- Seatbelt pretensioners at the front outermost and second row outermost seating positions.
- Belt tension sensor at the front outermost passenger seating position.



- Seatbelt warning light and chime.

# Seatbelts



- Crash sensors and monitoring system with readiness indicator.

The seatbelt pretensioners are designed to tighten the seatbelts when activated. In frontal and near-frontal crashes, the seatbelt pretensioners may be activated alone or, if the crash is of sufficient severity, together with the front airbags. The pretensioners may also activate when a Safety Canopy airbag deploys.

## FASTENING THE SEATBELTS

The front outboard and rear safety restraints in the vehicle are combination lap and shoulder belts.



1. Insert the belt tongue into the proper buckle (the buckle closest to the direction the tongue is coming from) until you hear a snap and feel it latch. Make sure the tongue is securely fastened in the buckle.

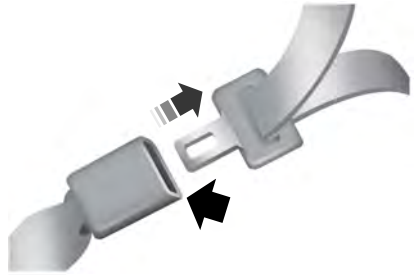

2. To unfasten, press the release button and remove the tongue from the buckle.

## Using Seatbelts During Pregnancy

 **WARNING:** Always ride and drive with your seatback upright and properly fasten your seatbelt. Fit the lap portion of the seatbelt snugly and low across the hips. Position the shoulder portion of the seatbelt across your chest. Pregnant women must follow this practice. See the following figure.

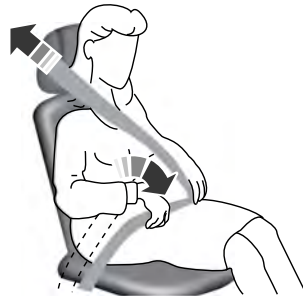

# Seatbelts

Pregnant women should always wear their seatbelt. Position the lap belt portion of a combination lap and shoulder belt low across the hips below the belly and worn as tight as comfort allows. Position the shoulder belt to cross the middle of the shoulder and the center of the chest.

## Seatbelt Locking Modes



**WARNING:** If your vehicle is involved in a crash, have the seatbelts and associated components inspected as soon as possible. Failure to follow this instruction could result in personal injury or death.

All safety restraints in the vehicle are combination lap and shoulder belts. The driver seatbelt has the first type of locking mode, and the front outboard passenger and rear seat seatbelts have both types of locking modes described as follows:

### Vehicle Sensitive Mode

This is the normal retractor mode, which allows free shoulder belt length adjustment to your movements and locking in response to vehicle movement. For example, if the driver brakes suddenly or turns a corner sharply, or the vehicle receives an impact of about 5 mph (8 km/h) or more, the combination seatbelts lock to help reduce forward movement of the driver and passengers.

In addition, the retractor is designed to lock if you pull the webbing out too quickly. If the seatbelt retractor locks, slowly lower the height adjuster to allow the seatbelt to retract. If the retractor does not unlock, pull the seatbelt out slowly then feed a

small length of webbing back toward the stowed position. For rear seatbelts, recline the rear seat backrest or push the seat backrest cushion away from the seatbelt. Feed a small length of webbing back toward the stowed position.

### Automatic Locking Mode

In this mode, the shoulder belt automatically pre-locks. The belt still retracts to remove any slack in the shoulder belt.

Automatic locking mode is not available on the driver seatbelt.

### When to Use the Automatic Locking Mode

Use this mode any time a child safety seat, except a booster, is installed in passenger front or rear seating positions. Properly restrain children 12 years old and under in a rear seating position whenever possible. See **Child Safety** (page 21).

### How to Use the Automatic Locking Mode



1. Buckle the combination lap and shoulder belt.

# Seatbelts

2. Grasp the shoulder portion and pull downward until you pull the entire belt out. Allow the belt to retract. As the belt retracts, you will hear a clicking sound. This indicates the seatbelt is now in the automatic locking mode.

## How to Disengage the Automatic Locking Mode

Unbuckle the combination lap and shoulder belt and allow it to retract completely to disengage the automatic locking mode and turn on the vehicle sensitive (emergency) locking mode.

## How to Extract Seatbelts in the Rear Outermost Positions

Seatbelts in the rear outermost positions can lock if you firmly return the seat backrest to its upright position. You can unlock the seatbelts using the following procedures.

For vehicles where the rear seats recline:

1. Recline the seat to its full rear recline position.
2. The seatbelt should then unlock.
3. Return the seat backrest to its desired upright position.

For vehicles with rear seats that do not recline or are locked with the seat in its full rear recline position:

1. Grasp the seatbelt webbing at the top of the seat backrest.
2. Pull the seatbelt webbing forward, firmly.
3. After pulling the seatbelt forward, allow the seatbelt to feed back into the seatbelt retractor as much as possible. If necessary, press the seat backrest down to allow the seatbelt webbing to retract further.
4. The seatbelt should then unlock.

5. If the seatbelt does not unlock, repeat steps 1-3.

## SEATBELT HEIGHT ADJUSTMENT

 **WARNING:** Position the seatbelt height adjusters so that the belt rests across the middle of your shoulder. Failure to adjust the seatbelt correctly could reduce the effectiveness of the seatbelt and increase the risk of injury in a crash.



E87511

To adjust the shoulder belt height, squeeze the button and slide the height adjuster up or down. Release the button and pull down on the height adjuster to make sure it is locked in place.



# Seatbelts

## SEATBELT WARNING LAMP AND INDICATOR CHIME



This lamp illuminates and an indicator chime will sound if the driver seatbelt has not been fastened when the vehicle's ignition is turned on.

### Conditions of operation

If	Then
The driver seatbelt is not buckled before the ignition switch is turned to the on position...	The seatbelt warning lamp illuminates and the indicator chime sounds for a few seconds.
The driver seatbelt is buckled while the warning lamp is illuminated and the indicator chime is sounding...	The seatbelt warning lamp and indicator chime turn off.
The driver seatbelt is buckled before the ignition switch is turned to the on position...	The seatbelt warning lamp and indicator chime remain off.

## SEATBELT REMINDER



**WARNING:** The system will only provide protection when you use the seatbelt correctly.

This system monitors all seating positions and provides audio and graphic feedback.



This lamp illuminates and a warning tone sounds if you do not fasten your seatbelt when you switch the ignition on. The lamp and tone turn off when you fasten your seatbelt or about one minute has elapsed.

When the initial warning expires for the driver, more warnings are provided for the driver and front passenger. This lamp illuminates and a warning tone sounds if you or your front passenger do not fasten the seatbelt buckle and the vehicle speed exceeds 6 mph (9.7 km/h). To deactivate the warning, see Deactivating and Activating the Belt-Minder Feature.

**Note:** To avoid inadvertent warnings, do not place large objects on the seat.



This lamp illuminates when you switch the ignition on, identifying the number of seating positions with fastened buckles. It illuminates again when a seating position changes from unfastened to fastened.

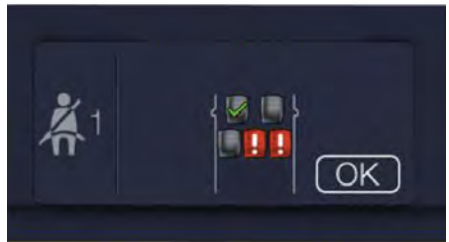

This warning displays and a tone sounds if an occupant unfastens the rear seatbelt buckle or it becomes unfastened.

# Seatbelts

**Note:** If a rear seat is unoccupied, or an occupant never fastens the seatbelt buckle to begin with, the warning will not display.

**Note:** Front seating positions appear in this warning display. Warnings for unfastened front seatbelt buckles appear in the initial warning lamp.

## Seatbelt Status

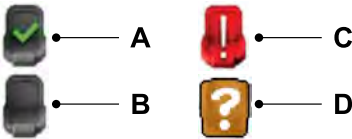
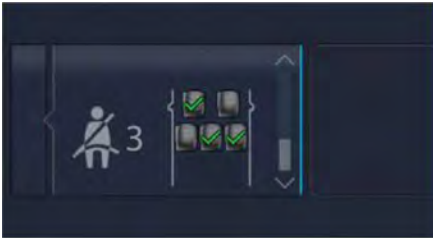

- A Seatbelt fastened.
- B Seatbelt not fastened.
- C Seatbelt recently unfastened.
- D Fault.

To view the seatbelt status, use the information display controls on the steering wheel.

## Deactivating and Activating the Seatbelt Reminder (Front Seats Only)

**WARNING:** While the system allows you to deactivate it, this system is designed to improve your chances of being safely belted and surviving an accident. We recommend you leave the system activated for yourself and others who may use the vehicle.

**Note:** The driver and front passenger warnings switch on and off independently. When you perform this procedure for one seating position, do not buckle the other position as this terminates the process.

Read Steps 1 - 4 before starting the procedure.

Make sure that:

- You set the parking brake.
  - The transmission is in park (P).
  - The ignition is off.
  - You close all vehicle doors.
  - You unbuckle the driver and front passenger seatbelts.
1. Switch the ignition on. Do not start the engine.
  2. Wait until the seatbelt warning lamp turns off (about one minute). After Step 2, wait an additional five seconds before proceeding with Step 3. Once you start Step 3, you must complete the procedure within 60 seconds.
  3. For the seating position you are switching off, buckle then unbuckle the seatbelt three times at a moderate speed, ending in the unbuckled state. After Step 3, the seatbelt warning lamp turns on.
  4. When the seatbelt warning lamp is on, buckle then unbuckle the seatbelt. After Step 4, the seatbelt warning lamp flashes for confirmation.

# Seatbelts

- This switches the feature off if it is currently on.
- This switches the feature on if it is currently off.

## CHILD RESTRAINT AND SEATBELT MAINTENANCE

Inspect the vehicle seatbelts and child safety seat systems periodically to make sure they work properly and are not damaged. Inspect the vehicle and child restraint seatbelts to make sure there are no nicks, tears or cuts. Replace if necessary. All vehicle seatbelt assemblies, including retractors, buckles, front seatbelt buckle assemblies, buckle support assemblies (slide bar-if equipped), shoulder belt height adjusters (if equipped), shoulder belt guide on seat backrest (if equipped), child safety seat LATCH and tether anchors, and attaching hardware, should be inspected after a crash. Read the child restraint manufacturer's instructions for additional inspection and maintenance information specific to the child restraint.

We recommend that all seatbelt assemblies in use in vehicles involved in a crash be replaced. However, if the crash was minor and an authorized dealer finds that the belts do not show damage and continue to operate properly, they do not need to be replaced. Seatbelt assemblies not in use during a crash should also be inspected and replaced if either damage or improper operation is noted.

Properly care for seatbelts. See **Vehicle Care** (page 289).

## SEATBELT EXTENSIONS



**WARNING:** Persons who fit into the vehicle's seatbelt should not use an extension. Unnecessary use could result in serious personal injury in the event of a crash.



**WARNING:** Only use extensions provided free of charge by our dealers. The dealer will provide an extension designed specifically for this vehicle, model year and seating position. The use of an extension intended for another vehicle, model year or seating position may not offer you the full protection of your vehicle's seatbelt restraint system.



**WARNING:** Never use seatbelt extensions to install child restraints.



**WARNING:** Do not use a seatbelt extension with an inflatable seatbelt.



**WARNING:** Do not use extensions to change the way the seatbelt fits across the torso, over the lap or to make the seatbelt buckle easier to reach.

If, because of body size or driving position, it is not possible to properly fasten the seatbelt over your lap and shoulder, an extension that is compatible with the seatbelts is available free of charge from our dealers. Only use our seatbelt extensions made by the original equipment seatbelt manufacturer with our seatbelts. Ask your authorized dealer if your extension is compatible with your vehicle restraint system.

# Personal Safety System™

---

The Personal Safety System provides an improved overall level of frontal crash protection to front seat occupants and is designed to help further reduce the risk of airbag-related injuries. The system is able to analyze different occupant conditions and crash severity before activating the appropriate safety devices to help better protect a range of occupants in a variety of frontal crash situations.

The Vehicle Personal Safety System consists of:

- Driver and passenger dual-stage airbag supplemental restraints.
- Front seat outermost seatbelts with pretensioners, energy management retractors and seatbelt usage sensors.
- Driver seat position sensor.
- Passenger seat position sensor.
- Front passenger sensing system.
- Passenger airbag off and on indicators.
- Front crash severity sensors.
- Restraints control module with impact and safing sensors.
- Restraint system warning lamp and tone.
- The electrical wiring for the airbags, crash sensors, seatbelt pretensioners, front seatbelt usage sensors, driver seat position sensor, front passenger sensing system and indicators.

## **How Does the Personal Safety System Work?**

The Personal Safety System can adapt the deployment strategy of the safety devices according to crash severity and occupant conditions. A collection of crash and occupant sensors provides information to the restraints control module. During a crash, the restraints control module may deploy the seatbelt pretensioners, one or both stages of the dual-stage airbags based on crash severity and occupant conditions.

# Supplementary Restraints System

## PRINCIPLE OF OPERATION

 **WARNING:** Airbags do not inflate slowly or gently, and the risk of injury from a deploying airbag is the greatest close to the trim covering the airbag module.

 **WARNING:** All occupants of your vehicle, including the driver, should always properly wear their seatbelts, even when an airbag supplemental restraint system is provided. Failure to properly wear your seatbelt could seriously increase the risk of injury or death.

 **WARNING:** Even with advanced restraints systems, properly restrain children 12 and under in a rear seating position. Failure to follow this could seriously increase the risk of injury or death.

 **WARNING:** Do not place your arms on the airbag cover or through the steering wheel. Failure to follow this instruction could result in personal injury.

 **WARNING:** Keep the areas in front of the airbags free from obstruction. Do not affix anything to or over the airbag covers. Objects could become projectiles during airbag deployment or in a sudden stop. Failure to follow this instruction could result in personal injury or death.

 **WARNING:** Airbags can kill or injure a child in a child restraint. Never place a rear-facing child restraint in front of an active airbag. If you must use a forward-facing child restraint in the front seat, move the seat upon which the child restraint is installed all the way back.

 **WARNING:** Do not attempt to service, repair, or modify the supplementary restraint system or associated components. Failure to follow this instruction could result in personal injury or death.

 **WARNING:** Several airbag system components get hot after inflation. To reduce the risk of injury, do not touch them after inflation.

 **WARNING:** If a supplementary restraint system component has deployed, it will not function again. Have the system and associated components inspected as soon as possible. Failure to follow this instruction could result in personal injury or death.

The airbags are a supplemental restraint system and are designed to work with the seatbelts to help protect the driver and right front passenger from certain upper body injuries. Airbags do not inflate slowly; there is a risk of injury from a deploying airbag.

**Note:** *You will hear a loud bang and see a cloud of harmless powdery residue if an airbag deploys. This is normal.*

The airbags inflate and deflate rapidly upon activation. After airbag deployment, it is normal to notice a smoke-like, powdery residue or smell the burnt propellant. This may consist of cornstarch, talcum powder (to lubricate the bag) or sodium compounds (for example, baking soda) that result from the combustion process that inflates the airbag. Small amounts of sodium hydroxide may be present which may irritate the skin and eyes, but none of the residue is toxic.

# Supplementary Restraints System

While the system is designed to help reduce serious injuries, contact with a deploying airbag may also cause abrasions or swelling. Temporary hearing loss is also a possibility as a result of the noise associated with a deploying airbag. Because airbags must inflate rapidly and with considerable force, there is the risk of death or serious injuries such as fractures, facial and eye injuries or internal injuries, particularly to occupants who are not properly restrained or are otherwise out of position at the time of airbag deployment. Thus, it is extremely important that occupants be properly restrained as far away from the airbag module as possible while maintaining vehicle control.

Routine maintenance of the airbags is not required.

## DRIVER AND PASSENGER AIRBAGS



**WARNING:** Do not place your arms on the airbag cover or through the steering wheel. Failure to follow this instruction could result in personal injury.



**WARNING:** Keep the areas in front of the airbags free from obstruction. Do not affix anything to or over the airbag covers. Objects could become projectiles during airbag deployment or in a sudden stop. Failure to follow this instruction could result in personal injury or death.



**WARNING:** Airbags can kill or injure a child in a child restraint. Never place a rear-facing child restraint in front of an active airbag. If you must use a forward-facing child restraint in the front seat, move the seat upon which the child restraint is installed all the way back.

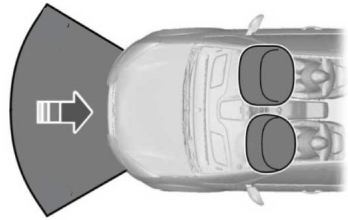

The driver and front passenger airbags will deploy during significant frontal and near frontal crashes.

The driver and passenger front airbag system consists of:

- Driver and passenger airbag modules.
- Front passenger sensing system.



• Crash sensors and monitoring system with readiness indicator. See **Crash Sensors and Airbag Indicator** (page 49).

## Proper Driver and Front Passenger Seating Adjustment



**WARNING:** National Highway Traffic Safety Administration (NHTSA) recommends a minimum distance of at least 10 in (25 cm) between an occupant's chest and the driver airbag module.

To properly position yourself away from the airbag:

- Move your seat to the rear as far as you can while still reaching the pedals comfortably.
- Recline the seat slightly (one or two degrees) from the upright position.

# Supplementary Restraints System

After all occupants have adjusted their seats and put on seatbelts, it is very important that they continue to sit properly. A properly seated occupant sits upright, leaning against the seatback, and centered on the seat cushion, with their feet comfortably extended on the floor. Sitting improperly can increase the chance of injury in a crash event. For example, if an occupant slouches, lies down, turns sideways, sits forward, leans forward or sideways, or puts one or both feet up, the chance of injury during a crash is greatly increased.

## Children and Airbags

**WARNING:** Airbags can kill or injure a child in a child restraint. Never place a rear-facing child restraint in front of an active airbag. If you must use a forward-facing child restraint in the front seat, move the seat upon which the child restraint is installed all the way back.



Children must always be properly restrained. Accident statistics suggest that children are safer when properly restrained in the rear seating positions than in the front seating position. Failure to follow these instructions may increase the risk of injury in a crash.

## FRONT PASSENGER SENSING SYSTEM

**WARNING:** Even with advanced restraints systems, properly restrain children 12 and under in a rear seating position. Failure to follow this could seriously increase the risk of injury or death.

**WARNING:** Sitting improperly, out of position or with the seatback reclined too far can take weight off the seat cushion and affect the decision of the passenger sensing system, resulting in serious injury or death in the event of a crash. Always sit upright against your seat back, with your feet on the floor.

**WARNING:** Any alteration or modification to the front passenger seat may affect the performance of the front passenger sensing system. This could seriously increase the risk of injury or death.

This system works with sensors that are part of the front passenger seat and seatbelt to detect the presence of a properly-seated occupant and determine if the front passenger frontal airbag should be enabled or not.



The indicators are on the center stack of the instrument panel.

# Supplementary Restraints System

The front passenger sensing system uses passenger airbag status indicators that illuminate indicating that the front passenger frontal airbag is either on or off.

**Note:** *The indicators briefly illuminate when you first switch the ignition on to confirm they are functional.*

The front passenger sensing system is designed to disable the front passenger frontal airbag under these conditions:

- The front passenger seat is unoccupied.
- The system determines an infant is present in a child restraint.
- A passenger takes their weight off of the seat for a period of time.
- If there is a problem with the airbag system or the passenger sensing system.

Even with this technology, parents are strongly encouraged to always properly restrain children in the rear seat.

- When the front passenger sensing system disables the front passenger frontal airbag, the passenger airbag status off indicator illuminates and stays lit to remind you that the front passenger frontal airbag is disabled.
- If you have installed the child restraint and the passenger airbag status on indicator illuminates, switch the vehicle off, remove the child restraint from the vehicle and reinstall the restraint following the child restraint manufacturer's instructions.

The front passenger sensing system is designed to enable the front passenger frontal airbag anytime the system senses that a person of adult size is sitting properly in the front passenger seat.

- When the front passenger sensing system enables the front passenger frontal airbag, the passenger airbag status on indicator illuminates.

If a person of adult size is sitting in the front passenger seat, but the passenger airbag is disabled, it is possible that the person is not sitting properly in the seat. If this happens:

- Switch the vehicle off and ask the person to place the seat backrest in an upright position.
- Have the person sit upright in the seat, centered on the seat cushion, with the person's legs comfortably extended.
- Restart the vehicle and have the person remain in this position for about two minutes. This allows the system to detect that person and enables the passenger frontal airbag.
- If the passenger airbag status off indicator remains illuminated even after this, advise the person to ride in the rear seat.

Occupant	Passenger Airbag Status Indicator	Passenger Airbag
Empty	OFF: Illuminated	Disabled
	ON: Not illuminated	
Child	OFF: Illuminated	Disabled



# Supplementary Restraints System

Occupant	Passenger Airbag Status Indicator	Passenger Airbag
	ON: Not illuminated	
Adult	OFF: Not illuminated	Enabled
	ON: Illuminated	

After all occupants have adjusted their seats and put on seatbelts, it is very important that they continue to sit upright, leaning against the seat backrest, and centered on the seat cushion, with their feet comfortably extended on the floor.

Sitting improperly can increase the chance of injury in a crash event. For example, if an occupant slouches, lies down, turns sideways, sits forward, leans forward or sideways, or puts one or both feet up, the chance of injury during a crash greatly increases.

If you think that the status of the passenger airbag off indicator is incorrect, check for the following:

- Objects lodged underneath the seat.
- Objects between the seat cushion and the center console.
- Objects hanging off the seat backrest.
- Objects stowed in the seat backrest map pocket.
- Objects placed on the occupant's lap.
- Cargo interference with the seat.
- Other passengers pushing or pulling on the seat.
- Rear passenger feet and knees resting or pushing on the seat.

The listed conditions may cause the weight of a properly seated occupant to be incorrectly interpreted by the passenger sensing system. The person in the front passenger seat may appear heavier or lighter due to the conditions listed.



Make sure the front passenger sensing system is operating properly. See **Crash Sensors and Airbag Indicator** (page 49).

Do not attempt to repair or service the system. Take your vehicle in for service immediately.

If it is necessary to modify an advanced front airbag system to accommodate a person with disabilities, contact your authorized dealer.

## SIDE AIRBAGS



**WARNING:** Do not place objects or mount equipment on or near the airbag cover, on the side of the front or rear seatbacks, or in areas that may come into contact with a deploying airbag. Failure to follow these instructions may increase the risk of personal injury in the event of a crash.



**WARNING:** Accessory seat covers not released by Ford Motor Company could prevent the deployment of the airbags and increase the risk of injuries in a crash.



**WARNING:** Do not lean your head on the door. The side airbag could injure you as it deploys from the side of the seatback.

# Supplementary Restraints System



**WARNING:** Do not attempt to service, repair, or modify the supplementary restraint system or associated components. Failure to follow this instruction could result in personal injury or death.



**WARNING:** If a supplementary restraint system component has deployed, it will not function again. Have the system and associated components inspected as soon as possible. Failure to follow this instruction could result in personal injury or death.

The side airbags are on the outermost side of each front and rear seat backrest. In certain sideways crashes or rollover events, the side airbags will be inflated. The airbag was designed to inflate between the door panel and occupant to further enhance the protection provided occupants in side impact crashes.



Properly restrain children 12 years old and under in the rear seats. The rear side airbag will not interfere with children restrained using a properly installed child or booster seat.

The system consists of the following:

- A label or embossed side panel indicating that side airbags are fitted to your vehicle.
- Side airbags inside the driver and front passenger seat backrests, as well as side airbags inside of each outermost rear seat backrest.



- Crash sensors and monitoring system with readiness indicator. See **Crash Sensors and Airbag Indicator** (page 49).

The design and development of the side airbag system included recommended testing procedures that were developed by a group of automotive safety experts known as the Side Airbag Technical Working Group. These recommended testing procedures help reduce the risk of injuries related to the deployment of side airbags.

## DRIVER KNEE AIRBAG

A driver's knee airbag is located under the instrument panel. During a crash, the restraints control module may activate the driver's knee airbag based on crash severity and occupant conditions. Under certain crash and occupant conditions, the driver's knee airbag may deploy but the driver's front airbag may not activate. As with front and side airbags, it is important to be properly seated and restrained to reduce the risk of death or serious injury.



- Make sure the knee airbag is operating properly. See **Crash Sensors and Airbag Indicator** (page 49).

# Supplementary Restraints System

## SAFETY CANOPY™

**WARNING:** Do not place objects or mount equipment on or near the headliner at the siderail that may come into contact with a deploying curtain airbag. Failure to follow these instructions may increase the risk of personal injury in the event of a crash.

**WARNING:** Do not lean your head on the door. The curtain airbag could injure you as it deploys from the headliner.

**WARNING:** Do not attempt to service, repair, or modify the supplementary restraint system or associated components. Failure to follow this instruction could result in personal injury or death.

**WARNING:** All occupants of your vehicle, including the driver, should always properly wear their seatbelts, even when an airbag supplemental restraint system is provided. Failure to properly wear your seatbelt could seriously increase the risk of injury or death.

**WARNING:** To reduce risk of injury, do not obstruct or place objects in the deployment path of the airbag.

**WARNING:** If a supplementary restraint system component has deployed, it will not function again. Have the system and associated components inspected as soon as possible. Failure to follow this instruction could result in personal injury or death.

The Safety Canopy deploys during significant side crashes or when a certain likelihood of a rollover event is detected by the rollover sensor. The Safety Canopy is mounted to the roof side rail sheet metal, behind the headliner, above each row of seats. In certain sideways crashes or rollover events, the Safety Canopy will be activated, regardless of which seats are occupied. The Safety Canopy is designed to inflate between the side window area and occupants to further enhance protection provided in side impact crashes and rollover events.

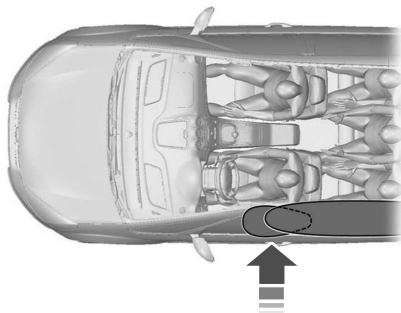

The system consists of the following:

- Safety Canopy curtain airbags above the trim panels over the front and rear side windows identified by a label or wording on the headliner or roof-pillar trim.
- A flexible headliner which opens above the side doors to allow air curtain deployment



- Crash sensors and monitoring system with a readiness indicator. See **Crash Sensors and Airbag Indicator** (page 49).

# Supplementary Restraints System

Properly restrain children 12 years old and under in the rear seats. The Safety Canopy will not interfere with children restrained using a properly installed child or booster seat because it is designed to inflate downward from the headliner above the doors along the side window opening.

The design and development of the Safety Canopy included recommended testing procedures that were developed by a group of automotive safety experts known as the Side Airbag Technical Working Group. These recommended testing procedures help reduce the risk of injuries related to the deployment of side airbags (including the Safety Canopy).

## CRASH SENSORS AND AIRBAG INDICATOR



**WARNING:** Modifying or adding equipment to the front end of your vehicle (including hood, bumper system, frame, front end body structure, tow hooks and hood pins) may affect the performance of the airbag system, increasing the risk of injury. Do not modify or add equipment to the front end of your vehicle.

Your vehicle has a collection of crash and occupant sensors which provide information to the restraints control module. The restraints control module deploys (activates) the seatbelt pretensioners, driver airbag, passenger airbag, knee airbag(s), seat mounted side airbags and the Safety Canopy. Based on the type of crash, the restraints control module deploys the appropriate safety devices.

The restraints control module also monitors the readiness of the above safety devices plus the crash and occupant sensors. The readiness of the safety system is indicated by a warning indicator light in the instrument cluster or by a backup tone if the warning light is not working. Routine maintenance of the airbag is not required.

A difficulty with the system is indicated by one or more of the following:



- The readiness light will not illuminate immediately after you switch the ignition on.
- The readiness light either flashes or stays lit.
- A series of five beeps is heard. The tone pattern repeats periodically until the problem, the light or both are repaired.

If any of these things happen, even intermittently, have the supplemental restraint system serviced at an authorized dealer immediately. Unless serviced, the system may not function properly in the event of a crash.

The restraint system is designed to activate when the vehicle sustains conditions sufficient to cause the restraint control module to deploy a safety device.

# Supplementary Restraints System

---

The fact that not all the safety devices activate for all occupants in a crash does not mean something is wrong with the system. Rather, it means the restraints control module determined the accident conditions (crash severity, type of crash, belt usage) were not appropriate to activate these safety devices.

- The front airbags are designed to activate only in frontal and near-frontal crashes (not rollovers, side impacts or rear impacts) unless the crash causes sufficient frontal deceleration.
- The front seatbelt pretensioners are designed to activate in frontal, near-frontal and side crashes, and in rollovers. The rear seatbelt pretensioners are designed to activate in frontal crashes and in rollovers.
- The knee airbag(s) may deploy based on crash severity and occupant conditions.
- The side airbags are designed to inflate in certain side impact crashes or rollover events. Side airbags may activate in other types of crashes if your vehicle experiences sufficient sideways motion or deformation, or a certain likelihood of rollover.
- The Safety Canopy is designed to inflate in certain side impact crashes or rollover events. The Safety Canopy may activate in other types of crashes if your vehicle experiences sufficient sideways motion or deformation, or a certain likelihood of rollover.

## AIRBAG DISPOSAL

Contact your authorized dealer as soon as possible. Airbags must be disposed of by qualified personnel.

# 911 Assist

## WHAT IS 911 ASSIST

911 Assist is a SYNC system feature that can call for help if you're in an accident. If a crash deploys an airbag (excluding knee airbags and rear inflatable seatbelts [if equipped]) or activates the fuel pump shut-off, your SYNC-equipped vehicle may be able to contact emergency services by dialing 911 through a paired and connected Bluetooth-enabled phone. You can learn more about the 911 Assist feature, by visiting:

Website
<a href="http://www.owner.ford.com">www.owner.ford.com</a> <a href="http://www.syncmyride.ca">www.syncmyride.ca</a> <a href="http://www.syncmaroute.ca">www.syncmaroute.ca</a>

Not all crashes will deploy an airbag or activate the fuel pump shut-off (the triggers for 911 Assist). If a connected cell phone sustains damage or loses its connection to SYNC during a crash, SYNC will search for and try to connect to a previously paired cell phone; SYNC will then attempt to call the emergency services.

Before making the call:

- SYNC provides a short window of time (about 10 seconds) to cancel the call. If you fail to cancel the call, SYNC attempts to dial 911.
- SYNC says the following, or a similar message: "SYNC will attempt to call 911, to cancel the call, press Cancel on your screen or press and hold the phone button on your steering wheel."

If you do not cancel the call, and SYNC makes a successful call, a pre-recorded message plays for the 911 operator, and then the occupant(s) in your vehicle is able to talk with the operator. Be prepared to provide your name, phone number and location immediately, because not all 911 systems are capable of receiving this information electronically.

During an emergency call, the system transmits vehicle data to the emergency service. See **Data Recording** (page 11).

## EMERGENCY CALL REQUIREMENTS



**WARNING:** Do not wait for 911 Assist to make an emergency call if you can do it yourself. Dial emergency services immediately to avoid delayed response time which could increase the risk of serious injury or death after a crash. If you do not hear 911 Assist within five seconds of the crash, the system or phone may be damaged or non-functional.



**WARNING:** Always place your phone in a secure location in your vehicle so it does not become a projectile or get damaged in a crash. Failure to do so may cause serious injury to someone or damage the phone which could prevent 911 Assist from working properly.



**WARNING:** Unless the 911 Assist setting is set on before a crash, the system will not dial for help which could delay response time, potentially increasing the risk of serious injury or death after a crash.

# 911 Assist

---

- SYNC must be powered and working properly at the time of the incident and throughout feature activation and use.
- The 911 Assist feature must be set on before the incident.
- You must pair and connect a Bluetooth enabled and compatible cell phone to SYNC.
- A connected Bluetooth enabled phone must have the ability to make and maintain an outgoing call at the time of the incident.
- A connected Bluetooth enabled phone must have adequate network coverage, battery power and signal strength.
- The vehicle must have battery power and be located in the U.S., Canada or in a territory in which 911 is the emergency number.

**Note:** *If any user sets 911 Assist to on or off, that setting applies for all paired phones. If 911 Assist is switched off and the phone is connected to SYNC, an icon displays on the status bar.*

**Note:** *Every phone operates differently. While SYNC 911 Assist works with most cellular phones, some may have trouble using this feature.*

## EMERGENCY CALL LIMITATIONS

The SYNC 911 Assist feature only operates in the U.S., Canada or in a territory in which 911 is the emergency number.

- Your cellular phone or 911 Assist hardware sustains damage in a crash.
- The vehicle's battery or the SYNC system has no power.
- The phone(s) thrown from your vehicle are the ones paired and connected to the system.

# Keys and Remote Controls

## GENERAL INFORMATION ON RADIO FREQUENCIES

This device complies with Part 15 of the FCC Rules and with Industry Canada license-exempt RSS standard(s). Operation is subject to the following two conditions: (1) This device may not cause harmful interference, and (2) This device must accept any interference received, including interference that may cause undesired operation.



**WARNING:** Changes or modifications not expressly approved by the party responsible for compliance could void the user's authority to operate the equipment. The term "IC:" before the radio certification number only signifies that Industry Canada technical specifications were met.

The typical operating range for your transmitter is approximately 33 ft (10 m). Vehicles with the remote start feature will have a greater range.

One of the following could cause a decrease in operating range:

- Weather conditions.
- Nearby radio towers.
- Structures around the vehicle.
- Other vehicles parked next to your vehicle.

The radio frequency used by your remote control can also be used by other radio transmitters, for example amateur radios, medical equipment, wireless headphones, wireless remote controls, cell phones, battery chargers and alarm systems. If the frequencies are jammed, you will not be able to use your remote control. You can lock and unlock the doors with the key.

**Note:** Make sure to lock your vehicle before leaving it unattended.

**Note:** If you are in range, the remote control will operate if you press any button unintentionally.

**Note:** The remote control contains sensitive electrical components. Exposure to moisture or impact may cause permanent damage.

## Intelligent Access (If Equipped)

The system uses a radio frequency signal to communicate with your vehicle and authorize your vehicle to unlock when one of the following conditions are met:

- You activate the front exterior door handle switch.
- You press the luggage compartment button.
- You press a button on the transmitter.

If excessive radio frequency interference is present in the area or if the transmitter battery is low, you may need to mechanically unlock your door. You can use the mechanical key blade in your intelligent access key to open the driver door in this situation. See **Remote Control** (page 53).

## REMOTE CONTROL

### Integrated Keyhead Transmitter

Use the key blade to start your vehicle, and unlock or lock the driver door from outside your vehicle. The integrated keyhead transmitter functions as a programmed ignition key that operates all the locks and starts your vehicle, as well as a remote control.



# Keys and Remote Controls

## Passive Key (If Equipped)



Press the button to release the key blade. Press and hold the button to fold the key blade back in when not in use.



**Note:** *Your vehicle keys came with a security label that provides important key cut information. Keep the label in a safe place for future reference.*

Your remote control operates the power locks and the remote start system. The key must be in your vehicle to use the push button start.

**Note:** *You may not be able to shift out of park (P) unless the passive key is inside your vehicle.*

### Removable Key Blade

Your remote control also contains a removable key blade that you can use to unlock your vehicle.

# Keys and Remote Controls



Press the release button and pull the key blade out.



**Note:** Your vehicle keys came with a security label that provides important key cut information. Keep the label in a safe place for future reference.

## Replacing the Battery

**WARNING:** Keep batteries away from children to prevent ingestion. Failure to follow this instruction could result in personal injury or death. If ingested, immediately seek medical attention.

**WARNING:** If the battery compartment does not securely close, stop using the remote control and replace it as soon as possible. In the meantime, keep the remote control away from children. Failure to follow this instruction could result in personal injury or death.

A message appears in the information display when the remote control battery is low. See **Information Messages** (page 104).

**Note:** Refer to local regulations when disposing of remote control batteries.

**Note:** Do not wipe off any grease on the battery terminals or on the back surface of the circuit board.

**Note:** Replacing the battery does not erase the programmed key from your vehicle. The remote control operates normally.

## Integrated Keyhead Transmitter

The remote control uses one coin-type three-volt lithium battery CR2032 or equivalent.

Press the button to release the key blade before beginning the procedure.



1. Insert a screwdriver in the position shown and gently push the clip.

## Keys and Remote Controls

2. Press the clip down to release the battery cover.

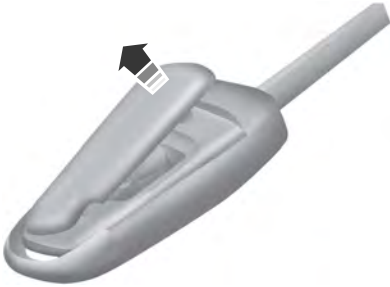

3. Carefully remove the cover.



**Note:** Do not touch the battery contacts or the printed circuit board with the screwdriver.

4. Insert a screwdriver as shown to release the battery.

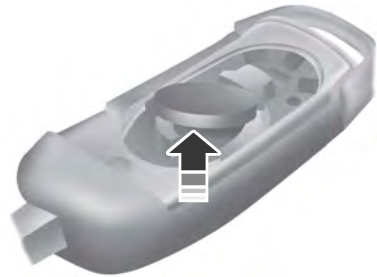

5. Remove the battery.
6. Install a new battery with the + facing up.
7. Replace the battery cover.

### Passive Key

The remote control uses one coin-type three-volt lithium battery CR2450 or equivalent.



1. Push the release button and pull the key blade out.

## Keys and Remote Controls

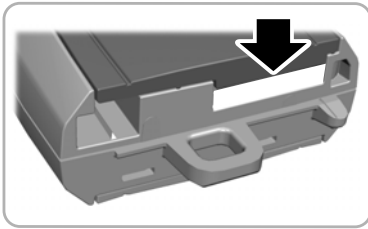

2. Twist a thin coin under the tab hidden behind the key blade head to remove the battery cover.

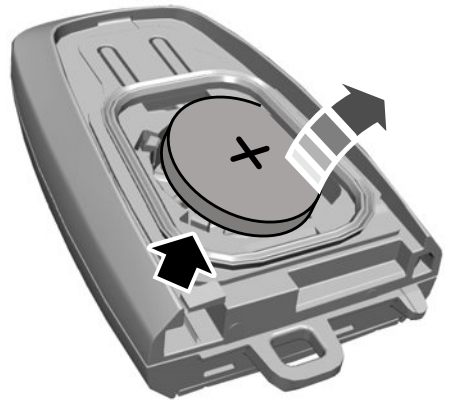

3. Insert a suitable tool, for example a screwdriver, in the position shown and carefully remove the battery.
4. Install a new battery with the + facing upward.
5. Reinstall the battery housing cover onto the remote control and install the key blade.

### Car Finder



Press the button twice within three seconds. The horn sounds and the direction indicators flash. We recommend you use this method to locate your vehicle, rather than using the panic alarm.

### Sounding a Panic Alarm



Press the button to activate the alarm. Press the button again or switch the ignition on to deactivate.

**Note:** *The panic alarm only operates when the ignition is off.*

# Keys and Remote Controls

---

## **REPLACING A LOST KEY OR REMOTE CONTROL**

Replacement or additional keys or remote controls can be purchased from your authorized dealer. Your dealer can program the transmitters to your vehicle.

## PRINCIPLE OF OPERATION

MyKey allows you to program keys with restricted driving modes to promote good driving habits. You can program the restrictions to all keys except one. Any keys that you did not program are administrator keys or admin keys.

You can use admin keys to:

- Create a MyKey with certain vehicle restrictions.
- Program certain MyKey settings.
- Clear all MyKey restrictions.

After you program a MyKey, you can view the following information through the information display:

- The total number of admin keys and MyKeys for your vehicle.
- The total distance a MyKey driver traveled with your vehicle.

**Note:** Every MyKey receives the same restrictions and settings. You cannot program them individually.

**Note:** For vehicles equipped with a push-button start switch: When both a MyKey and an admin key are present when you start your vehicle, the system recognizes the admin key only.

## Standard Settings

Not every vehicle includes the features listed below. If your vehicle has this equipment, then you cannot change the following settings when using a MyKey:

- Seatbelt reminder or Belt-Minder™. MyKey mutes the audio system until drivers, and in some instances, passengers, fasten their seatbelts.  
**Note:** If your vehicle includes an AM/FM radio or a very basic audio system, then the radio may not mute.
- Earlier low-fuel warning. The low-fuel warning activates earlier for MyKey drivers, giving them more time to refuel.
- Certain driver alerts, stability systems or parking aids turn on automatically when you use the MyKey system. For example, Blind Spot Information System (BLIS), cross traffic alert, lane departure warning or forward collision warning. **Note:** MyKey drivers may be able to turn the lane departure warning feature off, but this feature turns back on automatically with every new key cycle.
- Restricted touchscreen operation in some markets. For example, MyKey may prevent manual navigation destination input while the vehicle is in any gear other than park (P) or when the vehicle reaches a certain rate of speed.
- Satellite radio adult content restrictions, if this feature is available in your market.

## Optional Settings

You can configure certain vehicle feature settings when you first create a MyKey. You can also change the settings afterward with an admin key.

**Note:** *Not every feature applies to every vehicle in every market. When they are available for your vehicle, then they appear in your information display, providing choices to switch them on or off, or to select a more specific setting.*

- Various vehicle speed limits so the MyKey driver cannot exceed certain speeds. The information display shows warnings followed by an audible tone when the MyKey driver reaches the set speed. You cannot override the set speed by fully depressing the accelerator pedal.



**WARNING:** Do not set MyKey maximum speed limit to a limit that will prevent the driver from maintaining a safe speed considering posted speed limits and prevailing road conditions. The driver is always responsible to drive in accordance with local laws and prevailing conditions. Failure to do so could result in accident or injury.

- Various vehicle speed reminders so MyKey drivers know when their vehicle speed approaches the limits. Warnings appear in your information display and a tone sounds when the MyKey drivers exceed the set vehicle speed.
- The audio system's maximum volume limits to 45% so MyKey drivers can concentrate on the road. A message appears in the information display when MyKey drivers attempt to exceed the limited volume. MyKey also disables the automatic volume control. **Note:** If your vehicle includes an AM/FM radio or a very basic audio system, then the radio may not limit.
- Always on setting. This setting forces certain features to remain on and active for MyKey drivers. For example, E911 or emergency assistance and the do not disturb features stay on even if a MyKey driver uses the feature's control to switch it off. When selected, you will not be able to turn off Advance Trac or traction control (if your vehicle has this feature).

## CREATING A MYKEY

Use the touchscreen to create a MyKey:

1. Insert the key you want to program into the ignition. If your vehicle has a push-button start, place the remote control into the backup slot. See **Starting a Gasoline Engine** (page 149).
2. Switch the ignition on.
3. Access the main menu in the touchscreen and then scroll through the menus to change the settings of your MyKey. From the MyKey menu, select the option Create MyKey. See **Settings** (page 378).

4. Press Yes if you want to create the key as a MyKey. A confirmation message appears on the screen.
5. Switch the ignition off.

You have successfully created a MyKey. Make sure you label it so you can distinguish it from the admin keys.

You can also program configurable settings for the key.

## Programming and Changing Configurable Settings

Use the touchscreen to access your configurable MyKey settings.

1. Switch the ignition on using an admin key or the remote control you want to program.
2. Access the main menu in the information display and then scroll through the menus to change the settings of your MyKey. See **Settings** (page 378).
3. Follow the instructions in the touchscreen.

The programmed restrictions apply when you switch the vehicle off, open and close the driver door and restart your vehicle with the programmed key or remote control.

**Note:** *You can clear or change your MyKey settings at any time during the same key cycle as you created the MyKey. Once you have switched the vehicle off, however, you need an admin key to change or clear your MyKey settings. When you make any changes to your MyKey settings, you change the settings for every MyKey. You cannot make individual changes to apply to specific MyKeys.*

## CLEARING ALL MYKEYS

When you clear your MyKeys, you remove all restrictions and return all MyKeys to their original admin key status at once. To clear all MyKeys of all MyKey settings, use the touchscreen.

1. Switch the ignition on using an admin key.
2. Access the main menu in the touchscreen and then scroll through the menus to begin clearing your MyKey programming. See **Settings** (page 378).
3. Follow the instructions in the display.
4. A confirmation message appears in the display after you finish clearing your MyKeys.

**Note:** *When you clear your MyKeys, you remove all restrictions and return all MyKeys to their original admin key status. You cannot remove the MyKey restrictions individually.*

## CHECKING MYKEY SYSTEM STATUS

You can find information about your programmed MyKeys by using the touchscreen. See **Settings** (page 378).

### MyKey Distance

Tracks the distance when drivers use a MyKey. The only way to delete the accumulated distance is by using an admin key to clear all MyKeys. If the distance does not accumulate as expected, then the intended user is not using the MyKey, or an admin key user recently cleared and then recreated a MyKey.



## Number of MyKeys

Indicates the number of MyKeys you have programmed to your vehicle. Use this feature to detect how many MyKeys you have for your vehicle and determine when you have deleted all MyKeys.

## Number of Admin Keys

Indicates how many admin keys you have programmed to your vehicle. Use this feature to determine how many admin keys you have for your vehicle, and detect if an additional MyKey has been programmed.

## USING MYKEY WITH REMOTE START SYSTEMS

MyKey is not compatible with non Ford-approved, aftermarket remote start systems. If you choose to install a remote start system, see an authorized dealer for a Ford-approved remote start system.

## MYKEY – TROUBLESHOOTING

Condition	Potential causes
I cannot create a MyKey.	<ul style="list-style-type: none"> <li>· The key or transmitter used to start the vehicle does not have admin privileges.</li> <li>· Vehicles with keyless start: Make sure you place the transmitter into the backup slot. See <b>Starting a Gasoline Engine</b> (page 149).</li> <li>· The key or transmitter used to start the vehicle is the only admin key. There always has to be at least one admin key.</li> <li>· SecuriLock passive anti-theft system is disabled or in unlimited mode.</li> </ul>
I cannot program the configurable settings.	<ul style="list-style-type: none"> <li>· The key or transmitter used to start the vehicle does not have admin privileges.</li> <li>· There are no MyKeys programmed to the vehicle. See <b>Creating a MyKey</b> (page 60).</li> </ul>
I cannot clear the MyKeys.	<ul style="list-style-type: none"> <li>· The key or transmitter used to start the vehicle does not have admin privileges.</li> <li>· No MyKeys are created. See <b>Creating a MyKey</b> (page 60).</li> </ul>

# MyKey™

---

<b>Condition</b>	<b>Potential causes</b>
I lost the only admin key.	· Purchase a new key or transmitter from your authorized dealer.
I lost a key.	· Program a spare key or transmitter. You may need to see your authorized dealer. See <b>Starting a Gasoline Engine</b> (page 149).
MyKey distances do not accumulate.	· The MyKey user is not using the MyKey. · An admin key holder cleared the MyKeys and created new MyKeys. · The key system has been reset.

# Doors and Locks

## LOCKING AND UNLOCKING

You can use the power door lock control or the remote control to lock and unlock your vehicle.

**Note:** Do not use the door latch assembly to attach any accessory, such as handles or steps, as this can cause damage to your vehicle.

**Note:** Always take your keys and lock all doors when leaving your vehicle.

## Power Door Locks

The power door lock controls are on the driver and front passenger door panels.

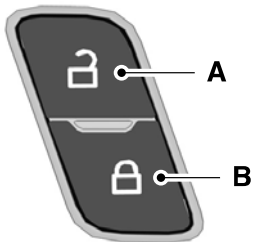

- A Unlock.
- B Lock.

## Remote Control

### Unlocking the Doors (Two-Stage Unlock)



Press the button to unlock the driver door.

Press the button again within three seconds to unlock all doors. The direction indicators flash.

To change between driver door or all door unlock mode, with the ignition off, press and hold both the lock and unlock buttons on the remote control for three seconds to change between driver door or all door unlock mode. The direction indicators flash twice to indicate a change to the unlocking mode. Driver door mode only unlocks the driver door when you press the unlock button once. All door mode unlocks all doors when you press the unlock button once. The unlocking mode applies to the remote control, keyless entry keypad and intelligent access.

## Locking the Doors



Press the button to lock all doors. The direction indicators flash.

Press the button again within three seconds to confirm that all the doors have closed. The doors lock again, the horn sounds and the direction indicators flash if all the doors and the luggage compartment have closed.

## Mislock

If any door or the liftgate is open, or if the hood is open on vehicles with an anti-theft alarm or remote start, the horn sounds twice and the direction indicators do not flash.

## Opening a Rear Door from the Inside

Pull the interior door handle twice to unlock and open a rear door. The first pull unlocks the door and the second pull opens the door.

# Doors and Locks

## Activating Intelligent Access (If Equipped)

### General Information

You can unlock and lock the vehicle without taking the keys out of your pocket or purse when your Passive key is within 3 ft (1 m) of your vehicle. Intelligent access uses a sensor on the back of the door handle for unlocking and a separate sensor on the face of each door handle for locking.

The system does not function if:

- Your vehicle battery has no charge.
- The key battery has no charge.
- The key frequencies are jammed.

**Note:** *The system may not function if the passive key is close to metal objects or electronic devices, for example keys or a cell phone.*

**Note:** *If the system does not function, use the key blade to lock and unlock your vehicle. See **Remote Control** (page 53).*

### Unlocking Using Intelligent Access



With your Passive key within 3 ft (1 m) of your vehicle, touch the unlock sensor on the back of the door handle for a brief period and then pull on the door handle to unlock, being careful to not touch the lock sensor at the same time or pulling the door handle too quickly. The intelligent access system requires a brief delay to authenticate your Passive key.

## Locking Using Intelligent Access

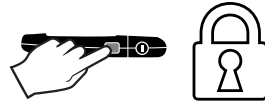

With your Passive key within 3 ft (1 m) of your vehicle, touch the outer door handle lock sensor for approximately one second to lock, being careful to not touch the unlock sensor on the back of the door handle at the same time. After locking, you can immediately pull on the door handle to confirm locking occurred without inadvertently unlocking.

### Smart Unlocks for Integrated Keyhead Transmitter (If Equipped)

This helps to prevent you from locking yourself out of your vehicle if the key is still in the ignition.

When you open one of the front doors and lock your vehicle with the power door lock control, all the doors lock then unlock and the horn sounds twice if the key is still in the ignition.

You can still lock your vehicle with the key in the ignition by either:

- Using the keyless entry keypad with the driver door closed.
- Pressing the lock button on the transmitter even if you have not closed the doors.

If you have closed both front doors, you can lock your vehicle by any method, regardless of whether the key is in the ignition or not.

# Doors and Locks

## Smart Unlocks for Passive keys (If Equipped)

This feature helps to prevent you from locking your passive key inside your vehicle's passenger compartment or rear cargo area. When you electronically lock your vehicle with any door open, the transmission in park (P) and the ignition off, the system searches for a passive key inside your vehicle after you close the last door. If the system finds a key, all the doors immediately unlock and the horn sounds twice, indicating that a key is inside.

When you open one of the front doors and lock your vehicle using the power door lock control, all doors lock then unlock if the ignition is on.

## Autolock (If Equipped)

Autolock locks all the doors when:

- All doors have closed.
- Your vehicle reaches a speed greater than 4 mph (7 km/h).
- The ignition is on.
- You shift into any gear putting your vehicle in motion.

Autolock repeats when:

- You open then close any door while the ignition is on and your vehicle speed is 4 mph (7 km/h) or lower.
- Your vehicle reaches a speed greater than 4 mph (7 km/h).

## Autounlock

Autounlock unlocks all the doors when:

- The ignition is on, all the doors have closed, and your vehicle has been moving at a speed greater than 7 mph (12 km/h).
- Your vehicle comes to a stop and you switch the ignition off or to the accessory position.
- You open the driver door within 10 minutes of switching the ignition off or to accessory.

**Note:** *The doors do not autounlock if you electronically lock your vehicle after you switch the ignition off and before you open the driver door.*

## Enabling or Disabling Autounlock

To enable or disable autounlock, see an authorized dealer.

## Illuminated Entry

The interior lamps and some exterior lamps illuminate when you unlock the doors with the remote control.

The illuminated entry system turns off the lights if:

- The ignition is on.
- You press the remote control lock button.
- After twenty-five seconds of illumination.

The lights do not turn off if:

- You turn them on with the lamp control.
- Any door is open.

## Illuminated Exit

The interior lamps and some exterior lamps illuminate when all doors have closed and you switch the ignition off.

# Doors and Locks

The lamps turn off if all the doors remain closed and:

- Twenty-five seconds have elapsed.
- You lock your vehicle from the outside.

## Battery Saver

If you leave the courtesy lamps, interior lamps or headlamps on, the battery saver shuts them off 10 minutes after you switch the ignition off.

## Accessory Mode Battery Saver for Passive Keys (If Equipped)

If you leave the ignition on after leaving your vehicle, it turns off 15 minutes after you close all of the doors.

## KEYLESS ENTRY (IF EQUIPPED)

### SECURICODE™ KEYLESS ENTRY KEYPAD

The keypad is located near the driver window. It is invisible until touched and then it lights up so you can see and touch the appropriate buttons.

**Note:** *If you enter your entry code too fast on the keypad, the unlock function may not work. Re-enter your entry code more slowly.*

1-2
3-4
5-6
7-8
9-0

You can use the keypad to:

- Lock or unlock the doors.
- Program and erase user codes.
- Arm and disarm the anti-theft alarm.

## Displaying the Master Access Code

To display the factory-set code in the information display:

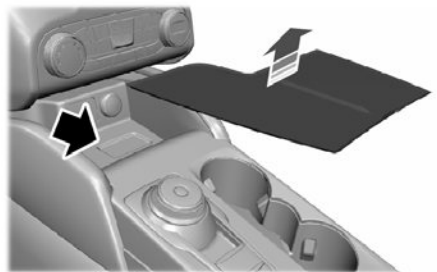

1. Remove the rubber mat.
2. Insert the first programmed key in the backup slot.
3. Press the push button ignition switch once and wait a few seconds.

# Doors and Locks

4. Press the push button ignition switch again and remove the key.
5. Within 10 seconds, place a second programmed intelligent access key in the backup slot and press the push button ignition switch.

The factory-set code appears in the information display for a few seconds.

**Note:** *You need to have two programmed intelligent access keys for this procedure.*

**Note:** *The code may not display until after any other warning messages first display.*

## Creating a Personal Entry Code Using the Keypad

1. Enter the factory-set code.
2. Press **1-2** on the keypad within five seconds.
3. Enter your personal five-digit code. You must enter each number within five seconds of each other.
4. Press **1-2** on the keypad to save personal code 1.

The doors lock then unlock to confirm that programming was successful.

To program additional personal entry codes, repeat Steps 1-3, then for Step 4:

- press **3-4** to save personal code 2.
- press **5-6** to save personal code 3.
- press **7-8** to save personal code 4.
- press **9-0** to save personal code 5.

### Tips:

- Do not set a code that uses five of the same number.
- Do not use five numbers in sequential order.
- The factory-set code works even if you have set your own personal code.

## Erasing a Personal Entry Code Using the Keypad

1. Enter the factory-set five-digit code.
2. Press and release **1-2** on the keypad within five seconds.
3. Press and hold **1-2** for two seconds. Do this within five seconds of completing Step 2.

All personal codes erase and only the factory-set five-digit code works.

## Creating a Personal Entry Codes Using the Touchscreen

You can create or erase your own personal entry code through the touchscreen settings. See **Settings** (page 378).

## Anti-Scan Feature

The keypad goes into an anti-scan mode if you enter the wrong code 7 times, or 35 button presses. This mode disables the keypad for one minute and the keypad lamp flashes.

The anti-scan feature turns off after:

- One minute of keypad inactivity.
- Pressing the unlock button on the remote control.
- Switching the ignition on.
- Unlocking the vehicle using intelligent access.

## Unlocking and Locking the Doors

### To Unlock the Driver Door

Enter the factory-set five-digit code or your personal code. You must press each number within five seconds of each other. The interior lamps illuminate.

**Note:** *All doors unlock if you disable the two-stage unlocking feature. See **Locking and Unlocking** (page 64).*

# Doors and Locks

---

## ***To Unlock All Doors***

Enter the factory-set code or your personal code, then press **3•4** within five seconds.

## ***To Lock All Doors***

Press and hold **7•8** and **9•0** at the same time with the driver door closed. You do not need to enter the keypad code first.



# Liftgate

## OPENING THE LIFTGATE

### Opening the Liftgate From Outside Your Vehicle

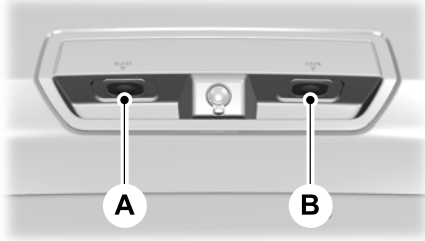

- A Glass.
- B Door.

1. Unlock the liftgate with the remote control or power door unlock control. If an intelligent access key is within 3 ft (1 m) of the liftgate, the liftgate unlocks when you press the liftgate release button.
2. Press button B.

**Note:** Be careful when opening or closing the liftgate in a garage or other enclosed area to avoid damaging the liftgate.

**Note:** Do not hang anything, for example a bike rack, from the glass or liftgate. This could damage the liftgate and its components.

**Note:** Do not leave the liftgate open while driving. This could damage the liftgate and its components.

### Opening the Liftgate Using the Remote Control



Press the button twice within three seconds. The liftgate unlocks for 45 seconds, during which time you can open the liftgate using the outside control button.

**Note:** Be careful when opening or closing the liftgate in a garage or other enclosed area to avoid damaging the liftgate.

**Note:** Do not hang anything, for example a bike rack, from the glass or liftgate. This could damage the liftgate and its components.

**Note:** Do not leave the liftgate open while driving. This could damage the liftgate and its components.

## CLOSING THE LIFTGATE

### Closing the Liftgate From Outside Your Vehicle



**WARNING:** It is extremely dangerous to ride in a cargo area, inside or outside of a vehicle. In a crash, people riding in these areas are more likely to be seriously injured or killed. Do not allow people to ride in any area of your vehicle that is not equipped with seats and seatbelts. Make sure everyone in your vehicle is in a seat and properly using a seatbelt. Failure to follow this warning could result in serious personal injury or death.

# Liftgate



**WARNING:** Make sure that you fully close the liftgate to prevent exhaust fumes from entering your vehicle. If you are unable to fully close the liftgate, open the air vents or the windows to allow fresh air to enter your vehicle. Failure to follow this instruction could result in personal injury or death.



Use the handles inside the liftgate to help with closing.

**Note:** Make sure that you fully close the liftgate to prevent cargo from falling out.

## OPENING AND CLOSING THE LIFTGATE WINDOW

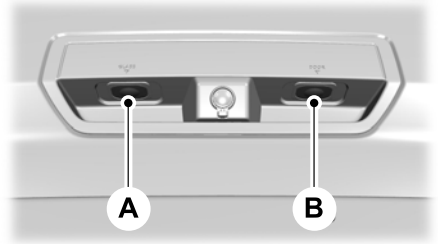

A Glass.

B Door.

1. Unlock the liftgate window with the remote control or power door unlock control. If an intelligent access key is within 3 ft (1 m) of the liftgate, the liftgate window unlocks when you press the release button.
2. Press button A and then lift to open.
3. Carefully push the window down and press firmly to latch securely.

**Note:** Be careful when opening or closing the liftgate window in a garage or other enclosed area to avoid damaging the glass.

**Note:** Do not hang anything, for example a bike rack, from the glass or liftgate. This could damage the liftgate and its components.

**Note:** Do not leave the liftgate window open while driving. This could damage the liftgate window and its components.

# Security

---

## PASSIVE ANTI-THEFT SYSTEM

**Note:** The system is not compatible with non-Ford aftermarket remote start systems. Use of these systems could result in vehicle starting problems and a loss of security protection.

**Note:** Metallic objects, electronic devices or a second coded key on the same key chain could cause vehicle starting problems if they are too close to the key when starting the engine. Prevent these objects from touching the coded key while starting the engine. Switch the ignition off, move all objects on the key chain away from the coded key and restart the engine if a problem occurs.

**Note:** Do not leave a duplicate coded key in the vehicle. Always take your keys and lock all doors when leaving the vehicle.

### SecuriLock®

The system is an engine immobilization system. It helps to prevent anyone from starting the engine without using a coded key programmed to your vehicle. Using the wrong key could prevent the engine from starting. A message may appear in the information display.

If you are unable to start the engine with a correctly coded key, there is a problem with the system and a message could appear in the information display.

### Automatic Arming

The vehicle arms immediately after you switch the ignition off.

### Automatic Disarming

Switching the ignition on with a coded key disarms the vehicle.

## Replacement Keys

**Note:** Your vehicle comes with two integrated keyhead transmitters or two intelligent access keys.

The integrated keyhead transmitter functions as a programmed ignition key that operates all the locks and starts the vehicle, as well as a remote control.

The intelligent access key functions as a programmed key that operates the driver door lock and activates the intelligent access with push button start system, as well as a remote control.

If your programmed transmitters or standard SecuriLock coded keys (integrated keyhead transmitters only) are lost or stolen and you do not have an extra coded key, you will need to have your vehicle towed to an authorized dealer. You need to erase the key codes from your vehicle and program new coded keys.

Store an extra programmed key away from the vehicle in a safe place to help prevent any inconveniences. See your authorized dealer to purchase additional spare or replacement keys.

### Programming a Spare Intelligent Access Key (If Equipped)

See your authorized dealer to have additional keys programmed to your vehicle.

## ANTI-THEFT ALARM

The system will warn you of an unauthorized entry to your vehicle. It will be triggered if any door, the luggage compartment or the hood is opened without using the key, remote control or keyless entry keypad.

The direction indicators will flash and the horn will sound if unauthorized entry is attempted while the alarm is armed.

# Security

---

Take all remote controls to an authorized dealer if there is any potential alarm problem with your vehicle.

## Arming the Alarm

The alarm is ready to arm when there is not a key in the ignition. Electronically lock the vehicle to arm the alarm.



The message indicator flashes when theft protection is active.

## Disarming the Alarm

Disarm the alarm by any of the following actions:

- Unlock the doors or luggage compartment with the remote control or keyless entry keypad.
- Switch the ignition on or start the vehicle.
- Use a key in the driver's door to unlock the vehicle, then switch the ignition on within 12 seconds.

**Note:** *Pressing the panic button on the remote control will stop the horn and signal indicators, but will not disarm the system.*

# Steering Wheel

## ADJUSTING THE STEERING WHEEL



**WARNING:** Do not adjust the steering wheel when your vehicle is moving.

**Note:** Make sure that you are sitting in the correct position. See **Sitting in the Correct Position** (page 133).

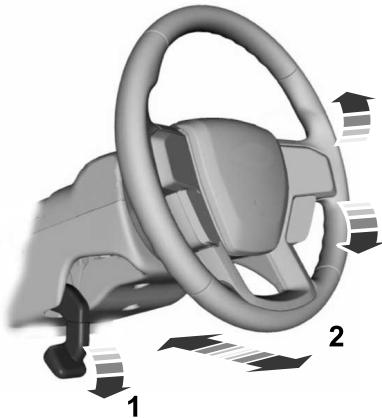

1. Unlock the steering column.
2. Adjust the steering wheel to the position you prefer.
3. Lock the steering column.

## AUDIO CONTROL



E280796



E280795

### You can operate the following functions with the control:



Press to decrease volume level.



Press to increase volume level.



Press to silence the current media



Press to access phone mode or to answer a phone call.



Press to end a phone call.

# Steering Wheel



Press to access the previous media selection.



Press to access the next media selection.

## VOICE CONTROL

The controls are on the steering wheel.



Press and release to activate voice recognition.

## CRUISE CONTROL - VEHICLES WITH: LANE CENTERING



See **Switching Adaptive Cruise Control On and Off** (page 198). See **Setting the Adaptive Cruise Control Speed** (page 199). See **Setting the Adaptive Cruise Control Gap** (page 200).

## CRUISE CONTROL



See **What Is Cruise Control** (page 193).

## INFORMATION DISPLAY CONTROL



E280795

See **General Information** (page 99).

## HORN



Press on the center of the steering wheel near the horn icon to activate the horn.

# Steering Wheel

---

## SWITCHING THE HEATED STEERING WHEEL ON AND OFF

(IF EQUIPPED)



To activate the heated steering wheel, press the button on the climate control unit.

On some vehicles, an indicator on the button illuminates when the heated steering wheel is on.

**Note:** *A sensor regulates the temperature of the steering wheel.*

# Wipers and Washers

## WINDSHIELD WIPERS



Push the lever up or down to operate the windshield wipers.

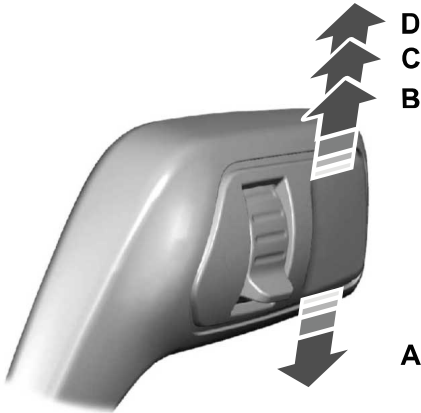

- A Single wipe.
- B Intermittent wipe.
- C Normal wipe.
- D High-speed wipe.

**Note:** Fully defrost the windshield before you switch the windshield wipers on.

**Note:** Make sure that you switch the windshield wipers off before entering a car wash.

**Note:** If streaks or smears appear on the windshield, clean the windshield and the wiper blades. If that does not resolve the issue, install new wiper blades.

**Note:** Do not operate the wipers on a dry windshield. This may scratch the glass, damage the wiper blades or cause the wiper motor to burn out. Always use the windshield washers before wiping a dry windshield.

## Intermittent Wipe

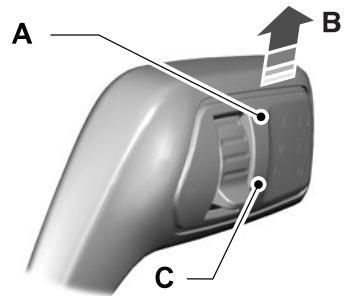

- A Shortest wipe interval.
- B Intermittent wipe.
- C Longest wipe interval.

Use the rotary control to adjust the intermittent wipe interval.

## Speed Dependent Wipers

When your vehicle speed increases, the interval between wipes decreases.

## AUTOWIPERS (IF EQUIPPED)

Wet or winter driving conditions with ice, snow or salty road mist can cause inconsistent and unexpected wiping or smearing.



# Wipers and Washers

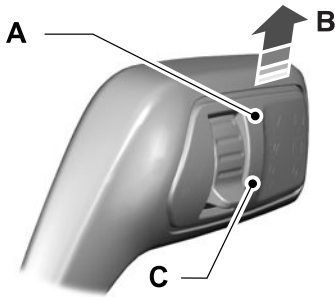

- A High sensitivity.
- B Autowipers On.
- C Low sensitivity.

Use the rotary control to adjust the sensitivity of the autowipers. When you select low sensitivity, the wipers operate when the sensor detects a large amount of water on the windshield. When you select high sensitivity, the wipers operate when the sensor detects a small amount of water on the windshield.

Keep the outside of the windshield clean. The rain sensor is very sensitive and the wipers may operate if dirt, mist or insects hit the windshield.

In these conditions, you can do the following:

- Lower the sensitivity of the autowipers to reduce the amount of smearing on the windshield.
- Switch to normal or high-speed wipe.
- Switch autowipers off.

**Note:** Fully defrost the windshield before you switch the windshield wipers on.

**Note:** Make sure that you switch the windshield wipers off before entering a car wash.

**Note:** If streaks or smears appear on the windshield, clean the windshield and the wiper blades. If that does not resolve the issue, install new wiper blades.

**Note:** If you switch autolamps and autowipers on, the headlamps turn on when the windshield wipers continuously operate.

## Autowipers Settings

Autowipers defaults to on and remains on until you switch it off in the information display. When you switch off autowipers, the wipers operate in intermittent mode.

## WINDSHIELD WASHERS



E242323



Pull the lever toward you to operate the windshield washers.

When you release the lever, the wipers operate for a short time. When activated, a courtesy wipe occurs a short time after the wipers stop to clear any remaining washer fluid.

**Note:** You can switch courtesy wipe on or off in the touchscreen. See **Settings** (page 378).

**Note:** Do not operate the washers when the washer reservoir is empty. This could cause the washer pump to overheat.

# Wipers and Washers

## Front Camera Washer (If Equipped)

Operating the windshield washer also turns on the front camera washer.

## REAR WINDOW WIPER AND WASHERS

### Rear Window Wiper

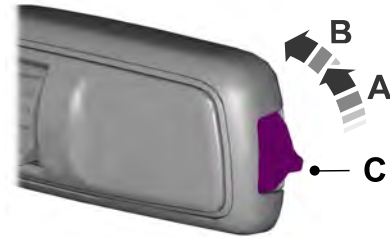

- A Intermittent wipe.
- B Continuous wipe.
- C Rear window wiper off.

Depending on your vehicle, when you switch on the front wipers and move the gearshift lever to reverse (R), the rear intermittent wipe may turn on.

**Note:** Make sure you switch the rear window wiper off before entering a car wash.

### Rear Window Washer



E242432

Push the lever away from you to operate the rear window washer. When you release the lever, the wipers operate for a short time.

Do not operate the washers when the washer reservoir is empty. This could cause the washer pump to overheat.

### Rear Camera Washer (If Equipped)

Switching on the rear washer also turns on the rear camera washer.

# Lighting

## GENERAL INFORMATION

### Condensation in the Exterior Front Lamps and Rear Lamps

Exterior front lamps and rear lamps have vents to accommodate normal changes in air pressure.

Condensation can be a natural by-product of this design. When moist air enters the lamp assembly through the vents, there is a possibility that condensation can occur when the temperature is cold. When normal condensation occurs, a fine mist can form on the interior of the lens. The fine mist eventually clears and exits through the vents during normal operation.

Clearing time may take as long as 48 hours under dry weather conditions.

Examples of acceptable condensation are:

- The presence of a fine mist (no streaks, drip marks or large droplets).
- A fine mist covers less than 50% of the lens.

Examples of unacceptable condensation are:

- A water puddle inside the lamp.
- Streaks, drip marks or large droplets present on the interior of the lens.

If you see any unacceptable condensation, have your vehicle checked by an authorized dealer.

## LIGHTING CONTROL

### Lighting Control Selections



E281337

Turn the dial to make a selection.

**Note:** *The indicator illuminates next to the active selection.*



Lamps off.



Parking lamps, instrument panel lamps, license plate lamps and rear lamps.



Autolamps.



Headlamps on.

**Note:** *The lighting control defaults to autolamps every time you switch your vehicle on.*

### Switching High Beam Headlamps On and Off



Push the lever away from you to switch the high beam on.

Push the lever forward again or pull the lever toward you to switch the high beams off.

# Lighting

## Flashing High Beam Headlamps



E248604

Pull the lever toward you and release it to flash the high beam headlamps.

## AUTOLAMPS



**WARNING:** The system does not relieve you of your responsibility to drive with due care and attention. You may need to override the system if it does not turn the headlamps on in low visibility conditions, for example daytime fog.

Autolamps turn the headlamps on in low light situations or when the wipers operate.



Switch the lighting control to the autolamps position.

**Note:** The lighting control defaults to autolamps each time you switch your vehicle on.

The headlamps remain on for a period of time after you switch the ignition off. Use the touchscreen to adjust the period of time that the headlamps remain on.

**Note:** If you switch the autolamps on, you cannot switch the high beams on until the system turns the low beams on.

## Windshield Wiper Activated Headlamps

When you switch the autolamps on, the headlamps turn on within 10 seconds of switching the wipers on. They turn off approximately 60 seconds after you switch the windshield wipers off.

The headlamps do not turn on with the wipers:

- During a single wipe.
- When using the windshield washers.
- If the wipers are in intermittent mode.

**Note:** If you switch the autolamps and the autowipers on, the headlamps turn on when the windshield wipers continuously operate.

## INSTRUMENT LIGHTING DIMMER

The instrument lighting dimmer buttons are on the lighting control.



Repeatedly press one of the buttons to adjust the brightness.



## HEADLAMP EXIT DELAY

After you switch the ignition off, you can switch the headlamps on by pulling the direction indicator lever toward you. You will hear a short tone. The headlamps will switch off automatically after three minutes with any door open or 30 seconds after the last door has been closed. You can cancel this feature by pulling the direction indicator lever toward you again or switching the ignition on.

# Lighting

## DAYTIME RUNNING LAMPS - VEHICLES WITH: CONFIGURABLE DAYTIME RUNNING LAMPS



**WARNING:** The daytime running lamps system does not activate the rear lamps and may not provide adequate lighting during low visibility driving conditions. Make sure you switch the headlamps on, as appropriate, during all low visibility conditions. Failure to do so may result in a crash.

Switch the daytime running lamps on or off using the touchscreen:

1. Select **Settings**. See **Settings** (page 378).
2. Select **Vehicle**.
3. Select **Lighting**.

The daytime running lamps turn on when:

1. The lamps are on in the information display.
2. You switch the ignition on.
3. The transmission is not in park (P) for vehicles with automatic transmissions or you release the parking brake for vehicles with manual transmissions.
4. The lighting control is in the autolamps position.
5. The headlamps are off.

The other lighting control switch positions do not turn on the daytime running lamps.

If the daytime running lamps are off in the information display, the lamps stay off in all switch positions.

## DAYTIME RUNNING LAMPS - VEHICLES WITH: DAYTIME RUNNING LAMPS (DRL)



**WARNING:** The daytime running lamps system does not activate the rear lamps and may not provide adequate lighting during low visibility driving conditions. Make sure you switch the headlamps on, as appropriate, during all low visibility conditions. Failure to do so may result in a crash.

The system turns the lamps on in daylight conditions.

To switch the system on, switch the lighting control to any position except headlamps.

## FRONT FOG LAMPS (IF EQUIPPED)

### Switching the Front Fog Lamps On or Off

Only switch the front fog lamps on during reduced visibility.

You can switch the front fog lamps on if any of the following occur:

- You set the lighting control to the parking lamps position.
- You set the lighting control to the headlamps position.
- You set the lighting control to the autolamps position and the headlamps are on.

The front fog lamp button is on the lighting control.



Press the button to switch the front fog lamps on or off.

# Lighting

**Note:** The brightness of the daytime running lamps may decrease when the front fog lamps are switched on.

## Front Fog Lamp Indicator



It illuminates when you switch the front fog lamps on.

## CORNERING LAMPS (IF EQUIPPED)

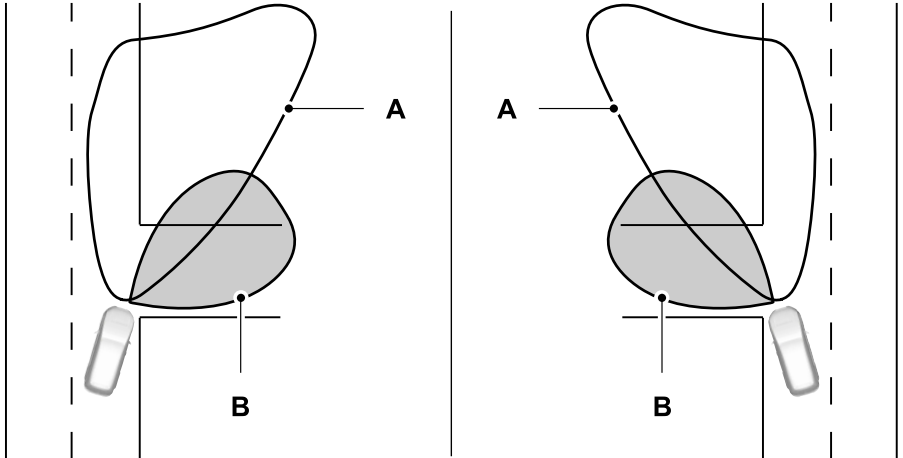

E72898

- A Headlamp beam.
- B Cornering lamp beam.

The cornering lamps illuminate the inside of a corner when you are turning the steering wheel.

# Lighting

## DIRECTION INDICATORS

### Switching the Direction Indicators On and Off



Push the lever up or down to switch the direction indicators on.

**Note:** Tap the lever up or down to make the direction indicators flash three times.

Set the lever to the middle position to switch the direction indicators off.

### Direction Indicator



Flashes when you switch the direction indicators on.

**Note:** An increase in the rate of flashing warns of a failed indicator bulb.

## INTERIOR LAMPS

### Switching All of the Interior Lamps On



Fully press the button on the overhead console towards the icon.

### Switching All of the Interior Lamps Off



Fully press the button on the overhead console towards the icon.

### Interior Lamp Function

#### Switching the Interior Lamp Function On

The switch is on the overhead console.

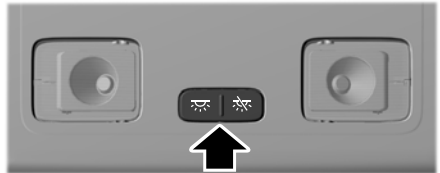

Set the switch to the middle position.

When you switch the interior lamp function on, the interior lamps turn on if:

- You open a door.
- You press the unlock button on the remote control.
- You switch the ignition off.

### Switching the Front Interior Lamps On and Off



E249791

Press the edge of the lamp lens.

# Lighting

## Switching the Rear Interior Lamps On and Off

Press the edge of the lamp lens.

**Note:** If the rear lamps are switched on through the overhead console, you cannot switch them off with the rear lamp switch.

## AMBIENT LIGHTING (IF EQUIPPED)

Use the touchscreen to select the following:



Select the settings option on the feature bar.

Select **Vehicle**.

Select **Ambient Light**.



## Switching Ambient Lighting On

Drag the slider above zero brightness.

## Adjusting the Brightness

Drag the slider left or right.

## Switching Ambient Lighting Off

Drag the slider left to zero brightness.

## REAR FLOODLAMPS

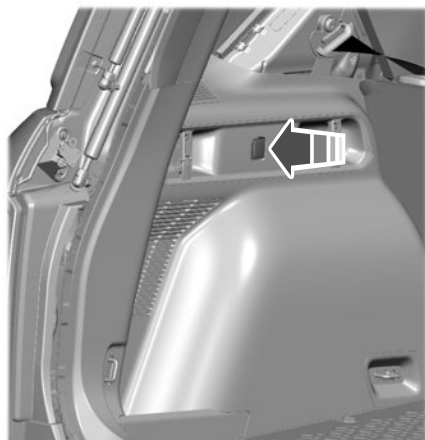

1. Open the liftgate or liftgate window.
2. Press the button on the left-hand side of the cargo area to switch the rear floodlamps on and off.

**Note:** The rear floodlamps turn off approximately 45 minutes after you switch them on.

**Note:** After the floodlamps time out twice, you need to start your vehicle before you can switch them on again.

**Note:** The rear floodlamps turn off when you close the liftgate or liftgate window.

The rear floodlamps can be rotated to direct light closer or further away from the rear of the vehicle.



# Automatic High Beam Control

## WHAT IS AUTOMATIC HIGH BEAM CONTROL

The system turns on high beams if it is dark enough and no other traffic is present. If it detects an approaching vehicle's headlamps or tail lamps, or street lighting ahead, the system turns the high beams off. Low beams remain on.

A camera sensor, centrally mounted behind the windshield of your vehicle, continuously monitors conditions to turn the high beams on and off.

## SWITCHING AUTOMATIC HIGH BEAM CONTROL ON AND OFF



**WARNING:** Do not use the system in poor visibility, for example fog, heavy rain, spray or snow.

1. Press **Settings** on the touchscreen.
2. Press **Vehicle**.
3. Press **Lighting**.

## Activating the Automatic High Beam Control



Switch the lighting control to the autolamps position. See **Autolamps** (page 81).

**Note:** The lighting control defaults to autolamps each time you switch your vehicle on.

When active, the high beams turn on if:

- The ambient light level is low enough.
- There is no traffic in front of your vehicle.
- The vehicle speed is greater than approximately 32 mph (51 km/h).

When active, the high beams turn off if:

- The ambient light level is high enough that high beams are not required.
- The system detects an approaching vehicle's headlamps or tail lamps.
- The system detects severe rain, snow or fog.
- The camera is blocked.
- The vehicle speed falls below approximately 27 mph (44 km/h).

**Note:** The deactivation speed is lower on curves.

**Note:** High beam reactivation may be delayed in certain curvy road situations.

**Note:** The system may not operate properly if the sensor is blocked. Keep the windshield free from obstruction or damage.

**Note:** The system may not operate properly in cold or inclement conditions. You can switch on the high beams by overriding the system.

**Note:** If the system detects a blockage, for example bird droppings, bug splatter, snow or ice, the system goes into low beam mode until you clear the blockage. A message may appear in the information display if the camera is blocked.

**Note:** Using much larger tires or equipping vehicle accessories such as snowplows can modify your vehicle's ride height and degrade automatic high beam control performance.

## AUTOMATIC HIGH BEAM CONTROL INDICATORS



The indicator illuminates to confirm when the system is ready to assist.

# Automatic High Beam Control

---

## OVERRIDING AUTOMATIC HIGH BEAM CONTROL



**WARNING:** The system does not relieve you of your responsibility to drive with due care and attention. You may need to override the system if it does not turn the high beams on or off.



**WARNING:** You may need to override the system when approaching other road users.



**WARNING:** You may need to override the system during inclement weather.



Push the lever away from you to switch between high beam and low beam.

# Windows and Mirrors

## POWER WINDOWS



**WARNING:** Do not leave children unattended in your vehicle and do not let them play with the power windows. Failure to follow this instruction could result in personal injury.



**WARNING:** When closing the power windows, verify they are free of obstruction and make sure that children and pets are not in the proximity of the window openings.



Press the control to open the window. Lift the control to close the window.

To reduce wind noise or pulsing noise when just one window is open, slightly open the opposite window.

### One-Touch Down (If Equipped)

Press the switch fully and release it. Press again or lift it to stop the window.

### One-Touch Up (If Equipped)

Lift the switch fully and release it. Press or lift it again to stop the window.

### Resetting One-Touch Up

Start the engine.

1. Lift and hold the window switch until you fully close the door window. Continue to hold the switch for a few seconds after you close the window.
2. Release the window switch.
3. Press and hold the window switch until you fully open the door window.
4. Release the window switch.
5. Lift and hold the window switch until you fully close the window.

6. Test for correct window operation by carrying out the one-touch down and one-touch up features.

## Rear Window Lock



Press the control to lock or unlock the rear window controls. It illuminates when you lock the rear window controls.

## Bounce-Back (If Equipped)

The window stops and reverses if it detects an obstruction.

## Overriding the Bounce-Back Feature



**WARNING:** If you override bounce-back, the window does not reverse if it detects an obstacle. Take care when closing the windows to avoid personal injury or damage to your vehicle.

Pull up the window switch and hold within a few seconds of the window reaching the bounce-back position. The window travels up with no bounce-back protection. The window stops if you release the switch before the window fully closes.

## Resetting Bounce-Back



**WARNING:** Bounce-back is off until you reset the memory. Take care when closing the windows to avoid personal injury or damage to your vehicle.

If you have disconnected the battery, you must reset the bounce-back memory separately for each window.

1. Lift and hold the switch until the window is fully closed.
2. Release the switch.

# Windows and Mirrors

3. Lift and hold the switch again for a few seconds.
4. Release the switch.
5. Lift and hold the switch again for a few seconds.
6. Release the switch.
7. Press and hold the switch until the window is fully open.
8. Lift and hold the switch until the window is fully closed.
9. Release the switch.
10. Open the window and then try to close it using one-touch close.

**Note:** Repeat the procedure if the window does not close when you use one-touch.

## Accessory Delay

You can use the window controls for several minutes after switching off the ignition or until opening either front door.

## GLOBAL OPENING AND CLOSING (IF EQUIPPED)

You can use the remote control to open the windows with the ignition off.

**Note:** You can enable or disable this feature in the information display or see an authorized dealer. See **General Information** (page 99).

**Note:** To operate this feature, accessory delay must not be active.

## Opening the Windows

You can only open the windows for a short time after you unlock your vehicle with the remote control. After you unlock your vehicle, press and hold the remote control unlock button to open the windows. Release the button once movement starts. Press the lock or unlock button to stop movement.

## Closing the Windows

**WARNING:** When closing the power windows, verify they are free of obstruction and make sure that children and pets are not in the proximity of the window openings.

To close the windows, press and hold the remote control lock button. Release the button once movement starts. Press the lock or unlock button to stop movement.

## EXTERIOR MIRRORS

### Power Exterior Mirrors

**WARNING:** Do not adjust the mirrors when your vehicle is moving. This could result in the loss of control of your vehicle, serious personal injury or death.



- A Left-hand mirror.
- B Right-hand mirror.

# Windows and Mirrors



Press the arrows to adjust the mirror.

## Fold-Away Exterior Mirrors

Push the mirror toward the door window glass. Make sure that you fully engage the mirror in its support when returning it to its original position.

## Signal Indicator Mirrors (If Equipped)

The outer portion of the appropriate mirror housing blinks when you switch on the turn signal.

## Blind Spot Monitor (If Equipped)

See **Blind Spot Information System** (page 211).

## INTERIOR MIRROR



**WARNING:** Do not adjust the mirrors when your vehicle is moving. This could result in the loss of control of your vehicle, serious personal injury or death.

**Note:** Do not clean the mirror housing or glass with harsh abrasives, fuel or other petroleum-based cleaning products.

You can adjust the interior mirror to your preference. Some mirrors also have a second pivot point. This lets you move the mirror head up or down and from side to side.

## Manual Dimming Mirror

Pull the tab below the mirror toward you to reduce the effect of bright light from behind.

## Automatic Dimming Mirror (If Equipped)

**Note:** Do not block the sensors on the front and back of the mirror. A rear center passenger or raised rear center head restraint may also block light from reaching the sensor.

The mirror dims to reduce the effect of bright light from behind. It returns to normal when the bright light from behind is no longer present or if you shift into reverse (R).

## SUN VISORS

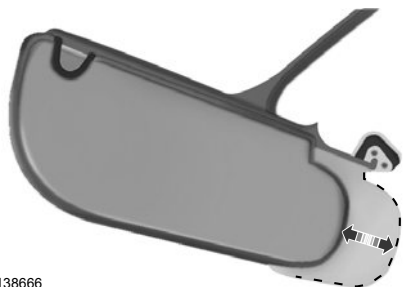

E138666

Rotate the sun visor toward the side window and extend it rearward for extra shade.

# Windows and Mirrors

## Illuminated Vanity Mirror (If Equipped)

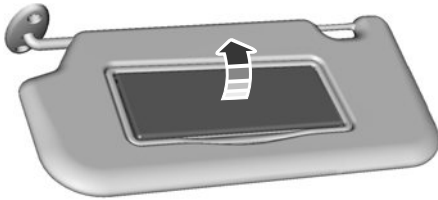

E162197

Lift the cover to switch the lamp on.

## MOONROOF (IF EQUIPPED)



**WARNING:** Do not leave children unattended in your vehicle and do not let them play with the moonroof. Failure to follow this instruction could result in personal injury.



**WARNING:** When closing the moonroof, verify that it is free of obstruction and make sure that children and pets are not in the proximity of the roof opening.

The moonroof and sunscreen controls are on the overhead console.

The Moonroof and sunscreen have a one-touch open and close feature, press the control all the way down and release. To stop them during one-touch operation, press the control a second time.

## Opening and Closing the Moonroof



- A **Moonroof open.** Press and release to open the moonroof.
- B **Moonroof vent or close.** Press and release to vent or close the moonroof. When the glass is closed, press to vent the moonroof.
- C **Sunshade open.** Press and release to open the sunshade. The sunshade opens with the moonroof. You can also open the sunshade with the moonroof closed.
- D **Sunshade close.** Press and release to close the sunshade.

## Bounce-Back

The moonroof stops when closing. It can reverse some distance if there is an obstacle in the way.

Press and hold the front of the control within two seconds of a bounce-back event to override this function. When bounce-back is active, the closing force increases for each of the next three times that you close the moonroof.

# Instrument Cluster

## GAUGES - VEHICLES WITH: 4.2 INCH INSTRUMENT CLUSTER DISPLAY SCREEN

### 4 Inch Display

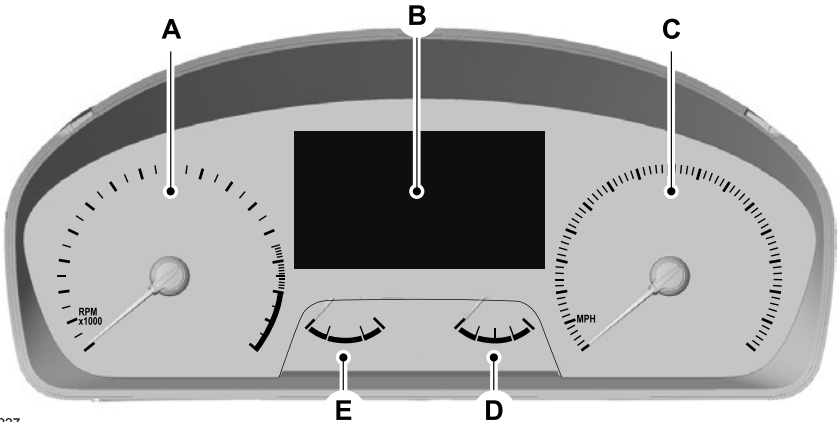

E282227

- A Tachometer.
- B Information display.
- C Speedometer.
- D Fuel gauge.
- E Engine coolant temperature gauge.

### Information Display

Information that appears depends on your vehicle settings. See **General Information** (page 99).

### Engine Coolant Temperature Gauge

Indicates engine coolant temperature. At normal operating temperature, the level indicator will be in the normal range. If the engine coolant temperature exceeds the normal range, stop your vehicle as soon as safely possible, switch off the engine and let the engine cool.

# Instrument Cluster



**WARNING:** Do not remove the coolant reservoir cap when the engine is on or the cooling system is hot. Wait 10 minutes for the cooling system to cool down. Cover the coolant reservoir cap with a thick cloth to prevent the possibility of scalding and slowly remove the cap. Failure to follow this instruction could result in personal injury.

## Fuel Gauge

The fuel gauge indicates about how much fuel is in the fuel tank.

The arrow adjacent to the fuel pump symbol indicates on which side of your vehicle the fuel filler door is located.

**Note:** *The fuel gauge may vary slightly when your vehicle is moving or on a slope.*

## Low Fuel Reminder

A low fuel level reminder displays and sounds when the distance to empty reaches 75 mi (120 km) to empty for MyKey, and at 50 mi (80 km), 25 mi (40 km), 10 mi (20 km) and 0 mi (0 km) for all vehicle keys.

**Note:** *The low fuel reminder can appear at different fuel gauge positions depending on fuel economy conditions. This variation is normal.*

## GAUGES - VEHICLES WITH: 6.5 INCH INSTRUMENT CLUSTER DISPLAY SCREEN

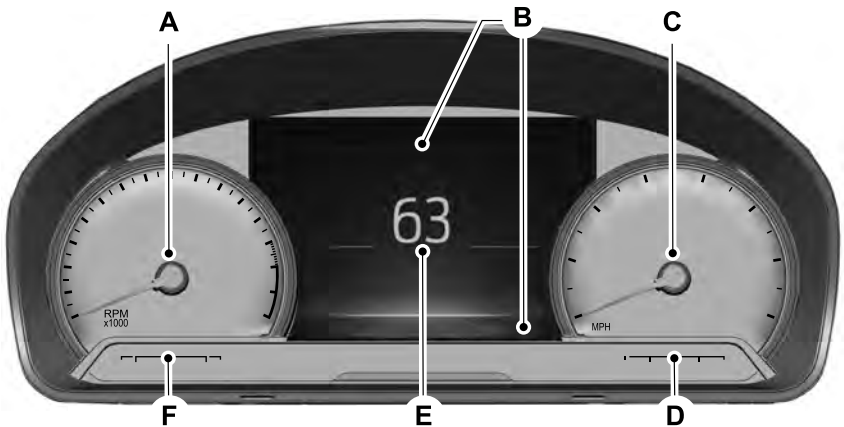

- A Tachometer.
- B Information bar.
- C Speedometer.



# Instrument Cluster

---

- D Fuel gauge.
- E Information display.
- F Engine coolant temperature gauge.

## Information Bar

Displays information related to the navigation, outside air temperature, odometer and distance to empty.

## Information Display

Displays information related to the navigation, outside air temperature, odometer and distance to empty.

## Fuel Gauge

The fuel gauge indicates about how much fuel is in the fuel tank.

The arrow adjacent to the fuel pump symbol indicates on which side of your vehicle the fuel filler door is located.

**Note:** *The fuel gauge may vary slightly when your vehicle is moving or on a slope.*

## Low Fuel Reminder

A low fuel level reminder displays and sounds when the distance to empty reaches 75 mi (120 km) to empty for MyKey, and at 50 mi (80 km), 25 mi (40 km), 10 mi (20 km) and 0 mi (0 km) for all vehicle keys.

**Note:** *The low fuel reminder can appear at different fuel gauge positions depending on fuel economy conditions. This variation is normal.*

## Distance to Empty

Indicates the approximate distance your vehicle can travel on the fuel remaining in the tank. Changes in driving pattern can cause the value to not only decrease but also increase or stay constant for periods of time.

## Engine Coolant Temperature Gauge



**WARNING:** Do not remove the coolant reservoir cap when the engine is on or the cooling system is hot. Wait 10 minutes for the cooling system to cool down. Cover the coolant reservoir cap with a thick cloth to prevent the possibility of scalding and slowly remove the cap. Failure to follow this instruction could result in personal injury.

Indicates engine coolant temperature. At normal operating temperature, the level indicator will be in the normal range. If the engine coolant temperature exceeds the normal range, stop your vehicle as soon as safely possible, switch off the engine and let the engine cool.

# Instrument Cluster

## WARNING LAMPS AND INDICATORS

The following warning lamps and indicators alert you to a vehicle condition that may become serious. Some lamps illuminate when you start your vehicle to make sure they work. If any lamps remain on after starting your vehicle, refer to the respective system warning lamp for further information.

**Note:** *Some warning indicators appear in the information display and function the same as a warning lamp, but do not display when you start your vehicle.*

**Note:** *Depending on your vehicle options and instrument cluster type, not all indicators display or are available.*

### Adaptive Cruise Control



The speed control system indicator light changes color to indicate what mode the system is in. See **How Does Adaptive Cruise Control With Stop and Go Work** (page 195).

On (white light): Illuminates when you switch on the adaptive cruise control system. Turns off when the speed control system is turned off.

Engaged (green light): Illuminates when you engage the adaptive cruise control system. Turns off when you disengage the speed control system.

### Anti-Lock Braking System



If it illuminates when you are driving, this indicates a system error. You continue to have the normal braking (without ABS) unless the brake system warning lamp also illuminates. Have the system checked by an authorized dealer.

### Automatic High Beam Control



Illuminates when this feature is on. See **Switching Automatic High Beam Control On and Off** (page 86).

### Auto Hold Active



Illuminates when the system holds your vehicle stationary.

### Auto Hold Unavailable



Illuminates when the system is on, but unavailable to hold your vehicle stationary.

### Auto-Start-Stop



Illuminates when the engine shuts down or in conjunction with a message.

### Battery



If it illuminates while driving, it indicates a system error. Switch off all unnecessary electrical equipment and have the system checked by an authorized dealer immediately.

### Blind Spot Monitor



Illuminates when you switch this feature off or in conjunction with a message. See **Blind Spot Information System** (page 211).

# Instrument Cluster

## Brake System Warning Lamp



**WARNING:** Driving your vehicle with the warning lamp on is dangerous. A significant decrease in braking performance may occur. It may take you longer to stop your vehicle. Have your vehicle checked as soon as possible. Driving extended distances with the parking brake engaged can cause brake failure and the risk of personal injury.

**Note:** *Indicators vary depending on region.*

This lamp is a dual function lamp and illuminates when:

- You apply the parking brake with the ignition on.
- Your vehicle has a brake fault or low brake fluid level, regardless of parking brake position.

**BRAKE**

If the lamp illuminates when you are moving, you may have the parking brake applied. Make sure the parking brake is off. Have your vehicle checked as soon as possible if the lamp continues to illuminate.



## Cruise Control



Illuminates when you switch this feature on.

## Direction Indicator



Illuminates when you switch on the left or right direction indicator or the hazard flasher. If the indicators stay on or flash faster, check for a burned out bulb. See **Changing a Bulb** (page 287).

## Door Ajar



Illuminates when the ignition is on and any door is not completely closed.

## Electric Park Brake

**Note:** *Indicators vary depending on region.*



Illuminates or flashes when the electric parking brake has a system error. See **Electric Parking Brake** (page 177).

## Engine Coolant Temperature Warning Lamp



Illuminates when the engine or motor coolant temperature is high. Stop your vehicle as soon as possible, switch your vehicle off and let it cool. See **Engine Coolant Check** (page 277).

## Engine Oil



If it illuminates with the engine running or when you are driving, this indicates a system error. Stop your vehicle as soon as it is safe to do so and switch the engine off. Check the engine oil level. See **Engine Oil Check** (page 274).

**Note:** *Do not resume your journey if it illuminates despite the level being correct. Have the system checked by an authorized dealer immediately.*

## Fasten Seatbelt



Illuminates and a tone sounds to remind you to fasten your seatbelt. See **Seatbelt Reminder** (page 38).

# Instrument Cluster

## Fasten Rear Seatbelt



Illuminates and a tone sounds to signal the rear seatbelts are not fastened.

## Front Airbag



If it fails to illuminate when you start your vehicle, continues to flash or remains on, it indicates there is a system error. Have the system checked as soon as possible.

## Front Fog Lamps



Illuminates when you switch the front fog lamps on.

## High Beam



Illuminates when you switch the high beam headlamps on. It flashes when you use the headlamp flasher.

## Hood Ajar



Illuminates when the ignition is on and the hood is not completely closed.

## Lamps On



Illuminates when you switch the low beam headlamps or the parking lamps on.

## Liftgate Ajar



Illuminates when the liftgate is not completely closed.

## Low Beam Warning



Illuminates when the low beam headlamp bulb is not functioning properly.

## Low Fuel Level



Illuminates when the fuel level is low or the fuel tank is nearly empty. Refuel as soon as possible.

## Low Tire Pressure Warning



Illuminates when your tire pressure is low. If the lamp remains on with the engine running or when driving, check your tire pressure as soon as possible.

It also illuminates momentarily when you switch the ignition on to confirm the lamp is functional. If it does not illuminate when you switch the ignition on, or begins to flash at any time, have the system checked by an authorized dealer.

## Low Washer Fluid



Illuminates when the windshield washer fluid is low.

## Malfunction Indicator Lamp



It illuminates when you switch the ignition on prior to engine start to check the bulb.

Normally, it illuminates until the engine is cranked and automatically turns off if no system errors are present.

If it illuminates when the engine is running this indicates a system error. The On Board Diagnostics system has detected an error in the vehicle emission control system. See **Emission Law** (page 162).

# Instrument Cluster

If it flashes, engine misfire may be occurring. Continuing to drive your vehicle may cause reduced power or the engine to stop. Failure to respond to the warning lamp may cause component damage not covered by the vehicle warranty. Have your vehicle checked as soon as possible.

## Powertrain Fault



Illuminates when the system detects a powertrain or a 4WD/AWD fault. Contact an authorized dealer as soon as possible.

## Rear Differential Lock



Illuminates when you lock the rear differential.

## Stability Control



It flashes when the system is active. If it remains illuminated or does not illuminate when you switch the ignition on, this indicates a system error. During a system error the system switches off. Have the system checked by an authorized dealer immediately. See **Using Stability Control** (page 183).

## Stability Control Off



Illuminates when you switch the system off. It goes out when you switch the system back on or when you switch the ignition off. See **Using Stability Control** (page 183).

## Trail Control



Illuminates when you switch trail control on.

## 4WD Lock



Illuminates when four-wheel drive is locked.

## AUDIBLE WARNINGS AND INDICATORS

### Key in Ignition Warning Chime

Sounds when you open the driver's door and you have left the key in the ignition.

### Keyless Warning Alert (If Equipped)

Sounds the horn twice when you exit your vehicle with the intelligent access key, after the last door is closed and your keyless vehicle is in RUN, indicating your vehicle is still on.

### Headlamps On Warning Chime

Sounds when you remove the key from the ignition and open the driver's door and you have left the headlamps or parking lamps on.

### Parking Brake On Warning Chime

Sounds when you have left the parking brake on and drive your vehicle. If the warning chime remains on after you have released the parking brake, have the system checked by an authorized dealer immediately.

# Information Displays

## GENERAL INFORMATION



**WARNING:** Driving while distracted can result in loss of vehicle control, crash and injury. We strongly recommend that you use extreme caution when using any device that may take your focus off the road. Your primary responsibility is the safe operation of your vehicle. We recommend against the use of any hand-held device while driving and encourage the use of voice-operated systems when possible. Make sure you are aware of all applicable local laws that may affect the use of electronic devices while driving.

You can control various systems on your vehicle using the quick action menu (QAM) buttons on the right-hand side of the steering wheel. The information display provides the corresponding information.

## Information Display Controls



E250032

- A Return button.
- B OK button.
- C Menu button.

## Return Button

Use the return button to go back or to exit.

## OK Button

Use the **OK** button to make a selection. You can also use it to scroll through a menu.

## Menu Button

Use the menu button on the main screen to display the submenu.

## 4 Inch Display Menu



This icon shows the features on or off status. A check in the box indicates the feature is on, and unchecked indicates the feature is off.

**Note:** Some options could appear slightly different or not at all if the items are optional.

**Note:** Some MyKey menu options only appear if MyKey is enabled and at least one MyKey is programmed.

# Information Displays

## Trip Menu

Trip Menu	
Trip 1	
Trip 2	
Reset Individual Values	Select Your Setting
Configure View	Select Your Setting

- Trip Odometer - Registers the distance traveled of individual journeys or the total distance since the function was last reset.
- Trip Timer - Registers the elapsed time of individual journeys or the total time since the function was last reset.
- Average Fuel - Indicates the average fuel consumption of individual journeys or the average fuel consumption since the function was last reset.
- Average Speed - Indicates the average vehicle speed of individual journeys or the average vehicle speed since the function was last reset.
- Distance to Empty - Indicates the approximate distance your vehicle can travel on the fuel remaining in the tank. Changes in driving pattern can cause the value to not only decrease but also increase or stay constant for periods of time.

**Note:** Press and hold the OK button to reset your trip information.

## MyView

MyView
Digital Speedometer
Fuel Economy
Trip/Audio
Calm Screen

## Navigation

Navigation
Menu options covered in the SYNC chapter. See <b>General Information</b> (page 350).

# Information Displays

## Audio

Audio
Menu options covered in the SYNC chapter. See <b>General Information</b> (page 350).

## Phone

Phone
Menu options covered in the SYNC chapter. See <b>General Information</b> (page 350).

## Settings

Settings		
Information	Contains vehicle status information. Select Your Setting.	
Display	Language	Select Your Setting
	Measure unit	
	Temperature unit	
	Tire Pressure	
Driver Assistance	Select Your Setting	
Vehicle Maintenance	Oil Level	Select Your Setting
	Oil Life	
	Brake Fluid Life	
	Tire Pressure	
MyKey	MyKey Info	
	Create MyKey	

**Note:** Additional vehicle settings are available through your touchscreen. See **Settings** (page 378).

## 6 Inch Display Menu



This icon shows the features on or off status. A check in the box indicates the feature is on, and unchecked indicates the feature is off.



# Information Displays

**Note:** Some options could appear slightly different or not at all if the items are optional.

**Note:** Some MyKey menu options only appear if MyKey is enabled and at least one MyKey is programmed.

## Select Screens

Select Screens
Menu options covered in Personalized Settings. See <b>Personalized Settings</b> (page 103).

## Audio

Audio
Menu options covered in the SYNC chapter. See <b>General Information</b> (page 350).

## Navigation

Navigation
Menu options covered in the SYNC chapter. See <b>General Information</b> (page 350).

## Phone

Phone
Menu options covered in the SYNC chapter. See <b>General Information</b> (page 350).

## Settings

Settings	
Oil Life	Percent Oil Life Indication XXX% Hold Ok to Reset
Tire Monitor	Hold Ok to Reset

**Note:** Additional vehicle settings are available through your touchscreen. See **Settings** (page 378).

# Information Displays

## Display Setup

Display Setup
Speedometer km/h
Speedometer MPH

**Note:** Additional display settings are available through your touchscreen. See **Settings** (page 378).

**Note:** Some options could appear slightly different or not at all if the items are optional.

## PERSONALIZED SETTINGS

Select one of these options to display on your main screen.

Select Screens
Calm Screen
Fuel Economy
Trip 1
Trip 2
Tire Pressure
Intelligent 4WD
Off Road
Trailer Light Check
Seatbelts
Auto Start/Stop
Now Playing

After making your selection:

1. Select a setting and press the **OK** button. This offers more information on the feature.
2. Select fuel economy, trip 1 or trip 2 to reset. Press and hold the **OK** button for a few seconds.

### Fuel Economy

An Instant Fuel Economy gauge is provided along with average fuel economy. Average fuel economy is continuously averaged since the last reset.

# Information Displays

**Note:** When viewing this screen you can reset your average fuel economy. Hold **OK** to reset fuel history and average fuel economy.

**Note:** The system abbreviates or shortens certain messages.

## Trip 1 and 2

Provides trip timer, trip average fuel economy and total trip distance traveled. For hybrid vehicles, the trip also shows the distance traveled on electric power only.



E222314

Press the **OK** button to acknowledge and remove some messages from the information display. The system removes other messages after a short time.

You need to confirm certain messages before you can access the menus.

## INFORMATION MESSAGES

Depending on your vehicle options and instrument cluster type, not all messages display or are available.

## Adaptive Cruise Control

Message	Action
Adaptive Cruise Malfunction	A radar malfunction is preventing the adaptive cruise from engaging.
Front Sensor Not Aligned	
Adaptive Cruise Not Available	Conditions exist such that the adaptive cruise cannot properly function.
Adaptive Cruise Not Available Sensor Blocked See Manual	Bad weather, ice, mud or water is causing poor radar visibility and is blocking the radar sensor. You can typically clean the sensor to resolve.
Normal Cruise Active Adaptive Braking Off	Displays when automatic braking disables.
Adaptive Cruise - Driver Resume Control	Displays when the adaptive cruise system reinstates control to the driver.
Adaptive Cruise Speed Too Low to Activate	Displays when the vehicle speed is too slow to activate the adaptive cruise.

# Information Displays

## AdvanceTrac™ and Traction Control

Message	Action
Service AdvanceTrac	The system detects a condition that requires service. Contact an authorized dealer as soon as possible.
AdvanceTrac Off	The status of the AdvanceTrac system after you switched it off.
AdvanceTrac On	The status of the AdvanceTrac system after you switched it on.
Traction Control Off	The status of the traction control system after you switched it off.
Traction Control On	The status of the traction control system after you switched it on.

## Alarm

Message	Action
Vehicle Alarm To Stop Alarm, Start Vehicle.	Alarm triggered due to unauthorized entry. See <b>Anti-Theft Alarm</b> (page 72).

## Auto-Start-Stop

Message	Action
Auto StartStop Press Brake to Start Engine	You need to restart the engine and press the brake pedal to start.
Auto StartStop Press Brake Harder to Activate	You need to restart the engine and press the brake pedal harder to start.
Auto StartStop Press a Pedal to Start Engine	You need to restart the engine and press any pedal to start.
Auto StartStop Select Neutral To Start Engine	Select neutral (N) for the system to restart the engine.

## Information Displays

Message	Action
Auto StartStop Shift to P, then Restart Engine	Select park (P) for the system to restart the engine.
Auto StartStop Manual Restart Required	The system is not functioning. You need to restart the engine.
Auto StartStop Not Available	Conditions are not met for the auto-start-stop system to properly function.

### Battery and Charging System

Message	Action
Check Charging System	The charging system needs servicing. If the warning stays on or continues to come on, contact an authorized dealer as soon as possible.
Charging System Service Soon	The charging system needs servicing. If the warning stays on or continues to come on, contact an authorized dealer as soon as possible.
Charging System Service Now	The charging system needs servicing. Contact an authorized dealer as soon as possible.
Battery State of Charge Low	The battery management system determines that the 12V battery is at a low state of charge. Start the engine to charge the battery or charge the battery using an aftermarket battery charger. This message clears once you restart your vehicle and the battery state of charge recovers.
Turn Power Off To Save Battery	The battery management system determines that the battery is at a low state of charge. Switch the ignition off as soon as possible to protect the battery. This message clears once you restart your vehicle and the battery state of charge recovers. Turning off unnecessary electrical loads allows for a faster battery state-of-charge recovery.

# Information Displays

## Blind Spot Information and Cross Traffic Alert System

Message	Action
Blind Spot System Fault	A system error has occurred. Contact an authorized dealer as soon as possible.
Blind Spot Not Available Sensor Blocked See Manual	The system sensors are blocked. See <b>Blind Spot Information System</b> (page 211).
Cross Traffic Alert Applying Brakes	The system detects a vehicle and automatically applied the brakes.
Cross Traffic Not Available Sensor Blocked See Manual	The blind spot information system and cross traffic alert system sensors are blocked. See <b>Cross Traffic Alert</b> (page 213).
Cross Traffic System Fault	A system error has occurred. Contact an authorized dealer as soon as possible.
Cross Traffic Alert Deactivated Trailer Attached	The system automatically turns off and displays this message when you connect a trailer to the vehicle that does not have a trailer blind spot system or when you switch the trailer blind spot system off through the information display. See <b>Cross Traffic Alert</b> (page 213).
Blind Spot Alert Deactivated Trailer Attached	The system automatically turns off and displays this message when you connect a trailer to the vehicle that does not have a trailer blind spot system or when you switch the trailer blind spot system off through the information display. See <b>Blind Spot Information System</b> (page 211).

## Doors and Locks

Message	Action
Driver Door Ajar	The driver door is not completely closed.
Passenger Door Ajar	The passenger door is not completely closed.
Rear Left Door Ajar	The rear left door is not completely closed.
Rear Right Door Ajar	The rear right door is not completely closed.

## Information Displays

Message	Action
Liftgate or liftglass ajar	The liftgate or liftgate glass is not completely closed.
Hood Ajar	The hood is not completely closed.
Factory Keypad Code {X X X X X}	The factory keypad code appears in the information display after the system resets the keypad. See <b>Passive Anti-Theft System</b> (page 72).

### Driver Alert

Message	Action
Driver Alert Warning Rest Now	Stop and rest as soon as it is safe to do so.
Driver Alert Warning Rest Suggested	Take a rest soon.

### Four-Wheel Drive

Message	Action
4WD Temporarily Disabled	The four-wheel drive system temporarily turns off to protect itself from overheating.
4WD Temporarily Locked	The four-wheel drive system is locking up the torque transfer clutch to help reduce clutch temperature.
4WD Off	The four-wheel drive system temporarily turns off to protect itself from overheating or if you are using the temporary spare tire.
4WD Restored	The four-wheel drive system will resume normal function and clear this message after driving a short distance with the road tire re-installed or after the system cools.
4WD Fault Service Required	The four-wheel drive system is not operating properly. If the warning stays on or continues to come on, contact an authorized dealer.
Change 4WD Power Transfer Unit Lube	Displays when the power transfer unit fluid requires service.

## Information Displays

Message	Action
4WD Power Transfer Unit Lube Set to New	Displays when you have the power transfer unit fluid changed and reset to new.
Rear Differential Lock Not Available in Current Drive Mode	The selected drive mode does not allow you to turn on the rear differential lock feature.
4WD Lock Required in Current Drive Mode	The selected drive mode requires your vehicle to be in four-wheel drive.

### Fuel

Message	Action
Fuel Level Low	An early reminder of a low fuel condition.
Check Fuel Fill Inlet	The fuel fill inlet may not be properly closed.
Fuel Door Opening	Wait for up to 15 seconds while the fuel system depressurizes.
Fuel Door Open	The fuel system has finished depressurizing and you can begin to refuel.
Close Fuel Door to Avoid ""Check Engine"" Light	A reminder to close the fuel door. Failure to follow this instruction can cause the check engine light to illuminate.
Refuel Error See Manual	There is an error in attempting to refill your vehicle.

### Hill Start Assist

Message	Action
Hill Start Assist Not Available	Hill start assist is not available. Contact an authorized dealer. See <b>Hill Start Assist</b> (page 178).

### Keys and Intelligent Access

Message	Action
To START Press Brake	A reminder to press the brake when starting your vehicle.
No Key Detected	The system does not detect the key. See <b>Keyless Starting</b> (page 148).



## Information Displays

<b>Message</b>	<b>Action</b>
Restart Now or Key is Needed	Appears when you need to press the Start Stop button to shut off the engine when the system does not detect an Intelligent Access key inside your vehicle.
Full Accessory Power Active	Your vehicle is in the accessory ignition state.
Starting System Fault	There is a problem with your vehicle's starting system. See an authorized dealer for service.
Key Program Successful	During spare key programming, an intelligent access key is programmed to the system.
Max Number of Keys Learned	During spare key programming, the maximum number of keys have been programmed.
Key Program Failure	Displayed during spare key programming, when an intelligent access key has failed to be programmed.
Not Enough Keys Learned	Displayed during spare key programming when not enough keys have been programmed.
Key Battery Low Replace Soon	Displays when the key battery is low. Change the battery as soon as possible.
Vehicle Switched Off	Displays when the vehicle is switched off.

## Lane Keeping System

<b>Message</b>	<b>Action</b>
Lane Keeping Sys. Malfunction Service Required	The system has malfunctioned. Contact an authorized dealer as soon as possible.
Front Camera Temporarily Not Available	The system has detected a condition that has caused the system to be temporarily unavailable.
Front Camera Low Visibility Clean Screen	The system has detected a condition that requires the windshield to be cleaned to operate properly.
Front Camera Malfunction Service Required	The system has malfunctioned. Contact an authorized dealer as soon as possible.
Keep Hands on Steering Wheel	The system requests the driver to keep their hands on the steering wheel.

# Information Displays

## Maintenance

Message	Action
Low Engine Oil Pressure	Stop your vehicle as soon as safely possible, turn off the engine. Check the oil level. If the warning stays on or continues to come on with your engine running, contact an authorized dealer as soon as possible.
Change Engine Oil Soon	The engine oil life remaining is 10% or less.
Oil Change Required	The oil life left reaches 0%.
Brake Fluid Level Low	The brake fluid level is low and the brake system should be inspected immediately. See <b>Brake Fluid Check</b> (page 281).
Check Brake System	The brake system needs servicing. Stop the vehicle in a safe place. Contact an authorized dealer.
Engine Coolant Over Temperature	The engine coolant temperature is excessively high.
Washer Fluid Level Low	The washer fluid is low and needs to be refilled.
Transport Mode Contact Dealer	Indicates that your vehicle is still in Transport mode. This may not allow some features to operate properly. Contact an authorized dealer.
Factory Mode Contact Dealer	Indicates that your vehicle is still in Factory mode. This may not allow some features to operate properly. Contact an authorized dealer.
See Manual	Informs the driver that the powertrain needs service due to a powertrain malfunction.
Power Reduced to Lower Engine Temp	The engine has reduced power to help reduce high engine temperature.
Brake Applied Power Reduced	The brake system has reduced stopping power.

# Information Displays

## MyKey

<b>Message</b>	<b>Action</b>
MyKey not Created	You cannot program a MyKey.
MyKey Active Drive Safely	MyKey is active.
Speed Limited to XX MPH/km/h	When switching on your vehicle and MyKey is in use, displays that the MyKey speed limit is on.
Near Vehicle Top Speed	MyKey is in use and the MyKey speed limit is on and the vehicle speed is approaching 81 mph (130 km/h).
Vehicle at Top Speed of MyKey Setting	You have reached the speed limit set for your MyKey.
Check Speed Drive Safely	You have an active MyKey with a programmed set speed limit.
Buckle Up to Unmute Audio	Belt-Minder turns on with a MyKey in use.
AdvanceTrac On - MyKey Setting	With a MyKey in use, AdvanceTrac turns on.
Traction Control On - MyKey Setting	With a MyKey in use, traction control turns on.
MyKey Park Aid Cannot be Deactivated	With a MyKey in use, park aid is always on.
Lane Keeping Alert On MyKey Setting	With a MyKey in use, lane keeping alert turns on.

# Information Displays

## Park Aid

Message	Action
Check Rear Park Aid	The system has detected a fault that requires service. Contact an authorized dealer.
Rear Park Aid Not Available Sensor Blocked See Manual	The radar is blocked due to bad weather, ice, mud or water in front of radar. You can typically clean the sensor to resolve. See <b>Rear Parking Aid</b> (page 187).
Park Aid Not Available Sensor Blocked See Manual	The radar is blocked due to bad weather, ice, mud or water in front of radar. You can typically clean the sensor to resolve. See <b>Principle of Operation</b> (page 186).
Rear Park Aid On Off	Displays the park aid status.

## Park Brake

Message	Action
Park Brake Engaged	The parking brake is set, the engine is running and you drive your vehicle more than 3 mph (5 km/h). If the warning stays on after the parking brake is released, contact an authorized dealer as soon as possible.
To Release: Press Brake and Switch	The electric parking brake is set and a manual release is attempted without the brake pedal being pressed.
Park Brake Use Switch to Release	The electric parking brake is set and an automatic release is attempted but cannot be performed. Perform a manual release.
Release Park Brake	The electric parking brake is set and your vehicle speed exceeds 3 mph (5 km/h). Release park brake before continued driving.
Park Brake Not Applied	The electric parking brake is not fully applied.
Park Brake Not Released	The electric parking brake is not fully released.
Park Brake Maintenance Mode	The electric parking brake system has been put into a special mode that is used to allow service of the rear brakes. Contact an authorized dealer.

## Information Displays

Message	Action
Park Brake Limited Function Service Required	The electric park brake system has detected a condition that requires service. Some functionality may still be available. Contact your authorized dealer.
Park Brake Malfunction Service Now	The electric parking brake system has detected a condition that requires service. Contact your authorized dealer.
Park Brake System Overheated	Numerous park brake applies have overheated the system. Wait 2 minutes before attempting to apply again.

### Power Steering

Message	Action
Steering Fault Service Now	The power steering system has detected a condition that requires service. See an authorized dealer.
Steering Loss Stop Safely	The power steering system is not working. Stop your vehicle in a safe place. Contact an authorized dealer.
Steering Assist Fault Service Required	The power steering system has detected a condition within the power steering system or passive entry or passive start system requires service. Contact an authorized dealer.
Steering Lock Malfunction Service Now	The steering lock system has detected a condition that requires service. See an authorized dealer.

### Pre-Collision Assist

Message	Action
Pre-Collision Assist Not Available Sensor Blocked	You have a blocked sensor due to bad weather, ice, mud or water in front of the radar sensor. You can typically clean the sensor to resolve.
Pre-Collision Assist Not Available	A fault with the system has occurred. Contact an authorized dealer as soon as possible.

### Remote Start

Message	Action
To Drive: Press Brake and Gear Shift Button	Displays as a reminder to apply the brake and push the gear shift button to drive the vehicle after a remote start.

# Information Displays

## Seats

Message	Action
Occupant Sensor BLOCKED Remove Objects Near Passenger Seat	Objects are by the passenger seat. After the objects are moved away from the seat, if the warning stays on or continues to come on contact an authorized dealer as soon as possible.
Memory Recall Not Permitted While Driving	Displays as a reminder that memory seats are not available when driving.
Memory {0} Saved	Displays to show where your memory setting has been saved.

## Starting System

Message	Action
To START Press Brake	Displays when starting the vehicle as a reminder to apply the brake.
Cranking Time Exceeded	Displays when the starter has exceeded its cranking time in attempting to start the vehicle.
Engine Start Pending Please Wait	Displays when the starter is attempting to start the vehicle.
Pending Start Cancelled	Displays when the pending start has been cancelled.

## Tire Pressure Monitoring System

Message	Action
Tire Pressure Low	One or more tires on your vehicle have low tire pressure. See <b>Tire Pressure Monitoring System</b> (page 312).
Tire Pressure Monitor Fault	The tire pressure monitoring system is malfunctioning. If the warning stays on or continues to come on, contact an authorized dealer. See <b>Tire Pressure Monitoring System</b> (page 312).
Tire Pressure Sensor Fault	A tire pressure sensor is malfunctioning, or your spare tire is in use. For more information on how the system operates under these conditions, See <b>Tire Pressure Monitoring System</b> (page 312). If the warning stays on or continues to come on, contact an authorized dealer as soon as possible.

## Information Displays

### Trailer

Message	Action
Trailer Connected	A correct trailer connection is sensed during a given ignition cycle.
Trailer Disconnected	A trailer connection becomes disconnected, either intentionally or unintentionally, and has been sensed during a given ignition cycle.
Trailer Sway Reduce Speed	The trailer sway control has detected trailer sway.
Trailer Wiring Fault	There are certain faults in your vehicle wiring and trailer wiring/brake system. See <b>Towing a Trailer</b> (page 235).
Trailer Left Turn Lamps Fault Check Lamps	There is a fault with your trailer turn lamp. Check your lamp.
Trailer Right Turn Lamps Fault Check Lamps	There is a fault with your trailer turn lamp. Check your lamp.
Trailer Battery Not Charging See Manual	There is a fault with your trailer battery. See <b>Towing a Trailer</b> (page 235).
Trailer Lighting Module Fault See Manual	There is a fault with your vehicle trailer lighting module. See <b>Towing a Trailer</b> (page 235).

### Transmission

Message	Action
Shift to Park	Displays when you switch the engine off and the transmission is not in park (P). Shift into park (P).
Transmission Warming Up Please Wait	Transmission is too cold. Wait for it to warm up before you drive.
Press Brake Pedal	Displays when the brake pedal needs to be depressed.
Transmission Over Temperature Stop Safely	The transmission is overheating and needs to cool. Stop in a safe place as soon as it's possible.
Transmission Service Required	See an authorized dealer.
Transmission Too Hot Press Brake	The transmission is overheating and needs to cool. Stop in a safe place as soon as it's possible.

## Information Displays

Message	Action
Transmission Limited Function See Manual	The transmission has limited functionality. See an authorized dealer.
Transmission Not in Park	A reminder to shift into park. In addition, this message is typical after reconnecting or recharging the battery until you cycle the ignition to the on mode. See <b>Changing the 12V Battery</b> (page 282).
SHIFT SYS FAULT Confirm Park Brake Apply Before Exiting the Vehicle	Displays when there is a system fault and the park brake needs to be depressed before exiting the vehicle. See your authorized dealer.
SHIFT SYS FAULT Service Required	See your authorized dealer.
SHIFT SYS FAULT Vehicle is Shifting to Park	Displays when there is a system fault when the vehicle is shifting to park. See your authorized dealer.
SHIFT SYS FAULT Reverse Unavailable Service Required	Displays when there is a system fault when the vehicle is shifting to reverse. See your authorized dealer.
SHIFT SYS FAULT Drive Unavailable Select S for Drive Service Required	See an authorized dealer.
SHIFT SYS FAULT Neutral Unavailable Service Required	See your authorized dealer.
SHIFT SYS FAULT Sport Unavailable Service Required	See your authorized dealer.
Invalid Gear Selection	Displays when an invalid gear has been selected.
Depress Brake to Shift from Park	Displays when the brake pedal needs to be depressed to enable the transmission to shift from park.



# Remote Start (If Equipped)

## WHAT IS REMOTE START

The system allows you to remotely start your vehicle and to adjust the interior temperature according to the settings that you chose.

## REMOTE START PRECAUTIONS



**WARNING:** Do not start the engine in a closed garage or in other enclosed areas. Exhaust fumes are toxic. Always open the garage door before you start the engine. Failure to follow this instruction could result in personal injury or death.

## REMOTE START LIMITATIONS

Remote start does not work under the following conditions:

- The alarm horn is sounding.
- The hood is open.
- The transmission is not in park (P).
- The ignition is on.
- The battery voltage is below the minimum operating voltage.

**Note:** Do not use remote start if your fuel level is low.

**Note:** You can use remote start with FordPass. See **Connecting the Vehicle to a Wi-Fi Network** (page 337).

## ENABLING REMOTE START

1. Press **Settings** on the touchscreen.
2. Press **Vehicle**.
3. Press **Remote Start Setup**.
4. Switch **System** on.

**Note:** To use remote start, make sure that the **modem is enabled**. See **Connected Vehicle** (page 337).

## REMOTELY STARTING AND STOPPING THE VEHICLE

### Remotely Starting the Vehicle



Press the button on the remote control.



Within three seconds, press the button on the remote control.

Within three seconds, press the button again.

**Note:** You can also use FordPass to start the vehicle.

**Note:** The turn signal lamps flash twice.

**Note:** The parking lamps turn on when the vehicle is running.

**Note:** The horn sounds if the system fails to start.

**Note:** All other vehicle systems remain off when you have remotely started the vehicle.

**Note:** The vehicle remains secured when you have remotely started the vehicle. A valid key must be inside your vehicle to switch the ignition on and drive your vehicle.

### Remotely Stopping the Vehicle



Within three seconds, press the button on the remote control.

Within three seconds, press the button again.

## EXTENDING THE REMOTE START DURATION

To extend the remote start duration during remote start, do the following:

## Remote Start (If Equipped)



Press the button on the remote control.



Within three seconds, press the button on the remote control.

Within three seconds, press the button again.

If the duration is set to 15 minutes, the duration extends by another 15 minutes. This provides a total of 30 minutes.

**Note:** Remote start can only be extended once.

**Note:** A maximum of two remote starts, or one remote start with an extension, are allowed. To reset the restart procedure switch the vehicle to on, then to off.

### REMOTE START REMOTE CONTROL INDICATORS

#### Remote Control Feedback

An LED on the remote control provides status feedback of remote start or stop commands.

LED	Status
Solid green.	Remote start successful.
Solid red.	Remote stop successful.
Blinking red.	Request failed or status not received.
Blinking green.	Status incomplete.

### REMOTE START SETTINGS

#### Switching Climate Control Auto Mode On and Off

1. Press **Settings** on the touchscreen.

2. Press **Remote Start Setup**.

3. Press **Climate Control**.

4. Select **Vehicle**.

5. Switch **Auto** on or off.

**Note:** If you switch the auto mode on, the system attempts to heat or cool the interior to 72°F (22°C).

**Note:** When you switch the ignition on, the climate control system returns to the last used settings.

#### Switching Climate Control Last Settings On and Off

1. Press **Settings** on the touchscreen.

2. Press **Vehicle**.

3. Press **Remote Start Setup**.

4. Switch **Last settings** on.

**Note:** If you switch the last settings on, the system remembers the last used settings.

#### Switching the Heated Seat Settings On and Off

1. Press **Settings** on the touchscreen.

2. Press **Vehicle**.

3. Press **Remote Start Setup**.

4. Press **Seats**.

5. Switch **Auto** on or off.

**Note:** If you switch the heated seat settings on, the heated seats turn on during cold weather.

#### Switching the Heated Steering Wheel Settings On and Off

1. Press **Settings** on the touchscreen.

2. Press **Vehicle**.

3. Press **Remote Start Setup**.

4. Press **Seats and Steering Wheel**.

## Remote Start (If Equipped)

---

5. Switch **Auto** on or off.

**Note:** *If you switch the heated steering wheel settings on, the heated steering wheel turns on during cold weather.*

### Setting the Remote Start Duration

1. Press **Settings** on the touchscreen.
2. Press **Vehicle**.
3. Press **Remote Start Setup**.
4. Press **Duration**.

**Note:** *Wait a few seconds before remotely starting the vehicle after the vehicle stops running.*

# Climate Control - Vehicles With: Dual Automatic Temperature Control (DATC)

## IDENTIFYING THE CLIMATE CONTROL UNIT



E290005

**Note:** Depending on your vehicle options, the controls may look different from what you see here.

## SWITCHING CLIMATE CONTROL ON AND OFF



Press the button.

## SWITCHING RECIRCULATED AIR ON AND OFF



Press the button to recirculate air currently in the passenger compartment.

**Note:** Recirculated air could turn off or be prevented from turning on in all air flow modes except maximum cooling to reduce the risk of the windows fogging up.

**Note:** Recirculated air could turn on and off when you direct air to the instrument panel or footwell air vents during hot weather to improve cooling efficiency.

## SWITCHING AIR CONDITIONING ON AND OFF



Press the button.

**Note:** Under certain conditions, the air conditioning compressor could continue to operate after you switch air conditioning off.

## SWITCHING MAXIMUM DEFROST ON AND OFF



Press the button.

Air flows through the windshield air vents, and the blower motor adjusts to the highest speed.

You can also use this setting to defog and clear the windshield of a thin covering of ice.

**Note:** To prevent window fogging, you cannot select recirculated air when maximum defrost is on.

**Note:** The heated rear window also turns on when you select maximum defrost.

## SWITCHING MAXIMUM COOLING ON AND OFF



Press the button.

**Note:** When you switch maximum cooling off, air conditioning remains on.

# Climate Control - Vehicles With: Dual Automatic Temperature Control (DATC)

## SWITCHING THE HEATED WIPER PARK ON AND OFF (IF

EQUIPPED)



When you switch the heated rear window on, the heated wiper park also turns on.

## SWITCHING THE HEATED REAR WINDOW ON AND OFF



Press the button to clear the rear window of thin ice and fog. The heated rear window turns off after a short period of time.

**Note:** Do not use harsh chemicals, razor blades or other sharp objects to clean or remove decals from the inside of the heated rear window as this could cause damage to the heated rear window grid lines not covered by the vehicle Warranty.

## SWITCHING THE HEATED MIRRORS ON AND OFF (IF

EQUIPPED)

When you switch the heated rear window on, the heated exterior mirrors turn on.

**Note:** Do not remove ice from the mirrors with a scraper or adjust the mirror glass when it is frozen in place.

**Note:** Do not clean the mirror housing or glass with harsh abrasives, fuel or other petroleum-based cleaning products. The vehicle warranty may not cover damage caused to the mirror housing or glass.

## SETTING THE BLOWER MOTOR SPEED



**Note:** Lights on the control illuminate to indicate the blower motor speed.

**Note:** When you switch the blower motor off, air conditioning turns off and the windows could fog up.

## SETTING THE TEMPERATURE

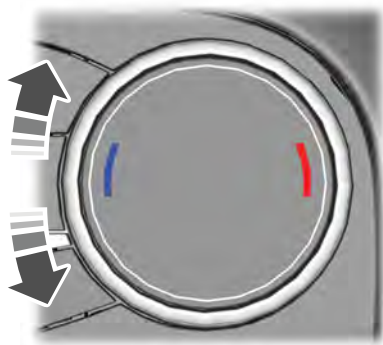

Turn the control on the left-hand side of the climate control to set the left-hand temperature.

**Note:** This control also sets the right-hand side temperature when you switch off dual zone mode.

Turn the control on the right-hand side of the climate control to set the right-hand temperature.

# Climate Control - Vehicles With: Dual Automatic Temperature Control (DATC)

## DIRECTING THE FLOW OF AIR

### Directing Air to the Windshield Air Vents



Press the button.

### Directing Air to the Instrument Panel Air Vents



Press the button.

### Directing Air to the Footwell Air Vents



Press the button.

## AUTO MODE

### Switching Auto Mode On and Off



Press the button to switch auto mode on. Repeatedly press the button to adjust auto mode.

**Note:** When you switch auto mode on, lights on the blower motor control do not illuminate to indicate the blower motor speed.

Adjust the blower motor control or air distribution control to switch auto mode off.

### Auto Mode Indicators

The indicators are on the Auto Mode button.

Auto Mode Indicator Status	Description
One indicator illuminated.	The blower motor speed is reduced. Use this setting to minimize the amount of noise from the blower motor. This setting increases the time taken to cool the interior.
Two indicators illuminated.	The blower motor speed is moderate.
Three indicators illuminated.	The blower motor speed is increased. Use this setting to reduce the time taken to cool the interior. This setting increases the amount of noise from the blower motor.

# Climate Control - Vehicles With: Dual Automatic Temperature Control (DATC)

## Switching Dual Mode On and Off



Press the button.

## CLIMATE CONTROL – TROUBLESHOOTING

### Climate Control – Frequently Asked Questions

#### Why is the volume of air to the rear passenger compartment limited?

Objects may obstruct the air direction to the rear passenger compartment. Make sure objects have not been placed under the front seats.

#### Why is the volume of air from the air vents reduced?

The air intake area at the base of the windshield could be obstructed. Make sure the air intake area is free from any snow, ice or leaves.

#### What are the recommended settings for heating the interior?

Auto mode on and instrument panel and side air vents fully open.

#### How can I quickly heat the interior?

Select the highest blower motor speed, highest temperature and direct the air to the footwell air vents.

#### What are the recommended settings for cooling the interior?

Auto mode on.

#### How can I quickly cool the interior?

Switch maximum cooling on, switch recirculated air on and drive with the windows open until you feel cold air through the air vents.

#### How can I reduce the humidity build-up inside my vehicle?

Do not drive with the system off or with recirculated air on.

#### How can I defog the side windows?

Switch maximum defrost on.

#### How can I defog or clear the windshield of thin ice?

Switch maximum defrost on.

#### Why do I feel air from the footwell air vents regardless of the air distribution?

This is normal operation. You may feel a small amount of air from the footwell air vents regardless of the air distribution.

#### What happens if I switch auto mode on when the outside temperature and in-vehicle temperature is high?

The system temporarily selects recirculated air to maximize cooling.

#### What happens if I switch auto mode on when the outside temperature is low and the engine is cold?

Air is directed to the windshield and the outer instrument panel air vents.

# Climate Control - Vehicles With: Electronic Automatic Temperature Control (EATC)

## IDENTIFYING THE CLIMATE CONTROL UNIT



E289733

**Note:** Depending on your vehicle options, the controls may look different from what you see here.

## SWITCHING CLIMATE CONTROL ON AND OFF



Press the button.

## SWITCHING RECIRCULATED AIR ON AND OFF



Press the button to recirculate air currently in the passenger compartment.

**Note:** Recirculated air could turn off or be prevented from turning on in all air flow modes except maximum cooling to reduce the risk of the windows fogging up.

**Note:** Recirculated air could turn on and off when you direct air to the instrument panel or footwell air vents during hot weather to improve cooling efficiency.

## SWITCHING AIR CONDITIONING ON AND OFF



Press the button.

**Note:** Under certain conditions, the air conditioning compressor could continue to operate after you switch air conditioning off.

## SWITCHING MAXIMUM DEFROST ON AND OFF



Press the button.

Air flows through the windshield air vents, and the blower motor adjusts to the highest speed.

You can also use this setting to defog and clear the windshield of a thin covering of ice.

**Note:** To prevent window fogging, you cannot select recirculated air when maximum defrost is on.

**Note:** The heated rear window also turns on when you select maximum defrost.

## SWITCHING MAXIMUM COOLING ON AND OFF



Press the button.

**Note:** When you switch maximum cooling off, air conditioning remains on.



# Climate Control - Vehicles With: Electronic Automatic Temperature Control (EATC)

## SWITCHING THE HEATED WIPER PARK ON AND OFF (IF

EQUIPPED)



When you switch the heated rear window on, the heated wiper park also turns on.

## SWITCHING THE HEATED REAR WINDOW ON AND OFF



Press the button to clear the rear window of thin ice and fog. The heated rear window turns off after a short period of time.

**Note:** Do not use harsh chemicals, razor blades or other sharp objects to clean or remove decals from the inside of the heated rear window as this could cause damage to the heated rear window grid lines not covered by the vehicle Warranty.

## SWITCHING THE HEATED MIRRORS ON AND OFF (IF

EQUIPPED)

When you switch the heated rear window on, the heated exterior mirrors turn on.

**Note:** Do not remove ice from the mirrors with a scraper or adjust the mirror glass when it is frozen in place.

**Note:** Do not clean the mirror housing or glass with harsh abrasives, fuel or other petroleum-based cleaning products. The vehicle warranty may not cover damage caused to the mirror housing or glass.

## SETTING THE BLOWER MOTOR SPEED



Turn the control.

**Note:** Lights on the control illuminate to indicate the blower motor speed.

**Note:** When you switch the blower motor off, air conditioning turns off and the windows could fog up.

## SETTING THE TEMPERATURE

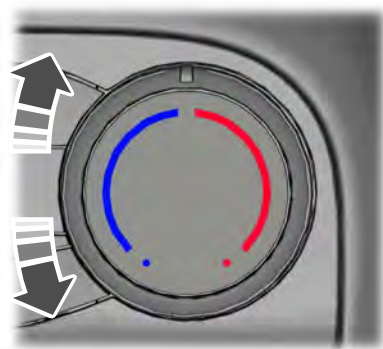

# Climate Control - Vehicles With: Electronic Automatic Temperature Control (EATC)

Turn the temperature control counterclockwise for cooler temperature settings.

Turn the temperature control clockwise for warmer temperature settings.

## DIRECTING THE FLOW OF AIR

### Directing Air to the Windshield Air Vents



Press the button.

### Directing Air to the Instrument Panel Air Vents



Press the button.

### Directing Air to the Footwell Air Vents



Press the button.

## AUTO MODE

### Switching Auto Mode On and Off



Press the button to switch auto mode on. Repeatedly press the button to adjust auto mode.

**Note:** When you switch auto mode on, lights on the blower motor control do not illuminate to indicate the blower motor speed.

Adjust the blower motor control or air distribution control to switch auto mode off.

### Auto Mode Indicators

The indicators are on the Auto Mode button.

Auto Mode Indicator Status	Description
One indicator illuminated.	The blower motor speed is reduced. Use this setting to minimize the amount of noise from the blower motor. This setting increases the time taken to cool the interior.
Two indicators illuminated.	The blower motor speed is moderate.
Three indicators illuminated.	The blower motor speed is increased. Use this setting to reduce the time taken to cool the interior. This setting increases the amount of noise from the blower motor.

# Climate Control - Vehicles With: Electronic Automatic Temperature Control (EATC)

---

## CLIMATE CONTROL – TROUBLESHOOTING

### Climate Control – Frequently Asked Questions

#### Why is the volume of air to the rear passenger compartment limited?

Objects may obstruct the air direction to the rear passenger compartment. Make sure objects have not been placed under the front seats.

#### Why is the volume of air from the air vents reduced?

The air intake area at the base of the windshield could be obstructed. Make sure the air intake area is free from any snow, ice or leaves.

#### What are the recommended settings for heating the interior?

Auto mode on and instrument panel and side air vents fully open.

#### How can I quickly heat the interior?

Select the highest blower motor speed, highest temperature and direct the air to the footwell air vents.

#### What are the recommended settings for cooling the interior?

Auto mode on.

#### How can I quickly cool the interior?

Switch maximum cooling on, switch recirculated air on and drive with the windows open until you feel cold air through the air vents.

#### How can I reduce the humidity build-up inside my vehicle?

Do not drive with the system off or with recirculated air on.

#### How can I defog the side windows?

Switch maximum defrost on.

#### How can I defog or clear the windshield of thin ice?

Switch maximum defrost on.

#### Why do I feel air from the footwell air vents regardless of the air distribution?

This is normal operation. You may feel a small amount of air from the footwell air vents regardless of the air distribution.

#### What happens if I switch auto mode on when the outside temperature and in-vehicle temperature is high?

The system temporarily selects recirculated air to maximize cooling.

#### What happens if I switch auto mode on when the outside temperature is low and the engine is cold?

Air is directed to the windshield and the outer instrument panel air vents.

# Climate Control - Vehicles With: Manual Temperature Control

## IDENTIFYING THE CLIMATE CONTROL UNIT



E290056

**Note:** Depending on your vehicle options, the controls may look different from what you see here.

## SWITCHING CLIMATE CONTROL ON AND OFF



Press the button.

## SWITCHING RECIRCULATED AIR ON AND OFF



Press the button to recirculate air currently in the passenger compartment.

**Note:** Recirculated air could turn off or be prevented from turning on in all air flow modes except maximum cooling to reduce the risk of the windows fogging up.

**Note:** Recirculated air could turn on and off when you direct air to the instrument panel or footwell air vents during hot weather to improve cooling efficiency.

## SWITCHING AIR CONDITIONING ON AND OFF



Press the button.

**Note:** Under certain conditions, the air conditioning compressor could continue to operate after you switch air conditioning off.

## SWITCHING MAXIMUM DEFROST ON AND OFF



Turn the temperature control clockwise past the highest setting to maximize defrosting.

**Note:** The temperature control springs back to the highest setting.

Air flows through the windshield air vents, and the blower motor adjusts to the highest speed.

**Note:** To prevent window fogging, you cannot select recirculated air when maximum defrost is on.

**Note:** The heated rear window also turns on when you select maximum defrost.

## SWITCHING MAXIMUM COOLING ON AND OFF



Turn the temperature control counterclockwise past the lowest setting to maximize cooling.

**Note:** The temperature control springs back to the lowest setting.

**Note:** When you switch maximum cooling off, air conditioning remains on.

# Climate Control - Vehicles With: Manual Temperature Control

## SWITCHING THE HEATED WIPER PARK ON AND OFF (IF

EQUIPPED)



When you switch the heated rear window on, the heated wiper park also turns on.

## SWITCHING THE HEATED REAR WINDOW ON AND OFF



Press the button to clear the rear window of thin ice and fog. The heated rear window turns off after a short period of time.

**Note:** Do not use harsh chemicals, razor blades or other sharp objects to clean or remove decals from the inside of the heated rear window as this could cause damage to the heated rear window grid lines not covered by the vehicle Warranty.

## SETTING THE BLOWER MOTOR SPEED



Turn the control.

**Note:** Lights on the control illuminate to indicate the blower motor speed.

**Note:** When you switch the blower motor off, air conditioning turns off and the windows could fog up.

## SETTING THE TEMPERATURE

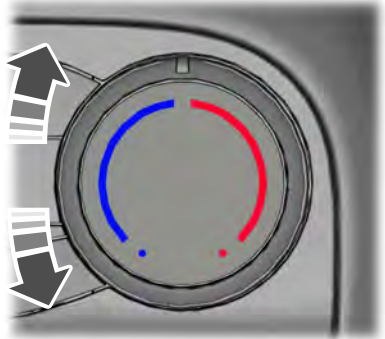

Turn the temperature control counterclockwise for cooler temperature settings.

Turn the temperature control clockwise for warmer temperature settings.

## DIRECTING THE FLOW OF AIR

### Directing Air to the Windshield Air Vents



Press the button.

### Directing Air to the Instrument Panel Air Vents



Press the button.

# Climate Control - Vehicles With: Manual Temperature Control

## Directing Air to the Footwell Air Vents



Press the button.

## CLIMATE CONTROL – TROUBLESHOOTING

### Climate Control – Frequently Asked Questions

#### Why is the volume of air to the rear passenger compartment limited?

Objects may obstruct the air direction to the rear passenger compartment. Make sure objects have not been placed under the front seats.

#### Why is the volume of air from the air vents reduced?

The air intake area at the base of the windshield could be obstructed. Make sure the air intake area is free from any snow, ice or leaves.

#### What are the recommended settings for heating the interior?

A medium blower motor speed selected and the air directed to the footwell and windshield air vents.

#### How can I quickly heat the interior?

Select the highest blower motor speed, highest temperature and direct the air to the footwell air vents.

#### What are the recommended settings for cooling the interior?

Air conditioning on, a medium blower motor speed selected and air directed to the footwell and windshield air vents.

#### How can I quickly cool the interior?

Switch maximum cooling on, switch recirculated air on and drive with the windows open until you feel cold air through the air vents.

#### How can I reduce the humidity build-up inside my vehicle?

Do not drive with the system off or with recirculated air on.

#### How can I defog the side windows?

Switch maximum defrost on.

#### How can I defog or clear the windshield of thin ice?

Switch maximum defrost on.

#### Why do I feel air from the footwell air vents regardless of the air distribution?

This is normal operation. You may feel a small amount of air from the footwell air vents regardless of the air distribution.

# Interior Air Quality

---

## WHAT IS THE CABIN AIR FILTER

The cabin air filter improves the quality of air in your vehicle by trapping dust, pollen and other particles.

## LOCATING THE CABIN AIR FILTER

You can locate the cabin air filter behind the glove box.

## REPLACING THE CABIN AIR FILTER

Replace the filter at regular intervals. See **Scheduled Maintenance** (page 396).

**Note:** *Make sure you have a cabin air filter installed at all times. This prevents foreign objects from entering the system. Running the system without a filter in place could result in degradation or damage to the system.*

**Note:** *Using an aftermarket cabin air filter could reduce cabin air filtration and climate control performance.*

# Seats

## SITTING IN THE CORRECT POSITION



**WARNING:** Sitting improperly, out of position or with the seatback reclined too far can take weight off the seat cushion and affect the decision of the passenger sensing system, resulting in serious injury or death in the event of a crash. Always sit upright against your seat back, with your feet on the floor.



**WARNING:** Do not recline the seat backrest too far as this can cause the occupant to slide under the seatbelt, resulting in personal injury in the event of a crash.



**WARNING:** Do not place objects higher than the top of the seat backrest. Failure to follow this instruction could result in personal injury or death in the event of a sudden stop or crash.

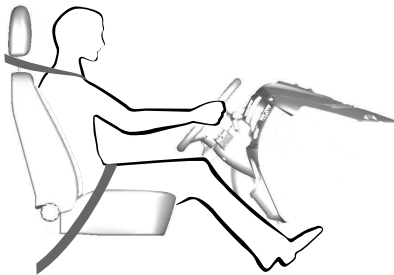

When you use them properly, the seat, head restraint, seatbelt and airbags will provide optimum protection in the event of a crash.

We recommend that you follow these guidelines:

- Sit in an upright position with the base of your spine as far back as possible.
- Do not recline the seat backrest so that your torso is more than 30 degrees from the upright position.
- Adjust the head restraint so that the top of it is level with the top of your head and as far forward as possible. Make sure that you remain comfortable.
- Keep sufficient distance between yourself and the steering wheel. We recommend a minimum of 10 in (25 cm) between your breastbone and the airbag cover.
- Hold the steering wheel with your arms slightly bent.
- Bend your legs slightly so that you can press the pedals fully.
- Position the shoulder strap of the seatbelt over the center of your shoulder and position the lap strap tightly across your hips.

Make sure that your driving position is comfortable and that you can maintain full control of your vehicle.

## HEAD RESTRAINTS



**WARNING:** Fully adjust the head restraint before you sit in or operate your vehicle. This will help minimize the risk of neck injury in the event of a crash. Do not adjust the head restraint when your vehicle is moving.



# Seats



**WARNING:** The head restraint is a safety device. Whenever possible it should be installed and properly adjusted when the seat is occupied. Failure to adjust the head restraint properly could reduce its effectiveness during certain impacts.



**WARNING:** Adjust the head restraints for all passengers before you drive your vehicle. This will help minimize the risk of neck injury in the event of a crash. Do not adjust the head restraints when your vehicle is moving.

**Note:** Adjust the seat backrest to an upright driving position before adjusting the head restraint. Adjust the head restraint so that the top of it is level with the top of your head and as far forward as possible. Make sure that you remain comfortable. If you are extremely tall, adjust the head restraint to its highest position.

## Front Seat Head Restraints



The head restraints consists of:

- A An energy absorbing head restraint.
- B Two steel stems.
- C Guide sleeve adjust and unlock button.

## Rear Seat Center Head Restraint

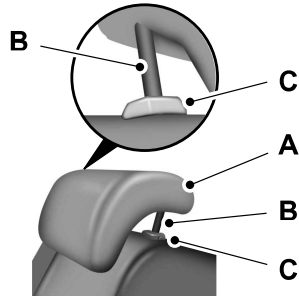

The head restraint consists of:

- A An energy absorbing head restraint.
- B Two steel stems.
- C Guide sleeve adjust and unlock button.

## Raising the Head Restraint

Pull the head restraint up.

## Lowering the Head Restraint

1. Press and hold button C.
2. Push the head restraint down.

## Removing the Head Restraints

1. Pull the head restraint up until it reaches its highest position.
2. Press and hold button C.
3. Pull the head restraint up.

# Seats

## Installing the Head Restraint

Align the steel stems into the guide sleeves and push the head restraint down until it locks.

## Tilting the Front Seat Head Restraint (If Equipped)

The front head restraint tilts for extra comfort. To tilt the head restraint, do the following:



1. Adjust the seat backrest to an upright driving or riding position.
2. Pivot the head restraint forward toward your head to the desired position.

After the head restraint reaches the forward-most tilt position, pivot it forward again to release it to the rearward, un-tilted position.

## Rear Seat Outermost Head Restraint

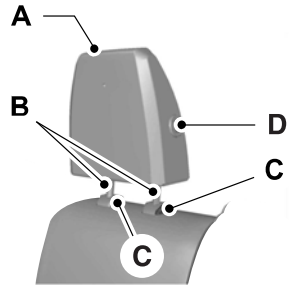

E293091

The head restraint consists of:

- A An energy absorbing head restraint.
- B Two steel stems.
- C Guide sleeve unlock and remove button.
- D Fold button (if equipped).

## Removing the Head Restraint

1. Pull the head restraint up until it reaches its highest position.
2. Press and hold both C buttons.
3. Pull the head restraint up.

## Installing the Head Restraint

Align the steel stems into the guide sleeves and push the head restraint down until it locks.

## Folding the Head Restraint

1. Press and hold button D.
2. Pull the head restraint back up to reset.

# Seats

## MANUAL SEATS

**WARNING:** Do not adjust the driver seat or seat backrest when your vehicle is moving. This may result in sudden seat movement, causing the loss of control of your vehicle.

### Moving the Seat Backward and Forward

**WARNING:** Make sure the seat fully locks into place by rocking it backward and forward.



### Adjusting the Seat Height (If Equipped)

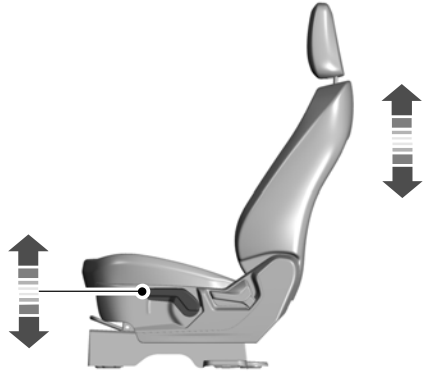

### Adjusting the Seat Backrest

**WARNING:** Do not place cargo or any objects behind the seat backrest before returning it to the original position. Pull on the seat backrest to make sure that it has fully latched after returning the seat backrest to its original position. An unlatched seat may become dangerous if you stop suddenly or have a crash.

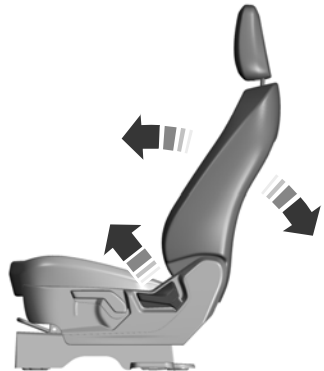

# Seats

## POWER SEATS (IF EQUIPPED)

**WARNING:** Do not adjust the driver seat or seat backrest when your vehicle is moving. This may result in sudden seat movement, causing the loss of control of your vehicle.

**WARNING:** Do not place cargo or any objects behind the seatback before returning it to the original position.

### Moving the Seat Backward and Forward

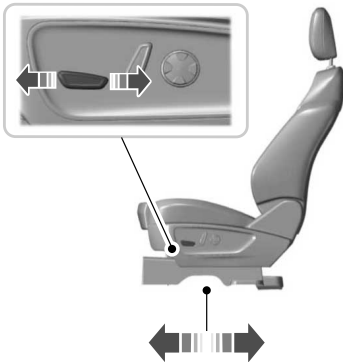

### Adjusting the Seat Height (If Equipped)

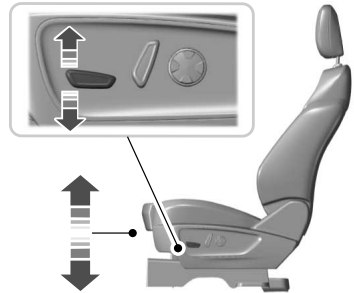

### Adjusting the Seat Backrest

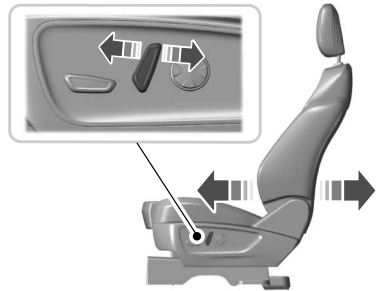

### Adjusting the Lumbar Support (If Equipped)

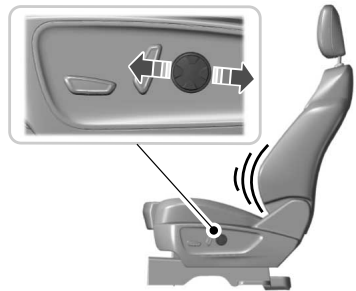

# Seats

## REAR SEATS

### Folding the Seat Backrest



**WARNING:** Do not drive your vehicle with a seat that is unlatched or in the folded position. Failure to follow this instruction could result in personal injury or death in the event of a sudden stop or crash.



**WARNING:** Do not fold a seat if it is occupied. Failure to follow this instruction could result in personal injury.

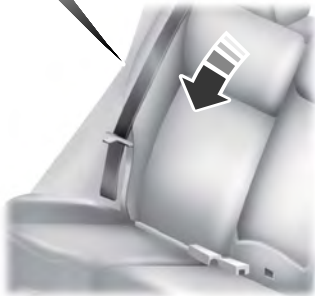

E164098

1. Before folding the seat backrest, stow the seatbelt in the stowage clip. This prevents the seatbelt from getting caught in the seat latch.

2. Fold the outermost head restraints and pull the center head restraint up to the first locked position. See **Head Restraints** (page 133).

**Note:** If you have head restraints that do not fold, move the front seats forward to avoid interference between the front and rear seats. This allows the rear seat backrest to be properly folded.



3. Press the button at the top of the seat backrest.
4. Push the seat backrest forward.



# Seats

5. If you have folding head restraints, make sure they do not interfere with the seat cushion when folded. This allows the seat backrest to be properly stowed.

## Unfolding the Seat Backrest



**WARNING:** Do not place cargo or any objects behind the seat backrest before returning it to the original position. Pull on the seat backrest to make sure that it has fully latched after returning the seat backrest to its original position. An unlatched seat may become dangerous if you stop suddenly or have a crash.

Pull the seat backrest up to unfold it. When raising the seat backrest, make sure the seat latch engages.

## HEATED SEATS (IF EQUIPPED)



**WARNING:** Use caution when using the heated seat if you are unable to feel pain to your skin because of advanced age, chronic illness, diabetes, spinal cord injury, medication, alcohol use, exhaustion or other physical conditions. The heated seat could cause burns even at low temperatures, especially if used for long periods of time. Failure to follow this instruction could result in personal injury.



**WARNING:** Do not place anything on the seat that blocks the heat, for example a seat cover or a cushion. This could cause the seat to overheat. Failure to follow this instruction could result in personal injury.



**WARNING:** Do not poke sharp objects into the seat cushion or seat backrest. This could damage the heated seat element and cause it to overheat. Failure to follow this instruction could result in personal injury.

Do not:

- Place heavy objects on the seat.
- Operate the heated seat if water or any other liquid spills on the seat. Allow the seat to dry thoroughly.

The engine must be running to use this feature.



E146941

Press the heated seat symbol to cycle through the various heat settings and off. Warmer settings are indicated by more indicator lights.

## Rear Occupant Alert System (If Equipped)

### WHAT IS THE REAR OCCUPANT ALERT SYSTEM

The rear occupant alert system monitors vehicle conditions and notifies you to check for rear seat occupants when you switch the ignition off.

### HOW DOES THE REAR OCCUPANT ALERT SYSTEM WORK

The system monitors when rear doors have been opened and closed to indicate the potential presence of an occupant in the rear seat.

A message displays in the information and entertainment display screen and an audible warning sounds when you switch the ignition off after any of the following conditions have been met:

- A rear door is opened or closed while the ignition is on.
- You switch the ignition on within 15 minutes of a rear door opening and closing.
- You switch the ignition on within 15 minutes of the alert having displayed or sounded.

### REAR OCCUPANT ALERT SYSTEM PRECAUTIONS



**WARNING:** On hot days, the temperature inside the vehicle can rise very quickly. Exposure of people or animals to these high temperatures for even a short time can cause death or serious heat related injuries, including brain damage. Small children are particularly at risk.



**WARNING:** Do not leave children or pets unattended in your vehicle. Failure to follow this instruction could result in personal injury or death.

### REAR OCCUPANT ALERT SYSTEM LIMITATIONS

The system does not detect the presence of objects or passengers in the rear seat. It monitors when rear doors are opened and closed.

**Note:** *It is possible to receive an alert when there is no rear seat occupant, but alert conditions are met.*

**Note:** *It is possible to receive no alert when there is an occupant in the rear seat, if alert conditions are not met. For example, if a rear seat occupant does not enter the vehicle through a rear door.*

**Note:** *The audible warning does not sound when the front door is opened before you switch the ignition off.*

### SWITCHING REAR OCCUPANT ALERT SYSTEM ON AND OFF

1. Press **Settings** on the touchscreen.
2. Press **Vehicle**.
3. Switch **Rear Occupant Alert** on or off.

**Note:** *The default setting is on.*

**Note:** *Performing a master reset causes the system to switch on again.*

### Semiannual Reminder (If Equipped)

When you switch the system off, a message appears every six months as a reminder that the system is off. You can switch the system back on or leave it off.

## Rear Occupant Alert System (If Equipped)

---

### REAR OCCUPANT ALERT SYSTEM INDICATORS



Message
Check rear seats for occupants.

Displays when you switch your vehicle off after the alert conditions are met.

The message displays for a short period of time. Press **Close** to acknowledge and remove the message.

### REAR OCCUPANT ALERT SYSTEM AUDIBLE WARNINGS

Sounds when you switch your vehicle off after the alert conditions are met.

The warning sounds for a short period of time.



# Power Outlet - Vehicles With: 12V Power Outlet

---

## WHAT IS THE POWER OUTLET

The power outlet can power devices using a 12 V outlet adapter.

## POWER OUTLET PRECAUTIONS

When you switch the vehicle on, you can use the socket to power 12 V appliances with a maximum current rating of 20 A. Do not use the power point over the vehicle capacity of 12 V DC 240 W or a fuse could blow. Do not plug in any device that supplies power to the vehicle through the power points. This could result in damage to vehicle systems. Do not hang any accessory from the accessory plug. Always keep the power point caps closed when not in use. Do not insert objects other than an accessory plug into the power point.

To prevent the battery from running out of charge:

- Do not use the power point longer than necessary when the vehicle is off.
- Do not leave devices plugged in overnight or when you park your vehicle for extended periods.

## LOCATING THE POWER OUTLET

Power outlets are in the following locations:

- Inside the media bin below the instrument panel.
- Inside the main center console bin.
- In the cargo area.

# Power Outlet - Vehicles With: 110V Power Outlet

## WHAT IS THE POWER OUTLET

The power outlet can power devices that use a household plug.

## POWER OUTLET PRECAUTIONS - 1.5L ECOBOOST™



**WARNING:** Do not keep electrical devices plugged in the power point whenever the device is not in use. Do not use any extension cord with the 110 volt AC power point, since it will defeat the safety protection design. Doing so may cause the power point to overload due to powering multiple devices that can reach beyond the 150 watt load limit and could result in fire or serious injury.

## POWER OUTLET PRECAUTIONS - 2.0L ECOBOOST™



**WARNING:** Do not keep electrical devices plugged in the power point whenever the device is not in use. Do not use any extension cord with the 110 volt AC power point, since it will defeat the safety protection design. Doing so may cause the power point to overload due to powering multiple devices that can reach beyond the 400 watt load limit and could result in fire or serious injury.

**Note:** The vehicle provides up to 400 watts when in park and up to 300 watts when in drive mode. This wattage is divided between multiple outlets when in use at the same time.

## LOCATING THE POWER OUTLET

The power outlets are located on the rear of the center console, and in the cargo area.

## POWER OUTLET INDICATORS

The power outlet indicator illuminates to let you know the status of the system.

Indicator Status	Description
On	The power point is working, the ignition is on, or the vehicle is in accessory mode.
Off	The power point is off, the ignition is off, or the vehicle is not in accessory mode.
Flashing	The power point is in fault mode.

**Note:** Due to different technologies used on its construction, some devices may exceed the capacity shown on its label when they are initially plugged in.

**Note:** The power outlet temporarily turns off power when in fault mode if the device exceeds the Watt limit. Unplug your device and switch the ignition off. Switch the ignition back on, but do not plug your device back in. Let the system cool off and switch the ignition off to reset the fault mode. Switch the ignition back on and make sure the indicator light remains on.

# Wireless Accessory Charger (If Equipped)

## WHAT IS THE WIRELESS ACCESSORY CHARGER

The wireless accessory charger allows you to charge one compatible Qi wireless charging device on the charging area.

## WIRELESS ACCESSORY CHARGER PRECAUTIONS



**WARNING:** Wireless charging devices can affect the operation of implanted medical devices, including cardiac pacemakers. If you have any implanted medical devices, we recommend that you consult with your physician.

Tests on this equipment show that it complies with part 18 of the FCC Rules.

- This equipment generates, uses and can radiate radio frequency energy and may cause harmful interference to radio communications. There is no guarantee that the interference will not occur in a particular installation. If this equipment does cause harmful interference to radio or television reception, please consult the dealer.
- This product is not end-user serviceable.



**WARNING:** Changes or modifications not expressly approved by the party responsible for compliance could void the user's authority to operate the equipment. The term "IC:" before the radio certification number only signifies that Industry Canada technical specifications were met.

This device complies with Industry Canada licence-exempt RSS standard(s).

Operation is subject to:

- This device may not cause interference.
- This device must accept any interference, including interference that may cause undesired operation of the device.

Keep the charging area clean and remove foreign objects prior to charging a device.

Do not place items with a magnetic strip, for example passports, parking tickets or credit cards, near the charging area when charging a device. Damage may occur to the magnetic strip.

Do not place metal objects, for example remote controls, coins and candy wrappers, on or near the charging area when charging a device. Metal objects may heat up and degrade the charging performance, in addition to causing error messages and interruptions in charging.

**Note:** *During charging, the device and the charger could heat up, this is normal. If the battery gets hotter than usual, the device may stop charging.*

## LOCATING THE WIRELESS ACCESSORY CHARGER



The charging area is on the center console or in the media bin below the instrument panel.

## CHARGING A WIRELESS DEVICE

Place the device on the center of the charging surface with the charging side down. The charging stops after your device reaches a full charge.

## **Wireless Accessory Charger (If Equipped)**

---

You can use the charger when the vehicle is in accessory mode, when the vehicle is running, or when SYNC is on.

# Storage

## CUP HOLDERS

### Cup Holder Precautions



**WARNING:** Use caution when stowing items or hot drinks in the cup holders. Items could become loose or spill during hard braking, acceleration or crashes. Failure to follow this instruction could result in personal injury.

## UNDER SEAT STORAGE

### Locating the Under Seat Storage Compartment (If Equipped)

#### Rear Under Seat Storage

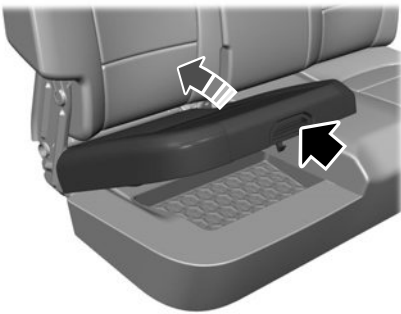

Push the latch and lift the seat cushion to access the storage compartment.

**Note:** For proper operation, keep the under seat storage rubber bin in place when the vehicle is in motion.

## GLASSES HOLDER

### Locating the Glasses Holder



The glasses holder is in the overhead console. Press near the rear edge of the door to open.

## MAP POCKET (If Equipped)

### Locating the Map Pocket

A zipper map pocket and strap system are on the backs of the front seats.

## Storage

---

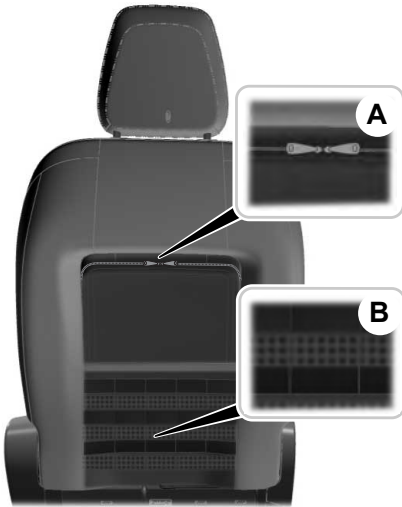

- A. Zipper map pocket.
- B. Strap system.

**Note:** *The recommended load for the overall system should not exceed 5 lb (2.2 kg).*

# Starting and Stopping the Engine

## GENERAL INFORMATION



**WARNING:** Extended idling at high engine speeds can produce very high temperatures in the engine and exhaust system, creating the risk of fire or other damage.



**WARNING:** Do not park, idle or drive your vehicle on dry grass or other dry ground cover. The emission system heats up the engine compartment and exhaust system, creating the risk of fire.



**WARNING:** Do not start the engine in a closed garage or in other enclosed areas. Exhaust fumes can be toxic. Always open the garage door before you start the engine.



**WARNING:** Exhaust leaks may result in entry of harmful and potentially lethal fumes into the passenger compartment. If you smell exhaust fumes inside your vehicle, have your vehicle inspected immediately. Do not drive if you smell exhaust fumes.

If you disconnect the battery, your vehicle may exhibit some unusual driving characteristics for approximately 5 mi (8 km) after you reconnect it. This is because the engine management system must realign itself with the engine. You can disregard any unusual driving characteristics during this period.

The powertrain control system meets all Canadian interference-causing equipment standard requirements regulating the impulse electrical field or radio noise.

When you start the engine, avoid pressing the accelerator pedal before and during operation. Only use the accelerator pedal when you have difficulty starting the engine.

## IGNITION SWITCH

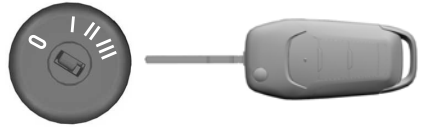

**0** (off) - The ignition is off.

**Note:** When you switch the ignition off and leave your vehicle, do not leave your key in the ignition. This could cause your vehicle battery to lose charge.

**I** (accessory) - Allows the electrical accessories, such as the radio, to operate while the engine is not running.

**Note:** Do not leave the ignition key in this position for too long. This could cause your vehicle battery to lose charge.

**II** (on) - All electrical circuits are operational and the warning lamps and indicators illuminate.

**III** (start) - cranks the engine.

## KEYLESS STARTING (IF EQUIPPED)

**Note:** The keyless starting system may not function if the key is close to metal objects or electronic devices such as cellular phones

**Note:** A valid key must be located inside your vehicle to switch the ignition on and start the engine.

# Starting and Stopping the Engine

## Ignition Modes



E142555

The keyless starting system has three modes:

**Off:** Turns the ignition off.

- Without applying the brake pedal, press and release the button once when the ignition is in the on mode, or when the engine is running but the vehicle is not moving.

**On:** All electrical circuits are operational and the warning lamps and indicators illuminate.

- Without applying the brake pedal, press and release the button once.

**Start:** Starts the engine.

- Press the brake pedal, and then press and hold the button until the engine starts.

## STARTING A GASOLINE ENGINE

When you start the engine, the idle speed increases. This helps to warm up the engine. If the engine idle speed does not slow down, have your vehicle checked by an authorized dealer.

Before starting the engine check the following:

- Make sure all occupants have fastened their seatbelts.
- Make sure the headlamps and electrical accessories are off.
- Make sure the parking brake is on.
- Make sure the transmission is in park (P).

### Vehicles with an Ignition Key

**Note:** Do not touch the accelerator pedal.

- Fully press the brake pedal.
- Turn the key to the start position to start your vehicle.

**Note:** The engine may continue cranking for up to 15 seconds or until it starts.

**Note:** If you cannot start the engine on the first try, wait for a short period and try again.

### Vehicles with Keyless Start

**Note:** Do not touch the accelerator pedal.

- Fully press the brake pedal.
- Press the push button ignition switch until the engine starts.

The system does not function if:

- The passive key frequencies are jammed.
- The key battery has no charge.

If you are unable to start your vehicle, do the following:



# Starting and Stopping the Engine

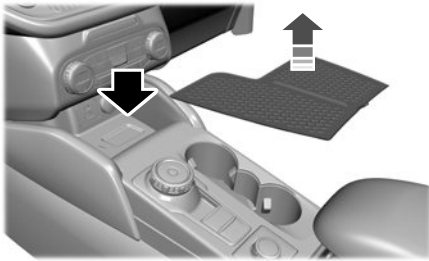

1. Place the key in the middle of the tray as shown.
2. With the key in this position, press the brake pedal then press the push button ignition switch to switch the ignition on and start your vehicle.

## Fast Restart

The fast restart feature allows you to restart your vehicle within 20 seconds of switching it off, even if it does not detect a valid passive key.

Within 20 seconds of switching the engine off, press the brake pedal and press the push button ignition switch. After 20 seconds, you can no longer start your vehicle if it does not detect a valid passive key.

Once your vehicle starts, it remains running until you press the push button ignition switch, even if your vehicle does not detect a valid passive key. If you open and close a door while your vehicle is running, the system searches for a valid passive key. You cannot start your vehicle if the system does not detect a valid passive key within 20 seconds.

## Failure to Start

If you cannot start your vehicle after three attempts, wait 10 seconds and do the following:

1. Fully press the brake pedal.
2. Apply the parking brake.
3. Shift into park (P).
4. Fully press the accelerator pedal and hold it there.
5. Turn the key to position **III** and wait until the engine stops cranking.
6. Release the accelerator pedal.
7. Start the engine.

## Automatic Engine Shutdown

For vehicles with a keyless ignition, this automatically shuts down your vehicle if it has been idling for an extended period. The ignition also turns off to save battery power. Before your vehicle shuts down, a message appears in the information display showing a timer counting down. If you do not intervene within 30 seconds, your vehicle shuts down. Another message appears in the information display to inform you that your vehicle has shut down to save fuel. Start your vehicle as normal.

## Automatic Engine Shutdown Override

**Note:** *You cannot permanently switch off the automatic shutdown. When you switch it off temporarily, it turns on at the next ignition cycle.*

You can stop the shutdown, or reset the timer, at any point before the 30-second countdown has expired by doing any of the following:

- Interacting with your vehicle, for example pressing the brake or accelerator pedal.
- You can temporarily switch off the shutdown any time the ignition is on using the information display. See **Information Displays** (page 99).
- Pressing the OK or RESET button to temporarily switch the feature off for the current ignition cycle only.

# Starting and Stopping the Engine

## Stopping the Engine When Your Vehicle is Stationary

### Vehicles with an Ignition Key

1. Shift into park (P).
2. Apply the parking brake.
3. Turn the key to the off position.

### Vehicles with Keyless Start

1. Shift into park (P).
2. Apply the parking brake.
3. Press the push button ignition switch.

**Note:** *The ignition, all electrical circuits and all warning lamps and indicators will be turned off.*

## Stopping the Engine When Your Vehicle is Moving



**WARNING:** Switching off the engine when your vehicle is still moving results in a significant decrease in braking assistance. Higher effort is required to apply the brakes and to stop your vehicle. A significant decrease in steering assistance could also occur. The steering does not lock, but higher effort could be required to steer your vehicle. When you switch the ignition off, some electrical circuits, for example airbags, also turn off. If you unintentionally switch the ignition off, shift into neutral (N) and restart the engine.

### Vehicles with an Ignition Key

1. Shift into neutral and use the brakes to bring your vehicle to a safe stop.
2. When your vehicle has stopped, shift into park (P) and switch the ignition off.
3. Apply the parking brake.

### Vehicles with Keyless Start

1. Shift into neutral and use the brakes to bring your vehicle to a safe stop.
2. When your vehicle has stopped, shift into park (P).
3. Press and hold the push button ignition switch, or press it three times within two seconds.
4. Apply the parking brake.

## Guarding Against Exhaust Fumes



**WARNING:** Exhaust leaks may result in entry of harmful and potentially lethal fumes into the passenger compartment. If you smell exhaust fumes inside your vehicle, have your vehicle inspected immediately. Do not drive if you smell exhaust fumes.

## Important Ventilating Information

If you stop your vehicle and then leave the engine idling for long periods, we recommend that you do one of the following:

- Open the windows at least 1 in (3 cm).
- Set your climate control to outside air.

## ENGINE BLOCK HEATER (IF

EQUIPPED)



**WARNING:** Failure to follow engine block heater instructions could result in property damage or serious personal injury.



**WARNING:** Do not use your heater with ungrounded electrical systems or two-pronged adapters. There is a risk of electrical shock.

# Starting and Stopping the Engine



**WARNING:** Do not fully close the hood, or allow it to drop under its own weight when using the engine block heater. This could damage the power cable and may cause an electrical short resulting in fire, injury and property damage.

**Note:** *The heater is most effective when outdoor temperatures are below 0°F (-18°C).*

The heater acts as a starting aid by warming the engine coolant. This allows the climate control system to respond quickly. The equipment includes a heater element, installed in the engine block and a wire harness. You can connect the system to a grounded 120-volt AC electrical source.

We recommend that you do the following for a safe and correct operation:

- Use a 16-gauge outdoor extension cord that is product certified by Underwriter's Laboratory (UL) or Canadian Standards Association (CSA). This extension cord must be suitable for use outdoors, in cold temperatures, and be clearly marked Suitable for Use with Outdoor Appliances. Do not use an indoor extension cord outdoors. This could result in an electric shock or become a fire hazard.
  - Use as short an extension cord as possible.
  - Do not use multiple extension cords.
  - Make sure that when in operation, the extension cord plug and heater cord plug connections are free and clear of water. This could cause an electric shock or fire.
- If the block heater cord is under the hood, Do Not remove the wiring from its original location. Do Not close the hood on the extension wiring.
  - Make sure your vehicle is parked in a clean area, clear of combustibles.
  - Make sure the heater, heater cord and extension cord are firmly connected.
  - Check for heat anywhere in the electrical hookup once the system has been operating for approximately 30 minutes.
  - Make sure the system is unplugged and properly stowed before starting and driving your vehicle. Make sure the protective cover seals the prongs of the block heater cord plug when not in use.
  - Make sure the heater system is checked for proper operation before winter.

## Using the Engine Block Heater

Make sure the receptacle terminals are clean and dry prior to use. Clean them with a dry cloth if necessary.

The heater uses 0.4 to 1.0 kilowatt-hours of energy per hour of use. The system does not have a thermostat. It achieves maximum temperature after approximately three hours of operation. Using the heater longer than three hours does not improve system performance and unnecessarily uses electricity.

# Unique Driving Characteristics

## AUTO-START-STOP

The system helps reduce fuel consumption by automatically shutting off and restarting the engine while your vehicle is stopped. The engine restarts when you release the brake pedal. Your vehicle may restart in some situations, for example:

- To maintain interior comfort.
- To recharge the battery.

**Note:** *Power assist steering is turned off when the engine is off.*



**WARNING:** Apply the parking brake, shift into park (P), switch the ignition off and remove the key before you open the hood or have any service or repair work completed. If you do not switch the ignition off, the engine could restart at any time. Failure to follow this instruction could result in personal injury or death.



**WARNING:** The system may require the engine to automatically restart when the auto-start-stop indicator illuminates green or flashes amber. Failure to follow this instruction could result in personal injury.

The Auto-Start-Stop system status is available at a glance within the information display. See **Information Displays** (page 99).

## Enabling Auto-Start-Stop

The system is enabled every time you start your vehicle if the following conditions are met:

- You do not press the Auto-Start-Stop button.
- Your vehicle exceeds an initial speed of 3 mph (5 km/h) after the vehicle initially starts.

- Your vehicle is stopped.
- Your foot is on the brake pedal.
- The transmission is in drive (D).
- The driver door is closed.
- There is adequate brake vacuum.
- The interior compartment has cooled or warmed to an acceptable level.
- The front windshield defroster is off.
- The steering wheel is not being turned.
- The vehicle is not on a steep road slope.
- The battery is within optimal operating conditions, such as battery state of charge and temperature in range.
- The engine coolant is at operating temperature.
- Your vehicle is not being driven at a high altitude.
- The ambient temperature is moderate.



The green Auto-Start-Stop indicator light on the instrument cluster illuminates to indicate when the automatic engine stop occurs.



If the instrument cluster has a grey Auto-Start-Stop indicator light, it illuminates when automatic engine stop is not available due to one of the above noted conditions not being met.

## Automatic Engine Restart

Any of the following conditions results in an automatic restart of the engine if:

- You remove your foot from the brake pedal.
- You press the accelerator pedal.
- You press the accelerator and the brake pedal at the same time.
- The driver seatbelt becomes unfastened or the driver door is ajar.

# Unique Driving Characteristics

---

- Your vehicle is moving.
- The interior compartment does not meet customer comfort when air conditioning or heat is on.
- Fogging of the windows could occur and the air conditioning is on.
- The battery is not within optimal operating conditions.
- You exceed the maximum engine off time.
- You press the Auto-Start-Stop button while the engine is stopped.
- The heated windshield is turned on.

Any of the following conditions could result in an automatic restart of the engine if:

- The blower fan speed increases or the climate control temperature changes.
- You plug in or switch on an electrical accessory.

## Disabling Auto-Start-Stop

Press the Auto-Start-Stop button on the instrument panel to switch the system off. The button illuminates. The system deactivates for the current ignition cycle only. Press the button again to restore the Auto-Start-Stop function.

If your vehicle is in an Auto-Start-Stop state and you shift the transmission to reverse without pressing the brake, a message appears telling you to press the brake. Press the brake pedal within 60 seconds, or shift into park (P) and manually restart your vehicle.

**Note:** *If the Shift to P, Restart Engine message appears and the amber Auto-Start-Stop indicator light is flashing, automatic restart is not available. Manually restart your vehicle. See **Information Displays** (page 99).*

# Fuel and Refueling

## SAFETY PRECAUTIONS



**WARNING:** Do not overfill the fuel tank. The pressure in an overfilled tank may cause leakage and lead to fuel spray and fire.



**WARNING:** The fuel system may be under pressure. If you hear a hissing sound near the fuel filler inlet, do not refuel until the sound stops. Otherwise, fuel may spray out, which could cause serious personal injury.



**WARNING:** Fuels can cause serious injury or death if misused or mishandled.



**WARNING:** Fuel may contain benzene, which is a cancer-causing agent.



**WARNING:** When refueling always shut the engine off and never allow sparks or open flames near the fuel tank filler valve. Never smoke or use a cell phone while refueling. Fuel vapor is extremely hazardous under certain conditions. Avoid inhaling excess fumes.

Follow these guidelines when refueling:

- Extinguish all smoking materials and any open flames before refueling your vehicle.
- Always switch the engine off before refueling.
- Automotive fuels can be harmful or fatal if swallowed. Fuel is highly toxic and if swallowed can cause death or permanent injury. If fuel is swallowed immediately call a physician, even if no symptoms are immediately apparent. The toxic effects of fuel may not be apparent for hours.

- Avoid inhaling fuel vapors. Inhaling fuel vapor can lead to eye and respiratory tract irritation. In severe cases, excessive or prolonged breathing of fuel vapor can cause serious illness and permanent injury.
- Avoid getting fuel in your eyes. If you splash fuel in your eyes, immediately remove contact lenses (if worn), flush with water for 15 minutes and seek medical attention. Failure to seek proper medical attention could lead to permanent injury.
- Fuels can be harmful if absorbed through the skin. If you splash fuel on your skin, clothing or both, promptly remove contaminated clothing and thoroughly wash your skin with soap and water. Repeated or prolonged skin contact causes skin irritation.
- Be particularly careful if you are taking Antabuse or other forms of Disulfiram for the treatment of alcoholism. Breathing fuel vapors could cause an adverse reaction, serious personal injury or sickness. Immediately call a physician if you experience any adverse reactions.

## FUEL QUALITY

### Choosing the Right Fuel

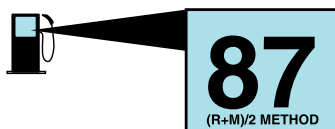

Your vehicle is designed to operate on regular unleaded gasoline with a minimum pump (R+M)/2 octane rating of 87.

# Fuel and Refueling

Some fuel stations, particularly those in high altitude areas, offer fuels posted as regular unleaded gasoline with an octane rating below 87. The use of these fuels could result in engine damage that will not be covered by the vehicle warranty.

For best overall vehicle and engine performance, premium fuel with an octane rating of 91 or higher is recommended. The performance gained by using premium fuel is most noticeable in hot weather as well as other conditions, for example when towing a trailer. See **Towing** (page 235).

Do not be concerned if the engine sometimes knocks lightly. However, if the engine knocks heavily while using fuel with the recommended octane rating, contact an authorized dealer to prevent any engine damage.

We recommend Top Tier detergent gasolines, where available to help minimize engine deposits and maintain optimal vehicle and engine performance. For additional information, refer to [www.toptiergas.com](http://www.toptiergas.com).

**Note:** *Use of any fuel for which the vehicle was not designed can impair the emission control system, cause loss of vehicle performance, and cause damage to the engine which may not be covered by the vehicle Warranty.*

Do not use:

- Diesel fuel.
- Fuels containing kerosene or paraffin.
- Fuel containing more than 15% ethanol or E85 fuel.
- Fuels containing methanol.
- Fuels containing metallic-based additives, including manganese-based compounds.

- Fuels containing the octane booster additive, methylcyclopentadienyl manganese tricarbonyl (MMT).
- Leaded fuel, using leaded fuel is prohibited by law.

The use of fuels with metallic compounds such as methylcyclopentadienyl manganese tricarbonyl (commonly known as MMT), which is a manganese-based fuel additive, will impair engine performance and affect the emission control system.

## FUEL FILLER FUNNEL LOCATION

The fuel filler funnel is under the luggage compartment floor covering.

## RUNNING OUT OF FUEL

Running out of fuel can cause damage not covered by the vehicle Warranty.

If your vehicle runs out of fuel:

- Add a minimum of 1.3 gal (5 L) of fuel to restart the engine.
- You may need to switch the ignition from off to on several times after refueling to allow the fuel system to pump the fuel from the tank to the engine. When restarting, cranking time takes a few seconds longer than normal.

**Note:** *If your vehicle is on a steep slope, more fuel may be required.*

## Filling a Portable Fuel Container



**WARNING:** Flow of fuel through a fuel pump nozzle can produce static electricity. This can cause a fire if you are filling an ungrounded fuel container.

# Fuel and Refueling

Use the following guidelines to avoid electrostatic charge build-up, which can produce a spark, when filling an ungrounded fuel container:

- Only use an approved fuel container to transfer fuel to your vehicle. Place the container on the ground when filling it.
- Do not fill a fuel container when it is inside your vehicle (including the cargo area).
- Keep the fuel pump nozzle in contact with the fuel container when filling it.
- Do not use a device that holds the fuel pump nozzle lever in the fill position.

## Adding Fuel From a Portable Fuel Container



**WARNING:** Do not insert the nozzle of a fuel container or an aftermarket funnel into the fuel filler neck. This may damage the fuel system filler neck or its seal and cause fuel to run onto the ground.



**WARNING:** Do not try to pry open or push open the capless fuel system with foreign objects. This could damage the fuel system and its seal and cause injury to you or others.



**WARNING:** Do not dispose of fuel in the household refuse or the public sewage system. Use an authorized waste disposal facility.

When refueling the vehicle fuel tank from a fuel container, use the fuel filler funnel included with your vehicle. See **Fuel Filler Funnel Location** (page 156).

**Note:** *Do not use aftermarket funnels as they may not work with the capless fuel system and can damage it.*

When refueling the vehicle fuel tank from a fuel container, do the following:

1. Fully open the fuel filler door.
2. Fully insert the fuel filler funnel into the fuel filler inlet.



3. Add fuel to your vehicle from the fuel container.
4. Remove the fuel filler funnel.
5. Fully close the fuel filler door.
6. Clean the fuel filler funnel and place it back in your vehicle or correctly dispose of it.

**Note:** *Extra funnels can be purchased from an authorized dealer if you choose to dispose of the funnel.*



# Fuel and Refueling

## REFUELING

### Refueling System Overview

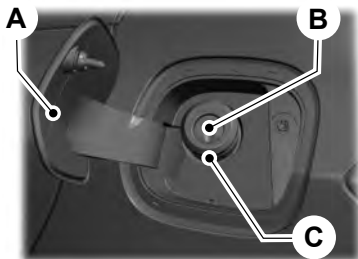

- A Fuel filler door.
- B Fuel tank filler valve.
- C Fuel tank filler pipe.

Your vehicle does not have a fuel tank filler cap.

### Refueling Your Vehicle

**WARNING:** When refueling always shut the engine off and never allow sparks or open flames near the fuel tank filler valve. Never smoke or use a cell phone while refueling. Fuel vapor is extremely hazardous under certain conditions. Avoid inhaling excess fumes.

**WARNING:** The fuel system may be under pressure. If you hear a hissing sound near the fuel filler inlet, do not refuel until the sound stops. Otherwise, fuel may spray out, which could cause serious personal injury.

**WARNING:** Do not pry open the fuel tank filler valve. This could damage the fuel system. Failure to follow this instruction could result in fire, personal injury or death.

**WARNING:** Do not remove the fuel pump nozzle from its fully inserted position when refueling.

**WARNING:** Stop refueling when the fuel pump nozzle automatically shuts off for the first time. Failure to follow this will fill the expansion space in the fuel tank and could lead to fuel overflowing.

**WARNING:** Do not overfill the fuel tank. The pressure in an overfilled tank may cause leakage and lead to fuel spray and fire.

**WARNING:** Wait at least five seconds before removing the fuel pump nozzle to allow any residual fuel to drain into the fuel tank.

1. Fully open the fuel filler door.
2. Select the correct fuel pump nozzle for your vehicle.

# Fuel and Refueling

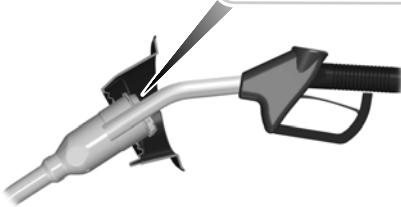
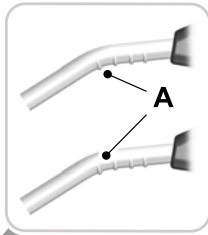

3. Insert the fuel pump nozzle up to the first notch on the nozzle A. Keep the fuel pump nozzle resting on the fuel tank filler pipe.

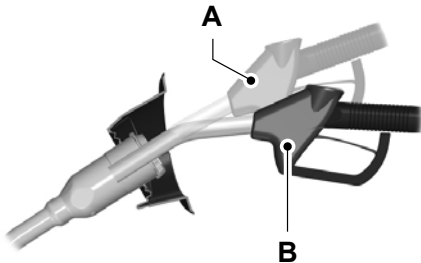

E139203

4. Hold the fuel pump nozzle in position B when refueling. Holding the fuel pump nozzle in position A can affect the flow of fuel and shut off the fuel pump nozzle before the fuel tank is full.

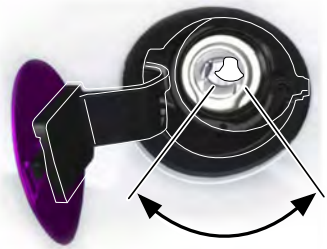

5. Operate the fuel pump nozzle within the area shown.

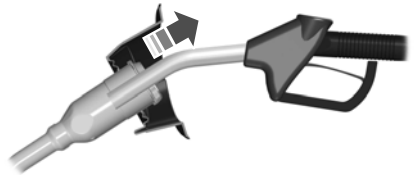

6. When the pump shuts off, wait 5 seconds then slightly raise the fuel pump nozzle and slowly remove it.
7. Fully close the fuel filler door.

Do not attempt to start the engine if you fill the fuel tank with incorrect fuel. Incorrect fuel use could cause damage the vehicle Warranty may not cover. Have your vehicle immediately checked.

## Refueling System Warning (If Equipped)

If the fuel tank filler valve does not fully close, a message could appear in the information display.

<b>Message</b>
Check Fuel Fill Inlet

If the message appears, do the following:

# Fuel and Refueling

1. Stop your vehicle as soon as it is safe to do so and switch the engine off.
2. Shift into park (P) or neutral (N).
3. Apply the parking brake.
4. Fully open the fuel filler door.
5. Check the fuel tank filler valve for any debris that could be restricting its movement.
6. Remove any debris from the fuel tank filler valve.
7. Fully insert a fuel pump nozzle or the fuel filler funnel provided with your vehicle into the fuel filler pipe. See **Fuel Filler Funnel Location** (page 156). This action should dislodge any debris that could be preventing the fuel tank filler valve from fully closing.
8. Remove the fuel pump nozzle or fuel filler funnel from the fuel filler pipe.
9. Fully close the fuel filler door.

**Note:** *The message may not immediately reset. If the message continues to appear and a warning lamp illuminates, have your vehicle checked as soon as possible.*

## FUEL CONSUMPTION

### Advertised Capacity

The advertised capacity is the maximum amount of fuel that you can add to the fuel tank when the fuel gauge indicates empty. In addition, the fuel tank contains an empty reserve. The empty reserve is an unspecified amount of fuel that remains in the fuel tank when the fuel gauge indicates empty.

**Note:** *The amount of fuel in the empty reserve varies and should not be relied upon to increase driving range.*

### Calculating Fuel Economy

Your vehicle calculates fuel economy figures through the trip computer average fuel function. See **Information Displays** (page 99).

The first 1,000 mi (1,600 km) of driving is the break-in period of the vehicle. A more accurate measurement is obtained after 2,000–3,000 mi (3,200–4,800 km).

1. Completely fill the fuel tank and record the initial odometer reading. See **Refueling** (page 158).
2. Each time you fill the fuel tank, record the amount of fuel added.
3. After at least three fill ups, fill the fuel tank and record the current odometer reading.
4. Subtract your initial odometer reading from the current odometer reading.

To calculate L/100 km (liters per 100 kilometers) fuel consumption, multiply the liters used by 100, then divide by kilometers traveled. To calculate MPG (miles per gallon) fuel consumption, divide miles traveled by gallons used.

Keep a record for at least one month and record the type of driving, for example city or highway. This provides an accurate estimate of your vehicle's fuel economy under current driving conditions. Keeping records during summer and winter shows how temperature impacts fuel economy.

### Conditions Influencing Fuel Efficiency

- Carrying unnecessary weight in your vehicle will reduce fuel efficiency.
- Avoid adding accessories that increase aerodynamic drag to your vehicle such as bug deflectors, car top carriers and ski or bike racks.
- Remove empty roof racks and keep windows shut at high speeds to reduce wind resistance and fuel use.

# Fuel and Refueling

---

- Check and adjust tire pressure regularly. Under inflated tires will increase fuel consumption.
- Sudden acceleration and braking degrade fuel efficiency. Drive smoothly looking as far ahead as possible and avoid short trips when possible.
- Fuel efficiency degrades with lower temperatures.
- Comfort Features use additional energy and consume more fuel. Use AC and other comfort features only when necessary.
- Using fuel blended with alcohol may increase fuel consumption.

# Engine Emission Control

## EMISSION LAW



**WARNING:** Do not remove or alter the original equipment floor covering or insulation between it and the metal floor of the vehicle. The floor covering and insulation protect occupants of the vehicle from the engine and exhaust system heat and noise. On vehicles with no original equipment floor covering insulation, do not carry passengers in a manner that permits prolonged skin contact with the metal floor. Failure to follow these instructions may result in fire or personal injury.

U.S. federal laws and certain state laws prohibit removing or rendering inoperative emission control system components. Similar federal or provincial laws may apply in Canada. We do not approve of any vehicle modification without first determining applicable laws.



Tampering with emissions control systems including related sensors or the Diesel Exhaust Fluid system can result in reduced engine power and the illumination of the service engine soon light.

## Tampering With a Noise Control System

Federal laws prohibit the following acts:

- Removal or rendering inoperative by any person other than for purposes of maintenance.
- Repair or replacement of any device or element of the design incorporated into a new vehicle for the purpose of noise control prior to its sale or delivery to the ultimate purchaser or while it is in use.
- The use of the vehicle after any person removes or renders inoperative any device or element of the design.

The U.S. Environmental Protection Agency may presume to constitute tampering as follows:

- Removal of hood blanket, fender apron absorbers, fender apron barriers, underbody noise shields or acoustically absorptive material.
- Tampering or rendering inoperative the engine speed governor, to allow engine speed to exceed manufacturer specifications.

If the engine does not start, runs rough, experiences a decrease in engine performance, experiences excess fuel consumption or produces excessive exhaust smoke, check for the following:

- A plugged or disconnected air inlet system hose.
- A plugged engine air filter element.
- Water in the fuel filter and water separator.
- A clogged fuel filter.
- Contaminated fuel.
- Air in the fuel system, due to loose connections.
- An open or pinched sensor hose.
- Incorrect engine oil level.

# Engine Emission Control

- Incorrect fuel for climatic conditions.
- Incorrect engine oil viscosity for climactic conditions.

**Note:** *Some vehicles have a lifetime fuel filter that is integrated with the fuel tank. Regular maintenance or replacement is not needed.*

**Note:** *If these checks do not help you correct the concern, have your vehicle checked as soon as possible.*

## Noise Emissions Warranty, Prohibited Tampering Acts and Maintenance

On January 1, 1978, Federal regulation became effective governing the noise emission on trucks over 10,000 lb (4,536 kg) Gross Vehicle Weight Rating (GVWR). The preceding statements concerning prohibited tampering acts and maintenance, and the noise warranty found in the Warranty Guide, are applicable to complete chassis cabs over 10,000 lb (4,536 kg) GVWR.

## CATALYTIC CONVERTER



**WARNING:** Do not park, idle or drive your vehicle on dry grass or other dry ground cover. The emission system heats up the engine compartment and exhaust system, creating the risk of fire.



**WARNING:** The normal operating temperature of the exhaust system is very high. Never work around or attempt to repair any part of the exhaust system until it has cooled. Use special care when working around the catalytic converter. The catalytic converter heats up to a very high temperature after only a short period of engine operation and stays hot after the engine is switched off.



**WARNING:** Exhaust leaks may result in entry of harmful and potentially lethal fumes into the passenger compartment. If you smell exhaust fumes inside your vehicle, have your vehicle inspected immediately. Do not drive if you smell exhaust fumes.

Your vehicle has various emission control components and a catalytic converter that enables it to comply with applicable exhaust emission standards.

To make sure that the catalytic converter and other emission control components continue to work properly:

- Do not crank the engine for more than 10 seconds at a time.
- Do not run the engine with a spark plug lead disconnected.
- Do not push-start or tow-start your vehicle. Use booster cables. See **Jump Starting the Vehicle** (page 252).
- Use only the specified fuel listed.
- Do not switch the ignition off when your vehicle is moving.
- Avoid running out of fuel.
- Have the items listed in scheduled maintenance information performed according to the specified schedule.

**Note:** *Resulting component damage may not be covered by the vehicle Warranty.*

The scheduled maintenance items listed in scheduled maintenance information are essential to the life and performance of your vehicle and to its emissions system.

If you use anything other than Ford, Motorcraft or Ford-authorized parts for maintenance replacements or for service of components affecting emission control, such non-Ford parts should be equivalent to genuine Ford Motor Company parts in performance and durability.

# Engine Emission Control

Illumination of the service engine soon indicator, charging system warning light or the temperature warning light, fluid leaks, strange odors, smoke or loss of engine power could indicate that the emission control system is not working properly.

An improperly operating or damaged exhaust system may allow exhaust to enter the vehicle. Have a damaged or improperly operating exhaust system inspected and repaired immediately.

Do not make any unauthorized changes to your vehicle or engine. By law, vehicle owners and anyone who manufactures, repairs, services, sells, leases, trades vehicles, or supervises a fleet of vehicles are not permitted to intentionally remove an emission control device or prevent it from working. Information about your vehicle's emission system is on the Vehicle Emission Control Information Decal located on or near the engine. This decal also lists engine displacement.

Please consult your warranty information for complete details.

## On-Board Diagnostics (OBD-II)

Your vehicle has a computer known as the on-board diagnostics system (OBD-II) that monitors the engine's emission control system. The system protects the environment by making sure that your vehicle continues to meet government emission standards. The OBD-II system also assists a service technician in properly servicing your vehicle.



When the service engine soon indicator illuminates, the OBD-II system has detected a malfunction. Temporary malfunctions may cause the service engine soon indicator to illuminate. Examples are:

1. Your vehicle has run out of fuel—the engine may misfire or run poorly.
2. Poor fuel quality or water in the fuel—the engine may misfire or run poorly.
3. The fuel fill inlet may not have closed properly. See **Refueling** (page 158).
4. Driving through deep water—the electrical system may be wet.

You can correct these temporary malfunctions by filling the fuel tank with good quality fuel, properly closing the fuel fill inlet or letting the electrical system dry out. After three driving cycles without these or any other temporary malfunctions present, the service engine soon indicator should stay off the next time you start the engine. A driving cycle consists of a cold engine startup followed by mixed city and highway driving. No additional vehicle service is required.

If the service engine soon indicator remains on, have your vehicle serviced at the first available opportunity. Although some malfunctions detected by the OBD-II may not have symptoms that are apparent, continued driving with the service engine soon indicator on can result in increased emissions, lower fuel economy, reduced engine and transmission smoothness and lead to more costly repairs.

## Readiness for Inspection and Maintenance (I/M) Testing

Some state and provincial and local governments may have Inspection/Maintenance (I/M) programs to inspect the emission control equipment on your vehicle. Failure to pass this inspection could prevent you from getting a vehicle registration.



If the service engine soon indicator is on or the bulb does not work, your vehicle may need service. See On-Board Diagnostics.

# Engine Emission Control

---

Your vehicle may not pass the I/M test if the service engine soon indicator is on or not working properly (bulb is burned out), or if the OBD-II system has determined that some of the emission control systems have not been properly checked. In this case, the vehicle is not ready for I/M testing.

If the vehicle's engine or transmission has just been serviced, or the battery has recently run down or been replaced, the OBD-II system may indicate that the vehicle is not ready for I/M testing. To determine if the vehicle is ready for I/M testing, turn the ignition key to the on position for 15 seconds without cranking the engine. If the service engine soon indicator blinks eight times, it means that the vehicle is not ready for I/M testing; if the service engine soon indicator stays on solid, it means that your vehicle is ready for I/M testing.

The OBD-II system checks the emission control system during normal driving. A complete check may take several days.

If the vehicle is not ready for I/M testing, you can perform the following driving cycle consisting of mixed city and highway driving:

1. 15 minutes of steady driving on an expressway or highway followed by 20 minutes of stop-and-go driving with at least four 30-second idle periods.
2. Allow your vehicle to sit for at least eight hours with the ignition off. Then, start the vehicle and complete the above driving cycle. The vehicle must warm up to its normal operating temperature. Once started, do not turn off the vehicle until the above driving cycle is complete.

If the vehicle is still not ready for I/M testing, you need to repeat the above driving cycle.



# Transmission

## AUTOMATIC TRANSMISSION



**WARNING:** Do not apply the brake pedal and accelerator pedal simultaneously. Applying both pedals simultaneously for more than a few seconds will limit engine performance, which may result in difficulty maintaining speed in traffic and could lead to serious injury.



**WARNING:** When your vehicle is stationary, keep the brake pedal fully pressed when shifting gears. Failure to follow this instruction could result in personal injury, death or property damage.



**WARNING:** Apply the parking brake, shift into park (P), switch the ignition off and remove the key before you leave your vehicle. Failure to follow this instruction could result in personal injury or death.

**Note:** You may not be able to shift out of park (P) unless the remote control is inside your vehicle.

## Understanding the Shift Positions of Your Automatic Transmission



### Putting your vehicle in or out of gear:

Your vehicle has an electronic transmission shifter. The transmission selector is on the center console, below the climate control system.

To place the vehicle in gear from park (P):

1. Fully press and hold the brake pedal when shifting out of park (P).

# Transmission

2. Rotate the outer ring of the transmission selector clockwise from park (P), until the desired gear illuminates on the transmission selector.
3. Release the brake pedal and the transmission remains in the selected gear.

The instrument cluster also displays the current gear.

## Park (P)

In park (P), no power transmits to the driven wheels and the transmission locks. You can start the engine with the transmission in this position.

Shift into park (P) only when your vehicle is stationary.

**Note:** *The electric parking brake could automatically apply when you shift into park (P). See **Electric Parking Brake** (page 177).*

## Reverse (R)

Shift into reverse (R) only when your vehicle is stationary and the engine is at idle speed.

## Neutral (N)



**WARNING:** In neutral (N) your vehicle has the ability to roll freely. If you intend to leave your vehicle, make sure you apply the parking brake.

In neutral (N), no power transmits to the driven wheels but the transmission does not lock. You can start the engine with the transmission in this position.

## Drive (D)

Drive (D) is the normal driving position for the best fuel economy.

## Manual (M) (If Equipped)

With your vehicle in drive (D), press the manual (M) button to activate manual mode.

In manual (M), you can upshift or downshift using the paddle shifters.

## Low(L) (If Equipped)

With your vehicle in drive (D), press the low (L) button to activate low mode.

- Provides maximum engine braking.
- You can shift the transmission into low (L) at any vehicle speed.
- Is not for use under extended or normal driving conditions and results in lower fuel economy.

## SelectShift (If Equipped)

Use this feature to upshift or downshift using the paddle shifters.

You can only use this feature in drive (D) or manual (M).

The current gear flashes when you cannot shift into the requested gear.



Pull any paddle to switch the feature on.

**Note:** *SelectShift in drive (D) provides temporary manual control of the gear selection.*

- Pull the right paddle (+) to upshift.
- Pull the left paddle (-) to downshift.

# Transmission

In manual (M), press the manual (M) button to switch the feature off and return to drive (D).

**Note:** The shift schedule can change with drive modes. Using drive modes could change when you can shift into the requested gear. See **Drive Mode Control** (page 223).

## Automatic Return to Park

**Note:** This feature does not operate when your vehicle is in stay in neutral (N).

Your vehicle has a feature that shifts your vehicle into park (P) when any of the following conditions occur:

- You switch the vehicle off.
- You open the driver door with your seatbelt unlatched.
- You unlatch your seatbelt when the driver door is open.

If you switch your vehicle off when moving, the vehicle first shifts into neutral (N) until it slows down enough to shift into park (P).

**Note:** If you have waited for more than two minutes before starting your vehicle, unlatching your seatbelt causes this feature to activate, even with the driver door closed.

**Note:** This feature may not work properly if the door ajar switch is malfunctioning. If your door ajar indicator does not illuminate when you open the driver door or the indicator illuminates with the driver door closed, see your authorized dealer.

## Stay in Neutral Mode

Stay in neutral mode allows your vehicle to stay in neutral when you exit your vehicle. Your vehicle must be stationary to enter this mode.

Do not tow your vehicle in this mode.

**Note:** Stay in neutral is a temporary vehicle state with the ignition off. Once in this mode, sufficient battery voltage must be maintained or your vehicle returns to park. Not maintaining sufficient battery voltage could damage the battery which the vehicle warranty would not cover.

**Note:** When entering an automatic car wash, always shift to neutral (N). If you are exiting the vehicle before the car wash, stay in neutral mode is available.

## To enter stay in neutral mode

1. Bring your vehicle to a complete stop.
2. With the key ON and the engine running, press and hold the brake pedal.
3. Shift in neutral (N).

**Note:** When in neutral (N), a message appears in the display screen informing you how to access stay in neutral mode.

4. Press the manual (M), or low (L) button in the middle of the transmission selector to enter stay in neutral mode.

**Note:** A message appears in the display screen confirming your vehicle is in stay in neutral mode. The neutral (N) indicator light on the transmission selector slowly flashes.

5. Release the brake pedal.
6. Switch the ignition off.

To exit stay in neutral mode, place your foot on the brake pedal and shift into park (P), or start the engine and shift into drive (D) or reverse (R).

# Transmission

## Manual Park Release



**WARNING:** When doing this procedure, you need to take the transmission out of park (P) which means your vehicle can roll freely. To avoid unwanted vehicle movement, always fully apply the parking brake prior to doing this procedure. Use wheel chocks if appropriate.



**WARNING:** If the parking brake is fully released, but the brake warning lamp remains illuminated, the brakes may not be working properly. Have your vehicle checked as soon as possible.



**WARNING:** Do not drive your vehicle until you verify that the stoplamps are working.

Use the manual park release to move your transmission from the park (P) position in the event of an electrical malfunction or emergency.

### Activating the Manual Park Release Cable

1. Apply the parking brake. See **Electric Parking Brake** (page 177).

**Note:** *If the vehicle battery is dead, for example, no electrical power is available, you could use an external power source to apply the parking brake.*

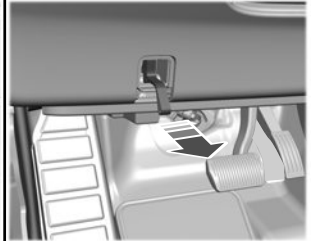
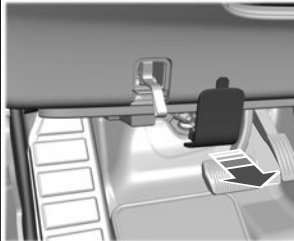
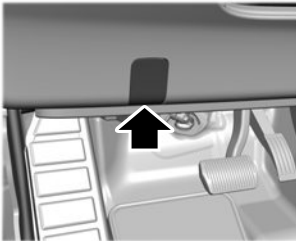

2. Locate the manual park release cable access cover on the lower instrument panel dash to the bottom left-hand side of the steering column.
  3. Using a tool or the key blade, carefully open the access cover.
- Note:** *Do not pull the tether until you are in the driver seat.*
4. Switch the ignition on, but do not start your vehicle.

5. Once in the driver seat, fully press the brake pedal and hold. Do not release. Pull the orange tether towards the driver seat until the tether gets locked in the override position. Then leave the tether.
6. If done correctly, a message on the instrument cluster displays Park Not Available, Transmission Not in Park, or Shift System Fault.

**Note:** *Your vehicle is now out of the park (P) position and is free to roll.*

# Transmission

7. With your foot still fully applied on the brake pedal, disengage the parking brake. See **Electric Parking Brake** (page 177).
8. Your vehicle remains in neutral (N) for emergency towing purposes.
9. Switch off the ignition.
10. Once it is safe to do so and there is no risk that your vehicle will roll, disconnect the negative, black battery cable from the battery. If the vehicle rolls before disconnecting the battery, the electric parking brake could apply. You may need to release the parking brake again. See **Electric Parking Brake** (page 177).

## Returning Your Vehicle to Normal Mode

1. Once it is safe to do so, reconnect the negative, black battery cable to the battery.
2. Apply the parking brake. See **Electric Parking Brake** (page 177).

**Note:** *If the vehicle battery is dead, for example, no electrical power is available, you could use an external power source to apply the parking brake.*

3. Fully apply the brake pedal and hold. Do not release. Pull the orange tether outward toward the driver seat to release it from the override position.
4. The cable releases and retracts back to its original rest position.
5. Stow the manual park release cable tether back inside the instrument panel dash hole, install the access cover by pressing it back in position.
6. With your foot fully applied on the brake pedal, start your vehicle. Confirm that your vehicle is in the park (P) position and that the instrument cluster indicates park (P).
7. If the instrument cluster is not displaying the park (P) position or a message displays on the instrument cluster screen, make sure you apply the parking brake before exiting your vehicle. Contact an authorized dealer for service.

## Information Messages

Message	Details
Transmission Malfunction Service Now	The system detects a fault that requires service. Have your vehicle checked as soon as possible.
Select M To Confirm Stay In Neutral Mode	Displays when you shift into neutral (N).
Select L to Confirm Stay in Neutral Mode	Displays when you shift into neutral (N).
Stay in Neutral Mode Engaged	Displays to confirm that your vehicle has entered Stay in Neutral mode.

# Transmission

---

## **If Your Vehicle Gets Stuck in Mud or Snow**

If your vehicle gets stuck in mud or snow, rock it out by shifting between forward and reverse gears, stopping between shifts in a steady pattern. Press lightly on the accelerator in each gear.

**Note:** *Do not rock the vehicle if the engine is not at normal operating temperature or damage to the transmission could occur.*

**Note:** *Do not rock the vehicle for more than a minute or damage to the transmission and tires could occur, or the engine could overheat.*

# Four-Wheel Drive

## PRINCIPLE OF OPERATION

This system is a proactive system. It has the ability to anticipate wheel slip and transfer torque to the rear wheels before slip occurs. Even when wheel slip is not present, the system is continuously making adjustments to the torque distribution, in an attempt to improve straight line and cornering behavior, both on and off road.

The system automatically turns on every time you switch the ignition on.

If any component requires maintenance, a message appears in the information display.

## USING FOUR-WHEEL DRIVE



A graphic displays in the information display to advise you of the power distribution between the front and rear wheels. The more the area is filled, the more power is being distributed to that wheel.

**Note:** Four-wheel drive is also called 4WD and 4x4.

**Note:** Do not use the four-wheel drive lock, the rear differential lock or off-road selectable drive modes on dry, hard surfaced roads. Doing so can produce excessive noise, increase tire wear and may damage drive components. These features are only intended for consistently slippery or loose surfaces. Operating your vehicle outside of these conditions could subject the vehicle to excessive stress, which may result in damage not covered under your warranty. See **Drive Mode Control** (page 223).

**Note:** When a system malfunction is present, a warning message is displayed in the information display. See **Information Messages** (page 104). This means the system is not functioning correctly and has defaulted to front-wheel drive only. Have your vehicle checked as soon as possible.

**Note:** A message is displayed in the information display if the system overheats and switches to front-wheel drive. This condition could occur if you operate your vehicle in extreme high-load conditions or with excessive wheel slip, for example deep sand. To resume four-wheel drive function as soon as possible, stop your vehicle in a safe location and switch the ignition off for a minimum of 10 minutes. After the system cools, normal four-wheel drive functionality resumes.

**Note:** If a warning message appears in the information display when using the spare tire, it turns off after reinstalling the repaired or replaced road tire and you perform a key cycle.

**Note:** It is recommended that you reinstall the repaired tire or replace the tire as soon as possible. Major dissimilar tire sizes could cause system damage or default the system to front-wheel drive.

# Four-Wheel Drive

---

## Driving in Special Conditions With Four-Wheel Drive

Four-wheel drive has operating characteristics that are somewhat different from front-wheel drive, both on and off the freeway.

When driving at slow speeds under high-load conditions, use a low gear when possible. Low gear operation maximizes the engine and transmission cooling capability.

Under severe operating conditions, the air conditioning may cycle on and off to prevent the engine from overheating.

**Note:** *It may be useful to select the most appropriate drive mode to most effectively maximize vehicle performance. See **Drive Mode Control** (page 223).*

**Note:** *It may be useful to switch traction control off. This allows for more wheel spin and engine torque in certain conditions or if your vehicle becomes stuck.*

**Note:** *If the front or rear axle is submerged in water, check the rear axle lubricant and power transfer unit lubricant and change if necessary. See **Driving Through Water Limitations** (page 246).*

## Basic Operating Principles

Drive slower in strong crosswinds which can affect the normal steering characteristics of your vehicle.

When driving your vehicle on surfaces made slippery by loose sand, water, gravel, snow or ice, proceed with care.

## If Your Vehicle leaves the Road

If your vehicle leaves the road, reduce your vehicle speed and avoid severe braking. When your vehicle speed has been reduced, ease your vehicle back onto the road. Do not turn the steering wheel sharply while returning your vehicle to the road.

It may be safer to stay on the shoulder of the road and slow down gradually before returning to the road. You could lose control if you do not slow down or if you turn the steering wheel too sharply or abruptly.

It may be less risky to strike small objects, such as freeway reflectors, with minor damage to your vehicle rather than attempt a sudden return to the road which could cause your vehicle to slide sideways out of control, or roll over. Remember, your safety and the safety of others is your primary concern.

## Emergency Maneuvers

In an unavoidable emergency where a sudden sharp turn must be made, remember to avoid over-driving your vehicle, for example, turn the steering wheel only as rapidly and as far as required to avoid the emergency. Excessive steering can result in loss of vehicle control. Apply smooth pressure to the accelerator pedal or brake pedal when changes in vehicle speed are required. Avoid abrupt steering, acceleration and braking. This could result in an increased risk of vehicle rollover, loss of vehicle control and personal injury. Use all available road surface to bring your vehicle to a safe direction of travel.

In the event of an emergency stop, avoid skidding the tires and do not attempt any sharp steering wheel movements.

If your vehicle goes from one type of surface to another, for example, from concrete to gravel, there will be a change in the way your vehicle responds to a maneuver, for example, steering, acceleration or braking.

**Note:** *For off-road driving,*



# Four-Wheel Drive

## Four-Wheel Drive Lock (If Equipped)

The four-wheel drive lock increases four-wheel drive performance by preventing the front and rear axles from disconnecting. You can activate and deactivate the four-wheel drive lock on the fly by pressing the button on the drive mode control. It also engages based on certain selected drive modes. See **What Is Drive Mode Control** (page 223).

**Note:** *The four-wheel drive lock is not intended for use on dry pavement. Using the four-wheel drive lock on dry pavement can produce excessive noise, increase tire and vehicle wear.*

**Note:** *The four-wheel drive lock may be required in some drive modes, preventing it from being disabled.*

 This feature provides an indicator light in the information display when in use. While the feature is in standby mode, the light displays gray. While the feature is active, the light becomes colored.

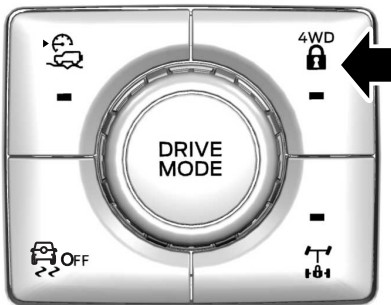

## Rear Differential Lock (If Equipped)

The rear differential lock feature provides additional traction should your vehicle become stuck. You can activate and deactivate the rear differential lock feature while moving within the operating speed range by pressing the button on the drive mode control. The feature disengages when the vehicle speed exceeds a set value and it re-engages when the vehicle speed goes below a set value. It also engages based on certain selected drive modes. See **Selecting a Drive Mode** (page 223).

The rear differential lock feature is for use in mud, rocks, sand or off-road conditions where you need maximum traction. It is not for use on dry pavement.

**Note:** *This feature is for off-road use only and is not for use on dry pavement. Using the rear differential lock feature on dry pavement can produce excessive noise, and increase tire and vehicle wear. Operating your vehicle in these conditions could subject your vehicle to excessive stress, which may result in damage not covered under your warranty.*

**Note:** *This feature is not available in all drive modes.*

 The rear differential lock provides an indicator light in the information display when in use. While the feature is in standby mode, the light displays gray. While the feature is active, the light becomes colored.

# Four-Wheel Drive

---

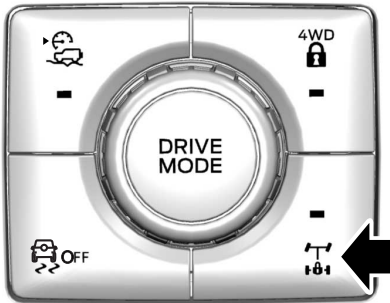

## Maintenance and Modifications

The suspension and steering systems on your vehicle have been designed and tested to provide predictable performance whether loaded or empty. For this reason, we strongly recommend that you do not make modifications such as adding or removing parts, for example, lift kits or stabilizer bars, or by using replacement parts not equivalent to the original factory equipment.

We recommend that you use caution when your vehicle has either a high-load or device, for example, a ladder or luggage racks. Any modifications to your vehicle that raise the center of gravity could cause your vehicle to roll over when there is a loss of vehicle control.

Failure to maintain your vehicle correctly could void the warranty, increase your repair cost, reduce vehicle performance and operational capabilities, and adversely affect you and your passenger's safety. We recommend you frequently inspect your vehicle's chassis components when your vehicle is subject to off-road usage.

# Brakes

## GENERAL INFORMATION

**Note:** Occasional brake noise is normal. If a metal-to-metal, continuous grinding or continuous squeal sound is present, the brake linings could be worn-out and have your vehicle checked. If the vehicle has continuous vibration or shudder in the steering wheel while braking, have your vehicle checked.

**Note:** Brake dust may accumulate on the wheels, even under normal driving conditions. Some dust is inevitable as the brakes wear and does not contribute to brake noise. Wet brakes result in reduced braking efficiency. Gently press the brake pedal a few times when driving from a car wash or standing water to dry the brakes.

See **Cleaning the Wheels** (page 294).

### Brake Over Accelerator

In the event the accelerator pedal becomes stuck or entrapped, apply steady and firm pressure to the brake pedal to slow the vehicle and reduce engine power. If you experience this condition, apply the brakes and bring your vehicle to a safe stop. Switch the engine off, move the transmission to park (P) and apply the parking brake. Inspect the accelerator pedal and the area around it for any items or debris that may be obstructing its movement. If none are found and the condition persists, have your vehicle towed to have your vehicle checked.

### Emergency Brake Assist

Emergency brake assist detects when you brake heavily by measuring the rate at which you press the brake pedal. It provides maximum braking efficiency as long as you press the pedal. Emergency brake assist can reduce stopping distances in critical situations.

## Anti-Lock Brake System

This system helps you maintain steering control during emergency stops by keeping the brakes from locking.



If the light does not momentarily illuminate, continues to flash or remains on when you switch the ignition on, the anti-lock brake system could be disabled. Have the system checked. If the anti-lock brake system is disabled, normal braking is still effective.

## Brake Lamps

See **Warning Lamps and Indicators** (page 95).



If the light does not momentarily illuminate, continues to flash or remains on when you switch the ignition on or apply the parking brake, have the system checked. If the brake warning lamp

illuminates with the parking brake released, have the system checked immediately.

**Note:** Indicators vary depending on region.

## HINTS ON DRIVING WITH ANTI-LOCK BRAKES

The anti-lock braking system does not eliminate the risks when:

- You drive too closely to the vehicle in front of you.
- Your vehicle is hydroplaning.
- You take corners too fast.
- The road surface is poor.

**Note:** If the system activates, the brake pedal may pulse and may travel further. Maintain pressure on the brake pedal. You may also hear a noise from the system. This is normal.

# Brakes

## ELECTRIC PARKING BRAKE



**WARNING:** Always fully apply the parking brake and make sure you shift into park (P). Failure to follow this instruction could result in personal injury or death.



**WARNING:** If you drive extended distances with the parking brake applied, you could cause damage to the brake system.



**WARNING:** The electric parking brake does not operate if the vehicle battery is running out of charge.

Your vehicle has an electric parking brake. You operate it with a switch instead of a lever. The switch is on the center console or to the left-hand side of the steering wheel, on the lower part of the instrument panel.

**Note:** *The electric parking brake makes noises during operation. This is normal.*

### Applying the Electric Parking Brake



Pull the switch upward.



The red warning lamp flashes during operation and illuminates when the parking brake is applied.



**Note:** *It remains illuminated for a short period of time after you switch the ignition off.*

If it continues to flash or does not illuminate, the system has malfunctioned. Have your vehicle checked as soon as possible.

**Note:** *You can apply the electric parking brake when the ignition is off.*

**Note:** *The electric parking brake could automatically apply when you shift into park (P). See **Transmission** (page 166).*

### Applying the Electric Parking Brake in an Emergency

**Note:** *Do not apply the electric parking brake when your vehicle is moving, except in an emergency. If you repeatedly use the electric parking brake to slow or stop your vehicle, you could cause damage to the brake system.*

You can use the electric parking brake to slow or stop your vehicle in an emergency.



Pull the switch upward and hold it.



The red warning lamp illuminates, a tone sounds and the stoplamps turn on.



The electric parking brake continues to slow your vehicle down unless you release the switch.

### Manually Releasing the Electric Parking Brake

Switch the ignition on.

Press and hold the brake pedal.



Push the switch downward.



The red warning lamp turns off.

# Brakes



If it remains illuminated or flashes, the system has malfunctioned. Have your vehicle checked as soon as possible.

## Pulling Away on a Hill When Towing a Trailer

Press and hold the brake pedal.



Pull the switch upward and hold it.

Shift into gear.

Press the accelerator pedal until engine has developed sufficient torque to prevent your vehicle from rolling down the hill.



Release the switch and pull away in a normal manner.

## Automatically Releasing the Electric Parking Brake

Close the driver door.

Shift into gear.

Press the accelerator pedal and pull away in a normal manner.



The red warning lamp turns off.



If it remains illuminated or flashes, the electric parking brake has not released. Manually release the parking brake.

## Releasing the Electric Parking Brake if the Vehicle Battery is Running Out of Charge

Connect a booster battery to the vehicle battery to release the electric parking brake if the vehicle battery is running out of charge. See **Jump Starting the Vehicle** (page 252).

## HILL START ASSIST



**WARNING:** The system does not replace the parking brake. When you leave your vehicle, always apply the parking brake.



**WARNING:** You must remain in your vehicle when the system turns on. At all times, you are responsible for controlling your vehicle, supervising the system and intervening, if required. Failure to take care may result in the loss of control of your vehicle, serious personal injury or death.



**WARNING:** The system will turn off if a malfunction is apparent or if you rev the engine excessively. Failure to take care may result in the loss of control of your vehicle, serious personal injury or death.

The system makes it easier to pull away when your vehicle is on a slope without the need to use the parking brake.

When the system is active, your vehicle remains stationary on the slope for two to three seconds after you release the brake pedal. This allows time to move your foot from the brake to the accelerator pedal. The system releases the brakes automatically once the engine has

# Brakes

developed sufficient torque to prevent your vehicle from rolling down the slope. This is an advantage when pulling away on a slope, for example from a car park ramp, traffic lights or when reversing uphill into a parking space.

The system activates on any slope that causes your vehicle to roll.

**Note:** *There is no warning light to indicate the system is either on or off.*

## Using Hill Start Assist

1. Press the brake pedal to bring your vehicle to a complete standstill. Keep the brake pedal pressed and shift into first gear when facing uphill or reverse (R) when facing downhill.
2. If the sensors detect that your vehicle is on a slope, the system activates automatically.
3. When you remove your foot from the brake pedal, your vehicle remains on the slope without rolling away for about two to three seconds. This hold time automatically extends if you are in the process of driving off.
4. Drive off in the normal manner. The system releases the brakes automatically.

**Note:** *When you remove your foot from the brake pedal and press the pedal again when the system is active, you will experience significantly reduced brake pedal travel. This is normal.*

## Switching the System On and Off

When you switch the ignition on, the system automatically turns on. You cannot turn the system on or off.

## AUTO HOLD

 **WARNING:** The system does not replace the parking brake. When you leave your vehicle, always apply the parking brake.

 **WARNING:** You must remain in your vehicle when the system turns on. At all times, you are responsible for controlling your vehicle, supervising the system and intervening, if required. Failure to take care may result in the loss of control of your vehicle, serious personal injury or death.

 **WARNING:** The system turns off if there is a malfunction or if you excessively rev the engine.

The system applies the brakes to hold your vehicle at a standstill after you stop your vehicle and release the brake pedal. This could be beneficial in certain situations, for example when waiting on a hill or in traffic.

## Switching Auto Hold On and Off



Press the button on your console to access auto hold on the touchscreen.

**Note:** *You can only switch the system on after you close the driver door, fasten your seatbelt and start the engine.*

**Note:** *The system remembers the last setting when you start your vehicle.*

# Brakes

Make sure you switch the system off before towing with your vehicle or before using an automatic car wash.

## Using Auto Hold

1. Use the brakes to bring your vehicle to a complete stop. The auto hold active indicator illuminates in the information display.
2. Release the brake pedal. The system holds your vehicle at a standstill. The auto hold active indicator remains illuminated in the information display.

**Note:** *The system only activates if you apply enough brake pressure. If your vehicle is on a steep slope, you need to press the brake pedal harder before the system activates.*

**Note:** *Under certain conditions, the system could apply the electric parking brake. The brake system warning lamp illuminates. The electric parking brake releases when you press the accelerator pedal. See **Electric Parking Brake** (page 177).*

**Note:** *If auto-start-stop turns off the engine, auto hold remains active.*

**Note:** *The system deactivates if you shift into reverse (R) and press the brake pedal.*

3. Pull away in the normal manner. The system releases the brakes and the auto hold active indicator turns off.

## Auto Hold Indicator



The auto hold indicator illuminates in the information display when the system is on and is either active or unavailable.



Illuminates when the system is active. Your vehicle remains stationary after you release the brake pedal.

Illuminates when the system is on but unavailable to hold your vehicle at a standstill.

The system could be unavailable when any of the following occur:

- During an active park assist maneuver.
- Your vehicle is in stay in neutral mode.
- The driver door is open.
- You do not fasten your seatbelt.
- You shift into reverse (R) before the system is active.

# Traction Control

## PRINCIPLE OF OPERATION

The traction control system helps avoid drive wheel spin and loss of traction.

If your vehicle begins to slide, the system applies the brakes to individual wheels and, when needed, reduces engine power at the same time. If the wheels spin when accelerating on slippery or loose surfaces, the system reduces engine power in order to increase traction.

## USING TRACTION CONTROL



**WARNING:** The stability and traction control light illuminates steadily if the system detects a failure. Make sure you did not manually disable the traction control system using the information display controls or the switch. If the stability control and traction control light is still illuminating steadily, have the system serviced by an authorized dealer immediately. Operating your vehicle with the traction control disabled could lead to an increased risk of loss of vehicle control, vehicle rollover, personal injury and death.

The system automatically turns on each time you switch the ignition on.

If your vehicle is stuck in mud or snow, switching traction control off may be beneficial as this allows the wheels to spin.

**Note:** *When you switch traction control off, stability control remains fully active.*

## Switching the System Off

When you switch the system off or on, a message appears in the information display showing system status.

You can switch the system off by either using the information display controls or the switch.

## Using the Information Display Controls

You can switch this feature off or on in the information display. See **General Information** (page 99).

## Using a Switch (If Equipped)

Using the traction control switch on the center console to turn this feature off or on.

## System Indicator Lights and Messages



The stability and traction control light:

- Temporarily illuminates on engine start-up.
- Flashes when a driving condition activates either of the systems.
- Illuminates if a problem occurs in either of the systems.



The stability and traction control off light temporarily illuminates on engine start-up and stays on when you switch the traction control system off.



# Stability Control

## PRINCIPLE OF OPERATION



**WARNING:** Vehicle modifications involving braking system, aftermarket roof racks, suspension, steering system, tire construction and wheel and tire size may change the handling characteristics of your vehicle and may adversely affect the performance of the electronic stability control system. In addition, installing any stereo loudspeakers may interfere with and adversely affect the electronic stability control system. Install any aftermarket stereo loudspeaker as far as possible from the front center console, the tunnel, and the front seats in order to minimize the risk of interfering with the electronic stability control sensors. Reducing the effectiveness of the electronic stability control system could lead to an increased risk of loss of vehicle control, vehicle rollover, personal injury and death.



**WARNING:** Remember that even advanced technology cannot defy the laws of physics. It's always possible to lose control of a vehicle due to inappropriate driver input for the conditions. Aggressive driving on any road condition can cause you to lose control of your vehicle increasing the risk of personal injury or property damage. Activation of the electronic stability control system is an indication that at least some of the tires have exceeded their ability to grip the road; this could reduce the operator's ability to control the vehicle potentially resulting in a loss of vehicle control, vehicle rollover, personal injury and death. If your electronic stability control system activates, SLOW DOWN.

The system automatically turns on each time you switch the ignition on.

If a fault occurs in either the stability control or the traction control system, you may experience the following conditions:

- The stability and traction control light illuminates steadily.
- The stability control and traction control systems do not enhance your vehicle's ability to maintain traction of the wheels.

If a driving condition activates either the stability control or the traction control system you may experience the following conditions:

- The stability and traction control light flashes.
- Your vehicle slows down.
- Reduced engine power.
- A vibration in the brake pedal.
- The brake pedal is stiffer than usual.
- If the driving condition is severe and your foot is not on the brake, the brake pedal may move as the system applies higher brake force.

The stability control system has several features built into it to help you maintain control of your vehicle:

### Electronic Stability Control

The system enhances your vehicle's ability to prevent skids or lateral slides by applying brakes to one or more of the wheels individually and, if necessary, reducing engine power.

### Roll Stability Control

The system enhances your vehicle's ability to prevent rollovers by detecting your vehicle's roll motion and the rate at which it changes by applying the brakes to one or more wheels individually.

# Stability Control

## Traction Control

The system enhances your vehicle's ability to maintain traction of the wheels by detecting and controlling wheel spin. See **Using Traction Control** (page 181).

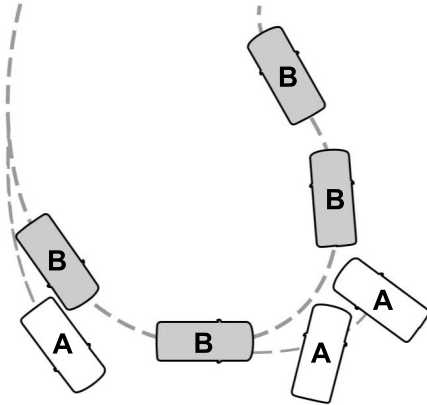

- A Vehicle without stability control skidding off its intended route.
- B Vehicle with stability control maintaining control on a slippery surface.

## USING STABILITY CONTROL

The system automatically turns on each time you switch the ignition on.

You cannot switch the stability control and roll stability control systems off, but when you shift into reverse (R), the systems deactivate.

You can switch the traction control system off or on. See **Using Traction Control** (page 181).

## Trail Control (If Equipped)

### WHAT IS TRAIL CONTROL



**WARNING:** The system does not control speed in low traction conditions or extremely steep slopes. The system is designed to be an aid and does not relieve you of your responsibility to drive with due care and attention. Failure to follow this instruction could result in personal injury.



**WARNING:** The system does not replace the parking brake. When you leave your vehicle, always apply the parking brake and shift the transmission into park (P) for automatic transmission or first gear for manual transmission.

Trail control lets you focus on steering during low-speed and off-road use by controlling your vehicle's acceleration and braking.

You can use trail control under the following speeds:

- 20 mph (32 km/h) in four-wheel drive or four-wheel drive lock.
- 5 mph (8 km/h) in reverse (R).

You may hear a noise from the anti-lock brake system pump motor when you use the system. This is normal.

### SWITCHING TRAIL CONTROL ON AND OFF



Press the button on the console.

The system switches off if you press the button again or exceed 42 mph (68 km/h).

### SETTING THE TRAIL CONTROL SPEED



**Note:** The indicator changes color.

Drive to your preferred speed.

**SET+**

Press the button to increase the set current speed.

**SET-**

Press the button to decrease the set current speed.

**Note:** The indicator changes color.

You can adjust the set speed in small or large increments. Press the toggle button upward or downward once to adjust the set speed in small increments. Press and hold the toggle button upward or downward to adjust the set speed in large increments.

You can also adjust the set speed by braking.

**Note:** Pressing the brake pedal does not switch off the system.

## Trail Control (If Equipped)

### CANCELING THE SET SPEED



Press the button.

### TRAIL CONTROL INDICATORS



## TRAIL CONTROL – TROUBLESHOOTING

### Trail Control – Information Messages

Message	Action
Reduce Speed To Enter Trail Control	You need to reduce your vehicle speed to use trail control.
Trail Control Not Available with Park Brake Applied	You need to release the park brake to use trail control.
Trail Control Not Available While Pro Trailer Backup Assist™ Active	You need to switch off the trailer backup assist to use trail control.
Trail Control Enabled Use SET Button to Set Speed	You successfully enabled trail control and can set a speed with the <b>Set +</b> or <b>SET-</b> control.
Trail Control Off Driver Resume Control	The system turns trail control off due to a system fault. You must resume control.
Trail Control Off	Displays when the system has turned off.
Trail Control Fault See Manual	Displays when a system fault is present. See the trail control section in your owner's manual.
Trail Control To Activate Select Gear	You need to select drive (D), neutral (N), or reverse (R) to use trail control.
Trail Control Not Available with Cruise Control Active	You need to switch cruise control off to use trail control.
Trail Control Not Available with Driver Door Open	You need to close the driver door to use trail control.
Descent Control Now Active Press Trail Control Switch To Exit	Due to some action from you, the system turned the trail control propulsion system off. The vehicle will still brake if descending a hill. You need to press trail control to switch it back on.

# Parking Aids

## PRINCIPLE OF OPERATION

 **WARNING:** To help avoid personal injury, always use caution when in reverse (R) and when using the sensing system.

 **WARNING:** The system may not detect objects with surfaces that absorb reflection. Always drive with due care and attention. Failure to take care may result in a crash.

 **WARNING:** Traffic control systems, inclement weather, air brakes, external motors and fans may affect the correct operation of the sensing system. This may cause reduced performance or false alerts.

 **WARNING:** The system may not detect small or moving objects, particularly those close to the ground.

 **WARNING:** If damage occurs in the immediate area surrounding the sensor, have your vehicle checked as soon as possible.

 **WARNING:** The parking aid system can only assist you to detect objects when your vehicle is moving at parking speeds. To help avoid personal injury you must take care when using the parking aid system.

 **WARNING:** In cold and severe weather conditions the system may not function. Rain, snow and spray can all limit sensor performance.

 **WARNING:** The system may not function if the sensor is blocked.

**Note:** If your vehicle has MyKey™, the sensing system cannot be switched off when a MyKey™ is present. See **Principle of Operation** (page 59).

**Note:** Do not clean the sensors with sharp objects.

**Note:** If your vehicle sustains damage to the bumper or fascia and you leave it misaligned or bent, the sensing zone may be altered causing inaccurate measurement of obstacles or false alerts.

**Note:** Certain add-on devices installed around the bumper or fascia may create false alerts. For example, large trailer hitches, bike or surfboard racks, license plate brackets, bumper covers or any other device that may block the normal detection zone of the system. Remove the add-on device to prevent false alerts.

**Note:** When you connect a trailer to your vehicle, the rear parking aid may detect the trailer and therefore provide an alert. Disable the rear parking aid when you connect a trailer to prevent the alert.

The sensing system warns you of obstacles within a certain range of your vehicle. The system turns on when you switch the ignition on.

You can switch the system off through the information display menu or from the pop-up message that appears once you shift the transmission into reverse (R). See

**General Information** (page 99). If your vehicle has a parking aid button, you can switch the system off by pressing the button. The system turns on when you switch the ignition on.

If a fault is present in the system, a warning message appears in the information display. See **Information Messages** (page 104).

# Parking Aids

## REAR PARKING AID (IF EQUIPPED)



**WARNING:** The system may not detect objects with surfaces that absorb reflection. Always drive with due care and attention. Failure to take care may result in a crash.



**WARNING:** The system may not detect small or moving objects, particularly those close to the ground.



**WARNING:** To help avoid personal injury, always use caution when in reverse (R) and when using the sensing system.



**WARNING:** The parking aid system can only assist you to detect objects when your vehicle is moving at parking speeds. To help avoid personal injury you must take care when using the parking aid system.

The sensors are on the rear bumper.

The sensors are active when the transmission is in reverse (R) and the vehicle speed is less than 3 mph (5 km/h). When the parking aid system sounds a tone, the audio system may reduce the set volume.

**Note:** Keep the sensors free from snow, ice and large accumulations of dirt.

**Note:** Do not cover up the sensors.

**Note:** Do not clean the sensors with sharp objects.

**Note:** If your vehicle sustains damage leaving the sensors misaligned, this could cause inaccurate measurements or false alerts.

**Note:** Some accessories, for example, large trailer hitches or bike or surfboard racks can cause reduced performance or false alerts.

A warning tone sounds when your vehicle approaches an object. As your vehicle moves closer to an object, the rate of the tone increases. The warning tone continuously sounds when an object is 12 in (30 cm) or less from the center of the rear bumper.

**Note:** There is a decreased coverage area at the outer corners.



The sensor coverage area is up to 70 in (180 cm) from the rear bumper.

If the system detects a fault, a warning message appears in the information display.

The system detects large objects when you shift into reverse (R) and any of the following occur:

- Your vehicle is moving backward at low speed.
- Your vehicle is stationary but an object is approaching the rear of your vehicle at low speed.
- Your vehicle is moving backward at low speed and an object is moving toward your vehicle, for example, another vehicle at low speed.

# Parking Aids

If your vehicle remains stationary for two seconds the audible warning turns off. If your vehicle moves backward the tone sounds again.

**Note:** *If the detected object is 12 in (30 cm) or less from the rear bumper, the audible warning does not turn off.*

## Object Distance Indicator (If Equipped)

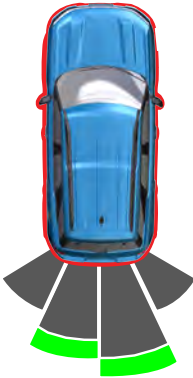

The system provides object distance indication through the information display.

- As the distance to the object decreases, the indicator blocks illuminate and move toward the vehicle icon.
- If the system does not detect an object, the distance indicator blocks are gray.

When you shift into reverse (R), the system provides audible warnings and visual indication when your vehicle is moving and the detected object is moving toward your vehicle. When you stop your vehicle, the audible warnings stop after two seconds. Visual indication remains on when the transmission is in reverse (R).

## REAR VIEW CAMERA

**WARNING:** The rear view camera system is a reverse aid supplement device that still requires the driver to use it in conjunction with the interior and exterior mirrors for maximum coverage.

**WARNING:** Objects that are close to either corner of the bumper or under the bumper, might not be seen on the screen due to the limited coverage of the camera system.

**WARNING:** Use caution when the rear cargo door is ajar. If the rear cargo door is ajar, the camera will be out of position and the video image could be incorrect. All guide lines disappear when the rear cargo door is ajar. Failure to follow this instruction could result in personal injury.

**WARNING:** Use caution when turning camera features on or off when the transmission is not in park (P). Make sure your vehicle is not moving.

**WARNING:** Reverse your vehicle slowly. Failure to follow this instruction could result in the loss of control of your vehicle, personal injury or death.

The rear view camera system provides a video image of the area behind your vehicle.

During operation, lines appear in the display which represent your vehicle's path and proximity to objects behind your vehicle.

# Parking Aids



The camera is on the liftgate.

## Using the Rear View Camera System

The rear view camera system displays what is behind your vehicle when you place the transmission in reverse (R).

**Note:** *The reverse sensing system is not effective at speeds above 6 mph (10 km/h) and may not detect certain angular or moving objects.*

The system uses three types of guides to help you see what is behind your vehicle:

- Active guidelines: Show the intended path of your vehicle when reversing.
- Fixed guidelines: Show the actual path your vehicle is moving in while reversing in a straight line. This can be helpful when backing into a parking space or aligning your vehicle with another object behind you.
- Centerline: Helps align the center of your vehicle with an object, for example, a trailer.

**Note:** *If the transmission is in reverse (R) and the luggage compartment door or liftgate is open, no rear view camera features will display.*

**Note:** *When towing, the camera only sees what you are towing. This might not provide adequate coverage as it usually provides in normal operation and some objects might not be seen. In some vehicles, the guidelines may disappear when you connect the trailer tow connector.*

The camera may not operate correctly under the following conditions:

- Nighttime or dark areas if one or both reverse lamps are not operating.
- Mud, water or debris obstructs the camera's view. Clean the lens with a soft, lint-free cloth and non-abrasive cleaner.
- The rear of your vehicle is hit or damaged, causing the camera to become misaligned.



# Parking Aids

## Camera Guidelines

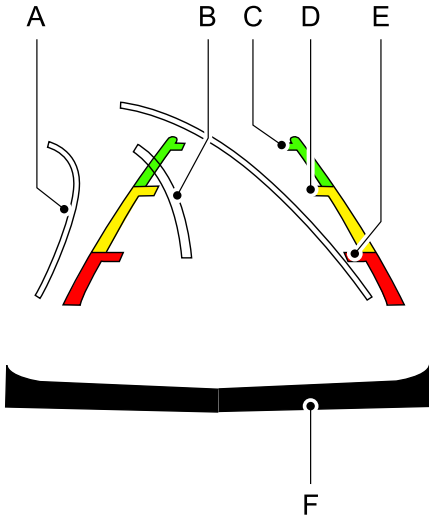

- A Active guidelines.
- B Centerline.
- C Fixed guideline: Green zone.
- D Fixed guideline: Yellow zone.
- E Fixed guideline: Red zone.
- F Rear bumper.

Active guidelines are only shown with fixed guidelines. To use active guidelines, turn the steering wheel to point the guidelines toward an intended path. If you change the steering wheel position while reversing, your vehicle might deviate from the original intended path.

The fixed and active guidelines fade in and out depending on the steering wheel position. The active guidelines do not display when the steering wheel position is straight.

Always use caution while reversing. Objects in the red zone are closest to your vehicle and objects in the green zone are farther away. Objects are getting closer to your vehicle as they move from the green zone to the yellow or red zones. Use the side view mirrors and rear view mirror to get better coverage on both sides and rear of your vehicle.

**Note:** Active guidelines are only available when the transmission is in reverse (R).

**Note:** Upon a battery disconnect, the active guidelines may not be functional until your vehicle has been driven a short distance and exceeds a speed of 12 mph (20 km/h).

## Manual Zoom



**WARNING:** When manual zoom is on, the full area behind your vehicle may not show. Be aware of your surroundings when using the manual zoom feature.

Selectable settings for this feature are zoom in (+) and zoom out (-). Press the symbol in the camera screen to change the view. The default setting is with the zoom off.

This allows you to get a closer view of an object behind your vehicle. The zoomed image keeps the bumper in the image to provide a reference. The zoom is only active while the transmission is in reverse (R).

**Note:** Manual zoom is only available when the transmission is in reverse (R).

**Note:** When you enable manual zoom, only the centerline is shown.

# Parking Aids

## Camera System Settings

The rear view camera system settings can be accessed through the display screen. See **General Information** (page 99).

## Obstacle Distance Indicator

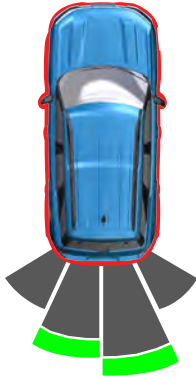

The system uses red, yellow and green highlights that appear on top of the video image when any of the sensing systems detect an object.

## Rear Camera Delay

Selectable settings for this feature are on and off.

The default setting for the rear camera delay is off.

When shifting the transmission out of reverse (R) and into any gear other than park (P) while the delay mode is on, the camera image remains in the display until:

- Your vehicle speed sufficiently increases.
- You shift your vehicle into park (P) on vehicles with automatic transmission.
- You enable the hand brake on vehicles with manual transmission.

## 180 DEGREE CAMERA (IF EQUIPPED)

 **WARNING:** The front camera system still requires the driver to use it in conjunction with looking out of your vehicle.

 **WARNING:** Objects that are close to either corner of the bumper or under the bumper, might not be seen on the screen due to the limited coverage of the camera system.

 **WARNING:** Use caution when turning camera features on or off when the transmission is not in park (P). Make sure your vehicle is not moving.



# Parking Aids

The front view camera is located in the grille. The camera provides a video image of the area in front of your vehicle.

**Note:** The area displayed on the screen may vary according to your vehicle's orientation or road condition.

**Note:** The front view camera switches off if your vehicle speed exceeds 6 mph (10 km/h). You have to switch the system back on by using the camera system button once below the speed threshold.

**Note:** The front camera system will switch on when you are in mud/ruts, rock crawl or sand mode and your speed is less than 15 mph (24 km/h). If you exceed 15 mph (24 km/h) the camera shuts off until your vehicle speed is below 12 mph (20 km/h).

## Using the System

The 180 degree camera system consists of front and rear cameras. The system:

- Allows you to see what is directly in front or behind your vehicle.
- Provides cross traffic view in front and behind your vehicle.
- Provides visibility during parking maneuvers.

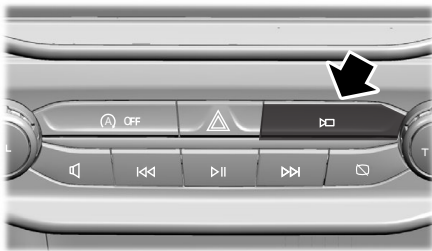

The camera system button is located on the audio unit and allows you to enable and disable front camera.

**Note:** The camera system may not operate correctly if mud, water or debris obstructs the camera's view. You can clean the lens with a soft, lint-free cloth and non-abrasive cleaner or by using your front or rear washer. See **Wipers and Washers** (page 77).

## Camera Views

Press the camera icon on the touchscreen to toggle between different views.

- **Normal Rear View:** Provides an image of what is directly behind your vehicle when your vehicle is in reverse (R).
- **Expanded Rear View:** Provides an expanded 180 degree image of what is directly behind your vehicle when your vehicle is in reverse (R).
- **Normal Front View:** Provides an image of what is directly in front your vehicle when your vehicle is in park (P), neutral (N) or drive (D).
- **Expanded Front View:** Provides an expanded 180 degree image of what is directly in front your vehicle when your vehicle is in park (P), neutral (N) or drive (D).

# Cruise Control

## WHAT IS CRUISE CONTROL

Cruise control lets you maintain a set speed without keeping your foot on the accelerator pedal.

### Requirements

Use cruise control when the vehicle speed is greater than 20 mph (30 km/h).

## SWITCHING CRUISE CONTROL ON AND OFF



**WARNING:** Do not use cruise control on winding roads, in heavy traffic or when the road surface is slippery. This could result in loss of vehicle control, serious injury or death.

The cruise controls are on the steering wheel.

### Switching Cruise Control On



Press the button to put the system in standby mode.

### Switching Cruise Control Off



Press the button when in standby mode or switch the ignition off.

**Note:** When you switch cruise control off the set speed clears.

## SETTING THE CRUISE CONTROL SPEED



**WARNING:** When you are going downhill, your vehicle speed could increase above the set speed. The system does not apply the brakes.

Drive to the speed you prefer.

**SET+**

Press the toggle button upward or downward to set the current speed.

**SET-**

Take your foot off the accelerator pedal.

**Note:** The indicator changes color in the information display.

## Changing the Set Speed

**SET+**

Press and release the toggle button upward to increase the set speed in small increments.

Press and hold the toggle button upward to accelerate. Release the button when you have reached your preferred speed.

**SET-**

Press and release the toggle button downward to decrease the set speed in small increments.

Press and hold the toggle button downward to decelerate. Release the button when you have reached your preferred speed.

**Note:** If you accelerate by pressing the accelerator pedal, the set speed does not change. When you release the accelerator pedal, your vehicle returns to the speed that you previously set.

# Cruise Control

---

## CANCELING THE SET SPEED



Press the button, or tap the brake pedal to cancel the set speed.

**Note:** *The system remembers the set speed.*

**Note:** *The system cancels if the vehicle speed drops below 10 mph (16 km/h) under the set speed when driving uphill.*

## RESUMING THE SET SPEED



Press the button.

## CRUISE CONTROL INDICATORS



Illuminates when you switch the system on.

# Adaptive Cruise Control (If Equipped)

## HOW DOES ADAPTIVE CRUISE CONTROL WITH STOP AND GO WORK

Adaptive cruise control with stop and go uses radar and camera sensors to adjust the speed of your vehicle to maintain a set gap from the vehicle in front of you in the same lane while following it to a complete stop. You can also engage the system to follow a vehicle in front of you and adjust set speed while stopped.

## WHAT IS ADAPTIVE CRUISE CONTROL WITH LANE CENTERING

Adaptive cruise control with lane centering uses radar and camera sensors to help keep your vehicle in the lane by applying continuous assistance steering torque input toward the lane center on highways.

**Note:** *The adaptive cruise control gap setting operates normally.*

## WHAT IS INTELLIGENT ADAPTIVE CRUISE CONTROL

(IF EQUIPPED)

Intelligent adaptive cruise control combines speed sign recognition with adaptive cruise control to adjust the cruise set speed to the speed limit detected by the speed sign recognition system. For example, if the speed sign recognition system detects a 50 mph (80 km/h) speed limit, the cruise set speed is updated to 50 mph (80 km/h).

**Note:** *The adaptive cruise control gap setting operates normally.*

## ADAPTIVE CRUISE CONTROL PRECAUTIONS



**WARNING:** You are responsible for controlling your vehicle at all times. The system is designed to be an aid and does not relieve you of your responsibility to drive with due care and attention. Failure to follow this instruction could result in the loss of control of your vehicle, personal injury or death.



**WARNING:** Pay close attention to changing road conditions such as entering or leaving a highway, on roads with intersections or roundabouts, roads without visible lanes of travel, roads that are winding, slippery, unpaved, or steep slopes.



**WARNING:** The system does not control speed in low traction conditions or extremely steep slopes. The system is designed to be an aid and does not relieve you of your responsibility to drive with due care and attention. Failure to follow this instruction could result in personal injury.



**WARNING:** The system is not a crash warning or avoidance system.





**WARNING:** Do not use the system when towing a trailer that has aftermarket electronic trailer brake controls. Failure to follow this instruction could result in the loss of control of your vehicle, personal injury or death.



**WARNING:** Do not use tire sizes other than those recommended because this can affect the normal operation of the system. Failure to do so may result in a loss of vehicle control, which could result in serious injury.

# Adaptive Cruise Control (If Equipped)

 **WARNING:** Do not use the system with a snow plow blade installed.

 **WARNING:** Do not use the system in poor visibility, for example fog, heavy rain, spray or snow.

## When Following a Vehicle

 **WARNING:** When following a vehicle that is braking, your vehicle does not always decelerate quickly enough to avoid a crash without driver intervention. Apply the brakes when necessary. Failure to follow this instruction could result in personal injury or death.

## Hilly Condition Usage

You should select a lower gear when the system is active in situations such as prolonged downhill driving on steep grades, for example in mountainous areas. The system needs additional engine braking in these situations to reduce the load on the vehicle's regular brake system to prevent it from overheating.

**Note:** *An audible alarm sounds and the system shuts down if it applies brakes for an extended period of time. This allows the brakes to cool. The system functions normally again after the brakes cool.*

## Lane Centering Precautions

Adaptive cruise control precautions apply to lane centering unless stated otherwise or contradicted by a lane centering precaution.

 **WARNING:** Do not use the system when towing a trailer. Failure to follow this instruction could result in the loss of control of your vehicle, personal injury or death.

 **WARNING:** Do not use the system if any changes or modifications to the steering wheel have been made. Any changes or modifications to the steering wheel could affect the functionality or performance of the system. Failure to follow this instruction could result in the loss of control of your vehicle, personal injury or death.

## ADAPTIVE CRUISE CONTROL LIMITATIONS

### Sensor Limitations

 **WARNING:** On rare occasions, detection issues can occur due to the road infrastructures, for example bridges, tunnels and safety barriers. In these cases, the system may brake late or unexpectedly. At all times, you are responsible for controlling your vehicle, supervising the system and intervening, if required.

 **WARNING:** If the system malfunctions, have your vehicle checked as soon as possible.

 **WARNING:** Large contrasts in outside lighting can limit sensor performance.

## Adaptive Cruise Control (If Equipped)

 **WARNING:** The system only warns of vehicles detected by the radar and camera sensors. In some cases there may be no warning or a delayed warning. Apply the brakes when necessary. Failure to follow this instruction could result in personal injury or death.

 **WARNING:** The system may not detect stationary or slow moving vehicles below 6 mph (10 km/h).

 **WARNING:** The system does not detect pedestrians or objects in the road.

 **WARNING:** The system does not detect oncoming vehicles in the same lane.

 **WARNING:** The system may not operate properly if the sensor is blocked. Keep the windshield free from obstruction.

 **WARNING:** The sensor may incorrectly track lane markings as other structures or objects. This can result in a false or missed warning.

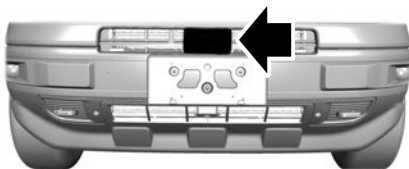

The radar sensor is in the lower grille.

**Note:** You cannot see the sensor. It is behind a fascia panel.

**Note:** Keep the front of your vehicle free of dirt, metal badges or objects. Vehicle front protectors, aftermarket lights, additional paint or plastic coatings could also degrade sensor performance.

A message displays if something obstructs the camera or the sensor. When something blocks the sensor, the system cannot detect a vehicle ahead and does not function. See **Adaptive Cruise Control – Information Messages** (page 204).

The radar sensor has a limited field of view. It may not detect vehicles at all or detect a vehicle later than expected in some situations. The lead vehicle image does not illuminate if the system does not detect a vehicle in front of you.



The camera is mounted on the windshield behind the interior mirror.



# Adaptive Cruise Control (If Equipped)

## Detection issues can occur:

A

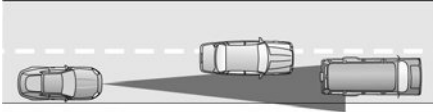

B



C

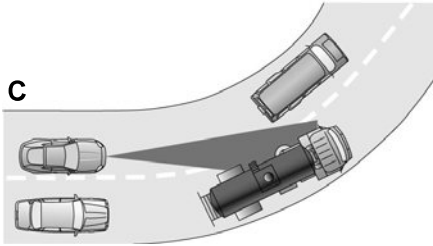

- A When driving on a different line than the vehicle in front.
- B With vehicles that edge into your lane. The system can only detect these vehicles once they move fully into your lane.
- C There may be issues with the detection of vehicles in front when driving into and coming out of a bend or curve in the road.

In these cases, the system may brake late or unexpectedly.

If something hits the front end of your vehicle or damage occurs, the radar-sensing zone could change. This could result in a missed or false vehicle detection.

Optimal system performance requires a clear view of the road by the windshield-mounted camera.

Optimal performance may not occur if:

- The camera is blocked.
- There is poor visibility or lighting conditions.
- There are bad weather conditions.

## Lane Centering Limitations

Adaptive cruise control limitations apply to lane centering unless stated otherwise or contradicted by a lane centering limitation.

Lane Centering may not correctly operate in any of the following conditions:

- Your vehicle is not centered in the lane.
- The lane is too narrow or wide.
- The system does not detect at least one lane marking or when lanes merge or split.
- You switch the direction indicator on.
- Limited steering torque input is applied.
- Areas under construction or new infrastructure.
- When modifications to the steering system have been made.
- When using a spare tire.

**Note:** *The assistance steering torque is limited and may not be sufficient for all driving situations such as driving through tight curves or driving through curves at high speeds.*

**Note:** *In exceptional conditions, the system may deviate from the center line.*

## SWITCHING ADAPTIVE CRUISE CONTROL ON AND OFF

The cruise controls are on the steering wheel. See **Cruise Control** (page 75).

# Adaptive Cruise Control (If Equipped)

## Switching Adaptive Cruise Control On



Press the button to set the system in standby mode.

The indicator, current gap setting and set speed appear in the information display.

## Switching Adaptive Cruise Control Off



Press the button when the system is in standby mode, or switch the ignition off.

**Note:** You erase the set speed when you switch the system off.

## Automatic Cancellation or Deactivation

The system may cancel if:

- The tires lose traction.
- You apply the parking brake.

The system may cancel and set the parking brake if:

- You unbuckle the seatbelt and open the driver door after you stop your vehicle.
- Your vehicle is at a stop continuously for more than three minutes.

The system may deactivate or prevent activating when requested if:

- The vehicle has a blocked sensor.
- The brake temperature is too high.
- There is a failure in the system or a related system.

## SETTING THE ADAPTIVE CRUISE CONTROL SPEED

Drive to the speed you prefer.

SET+

Press the toggle button upward or downward to set the current speed.

SET-

Take your foot off the accelerator pedal.

The indicator, current gap setting and set speed appear in the information display.



A vehicle image illuminates if there is a vehicle detected in front of you.

**Note:** When adaptive cruise control is active, the speedometer may vary slightly from the set speed displayed in the information display.

## Setting the Adaptive Cruise Speed from a Complete Stop

SET+

Press the toggle button upward or downward while keeping the brake pedal fully pressed.

SET-

The set speed adjusts to 20 mph (30 km/h).

The indicator, current gap setting and set speed appear in the information display.

## Manually Changing the Set Speed

SET+

Press and release the toggle button upward to increase the set speed in small increments.

# Adaptive Cruise Control (If Equipped)

Press and hold the toggle button upward to increase the set speed in large increments. Release the button when you reach the speed you prefer.

**SET-** Press and release the toggle button downward to decrease the set speed in small increments.

Press and hold the toggle button downward to decrease the set speed in large increments. Release the button when you reach the speed you prefer.

You can also press the accelerator or brake pedal until you reach the speed you prefer. Press the toggle button upward or downward to select the current speed as the set speed.

The system may apply the brakes to slow the vehicle to the new set speed. The set speed continuously displays in the information display when the system is active.

## SETTING THE ADAPTIVE CRUISE CONTROL GAP



Press the button to cycle through the four gap settings.



The selected gap appears in the instrument cluster display as shown by the bars in the image.

**Note:** *The gap setting is time dependent and therefore, the distance adjusts with your vehicle speed.*

**Note:** *It is your responsibility to select a gap appropriate to the driving conditions.*

## Adaptive Cruise Control Gap Settings

Graphic Display, Bars Indicated Between Vehicles	Gap Distance	Dynamic Behavior
1	Closest.	Sport.
2	Close.	Normal.
3	Medium.	Normal.
4	Far.	Comfort.

Each time you switch the system on, it selects the last chosen gap setting.

## Following a Vehicle

When a vehicle ahead of you enters the same lane or a slower vehicle is ahead in the same lane, the vehicle speed adjusts to maintain the gap setting.

**Note:** *When you are following a vehicle and you switch on a turn signal lamp, adaptive cruise control may provide a small, temporary acceleration to help you pass.*

Your vehicle maintains a consistent gap from the vehicle ahead until:

- The vehicle in front of you accelerates to a speed above the set speed.
- The vehicle in front of you moves out of the lane you are in.
- You set a new gap distance.

The system applies the brakes to slow down your vehicle to maintain a safe gap distance from the vehicle in front of you. The system only applies limited braking. You can override the system by applying the brakes.

# Adaptive Cruise Control (If Equipped)

**Note:** The brakes may emit noise when applied by the system.

If the system determines that its maximum braking level is not sufficient, an audible warning sounds, a message appears in the instrument cluster display and an indicator flashes when the system continues to brake. Take immediate action.

## CANCELING THE SET SPEED



Press the button or tap the brake pedal.

The set speed does not erase.

## RESUMING THE SET SPEED



Press the button.

Your vehicle speed returns to the previously set speed and gap setting. The set speed displays continuously in the information display when the system is active.

**Note:** Only use resume if you are aware of the set speed and intend to return to it.

## Resuming the Set Speed from a Complete Stop

If your vehicle follows a vehicle to a complete stop and remains stationary for less than three seconds, your vehicle accelerates from a stationary position to follow the vehicle ahead.



If your vehicle follows a vehicle to a complete stop and remains stationary for more than three seconds, press and release the button or press the accelerator pedal to follow the vehicle ahead.

## OVERRIDING THE SET SPEED

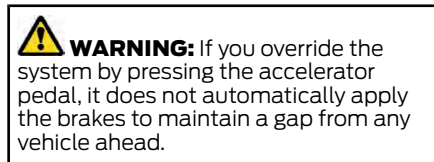

When you press the accelerator pedal, you override the set speed and gap distance.

Use the accelerator pedal to intentionally exceed the set speed limit.

When you override the system, the green indicator illuminates and the vehicle icon does not appear in the instrument cluster display.

The system resumes operation when you release the accelerator pedal. The vehicle speed decreases to the set speed, or a lower speed if following a slower vehicle.

## ADAPTIVE CRUISE CONTROL INDICATORS



Illuminates when you switch the system on. The color of the indicator changes to indicate the system status.

White indicates the system is on but inactive.

Green indicates the system is active and the speed has been set.

## Lane Centering Indicators



Illuminates when you switch lane centering on. The color of the indicator changes to indicate the system status.

Gray indicates the system is on but inactive.

## Adaptive Cruise Control (If Equipped)

Green indicates the system is active and applying assistance steering torque input to keep your vehicle in the center of the lane.

Amber indicates a system auto-cancellation.

### Intelligent Adaptive Cruise Control Indicators (If Equipped)



A bracket appears around the set speed and the detected speed limit sign in the information display.

### System Warnings

If the set speed is increased beyond the speed limit or speed limit plus a positive tolerance value, the set speed indicator flashes.

The warning does not occur if:

- You override the set speed using the accelerator pedal.
- The vehicle speed exceeds the set speed due to being on a downhill slope.

## SWITCHING FROM ADAPTIVE CRUISE CONTROL TO CRUISE CONTROL



**WARNING:** Normal cruise control will not brake when your vehicle is approaching slower vehicles. Always be aware of which mode you have selected and apply the brakes when necessary.

Use the touchscreen to select the following:

1. Select **Settings**.
2. Select **Driver Assist..**
3. Select **Cruise Control**.
4. Select **Normal**.



The cruise control indicator replaces the adaptive cruise control indicator if you select normal cruise control. The gap setting does not display, and the system does not respond to lead vehicles. Automatic braking remains active to maintain set speed. The system remembers the last setting when you start your vehicle.

## SWITCHING LANE CENTERING ON AND OFF

The controls are on the steering wheel. See **Cruise Control** (page 75).



Press the button.

The indicator appears in the information display. When the system is on, the color of the indicator changes to indicate the system status. See **Adaptive Cruise Control Indicators** (page 201).

**Note:** *Adaptive cruise control must be on before you can switch lane centering on.*

# Adaptive Cruise Control (If Equipped)

## Activating Lane Centering

The system only activates when all of the following occur:

- You have adaptive cruise control with stop-and-go on.
- Your hands are on the steering wheel.
- The system detects both lane markings.

**Note:** *If it does not detect valid lane markings, the system stays inactive until valid markings are available.*

You can override the system at any time by steering your vehicle.

If you drive off-center within the lane, the system sets and maintains that preferred lane position. The system provides continuous assistance steering torque input toward the preferred position.

**Note:** *The system can only set preferred lane positions within the lane.*

**Note:** *If the system cancels, the preferred position erases. On the next activation, the system provides continuous assistance steering torque input toward the lane center.*

## System Alerts and Automatic Cancellation

You must keep your hands on the steering wheel at all times.

When the system is active and detects no steering activity for a certain period of time, the system alerts you to put your hands on the steering wheel. If you do not react to the warnings the system cancels and slows your vehicle down to idle speeds while maintaining steering control.

The system also alerts you if your vehicle crosses lane markings without detected steering activity.

**Note:** *The system may detect a light grip or touch on the steering wheel as hands-off driving.*

When an external condition cancels the system, for example, no lane markings available, a tone sounds and a message appears in the information display.

**RES** If your vehicle starts to slow down, you must contribute to the steering control and press and release the button to regain full system performance.

Automatic cancellation can also occur if:

- The lane becomes too wide or too narrow.
- The system cannot detect valid lane markings.
- Lane markings are crossed.

**Note:** *The system disables until the next key cycle if your vehicle slows down due to driver inactivity twice within a key cycle.*

## SWITCHING INTELLIGENT MODE ON AND OFF (IF EQUIPPED)

 **WARNING:** You are responsible for controlling your vehicle at all times. The system is designed to be an aid and does not relieve you of your responsibility to drive with due care and attention. Failure to follow this instruction could result in the loss of control of your vehicle, personal injury or death.

Use the touchscreen to select the following:

1. Select **Settings**. See **Settings** (page 378).
2. Select **Driver Assist.**
3. Select **Cruise Control**.

# Adaptive Cruise Control (If Equipped)

## Changing the Set Speed with Intelligent Adaptive Cruise Control

When intelligent mode is on, the system adjusts the set speed to the speed limit detected by the camera and the speed limit information provided by the navigation system.

**Note:** The set speed adjusts when the system detects a different maximum speed limit.

**Note:** The speed limit information provided by the navigation map data may be inaccurate or out of date.

**Note:** The system alerts you if the set speed increases beyond the speed limit. See **Adaptive Cruise Control Indicators** (page 201).

If the system does not detect a speed limit, the vehicle speed remains at the current set speed.

You can override the set speed at any time. You may need to override or cancel the system in certain situations such as inclement weather or if an incorrect speed is set.

**Note:** The system may not detect and read speed limit signs with conditional information, for example, when a sign is flashing, during specific time ranges, or when children are present.

**Note:** Under certain conditions, the system may not adjust the vehicle speed until after your vehicle passes the speed limit sign.

## ADJUSTING THE SET SPEED TOLERANCE (IF EQUIPPED)

You can set a permanent speed tolerance that is above or below the detected speed limit.

Use the touchscreen to select the following:

1. Select **Settings**.
2. Select **Driver Assist**.
3. Select **Cruise Control**.
4. Select **Tolerance**.
5. Use **+** and **-** to set the tolerance.

## ADAPTIVE CRUISE CONTROL – TROUBLESHOOTING

### Adaptive Cruise Control – Information Messages

**Note:** Depending on your vehicle options and instrument cluster type, not all messages display or are available.

**Note:** Certain messages may be abbreviated or shortened depending upon which cluster type you have.

Message	Action
Adaptive Cruise Malfunction	A malfunction is preventing the adaptive cruise from engaging.
Front Sensor Not Aligned	Contact an authorized dealer to have the radar checked for proper coverage and operation.
Adaptive Cruise Not Available	Conditions exist preventing the system from being available.

## Adaptive Cruise Control (If Equipped)

Message	Action
Adaptive Cruise Not Available Sensor Blocked See Manual	The radar is blocked because of poor radar visibility due to inclement weather or ice, mud, or water in front of the radar. You can typically clean the sensor to resolve this. Due to the nature of radar technology, it is possible to get a blockage warning with no actual block. This happens, for example, when driving in sparse rural or desert environments. A false blocked condition either self clears, or clears after you restart your vehicle.
Normal Cruise Active Adaptive Braking Off	You have selected normal cruise control. The system does not brake or react to traffic.
Adaptive Cruise - Driver Resume Control	Displays when the adaptive cruise is going to cancel and you must take control.
Adaptive Cruise Speed Too Low to Activate	Displays when the vehicle speed is too slow to activate the adaptive cruise and there is no lead vehicle in range.

### Lane Centering Information Messages

Message	Action
Keep Hands on Steering Wheel	Make sure you return your hands to the steering wheel and provide steering input.
Lane Centering Assist Not Available	Conditions exist preventing the system from being available.
For Lane Centering Assist to work Turn On Adaptive Cruise	Adaptive cruise control must be on before lane centering can be switched on.

### Intelligent Adaptive Cruise Control Information Messages (If Equipped)

Message	Action
Intelligent Cruise Control Speed Sign Recognition Not Available	Conditions exist preventing the system from being available.



# Driving Aids

## DRIVER ALERT

**WARNING:** You are responsible for controlling your vehicle at all times. The system is designed to be an aid and does not relieve you of your responsibility to drive with due care and attention. Failure to follow this instruction could result in the loss of control of your vehicle, personal injury or death.

**WARNING:** The system may not function if the sensor is blocked.

**WARNING:** Take regular rest breaks if you feel tired. Do not wait for the system to warn you.

**WARNING:** Certain driving styles may result in the system warning you even if you are not feeling tired.

**WARNING:** In cold and severe weather conditions the system may not function. Rain, snow and spray can all limit sensor performance.

**WARNING:** The system will not operate if the sensor cannot track the road lane markings.

**WARNING:** If damage occurs in the immediate area surrounding the sensor, have your vehicle checked as soon as possible.

**WARNING:** The system may not correctly operate if your vehicle is fitted with a suspension kit not approved by us.

**Note:** If you have a blocked camera or damaged windshield, the system may not function.

**Note:** The system remembers the last setting when you start your vehicle, unless it detects a MyKey™.

**Note:** If enabled in the menu, the system activates at speeds above 40 mph (64 km/h).

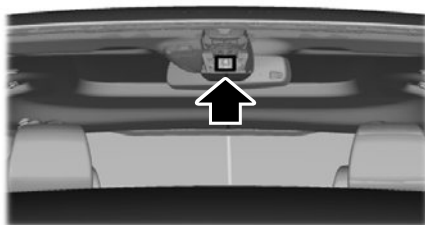

E249505

The system monitors your driving behavior using various inputs including the front camera sensor.

If the system detects reduced driving alertness below a certain threshold, the system alerts you using a tone and a message in the information display.

## Using Driver Alert

### Switching the system on and off

You may switch the system on or off through the information display by selecting Settings, Driver Assist and then Driver Alert in the menu. When activated, the system monitors your alertness level based upon your driving behavior in relation to the lane markings, and other factors.

### System Warnings

**Note:** The system does not issue warnings below approximately 40 mph (64 km/h).

**Note:** Keep the windshield free from obstructions. For example, bird droppings, insects and snow or ice.

# Driving Aids

The warning system is in two stages. At first the system issues a temporary warning that you need to take a rest. This message only appears for a short time. If the system detects further reduction in driving alertness, another warning could be issued which remains in the information display for a longer time. Press OK on the steering wheel control to clear the warning. When active the system runs in the background and only issues a warning if required.

## Resetting the System

You can reset the system by either:

- Switching the ignition off and on.
- Stopping the vehicle and then opening and closing the driver door.

## LANE KEEPING SYSTEM



**WARNING:** You are responsible for controlling your vehicle at all times. The system is designed to be an aid and does not relieve you of your responsibility to drive with due care and attention. Failure to follow this instruction could result in the loss of control of your vehicle, personal injury or death.



**WARNING:** Always drive with due care and attention when using and operating the controls and features on your vehicle.



**WARNING:** In cold and severe weather conditions the system may not function. Rain, snow and spray can all limit sensor performance.



**WARNING:** Large contrasts in outside lighting can limit sensor performance.



**WARNING:** The system will not operate if the sensor cannot track the road lane markings.



**WARNING:** The sensor may incorrectly track lane markings as other structures or objects. This can result in a false or missed warning.



**WARNING:** The system may not operate properly if the sensor is blocked. Keep the windshield free from obstruction.



**WARNING:** If damage occurs in the immediate area surrounding the sensor, have your vehicle checked as soon as possible.



**WARNING:** The system may not correctly operate if your vehicle is fitted with a suspension kit not approved by us.

**Note:** The system works above 40 mph (64 km/h).

**Note:** The system works as long as the camera can detect one lane marking or road edge.

**Note:** When you select aid or alert + aid mode and the system detects no steering activity for a short period, the system alerts you to put your hands on the steering wheel.

**The system may detect a light grip or touch on the steering wheel as hands off driving.**

**Note:** The system may not function if the camera is blocked, or if the windshield is damaged or dirty.

# Driving Aids

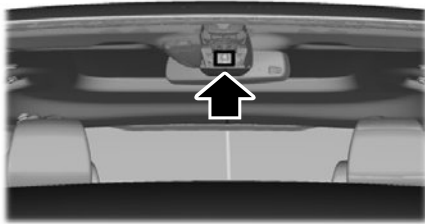

E249505

When you switch the system on and it detects an unintentional drift out of your lane is likely to occur, the system notifies or assists you to stay in your lane through the steering system and information display. In alert mode, the system provides a warning by vibrating the steering wheel. In aid mode, the system provides steering assistance by gently counter steering your vehicle back into the lane.

When the system is functioning in the combined alert and aid mode, the system first provides steering assistance by gently counter steering your vehicle back into the lane, followed by a warning that vibrates the steering wheel if the vehicle is still out of the lane markings.

## Switching the System On and Off



E288067

Press the button on the direction indicator stalk to switch the system on or off.

**Note:** *The on or off setting is stored until it is manually changed, unless a MyKey is detected. If the system detects a MyKey, it defaults to on and the mode sets to alert.*

## System Settings

The system has optional setting menus available. The system stores the last known selection for each of these settings. You do not need to readjust your settings each time you switch the system on.

**Mode:** This setting allows you to select which of the system features you can enable.

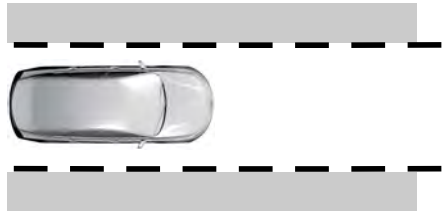

Alert only – Provides a steering wheel vibration when the system detects an unintended lane departure.

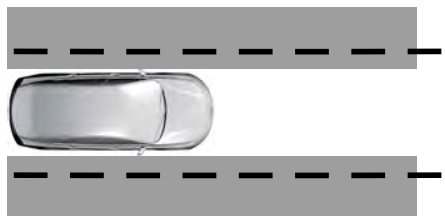

# Driving Aids

Aid only – Provides steering assistance toward the lane center when the system detects an unintended lane departure.

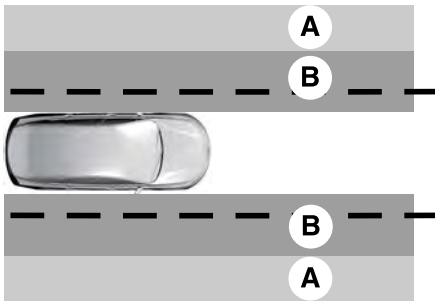

- A Alert.
- B Aid.

Alert + Aid – Provides steering assistance toward the lane center.

If your vehicle continues drifting out of the lane after the lane keeping aid corrects the vehicle, the system provides a steering wheel vibration.

If your vehicle stays to one side of the lane after the lane keeping aid corrects your vehicle and then subsequently drifts out of the lane again, the system only provides an alert at the steering wheel.

**Note:** The alert and aid diagrams illustrate general zone coverage. They do not provide exact zone parameters.

**Intensity:** This setting affects the intensity of the steering wheel vibration used for the alert and alert + aid modes. **This setting does not affect the aid mode.**

- Low.
- Normal.
- High.

## System Display

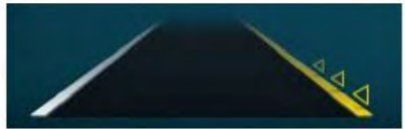
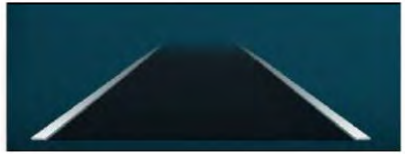

When you switch the system on, an image of lane markings appears in the information display.

When you switch the system off, the lane marking images do not display.

While the system is on, the color of the lane markings change to indicate the system status. These colors represent the following:

Gray: Indicates that the system is temporarily unable to provide a warning or intervention on the indicated side. This may be because:

- Your vehicle is under the activation speed.
- The direction indicator is active.
- Your vehicle is in a dynamic maneuver.
- The road has no or poor lane markings in the camera field-of-view.
- The camera is obscured or unable to detect the lane markings due to environmental, traffic or vehicle conditions. For example, significant sun angles, shadows, snow, heavy rain or fog, following a large vehicle that is blocking or shadowing the lane or poor headlamp illumination.

# Driving Aids

See **Troubleshooting** for additional information.

White: Indicates that the system is available or ready to provide a warning or intervention on the indicated side.

**Note:** *If your vehicle has lane centering assist and the system is active, the walls appear green instead of white.*

Yellow: Indicates that the system is providing or has just provided a lane keeping aid intervention.

Red: Indicates that the system is providing or has just provided a lane keeping alert warning.

The system can be temporarily suppressed at any time by the following:

- Quick braking.
- Fast acceleration.
- Using the direction indicator.
- Evasive steering maneuver.
- Driving too close to the lane markings.

## Troubleshooting

### **Why is the feature not available, line markings are gray, when I can see the lane markings on the road?**

Your vehicle speed is outside the operational range of the feature.

The sun is shining directly into the camera lens.

A quick intentional lane change has occurred.

Your vehicle stays too close to the lane markings.

Driving at high speeds in curves.

The last alert warning or aid intervention occurred a short time ago.

Ambiguous lane markings, for example in construction zones.

Rapid transition from light to dark, or from dark to light.

Sudden offset in lane markings.

ABS or AdvanceTrac™ is active.

There is a camera blockage due to dirt, grime, fog, frost or water on the windshield.

You are driving too close to the vehicle in front of you.

Transitioning between no lane markings to lane markings or vice versa.

There is standing water on the road.

Faint lane markings, for example partial yellow lane markings on concrete roads.

# Driving Aids

**Why is the feature not available, line markings are gray, when I can see the lane markings on the road?**

Lane width is too narrow or too wide.

The camera has not been calibrated after a windshield replacement.

Driving on tight roads or on uneven roads.

**Why does the vehicle not come back toward the middle of the lane, as expected, in the aid or aid + alert mode?**

High cross winds are present.

There is a large road crown.

Rough roads, grooves or shoulder drop-offs.

Heavy uneven loading of the vehicle or improper tire inflation pressure.

The tires have been changed, or the suspension has been modified.

## BLIND SPOT INFORMATION SYSTEM



**WARNING:** Do not use the blind spot information system as a replacement for using the interior and exterior mirrors or looking over your shoulder before changing lanes. The blind spot information system is not a replacement for careful driving.



**WARNING:** The system may not operate properly during severe weather conditions, for example snow, ice, heavy rain and spray. Always drive with due care and attention. Failure to take care may result in a crash.

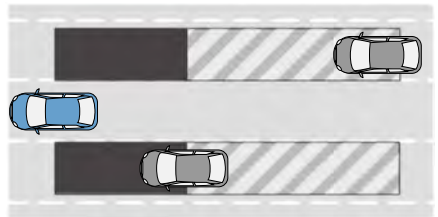

The system is designed to detect vehicles that may have entered the blind spot zone. The detection area is on both sides of your vehicle, extending rearward from the exterior mirrors to approximately 13 ft (4 m) beyond the rear bumper. The detection area extends to approximately 59 ft (18 m) beyond the rear bumper when the vehicle speed is greater than 30 mph (48 km/h) to alert you of faster approaching vehicles.

# Driving Aids

**Note:** The system does not prevent contact with other vehicles. It is not designed to detect parked vehicles, pedestrians, animals or other infrastructures.

## Using the Blind Spot Information System

### Vehicles with Automatic Transmission

The system turns on when all of the following occur:

- You start your vehicle.
- You shift into drive (D).
- The vehicle speed is greater than 6 mph (10 km/h).

**Note:** The system does not operate in park (P) or reverse (R).

## Blind Spot Information System Sensors



The sensors are behind the rear bumper on both sides of your vehicle.

**Note:** Keep the sensors free from snow, ice and large accumulations of dirt.

**Note:** Do not cover the sensors with bumper stickers, repair compound or other objects.

**Note:** Blocked sensors could affect system performance.

If the sensors are blocked, a message may appear in the information display. The alert indicators remain illuminated but the system does not alert you.

## Switching the Blind Spot Information System On and Off

1. Using the information display controls on the steering wheel, select **Settings**.
2. Select **Driver Assistance**.
3. Switch **Blind Spot** on or off.

If you switch the system off, a warning lamp illuminates and a message displays. When you switch the system on or off, the alert indicators flash twice.

**Note:** The system remembers the last setting when you start your vehicle.

**Note:** The system may not correctly operate when towing a trailer. For vehicles with a trailer tow module and tow bar approved by us, the system turns off when you attach a trailer. For vehicles with an aftermarket trailer tow module or tow bar, we recommend that you switch the system off when you attach a trailer.

To permanently switch the system off, contact an authorized dealer.

## Blind Spot Information System Indicator



When the system detects a vehicle, an alert indicator illuminates in the exterior mirror on the side the approaching vehicle is coming from. If you turn the direction indicator on for that side of your vehicle, the alert indicator flashes.

If the system detects a fault, an indicator illuminates in the instrument cluster and a message appears in the information display. Have your vehicle checked as soon as possible.

**Note:** The system may not alert you if a vehicle quickly passes through the detection zone.

# Driving Aids

## Blind Spot Information System Information Messages

Message	Action
Blind Spot Not Available Sensor Blocked See Manual	Displays if the blind spot information system sensors are blocked.
Blis Deactivated Trailer Attached	Displays if you attach a trailer to your vehicle.
Blind Spot System Fault	The system has detected a fault that requires service. Have your vehicle checked as soon as possible.

## CROSS TRAFFIC ALERT



**WARNING:** Do not use the cross traffic alert system as a replacement for using the interior and exterior mirrors or looking over your shoulder before reversing out of a parking space. The cross traffic alert system is not a replacement for careful driving.



**WARNING:** The system may not operate properly during severe weather conditions, for example snow, ice, heavy rain and spray. Always drive with due care and attention. Failure to take care may result in a crash.

The system alerts you of vehicles approaching from the sides behind your vehicle when you shift into reverse (R).

### Using Cross Traffic Alert

The system detects vehicles that approach at a speed between 4 mph (6 km/h) and 37 mph (60 km/h). Coverage decreases when the sensors are partially, mostly or fully obstructed. Slowly reversing helps increase the coverage area and effectiveness.

The system turns on when you start the engine and you shift into reverse (R). The system turns off when you shift out of reverse (R).



# Driving Aids

---

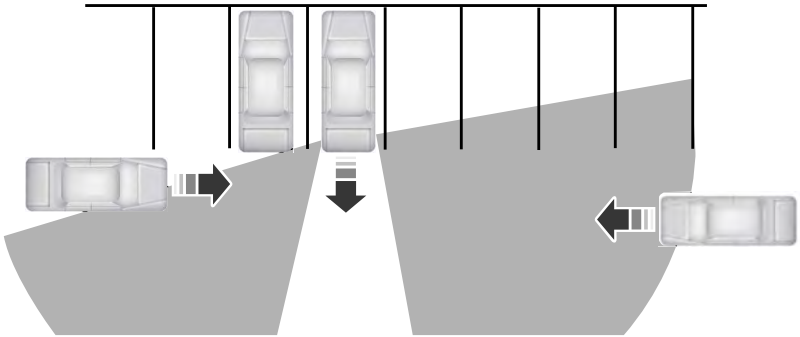

The sensor on the left-hand side is only partially obstructed and zone coverage on the right-hand side is maximized.

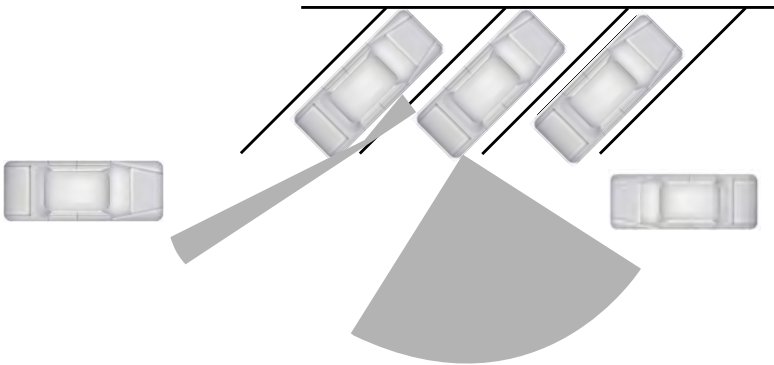

# Driving Aids

Zone coverage also decreases when parking at narrow angles. The sensor on the left-hand side is mostly obstructed and zone coverage on that side is severely reduced.

## Cross Traffic Alert System Sensors

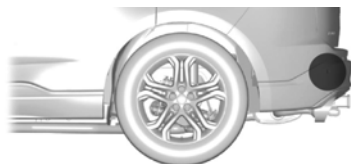

The sensors are behind the rear bumper on both sides of your vehicle.

**Note:** *Keep the sensors free from snow, ice and large accumulations of dirt.*

**Note:** *Do not cover the sensors with bumper stickers, repair compound or other objects.*

**Note:** *Blocked sensors could affect system performance.*

If the sensors are blocked, a message may appear in the information display when you shift into reverse (R).

## Cross Traffic Alert System Limitations

The system may not correctly operate when any of the following occur:

- The sensors are blocked.
- Adjacently parked vehicles or objects are obstructing the sensors.
- Vehicles approach at speeds less than 4 mph (6 km/h) or greater than 37 mph (60 km/h).
- The vehicle speed is greater than 7 mph (12 km/h).
- You reverse out of an angled parking space.

## Cross Traffic Alert Behavior When Trailer is Attached

**Note:** *The system may not correctly operate when towing a trailer. For vehicles with an approved trailer tow module and tow bar, the system turns off when you attach a trailer. For vehicles with an aftermarket trailer tow module or tow bar, we recommend that you switch the system off when you attach a trailer.*

Cross traffic alert remains on when you attach a trailer in vehicles that come with blind spot information system with trailer tow under the following conditions:

- You connect a trailer.
- The trailer is a bike rack or cargo rack with a maximum length of 3 ft (1 m).
- You set the trailer length to 3 ft (1 m) in the information display.

See **Blind Spot Information System** (page 211).

## Switching the System On and Off

To switch the system on or off, adjust the setting. Depending on your vehicle options, the setting could be in the following:

- Information display. See **General Information** (page 99).
- Touchscreen. See **Settings** (page 378).

**Note:** *The system turns on every time you switch the ignition on. To permanently switch the system off, contact an authorized dealer.*

## Cross Traffic Alert Indicator



When the system detects an approaching vehicle, a tone sounds, a warning lamp illuminates in the relevant exterior mirror and arrows appear in the information display to show which side the approaching vehicle is coming from.

# Driving Aids

**Note:** If arrows do not display, a message appears in the information display.

If the system malfunctions, a warning lamp illuminates in the instrument cluster and a message appears in the information display. Have your vehicle checked as soon as possible.

**Note:** In exceptional conditions, the system could alert you, even when there is nothing in the detection zone, for example a vehicle passing further away from your vehicle.

## Cross Traffic Alert Information Messages

Message	Action
Cross Traffic Alert	Displays instead of indication arrows when the system detects a vehicle. Check for approaching traffic.
Cross Traffic Not Available Sensor Blocked See Manual	Indicates blocked cross traffic alert system sensors. Clean the sensors. If the message continues to appear, have your vehicle checked as soon as possible.
Cross Traffic System Fault	The system has malfunctioned. Have your vehicle checked as soon as possible.
Cross Traffic Alert Deactivated Trailer Attached	Displays if you attach a trailer to your vehicle.

## SPEED SIGN RECOGNITION (IF EQUIPPED)

### Principle of Operation



**WARNING:** You are responsible for controlling your vehicle at all times. The system is designed to be an aid and does not relieve you of your responsibility to drive with due care and attention. Failure to follow this instruction could result in the loss of control of your vehicle, personal injury or death.



**WARNING:** In cold and severe weather conditions the system may not function. Rain, snow and spray can all limit sensor performance.



**WARNING:** The system may not operate properly if the sensor is blocked. Keep the windshield free from obstruction.

The system is designed to detect speed limit signs to inform you of the current speed limit. Detected speed signs appear in the information display. The sensor is behind the interior mirror.

**Note:** Do not carry out windshield repairs in the immediate area surrounding the sensor.

**Note:** Speed sign data provided by the navigation system contains information integrated to the data carrier release.

**Note:** The system may not detect all speed signs and may incorrectly read signs.

# Driving Aids

**Note:** If your vehicle has a suspension kit not approved by us, the system may not correctly function.

**Note:** Always replace headlamp bulbs with those specifically designed for your vehicle. Other bulbs could reduce system performance.

The system turns on when you switch the ignition on and you cannot switch the system off.

## Using Speed Sign Recognition

### Setting the System Speed Warning

You can set the system speed warning to alert you when the vehicle speed exceeds the speed limit recognized by the system by a certain speed tolerance.

**Note:** The system remembers the last setting when you start your vehicle.

## System Display



When the system detects a speed limit sign, the speed limit appears in the information display.

**Note:** If your vehicle has a navigation system, stored speed sign data could influence the indicated speed limit value.

To switch the system speed warning on or off, adjust the speed warning settings use the touchscreen:

1. Select **Settings**.
2. Select **Driver Assistance**.
3. Select **Tolerance**.
4. Use **+** and **-** to set the tolerance.

## Information Messages

Message	Action
Traffic Sign Reduced Performance See Manual	The traffic sign data provided by the navigation system is unavailable due to weak or no signal. Wait for a short period of time for the signal to improve. If the message continues to appear, have your vehicle checked as soon as possible.

# Driving Aids

## STEERING

### Electric Power Steering



**WARNING:** The electric power steering system has diagnostic checks that continuously monitor the system. If a fault is detected, a message displays in the information display. Stop your vehicle as soon as it is safe to do so. Switch the ignition off. After at least 10 seconds, switch the ignition on and watch the information display for a steering system warning message. If a steering system warning message returns, have the system checked as soon as possible.



**WARNING:** If the system detects an error, you may not feel a difference in the steering, however a serious condition may exist. Have your vehicle checked as soon as possible. Failure to do so may result in loss of steering control.

Your vehicle is equipped with an electric power-assisted steering system. There is no fluid reservoir to check or fill.

If your vehicle loses electrical power while you are driving (or if the ignition is turned off), you can steer the vehicle manually, but it takes more effort. You must adapt your speed and driving behavior to reduced steering assist. Extreme continuous steering may increase the effort it takes for you to steer. This occurs to prevent internal overheating and permanent damage to your steering system. If this should occur, you will neither lose the ability to steer the vehicle manually nor will it cause permanent damage. Typical steering and driving maneuvers will allow the system to cool down and steering assist will return to normal.

### Steering Tips

If the steering wanders or pulls, check for:

- An improperly inflated tire.
- Uneven tire wear.
- Loose or worn suspension components.
- Loose or worn steering components.
- Improper vehicle alignment.

A high crown in the road or high crosswinds may also make the steering seem to wander or pull.

## PRE-COLLISION ASSIST



**WARNING:** You are responsible for controlling your vehicle at all times. The system is designed to be an aid and does not relieve you of your responsibility to drive with due care and attention. Failure to follow this instruction could result in the loss of control of your vehicle, personal injury or death.



**WARNING:** The system does not detect vehicles that are driving in a different direction, cyclists or animals. Apply the brakes when necessary. Failure to follow this instruction could result in the loss of control of your vehicle, personal injury or death.



**WARNING:** The system does not operate during hard acceleration or steering. Failure to take care may lead to a crash or personal injury.

# Driving Aids



**WARNING:** The system may fail or operate with reduced function during cold and severe weather conditions. Snow, ice, rain, spray and fog can adversely affect the system. Keep the front camera and radar free of snow and ice. Failure to take care may result in the loss of control of your vehicle, serious personal injury or death.



**WARNING:** Some situations and objects prevent hazard detection. For example low or direct sunlight, inclement weather, unconventional vehicle types, and pedestrians. Apply the brakes when necessary. Failure to follow this instruction could result in the loss of control of your vehicle, personal injury or death.



**WARNING:** The system cannot help prevent all crashes. Do not rely on this system to replace driver judgment and the need to maintain a safe distance and speed.

## Using the Pre-Collision Assist System

The system is active at speeds above 3 mph (5 km/h) and pedestrian detection is active at speeds up to 50 mph (80 km/h).



E156130

If your vehicle is rapidly approaching another stationary vehicle, a vehicle traveling in the same direction as yours, or a pedestrian within your driving path, the system provides three levels of functionality:

1. Alert.
2. Brake support.

3. Active braking.

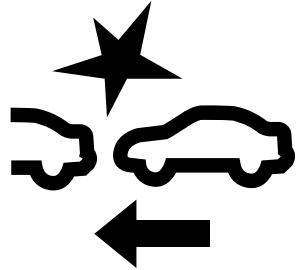

**Alert:** When active, a flashing visual warning appears and an audible warning tone sounds.

**Brake support:** The system helps reduce the impact speed by preparing the brakes for rapid braking. Brake support does not automatically apply the brakes. If you press the brake pedal, the system could apply additional braking up to maximum braking force, even if you lightly press the brake pedal.

**Active braking:** It activates if the system determines that a collision is about to occur. The system may help the driver reduce impact damage or completely avoid the crash.

**Note:** Brake support and active braking are active at speeds up to 75 mph (120 km/h). If your vehicle is equipped with a radar sensor, included with adaptive cruise control, then brake support and active braking are active up to the maximum speed of your vehicle.

**Note:** If you perceive pre-collision assist alerts as being too frequent or disturbing, you can reduce the alert sensitivity, though we recommend using the highest sensitivity setting where possible. Setting lower sensitivity would lead to fewer and later system warnings.

# Driving Aids

**Note:** The system turns off when you manually disable AdvanceTrac™.

## Distance Indication and Alert (If Equipped)

This feature provides the driver with a graphical indication of the time gap to other preceding vehicles traveling in the same direction. The information display screen shows one of the images that follow.



**Note:** Distance indication and alert deactivates and the images do not display when adaptive cruise control is active.

Speed	Sensitivity	Images	Distance Gap	Time Gap
62 mph (100 km/h)	Normal	Grey	>82 ft (25 m)	>0.9sec
62 mph (100 km/h)	Normal	Yellow	56–82 ft (17–25 m)	0.6sec — 0.9sec
62 mph (100 km/h)	Normal	Red	<56 ft (17 m)	<0.6sec

## Evasive Steering Assist (If Equipped)

If your vehicle is rapidly approaching a stationary vehicle or a vehicle traveling in the same direction as your vehicle, the system helps you steer around the vehicle.

The system only activates when all of the following occur:

- The pre-collision assist system detects a vehicle ahead and starts to apply active braking.
- You turn the steering wheel in an attempt to steer around the vehicle.

# Driving Aids

After you turn the steering wheel, the system applies additional steering torque to help you steer around the vehicle. After you pass the vehicle, the system applies steering torque in the opposite direction to encourage you to steer back into the lane. The system deactivates after you fully pass the vehicle.

**Note:** The system does not automatically steer around a vehicle. If you do not turn the steering wheel, the system does not activate.

**Note:** The system does not activate if the distance to the vehicle ahead is too small and a crash cannot be avoided.

## Adjusting the Pre-Collision Assist Settings

Depending on your vehicle options, the pre-collision assist settings may be in the following:

- Information display. See **General Information** (page 99).
- Touchscreen. See **Settings** (page 378).

You can adjust the following settings:

- Change alert and distance alert sensitivity to one of three possible settings.
- Switch distance indication and alert on or off.
- If required, switch active braking on or off.
- If required, switch evasive steering assist on or off.

**Note:** Active braking and evasive steering assist turn on every time you switch the ignition on.

**Note:** If you switch active braking off, evasive steering assist turns off.

## Blocked Sensors

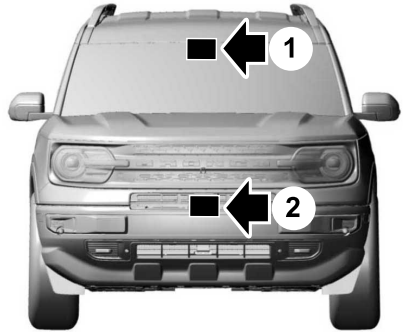

- 1 Camera.
- 2 Radar sensor (if equipped).

If a message regarding a blocked sensor or camera appears in the information display, the radar signals or camera images are obstructed. If your vehicle is equipped with a radar sensor, it is behind the fascia cover in the center of the lower grille. With a blocked sensor or camera, the pre-collision assist system may not operate or performance may reduce. The following table lists possible causes and actions for when this message displays.



# Driving Aids

## Camera Troubleshooting

Cause	Action
The windshield in front of the camera is dirty or obstructed in some way.	Clean the outside of the windshield in front of the camera.
The windshield in front of the camera is clean but the message remains in the display screen.	Wait a short time. It could take several minutes for the camera to detect that there is no obstruction.

## Radar Troubleshooting (If Equipped)

Cause	Action
The surface of the radar in the grille is dirty or obstructed in some way.	Clean the grille surface in front of the radar or remove the object causing the obstruction.
The surface of the radar in the grille is clean but the message remains in the display screen.	Wait a short time. It could take several minutes for the radar to detect that there is no obstruction.
Heavy rain, spray, snow or fog is interfering with the radar signals.	The pre-collision assist system is temporarily disabled. Pre-collision assist reactivates a short time after the weather conditions improve.
Swirling water, snow or ice on the surface of the road may interfere with the radar signals.	The pre-collision assist system is temporarily disabled. Pre-collision assist reactivates a short time after the weather conditions improve.
Radar is out of alignment due to a front-end impact.	Have the radar checked for proper coverage and operation.

**Note:** Proper system operation requires a clear view of the road by the camera. Have any windshield damage in the area of the camera's field of view repaired.

**Note:** If something hits the front end of your vehicle or damage occurs and your vehicle is equipped with a radar sensor, the radar sensing zone may change. This could cause missed or false detections. Have the radar checked for proper coverage and operation.

# Drive Mode Control

## WHAT IS DRIVE MODE CONTROL

Drive mode control delivers a driving experience through a suite of sophisticated electronic vehicle systems. These systems optimize steering, handling and powertrain response in the selected mode. The drive mode control provides a single location to control performance settings for multiple systems.

**Note:** Drive modes are selected by using the Goes Over Any-type of Terrain **G.O.A.T. MODES** controller.

Changing the drive mode changes the functionality of the following:

- Electric power-assisted steering adjusts steering effort and feel based on the mode you select. See **Steering** (page 218).
- Electronic stability control and traction control assist your vehicle control in adverse conditions or high performance driving. See **Stability Control** (page 182).
- Electronic throttle control enhances the powertrain response to your driving inputs.
- Engine sounds change based on each mode.
- Transmission controls become optimized with shift schedules tuned to each mode.
- Four-wheel drive settings are optimized and tuned to each mode.

The system tailors your vehicle configuration for each mode you select.

**Note:** Not all settings may be available.

**Note:** The system has diagnostic checks that continuously monitor the system for proper operation. If a mode is unavailable due to a system fault, the mode defaults to Normal.

## SELECTING A DRIVE MODE - 1.5L ECOBOOST™



To select a drive mode, use the console mounted **G.O.A.T. MODES** controller.

**Note:** Drive mode changes may not be available when the ignition is off.

**Note:** Selected drive mode displays in the information display. See **Information Messages** (page 104).

# Drive Mode Control

## SELECTING A DRIVE MODE - 2.0L ECOBOOST™

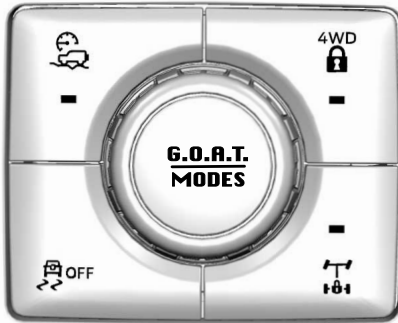

To select a drive mode, use the console mounted **G.O.A.T. MODES** controller.

**Note:** Drive mode changes may not be available when the ignition is off.

**Note:** Button icon shown may vary from your vehicle.

**Note:** Selected drive mode displays in the information display. See **Information Messages** (page 104).

## DRIVE MODES

### Eco



For efficient driving. This mode helps deliver maximum fuel efficiency and helps to increase driving range.

### Mud/Ruts (If Equipped)



For off-road driving. This mode enhances vehicle performance to traverse muddy, rutted or uneven terrains. Lower gears hold longer in mud/ruts mode to maintain momentum in soft conditions. Mud/ruts mode engages the four-wheel drive lock which you can switch off using the drive mode controller. Mud/ruts mode optimizes braking for off-road conditions, allowing quick path corrections and minimized stopping distance when on deformable surfaces. The engine sound enhances when in mud/ruts mode.

The rear differential lock feature is available in mud/ruts mode. When enabled it is engaged below 30 mph (48 km/h).

**Note:** The front camera system switches on when you are in mud/ruts mode and your speed is less than 15 mph (24 km/h). If you exceed 15 mph (24 km/h), the camera shuts off until your vehicle speed is below 12 mph (20 km/h). You can switch the camera off using the button on the audio unit.

**Note:** This mode may help get your vehicle unstuck from deep snow or sand.

**Note:** Using mud/ruts mode on dry, hard surfaces could produce some vibration, driveline bind up, and potential excessive tire and vehicle wear.

### Normal



For everyday driving. This mode is a balance of excitement, comfort and convenience. This is the default mode after each ignition cycle.

The rear differential lock feature is available in normal mode. When enabled it is engaged below 15 mph (24 km/h).

# Drive Mode Control

## Rock Crawl (If Equipped)



For off-road driving. For optimum rock-climbing ability. Rock crawl mode engages the four-wheel drive lock. Rock crawl mode optimizes the vehicle systems to provide maximum traction and slow speed performance. Lower gears hold longer in rock crawl mode to minimize shifting when traversing rocks and obstacles. The accelerator pedal dampens to improve throttle control and minimize speed change over rough terrain. The steering optimizes for less effort with reduced kick-back. Rock crawl mode optimizes braking for off-road conditions, allowing quick path corrections and minimized stopping distance when on deformable surfaces. The engine sound enhances when in rock crawl mode.

The rear differential lock feature enables in rock crawl mode. When enabled it is engaged below 30 mph (48 km/h). You can disable the feature using the drive mode controller.

**Note:** *The front camera system switches on when you are in rock crawl mode and your speed is less than 15 mph (24 km/h). If you exceed 15 mph (24 km/h), the camera shuts off until your vehicle speed is below 12 mph (20 km/h). You can switch the camera off using the button on the audio unit.*

**Note:** *This mode may help get your vehicle unstuck from deep snow or sand.*

**Note:** *Do not use this mode on dry, hard pavement. This could produce some vibration, driveline bind up, and potential excessive tire and vehicle wear depending on the four-wheel drive mode selection.*

## Sand



For more spirited off-road driving. Sand mode is for off-road driving on soft, dry sand or deep conditions. Lower gears hold longer in sand mode to maintain momentum in soft conditions. Sand mode engages the four-wheel drive lock, which you can switch off using the drive mode controller. Sand mode optimizes braking for off-road conditions, allowing quick path corrections and minimized stopping distance when on deformable surfaces. The engine sound enhances when in sand mode.

The rear differential lock feature is available in sand mode. When enabled it is engaged below 30 mph (48 km/h).

**Note:** *The front camera system switches on when you are in sand mode and your speed is less than 15 mph (24 km/h). If you exceed 15 mph (24 km/h), the camera shuts off until your vehicle speed is below 12 mph (20 km/h). You can switch the camera off using the button on the audio unit.*

**Note:** *Using sand mode on dry, hard surfaces could produce some vibration, driveline bind up, potential excessive tire wear and vehicle wear.*

**Note:** *Do not use on firm, slippery surfaces, such as paved roads covered with snow or ice or driving on packed snow. For slippery, firm surfaces use slippery mode.*

## Slippery



For less than ideal road conditions such as snow or ice covered roads. You can use this mode for crossing terrain where loose, wet or slippery materials covers a firm surface. Slippery mode lowers throttle response and optimizes shifting for slippery surfaces.

# Drive Mode Control

---

The rear differential lock feature is available in slippery mode. When enabled it is engaged below 15 mph (24 km/h).

**Note:** *Do not use this mode when driving on dry pavement. This could cause driveline bind up and damage the system depending on the four-wheel drive mode selection. See **Four-Wheel Drive** (page 172).*

## Sport



For sporty driving with improved performance handling and response. This mode increases accelerator pedal response and provides a sportier steering feel. The powertrain system holds onto lower gears longer, helping your vehicle accelerate faster. The steering optimizes for higher effort with more kick-back. The engine sound enhances when in sport mode.

# Load Carrying

## ROOF RACKS AND LOAD CARRIERS



**WARNING:** When loading the roof racks, we recommend you evenly distribute the load, as well as maintain a low center of gravity. Loaded vehicles, with higher centers of gravity, may handle differently than unloaded vehicles. Take extra precautions, such as slower speeds and increased stopping distance, when driving a heavily loaded vehicle.

For correct roof rack system operation, directly place loads on crossbars affixed to the roof rack side rails. When using the roof rack system, we recommend you use our genuine accessory crossbars designed specifically for your vehicle.

Make sure that you securely fasten the load. Check the tightness of the load before driving and at each fuel stop.

**Note:** *Do not place loads directly on the roof panel. The roof panel is not designed to directly carry a load.*

### Maximum Roof Load Amounts

**Note:** *The maximum roof load is based on the load being evenly distributed on the crossbars.*

Weight on Crossbar (Total)	Maximum Roof Load
Vehicles with Panoramic Roof	100 lb (45 kg)
Vehicles without Panoramic Roof	150 lb (68 kg)

## LOAD LIMIT

### Vehicle Loading - with and without a Trailer

This section guides you in the proper loading of your vehicle, trailer, or both. Keep your loaded vehicle weight within its design rating capability, with or without a trailer. Properly loading your vehicle provides maximum return of vehicle design performance. Before you load your vehicle, become familiar with the

following terms for determining your vehicle's weight rating, with or without a trailer, from the vehicle's Tire and Loading Information label or Safety Compliance Certification label.

# Load Carrying

## Tire and Loading Label Information

### Example:



### TIRE AND LOADING INFORMATION

SEATING CAPACITY TOTAL: 5 FRONT: 2 REAR: 3

The combined weight of occupants, and cargo should never exceed 385 kg or 850 lbs.

TIRE	SIZE	COLD TIRE PRESSURE
FRONT	XXX/XXXXX XXX	XXX KPA, XX PSI
REAR	XXX/XXXXX XXX	XXX KPA, XX PSI
SPARE	NONE	NONE

SEE OWNER'S  
MANUAL FOR  
ADDITIONAL  
INFORMATION



### TIRE AND LOADING INFORMATION RENSEIGNEMENTS SUR LES PNEUS ET LE CHARGEMENT

SEATING CAPACITY / NOMBRE DE PLACES TOTAL: 5 FRONT / AVANT: 2 REAR / ARRIERE: 3

The combined weight of occupants and cargo should never exceed 396 kg or 875 lbs.  
Le poids total des occupants et du chargement ne doit jamais dépasser 396 kg ou 875 lbs.

TIRE / PNEU	SIZE / DIMENSIONS	COLD TIRE PRESSURE / PRESSION DES PNEUS A FROID
FRONT / AVANT	XXX/XXXXX XXX	XXX KPA, XX PSI
REAR / ARRIERE	XXX/XXXXX XXX	XXX KPA, XX PSI
SPARE / EN SECOURS	XXX/XXXXX XXX	XXX KPA, XX PSI

SEE OWNER'S  
MANUAL FOR  
ADDITIONAL  
INFORMATION  
VOIR LE MANUEL  
DE L'USAGER  
POUR PLUS DE  
RENSEIGNEMENTS

## Payload

Payload is the combined weight of cargo and passengers that your vehicle is carrying. The maximum payload for your vehicle appears on the Tire and Loading label. The label is either on the B-pillar or the edge of the driver door. Vehicles exported outside the US and Canada may not have a tire and loading label. Look for "The combined weight of occupants and cargo should never exceed XXX kg OR XXX lb" for maximum payload. The payload listed on the Tire and Loading Information label

is the maximum payload for your vehicle as built by the assembly plant. If you install any additional equipment on your vehicle, you must determine the new payload. Subtract the weight of the equipment from the payload listed on the Tire and Loading label. When towing, trailer tongue weight or king pin weight is also part of payload.



### WARNING:

The appropriate loading capacity of your vehicle can be limited either by volume capacity (how much space is available) or by payload capacity (how much weight the vehicle should carry). Once you have reached the maximum payload of your vehicle, do not add more cargo, even if there is space available. Overloading or improperly loading your vehicle can contribute to loss of vehicle control and vehicle rollover.

## GAWR (Gross Axle Weight Rating)

GAWR is the maximum allowable weight that a single axle (front or rear) can carry. These numbers are on the Safety Compliance Certification label. The label is located on the door hinge pillar, door-latch post, or the door edge that meets the door-latch post, next to the driver seating position.

# Load Carrying

The total load on each axle must never exceed its Gross Axle Weight Rating.

## GVWR (Gross Vehicle Weight Rating)

GVWR is the maximum allowable weight of the fully loaded vehicle. This includes all options, equipment, passengers and cargo. It appears on the Safety Compliance Certification label. The label is located on the door hinge pillar, door-latch post, or the door edge that meets the door-latch post, next to the driver seating position.

The gross vehicle weight must never exceed the Gross Vehicle Weight Rating.

## Safety Compliance Certification Label Example:

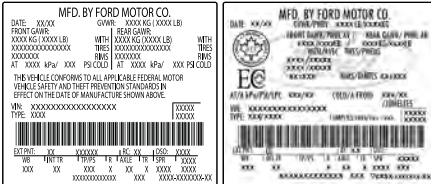



**WARNING:** Exceeding the Safety Compliance Certification label vehicle weight limits can adversely affect the performance and handling of your vehicle, cause vehicle damage and can result in the loss of control of your vehicle, serious personal injury or death.

## Maximum Loaded Trailer Weight

Maximum loaded trailer weight is the highest possible weight of a fully loaded trailer the vehicle can tow. Consult an authorized dealer (or the RV and Trailer Towing Guide available at an authorized dealer) for more detailed information.

## GCWR (Gross Combined Weight Rating)

GCWR is the maximum allowable weight of the vehicle and the loaded trailer, including all cargo and passengers, that the vehicle can handle without risking damage. (Important: The towing vehicle's braking system is rated for operation at Gross Vehicle Weight Rating, not at Gross Combined Weight Rating.) Separate functional brakes should



# Load Carrying

be used for safe control of towed vehicles and for trailers where the Gross Combined Weight of the towing vehicle plus the trailer exceed the Gross Vehicle Weight Rating of the towing vehicle.

The gross combined weight must never exceed the Gross Combined Weight Rating.

**Note:** For trailer towing information refer to the *RV and Trailer Towing Guide* available at an authorized dealer.



**WARNING:** Do not exceed the GVWR or the GAWR specified on the certification label.



**WARNING:** Do not use replacement tires with lower load carrying capacities than the original tires because they may lower your vehicle's GVWR and GAWR limitations. Replacement tires with a higher limit than the original tires do not increase the GVWR and GAWR limitations.



**WARNING:** Exceeding any vehicle weight rating can adversely affect the performance and handling of your vehicle, cause vehicle damage and can result in the loss of control of your vehicle, serious personal injury or death.

## Steps for determining the correct load limit:

1. Locate the statement "The combined weight of occupants and cargo should never exceed XXX kg or XXX lb." on your vehicle's placard.
2. Determine the combined weight of the driver and passengers that will be riding in your vehicle.
3. Subtract the combined weight of the driver and passengers from XXX kg or XXX lb.
4. The resulting figure equals the available amount of cargo and luggage load capacity. For example, if the "XXX" amount equals 1,400 lb. and there will be five 150 lb. passengers in your vehicle, the amount of available cargo and luggage load capacity is 650 lb.  $(1400 - 750 (5 \times 150) = 650 \text{ lb.})$
5. Determine the combined weight of luggage and cargo being loaded on the vehicle. That weight may not safely exceed the available cargo and luggage load capacity calculated in Step 4.
6. If your vehicle will be towing a trailer, load from your trailer will be transferred to your vehicle. Consult this manual to determine how this reduces the available cargo and luggage load capacity of your vehicle.

# Load Carrying

## **Helpful examples for calculating the available amount of cargo and luggage load capacity**

Suppose your vehicle has a 1400-pound (635-kilogram) cargo and luggage capacity. You decide to go golfing. Is there enough load capacity to carry you, four of your friends and all the golf bags? You and four friends average 220 pounds (99 kilograms) each and the golf bags weigh approximately 30 pounds (13.5 kilograms) each. The calculation would be:  $1400 - (5 \times 220) - (5 \times 30) = 1400 - 1100 - 150 = 150$  pounds. Yes, you have enough load capacity in your vehicle to transport four friends and your golf bags. In metric units, the calculation would be:  $635 \text{ kilograms} - (5 \times 99 \text{ kilograms}) - (5 \times 13.5 \text{ kilograms}) = 635 - 495 - 67.5 = 72.5$  kilograms.

Suppose your vehicle has a 1400-pound (635-kilogram) cargo and luggage capacity. You and one of your friends decide to pick up cement from the local home improvement store to finish that patio you have been planning for the past two years. Measuring the inside of the vehicle with the rear seat folded down, you have room for twelve 100-pound (45-kilogram) bags of cement. Do you have enough load capacity to transport the cement to your home? If you and your friend each weigh 220 pounds (99 kilograms), the calculation would be:  $1400 - (2 \times 220) - (12 \times 100) = 1400 - 440$

$- 1200 = - 240$  pounds. No, you do not have enough cargo capacity to carry that much weight. In metric units, the calculation would be:  $635 \text{ kilograms} - (2 \times 99 \text{ kilograms}) - (12 \times 45 \text{ kilograms}) = 635 - 198 - 540 = -103$  kilograms. You will need to reduce the load weight by at least 240 pounds (104 kilograms). If you remove three 100-pound (45-kilogram) cement bags, then the load calculation would be:  $1400 - (2 \times 220) - (9 \times 100) = 1400 - 440 - 900 = 60$  pounds. Now you have the load capacity to transport the cement and your friend home. In metric units, the calculation would be:  $635 \text{ kilograms} - (2 \times 99 \text{ kilograms}) - (9 \times 45 \text{ kilograms}) = 635 - 198 - 405 = 32$  kilograms.

The above calculations also assume that the loads are positioned in your vehicle in a manner that does not overload the front or the rear gross axle weight rating specified for your vehicle on the Safety Compliance Certification label.

## **Special Loading Instructions for Owners of Pick-up Trucks and Utility-type Vehicles**



**WARNING:** When loading the roof racks, we recommend you evenly distribute the load, as well as maintain a low center of gravity. Loaded vehicles, with higher centers of gravity, may

## Load Carrying

---

handle differently than unloaded vehicles. Take extra precautions, such as slower speeds and increased stopping distance, when driving a heavily loaded vehicle.

# Luggage Compartment

## ADJUSTING THE LUGGAGE COMPARTMENT LOAD FLOOR

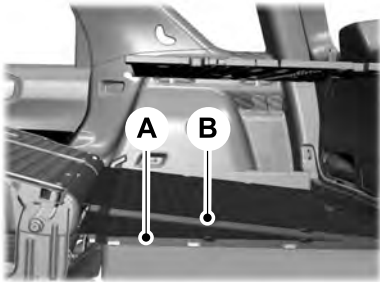

- A Flat load floor.
- B Angled load floor.

The load floor can be adjusted to a higher position to provide a fully flat load area when the rear seats are folded.

## ADJUSTING THE LUGGAGE COMPARTMENT DIVIDER (IF

EQUIPPED)

### Full Shelf Position

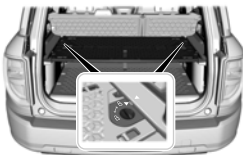

1. Slide the luggage compartment divider onto the tracks on each side of the vehicle.
2. Align the triangles on the latches and turn to lock the shelf into place.

**Note:** Do not use the shelf as a seat.

**Note:** The maximum weight you can place on the shelf is 29 lb (13 kg).

**Note:** Store or fold the shelf when the full shelf is not being used.

### Folded Shelf Position

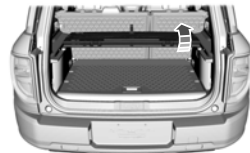

Fold the luggage compartment divider.

**Note:** The luggage compartment divider must be locked in place in the full shelf position before folding.

**Note:** Do not use the shelf as a seat.

**Note:** The maximum weight you can place on the shelf is 29 lb (13 kg).

**Note:** We recommend using this position to avoid noise when driving when the shelf is empty.

### Table Position



1. Slide the luggage compartment divider to the first locking position.
2. Align the triangles and turn the latches to lock into place.
3. Pull the table legs down and lock into place on the bumper.

**Note:** The full shelf must be locked in the first locking position before the table legs are deployed.

# Luggage Compartment

---

**Note:** The maximum weight you can place on the shelf is 29 lb (13 kg).

## Divider Position

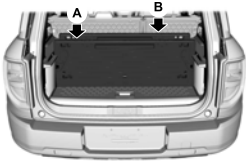

- A Forward divider position.
- B Rear divider position.

Fold the divider and insert into the divider slots.

## Storage Position

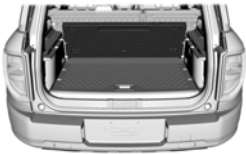

Store the luggage compartment divider behind the rear seat.

# Towing

## TOWING A TRAILER



**WARNING:** Towing trailers beyond the maximum recommended gross trailer weight exceeds the limit of your vehicle and could result in engine damage, transmission damage, structural damage, loss of vehicle control, vehicle rollover and personal injury.



**WARNING:** Do not exceed the GVWR or the GAWR specified on the certification label.

**Note:** See *Recommended Towing Weights* (page 236).

Your vehicle may have electrical items, such as fuses or relays, related to towing. See **Fuses** (page 262).

Your vehicle's load capacity designation is by weight, not by volume, so you cannot necessarily use all available space when loading a vehicle or trailer.

Towing a trailer places an extra load on your vehicle's engine, transmission, axle, brakes, tires and suspension. Inspect these components periodically during, and after, any towing operation.

## Load Placement

To help minimize how trailer movement affects your vehicle when driving:

- Load the heaviest items closest to the trailer floor.
- Load the heaviest items centered between the left and right side trailer tires.
- Load the heaviest items above the trailer axles or just slightly forward toward the trailer tongue. Do not allow the final trailer tongue weight to go above or below 10-15% of the loaded trailer weight.
- Select a ball mount with the correct rise or drop and load capacity. When both the loaded vehicle and trailer are connected, the trailer frame should be level, or slightly angled down toward your vehicle, when viewed from the side.

When driving with a trailer or payload, a slight takeoff vibration or shudder may be present due to the increased payload weight. Additional information regarding proper trailer loading and setting your vehicle up for towing is located in another chapter of this manual. See **Load Limit** (page 227).

You can also find information in the **RV & Trailer Towing Guide** available at your authorized dealer, or online.

# Towing

## RV & Trailer Towing Guide Online

Website | <http://www.fleet.ford.com/towing-guides/>

### TRAILER SWAY CONTROL



**WARNING:** Turning off trailer sway control increases the risk of loss of vehicle control, serious injury or death. Ford does not recommend disabling this feature except in situations where speed reduction may be detrimental (such as hill climbing), the driver has significant trailer towing experience, and can control trailer sway and maintain safe operation.

**Note:** *This feature does not prevent trailer sway, but reduces it when it begins.*

**Note:** *This feature cannot stop all trailers from swaying.*

**Note:** *In some cases, if your vehicle speed is too high, the system may turn on multiple times, gradually reducing your vehicle speed.*

The system applies the brakes to the individual wheels and reduces engine torque to aid vehicle stability. If the trailer begins to sway, the stability control warning lamp flashes and a message appears in the information display. See **Information Messages** (page 104). Slow your vehicle down, pull safely to the side of the road and check for correct load distribution. See **Load Carrying** (page 227).

You can switch this feature off in the information display. When you switch the ignition on, the system automatically turns on.

### RECOMMENDED TOWING WEIGHTS



**WARNING:** Towing trailers beyond the maximum recommended gross trailer weight exceeds the limit of your vehicle and could result in engine damage, transmission damage, structural damage, loss of vehicle control, vehicle rollover and personal injury.

**Note:** *Do not exceed the trailer weight for your vehicle configuration listed in the following chart.*

**Note:** *Do not exceed the trailer frontal area for your vehicle configuration listed in the following chart.*

**Note:** *Your vehicle could have reduced performance when operating at high altitudes, and when heavily loaded or towing a trailer. When driving at elevation, to match driving performance as perceived at sea level, reduce gross vehicle weight and gross combination weight by 2% per 1,000 ft (300 m) of elevation.*

# Towing

**Note:** *Certain states require electric trailer brakes for trailers over a specified weight. Be sure to check state regulations for this specified weight. The maximum trailer weights listed may be limited to this specified weight, as the vehicle's electrical system may not include the wiring connector needed to activate electric trailer brakes.*

Your vehicle may tow a trailer provided the maximum trailer weight is less than or equal to the maximum trailer weight listed for your vehicle configuration on the following chart.

<b>Powertrain</b>	<b>Maximum Gross Combined Weight Ratio</b>	<b>Maximum Trailer Weight</b>	<b>Maximum Trailer Frontal Area</b>
1.5L EcoBoost	5,860 lb (2,658 kg)	2,000 lb (907 kg)	20 ft <sup>2</sup> (1.86 m <sup>2</sup> )
2.0L EcoBoost	6,260 lb (2,839 kg)	2,200 lb (997 kg)	20 ft <sup>2</sup> (1.86 m <sup>2</sup> )

Calculated with SAE J2807 method.

## ESSENTIAL TOWING CHECKS

Follow these guidelines for safe towing:

- Do not tow a trailer until you drive your vehicle at least 1,000 mi (1,600 km).
- Consult your local motor vehicle laws for towing a trailer.
- See the instructions included with towing accessories for the proper installation and adjustment specifications.

- Service your vehicle more frequently if you tow a trailer. See your scheduled maintenance information.
- If you use a rental trailer, follow the instructions the rental agency gives you.

You can find information on load specification terms found on the tire label and Safety Compliance label as well as instructions on calculating your vehicle's load in the Load Carrying chapter. See **Load Limit** (page 227).

Remember to account for the trailer tongue weight as part of your vehicle load when calculating the total vehicle weight.



# Towing

## Trailer Towing Connector (If Equipped)



E168683

When attaching the trailer wiring connector to your vehicle, only use a proper fitting connector that works with the vehicle and trailer functions.

**Note:** Install the water proof protection cap back onto the trailer towing connector whenever it is not in use. This helps to prevent water damage and trailer towing connector malfunction.

**Note:** You cannot use a seven-pin trailer wiring connector for your vehicle and the trailer lighting equipment.

Color	Function
Yellow	Left direction indicator and stop lamp
White	Ground (-)
Green	Right direction indicator and stop lamp
Brown	Running lights

## Hitches

Do not use a hitch that either clamps onto the bumper or attaches to the axle.

Distribute the trailer load so 10-15% of the total trailer weight is on the tongue.

## Safety Chains

**Note:** Never attach safety chains to the bumper.

Always connect the safety chains to the hook retainers of your vehicle hitch.

To connect the trailer's safety chains, cross them under the trailer tongue and allow enough slack for turning tight corners. Do not allow the chains to drag on the ground.

## Trailer Brakes



**WARNING:** Do not connect a trailer's hydraulic brake system directly to your vehicle's brake system. Your vehicle may not have enough braking power and your chances of having a collision greatly increase.

Electric brakes and manual, automatic or surge-type trailer brakes are safe if you install them properly and adjust them to the manufacturer's specifications. The trailer brakes must meet local and federal regulations.

**The rating for the tow vehicle's braking system operation is at the gross vehicle weight rating, not the gross combined weight rating.**

**Separate functioning brake systems are required for safe control of towed vehicles and trailers weighing more than 1500 lb (680 kg) when loaded.**

# Towing

## Trailer Lamps



**WARNING:** Never connect any trailer lamp wiring to the vehicle's tail lamp wiring; this may damage the electrical system resulting in fire. Contact your authorized dealer as soon as possible for assistance in proper trailer tow wiring installation. Additional electrical equipment may be required.

Trailer lamps are required on most towed vehicles. Make sure all running lights, brake lights, turn signals and hazard lights are working.

## Before Towing a Trailer

Practice turning, stopping and backing up to get the feel of your vehicle-trailer combination before starting on a trip. When turning, make wider turns so the trailer wheels clear curbs and other obstacles.

## When Towing a Trailer

- Do not drive faster than 70 mph (113 km/h) during the first 500 mi (800 km).
- Do not make full-throttle starts.
- Check your hitch, electrical connections and trailer wheel lug nuts thoroughly after you have traveled 50 mi (80 km).
- When stopped in congested or heavy traffic during hot weather, place the transmission in park (P) to aid engine and transmission cooling and to help A/C performance.
- Turn off the speed control with heavy loads or in hilly terrain. The speed control may turn off automatically when you are towing on long, steep grades.

- Shift to a lower gear when driving down a long or steep hill. Do not apply the brakes continuously, as they may overheat and become less effective.
- If your transmission is equipped with a Grade Assist or Tow/Haul feature, use this feature when towing. This provides engine braking and helps eliminate excessive transmission shifting for optimum fuel economy and transmission cooling.
- Allow more distance for stopping with a trailer attached. Anticipate stops and brake gradually.
- Avoid parking on a grade. However, if you must park on a grade:
  1. Turn the steering wheel to point your vehicle tires away from traffic flow.
  2. Set your vehicle parking brake.
  3. Place the automatic transmission in park (P).
  4. Place wheel chocks in front and back of the trailer wheels. Chocks are not included with your vehicle.

## Launching or Retrieving a Boat or Personal Watercraft (PWC)

**Note:** Disconnect the wiring to the trailer **before** backing the trailer into the water.

**Note:** Reconnect the wiring to the trailer **after** removing the trailer from the water.

When backing down a ramp during boat launching or retrieval:

- Do not allow the static water level to rise above the bottom edge of the rear bumper.
- Do not allow waves to break higher than 6 in (15 cm) above the bottom edge of the rear bumper.

# Towing

Exceeding these limits may allow water to enter vehicle components:

- Causing internal damage to the components.
- Affecting driveability, emissions, and reliability.

Replace the rear axle lubricant anytime the rear axle has been submerged in water. Water may have contaminated the rear axle lubricant, which is not normally checked or changed unless a leak is suspected or other axle repair is required.

## TOWING THE VEHICLE ON FOUR WHEELS

### Emergency Towing



**WARNING:** If your vehicle has a steering wheel lock make sure the ignition is in the accessory or on position when being towed.

If your vehicle becomes inoperable without access to wheel dollies or a vehicle transport trailer, it can be flat-towed with all wheels on the ground, regardless of the powertrain and transmission configuration, under the following conditions:

- Your vehicle is facing forward for towing in a forward direction.
- Refer to the Manual Park Release procedure. See **Automatic Transmission** (page 166). Failing to do so could result in damage to the transmission.
- Maximum speed is 35 mph (56 km/h).
- Maximum distance is 50 mi (80 km).

**Note:** *If you are unsure of the vehicle's configuration, contact an authorized dealer.*

### Recreational Towing - Front-Wheel Drive Vehicles (If Equipped)

You cannot recreational tow your vehicle with all wheels on the ground because vehicle or transmission damage could occur. Place the front wheels on a two-wheel tow dolly. If you are using a tow dolly, follow the instructions specified by the equipment provider.

### Recreational Towing - Rear-Wheel Drive Vehicles (If Equipped)

You cannot recreational tow your vehicle with all wheels on the ground because vehicle or transmission damage could occur. We recommend towing your vehicle with all four wheels off the ground, such as when using a car-hauling trailer. Otherwise, you cannot recreational tow your vehicle.

### Recreational Towing - All-Wheel and Four-Wheel Drive Vehicles (If Equipped)

You cannot recreational tow your vehicle with all wheels on the ground because vehicle or transmission damage could occur. We recommend towing your vehicle with all four wheels off the ground, such as when using a car-hauling trailer. Otherwise, you cannot recreational tow your vehicle.

# Driving Hints

---

## OFF-ROAD DRIVING

### What Is Off-Road Driving

Off-road driving is driving your vehicle on unsurfaced roads or trails, made from dirt, rocks, sand and mud.

Your vehicle has been designed and equipped to explore those places where the road cannot take you, whether you choose a forest trail or the open desert.

### Off-Road Driving Precautions



**WARNING:** If you continue to drive your vehicle when the engine is overheating, the engine could stop without warning. Failure to follow this instruction could result in the loss of control of your vehicle.

Before going off-road, consult with your local governmental agencies to determine designated off-road trails and recreation areas. Also, be sure to understand any off-road vehicle registration requirements for the area in which you plan on driving.

Tread Lightly is an educational program designed to increase public awareness of land-use regulations and responsibilities in our nation's wilderness areas. The U.S. Forest Service and Bureau of Land Management is encouraging you to help preserve our national forest and other public and private lands by treading lightly.

Before taking your vehicle off-road, do a basic vehicle inspection to make sure that the vehicle is in top working condition.

Before you venture off road, have a clear mental picture of the underside of your vehicle. Learn the location of any low hanging items and any skid plates that may be on the vehicle. You can avoid snagging them on rocks and other obstacles if you know where they are.

Memorizing some basic dimensions helps you confidently deal with off-road obstacles. Get to know your vehicle's height and width, its lowest point, its wading depth and angles. Familiarize yourself with your vehicle's on-board technology features.

We recommend driving at least two vehicles when driving off-road. The buddy system helps make sure that help is close at hand should a vehicle become stuck or damaged.

We recommend taking supplies such as a first aid kit, supply of water, tow strap and cell or satellite phone with you any time you plan an off-road excursion.

### Basic Off-Road Driving Techniques

Grip the steering wheel with your thumbs on the outside of the rim. This reduces the risk of injury due to abrupt steering wheel motions that occur when negotiating rough terrain.

Control your throttle, brake and steering inputs in a smooth manner. Sudden inputs to the controls can cause a loss of traction for the vehicle, especially when on sloped terrain or crossing obstacles such as rocks or logs.

# Driving Hints

Look ahead on your route noting upcoming obstacles, surface texture or color changes or any other factors which may indicate a change in available traction. Adjust the vehicle speed and route to avoid a loss in traction. Conditions can change causing the course to vary day to day. Mark obstacles with GPS markers to avoid potential vehicle damage. Where necessary, get out of your vehicle and check the terrain.

When driving off-road, if the front or rear suspension is bottoming-out or excessive contact with the skid-plates is happening, reduce the vehicle's speed to avoid potential damage to your vehicle.

If you are driving in a dusty area, be sure to leave ample distance between your vehicle and any other vehicles to allow for adequate vision.

When driving off-road verify that your wipers and washers are working properly and reduce your speed for better visibility.

When driving in desert conditions, we recommend driving with your headlamps on to help other drivers easily see you.

When convoying with other vehicles, we recommend that communication is used, and the lead vehicle notify other vehicles of upcoming obstacles.

Keep available ground clearance in mind and pick a route that minimizes the risk of catching the underside of the vehicle on an obstacle.

When negotiating low speed obstacles, applying light brake pressure in conjunction with the throttle allows you to negotiate the obstacle in a more controlled manner.

Driving off-road requires a high amount of concentration. Even if your local law does not prohibit drinking alcohol when driving off-road we do not recommend it.

## Driving Off-Road

### Driving In Snow and Ice



**WARNING:** If you are driving in slippery conditions that require tire chains or cables, then it is critical that you drive cautiously. Keep speeds down, allow for longer stopping distances and avoid aggressive steering to reduce the chances of a loss of vehicle control which can lead to serious injury or death. If the rear end of your vehicle slides while cornering, steer in the direction of the slide until you regain control of your vehicle.

Four-wheel drive vehicles have advantages over two-wheel drive vehicles in snow and ice but can skid like any other vehicle. If your vehicle slides when driving on snowy or icy roads, turn the steering wheel in the direction of the slide until you regain control. Avoid sudden applications of power and quick changes of direction on snow and ice. Slowly and steadily apply the accelerator when starting from a full stop. Avoid sudden braking.



**WARNING:** Do not become overconfident in the ability of four-wheel drive vehicles. Although a four-wheel drive vehicle may accelerate better than a two-wheel drive vehicle in low traction situations, it won't stop any faster than two-wheel drive vehicles. Always drive at a safe speed.

Make sure you allow sufficient distance between your vehicle and other vehicles for stopping.

In emergency stopping situations, do not pump the brake pedal, apply the brake firmly.

# Driving Hints

## Driving In Sand

When driving over sand, try to keep all four wheels on the most solid area of the trail. Drive through the terrain without varying vehicle speed. Apply the accelerator and avoid excessive wheel slip.

When driving at slow speeds in deep sand under high ambient temperatures, use low (L) mode, or shift to a lower gear when possible. Select Low (L) mode or select a lower gear to maximize the engine and transmission cooling capability. See **Transmission** (page 166).

Use the vehicle's momentum to maintain forward motion in sand. Avoid coming to a stop on steep sand slopes as the vehicle may not be able to continue forward after it has stopped.

## Driving In Mud

Be cautious of sudden changes in vehicle speed or direction when you are driving in mud.

Even four-wheel drive vehicles can lose traction in slick mud. If your vehicle does slide, steer in the direction of the slide until you regain control of your vehicle.

After driving through mud, clean off residue stuck to rotating driveshafts and tires. Excess mud stuck on tires and rotating driveshafts can cause an imbalance that could damage drive components.

**Note:** *The vehicle brakes are less effective when wet or muddy.*

## Driving Over Rocks and Gravel

Gravel is a constantly changing, low-grip surface. Driving at slow speeds on gravel reduces the risk of losing traction when you stop, accelerate or turn a corner.

When approaching large rocks, position the vehicle so that the tires pass over the largest obstacle.

**Note:** *Never attempt to straddle a rock that is large enough to strike your axles or undercarriage.*

**Note:** *Never attempt to drive over a rock which is large enough to contact the door sills.*

If you lose traction on your wheels facing uphill, stop and choose a more suitable route.

Leave a generous gap between your vehicle and other vehicles to minimize the risk of damage from flying gravel. Avoid dust clouds as they reduce visibility.

Before navigating on uneven ground, secure anything inside the vehicle. If possible, remove any roof-rack items. Use the lowest gear possible and approach the obstacle at a slow speed.

If your vehicle begins to slide down a slope, steer downhill and gently apply the throttle. If you lose traction on your uphill wheels, stop immediately and choose a more suitable route.

Approach logs, rocky steps or ditches diagonally. Keep at least three wheels on the ground at all times.

## Climbing A Hill



**WARNING:** Extreme care should be used when steering the vehicle in reverse down a slope so as not to cause the vehicle to swerve out of control.

Although natural obstacles can make it necessary to travel diagonally up or down a hill or steep incline, try to drive straight up or straight down.

**Note:** *Avoid turning on steep slopes or hills. A danger lies in losing traction, slipping sideways and possible vehicle roll over.*

Whenever driving on a hill, first determine the route you can use.

# Driving Hints

When climbing a steep slope or hill, start in a lower gear rather than downshifting to a lower gear from a higher gear. This reduces strain on the engine and the possibility of stalling.

If your vehicle stalls, do not try to turn around because this could cause your vehicle to roll over. It is better to reverse back to a safe location.

Do not drive over the crest of a hill without seeing what conditions are on the other side. Do not drive in reverse over a hill without the aid of an observer.

If the vehicle is unable to make it up the hill, do not attempt to turn back down the slope.

Apply the accelerator just enough for the wheels to climb the hill.

**Note:** *Too much acceleration can cause the tires to slip, spin or lose traction, resulting in loss of vehicle control.*

Descending A Hill:

- Use the same gear you would use to climb the hill.
- Do not descend in neutral.
- Disengage overdrive.
- Avoid sudden and excessive braking.

**Note:** *The front wheels have to be turning in order to steer your vehicle.*

When descending a steep hill in a manual transmission vehicle do not leave the vehicle in gear with the clutch depressed. This could cause damage to your driveline.

## Driving Through Water



**WARNING:** Do not attempt to cross a deep, fast flowing body of water. Failure to follow this instruction could result in the loss of control of your vehicle, personal injury or death.

As the water depth increases, you must reduce your vehicle speed to avoid potential vehicle damage.

The key to a safe crossing is the water depth, current and bottom of the water's condition. On soft bottoms, the vehicle sinks in, effectively increasing the water level on the vehicle. Make sure to consider this when determining the depth of water.

Determine the depth and speed of the current before attempting a water crossing.

Be aware that obstacles and debris may be beneath the water's surface.

**Note:** *Cross flowing water at an angle heading slightly upstream.*

**Note:** *You should tread lightly and avoid damage to the environment.*

Drive slow when crossing water. Proceed with a constant slow speed lightly pressing on the accelerator.

Drive through the water very slowly when entering, then build up momentum. Keep your vehicle moving at a steady pace.

**Note:** *Do not try to accelerate through the water crossing.*

When driving too fast in water or through deep water, the engine, transmission, transfer case, axles, electrical components or vehicle interior could ingest water. Water can cause permanent damage that may not be covered by your vehicle warranty. See **Driving Through Water Limitations** (page 246).

**Note:** *Failure to follow the recommended speeds can result in vehicle damage.*

Never stop or shut a vehicle off when crossing deep water unless your vehicle ingested water into the engine air intake. If the engine stalls, do not attempt to restart it.

# Driving Hints

Ease off the accelerator as you reach the other side to diminish the front wave. Apply the accelerator slowly and as necessary to climb out of the other side.

Muddy waters can reduce the cooling system effectiveness by depositing debris into the radiator.

Extra care must be taken crossing any type of water. Do not drive into water unless necessary. You should only drive through areas that are designated and approved.

High currents even in shallow water can wash the dirt out from around your tires or push your vehicle across slippery rocks or surfaces.

Never attempt to cross flowing water that is deeper than your vehicles ground clearance. Even in low currents your vehicles body surface area can be pushed downstream and out of control.

Do not cross any body of water that is fast flowing and rising, wait for the flow rate to reduce.

Determine exit points that are downstream of your entry point to allow for drifting.

If there are other vehicles ahead, wait until they've left the water. Unsettled water can make a safe passage more challenging.

Know your vehicle's abilities and be able to recover it if something goes wrong.

Keep the doors fully closed during a water crossing.

Vehicles used to traverse water regularly should be periodically inspected for signs of water ingestion in all of the vehicle's fluids. If water is found inside your vehicle fluids, service your vehicle or see an authorized dealer.

After driving through water and as soon as it is safe to do so, check the brakes, horn, lights, and steering wheel to make sure everything is still in working order.

## Avoid Getting High-Centered

Always keep available ground clearance in mind and pick a route that minimizes the risk of catching the underside of the vehicle on an obstacle and getting high-centered.

## Freeing A Stuck Vehicle



**WARNING:** Do not spin the wheels at over 34 mph (55 km/h). The tires may fail and injure a passenger or bystander.

Recovery hooks are mounted to the vehicle's structure and are used to pull out the vehicle from a surface or location when stuck. Recover your vehicle using various towing apparatus attached to your recovery hook such as winch, open hook, or strap.

**Note:** Do not use recovery hooks to *recreationally tow your vehicle*. See **Towing the Vehicle on Four Wheels** (page 240).

If your vehicle gets stuck in mud or snow, you may rock it out by shifting between forward and reverse gears, stopping between shifts in a steady pattern. Press the accelerator in each gear.

**Note:** Do not rock your vehicle if the engine is not at normal operating temperature *damage to the transmission may occur*.

**Note:** Do not rock your vehicle for more than a minute *damage to the transmission and tires may occur or the engine may overheat*.

If you are unable to free your vehicle call roadside assistance. See **Roadside Assistance** (page 250).



# Driving Hints

## Crossing A Ravine, Gully, Ditch, Washout Or Rut

Review the path ahead before attempting to cross any obstacle. Review the obstacle from outside the vehicle for an understanding of the terrain condition in front of and behind the obstacle. Approach obstacles slowly and inch the vehicle over. Ditches and washouts should be crossed at a 45 degree angle when possible.

## Driving Over Logs

Review the path ahead before attempting to cross any obstacle. Review the obstacle from outside the vehicle for an understanding of the terrain condition in front of and behind the obstacle.

Approach obstacles slowly and inch the vehicle over, approaching at a 15 degree angle.

**Note:** *It is best to have a front tire on top of the log when the other begins to climb over.*

If a large obstacle near the log such as a rock cannot be avoided, choose a path that places the rock directly under the tire rather than the undercarriage of the vehicle. This helps prevent damage to the vehicle.

## Driving Through Water Limitations

Model	Maximum Wading Depth
Base	17.7 in (450 mm)
Badlands	23.6 in (600 mm)

When you are driving through water do not exceed 4 mph (7 km/h).

## Off-Road Driving Aids

### Selecting an Off-Road Drive Mode

Using the appropriate drive mode increases your vehicle's control. See **What Is Drive Mode Control** (page 223).

### Using the Cameras Off-Road

Use the 180 degree camera to enhance your off-road experience. See **180 Degree Camera** (page 191).

### Using Four-Wheel Drive Lock

Increases four wheel drive performance by preventing the front and rear axles from disconnecting. You can activate and deactivate the four wheel drive lock on the fly. See **Using Four-Wheel Drive** (page 172).

### Using Rear Differential Lock

The rear differential lock provides additional traction to your vehicle when stuck.

You can activate and deactivate the rear differential lock on the fly within the operating speed range.

The rear differential locker disengages when the vehicle speed exceeds a set value and it re-engages when the vehicle speed goes below a set value. See **Using Four-Wheel Drive** (page 172).

### Using Trail Control

The system works in a similar manner to cruise control in off-road conditions. Trail Control provides you the ability to maneuver the vehicle without using the throttle and brake pedals.

# Driving Hints

Trail Control allows you to set a speed between 1 mph (1.6 km/h) to 14 mph (23 km/h) in a forward motion and 1 mph (1.6 km/h) to 5 mph (8 km/h) in reverse. The system controls acceleration and braking in difficult off-road environments, which allows you to focus on steering. See **What Is Trail Control** (page 184).

Trail Control Performance:

- Manages wheel slip to maximize traction.
- Removes the need for you to use both feet when driving in off-road situations.
- Provides braking to maximize traction in descents.
- Gives you confidence in difficult environments.

## After Driving Your Vehicle Off-Road



**WARNING:** After off-road use, before returning to the road, check the wheels and tires for damage. Off-road use may cause damage to your wheels and tires that can lead to tire failure, loss of vehicle control, serious injury or death.

Driving off-road places more stress on your vehicle than most on-road driving. After driving off-road, check for damage to the wheels, chassis and underbody.

Inspect the underbody of your vehicle by checking tires, body structure, steering, suspension, and exhaust system for damage.

Inspect the tires for any cuts in the tread or sidewall area. Also inspect the sidewall for any bulge indicating damage to the tire.

Make sure that tires are inflated to proper tire pressure as indicated on the tire placard.

Check the radiator for mud and debris and clean as needed.

Check that the air filter is clean and dry.

Remove accumulations of plants or brush. These things could be a fire hazard or hide damage to the fuel lines, brake hoses, and propeller shafts.

Make sure that the grille and radiator are clear of any obstructions that may affect cooling.

After extended operation in mud, sand, water, or similar dirty conditions, inspect the wipers and washers to make sure they are working.

**Note:** *Mud caked windows are hard to see through and can damage wiper blades or motor.*

Check wipers for debris or anything that may scratch the windshield.

If you experience unusual vibration after driving in mud, slush or similar conditions, check the wheels for impacted material. Impacted material can cause vibrations when driving and wheel imbalance. Remove the material to reduce the vibration.

**Note:** *If you have removed the impacted material from the wheels and your vehicle still has a vibration check your vehicle for damage or see an authorized dealer.*

Inspect the exhaust system for damage or looseness.

Make sure that the brakes are in proper working order and free of any mud, stones and debris, which can become trapped around the brake rotor, backing plate and caliper.

Inspect the wheels for dents, cracks, or other damage.

# Driving Hints

Inspect undercarriage fasteners. If any are loose or damaged, tighten or replace ensuring that the proper torque specification is used.

Inspect for torn or punctured boots on ball joints, half shafts, steering gears.

Refit the front license plate if removed previously.

## BREAKING-IN

### Tires

You need to break in new tires for approximately 300 mi (480 km). During this time, your vehicle may exhibit some unusual driving characteristics.

### Brakes and Clutch

Avoid heavy use of the brakes and clutch if possible for the first 100 mi (160 km) in town and for the first 1,000 mi (1,600 km) on freeways.

## DRIVING ECONOMICALLY

The following helps to improve fuel consumption:

- Drive smoothly, accelerate gently and anticipate the road ahead to avoid heavy braking.
- Regularly check your tire pressures and make sure that they are inflated to the correct pressure.
- Follow the recommended maintenance schedule and carry out the recommended checks.
- Plan your journey and check the traffic before you set off. It is more efficient to combine errands into a single trip whenever possible.

- Avoid idling the engine in cold weather or for extended periods. Start the engine only when you are ready to set off.
- Do not carry unnecessary weight in your vehicle as extra weight wastes fuel.
- Do not add unnecessary accessories to the exterior of your vehicle, for example running boards. If you use a roof rack, remember to fold it down or remove it when not in use.
- Do not shift into neutral when you are braking or when your vehicle is slowing down.
- Shut all windows when driving at high speeds.
- Switch off all electric systems when not in use, for example air conditioning. Make sure that you unplug any accessories from the auxiliary power points when not in use.

## FLOOR MATS



**WARNING:** Use a floor mat designed to fit the footwell of your vehicle that does not obstruct the pedal area. Failure to follow this instruction could result in the loss of control of your vehicle, personal injury or death.



**WARNING:** Pedals that cannot move freely can cause loss of vehicle control and increase the risk of serious personal injury.



**WARNING:** Secure the floor mat to both retention devices so that it cannot slip out of position and interfere with the pedals. Failure to follow this instruction could result in the loss of control of your vehicle, personal injury or death.

## Driving Hints

---



**WARNING:** Do not place additional floor mats or any other covering on top of the original floor mats. This could result in the floor mat interfering with the operation of the pedals. Failure to follow this instruction could result in the loss of control of your vehicle, personal injury or death.



**WARNING:** Always make sure that objects cannot fall into the driver foot well while your vehicle is moving. Objects that are loose can become trapped under the pedals causing a loss of vehicle control.



To install the floor mats, position the floor mat eyelet over the retention post and press down to lock in position.

To remove the floor mat, reverse the installation procedure.

**Note:** *Regularly check the floor mats to make sure they are secure.*

# Roadside Emergencies

---

## ROADSIDE ASSISTANCE

### Vehicles Sold in the United States: Getting Roadside Assistance

To fully assist you should you have a vehicle concern, Ford Motor Company offers a complimentary roadside assistance program. This program is separate from the New Vehicle Limited Warranty.

The service is available:

- 24 hours a day, seven days a week.
- For the coverage period supplied with your vehicle.

Roadside Assistance covers:

- A flat tire change with a good spare (except vehicles supplied with a tire inflation kit).
- Battery jump start.
- Lock-out assistance (key replacement cost is the customer's responsibility).
- Fuel delivery — independent service contractors, if not prohibited by state, local or municipal law, shall deliver up to 2 gal (8 L) of gasoline or 5 gal (20 L) of diesel fuel to a disabled vehicle. Roadside Assistance limits fuel delivery service to two no-charge occurrences within a 12-month period.
- Winch out — available within 100 ft (30 m) of a paved or county maintained road, no recoveries.

- Towing — independent service contractors, if not prohibited by state, local or municipal law, shall tow Ford eligible vehicles to an authorized dealer within 35 mi (56 km) of the disablement location or to the nearest authorized dealer. If a member requests a tow to an authorized dealer that is more than 35 mi (56 km) from the disablement location, the member shall be responsible for any mileage costs in excess of 35 mi (56 km).
- Roadside Assistance includes up to \$200 for a towed trailer if the disabled eligible vehicle requires service at the nearest authorized dealer. If the towing vehicle is operational but the trailer is not, then the trailer does not qualify for any roadside services.

### Vehicles Sold in the United States: Using Roadside Assistance

Complete the roadside assistance identification card and place it in your wallet for quick reference. This card is in the Owner's Manual kit.

United States vehicle customers who require Roadside Assistance, call 1-800-241-3673.

If you need to arrange roadside assistance for yourself, Ford Motor Company reimburses a reasonable amount for towing to the nearest dealership within 35 mi (56 km). To obtain reimbursement information, United States vehicle customers call 1-800-241-3673. Customers need to submit their original receipts.

# Roadside Emergencies

## Vehicles Sold in Canada: Getting Roadside Assistance

To fully assist you should you have a vehicle concern, Ford Motor Company of Canada, Limited offers a complimentary roadside assistance program. This program is eligible within Canada or the continental United States.

The service is available 24 hours a day, seven days a week.

This program is separate from the New Vehicle Limited Warranty, but the coverage is concurrent with the powertrain coverage period of your vehicle. Canadian roadside coverage and benefits may differ from the U.S. coverage.

If you require more information, please call us in Canada at 1-800-665-2006, or visit our website at [www.ford.ca](http://www.ford.ca).

## HAZARD FLASHERS

**Note:** *The hazard flashers operate when the ignition is in any position, or if the key is not in the ignition. If used when the vehicle is not running, the battery loses charge. As a result, there may be insufficient power to restart your vehicle.*



The flasher control is on the instrument panel. Use your hazard flashers when your vehicle is creating a safety hazard for other motorists.

- Press the flasher control and all front and rear direction indicators flash.
- Press the button again to switch them off.

## FUEL SHUTOFF



**WARNING:** If your vehicle has been involved in a crash, have the fuel system checked. Failure to follow this instruction could result in fire, personal injury or death.

**Note:** *When you try to restart your vehicle after a fuel shutoff, the vehicle makes sure that various systems are safe to restart. Once the vehicle determines the systems are safe, then the vehicle allows you to restart.*

**Note:** *In the event that your vehicle does not restart after your third attempt, contact a qualified technician.*

The fuel pump shutoff stops the flow of fuel to the engine in the event of a moderate to severe crash. Not every impact causes a shutoff.

Should your vehicle shut off after a crash, you may restart your vehicle.

If your vehicle has a key system:

1. Switch off the ignition.
2. Switch to start position.
3. Switch off the ignition.
4. Switch on the ignition to re-enable the fuel pump.
5. If the vehicle does not start, repeat steps 1 through 4.

If your vehicle has a push button start system:

1. Press **START/STOP** to switch off your vehicle.
2. Press the brake pedal and **START/STOP** to switch on your vehicle.
3. Remove your foot from the brake pedal and press **START/STOP** to switch off your vehicle.

# Roadside Emergencies

4. You can attempt to start the vehicle by pressing the brake pedal and **START/STOP**, or press **START/STOP** without pressing the brake pedal.
5. If the vehicle does not start, repeat steps 1 through 4.

## JUMPSTARTING THE VEHICLE



**WARNING:** Keep batteries out of reach of children. Batteries contain sulfuric acid. Avoid contact with skin, eyes or clothing. Shield your eyes when working near the battery to protect against possible splashing of acid solution. In case of acid contact with skin or eyes, flush immediately with water for a minimum of 15 minutes and get prompt medical attention. If acid is swallowed, call a physician immediately.



**WARNING:** Batteries normally produce explosive gases which can cause personal injury. Therefore, do not allow flames, sparks or lighted substances to come near the battery. When working near the battery, always shield your face and protect your eyes. Always provide correct ventilation.



**WARNING:** Use only adequately sized cables with insulated clamps.

**Note:** Do not attempt to push-start an automatic transmission vehicle. This could cause transmission damage.

**Note:** Do not disconnect the battery of the disabled vehicle as this could damage the vehicle electrical system.

## To Connect the Booster Cables

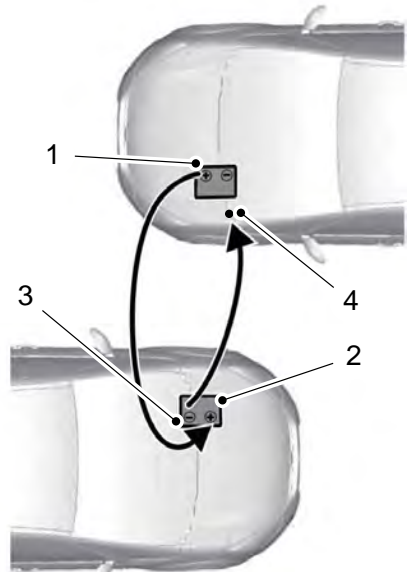

E142664

- 1 Flat battery vehicle.
- 2 Booster battery vehicle.
- 3 Positive connection cable.
- 4 Negative connection cable.



**WARNING:** If the engine is running while the hood is open, stay clear of moving engine components. Failure to follow this warning could result in serious personal injury or death.

Park the booster vehicle close to the hood of the disabled vehicle, making sure the two vehicles do not touch.

1. Switch off the engine and any electrical equipment.

# Roadside Emergencies

2. Connect the positive (+) jumper cable to the positive (+) terminal of the discharged battery.
3. Make the final connection of the negative (-) cable to the ground point.

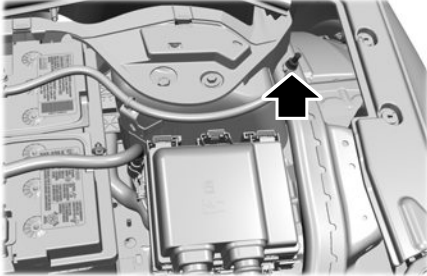

**WARNING:** Do not connect the negative jumper cable to any other part of your vehicle. Use the ground point.

## To Start the Engine

1. Start the engine of the booster vehicle and rev the engine moderately, or press the accelerator gently to keep your engine speed between 2000 and 3000 RPM, as shown in your tachometer
2. Start the engine of the disabled vehicle.
3. Once the disabled vehicle has been started, run both vehicle engines for an additional three minutes before disconnecting the jumper cables.

Remove the jumper cables in the reverse order that they were connected.

**Note:** Do not switch the headlamps on when disconnecting the cables. The peak voltage could blow the bulbs.

## POST-CRASH ALERT SYSTEM

The system flashes the direction indicators and sounds the horn (intermittently) in the event of a serious impact that deploys an airbag (front, side, side curtain or Safety Canopy) or the seatbelt pretensioners.

The horn and indicators turn off when:

- You press the hazard control button.
- You press the panic button on the remote entry transmitter (if equipped).
- Your vehicle runs out of power.
- Sounding of the horn is only enabled in specific markets.

## TRANSPORTING THE VEHICLE

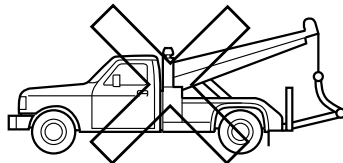
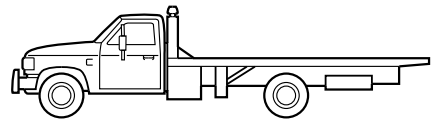
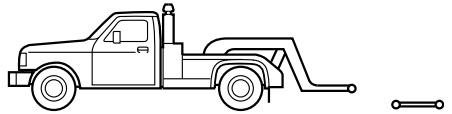



# Roadside Emergencies

---

If you need to have your vehicle towed, contact a professional towing service or, if you are a member of a roadside assistance program, your roadside assistance service provider.

We recommend the use of a wheel lift and dollies or flatbed equipment to tow your vehicle. Do not tow with a slingbelt. We do not approve a slingbelt towing procedure. Vehicle damage could occur if towed incorrectly, or by any other means.

We produce a towing manual for all authorized tow truck operators. Have your tow truck operator refer to this manual for proper hook-up and towing procedures for your vehicle.

Towing an all-wheel or four-wheel drive vehicle requires that all wheels be off the ground, such as using a wheel lift and dollies or flatbed equipment. This prevents damage to the transmission, all-wheel or four-wheel drive system and vehicle.

- Make sure the recovery strap is in good condition and free of visible cuts, tears or damage.
- Use a damper device such as a tarp, heavy blanket or piece of carpet draped over the recovery strap to help absorb the energy in the event the strap breaks.
- Make sure the stuck vehicle is not loaded heavier than its gross vehicle weight rating specified on the certification label.
- Always align the tow vehicle and stuck vehicle in a straight line within 10 degrees.
- Keep bystanders to the **sides** of the vehicle, at a distance of at least twice the length of the recovery strap. This helps avoid injury from the hazard of a recovery hook or strap breaking, or a vehicle lurching into their path.

## TOWING POINTS (IF EQUIPPED)

Your vehicle comes equipped with fixed front recovery hooks. These hooks should never have a load applied to them greater than the gross vehicle weight rating of your vehicle.

**Note:** *When recovering your vehicle, we recommend using both front hooks when possible to minimize damage to the vehicle.*

Before using recovery hooks:

- Make sure all attaching points are secure and capable of withstanding the applied load.
- Never use chains, cables or tow straps with metal hook ends.
- Only use recovery straps that have a minimum breaking strength two to three times the gross vehicle weight of the stuck vehicle.

# Customer Assistance

## GETTING THE SERVICES YOU NEED

Warranty repairs to your vehicle must be performed by an authorized dealer. While any authorized dealer handling your vehicle line will provide warranty service, we recommend you return to your selling authorized dealer who wants to ensure your continued satisfaction.

Please note that certain warranty repairs require special training and equipment, so not all authorized dealers are authorized to perform all warranty repairs. This means that, depending on the warranty repair needed, you may have to take your vehicle to another authorized dealer.

A reasonable time must be allowed to perform a repair after taking your vehicle to the authorized dealer. Repairs will be made using Ford or Motorcraft® parts, or remanufactured or other parts that are authorized by Ford.

### Away From Home

If you are away from home when your vehicle needs service, contact the Ford Customer Relationship Center or use the online resources listed below to find the nearest authorized dealer.

In the United States:

#### Mailing address

Ford Motor Company  
Customer Relationship Center  
P.O. Box 6248  
Dearborn, MI 48126

#### Telephone

1-800-392-3673 (FORD)  
(TDD for the hearing impaired:  
1-800-232-5952)

If your vehicle is configured as a motorhome please call 1-800-444-3311 for support.

Additional information and resources are available online:

Website
<a href="http://www.owner.ford.com">www.owner.ford.com</a>

These are some of the items that can be found online:

- U.S. dealer locator by Dealer Name, City/State or Zip Code.
- Owner Manuals.
- Maintenance Schedules.
- Recalls.
- Ford Extended Service Plans.
- Ford Genuine Accessories.
- Service specials and promotions.

In Canada:

#### Mailing address

Customer Relationship Centre  
Ford Motor Company of Canada, Limited  
P.O. Box 2000  
Oakville, Ontario L6K 0C8

#### Telephone

1-800-565-3673 (FORD)  
(TDD for the hearing impaired:  
1-888-658-6805)

Website
<a href="http://www.ford.ca">www.ford.ca</a>

#### Facebook

FordServiceCA (English)  
FordServiceQC (Français)

#### Twitter

@FordServiceCA

# Customer Assistance

---

## Additional Assistance

If you have questions or concerns, or are unsatisfied with the service you are receiving, follow these steps:

1. Contact your Sales Representative or Service Advisor at your selling or servicing authorized dealer.
2. If your inquiry or concern remains unresolved, contact the Sales Manager, Service Manager or Customer Relations Manager.
3. If you require assistance or clarification on Ford Motor Company policies, please contact the Ford Customer Relationship Center.

In order to help us serve you better, please have the following information available when contacting a Customer Relationship Center:

- Vehicle Identification Number.
- Your telephone number (home and business).
- The name of the authorized dealer and city where located.
- The vehicle's current odometer reading.

In some states within the United States, you must directly notify Ford in writing before pursuing remedies under your state's warranty laws, and Ford is also allowed a final repair attempt.

Additionally, in some states within the United States, a consumer has the option of submitting a warranty dispute to the BBB Auto Line before taking action under the Magnuson-Moss Warranty Act, or to the extent allowed by state law, before pursuing replacement or repurchase remedies provided by certain state laws. This dispute handling procedure is not required prior to enforcing state created rights or other rights which are independent of the Magnuson-Moss Warranty Act or state replacement or repurchase laws.

## IN CALIFORNIA (U.S. ONLY)

California Civil Code Section 1793.2(d) requires that, if a manufacturer or its representative is unable to repair a motor vehicle to conform to the vehicle's applicable express warranty after a reasonable number of attempts, the manufacturer shall be required to either replace the vehicle with one substantially identical or repurchase the vehicle and reimburse the buyer in an amount equal to the actual price paid or payable by the consumer (less a reasonable allowance for consumer use). The consumer has the right to choose whether to receive a refund or replacement vehicle.

California Civil Code Section 1793.22(b) presumes that the manufacturer has had a reasonable number of attempts to conform the vehicle to its applicable express warranties if, within the first 18 months of ownership of a new vehicle or the first 18,000 mi (29,000 km), whichever occurs first:

1. Two or more repair attempts are made on the same non-conformity likely to cause death or serious bodily injury OR
2. Four or more repair attempts are made on the same nonconformity (a defect or condition that substantially impairs the use, value or safety of the vehicle) OR
3. The vehicle is out of service for repair of nonconformities for a total of more than 30 calendar days (not necessarily all at one time).

In the case of 1 or 2 above, the consumer must also notify the manufacturer of the need for the repair of the nonconformity at the following address:

Ford Motor Company  
16800 Executive Plaza Drive  
Mail Drop 3NE-B  
Dearborn, MI 48126

# Customer Assistance

---

You are required to submit your warranty dispute to BBB AUTO LINE before asserting in court any rights or remedies conferred by California Civil Code Section 1793.22(b). You are also required to use BBB AUTO LINE before exercising rights or seeking remedies created by the Federal Magnuson-Moss Warranty Act, 15 U.S.C. sec. 2301 et seq. If you choose to seek redress by pursuing rights and remedies not created by California Civil Code Section 1793.22(b) or the Magnuson-Moss Warranty Act, resort to BBB AUTO LINE is not required by those statutes.

## **THE BETTER BUSINESS BUREAU (BBB) AUTO LINE PROGRAM (U.S. ONLY)**

Your satisfaction is important to Ford Motor Company and to your dealer. If a warranty concern has not been resolved using the three-step procedure outlined earlier in this chapter in the Getting the Services you need section, you may be eligible to participate in the BBB AUTO LINE program.

The BBB AUTO LINE program consists of two parts – mediation and arbitration. During mediation, a representative of the BBB will contact both you and Ford Motor Company to explore options for settlement of the claim. If an agreement is not reached during mediation or you do not want to participate in mediation, and if your claim is eligible, you may participate in the arbitration process. An arbitration hearing will be scheduled so that you can present your case in an informal setting before an impartial person. The arbitrator will consider the testimony provided and make a decision after the hearing.

Disputes submitted to the BBB AUTO LINE program are usually decided within forty days after you file your claim with the BBB. You are not bound by the decision, and may reject the decision and proceed to court where all findings of the BBB Auto Line dispute, and decision, are admissible in the court action. Should you choose to accept the BBB AUTO LINE decision, Ford is then bound by the decision, and must comply with the decision within 30 days of receipt of your acceptance letter.

**BBB AUTO LINE Application:** Using the information provided below, please call or write to request a program application. You will be asked for your name and address, general information about your new vehicle, information about your warranty concerns, and any steps you have already taken to try to resolve them. A Customer Claim Form will be mailed that will need to be completed, signed and returned to the BBB along with proof of ownership. Upon receipt, the BBB will review the claim for eligibility under the Program Summary Guidelines.

**You can get more information by calling BBB AUTO LINE at 1-800-955-5100, or writing to:**

**BBB AUTO LINE  
3033 Wilson Boulevard, Suite 600  
Arlington, Virginia 22201**

BBB AUTO LINE applications can also be requested by calling the Ford Motor Company Customer Relationship Center at 1-800-392-3673.

For additional information refer to the Better Business Bureau website.

**Note:** *Ford Motor Company reserves the right to change eligibility limitations, modify procedures, or to discontinue this process at any time without notice and without obligation.*

# Customer Assistance

---

## UTILIZING THE MEDIATION/ARBITRATION PROGRAM (CANADA ONLY)

For vehicles delivered to authorized Canadian dealers. In those cases where you continue to feel that the efforts by Ford of Canada and the authorized dealer to resolve a factory-related vehicle service concern have been unsatisfactory, Ford of Canada participates in an impartial third party mediation/arbitration program administered by the Canadian Motor Vehicle Arbitration Plan (CAMVAP).

The CAMVAP program is a straight forward and relatively speedy alternative to resolve a disagreement when all other efforts to produce a settlement have failed. This procedure is without cost to you and is designed to eliminate the need for lengthy and expensive legal proceedings.

In the CAMVAP program, impartial third-party arbitrators conduct hearings at mutually convenient times and places in an informal environment. These impartial arbitrators review the positions of the parties, make decisions and, when appropriate, render awards to resolve disputes. CAMVAP decisions are fast, fair, and final as the arbitrator's award is binding on both you and Ford of Canada.

CAMVAP services are available in all Canadian territories and provinces. For more information, without charge or obligation, call your CAMVAP Provincial Administrator directly at 1-800-207-0685 or visit [www.camvap.ca](http://www.camvap.ca).

## GETTING ASSISTANCE OUTSIDE THE U.S. AND CANADA

Before exporting your vehicle to a foreign country, contact the appropriate foreign embassy or consulate. These officials can inform you of local vehicle registration regulations and where to find unleaded fuel or petrol/gas engines or the proper sulfur fuel for diesel engines.

If you cannot find the proper fuel recommended for your vehicle, contact our Customer Relationship Center.

The use of improper fuels in your vehicle without proper conversion may damage the effectiveness of your emission control system and may cause engine knocking or serious engine damage. Ford Motor Company or Ford of Canada is not responsible for any damage caused by use of improper fuel. Using improper fuels may also result in difficulty importing your vehicle back into the United States.

If your vehicle must be serviced while you are traveling or living in Asia-Pacific Region, Sub-Saharan Africa, U.S. Virgin Islands and/or Puerto Rico, Central America, the Caribbean, and Israel and the Middle East, contact the nearest authorized dealer. If the authorized dealer cannot help you, contact the corresponding Ford Customer Assistance Center:

**FORD MOTOR COMPANY**  
**Customer Relationship Centers in:**

## Customer Assistance

Customer Relationship Center	Phone	Fax	E-mail
Asia Pacific	N/A	N/A	apemcrc@ford.com
Caribbean and Central America	+1-800-841-3673	N/A	atnclien@ford.com
Middle East	Ford 80004443673	971 4 3327 266	menacac@ford.com
	Lincoln 80004441067		
	UAE 80004441066		
	Saudi Arabia 8008443673		
	Mobily and Zain cell phone users in Saudi 800850078		
Kuwait 22280384			
North Africa	N/A	N/A	nafcrc@ford.com
Puerto Rico and U.S. Virgin Islands	+1-800-841-3673	N/A	atnclien@ford.com
Sub-Saharan Africa	N/A	N/A	ssacrc@ford.com
South Korea	+82-02-1600-6003	N/A	infokr1@ford.com or infokr@lincoln.com

If you buy your vehicle in North America and then relocate to any of the above locations, register your vehicle identification number (VIN) and new address with Ford Global Trade Services by emailing, [expcso@ford.com](mailto:expcso@ford.com).

If you are in another foreign country, contact the nearest authorized dealer. In the event your inquiry is unresolved, communicate your concern with the dealership's Sales Manager, Service Manager or Customer Relations Manager. If you require additional assistance or clarification, please contact the respective Customer Relationship Center as previously listed.

**Customers in the U.S. should call 1-800-392-3673.**

## Customer Assistance

---

### **ORDERING ADDITIONAL OWNER'S LITERATURE**

To order the publications in this portfolio, contact Helm, LLC at:

HELM, LLC  
47911 Halyard Drive, Suite 200  
Plymouth, Michigan 48170  
Attention: Customer Service

Or to order a free publication catalog, call toll free: 1-800-782-4356

Monday-Friday 8:00 a.m. - 6:00 p.m. EST

Helm, LLC can also be reached by their website:

[www.helminc.com](http://www.helminc.com)

(Items in this catalog may be purchased by credit card, check or money order.)

### **Obtaining a French Owner's Manual**

French Owner's Manual can be obtained from your authorized dealer or by contacting Helm, LLC using the contact information listed previously in this section.

### **REPORTING SAFETY DEFECTS (U.S. ONLY)**

If you believe that your vehicle has a defect which could cause a crash or could cause injury or death, you should immediately inform the National Highway Traffic Safety Administration (NHTSA) in addition to notifying Ford Motor Company.

If NHTSA receives similar complaints, it may open an investigation, and if it finds that a safety defect exists in a group of vehicles, it may order a recall and remedy campaign. However, NHTSA cannot become involved in individual problems between you, your dealer, or Ford Motor Company.

To contact NHTSA, you may call the Vehicle Safety Hotline toll-free at 1-888-327-4236 (TTY: 1-800-424-9153); go to [www.safercar.gov](http://www.safercar.gov); or write to:

Administrator

1200 New Jersey Avenue,  
Southeast

Washington, D.C. 20590

You can also obtain other information about motor vehicle safety from [www.safercar.gov](http://www.safercar.gov).

### **REPORTING SAFETY DEFECTS (CANADA ONLY)**

If you believe that your vehicle has a defect which could cause a crash or could cause injury or death, you should immediately inform Transport Canada and Ford of Canada.

# Customer Assistance

---

<b>Transport Canada Contact Information</b>	
Website	<a href="http://www.tc.gc.ca/eng/motorvehiclesafety/reporting-defects-motor-vehicles.html">http://www.tc.gc.ca/eng/motorvehiclesafety/reporting-defects-motor-vehicles.html</a> (English)
Website	<a href="http://www.tc.gc.ca/fra/securiteautomobile/signaler-defauts-vehicules-automobiles.html">http://www.tc.gc.ca/fra/securiteautomobile/signaler-defauts-vehicules-automobiles.html</a> (French)
Phone	1-800-333-0510

<b>Ford of Canada Contact Information</b>	
Website	<a href="http://www.ford.ca">www.ford.ca</a>
Phone	1-800-565-3673



# Fuses

## FUSE BOX LOCATIONS

### Engine Compartment Fuse Box

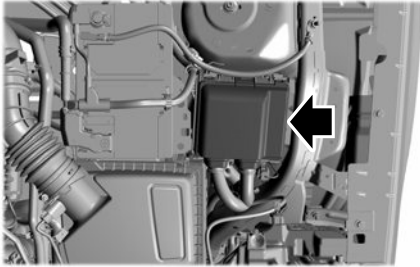

Remove the engine compartment fuse box to access the fuses. See **Changing a Fuse** (page 269).

### Passenger Compartment Fuse Box

The fuse box is below the glove compartment.

## FUSE SPECIFICATION CHART

### Engine Compartment Fuse Box



**WARNING:** Always disconnect the battery before servicing high current fuses.



**WARNING:** To reduce risk of electrical shock, always replace the cover to the power distribution box before reconnecting the battery or refilling fluid reservoirs.

The engine compartment fuse box is in the engine compartment. It has high-current fuses that protect your vehicle's main electrical systems from overloads.

When you disconnect and reconnect the battery, you need to reset some features. See **Changing the 12V Battery** (page 282).

Lift the release lever at the rear of the cover to remove it.

# Fuses

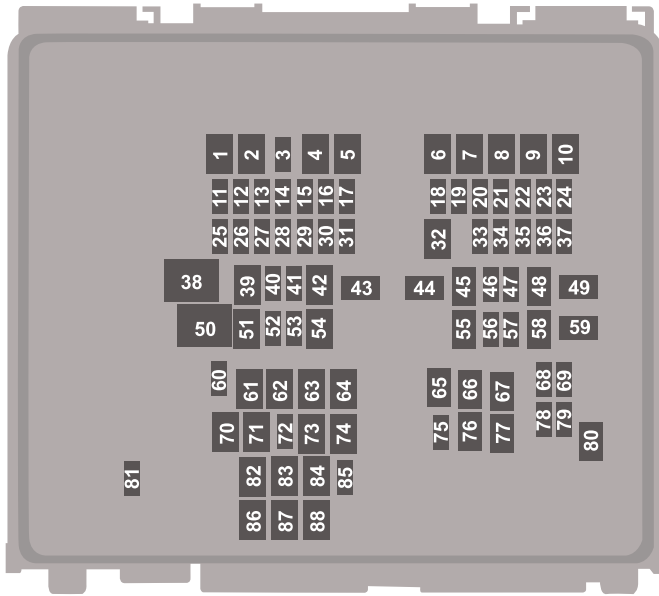

Fuse Location	Fuse Rating	Protected Component
1	30 A	Aftermarket auxiliary lighting.
2	—	Not used.
3	10 A	Windshield heated washer jets.
4	60 A	Supplemental heater.
5	40 A	Supplemental heater.
6	40 A	Supplemental heater.
7	20 A	Heated wiper park.
8	—	Not used.
9	60 A	Power inverter.
10	30 A	Starter motor.

# Fuses

<b>Fuse Location</b>	<b>Fuse Rating</b>	<b>Protected Component</b>
11	15 A	Powertrain control module.
12	15 A	Powertrain control module.
13	15 A	Powertrain control module.
14	15 A	Powertrain control module.
15	—	Not used.
16	—	Not used.
17	—	Not used.
18	10 A	Powertrain control module.
19	10 A	Anti-lock brake system module.
20	10 A	Data link connector.
21	5 A	Headlamp switch.
22	20 A	Amplifier.
23	—	Not used.
24	—	Not used.
25	25 A	Left-hand enhanced headlamps.
26	25 A	Right-hand enhanced headlamps.
27	—	Not used.
28	—	Not used.
29	—	Not used.
30	10 A	Electronic stability control.
31	5 A	Electronic power assist steering.
32	30 A	Body control module.
33	10 A	Front parking aid camera. Rear view camera. Blind spot information system. Gear shift actuator.
34	—	Not used.

# Fuses

<b>Fuse Location</b>	<b>Fuse Rating</b>	<b>Protected Component</b>
35	15 A	Heated steering wheel.
36	—	Not used.
37	20 A	Horn.
38	40 A	Blower motor.
39	—	Not used.
40	10 A	Brake on-off switch.
41	20 A	Amplifier.
42	30 A	Driver power seat.
43	40 A	Anti-lock brake system valves.
44	40 A	Trailer tow module.
45	30 A	Passenger power seat.
46	—	Not used.
47	20 A	Heated seats.
48	—	Not used.
49	60 A	Anti-lock brake system pump.
50	60 A	Cooling fan.
51	30 A	Moonroof.
52	5 A	USB smart charger.
53	—	Not used.
54	—	Not used.
55	—	Not used.
56	10 A	A/C clutch.
57	5 A	Flood light.
58	—	Not used.
59	40 A	Body control module.
60	5 A	USB smart charger.

# Fuses

<b>Fuse Location</b>	<b>Fuse Rating</b>	<b>Protected Component</b>
61	20 A	Auxiliary power point.
62	—	Not used.
63	—	Not used.
64	—	Not used.
65	—	Not used.
66	—	Not used.
67	—	Not used.
68	—	Not used.
69	15 A	Port fuel injectors.
70	20 A	Auxiliary power point.
71	20 A	Auxiliary power point.
72	20 A	Rear window wiper.
73	—	Not used.
74	30 A	Windshield wiper motor.
75	10 A	Heated exterior mirrors.
76	30 A	Heated rear window.
77	—	Not used.
78	15 A	Liftglass release.
79	—	Not used.
80	20 A	Fuel pump.
81	10 A	Rear window washer pump.
82	40 A	Power inverter.
83	—	Not used.
84	40 A	Driveline control module.
85	5 A	Rain sensor.
86	—	Not used.

# Fuses

Fuse Location	Fuse Rating	Protected Component
87	—	Not used.
88	—	Not used.

**Note:** Spare fuse amperage may vary.

## Passenger Compartment Fuse Box

The fuse box is below the glove compartment.

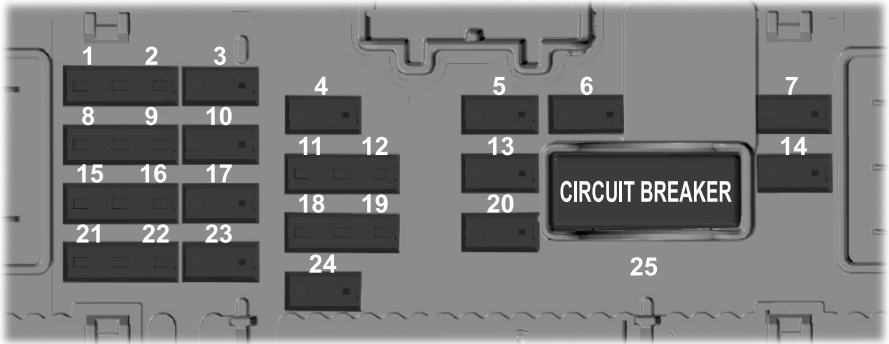

Fuse Location	Fuse Rating	Protected Component
1	5 A	Not used.
2	5 A	Not used.
3	10 A	Not used.
4	10 A	Ignition switch. Steering column lock.
5	20 A	Lock. Unlock.
6	10 A	DC-AC inverter.
7	30 A	Passenger door module.

## Fuses

Fuse Location	Fuse Rating	Protected Component
8	5 A	Parking assist control module.
9	5 A	Auto-dimming interior mirror. Lane keeping system. Passenger airbag deactivation indicator.
10	10 A	Extended power module.
11	5 A	Telematics control unit module.
12	5 A	Keyless keypad switch.
13	15 A	Driver door unlock.
14	30 A	Driver door module.
15	15 A	Not used (spare).
16	15 A	Not used (spare).
17	15 A	SYNC. Receiver transceiver module. Integrated control panel.
18	7.5 A	Wireless accessory charging module. All terrain control module.
19	7.5 A	Not used (spare).
20	10 A	Not used (spare).
21	7.5 A	Not used (spare).
22	7.5 A	Not used (spare).
23	20 A	Not used (spare).
24	20 A	Not used (spare).
25	30 A	Not used (spare).

**Note:** Spare fuse amperage may vary.

# Fuses

## CHANGING A FUSE

### General Information

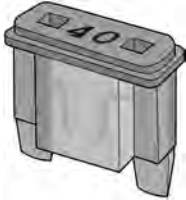

E217331

If electrical components in the vehicle are not working, a fuse may have blown. Blown fuses are identified by a broken wire within the fuse.

### Engine Compartment Fuse Box



**WARNING:** Always replace a fuse with one that has the specified amperage rating. Using a fuse with a higher amperage rating can cause severe wire damage and could start a fire.



E253688

1. Pull the latch toward you and remove the top cover.

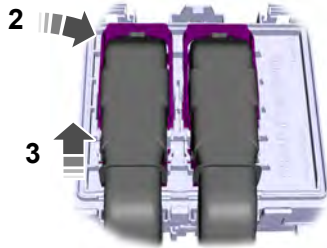

E253689

2. Pull the connector lever upward.
3. Pull the connector upward to remove it.

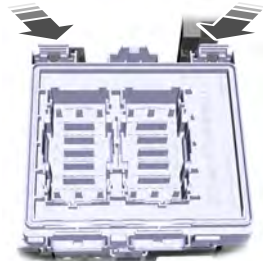

E253693

4. Pull both latches toward you and remove the fuse box.
5. Turn the fuse box over and open the lid.



# Fuses

---

## Fuse Types

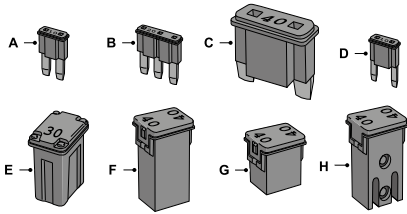

- A Micro 2.
- B Micro 3.
- C Maxi.
- D Mini.
- E M Case.
- F J Case.
- G J Case Low Profile.
- H Slotted M Case.

# Maintenance

## GENERAL INFORMATION

Have your vehicle serviced regularly to help maintain its roadworthiness and resale value. There is a large network of authorized dealers that are there to help you with their professional servicing expertise. We believe that their specially trained technicians are best qualified to service your vehicle properly and expertly. They are supported by a wide range of highly specialized tools developed specifically for servicing your vehicle.

If your vehicle requires professional service, an authorized dealer can provide the necessary parts and service. Check your warranty information to find out which parts and services are covered.

Use only recommended fuels, lubricants, fluids and service parts conforming to specifications. Motorcraft® parts are designed and built to provide the best performance in your vehicle.

## Precautions

- Do not work on a hot engine.
- Make sure that nothing gets caught in moving parts.
- Do not work on a vehicle with the engine running in an enclosed space, unless you are sure you have enough ventilation.
- Keep all open flames and other burning material (such as cigarettes) away from the battery and all fuel related parts.

## Working with the Engine Off

1. Set the parking brake and shift the transmission to park (P).
2. Switch off the engine.
3. Block the wheels.

## Working with the Engine On

**WARNING:** To reduce the risk of vehicle damage and personal burn injuries, do not start your engine with the air cleaner removed and do not remove it while the engine is running.

1. Set the parking brake and shift the transmission to park (P).
2. Block the wheels.

## OPENING AND CLOSING THE HOOD

### Opening the Hood

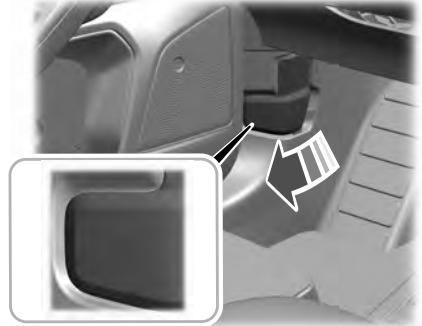

E263274

1. Open the left-hand front door.
2. Fully pull the hood release lever and let it completely retract.

**Note:** This action releases the hood latch.

3. Fully pull the hood release lever for a second time.

**Note:** This action fully releases the hood.

4. Open the hood.

**Note:** There is no secondary latch under the hood.

# Maintenance

## Closing the Hood



**WARNING:** Make sure that you fully latch the hood before driving. Failure to

follow this instruction could result in personal injury or death.

1. Lower the hood and allow it to drop under its own weight for the last 10–14 in (25–35 cm).

## UNDER HOOD OVERVIEW - 1.5L ECOBOOST™

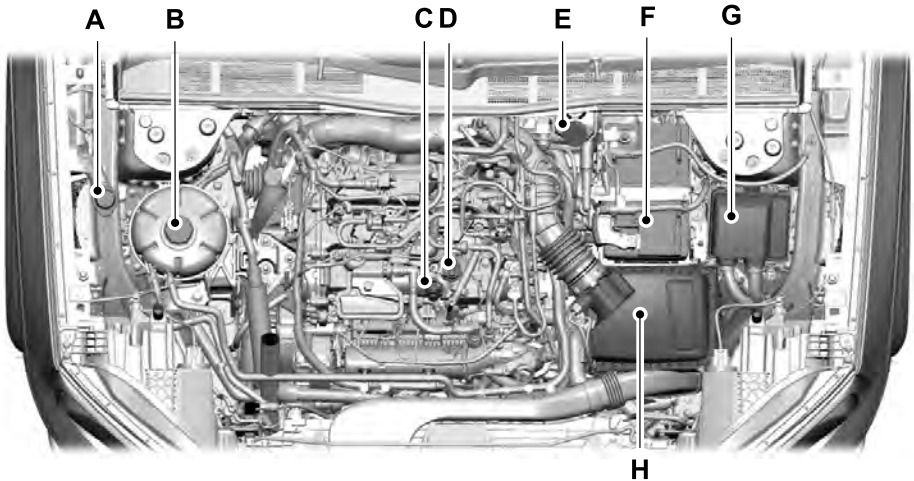

- A Windshield washer fluid reservoir. See **Washer Fluid Check** (page 285).
- B Engine coolant reservoir. See **Engine Coolant Check** (page 277).
- C Engine oil dipstick. See **Engine Oil Dipstick** (page 274).
- D Engine oil filler cap. See **Engine Oil Check** (page 274).
- E Brake fluid reservoir. See **Brake Fluid Check** (page 281).
- F Battery. See **Changing the 12V Battery** (page 282).
- G Power distribution box. See **Changing a Fuse** (page 269).
- H Air filter assembly. See **Changing the Engine Air Filter** (page 276).

# Maintenance

## UNDER HOOD OVERVIEW - 2.0L ECOBOOST™

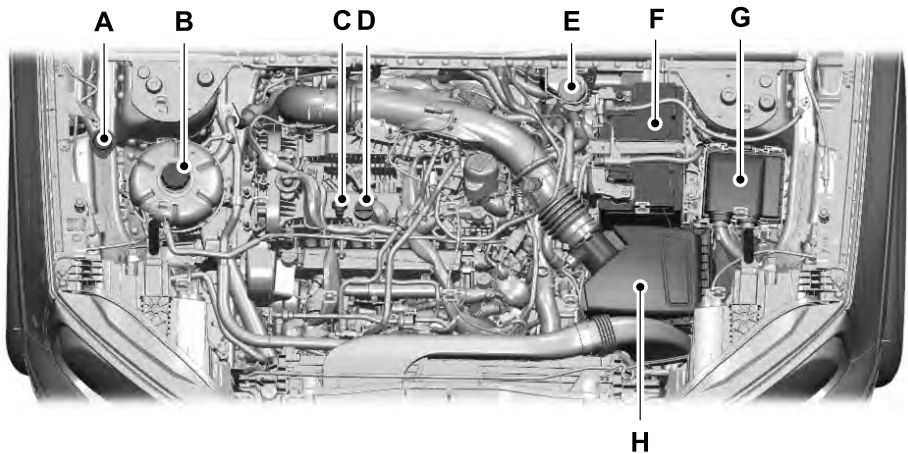

- A Windshield washer fluid reservoir. See **Washer Fluid Check** (page 285).
- B Engine coolant reservoir. See **Engine Coolant Check** (page 277).
- C Engine oil dipstick. See **Engine Oil Dipstick** (page 274).
- D Engine oil filler cap. See **Engine Oil Check** (page 274).
- E Brake fluid reservoir. See **Brake Fluid Check** (page 281).
- F Battery. See **Changing the 12V Battery** (page 282).
- G Power distribution box. See **Changing a Fuse** (page 269).
- H Air filter assembly. See **Changing the Engine Air Filter** (page 276).

# Maintenance

## ENGINE OIL DIPSTICK

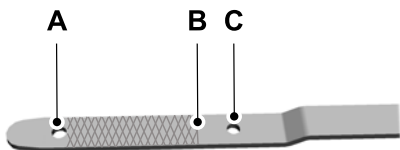

- A Minimum.
- B Nominal.
- C Maximum.

## ENGINE OIL CHECK

To check the engine oil level consistently and accurately, do the following:

1. Make sure the parking brake is on. Make sure the transmission is in park (P) or neutral (N).
2. Run the engine until it reaches normal operating temperature.
3. Make sure that your vehicle is on level ground.
4. Switch the engine off and wait 15 minutes for the oil to drain into the oil pan. Checking the engine oil level too soon after you switch the engine off may result in an inaccurate reading.
5. Open the hood. See **Opening and Closing the Hood** (page 271).
6. Remove the dipstick and wipe it with a clean, lint-free cloth. See **Under Hood Overview** (page 272).

7. Reinstall the dipstick and remove it again to check the oil level. See **Under Hood Overview** (page 272).
8. Make sure that the oil level is between the maximum and minimum marks. If the oil level is at the minimum mark, add oil immediately. See **Engine Oil Capacity and Specification** (page 329).
9. If the oil level is correct, replace the dipstick and make sure it is fully seated.

**Note:** Do not remove the dipstick when the engine is running.

**Note:** If the oil level is between the maximum and minimum marks, the oil level is acceptable. Do not add oil.

**Note:** The oil consumption of new engines reaches its normal level after approximately 3,000 ml (5,000 km).

## Adding Engine Oil



**WARNING:** Do not remove the filler cap when the engine is running.

Do not use supplemental engine oil additives because they are unnecessary and could lead to engine damage that may not be covered by the vehicle Warranty.



# Maintenance

Only use oils certified for gasoline engines by the American Petroleum Institute (API). An oil with this trademark symbol conforms to the current engine and emission system protection standards and fuel economy requirements of the International Lubricants Specification Advisory Committee (ILSAC).

To top up the engine oil level do the following:

1. Clean the area surrounding the engine oil filler cap before you remove it.
2. Remove the engine oil filler cap. See **Under Hood Overview** (page 272). Turn it counterclockwise and remove it.
3. Add engine oil that meets our specifications. See **Engine Oil Capacity and Specification** (page 329). You may have to use a funnel to pour the engine oil into the opening.
4. Recheck the oil level.
5. If the oil level is correct, replace the dipstick and make sure it is fully seated.
6. Replace the engine oil filler cap. Turn it clockwise until you feel a strong resistance.

**Note:** Do not add oil further than the maximum mark. Oil levels above the maximum mark may cause engine damage.

**Note:** Make sure you install the oil filler cap correctly.

**Note:** Soak up any spillage with an absorbent cloth immediately.

## OIL CHANGE INDICATOR RESET

Use the information display controls on the steering wheel to reset the oil change indicator.

### From the main menu scroll to:

Message	Action and description
Settings	Press the right arrow button, then from this menu scroll to the following message.
Vehicle	Press the right arrow button, then from this menu scroll to the following message.
Oil Life	Press the right arrow button, then from this menu scroll to the following message.
Hold OK to Reset	Press and hold the <b>OK</b> button until the instrument cluster displays the following message.
	Reset Successful
	When the oil change indicator resets the instrument cluster displays 100%. Remaining Life {00}%
	If the instrument cluster displays one of the following messages, repeat the process. Not Reset Reset Cancelled

# Maintenance

## CHANGING THE ENGINE AIR FILTER



**WARNING:** To reduce the risk of vehicle damage and personal burn injuries, do not start your engine with the air cleaner removed and do not remove it while the engine is running.

When changing the air filter element, use only parts that meet or exceed our specifications.

For EcoBoost equipped vehicles: When servicing the air cleaner, it is important that no foreign material enter the air induction system. The engine and turbocharger are susceptible to damage from even small particles.

Change the air filter element at the proper interval. See **Scheduled Maintenance** (page 396).

**Note:** Failure to use the correct air filter element may result in severe engine damage. The customer warranty may be void for any damage to the engine if the correct air filter element is not used.

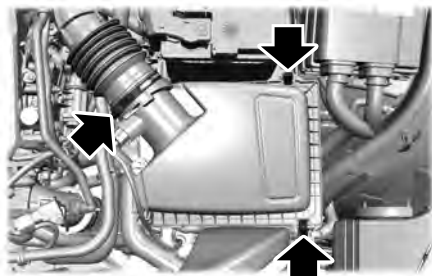

1. Using a screwdriver, loosen the clamp on the air filter housing cover.
2. Gently pull the boot back away from the air filter housing cover.

3. Release the two clips from the air filter housing cover.
4. Remove the air filter housing cover.
5. Remove the air filter element from the air filter housing.
6. Wipe any dirt or debris from the air filter housing assembly to make sure no dirt gets in the engine and to make sure you have a good seal.

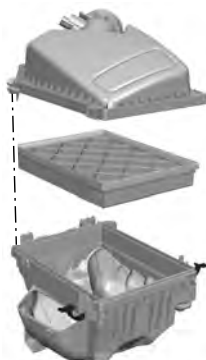

7. Install a new air filter element. Be careful not to crimp the filter element edges between the air filter housing and cover. This could cause filter damage and allow unfiltered air to enter the engine if it is not properly seated.
8. Install the air filter housing cover.
9. Engage the clips to secure the air filter housing cover to the air filter housing.
10. Reconnect the boot to the air filter housing cover and tighten securely.

# Maintenance

## ENGINE COOLANT CHECK



**WARNING:** Do not remove the coolant reservoir cap when the engine is on or the cooling system is hot. Wait 10 minutes for the cooling system to cool down. Cover the coolant reservoir cap with a thick cloth to prevent the possibility of scalding and slowly remove the cap. Failure to follow this instruction could result in personal injury.



**WARNING:** To reduce the risk of personal injury, make sure the engine is cool before unscrewing the coolant pressure relief cap. The cooling system is under pressure. Steam and hot liquid can come out forcefully when you loosen the cap slightly.



**WARNING:** Do not add coolant further than the **MAX** mark.

When the engine is cold, check the concentration and level of the coolant at the intervals listed in the scheduled maintenance information. See **Scheduled Maintenance** (page 396).

**Note:** Make sure that the coolant level is between the **MIN** and the **MAX** marks on the coolant reservoir.

**Note:** Coolant expands when it is hot. The level may extend beyond the **MAX** mark.

Maintain coolant concentration within 48% to 50%, which equates to a freeze point between -29°F (-34°C) and -35°F (-37°C). Coolant concentration should be checked using a refractometer. We do not recommend the use of hydrometers or coolant test strips for measuring coolant concentration.

## Adding Coolant



**WARNING:** Do not remove the coolant reservoir cap when the engine is on or the cooling system is hot. Wait 10 minutes for the cooling system to cool down. Cover the coolant reservoir cap with a thick cloth to prevent the possibility of scalding and slowly remove the cap. Failure to follow this instruction could result in personal injury.



**WARNING:** Do not add engine coolant when the engine is on or the cooling system is hot. Failure to follow this instruction could result in personal injury.



**WARNING:** Do not put coolant in the windshield washer reservoir. If sprayed on the windshield, coolant could make it difficult to see through the windshield.

**Note:** Automotive fluids are not interchangeable. Take care not to put engine coolant in the windshield washer fluid reservoir or windshield washer fluid in the engine coolant reservoir.

**Note:** Do not use stop leak pellets, cooling system sealants, or non-specified additives as they can cause damage to the engine cooling or heating systems. Resulting component damage may not be covered by the vehicle Warranty.

It is very important to use prediluted coolant approved to the correct specification in order to avoid plugging the small passageways in the engine cooling system. See **Capacities and Specifications** (page 323). Do not mix different colors or types of coolant in your vehicle. Mixing of engine coolants or using an incorrect coolant may harm the engine or cooling system components and may not be covered by the vehicle warranty.



# Maintenance

---

**Note:** If prediluted coolant is not available, use the approved concentrated coolant diluting it to 50/50 with distilled water. See **Capacities and Specifications** (page 323).

Using water that has not been deionized may contribute to deposit formation, corrosion and plugging of the small cooling system passageways.

**Note:** Coolants marketed for all makes and models may not be approved to our specifications and may cause damage to the cooling system. Resulting component damage may not be covered by the vehicle Warranty.

If the coolant level is at or below the minimum mark, add prediluted coolant immediately.

To top up the coolant level do the following:

1. Unscrew the cap slowly. Any pressure escapes as you unscrew the cap.
2. Add prediluted coolant approved to the correct specification. See **Capacities and Specifications** (page 323).
3. Add enough prediluted coolant to reach the correct level.
4. Replace the coolant reservoir cap. Turn the cap clockwise until it contacts the hard stop.
5. Check the coolant level in the coolant reservoir the next few times you drive your vehicle. If necessary, add enough prediluted engine coolant to bring the coolant level to the correct level.

If you have to add more than 1.1 qt (1 L) of engine coolant per month, have your vehicle checked as soon as possible. Operating an engine with a low level of coolant can result in engine overheating and possible engine damage.

In case of emergency, you can add a large amount of water without engine coolant in order to reach a vehicle service location. In this instance, qualified personnel:

1. Must drain the cooling system.
2. Chemically clean the coolant system.
3. Refill with engine coolant as soon as possible.

Water alone, without engine coolant, can cause engine damage from corrosion, overheating or freezing.

Do not use the following as a coolant substitute:

- Alcohol.
- Methanol.
- Brine.
- Any coolant mixed with alcohol or methanol antifreeze.

Alcohol and other liquids can cause engine damage from overheating or freezing.

Do not add extra inhibitors or additives to the coolant. These can be harmful and compromise the corrosion protection of the coolant.

## Recycled Coolant

We do not recommend the use of recycled coolant as an approved recycling process is not yet available.

Dispose of used engine coolant in an appropriate manner. Follow your community's regulations and standards for recycling and disposing of automotive fluids.

# Maintenance

## Severe Climates

If you drive in extremely cold climates:

- It may be necessary to increase the coolant concentration above 50%.
- A coolant concentration of 60% provides improved freeze point protection. Coolant concentrations above 60% decrease the overheat protection characteristics of the coolant and may cause engine damage.

If you drive in extremely hot climates:

- You can decrease the coolant concentration to 40%.
- Coolant concentrations below 40% decrease the freeze and corrosion protection characteristics of the coolant and may cause engine damage.

Vehicles driven year-round in non-extreme climates should use prediluted coolant for optimum cooling system and engine protection.

## Coolant Change

At specific mileage intervals, as listed in the scheduled maintenance information, the coolant should be changed. Add prediluted coolant approved to the correct specification. See **Capacities and Specifications** (page 323).

## Fail-Safe Cooling

Fail-safe cooling allows you to temporarily drive your vehicle before any incremental component damage occurs. The fail-safe distance depends on ambient temperature, vehicle load and terrain.

## How Fail-Safe Cooling Works



If the engine begins to overheat, the coolant temperature gauge moves toward the red zone.



A warning lamp illuminates, and a message may appear in the information display.

If the engine reaches a preset over-temperature condition, the engine automatically switches to alternating cylinder operation. Each disabled cylinder acts as an air pump and cools the engine.

When this occurs, your vehicle still operates, however:

- Engine power is limited.
- The air conditioning system turns off.

Continued operation increases the engine temperature, causing the engine to completely shut down. Your steering and braking effort increases in this situation.

When the engine temperature cools, you can re-start the engine. Have your vehicle checked as soon as possible to minimize engine damage.

## When Fail-Safe Mode Is Activated



**WARNING:** Fail-safe mode is for use during emergencies only. Operate your vehicle in fail-safe mode only as long as necessary to bring your vehicle to rest in a safe location and seek immediate repairs. When in fail-safe mode, your vehicle will have limited power, will not be able to maintain high-speed operation, and may completely shut down without warning, potentially losing engine power, power steering assist, and power brake assist, which may increase the possibility of a crash resulting in serious injury.

# Maintenance



**WARNING:** Do not remove the coolant reservoir cap when the engine is on or the cooling system is hot. Wait 10 minutes for the cooling system to cool down. Cover the coolant reservoir cap with a thick cloth to prevent the possibility of scalding and slowly remove the cap. Failure to follow this instruction could result in personal injury.

Your vehicle has limited engine power when in the fail-safe mode, drive your vehicle with caution. Your vehicle does not maintain high-speed operation and the engine may operate poorly.

Remember that the engine is capable of automatically shutting down to prevent engine damage. In this situation:

1. Pull off the road as soon as safely possible and switch the engine off.
2. If you are a member of a roadside assistance program, we recommend that you contact your roadside assistance service provider.
3. If this is not possible, wait a short period for the engine to cool.
4. Check the coolant level. If the coolant level is at or below the minimum mark, add prediluted coolant immediately.
5. When the engine temperature cools, you can re-start the engine. Have your vehicle checked as soon as possible to minimize engine damage.

**Note:** *Driving your vehicle without repair increases the chance of engine damage.*

## Engine Coolant Temperature Management (If Equipped)



**WARNING:** To reduce the risk of crash and injury, be prepared that the vehicle speed may reduce and the vehicle may not be able to accelerate with full power until the coolant temperature reduces.

If you tow a trailer with your vehicle, the engine may temporarily reach a higher temperature during severe operating conditions, for example ascending a long or steep slope in high ambient temperatures.

At this time, you may notice the coolant temperature gauge moves toward the red zone and a message may appear in the information display.

You could notice a reduction in vehicle speed caused by reduced engine power in order to manage the engine coolant temperature. Your vehicle could enter this mode if certain high-temperature and high-load conditions take place. The amount of speed reduction depends on vehicle loading, slope and ambient temperature. If this occurs, there is no need to stop your vehicle. You can continue to drive.

The air conditioning may turn on and off during severe operating conditions to protect the engine from overheating. When the coolant temperature decreases to the normal operating temperature, the air conditioning turns on.

If the coolant temperature gauge moves fully into the red zone, or if the coolant temperature warning or service engine soon messages appear in your information display, do the following:

# Maintenance

1. Stop your vehicle as soon as it is safe to do so. Fully apply the parking brake, shift into park (P) or neutral (N).
2. Leave the engine running until the coolant temperature gauge needle returns to the normal position. If the temperature does not drop after several minutes, follow the remaining steps.
3. Switch the engine off and wait for it to cool. Check the coolant level.
4. If the coolant level is at or below the minimum mark, add prediluted coolant immediately.
5. If the coolant level is normal, restart the engine and continue.

## AUTOMATIC TRANSMISSION FLUID CHECK

The automatic transmission does not have a transmission fluid dipstick.

Have an authorized dealer check and change the transmission fluid at the correct service interval. See **Scheduled Maintenance** (page 396). Your transmission does not consume fluid. However, if the transmission slips, shifts slowly or if you notice a sign of leaking fluid, contact an authorized dealer.

Do not use supplemental transmission fluid additives, treatments or cleaning agents. The use of these materials may affect transmission operation and result in damage to internal transmission components.

## BRAKE FLUID CHECK (IF EQUIPPED)

 **WARNING:** Do not use any fluid other than the recommended brake fluid as this will reduce brake efficiency. Use of incorrect fluid could result in the loss of vehicle control, serious personal injury or death.

 **WARNING:** Only use brake fluid from a sealed container. Contamination with dirt, water, petroleum products or other materials may result in brake system damage or failure. Failure to adhere to this warning could result in the loss of vehicle control, serious personal injury or death.

 **WARNING:** Do not allow the fluid to touch your skin or eyes. If this happens, rinse the affected areas immediately with plenty of water and contact your physician.

 **WARNING:** The brake system could be affected if the brake fluid level is below the **MIN** mark or above the **MAX** mark on the brake fluid reservoir.

**Note:** *A fluid level between the MAX and MIN lines is within the normal operating range and there is no need to add fluid. A fluid level not in the normal operating range could compromise the performance of the system. Have the system checked as soon as possible by an authorized dealer.*

# Maintenance



To avoid fluid contamination, the reservoir cap must remain in place and fully tight, unless you are adding fluid.

Only use fluid that meets our specifications. See **Capacities and Specifications** (page 335).

## Brake Fluid Service Interval

Brake fluid absorbs water over time which degrades the effectiveness of the brake fluid. Change brake fluid at the specified intervals to prevent degraded braking performance.

For detailed interval information, see Scheduled Maintenance in your Owner's Manual or your local maintenance guide.

## POWER STEERING FLUID CHECK

Your vehicle is equipped with an electric power steering (EPS) system. There is no fluid reservoir to check or fill.

## CHANGING THE 12V BATTERY

 **WARNING:** Batteries normally produce explosive gases which can cause personal injury. Therefore, do not allow flames, sparks or lighted substances to come near the battery. When working near the battery, always shield your face and protect your eyes. Always provide correct ventilation.

 **WARNING:** When lifting a plastic-cased battery, excessive pressure on the end walls could cause acid to flow through the vent caps, resulting in personal injury and damage to the vehicle or battery. Lift the battery with a battery carrier or with your hands on opposite corners.

 **WARNING:** Keep batteries out of reach of children. Batteries contain sulfuric acid. Avoid contact with skin, eyes or clothing. Shield your eyes when working near the battery to protect against possible splashing of acid solution. In case of acid contact with skin or eyes, flush immediately with water for a minimum of 15 minutes and get prompt medical attention. If acid is swallowed, call a physician immediately.

 **WARNING:** Battery posts, terminals and related accessories contain lead and lead compounds, chemicals known to the State of California to cause cancer and reproductive harm. **Wash your hands after handling.**

 **WARNING:** For vehicles with Auto-Start-Stop the battery requirement is different. You must replace the battery with one of exactly the same specification.

# Maintenance

---

The battery is in the engine compartment. See **Under Hood Overview** (page 272).

Your vehicle has a maintenance-free battery. It does not require additional water during service.

If the vehicle battery has a cover, make sure you correctly install it after cleaning or replacing the battery.

For longer, trouble-free operation, keep the top of the battery clean and dry and the battery cables tightly fastened to the battery terminals. If any corrosion is present on the battery or terminals, remove the cables from the terminals and clean with a wire brush. You can neutralize the acid with a solution of baking soda and water.

We recommend that you disconnect the negative battery cable terminal from the battery if you plan to store your vehicle for an extended period.

**Note:** *If you only disconnect the negative battery cable terminal, make sure it is isolated or placed away from the battery terminal to avoid unintended connection or arcing.*

To maintain correct operation of the battery management system, if you add any electrical devices to your vehicle, do not connect the ground connection directly to the negative battery terminal. A connection at the negative battery terminal can cause inaccurate measurements of the battery condition and potential incorrect system operation.

**Note:** *If you add electrical accessories or components to your vehicle this may adversely affect battery performance, durability and the performance of other electrical systems on your vehicle.*

If you replace the battery make sure it matches the electrical requirements of your vehicle.

If you disconnect or replace the battery and your vehicle has an automatic transmission, it must relearn its adaptive strategy. Because of this, the transmission may shift firmly when first driven. This is normal operation while the transmission fully updates its operation to optimum shift feel.

## Remove and Reinstall the Battery

To disconnect or remove the battery, do the following:

1. Apply the parking brake and switch the ignition off.
2. Switch all electrical equipment off, for example lights and radio.
3. Wait a minimum of two minutes before disconnecting the battery.

**Note:** *The engine management system has a power hold function and remains powered for a period of time after you switch the ignition off. This is to allow diagnostic and adaptive tables to be stored. Disconnecting the battery without waiting can cause damage not covered by the vehicle Warranty.*

4. Disconnect the negative battery cable terminal.
5. Disconnect the positive battery cable terminal.
6. Remove the battery securing clamp.
7. Remove the battery.
8. To install, reverse the removal procedure.

**Note:** *Before reconnecting the battery, make sure the ignition remains switched off.*

**Note:** *Make sure the battery cable terminals are fully tightened.*

# Maintenance

If you disconnect or replace the vehicle battery, you must reset the following features:

- Window bounce-back.
- Clock Settings.
- Pre-set radio stations.
- Steering Angle Sensor.

**Note:** To calibrate the steering angle sensor, drive the vehicle above 30 mph (50 km/h) for a minimum of 1.2 mi (2 km). Make sure to drive straight ahead for a minimum of 30 seconds. Several vehicle functions are disabled and a warning light could appear until the sensor is calibrated.

**Note:** For flexible fuel vehicles, if you are operating on E85, you could experience poor starts or an inability to start the engine, and driveability problems until the fuel trim and ethanol content have been relearned. Drive the vehicle at least 10 mi (16 km) to completely relearn the idle trim and fuel trim strategy.

## Battery Disposal



Make sure that you dispose of old batteries in an environmentally friendly way.

Seek advice from your local authority about recycling old batteries.

## ADJUSTING THE HEADLAMPS

### Vertical Aim Adjustment

The headlamps on your vehicle are properly aimed at the assembly plant. If your vehicle has been in an accident, have the alignment of your headlamps checked by your authorized dealer.

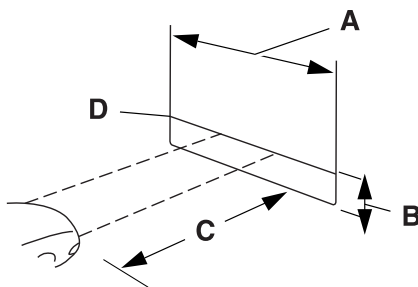

- A 8 feet (2.4 meters)
- B Center height of lamp to ground
- C 25 feet (7.6 meters)
- D Horizontal reference line

1. Park the vehicle directly in front of a wall or screen on a level surface, approximately 25 ft (7.6 m) away.
  2. Measure the height of the headlamp center from the ground and mark an 8 ft (2.4 m) horizontal reference line on the vertical wall or screen at this height.
- Note:** To see a clearer light pattern for adjusting, you may want to block the light from one headlamp when adjusting the other.
3. Switch on the low beam headlamps to illuminate the wall or screen and open the hood.

# Maintenance

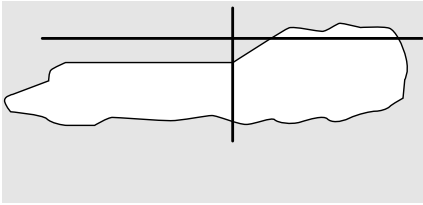

E142466

4. There is a distinct cut-off, or change from light to dark, in the left portion of the beam pattern. Position the top edge of this cut-off at the horizontal reference plane.

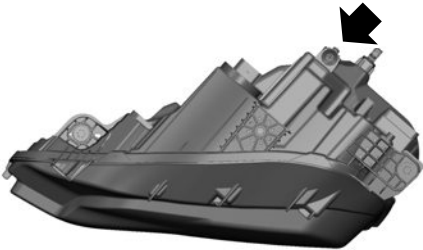

5. Locate the vertical adjuster on each headlamp. Using a Phillips #2 screwdriver, turn the adjuster either clockwise or counterclockwise to aim the headlamp.
6. Close the hood and switch off the lamps.

## Horizontal Aim Adjustment

Horizontal aim is not required for this vehicle and is non-adjustable.

## WASHER FLUID CHECK

**WARNING:** If you operate your vehicle in temperatures below 41.0°F (5°C), use washer fluid with antifreeze protection. Failure to use washer fluid with antifreeze protection in cold weather could result in impaired windshield vision and increase the risk of injury or accident.

**Note:** *The front and rear washer systems are supplied from the same reservoir.*

Add fluid to fill the reservoir if the level is low. Only use a washer fluid that meets our specifications. See **Capacities and Specifications** (page 334).

State or local regulations on volatile organic compounds may restrict the use of methanol, a common windshield washer antifreeze additive. Washer fluids containing non-methanol antifreeze agents should be used only if they provide cold weather protection without damaging the vehicle's paint finish, wiper blades or washer system.

## FUEL FILTER

Your vehicle is equipped with a lifetime fuel filter that is integrated with the fuel tank. Regular maintenance or replacement is not needed.



# Maintenance

## CHECKING THE WIPER BLADES



Run the tip of your fingers over the edge of the blade to check for roughness.

Clean the wiper blades with washer fluid or water applied with a soft sponge or cloth.

## CHANGING THE FRONT WIPER BLADES

1. Fully lift the wiper arm.

**Note:** Do not hold the wiper blade to lift the wiper arm.

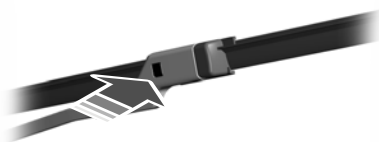

E264374

2. Press the wiper blade locking button.

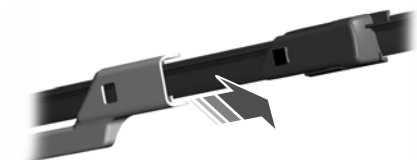

E264375

3. Remove the wiper blade.

**Note:** Make sure that the wiper arm does not spring back against the glass when the wiper blade is not attached.

4. To install, reverse the removal procedure.

**Note:** Make sure that the wiper blade locks into place.

## CHANGING THE REAR WIPER BLADES

1. Lift the wiper arm.

**Note:** Do not hold the wiper blade to lift the wiper arm.

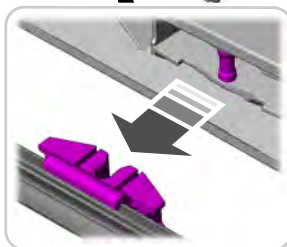
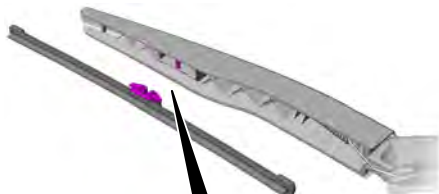

E183236

# Maintenance

2. Disengage the wiper blade from the wiper arm.

**Note:** Make sure that the wiper arm does not spring back against the glass when the wiper blade is not attached.

3. To install, reverse the removal procedure.

**Note:** Make sure that the wiper blade locks into place.

## CHANGING A BULB

### Replacing Headlamp Bulbs

Headlamp bulbs are LED and are not serviceable. See an authorized dealer if they fail.

### Replacing Fog Lamp Bulbs

Fog lamp bulbs are LED and are not serviceable. See an authorized dealer if they fail.

### Replacing Turn Signal Lamps

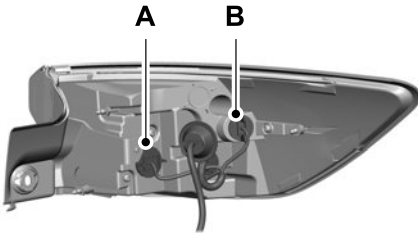

- A Rear turn signal bulb.
- B Side marker bulb.

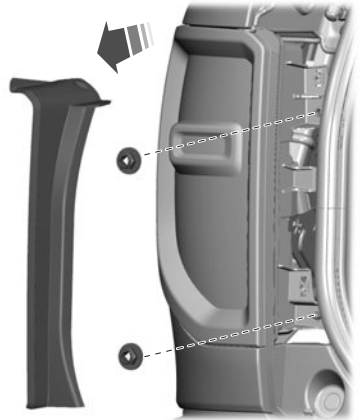

1. Make sure the headlamp control is in the off position and open the liftgate.
2. Gently pull the closeout panel away from the vehicle in a rearward direction.
3. Remove the nuts from the lamp assembly.
4. Gently pull the lamp assembly away from the vehicle in a rearward direction.
5. Disconnect the electrical connector.
6. Remove the bulb by turning the bulb socket counterclockwise. Gently pull the bulb straight out of the socket.
7. To install, reverse the removal procedure.

Mirror turn signal lamps are LED and are not serviceable. See an authorized dealer if they fail.

### Replacing the Side Marker Bulbs

Side marker bulbs are LED and are not serviceable. See an authorized dealer if they fail.

# Maintenance

## Replacing Reverse Lamp Assembly Bulbs

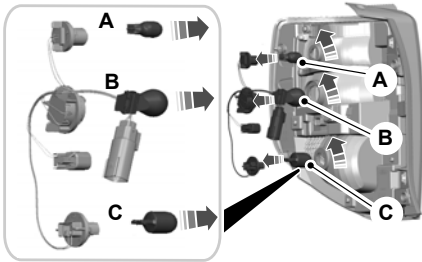

- A Rear turn signal bulb.
- B Reverse lamp.
- C Stop Lamp.

1. Remove the screws with a flathead screwdriver and pull the lamp assembly away from the vehicle.
2. Remove the bulb by turning the lower bulb socket counterclockwise. Gently pull the bulb straight out of the socket.
3. To install, reverse the removal procedure.

## Replacing License Plate Lamp Bulbs

License plate lamps are LED and are not serviceable. See an authorized dealer if they fail.

## Replacing High Mount Brake Lamp Bulbs

High mount stop lamps are LED and are not serviceable. See an authorized dealer if they fail.

# Vehicle Care

## GENERAL INFORMATION

Your dealer has many quality products available to clean your vehicle and protect its finishes.

## CLEANING PRODUCTS

### Materials

For best results, use the following products or products of equivalent quality:

For additional information and assistance, we recommend that you contact an authorized dealer.

<b>Name</b>	<b>Specification</b>
Motorcraft® Bug and Tar Remover, ZC-42 (U.S. & Canada)	
Motorcraft® Custom Bright Metal Cleaner, ZC-15 (U.S. & Canada)	ESR-M5B194-B
Motorcraft® Detail Wash, ZC-3-A (U.S. & Canada)	ESR-M14P4-A
Motorcraft® Engine Shampoo and Degreaser, ZC-20 (U.S.)	ESR-M14P3-A
Motorcraft® Engine Shampoo, CXC-66-A (Canada)	
Motorcraft® Premium Leather and Vinyl Cleaner, ZC-56 (U.S. & Canada)	
Motorcraft® Multi-Purpose Cleaner, CXC-101 (Canada)	
Motorcraft® Premium Windshield Wash Concentrate with Bitterant, ZC-32-B2 (U.S.)	WSS-M14P19-A
Motorcraft® Premium Quality Windshield Washer Fluid, CXC-37-A/B/D/F (Canada)	WSS-M14P19-A
Motorcraft® Professional Strength Carpet & Upholstery Cleaner, ZC-54 (U.S. & Canada)	
Motorcraft® Premium Glass Cleaner, CXC-100 (Canada)	ESR-M14P5-A
Motorcraft® Spot and Stain Remover, ZC-14 (U.S.)	
Motorcraft® Ultra-Clear Spray Glass Cleaner, ZC-23 (U.S.)	ESR-M14P5-A
Motorcraft® Wheel and Tire Cleaner, ZC-37-A (U.S. & Canada)	

# Vehicle Care

---

## CLEANING THE EXTERIOR

Wash your vehicle regularly with cool or lukewarm water and a neutral pH shampoo, we recommend Motorcraft Detail Wash.

- Never use strong household detergents or soap, for example dish washing or laundry liquid. These products can discolor and spot painted surfaces.
- Never wash your vehicle when it is hot to the touch, or during strong or direct sunlight.
- Dry your vehicle with a chamois or soft terry cloth towel to eliminate water spotting.
- Immediately remove fuel spillages, bird droppings, insect deposits and road tar. These may cause damage to your vehicle's paintwork or trim over time. We recommend Motorcraft Bug and Tar Remover.
- Remove any exterior accessories, for example antennas, before entering a car wash.
- When filling with AdBlue®, remove any residue on painted surfaces immediately.

**Note:** *Suntan lotions and insect repellents can damage painted surfaces. If these substances come in contact with your vehicle, wash the affected area as soon as possible.*

## Cleaning the Exterior Precautions

Immediately remove fuel spillages, AdBlue residuals, bird droppings, insect deposits and road tar. These may cause damage to your vehicle's paintwork or trim over time.

Remove any exterior accessories, for example antennas, before entering a car wash.

## Cleaning the Exterior Lamps

**Note:** *Do not scrape the exterior lamps lenses or use abrasives, alcoholic solvents or chemical solvents to clean them.*

**Note:** *Do not wipe the exterior lamps when they are dry.*

## Exterior Chrome Parts

- Apply a high quality-cleaning product to bumpers and other chrome parts. Follow the manufacturer's instructions. We recommend Motorcraft Custom Bright Metal Cleaner.
- Do not apply the cleaning product to hot surfaces. Do not leave the cleaning product on chrome surfaces longer than the time recommended.
- Using non-recommended cleaners can result in severe and permanent cosmetic damage.

**Note:** *Never use abrasive materials, for example steel wool or plastic pads as they can scratch the chrome surface.*

**Note:** *Do not use chrome cleaner, metal cleaner or polish on wheels or wheel covers.*

## Exterior Plastic Parts

For routine cleaning we recommend Motorcraft Detail Wash. If tar or grease spots are present, we recommend Motorcraft Bug and Tar Remover.

## Stripes or Graphics (If Equipped)

Hand washing your vehicle is preferred however, pressure washing may be used under the following conditions:

- Do not use water pressure higher than 2,000 psi (14,000 kPa).
- Do not use water hotter than 179°F (82°C).

# Vehicle Care

---

- Use a spray with a 40 degree wide spray angle pattern.
- Keep the nozzle at a 12 in (305 mm) distance and 90 degree angle to your vehicle's surface.

**Note:** *Holding the pressure washer nozzle at an angle to the vehicle's surface may damage graphics and cause the edges to peel away from the vehicle's surface.*

## Underbody

Regularly clean the underside of your vehicle using water. Keep body and door drain holes free of debris or foreign material.

## Under Hood

For removing black rubber marks from under the hood we recommend Motorcraft Wheel and Tire Cleaner or Motorcraft Bug and Tar Remover.

## WAXING

Regular waxing is necessary to protect your car's paint from the elements. We recommend that you wash and wax the painted surface once or twice a year.

When washing and waxing, park your vehicle in a shaded area out of direct sunlight. Always wash your vehicle before applying wax.

- Use a quality wax that does not contain abrasives.
- Follow the manufacturer's instructions to apply and remove the wax.
- Apply a small amount of wax in a back-and-forth motion, not in circles.

- Do not allow wax to come in contact with any non-body (low-gloss black) colored trim. The wax will discolor or stain the parts over time.
  - Roof racks.
  - Bumpers.
  - Grained door handles.
  - Side moldings.
  - Mirror housings.
  - Windshield cowl area.
- Do not apply wax to glass areas.
- After waxing, your car's paint should feel smooth, and be free of streaks and smudges.

## CLEANING THE ENGINE

Engines are more efficient when they are clean because grease and dirt buildup keep the engine warmer than normal.

When washing:

- Take care when using a power washer to clean the engine. The high-pressure fluid could penetrate the sealed parts and cause damage.
- Do not spray a hot engine with cold water to avoid cracking the engine block or other engine components.
- Spray Motorcraft Engine Shampoo and Degreaser on all parts that require cleaning and pressure rinse clean. In Canada, use Motorcraft Engine Shampoo.

**Note:** *If your vehicle has an engine cover remove the cover before application of Motorcraft Engine Shampoo and Degreaser. Immediately rinse away any over spray.*

# Vehicle Care

- Never wash or rinse the engine while it is hot or running; water in the running engine may cause internal damage.
- Never wash or rinse any ignition coil, spark plug wire or spark plug well, or the area in and around these locations.
- Cover the battery, power distribution box, and air filter assembly to prevent water damage when cleaning the engine.

## CLEANING THE WINDOWS AND WIPER BLADES

Car wash chemicals and environmental fallout can result in windshield and wiper blade contamination. Dirty windshield and wipers will result in poor windshield wiper operation. Keep the windshield and wiper blades clean to maintain windshield wiper performance.

To clean the windshield and wiper blades:

- Clean the windshield with a non-abrasive glass cleaner. When cleaning the interior of the windshield, avoid getting any glass cleaner on the instrument panel or door panels. Wipe any glass cleaner off these surfaces immediately.
- For windshields contaminated with tree sap, chemicals, wax or bugs, clean the entire windshield using steel wool (no greater than 0000 grade) in a circular motion and rinse with water.
- Clean the wiper blades with isopropyl rubbing alcohol or windshield washer concentrate.

**Note:** Do not use razor blades or other sharp objects to clean or remove decals from the inside of the heated rear window. The vehicle warranty does not cover damage caused to the heated rear window grid lines.

## CLEANING THE INTERIOR



**WARNING:** Do not use cleaning solvents, bleach or dye on the vehicle's seatbelts, as these actions may weaken the belt webbing.



**WARNING:** On vehicles equipped with seat-mounted airbags, do not use chemical solvents or strong detergents. Such products could contaminate the side airbag system and affect performance of the side airbag in a crash.

For fabric, carpets, cloth seats and seats equipped with side airbags:

- Remove dust and loose dirt with a vacuum cleaner.
- Remove light stains and soil with Motorcraft Professional Strength Carpet & Upholstery Cleaner.
- If grease or tar is present on the material, spot-clean the area first with Motorcraft Spot and Stain Remover. In Canada, use Motorcraft Multi-Purpose Cleaner.
- If a ring forms on the fabric after spot cleaning, clean the entire area immediately (but do not oversaturate) or the ring will set.
- Do not use household cleaning products or glass cleaners, which can stain and discolor the fabric and affect the flame retardant abilities of the seat materials.

For rubber floor:

- Remove dust and loose dirt with a vacuum cleaner.
- To remove soil use cloth dampened with water.

**Note:** Do not power wash main flooring.

# Vehicle Care

## Mirrors

Do not clean the housing or glass of any mirror with harsh abrasives, fuel or other petroleum or ammonia-based cleaning products.

## CLEANING THE INSTRUMENT PANEL AND INSTRUMENT CLUSTER LENS



**WARNING:** Do not use chemical solvents or strong detergents when cleaning the steering wheel or instrument panel to avoid contamination of the airbag system.

**Note:** *Follow the same procedure as cleaning leather seats for cleaning leather instrument panels and leather interior trim surfaces.*

Clean the instrument panel and cluster lens with a clean, damp and soft cloth, then use a clean, dry and soft cloth to dry these areas.

- Avoid cleaners or polishes that increase the gloss of the upper portion of the instrument panel. The dull finish in this area helps protect you from undesirable windshield reflection.
- Do not use any household cleaning products or glass cleaners as these may damage the finish of the instrument panel, interior trim and cluster lens.

- Wash or wipe your hands clean if you have been in contact with certain products such as insect repellent and suntan lotion to avoid possible damage to the interior painted surfaces.
- Do not allow air fresheners and hand sanitizers to spill onto interior surfaces. If a spill occurs, wipe off immediately. Your warranty may not cover these damages.

If a staining liquid like coffee or juice has been spilled on the instrument panel or on interior trim surfaces:

1. Wipe up spilled liquid using a clean, soft cloth as quickly as possible.
2. Use Motorcraft Premium Leather and Vinyl Cleaner or a commercially available leather cleaning product for automotive interiors. Test any cleaner or stain remover on an inconspicuous area.
3. Alternatively, wipe the surface with a clean, soft cloth and a mild soap and water solution. Dry the area with a clean, soft cloth.
4. If necessary, apply more soap and water solution or cleaning product to a clean, soft cloth and press it onto the soiled area. Allow this to set at room temperature for 30 minutes.
5. Remove the soaked cloth, then with a clean, damp cloth, use a rubbing motion for 60 seconds on the soiled area.
6. Dry the area with a clean, soft cloth.



# Vehicle Care

---

## REPAIRING MINOR PAINT DAMAGE

Authorized dealers have touch-up paint to match your vehicle's color. Your vehicle color code is printed on a sticker on the front, left-hand side door jamb. Take your color code to your authorized dealer to make sure you get the correct color.

Before repairing minor paint damage, use a cleaner to remove particles such as bird droppings, tree sap, insect deposits, tar spots, road salt and industrial fallout.

Read the instructions before using cleaning products.

## CLEANING THE WHEELS

1. Regularly clean them with a wheel cleaner. We recommend that you use Ford approved wheel cleaner if available.
2. Remove dirt and brake dust with a sponge.
3. Remove tar and grease with a bug and tar remover. We recommend that you use Ford approved bug and tar remover if available.
4. Thoroughly rinse the wheels with water after cleaning.

If you intend on parking your vehicle for an extended period after cleaning the wheels with a wheel cleaner, drive your vehicle for a few minutes before doing so. This reduces the risk of corrosion of the brake discs, brake pads and linings.

Do not clean the wheels when they are hot.

**Note:** *Some car washes could damage wheel rims and covers.*

**Note:** *Using non-recommended cleaners, harsh cleaning products, chrome wheel cleaners or abrasive materials could damage wheel rims and covers.*

## VEHICLE STORAGE

If you plan on storing your vehicle for 30 days or more, read the following maintenance recommendations to make sure your vehicle stays in good operating condition.

We engineer and test all motor vehicles and their components for reliable, regular driving. Under various conditions, long-term storage may lead to degraded engine performance or failure unless you use specific precautions to preserve engine components.

### General

- Store all vehicles in a dry, ventilated place.
- Protect from sunlight, if possible.
- If vehicles are stored outside, they require regular maintenance to protect against rust and damage.

### Body

- Wash your vehicle thoroughly to remove dirt, grease, oil, tar or mud from exterior surfaces, rear-wheel housing and the underside of front fenders.
- Periodically wash your vehicle if it is stored in exposed locations.
- Touch-up exposed or primed metal to prevent rust.
- Cover chrome and stainless steel parts with a thick coat of auto wax to prevent discoloration. Re-wax as necessary when you wash your vehicle.
- Lubricate all hood, door and luggage compartment hinges and latches with a light grade oil.
- Cover interior trim to prevent fading.
- Keep all rubber parts free from oil and solvents.

# Vehicle Care

---

## Engine

- Change the engine oil and filter prior to storage because used engine oil contains contaminants which may cause engine damage.
- Start the engine every 15 days for a minimum of 15 minutes. Run at fast idle with the climate controls set to defrost until the engine reaches normal operating temperature.
- With your foot on the brake, shift through all the gears while the engine is running.
- We recommend that you change the engine oil before you use your vehicle again.

## Fuel system

- Fill the fuel tank with high-quality fuel until the first automatic shutoff of the fuel pump nozzle.

## Cooling system

- Protect against freezing temperatures.
- When removing your vehicle from storage, check coolant fluid level. Confirm that there are no cooling system leaks and that fluid is at the recommended level.

## Disconnecting Your 12 Volt Battery

- Check and recharge as necessary. Keep connections clean.
- If storing your vehicle for more than 30 days without recharging the battery, we recommend that you disconnect the battery cables to maintain battery charge for quick starting.

**Note:** *It is necessary to reset memory features if you disconnect the battery cables.*

## Brakes

- Make sure the brakes and parking brake release fully.

## Tires

- Maintain recommended air pressure.

## Miscellaneous

- Make sure all linkages, cables, levers and pins under your vehicle are covered with grease to prevent rust.
- Move vehicles at least 25 ft (7.5 m) every 15 days to lubricate working parts and prevent corrosion.

## Removing Vehicle From Storage

When your vehicle is ready to come out of storage, do the following:

- Wash your vehicle to remove any dirt or grease film build-up on window surfaces.
- Check windshield wipers for any deterioration.
- Check under the hood for any foreign material that may have collected during storage such as mice or squirrel nests.
- Check the exhaust for any foreign material that may have collected during storage.
- Check tire pressures and set tire inflation per the Tire Label.
- Check brake pedal operation. Drive your vehicle 15 ft (4.5 m) back and forth to remove rust build-up.
- Check fluid levels (including coolant, oil and gas) to make sure there are no leaks, and fluids are at recommended levels.
- If you remove the battery, clean the battery cable ends and check for damage.

## Vehicle Care

---

Contact an authorized dealer if you have any concerns or issues.

# Wheels and Tires

## GENERAL INFORMATION

Use only approved wheel and tire sizes. Using other sizes could damage your vehicle. If you change the diameter of the tires from what is fitted at the factory, the speedometer may not display the correct speed. If you intend to change the size of the wheels from what was fitted by the manufacturer, you can check the suitability with your dealer.

Additional information related to the functionality and maintenance of your tires can be found later in this chapter. See **Tire Care** (page 299).

You can find the recommended tire inflation pressures on the Tire Label, which is on the B-pillar or the edge of the driver door. You can also find this information on the Safety Compliance Certification Label, affixed to either the door hinge pillar, door-latch post, or the door edge that meets the door latch post, next to the driver seating position.

We strongly recommend maintaining these tire pressures at all times. Failure to follow the tire pressure recommendations can cause uneven treadwear patterns, reduced fuel economy, and adversely affect the way your vehicle handles.

**Note:** *Check and set the tire pressure at the ambient temperature in which you are intending to drive your vehicle and when the tires are cold.*

**Note:** *Check your tire pressures at least once per month.*

If your vehicle has a spare tire, set the pressure to the highest value given for your vehicle and tire size combination.

## Notice to Utility Vehicle and Truck Owners

 **WARNING:** Utility vehicles have a significantly higher rollover rate than other types of vehicles.

 **WARNING:** Vehicles with a higher center of gravity (utility and four-wheel drive vehicles) handle differently than vehicles with a lower center of gravity (passenger cars). Avoid sharp turns, excessive speed and abrupt steering in these vehicles. Failure to drive cautiously increases the risk of losing control of your vehicle, vehicle rollover, personal injury and death.

 **WARNING:** In a rollover crash, an unbelted person is significantly more likely to die than a person wearing a seatbelt.

 **WARNING:** Do not become overconfident in the ability of four-wheel drive vehicles. Although a four-wheel drive vehicle may accelerate better than a two-wheel drive vehicle in low traction situations, it won't stop any faster than two-wheel drive vehicles. Always drive at a safe speed.

Utility vehicles and trucks handle differently than passenger cars in the various driving conditions that are encountered on streets, highways and off-road. Utility vehicles and trucks are not designed for cornering at speeds as high as passenger cars any more than low-slung sports cars are designed to perform satisfactorily under off-road conditions.

# Wheels and Tires

Study your owner's manual and any supplements for specific information about equipment features, instructions for safe driving and additional precautions to reduce the risk of an accident or serious injury.

## Four-Wheel Drive System (If Equipped)



**WARNING:** Do not become overconfident in the ability of four-wheel drive vehicles. Although a four-wheel drive vehicle may accelerate better than a two-wheel drive vehicle in low traction situations, it won't stop any faster than two-wheel drive vehicles. Always drive at a safe speed.

A vehicle equipped with four-wheel drive, when selected, has the ability to use all four wheels to power itself. This increases traction which can enable you to safely drive over terrain and road conditions that a conventional two-wheel drive vehicle cannot.

On some four-wheel drive vehicles, the initial shift from two-wheel to four-wheel drive when the vehicle is moving can cause a momentary clunk and ratcheting sound. These sounds are normal and are not cause for concern.

In four-wheel drive vehicles, the size of the spare tire relative to the remaining tires can have an effect on the four-wheel drive system. If there is a significant difference between the size of a spare and the remaining tires, four-wheel drive functionality could be limited or disabled.

**Note:** *The spare tire is only intended to be used in emergency situations. Replace the road wheel as soon as possible as extended use of a spare wheel can result in vehicle wear. Ensure all four tires are matching in manufacturer, size, and wear.*

## How Your Vehicle Differs from Other Vehicles

Sport utility vehicles and trucks can differ from some other vehicles in a few noticeable ways. Your vehicle can be:

- Higher - to allow higher load carrying capacity and to allow it to travel over rough terrain without getting stuck or damaging underbody components.
- Shorter - to give it the capability to approach inclines and drive over the crest of a hill without getting stuck or damaging underbody components. A shorter wheelbase can make your vehicle quicker to respond to steering inputs than a vehicle with a longer wheelbase.
- Narrower - to provide greater maneuverability in tight spaces, particularly in off-road use.

As a result of the above dimensional differences, sport utility vehicles and trucks often have a higher center of gravity and a greater difference in center of gravity between the loaded and unloaded condition. These differences that make your vehicle so versatile, also make it handle differently than an ordinary passenger car.

# Wheels and Tires

## TIRE CARE

### Information About Uniform Tire Quality Grading



Tire Quality Grades apply to new pneumatic passenger car tires. The Quality grades can be found where applicable on the tire sidewall between tread shoulder and maximum section width. For example: **Treadwear 200 Traction AA Temperature A.**

These Tire Quality Grades are determined by standards that the United States Department of Transportation has set.

Tire Quality Grades apply to new pneumatic passenger car tires. They do not apply to deep tread, winter-type snow tires, space-saver or temporary use spare tires, light truck or LT type tires, tires with nominal rim diameters of 10 to 12 inches or limited production tires as defined in Title 49 Code of Federal Regulations Part 575.104 (c)(2).

### U.S. Department of Transportation Tire quality grades:

The U.S. Department of Transportation requires us to give you the following information about tire grades exactly as the government has written it.

### Treadwear

The treadwear grade is a comparative rating based on the wear rate of the tire when tested under controlled conditions on a specified government test course. For example, a tire graded 150 would wear 1½ times as well on the government course as a tire graded 100. The relative performance of tires depends upon the actual conditions of their use, however, and may depart significantly from the norm due to variations in driving habits, service practices, and differences in road characteristics and climate.

### Traction AA A B C



**WARNING:** The traction grade assigned to this tire is based on straight-ahead braking traction tests, and does not include acceleration, cornering, hydroplaning or peak traction characteristics.

# Wheels and Tires

The traction grades, from highest to lowest are AA, A, B, and C. The grades represent the tire's ability to stop on wet pavement as measured under controlled conditions on specified government test surfaces of asphalt and concrete. A tire marked C may have poor traction performance.

## Temperature A B C



**WARNING:** The temperature grade for this tire is established for a tire that is properly inflated and not overloaded. Excessive speed, underinflation, or excessive loading, either separately or in combination, can cause heat buildup and possible tire failure.

The temperature grades are A (the highest), B and C, representing the tire's resistance to the generation of heat and its ability to dissipate heat when tested under controlled conditions on a specified indoor laboratory test wheel. Sustained high temperature can cause the material of the tire to degenerate and reduce tire life, and excessive temperature can lead to sudden tire failure. The grade C corresponds to a level of performance which all passenger car tires must meet under the

Federal Motor Vehicle Safety Standard No. 139. Grades B and A represent higher levels of performance on the laboratory test wheel than the minimum required by law.

## Glossary of Tire Terminology

\***Tire label:** A label showing the original equipment tire sizes, recommended inflation pressure and the maximum weight the vehicle can carry.

\***Tire Identification Number (TIN):** A number on the sidewall of each tire providing information about the tire brand and manufacturing plant, tire size and date of manufacture. Also referred to as DOT code.

\***Inflation pressure:** A measure of the amount of air in a tire.

\***Standard load:** A class of P-metric or Metric tires designed to carry a maximum load at set pressure. For example: For P-metric tires 35 psi (2.4 bar) and for Metric tires 36 psi (2.5 bar). Increasing the inflation pressure beyond this pressure will not increase the tire's load carrying capability.

\***Extra load:** A class of P-metric or Metric tires designed to carry a heavier maximum load at 42 psi (2.9 bar). Increasing the inflation pressure beyond this pressure will not increase the tire's load carrying capability.

# Wheels and Tires

\***kPa:** Kilopascal, a metric unit of air pressure.

\***PSI:** Pounds per square inch, a standard unit of air pressure.

\***Cold tire pressure:** The tire pressure when the vehicle has been stationary and out of direct sunlight for an hour or more and prior to the vehicle being driven for 1 mi (1.6 km).

\***Recommended inflation pressure:** The cold inflation pressure found on the Safety Compliance Certification Label (affixed to either the door hinge pillar, door-latch post, or the door edge that meets the door-latch post, next to the driver's seating position), or Tire Label located on the B-Pillar or the edge of the driver door.

\***B-pillar:** The structural member at the side of the vehicle behind the front door.

\***Bead area of the tire:** Area of the tire next to the rim.

\***Sidewall of the tire:** Area between the bead area and the tread.

\***Tread area of the tire:** Area of the perimeter of the tire that contacts the road when mounted on the vehicle.

\***Rim:** The metal support (wheel) for a tire or a tire and tube assembly upon which the tire beads are seated.

## Information Contained on the Tire Sidewall

Both United States and Canada Federal regulations require tire manufacturers to place standardized information on the sidewall of all tires. This information identifies and describes the fundamental characteristics of the tire and also provides a U.S. DOT Tire Identification Number for safety standard certification and in case of a recall.

## Information on P Type Tires

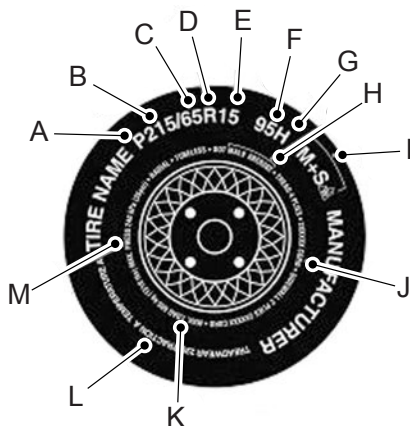

P215/65R15 95H is an example of a tire size, load index and speed rating. The definitions of these items are listed below. (Note that the tire size, load index and speed rating for your vehicle may be different from this example.)



## Wheels and Tires

A. **P:** Indicates a tire, designated by the Tire and Rim Association, that may be used for service on cars, sport utility vehicles, minivans and light trucks. **Note:** If your tire size does not begin with a letter this may mean it is designated by either the European Tire and Rim Technical Organization or the Japan Tire Manufacturing Association.

B. **215:** Indicates the nominal width of the tire in millimeters from sidewall edge to sidewall edge. In general, the larger the number, the wider the tire.

C. **65:** Indicates the aspect ratio which gives the tire's ratio of height to width.

D. **R:** Indicates a radial type tire.

E. **15:** Indicates the wheel or rim diameter in inches. If you change your wheel size, you will have to purchase new tires to match the new wheel diameter.

F. **95:** Indicates the tire's load index. It is an index that relates to how much weight a tire can carry. You may find this information in your owner's manual. If not, contact a local tire dealer.

**Note:** *You may not find this information on all tires because it is not required by federal law.*

G. **H:** Indicates the tire's speed rating. The speed rating denotes the speed at which a tire is designed to be driven for extended periods of time under a standard condition of load and inflation pressure. The tires on your vehicle may operate at different conditions for load and inflation pressure. These speed ratings may need to be adjusted for the difference in conditions. The ratings range from 81 mph (130 km/h) to 186 mph (299 km/h). These ratings are listed in the following chart.

**Note:** *You may not find this information on all tires because it is not required by federal law.*

Letter rating	Speed rating
M	81 mph (130 km/h)
N	87 mph (140 km/h)
Q	99 mph (159 km/h)
R	106 mph (171 km/h)
S	112 mph (180 km/h)
T	118 mph (190 km/h)
U	124 mph (200 km/h)
H	130 mph (210 km/h)
V	149 mph (240 km/h)

## Wheels and Tires

Letter rating	Speed rating
W	168 mph (270 km/h)
Y	186 mph (299 km/h)

**Note:** For tires with a maximum speed capability over 149 mph (240 km/h), tire manufacturers sometimes use the letters ZR. For those with a maximum speed capability over 186 mph (299 km/h), tire manufacturers always use the letters ZR.

**H. U.S. DOT Tire Identification Number (TIN):** This begins with the letters DOT and indicates that the tire meets all federal standards. The next two numbers or letters are the plant code designating where it was manufactured, the next two are the tire size code and the last four numbers represent the week and year the tire was built. For example, the numbers 317 mean the 31st week of 1997. After 2000, the numbers go to four digits. For example, 2501 means the 25th week of 2001. The numbers in between are identification codes used for traceability. This information is used to contact customers if a tire defect requires a recall.

**I. M+S or M/S:** Mud and Snow, or  
**AT:** All Terrain, or  
**AS:** All Season.

**J. Tire Ply Composition and Material Used:** Indicates the number of plies or the number of layers of rubber-coated fabric in the tire tread and sidewall. Tire manufacturers also must indicate the ply materials in the tire and the sidewall, which include steel, nylon, polyester, and others.

**K. Maximum Load:** Indicates the maximum load in kilograms and pounds that can be carried by the tire. See the Safety Compliance Certification Label (affixed to either the door hinge pillar, door-latch post, or the door edge that meets the door-latch post, next to the driver's seating position), for the correct tire pressure for your vehicle.

**L. Treadwear, Traction and Temperature Grades:**

**\*Treadwear** The treadwear grade is a comparative rating based on the wear rate of the tire when tested under controlled conditions on a specified government test course. For example, a tire graded 150 would wear one and one-half times as well on the government course as a tire graded 100.

# Wheels and Tires

**\*Traction:** The traction grades, from highest to lowest are AA, A, B, and C. The grades represent the tire's ability to stop on wet pavement as measured under controlled conditions on specified government test surfaces of asphalt and concrete. A tire marked C may have poor traction performance.

**\*Temperature:** The temperature grades are A (the highest), B and C, representing the tire's resistance to the generation of heat and its ability to dissipate heat when tested under controlled conditions on a specified indoor laboratory test wheel.

## M. Maximum Inflation Pressure:

Indicates the tire manufacturers' maximum permissible pressure or the pressure at which the maximum load can be carried by the tire. This pressure is normally higher than the vehicle manufacturer's recommended cold inflation pressure which can be found on the Safety Compliance Certification Label (affixed to either the door hinge pillar, door-latch post, or the door edge that meets the door-latch post, next to the driver's seating position), or Tire Label which is located on the B-Pillar or the edge of the driver's door. The cold inflation pressure should never be set lower than the recommended pressure on the vehicle label.

The tire suppliers may have additional markings, notes or warnings such as standard load or radial tubeless.

## Additional Information Contained on the Tire Sidewall for LT Type Tires

**Note:** *Tire Quality Grades do not apply to this type of tire.*

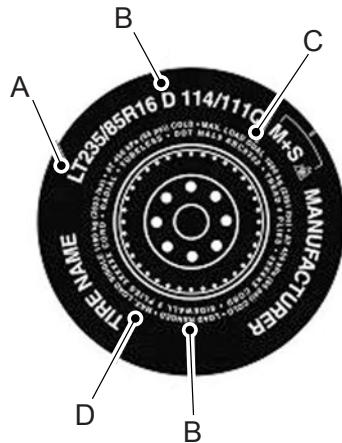

LT type tires have some additional information beyond those of P type tires; these differences are described below.

**A. LT:** Indicates a tire, designated by the Tire and Rim Association, that is intended for service on light trucks.

**B. Load Range and Load Inflation Limits:** Indicates the tire's load-carrying capabilities and its inflation limits.

## Wheels and Tires

**C. Maximum Load Dual lb (kg) at psi (kPa) cold:** Indicates the maximum load and tire pressure when the tire is used as a dual, defined as four tires on the rear axle (a total of six or more tires on the vehicle).

**D. Maximum Load Single lb (kg) at psi (kPa) cold:** Indicates the maximum load and tire pressure when the tire is used as a single, defined as two tires (total) on the rear axle.

### Information on T Type Tires

T145/80D16 is an example of a tire size.

**Note:** *The temporary tire size for your vehicle may be different from this example. Tire Quality Grades do not apply to this type of tire.*

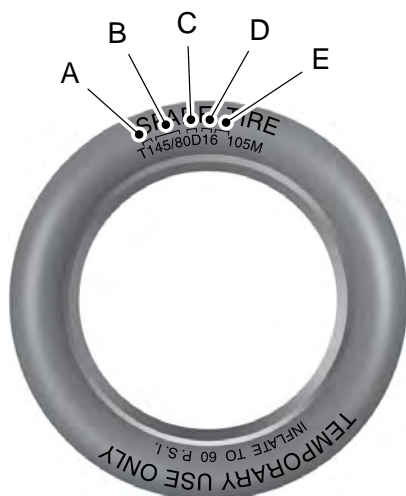

T type tires have some additional information beyond those of P type tires; these differences are described below:

**A. T:** Indicates a type of tire, designated by the Tire and Rim Association, that is intended for temporary service on cars, sport utility vehicles, minivans and light trucks.

**B. 145:** Indicates the nominal width of the tire in millimeters from sidewall edge to sidewall edge. In general, the larger the number, the wider the tire.

# Wheels and Tires

C. **80:** Indicates the aspect ratio which gives the tire's ratio of height to width. Numbers of 70 or lower indicate a short sidewall.

D. **D:** Indicates a diagonal type tire.

R: Indicates a radial type tire.

E. **16:** Indicates the wheel or rim diameter in inches. If you change your wheel size, you will have to purchase new tires to match the new wheel diameter.

## Recommended Tire Pressures and Inflating Your Tires

Safe operation of your vehicle requires that your tires are properly inflated. Remember that a tire can lose up to half of its air pressure without appearing flat. Every day before you drive, check your tires. If one looks lower than the others, use a tire gauge to check the pressure of all tires and adjust if required.

At least once a month and before long trips, inspect each tire and check the tire pressure with a tire gauge (including spare, if equipped). Inflate all tires to the inflation pressure recommended by the manufacturer.



**WARNING:** Under-inflation is the most common cause of tire failures and may result in severe tire cracking, tread separation or blowout, with unexpected loss of vehicle

control and increased risk of injury. Under-inflation increases sidewall flexing and rolling resistance, resulting in heat buildup and internal damage to the tire. It also may result in unnecessary tire stress, irregular wear, loss of vehicle control and accidents. A tire can lose up to half of its air pressure and not appear to be flat!

You are strongly urged to buy a reliable tire pressure gauge, as automatic service station gauges may be inaccurate. We recommend the use of a digital or dial-type tire pressure gauge rather than a stick-type tire pressure gauge. Use the recommended cold inflation pressure for optimum tire performance and wear. Under-inflation or over-inflation may cause uneven treadwear patterns.

Always inflate your tires to the recommended inflation pressure even if it is less than the maximum inflation pressure information found on the tire. You will find a Tire Label containing the manufacturer's recommended tire inflation pressure by the tire size and other important information located on the B-Pillar or the edge of the driver's door.

# Wheels and Tires

The recommended tire inflation pressure is also found on the Safety Compliance Certification Label (affixed to either the door hinge pillar, door-latch post, or the door edge that meets the door-latch on the B-pillar, or on the edge of the driver's door.

Failure to follow the tire pressure recommendations can cause uneven treadwear patterns and adversely affect the way your vehicle handles.

## Inspecting Your Tires and Wheel Valve Stems

Periodically inspect the tire treads for uneven or excessive wear and remove objects such as stones, nails or glass that may be wedged in the tread grooves. Check the tire and valve stems for holes, cracks, or cuts that may permit air leakage and repair or replace the tire and replace the valve stem. Inspect the tire sidewalls for cracking, cuts, bruises and other signs of damage or excessive wear. If internal damage to the tire is suspected, have the tire demounted and inspected in case it needs to be repaired or replaced. For your safety, tires that are damaged or show signs of excessive wear should not be used because they are more likely to blow out or fail.

Improper or inadequate vehicle maintenance can cause tires to wear abnormally. Inspect all your tires, including the spare, frequently, and replace them if one or more of the following conditions exist:

## Tire Wear

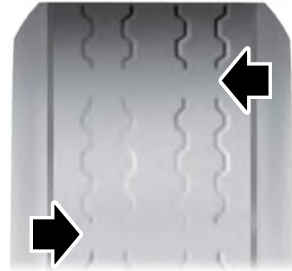

When the tread is worn down to one sixteenth of an inch (2 mm), tires must be replaced to help prevent your vehicle from skidding and hydroplaning. Built-in treadwear indicators, or wear bars, which look like narrow strips of smooth rubber across the tread will appear on the tire when the tread is worn down to one sixteenth of an inch (2 mm).

When the tire tread wears down to the same height as these wear bars, the tire is worn out and must be replaced.

# Wheels and Tires

## Damage

Periodically inspect the tire treads and sidewalls for damage (such as bulges in the tread or sidewalls, cracks in the tread groove and separation in the tread or sidewall). If damage is observed or suspected, have the tire inspected by a tire professional. Tires can be damaged during off-road use, so inspection after off-road use is also recommended.

## Age



**WARNING:** Tires degrade over time depending on many factors such as weather, storage conditions, and conditions of use (load, speed, inflation pressure) the tires experience throughout their lives.

In general, tires should be replaced after six years regardless of tread wear. However, heat caused by hot climates or frequent high loading conditions can accelerate the aging process and may require tires to be replaced more frequently.

You should replace your spare tire when you replace the road tires or after six years due to aging even if it has not been used.

## U.S. DOT Tire Identification Number

Both United States and Canada Federal regulations require tire manufacturers to place standardized information on the sidewall of all tires. This information identifies and describes the fundamental characteristics of the tire and also provides a U.S. DOT Tire Identification Number for safety standard certification and in case of a recall.

This begins with the letters DOT and indicates that the tire meets all federal standards. The next two numbers or letters are the plant code designating where it was manufactured, the next two are the tire size code and the last four numbers represent the week and year the tire was built. For example, the numbers 317 mean the 31st week of 1997. After 2000, the numbers go to four digits. For example, 2501 means the 25th week of 2001. The numbers in between are identification codes used for traceability. This information is used to contact customers if a tire defect requires a recall.

## Tire Replacement Requirements

Your vehicle is equipped with tires designed to provide a safe ride and handling capability.

## Wheels and Tires



**WARNING:** Only use replacement tires and wheels that are the same size, load index, speed rating and type (such as P-metric versus LT-metric or all-season versus all-terrain) as those originally provided by Ford. The recommended tire and wheel size may be found on either the Safety Compliance Certification Label (affixed to either the door hinge pillar, door-latch post, or the door edge that meets the door-latch post, next to the driver's seating position), or the Tire Label which is located on the B-Pillar or edge of the driver's door. If this information is not found on these labels, then you should contact your authorized dealer as soon as possible. Use of any tire or wheel not recommended by Ford can affect the safety and performance of your vehicle, which could result in an increased risk of loss of vehicle control, vehicle rollover, personal injury and death.



**WARNING:** To reduce the risk of serious injury, when mounting replacement tires and wheels, you should not exceed the maximum pressure indicated on the sidewall of the tire to set the beads without additional precautions listed below. If the beads do not seat at the maximum pressure indicated, re-lubricate and try again.



**WARNING:** For a mounting pressure more than 20 psi (1.38 bar) greater than the maximum pressure, a Ford dealer or other tire service professional should do the mounting.



**WARNING:** Always inflate steel carcass tires with a remote air fill with the person inflating standing at a minimum of 12 ft (3.66 m) away from the wheel and tire assembly.



**WARNING:** When inflating the tire for mounting pressures up to 20 psi (1.38 bar) greater than the maximum pressure on the tire sidewall, the following precautions must be taken to protect the person mounting the tire:

- Make sure that you have the correct tire and wheel size.
- Lubricate the tire bead and wheel bead seat area again.



# Wheels and Tires

- Stand at a minimum of 12 ft (3.66 m) away from the wheel and tire assembly.
- Use both eye and ear protection.

**Important:** Remember to replace the wheel valve stems when the road tires are replaced on your vehicle.

It is recommended that the two front tires or two rear tires generally be replaced as a pair.

The tire pressure sensors mounted in the wheels (originally installed on your vehicle) are not designed to be used in aftermarket wheels.

The use of wheels or tires not recommended may affect the operation of your tire pressure monitoring system.

If the tire pressure monitoring system indicator is flashing, your system is malfunctioning. Your replacement tire might be incompatible with your tire pressure monitoring system, or some component of the system may be damaged.

## Safety Practices



**WARNING:** If your vehicle is stuck in snow, mud or sand, do not rapidly spin the tires; spinning the tires can tear the tire and cause an explosion. A tire can explode in as little as three to five seconds.



**WARNING:** Do not spin the wheels at over 34 mph (55 km/h). The tires may fail and injure a passenger or bystander.

## Driving habits have a great deal to do with your tire mileage and safety.

- \*Observe posted speed limits
- \*Avoid fast starts, stops and turns
- \*Avoid potholes and objects on the road
- \*Do not run over curbs or hit the tire against a curb when parking

## Highway Hazards

No matter how carefully you drive, there is always the possibility that you may eventually have a flat tire on the highway. Drive slowly to the closest safe area out of traffic. This may further damage the flat tire, but your safety is more important.

If you feel a sudden vibration or ride disturbance while driving, or you suspect your tire or vehicle has been damaged, immediately reduce your speed. Drive with caution until you can safely pull off the road. Stop and inspect the tires for damage. If a tire is under-inflated or damaged, deflate it, remove wheel and

# Wheels and Tires

replace it with your spare tire and wheel. If you cannot detect a cause, have the vehicle towed to the nearest repair facility or tire dealer to have the vehicle inspected.

## Tire and Wheel Alignment

A bad jolt from hitting a curb or pothole can cause the front end of your vehicle to become misaligned or cause damage to your tires. If your vehicle seems to pull to one side when you are driving, the wheels may be out of alignment. Have an authorized dealer check the wheel alignment periodically.

Wheel misalignment in the front or the rear can cause uneven and rapid treadwear of your tires and should be corrected by an authorized dealer. Front-wheel drive vehicles and those with an independent rear suspension (if equipped) may require alignment of all four wheels.

The tires should also be balanced periodically. An unbalanced tire and wheel assembly may result in irregular tire wear.

## Tire Rotation

**Note:** *If your tires show uneven wear, ask an authorized dealer to check for and correct any wheel misalignment, tire imbalance or mechanical problem involved before tire rotation.*

**Note:** *Your vehicle may be equipped with a dissimilar spare wheel and tire assembly. A dissimilar spare wheel and tire assembly is defined as a spare wheel and tire assembly that is different in brand, size or appearance from the road tires and wheels. If you have a dissimilar spare wheel and tire assembly, it is intended for temporary use only and should not be used in a tire rotation.*

**Note:** *After having your tires rotated, inflation pressure must be checked and adjusted to the vehicle requirements.*

Rotating your tires at the recommended interval will help your tires wear more evenly, providing better tire performance and longer tire life. Sometimes irregular tire wear can be corrected by rotating the tires.

## Tire Rotation Diagram

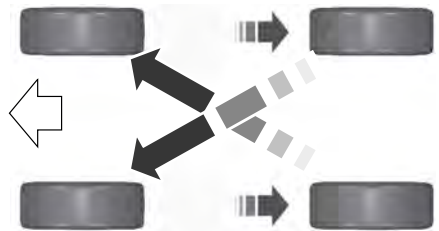

E142547

# Wheels and Tires

## USING SNOW CHAINS



**WARNING:** Do not exceed 30 mph (50 km/h). Failure to follow this instruction could result in the loss of control of your vehicle, personal injury or death.



**WARNING:** Do not use snow chains on snow-free roads.



**WARNING:** Only fit snow chains to specified tires.



**WARNING:** If your vehicle is fitted with wheel trims, remove them before fitting snow chains.



**WARNING:** If you choose to install snow tires on your vehicle, they must be the same size, construction, and load range as the original tires listed on the tire placard, and they must be installed on all four wheels. Mixing tires of different size or construction on your vehicle can adversely affect your vehicle's handling and braking, and may lead to loss of vehicle control.

The tires on your vehicle have all-weather treads to provide traction in rain and snow. However, in some climates, you may need to use snow tires and cables. If you need to use cables, it is recommended that steel wheels (of the same size and specifications) be used, as cables may chip aluminum wheels.

Follow these guidelines when using snow tires and traction devices.

- If possible, avoid fully loading your vehicle.
- Purchase chains or cables from a manufacturer that clearly labels body to tire dimension restrictions.

- Use 10 mm cables or chains only on front axle with 225/65R17 and 225/60R18 tires.
- Not all S-class snow chains or cables meet these restrictions. Chains of this size restriction will include a tensioning device.
- The snow chains or cables must be mounted in pairs on the front axle.
- Do not use chains or cables on 235/65R17 tires.
- Install cables securely, verifying that the cables do not touch any wiring, brake lines or fuel lines.
- When driving with tire cables do not exceed 30 mph (48 km/h) or the maximum speed recommended by the chain manufacturer, whichever is less.
- Drive cautiously. If you hear the cables rub or bang against the vehicle, stop and retighten them. If this does not work, remove the cables to prevent vehicle damage.
- Remove the cables when they are no longer needed. Do not use cables on dry roads.

If you have any questions regarding snow chains or cables, please contact your authorized dealer.

## TIRE PRESSURE MONITORING SYSTEM



**WARNING:** The tire pressure monitoring system is not a substitute for manually checking tire pressures. You should periodically check tire pressures using a pressure gauge. Failure to correctly maintain tire pressures could increase the risk of tire failure, loss of control, vehicle rollover and personal injury.

# Wheels and Tires

**Note:** You should only use tire sealants in roadside emergencies as they may cause damage to the tire pressure monitoring system sensor.

**Note:** If the tire pressure monitoring system sensor becomes damaged, it may not function.



Each tire, including the spare (if provided), should be checked monthly when cold and inflated to the inflation pressure recommended by the vehicle manufacturer on the vehicle placard or tire inflation pressure label. (If your vehicle has tires of a different size than the size indicated on the vehicle placard or tire inflation pressure label, you should determine the proper tire inflation pressure for those tires).

As an added safety feature, your vehicle has been equipped with a Tire Pressure Monitoring System (TPMS) that illuminates a low tire pressure telltale when one or more of your tires is significantly under-inflated. Accordingly, when the low tire pressure telltale illuminates, you should stop and check your tires as soon as possible, and inflate them to the proper pressure. Driving on a significantly under-inflated tire causes the tire to overheat and can lead to tire failure. Under-inflation also reduces fuel efficiency and tire tread life, and may affect the vehicle's handling and stopping ability.

Please note that the TPMS is not a substitute for proper tire maintenance, and it is the driver's responsibility to maintain correct tire pressure, even if under-inflation has not reached the level to trigger illumination of the TPMS low tire pressure telltale.

Your vehicle has also been equipped with a TPMS malfunction indicator to indicate when the system is not operating properly. The TPMS malfunction indicator is combined with the low tire pressure telltale. When the system detects a malfunction, the telltale will flash for approximately one minute and then remain continuously illuminated. This sequence will continue upon subsequent vehicle start-ups as long as the malfunction exists.

When the malfunction indicator is illuminated, the system may not be able to detect or signal low tire pressure as intended. TPMS malfunctions may occur for a variety of reasons, including the installation of replacement or alternate tires or wheels on the vehicle that prevent the TPMS from functioning properly. Always check the TPMS malfunction telltale after replacing one or more tires or wheels on your vehicle to ensure that the replacement or alternate tires and wheels allow the TPMS to continue to function properly.

This device complies with Part 15 of the FCC Rules and with License exempt RSS Standards of Industry Canada. Operation is subject to the following two conditions:

1. This device may not cause harmful interference, and
2. This device must accept any interference received, including interference that may cause undesired operation.

 **WARNING:** Changes or modifications not expressly approved by the party responsible for compliance could void the user's authority to operate the equipment. The term "IC:" before the radio certification number only signifies that Industry Canada technical specifications were met.

# Wheels and Tires

## Changing Tires With a Tire Pressure Monitoring System



**Note:** Each road tire is equipped with a tire pressure sensor located inside the wheel and tire assembly cavity. The pressure sensor is attached to the valve stem. The pressure sensor is covered by the tire and is not visible unless the tire is removed. Take care when changing the tire to avoid damaging the sensor.

You should always have your tires serviced by an authorized dealer.

Check the tire pressure periodically (at least monthly) using an accurate tire gauge. See **When Inflating Your Tires** in this chapter.

## Understanding Your Tire Pressure Monitoring System



The tire pressure monitoring system measures pressure in your road tires and sends the tire pressure readings to your vehicle. You can view the tire pressure readings through the information display. See **General Information** (page 99). The low tire pressure warning light will turn on if the tire pressure is significantly low. Once the light is illuminated, your tires are under-inflated and need to be inflated to the manufacturer's recommended tire pressure. Even if the light turns on and a short time later turns off, your tire pressure still needs to be checked.

## When Your Temporary Spare Tire is Installed

When one of your road tires needs to be replaced with the temporary spare, the system will continue to identify an issue to remind you that the damaged road wheel and tire assembly needs to be repaired and put back on your vehicle.

To restore the full function of the tire pressure monitoring system, have the damaged road wheel and tire assembly repaired and remounted on your vehicle.

## When You Believe Your System is Not Operating Properly

The main function of the tire pressure monitoring system is to warn you when your tires need air. It can also warn you in the event the system is no longer capable of functioning as intended. See the following chart for information concerning your tire pressure monitoring system:

# Wheels and Tires

Low tire pressure warning light	Possible cause	Customer action required
Solid warning light	Tire(s) under-inflated	Make sure tires are at the proper pressure. See Inflating your tires in this chapter. After inflating your tires to the manufacturer's recommended pressure as shown on the Tire Label (located on the edge of driver's door or the B-Pillar), the vehicle must be driven for at least two minutes over 20 mph (32 km/h) before the light turns off.
	Spare tire in use	Repair the damaged road wheel and tire assembly and reinstall it on the vehicle to restore system function. For a description on how the system functions, see <b>When Your Temporary Spare Tire is Installed</b> in this section.
	TPMS malfunction	If the tires are properly inflated and the spare tire is not in use but the light remains on, contact your authorized dealer as soon as possible.
Flashing warning light	Spare tire in use	Repair the damaged road wheel and tire assembly and reinstall it on the vehicle to restore system function. For a description on how the system functions, see <b>When Your Temporary Spare Tire is Installed</b> in this section.
	TPMS malfunction	If the tires are properly inflated and the spare tire is not in use but the light remains on, contact your authorized dealer as soon as possible.

## When Inflating Your Tires



**WARNING:** Do not use the tire pressure displayed in the information display as a tire pressure gauge. Failure to follow this instruction could result in personal injury or death.

When putting air into your tires (such as at a gas station or in your garage), the tire pressure monitoring system may not respond immediately to the air added to your tires.

It may take up to two minutes of driving over 20 mph (32 km/h) for the light to turn off after you have filled your tires to the recommended inflation pressure.

# Wheels and Tires

## How Temperature Affects Your Tire Pressure

The tire pressure monitoring system monitors tire pressure in each pneumatic tire. While driving in a normal manner, a typical passenger tire inflation pressure may increase about 2–4 psi (14–28 kPa) from a cold start situation. If the vehicle is stationary overnight with the outside temperature significantly lower than the daytime temperature, the tire pressure may decrease about 3 psi (21 kPa) for a drop of 30°F (17°C) in ambient temperature. This lower pressure value may be detected by the tire pressure monitoring system as being significantly lower than the recommended inflation pressure and activate the system warning light for low tire pressure. If the low tire pressure warning light is on, visually check each tire to verify that no tire is flat. If one or more tires are flat, repair as necessary. Check the air pressure in the road tires. If any tire is under-inflated, carefully drive the vehicle to the nearest location where air can be added to the tires. Inflate all the tires to the recommended inflation pressure.

## CHANGING A ROAD WHEEL



**WARNING:** The tire pressure monitoring system is not a substitute for manually checking tire pressures. You should periodically check tire pressures using a pressure gauge. Failure to correctly maintain tire pressures could increase the risk of tire failure, loss of control, vehicle rollover and personal injury.



**WARNING:** If the tire pressure monitor sensor becomes damaged it may not function.

**Note:** Only use tire sealants in roadside emergencies as they may cause damage to the tire pressure monitoring system sensor.

**Note:** The tire pressure monitoring system indicator light illuminates when the spare tire is in use. To restore the full function of the monitoring system, all road wheels equipped with tire pressure monitoring sensors must be mounted on the vehicle.

If you get a flat tire when driving, do not apply the brake heavily. Instead, gradually decrease your speed. Hold the steering wheel firmly and slowly move to a safe place on the side of the road.

Have a flat serviced by an authorized dealer in order to prevent damage to the tire pressure monitoring system sensors. See **Tire Pressure Monitoring System** (page 312). Replace the spare tire with a road tire as soon as possible. During repairing or replacing of the flat tire, have the authorized dealer inspect the tire pressure monitoring system sensor for damage.

## Dissimilar Spare Wheel and Tire Assembly Information



**WARNING:** Failure to follow these guidelines could result in an increased risk of loss of vehicle control, injury or death.

If you have a dissimilar spare wheel and tire, then it is intended for temporary use only. This means that if you need to use it, you should replace it as soon as possible with a road wheel and tire assembly that is the same size and type as the road tires and wheels that we provided with the vehicle. If the dissimilar spare tire or wheel is damaged, replace it instead of repairing it.

# Wheels and Tires

A dissimilar spare wheel and tire assembly is defined as a spare wheel and tire assembly that is different in brand, size or appearance from the road tires and wheels and can be one of three types:

1. **T-type mini-spare:** This spare tire begins with the letter T for tire size and may have Temporary Use Only molded in the sidewall.

2. **Full-size dissimilar spare with label on wheel:** This spare tire has a label on the wheel that states: THIS WHEEL AND TIRE ASSEMBLY FOR TEMPORARY USE ONLY.

When driving with one of the dissimilar spare tires listed above, do not:

- Exceed 50 mph (80 km/h).
- Load the vehicle beyond maximum vehicle load rating listed on the Safety Compliance Label.
- Tow a trailer.
- Use snow chains on the end of the vehicle with the dissimilar spare tire.
- Use more than one dissimilar spare tire at a time.
- Use commercial car washing equipment.
- Try to repair the dissimilar spare tire.

Use of one of the dissimilar spare tires listed above at any one wheel location can lead to impairment of the following:

- Handling, stability and braking performance.
- Comfort and noise.
- Ground clearance and parking at curbs.
- Winter weather driving capability.
- Wet weather driving capability.
- All-wheel driving capability

3. **Full-size dissimilar spare without label on wheel**

When driving with the full-size dissimilar spare wheel and tire assembly, do not:

- Exceed 70 mph (113 km/h).
- Use more than one dissimilar spare wheel and tire assembly at a time.
- Use commercial car washing equipment.
- Use snow chains on the end of the vehicle with the dissimilar spare wheel and tire assembly.

The usage of a full-size dissimilar spare wheel and tire assembly can lead to impairment of the following:

- Handling, stability and braking performance.
- Comfort and noise.
- Ground clearance and parking at curbs.
- Winter weather driving capability.
- Wet weather driving capability.
- Four-wheel driving capability.

When driving with the full-size dissimilar spare wheel and tire assembly additional caution should be given to:

- Towing a trailer.
- Driving vehicles equipped with a camper body.
- Driving vehicles with a load on the cargo rack.

Drive cautiously when using a full-size dissimilar spare wheel and tire assembly and seek service as soon as possible.

## Tire Change Procedure



**WARNING:** The jack supplied with this vehicle is only intended for changing wheels. Do not use the vehicle jack other than when you are changing a wheel in an emergency.



# Wheels and Tires

**WARNING:** Check that the vehicle jack is not damaged or deformed and the thread is lubricated and clean.

**WARNING:** To help prevent your vehicle from moving when changing a wheel, shift the transmission into park (P), set the parking brake and use an appropriate block or wheel chock to secure the wheel diagonally opposite to the wheel being changed. For example, when changing the front left wheel, place an appropriate block or wheel chock on the right rear wheel.

**WARNING:** Always use the jack provided as original equipment with your vehicle. If using a jack other than the one provided, make sure the jack capacity is adequate for the vehicle weight, including any vehicle cargo or modifications. If you are unsure if the jack capacity is adequate, contact the authorized dealer.

**WARNING:** Do not work on your vehicle when the jack is the only support as your vehicle could slip off the jack. Failure to follow this instruction could result in personal injury or death.

**WARNING:** Use only the specified jacking points. If you use other positions, you may damage the body, steering, suspension, engine, braking system or the fuel lines.

**WARNING:** Never place anything between the vehicle jack and your vehicle.

**WARNING:** Never place anything between the vehicle jack and the ground.

**WARNING:** Park your vehicle so that you do not obstruct the flow of traffic or place yourself in any danger and set up a warning triangle.

**WARNING:** Do not attempt to change a tire on the side of the vehicle close to moving traffic. Pull far enough off the road to avoid the danger of being hit when operating the jack or changing the wheel.

**WARNING:** The jack should be used on level firm ground wherever possible.

**WARNING:** Do not get under a vehicle that is only supported by a vehicle jack.

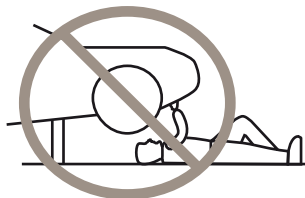

**Note:** *The jack does not require maintenance or additional lubrication over the service life of your vehicle.*

1. Park on a level surface, set the parking brake and activate the hazard flashers.
2. Place the transmission in park (P) and turn the engine off.
3. Lift and remove the carpeted cargo area floor to access the spare tire and jack.
4. Remove the wing nut that secures the spare tire by turning it counterclockwise.

# Wheels and Tires

5. Remove the spare tire and jack kit from the spare tire compartment.
6. Remove the jack and the flat tire retainer strap from the jack base.

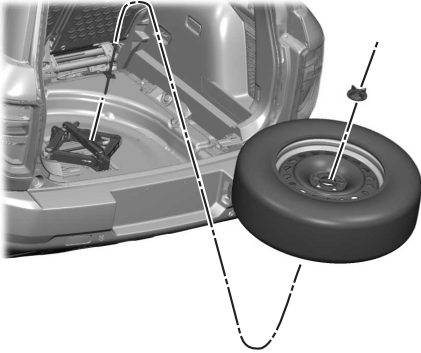

7. Turn the jack hex nut drive screw counterclockwise to detach the lug wrench from the jack. This lowers the jack and releases the mechanical lock.

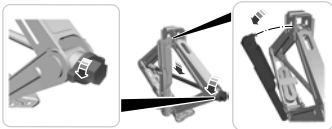

8. Unfold the lug wrench for use.

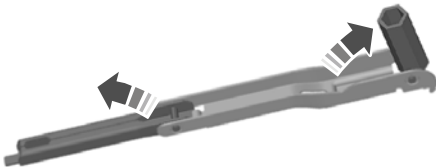

9. Block the diagonally opposite wheel.

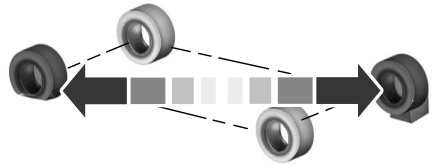

10. Loosen each wheel lug nut one-half turn counterclockwise, but do not remove them until the wheel is raised off the ground.

**Note:** Jack at the specified locations to avoid damage to the vehicle.

11. The vehicle jacking points shown here are also depicted on the warning label on the jack. Small arrow-shaped marks on the vehicle sills show the location of the jacking points.

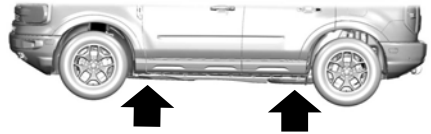

12. Turn the wrench clockwise to raise the vehicle until the flat tire is completely off the ground.

# Wheels and Tires

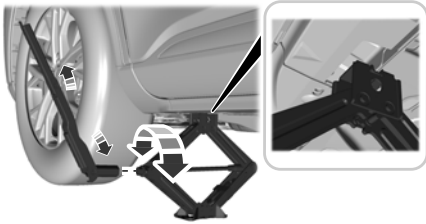

13. Remove the lug nuts with the lug wrench.

**Note:** For vehicles with full wheel covers with exposed wheel nuts, remove the wheel nuts prior to removing the wheel cover or damage to the wheel cover may occur.

14. Replace the flat tire with the spare tire, making sure the valve stem is facing outward. Reinstall the lug nuts until the wheel is snug against the hub. Do not fully tighten the lug nuts until the wheel has been lowered.
15. Lower the wheel by turning the jack handle counterclockwise.
16. Remove the jack and fully tighten the lug nuts in the order shown. See **Technical Specifications** (page 322).

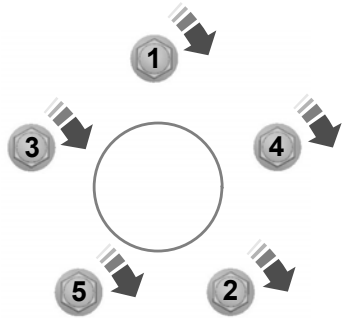

## Stowing the flat tire

1. To store the jack kit fold the jack and wrench handle and engage it to the bracket of the jack base using the lug wrench pin.
2. When attaching the folded wrench on the jack, swing the wrench upward and adjust the jack height until the wrench hook engages the hole on the jack. Tighten the hex nut clockwise until secure.

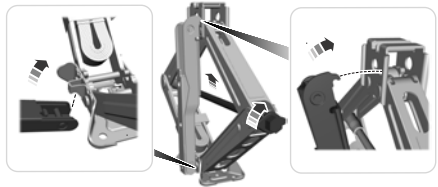

3. Re-position the jack kit assembly into the original vehicle position and secure with the plastic wing nut. Make sure the jack is fastened securely before you drive.
4. Unblock the wheels.

# Wheels and Tires

5. Stow the flat tire on the floor in the cargo area. Secure with the flat tire retainer strap by following the next steps:



6. Locate the cargo tie-down near the seatback. Push the loop of the retainer strap through the tie-down. Thread the non-loop end through the loop.

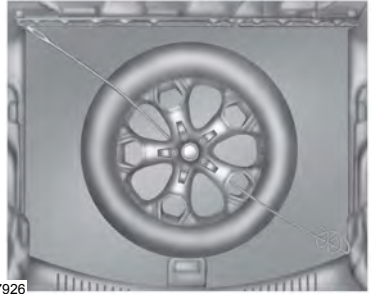

E157926

7. Weave the retainer strap through the wheel openings.
8. Locate the front cargo tie-down at the opposite corner of the cargo area to the tie-down used in Step 4. Thread the retainer strap through the tie-down and pull tight.
9. Secure by tying a 2-half hitch knot.

1



2



3



# Wheels and Tires

## TECHNICAL SPECIFICATIONS

### Wheel Lug Nut Torque Specifications



**WARNING:** When you install a wheel, always remove any corrosion, dirt or foreign materials present on the mounting surfaces of the wheel or the surface of the wheel hub, brake drum or brake disc that contacts the wheel. Make sure to secure any fasteners that attach the rotor to the hub so they do not interfere with the mounting surfaces of the wheel. Installing wheels without correct metal-to-metal contact at the wheel mounting surfaces can cause the wheel nuts to loosen and the wheel to come off while your vehicle is in motion, resulting in loss of vehicle control, personal injury or death.

Bolt size	lb-ft (Nm)*
M12 x 1.5	100 lb.ft (135 Nm)

\*Torque specifications are for nut and bolt threads free of dirt and rust. Use only Ford recommended replacement fasteners.

Retighten the lug nuts to the specified torque within 100 mi (160 km) after any wheel disturbance, such as tire rotation, changing a flat tire, wheel removal.



A Wheel pilot bore.

Inspect the wheel pilot bore and mounting surface prior to installation. Remove any visible corrosion or loose particles.

# Capacities and Specifications

## ENGINE SPECIFICATIONS - 1.5L ECOBOOST™

Engine	Specification
Compression ratio.	11:1
Displacement.	91 in <sup>3</sup> (1,497 cm <sup>3</sup> )
Firing order.	1-2-3
Ignition system.	Coil on plug
Required fuel.	Minimum 87 octane
Spark plug gap.	0.031 in (0.8 mm)

## Drivebelt Routing

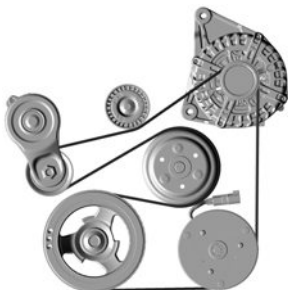

## ENGINE SPECIFICATIONS - 2.0L ECOBOOST™

Engine	Specification
Compression ratio.	10:1
Displacement.	122.0 in <sup>3</sup> (1,999 cm <sup>3</sup> )
Firing order.	1-3-4-2
Ignition system.	Coil on plug
Required fuel.	Minimum 87 octane
Spark plug gap.	0.028–0.031 in (0.7–0.8 mm)

# Capacities and Specifications

## Drivebelt Routing

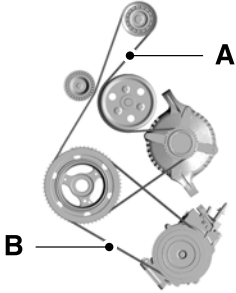

- A. Drivebelt closest to the engine.
- B. Drivebelt furthest from the engine.

## VEHICLE DIMENSIONS (IF EQUIPPED)

Dimension Description	Specification
Overall length excluding the license plate bracket.	172.7 in (4,386 mm)
Overall width.	74.3 in (1,888 mm)
Overall height.	71.5 in (1,817 mm)
Approach angle.	30.4°
Departure angle.	33.1°
Ramp breakover angle - Curb.	20.4°
Minimum running ground clearance.	8.8 in (223 mm)

## Capacities and Specifications

### MOTORCRAFT PARTS - 1.5L ECOBOOST™

Component	Motorcraft Part Number
Air filter element.	FA-1939
Battery.	BHEF-48H6
Cabin air filter.	FP-89
Engine oil filter. <sup>1</sup>	FL-910-S
Spark plug. <sup>2</sup>	SP-550
Windshield wiper blade.	WW-2117 (driver side) WW-2302 (passenger side) WW-901 (rear window)

<sup>1</sup> If a Motorcraft oil filter is not available, use an oil filter that meets industry performance specification SAE/USCAR-36.

<sup>2</sup> For spark plug replacement, contact your authorized dealer. Replace the spark plugs at the recommended intervals. See Normal Scheduled Maintenance.

We recommend Motorcraft® parts that are available at your authorized dealer or at [www.fordparts.com](http://www.fordparts.com). We engineer these parts for your vehicle to meet or exceed our specifications. Use of other parts could impact vehicle performance, emissions and durability. Your warranty could be void for any damage related to use of other parts.

### MOTORCRAFT PARTS - 2.0L ECOBOOST™

Component	Motorcraft Part Number
Air filter element.	FA-1939
Battery.	BHEF-48H6
Cabin air filter.	FP-89
Engine oil filter. <sup>1</sup>	FL-910-S



## Capacities and Specifications

Component	Motorcraft Part Number
Spark plug. <sup>2</sup>	SP-578
Windshield wiper blade.	WW-2117 (driver side) WW-2302 (passenger side) WW-901 (rear window)

<sup>1</sup> If a Motorcraft oil filter is not available, use an oil filter that meets industry performance specification SAE/USCAR-36.

<sup>2</sup> For spark plug replacement, contact your authorized dealer. Replace the spark plugs at the recommended intervals. See Normal Scheduled Maintenance.

We recommend Motorcraft® parts that are available at your authorized dealer or at [www.fordparts.com](http://www.fordparts.com). We engineer these parts for your vehicle to meet or exceed our specifications. Use of other parts could impact vehicle performance, emissions and durability. Your warranty could be void for any damage related to use of other parts.

### BULB SPECIFICATION CHART

The chart that follows specifies the replacement bulbs. Use headlamp bulbs marked with an authorized "D.O.T." for North America to ensure lamp performance, light brightness and pattern and safe visibility. The correct bulbs do not damage the lamp assembly or void the lamp assembly warranty and provide quality bulb burn time.

#### Exterior Lamps

Function	Trade number
Backup, reverse lamp.	W21W
Fog lamp. <sup>1</sup>	LED
Front side marker. <sup>1</sup>	LED
Headlamp. <sup>1</sup>	LED
High-mount brake lamp. <sup>1</sup>	LED
License plate lamp. <sup>1</sup>	LED
Mirror turn signal lamp. <sup>1</sup>	LED
Rear side marker. <sup>1</sup>	LED
Rear turn signal lamp.	WY16W

## Capacities and Specifications

---

Function	Trade number
Stop lamp.	P27/7W
Tail lamp. <sup>1</sup>	LED

<sup>1</sup> To replace these lamps, see your authorized dealer.

### Interior Lamps

Function	Trade number
All interior lamps. <sup>1</sup>	LED

<sup>1</sup> To replace these lamps, see your authorized dealer.

**Note:** *To replace all instrument panel lights, see your authorized dealer.*

# Capacities and Specifications

## ENGINE OIL CAPACITY AND SPECIFICATION - 2.0L ECOBOOST™

Use oil that meets the defined specification and viscosity grade.

If you do not use oil that meets the defined specification and viscosity grade, it could result in:

- Component damage that your vehicle warranty does not cover.
- Longer engine cranking periods.
- Increased emission levels.
- Reduced vehicle performance.
- Reduced fuel economy.



An oil that displays this symbol conforms to current engine, emission system and fuel economy performance standards of ILSAC.

We recommend Motorcraft motor oil for your vehicle. If Motorcraft oil is not available, use motor oils of the recommended viscosity grade that meet API SP requirements and display the API Certification Mark for gasoline engines.

Do not use supplemental engine oil additives because they are unnecessary and could lead to engine damage that your vehicle warranty does not cover.

### Capacities

Variant	Including the Oil Filter
All.	5.5 qt (5.2 L)

### Materials

Name	Specification
Motorcraft® SAE 5W-30 Synthetic Blend Motor Oil (U.S.) Motorcraft® SAE 5W-30 Super Premium Motor Oil / Huile moteur de très haute qualité SAE 5W-30 Motorcraft® (Canada) XO-5W30-Q1SP (U.S.) CXO-5W30-LSP6 (Canada)	WSS-M2C961-A1

# Capacities and Specifications

## Alternative Engine Oil for Extremely Cold Climates

To improve engine cold start performance,

we recommend that you use the following alternative engine oil in extremely cold climates, where the ambient temperature reaches  $-22.0^{\circ}\text{F}$  ( $-30^{\circ}\text{C}$ ) or below.

### Materials

Name	Specification
Engine Oil - SAE 0W-30 - Synthetic Blend	WSS-M2C963-A1

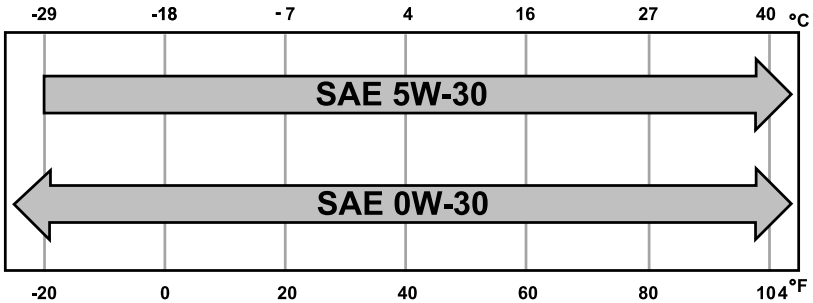

## ENGINE OIL CAPACITY AND SPECIFICATION - 1.5L ECOBOOST™

Use oil that meets the defined specification and viscosity grade.

If you do not use oil that meets the defined specification and viscosity grade, it could result in:

- Component damage that your vehicle warranty does not cover.
- Longer engine cranking periods.
- Increased emission levels.
- Reduced vehicle performance.
- Reduced fuel economy.



An oil that displays this symbol conforms to current engine, emission system and fuel economy performance standards of ILSAC.

# Capacities and Specifications

We recommend Motorcraft motor oil for your vehicle. If Motorcraft oil is not available, use motor oils of the recommended viscosity grade that meet API SP requirements and display the API

Certification Mark for gasoline engines.

Do not use supplemental engine oil additives because they are unnecessary and could lead to engine damage that your vehicle warranty does not cover.

## Capacities

Variant	Including the Oil Filter
All.	5.3 qt (5.05 L)

## Materials

Name	Specification
Motorcraft® SAE 5W-20 Synthetic Blend Motor Oil(U.S.) Motorcraft® SAE 5W-20 Super Premium Motor Oil / Huile moteur de très haute qualité SAE 5W-20 Motorcraft®(Canada) XO-5W20-Q1SP(U.S.) CXO-5W20-LSP6(Canada)	WSS-M2C960-A1

## Alternative Engine Oil for Extremely Cold Climates

To improve engine cold start performance, we recommend that you use the following alternative engine oil in extremely cold climates, where the ambient temperature reaches -22.0°F (-30°C) or below.

## Materials

Name	Specification
Motorcraft® SAE 0W-20 Synthetic Blend Motor Oil(U.S.) (Canada) XO-0W20-Q1SP(U.S.)	WSS-M2C962-A1

# Capacities and Specifications

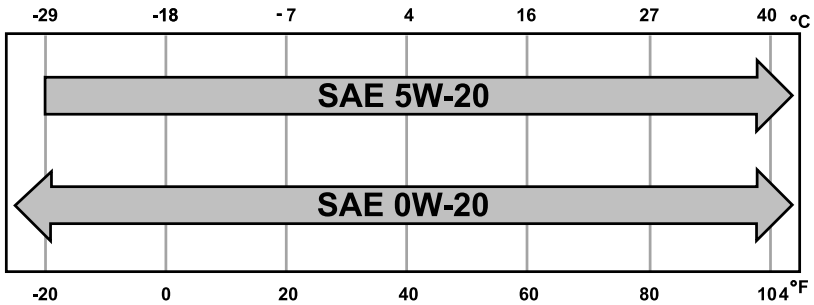

## COOLING SYSTEM CAPACITY AND SPECIFICATION - 2.0L ECOBOOST™

Use coolant that meets the defined specification.

If you do not use coolant that meets the defined specification, it could result in:

- Component damage that your vehicle warranty does not cover.
- Reduced vehicle performance.

### Capacities

Variant	Quantity
All.	8.6 qt (8.1 L)

### Materials

Name	Specification
Motorcraft® Yellow Prediluted Antifreeze/Coolant(U.S.) Motorcraft® Yellow Prediluted Antifreeze/Coolant / Antigel/liquide de refroidissement prédilué jaune Motorcraft®(Canada) VC-13DL-G(U.S.) CVC-13DL-G(Canada)	WSS-M97B57-A2

# Capacities and Specifications

## COOLING SYSTEM CAPACITY AND SPECIFICATION - 1.5L ECOBOOST™

Use coolant that meets the defined specification.

If you do not use coolant that meets the defined specification, it could result in:

- Component damage that your vehicle warranty does not cover.
- Reduced vehicle performance.

### Capacities

Variant	Quantity
All.	7.7 qt (7.3 L)

### Materials

Name	Specification
Motorcraft® Yellow Prediluted Antifreeze/ Coolant (U.S.) Motorcraft® Yellow Prediluted Antifreeze/Coolant / Antigel/liquide de refroidissement prédilué jaune Motorcraft® (Canada) VC-13DL-G (U.S.) CVC-13DL-G (Canada)	WSS-M97B57-A2

## FUEL TANK CAPACITY

### Capacities

Variant	Quantity
All.	15.7 gal (59.5 L)

# Capacities and Specifications

## AIR CONDITIONING SYSTEM CAPACITY AND SPECIFICATION - 2.0L ECOBOOST™



**WARNING:** The air conditioning refrigerant system contains refrigerant under high pressure. Only qualified personnel should service the air conditioning refrigerant system. Opening

the air conditioning refrigerant system can cause personal injury.

Use refrigerant and oil that meets the defined specifications.

If you do not use refrigerant and oil that meets the defined specifications, it could result in:

- Component damage that your vehicle warranty does not cover.
- Reduced vehicle performance.

### Capacities

Variant	Refrigerant	Refrigerant Oil
All.	19.4 oz (0.55 kg)	3.4 fl oz (100 ml)

### Materials

Name	Specification
R-1234yf Refrigerant(U.S.) R-1234yf Refrigerant / Frigorigène R-1234yf(Canada) YN-33-A(U.S.) HS7Z-19B519-BA(Canada)	WSS-M17B21-A
Motorcraft® R-1234yf Refrigerant PAG Oil(U.S.) Motorcraft® R-1234yf Refrigerant PAG Oil / Huile PAG pour frigorigène R-1234yf Motorcraft®(Canada) YN-35(U.S. & Canada)	WSS-M2C300-A2



# Capacities and Specifications

## AIR CONDITIONING SYSTEM CAPACITY AND SPECIFICATION - 1.5L ECOBOOST™

the air conditioning refrigerant system can cause personal injury.

Use refrigerant and oil that meets the defined specifications.

If you do not use refrigerant and oil that meets the defined specifications, it could result in:

- Component damage that your vehicle warranty does not cover.
- Reduced vehicle performance.



**WARNING:** The air conditioning refrigerant system contains refrigerant under high pressure. Only qualified personnel should service the air conditioning refrigerant system. Opening

### Capacities

Variant	Refrigerant	Refrigerant Oil
All.	19.4 oz (0.55 kg)	2.7 fl oz (80 ml)

### Materials

Name	Specification
R-1234yf Refrigerant(U.S.) R-1234yf Refrigerant / Frigorigène R-1234yf(Canada) YN-33-A(U.S.) HS7Z-19B519-BA(Canada)	WSS-M17B21-A
Motorcraft® R-1234yf Refrigerant PAG Oil(U.S.) Motorcraft® R-1234yf Refrigerant PAG Oil / Huile PAG pour frigorigène R-1234yf Motorcraft®(Canada) YN-35(U.S. & Canada)	WSS-M2C300-A2

## WASHER FLUID SPECIFICATION

### Capacities

Variant	Quantity
All.	Fill as required.

# Capacities and Specifications

## Materials

Name	Specification
Motorcraft® Premium Windshield Wash Concentrate with Bitterant(U.S.) Motorcraft® Premium Quality Windshield Washer Fluid / Liquide lave-glace de haute qualité Motorcraft®(Canada) ZC-32-B2(U.S.) CXC-37-A/B/D/F(Canada)	WSS-M14P19-A

## BRAKE FLUID SPECIFICATION

Use fluid that meets the defined specification and viscosity grade.

If you do not use fluid that meets the defined specification and viscosity grade, it could result in:

- Component damage that your vehicle warranty does not cover.
- Reduced brake performance.

**Note:** We recommend you use DOT 4 Low Viscosity (LV) High Performance Brake Fluid or equivalent meeting WSS-M6C65-A2. If you use any fluid other than the recommended fluid, it could cause reduced brake performance and not meet our performance standards. Keep brake fluid clean and dry. Contamination with dirt, water, petroleum products or other materials could result in brake system damage and possible failure.

## Capacities

Variant	Quantity
All.	Fill as required.

## Materials

Name	Specification
Motorcraft® DOT 4 LV High Performance Motor Vehicle Brake Fluid(U.S.) Motorcraft® DOT 4 LV High Performance Motor Vehicle Brake Fluid / Liquide de frein automobile haute performance DOT 4 LV Motorcraft®(Canada) PM-20(U.S. & Canada)	WSS-M6C65-A2

# Vehicle Identification

## VEHICLE IDENTIFICATION NUMBER

### Locating the Vehicle Identification Number

The vehicle identification number is on the left-hand side of the instrument panel.

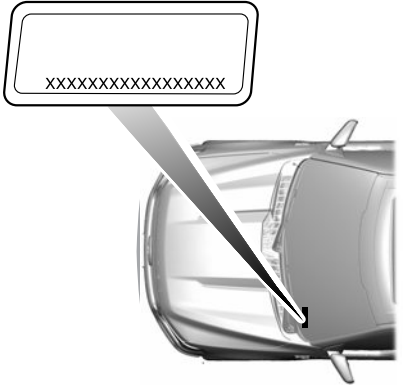

**Note:** In the illustration, XXXX is representative of your vehicle identification number.

### Vehicle Identification Number Overview

The vehicle identification number contains the following information:

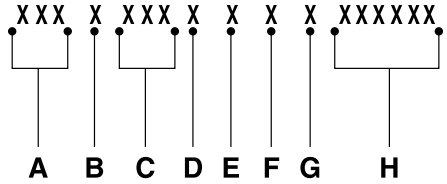

- A World manufacturer identifier.
- B Brake system, gross vehicle weight rating, restraint devices and their locations.
- C Make, vehicle line, series, body type.
- D Engine or motor type.
- E Check digit.
- F Model year.
- G Assembly plant.
- H Production sequence number.

# Connected Vehicle

---

## WHAT IS A CONNECTED VEHICLE

A connected vehicle has technology that allows your vehicle to connect to a mobile network and for you to access a range of features. When used in conjunction with the FordPass app, it could allow you to monitor and control your vehicle further, for example checking the tire pressures, the fuel level and the vehicle location. For additional information, refer to the local Ford website.

## CONNECTED VEHICLE REQUIREMENTS

Connected service and related feature functionality requires a compatible vehicle network.

Some remote features require additional service activation. Log in to your Ford account for details. Some restrictions, third party terms and message or data rates may apply.

## CONNECTED VEHICLE LIMITATIONS

Evolving technology, cellular networks, or regulations could affect functionality and availability, or continued provision of some features. These changes could even stop some features from functioning.

## CONNECTING THE VEHICLE TO A MOBILE NETWORK - VEHICLES WITH: MODEM

### What Is the Modem



The modem allows access to a range of features built into your vehicle.

### Enabling and Disabling the Modem

1. Press **Settings**.
2. Press **FordPass Connect**.
3. Press **Connectivity Settings**.
4. Switch connectivity features on or off.

### Connecting FordPass to the Modem

1. Make sure that the modem is enabled using the vehicle settings menu.
2. Open the FordPass app on your device and log in.
3. Add your vehicle or select your vehicle if already added.
4. Select the option for vehicle details.
5. Select the option to activate your vehicle.
6. Make sure that the name on the screen matches the name shown in your FordPass account.
7. Confirm that FordPass account is connected to the modem.

## CONNECTING THE VEHICLE TO A WI-FI NETWORK - VEHICLES WITH: SYNC 3

1. Press **Settings**.

## Connected Vehicle

---

2. Press **Wi-Fi**.
  3. Switch **Wi-Fi** on.
  4. Press **View Available Networks**.
  5. Select an available Wi-Fi network.
- Note:** Enter the network password to connect to a secure network.

### CONNECTED VEHICLE – TROUBLESHOOTING - VEHICLES WITH: MODEM

Symptom	Possible Cause and Resolution
I cannot confirm the connection of my FordPass account to the modem.	<ul style="list-style-type: none"><li>- Modem is not enabled.<ul style="list-style-type: none"><li>• Switch connectivity features on.</li></ul></li><li>- Weak network signal.<ul style="list-style-type: none"><li>• Move your vehicle closer to a place where the network signal is not obstructed.</li></ul></li></ul>

# Connected Vehicle

## CONNECTED VEHICLE – TROUBLESHOOTING - VEHICLES WITH: SYNC 3

Symptom	Possible Cause and Resolution
I cannot connect to a Wi-Fi network.	<ul style="list-style-type: none"><li>- Password error.<ul style="list-style-type: none"><li>• Enter the correct network password.</li></ul></li><li>- Weak network signal.<ul style="list-style-type: none"><li>• Move your vehicle closer to the Wi-Fi hotspot or to a place where the network signal is not obstructed.</li></ul></li><li>- Multiple access points in range with the same SSID.<ul style="list-style-type: none"><li>• Use a unique name for your SSID. Do not use the default name unless it contains a unique identifier, for example as part of the MAC address.</li></ul></li></ul>
The Wi-Fi connection disconnects after successful connection.	<ul style="list-style-type: none"><li>- Weak network signal.<ul style="list-style-type: none"><li>• Move your vehicle closer to the Wi-Fi hotspot or to a place where the network signal is not obstructed.</li></ul></li></ul>
I am close to a Wi-Fi hotspot but the network signal strength is weak.	<ul style="list-style-type: none"><li>- Obstructed network signal.<ul style="list-style-type: none"><li>• If your vehicle has a heated windshield, position your vehicle so that the windshield is not facing the Wi-Fi hotspot.</li><li>• If your vehicle has metallic tinting on the windows but not on the windshield, position your vehicle so that the windshield is facing the Wi-Fi hotspot or open the windows that are facing the hotspot.</li><li>• If your vehicle has metallic tinting on the windows and the windshield, open the windows that are facing the hotspot.</li><li>• If your vehicle is in a garage and you have the garage door closed, open the garage door.</li></ul></li></ul>
I cannot see a network in the list of available networks that I expect to see.	<ul style="list-style-type: none"><li>- Hidden network.<ul style="list-style-type: none"><li>• Make the network visible and try again.</li></ul></li></ul>

## Connected Vehicle

<b>Symptom</b>	<b>Possible Cause and Resolution</b>
I cannot see the Wi-Fi hotspot name when I search for Wi-Fi networks on my cell phone or other device.	<ul style="list-style-type: none"><li>- System limitation.<ul style="list-style-type: none"><li>• Make sure Wi-Fi hotspot visibility is on.</li><li>• The system does not provide a Wi-Fi hotspot at this time.</li></ul></li></ul>
Software downloads take too long.	<ul style="list-style-type: none"><li>- Weak network signal.<ul style="list-style-type: none"><li>• Move your vehicle closer to the Wi-Fi hotspot or to a place where the network signal is not obstructed.</li></ul></li><li>- Wi-Fi hotspot in high demand or has a slow Internet connection.<ul style="list-style-type: none"><li>• Use a more reliable Wi-Fi hotspot.</li></ul></li></ul>
The system seems to connect to a Wi-Fi network and the signal strength is excellent but the software does not update.	<ul style="list-style-type: none"><li>- No software update available.</li><li>- Wi-Fi network requires a subscription or acceptance of terms and conditions.<ul style="list-style-type: none"><li>• Test the connection using another device. If the network requires a subscription or acceptance of terms and conditions, contact the network service provider.</li></ul></li></ul>

# Vehicle Wi-Fi Hotspot

## CREATING A VEHICLE WI-FI HOTSPOT

You can create a Wi-Fi hotspot in your vehicle and allow devices to connect to it for access to the Internet.



Select the settings option on the feature bar.

1. Press **FordPass Connect**.
2. Press **Vehicle Hotspot**.

**Note:** The vehicle hotspot default setting is on.

3. Press **Settings**.
4. Press **Wi-Fi visibility**.

**Note:** The Wi-Fi Visibility default setting is on.

## Finding the Wi-Fi Hotspot Name and Password



Select the settings option on the feature bar.

1. Press **FordPass Connect**.
2. Press **Vehicle Hotspot**.
3. Press **Settings**.

**Note:** The SSID is the hotspot name.

4. Press **View Password**.

## Connecting a Device to the Wi-Fi Hotspot

1. On your device, switch Wi-Fi on and select the hotspot from the list of available Wi-Fi networks.
2. When prompted, enter the password.

## Purchasing a Data Plan

1. Connect a device to the hotspot.

**Note:** The vehicle network carrier's portal opens on your device.

2. If the portal does not open on your device, open a website and it redirects to the vehicle network carrier's portal.

**Note:** Secure websites do not redirect.

3. Follow the instructions on the carrier portal to purchase a plan.

**Note:** If you have an active plan, the system does not redirect to the vehicle network carrier's portal when you connect a device. Visit the vehicle network carrier's website to purchase more data.

**Note:** If data usage information is available in the vehicle hotspot menu, it is approximate.

**Note:** If you carry out a master reset, the system does not remove your vehicle from your vehicle network carrier's account. To remove your vehicle from the account, contact your vehicle network carrier.

**Note:** The vehicle network carrier provides Vehicle Hotspot services, subject to your vehicle network carrier agreement, coverage and availability.

## CHANGING THE VEHICLE WI-FI HOTSPOT NAME OR PASSWORD



Select the settings option on the feature bar.

1. Press **FordPass Connect**.
2. Press **Vehicle Hotspot**.
3. Press **Settings**.
4. Press **Edit**.
5. Press **Change SSID Name**.
6. Enter your required SSID.
7. Press **Done**.
8. Press **Change Password**.
9. Enter your required password.
10. Press **Done**.



# Audio System

## GENERAL INFORMATION



**WARNING:** Driving while distracted can result in loss of vehicle control, crash and injury. We strongly recommend that you use extreme caution when using any device that may take your focus off the road. Your primary responsibility is the safe operation of your vehicle. We recommend against the use of any

hand-held device while driving and encourage the use of voice-operated systems when possible. Make sure you are aware of all applicable local laws that may affect the use of electronic devices while driving.

## Radio Frequencies and Reception Factors

**Note:** *Listening to loud audio for long periods of time could damage your hearing.*

### Radio Reception Factors

<b>Distance and strength</b>	The further you travel from an AM or FM station, the weaker the signal and the weaker the reception.
<b>Terrain</b>	Hills, mountains, tall buildings, bridges, tunnels, freeway overpasses, parking garages, dense tree foliage and thunderstorms can interfere with the reception.
<b>Station overload</b>	When you pass a ground-based broadcast repeating tower, a stronger signal may overtake a weaker one and result in the audio system muting.

## AUDIO UNIT



**WARNING:** Driving while distracted can result in loss of vehicle control, crash and injury. We strongly recommend that you use extreme caution when using any device that may take your focus off the road. Your primary responsibility is the safe operation of your vehicle. We recommend against the use of any hand-held device while driving and encourage the use of voice-operated systems when possible. Make sure you are aware of all applicable local laws that may affect the use of electronic devices while driving.



E289731

**Note:** *Depending on your vehicle option package, the controls may look different from what you see here.*

**Note:** *Some features, such as satellite radio, may not be available in your location. Check with an authorized dealer.*

**Note:** *The touchscreen system controls most of the audio features.*

# Audio System

## Adjusting the Volume

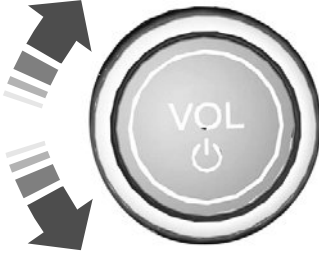

Turn to adjust the volume.

## Changing Radio Stations



E248947

In radio mode, turn to search through the radio frequency band.

In satellite radio mode, turn to find the previous or next available satellite radio station.

## Muting the Audio



Press and release the button to mute the playing audio.

## Pausing or Playing Media



In media mode, press and release the button to pause playback. Press the button again to resume playback.

In radio mode, press and release the button to mute the radio. Press the button again to unmute.

## Switching the Audio Unit On and Off



Press and release the button.

**Note:** *The button may be on the volume control.*

## Switching the Display On and Off



Press and release the button.

## Using Seek, Fast Forward and Reverse



Press and release the button to skip to the next track.

Press and hold the button to fast forward through the track.



Press and release the button to return to the beginning of a track.

Repeatedly press the button to return to previous tracks.

Press and hold the button to fast rewind.

In radio mode, select a frequency band and press and release either button. The system stops at the first station it finds in that direction.

# Audio System

---

In satellite radio mode, press and release to select the next or previous satellite radio station. If you select a specific category, such as jazz, rock or news, press to find the next or previous station in the category you select.

## **DIGITAL RADIO (IF EQUIPPED)**

**Note:** *HD Radio broadcasts are not available in all markets.*

HD Radio technology is the digital evolution of analog AM/FM radio. Your system has a special receiver that allows it to receive digital broadcasts, where available, in addition to the analog broadcasts, it already receives. Digital broadcasts provide a better sound quality than analog broadcasts with free, crystal-clear audio and no static or distortion. For more information, and a guide to available stations and programming, please visit [www.hdradio.com](http://www.hdradio.com).

When HD Radio is on and you tune to a station broadcasting HD Radio technology, you may notice the HD Radio logo on your screen. When this logo is available, you may also see Title and Artist fields on-screen.

The multicast indicator appears in FM mode, only, if the current station is broadcasting multiple digital broadcasts. The highlighted numbers signify available digital channels where new or different content is available. HD1 signifies the main programming status and is available in analog and digital broadcasts. Other multicast stations, HD2 through HD7, are only available digitally.

When HD Radio broadcasts are active, you can access the following functions:

- **Memory presets** allow you to save an active channel as a memory preset. Touch and hold a memory preset slot until the sound returns. There is a brief mute while the radio saves the station. Sound returns when finished. When switching to an HD2 or HD3 memory preset, the sound mutes before the digital audio plays, because the system has to reacquire the digital signal.

**Note:** *As with any saved radio station, you cannot access the saved station if your vehicle is outside the station's reception area.*

# Audio System

## HD Radio Reception and Station Troubleshooting

<b>Potential reception issues</b>	
Reception area	If you are listening to a multicast station and you are on the fringe of the reception area, the station may mute due to weak signal strength.
	If you are listening to HD1, the system switches back to the analog broadcast until the digital broadcast is available again. However, if you are listening to any of the possible HD2-HD7 multicast channels, the station mutes and stays muted unless it is able to connect to the digital signal again.
Station blending	When the system first receives a station, aside from HD2-HD7 multicast stations, it first plays the station in the analog version. Once the receiver verifies the station is an HD Radio station, it shifts to the digital version. Depending on the station quality, you may hear a slight sound change when the station changes from analog to digital. Blending is the shift from analog to digital sound or digital back to analog sound.

In order to provide the best possible experience, use the contact form to report any station issues found while listening to a station broadcasting with HD Radio technology. Independent entities own and operate each station. These stations are responsible for the accuracy of all audio streams and data fields.

# Audio System

Potential station issues		
Issues	Cause	Action
Echo, stutter, skip or repeat in audio. Increase or decrease in audio volume.	This is poor time alignment by the radio broadcaster.	No action required. This is a broadcast issue.
Sound fading or blending in and out.	The radio is shifting between analog and digital audio.	No action required. The reception issue may clear up as you continue to drive.
There is an audio mute delay when selecting HD2 or HD3, multicast preset or <b>Direct Tune</b> .	The digital multicast is not available until the HD Radio broadcast is decoded. Once decoded, the audio is available.	No action required. This is normal behavior. Wait until the audio is available.
Cannot access HD2 or HD3 multicast channel when recalling a preset or from a direct tune.	The previously stored multicast preset or direct tune is not available in your current reception area.	No action required. The station is not available in your current location.
Text information does not match currently playing audio.	Data service issue by the radio broadcaster.	Fill out the station issue form at website listed below. <sup>1</sup>
There is no text information shown for currently selected frequency.	Data service issue by the radio broadcaster.	Fill out the station issue form at website listed below. <sup>1</sup>

<sup>1</sup> <http://hdradio.com/stations/feedback>

HD Radio Technology manufactured under license from iBiquity Digital Corporation and foreign patents. HD Radio and the HD and HD Radio logos are proprietary trademarks of DTS Ford Motor Company and DTS are not responsible for the content sent using HD Radio technology. Content may be changed, added or deleted at any time at the station owner's discretion.

## SATELLITE RADIO (IF EQUIPPED)

SiriusXM® Satellite Radio broadcasts a variety of music, news, sports, weather, traffic and entertainment satellite radio channels. For more information and a complete list of SiriusXM satellite radio channels, visit [www.siriusxm.com](http://www.siriusxm.com) in the United States, [www.siriusxm.ca](http://www.siriusxm.ca) in Canada, or call SiriusXM at 1-888-539-7474.

# Audio System

**Note:** This receiver includes the eCos real-time operating system. eCos is published under the eCos License.

## Satellite Radio Reception Factors

Potential satellite radio reception issues	
Antenna obstructions	For optimal reception performance, keep the antenna clear of snow and ice build-up and keep luggage and other material as far away from the antenna as possible.
Terrain	Hills, mountains, tall buildings, bridges, tunnels, freeway overpasses, parking garages, dense tree foliage and thunderstorms can interfere with your reception.
Station overload	When you pass a ground-based broadcast-repeating tower, a stronger signal may overtake a weaker one and the audio system may mute.
Satellite radio signal interference	Your display may show ACQUIRING . . . to indicate the interference and the audio system may mute.

## SiriusXM Satellite Radio Service

**Note:** *SiriusXM reserves the unrestricted right to change, rearrange, add or delete programming including canceling, moving or adding particular channels, and its prices, at any time, with or without notice to you. Ford Motor Company shall not be responsible for any such programming changes.*



E208625

SiriusXM satellite radio is a subscription-based satellite radio service that broadcasts a variety of music, sports, news, weather, traffic and entertainment programming. Your factory-installed SiriusXM satellite radio system includes hardware and a limited subscription term, which begins on the date of sale or lease of your vehicle. See an authorized dealer for availability.

For more information on extended subscription terms (a service fee is required), the online media player and a complete list of SiriusXM satellite radio channels, and other features, please visit [www.siriusxm.com](http://www.siriusxm.com) in the United States, [www.siriusxm.ca](http://www.siriusxm.ca) in Canada, or call SiriusXM at 1-888-539-7474.

## Satellite Radio Electronic Serial Number (ESN)

You need your ESN to activate, modify or track your satellite radio account.

# Audio System

## Locating Your ESN

With satellite radio as the source, use the touchscreen to select the following:

1. Select **Settings**. See **Settings** (page 378).
2. Select **SiriusXM**.
3. Select **SiriusXM information**.

## Troubleshooting

Message	Condition	Action
Acquiring...	Radio requires more than two seconds to produce audio for the selected channel.	No action required. This message should disappear shortly.
Satellite antenna fault SIRIUS system failure	There is an internal module or system failure present.	If this message does not clear shortly, or with an ignition key cycle, your receiver may have a fault. See an authorized dealer for service.
Invalid Channel	The channel is no longer available.	Tune to another channel or choose another preset.
Unsubscribed Channel	Your subscription does not include this channel.	Contact SiriusXM at 1-888-539-7474 to subscribe to the channel, or tune to another channel.
No Signal	The signal is lost from the SiriusXM satellite or SiriusXM tower to your vehicle antenna.	The signal is blocked. When you move into an open area, the signal should return.
Updating...	Update of channel programming in progress.	No action required. The process may take up to three minutes.
Questions? Call 1-888-539-7474	Your satellite service is no longer available.	Contact SiriusXM at 1-888-539-7474 to resolve subscription issues.
None found Check Channel Guide	All the channels in the selected category are either skipped or locked.	Use the channel guide to turn off the Lock or Skip function on that station.
Subscription Updated	SiriusXM has updated the channels available for your vehicle.	No action required.

# Audio System

## USB PORT



**WARNING:** Driving while distracted can result in loss of vehicle control, crash and injury. We strongly recommend that you use extreme caution when using any device that may take your focus off the road. Your primary responsibility is the safe operation of your vehicle. We recommend against the use of any hand-held device while driving and encourage the use of voice-operated systems when possible. Make sure you are aware of all applicable local laws that may affect the use of electronic devices while driving.

## USB A



## USB C



The USB port allows you to plug in media playing devices, memory sticks and charge devices.

**Note:** We recommend using only USB-IF certified cables and adapters. Non-certified cables and adapters may not work.

## Locating the USB Ports

The USB ports may be in the following locations:

- Inside the media bin.
- Inside the center console.
- On the rear of the center console.

**Note:** The number and type of USB ports may vary depending on your vehicle.

**Note:** Only the USB ports located in the media bin have data transfer capabilities.



## GENERAL INFORMATION



**WARNING:** Driving while distracted can result in loss of vehicle control, crash and injury. We strongly recommend that you use extreme caution when using any device that may take your focus off the road. Your primary responsibility is the safe operation of your vehicle. We recommend against the use of any hand-held device while driving and encourage the use of voice-operated systems when possible. Make sure you are aware of all applicable local laws that may affect the use of electronic devices while driving.

### About SYNC

The system allows you to interact with the entertainment, information and communication systems on your vehicle using voice commands and a touchscreen. The system provides easy interaction with audio, phone, navigation, mobile apps and settings.

**Note:** You can switch the system on and use it for up to an hour without switching the ignition on.

**Note:** You can use the system after you switch the ignition off for up to 10 minutes or until you open a door.

**Note:** For your safety, some features are speed-dependent. Their use is limited to when your vehicle speed is less than 3 mph (5 km/h).

## Using the Touchscreen

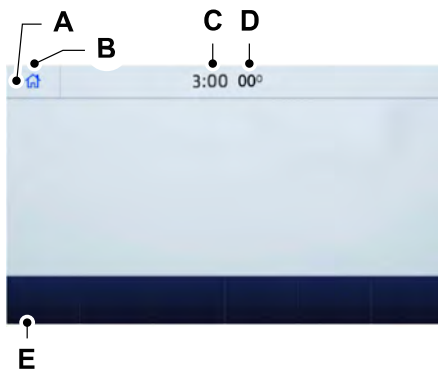

- A Status bar.
- B Home screen.
- C Clock. See **Settings** (page 378).
- D Outside air temperature.
- E Feature bar.

### Status Bar



Cell phone microphone muted.



Audio system muted.



Software update installed.



Wi-Fi connected.



Cell phone roaming.



Text message received.



Automatic crash notification system off.



Cell phone network signal strength.



Vehicle data sharing on.



Vehicle location sharing on.



Vehicle data and vehicle location sharing on.



Wireless charger active.

## Feature Bar



Select to use the radio, a USB, a media player or a Bluetooth device. See **Entertainment** (page 359).



Select to adjust climate settings



Select to make calls and access the phonebook on your cell phone. See **Phone** (page 369).



Select to use the navigation system. See **Navigation** (page 370).



Select to search for and use compatible apps on your iOS or Android device. See **Apps** (page 376).



Select to adjust system settings. See **Settings** (page 378).

## Cleaning the Touchscreen

See **Cleaning the Interior** (page 292).

## Updating the System

### Updating the System Using a USB Drive

#### Downloading an Update

1. Go to the SYNC update page on the local Ford website.
2. Download the update.

**Note:** *The website notifies you if an update is available.*

3. Insert a USB drive into your computer.

**Note:** *The USB drive needs to be empty and meet the minimum requirements detailed on the website.*

4. Follow the instructions provided to download the update to the USB drive.

#### Installing an Update

**Note:** *You can use the system when an installation is in progress.*

1. Disconnect all other USB devices from the USB ports.
2. Connect the USB drive with the update to a USB port.

**Note:** *Installation starts automatically within 10 minutes.*

### Updating the System Using a Wi-Fi Network Connection

#### Connecting to a Wi-Fi Network



Select the settings option on the feature bar.

1. Select **Automatic Updates**.
2. Select **System Wi-Fi**.
3. Switch **System Wi-Fi** on.
4. Select **Available Wi-Fi Networks**.
5. Select an available Wi-Fi network.

**Note:** *Enter the network password to connect to a secure network.*

## Switching Automatic System Updates On



Select the settings option on the feature bar.

1. Select **Automatic Updates**.
2. Switch **Automatic System Updates** on.

The system is now set to check for and receive system updates when it is connected to a Wi-Fi network.

**Note:** You can use the system when a download is in progress.

**Note:** If the system is disconnected from the Wi-Fi network when a download is in progress, the download continues the next time the system is connected to a Wi-Fi network.

## Additional Information and Assistance

For additional information and assistance, we recommend that you contact an authorized dealer or refer to the local Ford website.

## USING VOICE RECOGNITION

The SYNC 3 system allows you to use voice commands, to control features like audio and climate controls. By using voice commands, you can keep your hands on the wheel and your eyes on the road.

You can access each feature controlled by SYNC 3 through a variety of commands.



To activate the SYNC 3 voice commands push the voice button on the steering wheel and wait for the prompt.

\_\_\_ is a dynamic listing, meaning that it can be the name of anything, such as artist, the name of contact or number. The context and the description of the command tell you what to say for this dynamic option.

There are some commands that work for every feature, these commands are:

Voice Command	Action and Description
Main Menu	Brings you to the main menu.
Go back	Returns you to the previous screen.
Cancel	Ends the voice session.
List of Commands	Gives you a list of possible voice commands.
___ List of Commands	You can name any feature and the system gives a list of commands available for the feature. For example, you could say:
	Phone List of Commands
	Navigation List of Commands

# SYNC™ 3

Voice Command	Action and Description
Next Page	You can use this command to view the next page of options on any screen where multiple pages of choices are given.
Previous Page	You can use this command to view the previous page of options on any screen where multiple pages of choices are given.
Help	Gives you available commands you can use on the current screen.

Included here are some of the most popular commands for each SYNC 3 feature.

## Audio Voice Commands

\_\_\_ is a dynamic listing, meaning that for audio voice commands it can be the name of a Sirius channel or a channel number, a radio frequency number, or the name of an artist, album, song or a genre.

**To control the media features, press the voice button and when prompted, say:**

Voice command	Description
Sirius Channel ___ 1	You can say the Sirius channel name or number such as "Sirius channel 16".
You can also turn to a Sirius channel by saying the channel's name, such as "The Pulse".	
AM ___ FM ___	Allows you to tune to a specific FM or AM frequency such as "FM 88.7" or "AM 1580".
FM ___ HD ___ 1	Allows you to tune to a specific HD frequency such as "FM 88.7 HD 1".
Bluetooth Audio	Allows you to listen to music on your Bluetooth connected device.
USB	Allows you to listen to music on your USB connected device.
Play Genre ___ Play Playlist ___ Play Artist ___ Play Album ___ Play Podcast ___ Play Song ___	For USB audio only, you can say the name of an artist, album, song or a genre to listen to that selection. Your system must finish indexing before this option is available. For example, you could say "Play artist The Beatles" or "Play song Penny Lane".

# SYNC™ 3

Voice command	Description
Play Audiobook ____	
Browse ____ Browse Artist ____ Browse Album ____ Browse Genre ____ Browse Playlist ____ Browse Audiobook ____ Browse Podcast ____	For USB audio only, you can say the name of an artist, album, or a genre to browse by that selection. Your system must finish indexing before this option is available. For example you can say "Browse artist The Beatles" or "Browse genre folk".

<sup>1</sup> This option may not be available in all markets or may require a subscription.

## Climate Voice Commands (If Equipped)

You can control the temperature of the vehicle using voice commands.

\_\_\_\_ is a dynamic listing, meaning that for climate voice commands it can be the desired degrees for the temperature setting.

### To adjust the temperature, say:

Voice command	Description
Set the Temperature to ____	Adjust the temperature between 60–85°F (15.5–29.5°C).

## Phone Voice Commands

### Pairing a Phone

You can use voice commands to connect your Bluetooth enabled phone to the system.

### To pair your phone, press the voice button and when prompted, say:

Voice command	Description
Pair Phone	Follow the on-screen instructions to complete the pairing process. See <b>Settings</b> (page 378).

# SYNC™ 3

## Making Calls

\_\_\_ is a dynamic listing, meaning that for

phone voice commands it can be the name of the contact you wish to call or the digits you want to dial.

### Press the voice button and say a command similar to the following:

Voice command	Description
Call ___	Allows you to call a specific contact from your phonebook such as "Call Jenny".
Call ___ at ___	Allows you to call a specific contact from your phonebook at a specific location such as "Call Jenny at Home".
Dial ___	Allows you to dial a specific number such as "Dial 867-5309".

Please make sure that you are saying the contact name exactly as it appears in your contact list.

### Once you have provided the digits of the phone number, you can say the following commands:

Voice Command	Description
<0-9>	If you did not enter the full number with the first command, you can continue saying the number.
Dial	Tells SYNC 3 to make the phone call.
Delete	Tells SYNC 3 to erase the last block of digits you state.
Clear	Tells SYNC 3 to erase the entire number.

# SYNC™ 3

## Text Message Voice Commands

To access text message options, press the voice button and say:

Voice command	Description
Listen to Message	
Listen to text message ____	You can say the number of the message you would like to hear.
Reply to Message	
Reply to Message ____	You can say the number of the message you would like to respond to.
Reply to ____	You can say the contact of the most recent message to respond.

## Navigation Voice Commands (if Equipped)

### Setting a Destination

You can use any of the following commands to set a destination or find a point of interest.

**You can find an address, a point of interest (POI), or search for points of interest by category:**

Voice command	Description
Find an Address	Allows you to enter the address search functionality. You can also search for an address in a specific state or province.
Find a ____	State the name of the POI category or major brand name you would like to search for such as "Find restaurants".
Find a POI	Allows you to enter the POI search functionality.
Find an Intersection	Allows you to enter the intersection search functionality.
Find the Nearest <POI Category>	State the name of a POI category or major brand name you would like to search for.
Show Previous Destinations	Allows you to see a list of your previous destinations.

\_\_\_\_ is a dynamic listing, meaning that for navigation voice commands it can be a POI category or a major brand name, where major brand name is a chain with more than 20 locations

# SYNC™ 3

Voice command	Description
Show Favorites	Allows you to see a list of your favorite destinations.
Drive Home	Allows you to route to your home address.
Drive to Work	Allows you to route to your work address.

## In addition, you can say these commands when a route is active:

Voice command	Description
Cancel Route	Cancels the current route.
Detour	Allows you to select an alternate route.
Repeat Instruction	Repeats the last guidance prompt.
Show Route	Displays the active route.
Route Summary	Displays the list of upcoming maneuvers.
Where Am I	Provides current location.
Zoom in	Allows you to zoom in on the map.
Zoom out	Allows you to zoom out from the map.

## Mobile App Voice Commands (If Equipped)

### The following voice commands are always available:

Voice command	Description
Mobile Apps	SYNC 3 will prompt you to say the name of an app to start it on SYNC 3.
List Mobile Apps	SYNC 3 will list all of the currently available Mobile Apps.
Find Mobile Apps	SYNC 3 will search and connect to compatible app(s) running on your mobile device.



# SYNC™ 3

**There are also voice commands that you can use when app(s) are connected to SYNC 3:**

<b>Voice command</b>	<b>Description</b>
Say the name of an app	At any time, you can say the name of a mobile app to start the mobile app on SYNC 3.
Say the name of an app, followed by help	SYNC 3 will list the available voice commands for the specified app if the app is running on SYNC 3.

## **SiriusXM Traffic and Travel Link Voice Commands (If Equipped)**

SiriusXM Traffic and Travel Link may not be available in all markets. Activation and a subscription are required.

**You can say the following commands to access SiriusXM Traffic and Travel Link:**

<b>Voice command</b>	<b>Description</b>
Show Traffic	Displays a list of traffic incidents.
Show Weather Map	Displays the current weather map.
Show Fuel Prices	Displays a list of fuel prices.
Show 5 Day Forecast	Displays the 5 day weather forecast.
Help	

## **Voice Settings Commands**

**You can say the following commands to access the voice settings:**

<b>Voice command</b>	<b>Description</b>
Voice Settings	Allows you to enter the voice settings functionality.
Interaction Mode Standard	Sets standard prompting with longer prompts.
Interaction Mode Advanced	Sets advanced prompting with shorter prompts.
Phone Confirmation On	Allows the system to confirm before making a phone call.

# SYNC™ 3

Voice command	Description
Phone Confirmation Off	The system does not confirm before placing a call.
Voice Command Lists On	The system displays a short list of available commands.
Voice Command Lists Off	The system does not display the list of commands.

You can use the volume control to adjust the volume of the system voice prompts. While prompt is active, adjust the volume control up or down to your desired setting.

**Note:** Depending on the current climate control settings, the fan speed may automatically go down while issuing voice commands or while making and receiving phone calls via SYNC to reduce the amount of background noise in the vehicle. The fan speed will automatically return to normal operation once the voice session ends. You can adjust the fan speed during a voice session, simply press the fan buttons (or turn the fan knob) to increase or decrease the fan speed to the setting you prefer.

To disable this automatic fan speed reduction feature during voice sessions, press and hold the climate control AC and Recirculated air buttons simultaneously, release and then increase fan speed within 2 seconds. To re-enable this feature, repeat the above sequence.

## ENTERTAINMENT

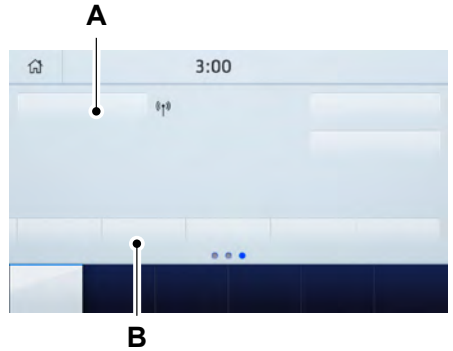

- A Audio source. Select to choose a different audio source.
- B Presets. Swipe left to view more presets.

You can access these options using the touchscreen or voice commands.

## Sources

Press this button to select the source of media you want to listen to.

# SYNC™ 3

Menu Item	
AM	
FM	
SIRIUS <sup>1</sup>	
CD	
USB	The name of the USB that is plugged in displays here.
Bluetooth Stereo	
Apps	If you have SYNC 3 compatible apps on your connected smart phone, they display here as individual source selections.

<sup>1</sup> This feature may not be available in all markets and requires an active subscription.

## AM/FM Radio

### Tuning a Station

You can use the tune or seek controls on the radio bezel to select a station.

### To tune a station using the touchscreen, select:

Menu Item
Direct Tune

A pop up appears, allowing you to type in the frequency of a station. You can only enter a valid station for the source you are currently listening to.

You can press the backspace button to delete the previously entered number.

### Once you have entered the station's call numbers, you can select:

Menu Item	Action and Description
Enter	Press to begin playing the station you have entered.
Cancel	Press to exit without changing the station.

### Presets

To set a new preset, tune to the station and then press and hold one of the memory preset buttons. The audio mutes briefly while the system saves the station and then returns.

You may be able to add additional preset pages using the settings option on the feature bar.

## SiriusXM® Satellite Radio (If Activated)

**Note:** *This feature may not be available in all markets and requires an active subscription.*



E234451

SiriusXM satellite radio is a subscription-based satellite radio service that broadcasts a variety of music, sports, news, weather, traffic and entertainment programming. Your factory-installed SiriusXM satellite radio system includes hardware and a limited subscription term that begins on the date of sale or lease of your vehicle. See an authorized dealer for availability.

For more information on extended subscription terms, a service fee is required, the online media player and a list of SiriusXM satellite radio channels, and other features, please visit [www.siriusxm.com](http://www.siriusxm.com) in the United States, [www.siriusxm.ca](http://www.siriusxm.ca) in Canada, or call SiriusXM at 1-888-539-7474.

**Note:** *SiriusXM reserves the unrestricted right to change, rearrange, add or delete programming. This includes canceling, moving or adding particular channels, and its prices, at any time, with or without notice to you. We are not responsible for any such programming changes.*

**Note:** *This receiver includes the eCos real-time operating system. eCos is published under the eCos License.*

### The following buttons are available for SiriusXM:

Menu Item	Action and Description	
Browse	Touch this button to see a list of available stations.	
Direct Tune	A pop-up appears, allowing you to type in the call numbers of a station. Once you enter the stations call numbers, you can select:	
	Enter	The system tunes to the station you select.
	Cancel	You exit the pop-up and the current station continues to play.
	You can press the backspace button to delete the previous number.	

# SYNC™ 3

Menu Item	Action and Description	
Replay	Replay audio on the current channel. You can replay approximately 45 minutes of audio as long as you remain tuned to the current station. Changing stations erases the previous audio.	
	Live	When you are in replay mode, you are not able to select a different preset until you return to live audio. Pressing this button returns you to the live broadcast.
ALERT	Save the current song, artist, or team as a favorite. The system alerts you when it plays again on any channel. Selecting this button allows you to enable and edit alerts.	

## Memory Presets

To set a preset, tune to the station then press and hold one of the memory preset buttons. The audio mutes briefly while the system saves the station and returns once the station is stored.

You may be able to add additional preset pages using the settings option on the feature bar.

## SiriusXM Satellite Radio Reception Factors and Troubleshooting

Potential Reception Issues	
Antenna obstructions	For optimal reception performance, keep the antenna clear of snow and ice build-up and keep luggage and other materials as far away from the antenna as possible.
Terrain	Hills, mountains, tall buildings, bridges, tunnels, freeway overpasses, parking garages, dense tree foliage and thunderstorms can interfere with your reception.
Station overload	When you pass a ground-based broadcast-repeating tower, a stronger signal may overtake a weaker one and the audio system may mute.
Satellite radio signal interference	Your display may show ACQUIRING... to indicate the interference and the audio system may mute.

# SYNC™ 3

Troubleshooting Tips		
Message	Cause	Action
Acquiring Signal	Radio requires more than two seconds to produce audio for the selected channel.	No action required. This message should disappear shortly.
Satellite antenna fault SIRIUS system failure	There is an internal module or system failure present.	If this message does not clear shortly, or with an ignition key cycle, your receiver may have a fault. See an authorized dealer for service.
Invalid Channel	The channel is no longer available.	Tune to another channel or choose another preset.
Unsubscribed Channel	Your subscription does not include this channel.	Contact SiriusXM at 1-888-539-7474 to subscribe to the channel, or tune to another channel.
Satellite acquiring signal...	The signal is lost from the SiriusXM satellite or SiriusXM tower to your vehicle antenna.	The signal is blocked. When you move into an open area, the signal should return.
Updating...	Update of channel programming in progress.	No action required. The process may take up to three minutes.
Questions? Call 1-888-539-7474	Your satellite service is no longer available.	Contact SiriusXM at 1-888-539-7474 to resolve subscription issues.
None found. Check channel guide.	All the channels in the selected category are either skipped or locked.	Use the channel guide or the Sirius XM Settings tile to turn off the Lock or Skip function on that station.
SIRIUS Subscription updated	SiriusXM has updated the channels available for your vehicle.	No action required.

## HD Radio™ Information (If Available)

To activate HD radio, please see the Radio Settings in the Settings Chapter.

**Note:** HD Radio broadcasts are not available in all markets.

## SYNC™ 3

HD Radio technology is the digital evolution of analog AM/FM radio. Your system has a special receiver that allows it to receive digital broadcasts, where available, in addition to the analog broadcasts it already receives. Digital broadcasts provide a better sound quality than analog broadcasts with free, crystal-clear audio and no static or distortion. For more information, and a guide to available stations and programming, please visit:

<b>Website</b>
<a href="http://www.hdradio.com">www.hdradio.com</a>

When HD Radio is on and you tune to a station broadcasting HD Radio technology, you may notice the following indicators on your screen:



The HD logo is grey when acquiring a digital station, and then changes to orange when digital audio is playing. When this logo is available, you may also see Title and Artist fields on-screen.

The multicast indicator only appears in FM mode if the current station is broadcasting multiple digital broadcasts. The highlighted numbers signify available digital channels where new or different content is available. HD1 signifies the main programming status and is available in analog and digital broadcasts. Other multicast stations, HD2 through HD7, are only available digitally.

**Note:** There is also an additional feature for stations that have more than 1 HD multicast, for example, HD1 or HD2. The HD logo and Radio text appears as a button. Pressing this button allows you to cycle through all of the HD stations on that specific frequency. For example, if you are on 101.1 and it has HD1, HD2, HD3, pressing the button repeatedly causes the radio to cycle through the HD stations in a cyclic increasing order.

### When HD Radio broadcasts are active, you can access the following functions:

Message	Action and Description
Presets	Allows you to save an active channel as a memory preset. Touch and hold a memory preset slot until the sound returns. There is a brief mute while the radio saves the station. Sound returns when the channel saves. When switching to an HD2 or HD3 memory preset, the sound mutes before the digital audio plays, because the system has to reacquire the digital signal.

**Note:** As with any station you save, you cannot access the saved station if your vehicle is outside the station's reception area.

# SYNC™ 3

## HD Radio Reception and Station Troubleshooting

<b>Potential Reception Issues</b>	
Reception area	If you are listening to a multicast station and you are on the fringe of the reception area, the station may mute due to weak signal strength.
	If you are listening to HD1, the system changes back to the analog broadcast until the digital broadcast is available again. However, if you are listening to any of the possible HD2-HD7 multicast channels, the station mutes and stays muted unless it is able to connect to the digital signal again.
Station blending	When the system first receives a station, aside from HD2-HD7 multicast stations, it first plays the station in the analog version. Once the receiver verifies the station is an HD Radio station, it shifts to the digital version. Depending on the station quality, you may hear a slight sound change when the station changes from analog to digital. Blending is the shift from analog to digital sound or digital back to analog sound.

In order to provide the best possible experience, use the contact form to report any station issues found while listening to a station broadcasting with HD Radio technology. Independent entities own and operate each station. These stations are responsible for ensuring all audio streams and data fields are accurate.

<b>Potential Station Issues</b>		
<b>Issues</b>	<b>Cause</b>	<b>Action</b>
Echo, stutter, skip or repeat in audio. Increase or decrease in audio volume.	This is poor time alignment by the radio broadcaster.	No action required. This is a broadcast issue.
Sound fading or blending in and out.	The radio is shifting between analog and digital audio.	No action required. The reception issue may clear up as you continue to drive.
There is an audio mute delay when selecting HD2 or HD3, multicast preset or Direct Tune.	The digital multicast is not available until the HD Radio broadcast is decoded. Once decoded, the audio is available.	No action required. This is normal behavior. Wait until the audio is available.



# SYNC™ 3

Potential Station Issues		
Issues	Cause	Action
Cannot access HD2 or HD3 multicast channel when recalling a preset or from a direct tune.	The previously stored multicast preset or direct tune is not available in your current reception area.	No action required. The station is not available in your current location.
Text information does not match currently playing audio.	Data service issue by the radio broadcaster.	Fill out the station issue form. <sup>1</sup>
There is no text information shown for currently selected frequency.	Data service issue by the radio broadcaster.	Fill out the station issue form. <sup>1</sup>

<sup>1</sup> You can find the form here:

Website
<a href="http://hdradio.com/stations/feedback">http://hdradio.com/stations/feedback</a>

HD Radio Technology manufactured under license from iBiquity Digital Corporation and foreign patents. HD Radio and the HD and HD Radio logos are proprietary trademarks of DTS. The vehicle manufacturer and DTS are not responsible for the content sent using HD Radio technology. Content may be changed, added or deleted at any time at the station owner's discretion.

## CD (If Equipped)

Once you select this option, the system returns you to the main audio screen.

The current audio information appears on the screen.

## The following buttons are also available:

Button	Function
Browse	You can use the browse button to select a track.
Repeat	When you select this button, a small number one displays to indicate the track is set to repeat.

# SYNC™ 3

Button	Function
	MP3 CDs: this button allows you to toggle through repeat off, repeat one track, a small number one displays, and repeat current folder, a small folder displays.
Shuffle	Select the shuffle symbol to have the audio on the disk play in random order.

You can use the forward, reverse, pause or play buttons to control the audio playback.

## Bluetooth Stereo or USB

Bluetooth Stereo and USB allow you to access media that you store on your Bluetooth device or USB device such as music, audio books or podcasts.

### The following buttons are available for Bluetooth and USB:

Button	Function
Repeat	Pressing the repeat button toggles the repeat setting through three modes: repeat off, button not highlighted, repeat all, button highlighted, and repeat track, button highlighted with a small number one.
Shuffle	Play the tracks in random order.

You can use the forward, reverse, pause or play buttons to control the audio playback.

To get more information about the currently playing track, press the cover art or Info button.

For some devices, SYNC 3 is able to provide 30-second skip buttons when you listen to audio books or podcasts. These buttons allow you to skip forward or backward within a track.

While playing audio from a USB device you can look for certain music by selecting the following:

Button	Function
Browse	If available, displays the list of tracks in the Now Playing playlist.
New Search	This option, which is available under browse, allows you to play all tracks or to filter the available media into one of the below categories.
	Play All

# SYNC™ 3

Button	Function
	Playlists
	Artist
	Albums
	Songs
	Genres
	Podcasts
	Audio books
	Composers
A-Z Jump	This button allows you to choose a specific letter to view within the category you are browsing.
Explore Device	If available, this allows you to browse the folders and files on your USB device.

## USB Ports



E285280

The USB ports are in the center console or inside of the media bin.

This feature allows you to plug in USB media devices, memory sticks, flash drives or thumb drives, and charge devices if they support this feature.

Select this option to play audio from your USB device.

## Apps

The system supports the use of certain audio apps such as iHeartRadio through a USB or Bluetooth enabled device.

Each app gives you different on-screen options depending on the app's content. See **Apps** (page 376).

## Supported Media Players, Formats and Metadata Information

The system is capable of hosting nearly any digital media player, including iPod, iPhone, and most USB drives.

Supported audio formats include MP3, WMA, WAV, AAC, and FLAC.

Supported audio file extensions include MP3, WMA, WAV, M4A, M4B, AAC, and FLAC.

Supported USB file systems include: FAT, exFAT, and NTFS.

# SYNC™ 3

SYNC 3 is also able to organize the media from your USB device by metadata tags. Metadata tags, which are descriptive software identifiers embedded in the media files, provide information about the file.

If your indexed media files contain no information embedded in these metadata tags, SYNC 3 may classify the empty metadata tags as unknown.

SYNC 3 is capable of indexing up to 50,000 songs per USB device, for up to 10 devices.

## PHONE



**WARNING:** Driving while distracted can result in loss of vehicle control, crash and injury. We strongly recommend that you use extreme caution when using any device that may take your focus off the road. Your primary responsibility is the safe operation of your vehicle. We recommend against the use of any hand-held device while driving and encourage the use of voice-operated systems when possible. Make sure you are aware of all applicable local laws that may affect the use of electronic devices while driving.

Check the compatibility of your device on the regional website.

### Pairing Your Cell Phone for the First Time

Go to the settings menu on your cell phone and switch Bluetooth on.



Select the phone option on the feature bar.

1. Select **Add Phone**.

**Note:** A prompt alerts you to search for your vehicle on your cell phone.

2. Select your vehicle on your cell phone.

**Note:** A number appears on your cell phone and on the touchscreen.

3. Confirm that the number on your cell phone matches the number on the touchscreen.

**Note:** The touchscreen indicates that you have successfully paired your cell phone.

4. Download the phonebook from your cell phone when you are prompted.

**Note:** If you pair more than one cell phone, use the phone settings to specify the primary phone. You can change this setting at any time.

## Using Your Cell Phone

### Recent Call List

Display and select an entry from a list of previous calls.

### Contacts

Display a smart search form to look up your contacts. Use the List button to alphabetically sort your contacts.

### Change Phone

Display the list of paired or connected devices that you can select.

### Phone Settings

Change ring tones, alerts or pair another phone.

### Do Not Disturb

Reject incoming calls and switch ring tones and alerts off.

### Phone Keypad

Directly dial a number.

## Mute

Mute the microphone when in a call or voice recognition session.

## Text Messaging

### Setting Text Message Notification

#### iOS

1. Go to the settings menu on your cell phone.
2. Select Bluetooth.

### Using Text Messaging

Menu Item	Description
Hear It	Hear the text message.
View	View the text message.
Call	Call the sender.
Reply	Reply to the text message with a standard text message.

## Apple CarPlay (If Equipped)

1. Connect your device to a USB port.
2. Follow the instructions on the touchscreen.

**Note:** Certain features of the system are not available when you are using Apple CarPlay.

### Switching Apple CarPlay Off



Select the settings option on the feature bar.

1. Select **Apple CarPlay Preferences**.
2. Switch **Apple CarPlay** off.

## Android Auto (If Equipped)

1. Connect your device to a USB port.

3. Select the information icon to the right of your vehicle.
4. Switch text message notification on.

## Android

1. Go to the settings menu on your cell phone.
2. Select Bluetooth.
3. Select the profiles option.
4. Select the phone profile.
5. Switch text message notification on.

2. Follow the instructions on the touchscreen.

**Note:** You might need to enable Android Auto from the settings menu.

**Note:** Certain features of the system are not available when you are using Android Auto.

### Switching Android Auto Off



Select the settings option on the feature bar.

1. Select **Android Auto**.
2. Switch **Android Auto** off.

## NAVIGATION (IF EQUIPPED)

**Note:** For more information, refer to our website.



Select the navigation option on the feature bar.

- C Zoom in.
- D Route guidance menu.
- E Destination entry menu.



- A Map view menu.
- B Zoom out.

## Setting a Destination

### Destination Entry Menu

Item	Description
Search	Enter a destination address.
Previous Destinations	Display and select from a list of previous destinations.
Home	Set your saved home address as your destination
Work	Set your saved place of work as your destination.
Favorites	Display and select from a list of favorite destinations.

## Setting a Destination Using the Text Entry Screen

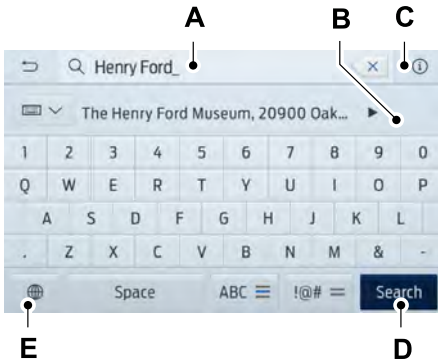

- A Text entry field.
- B Automatic suggestions based on the text you enter.
- C Information icon.
- D Search.
- E Keyboard settings.

**Note:** Select one of the suggestions to copy the detail to the text entry field.

You can search by entering all or part of the destination, such as the Address, POI Category or Name, Intersection, City, Latitude/Longitude, etc. **Tips:** If you do not specify a location, the system will use the current vehicle location. You can specify a location by address, city, state or zip code. For additional search support, please visit: [support.ford.com](http://support.ford.com).

**Note:** Press the button in the top right-hand corner of the main map to display estimated time of arrival, remaining travel time or distance to destination.

## Setting a Destination Using the Map Screen

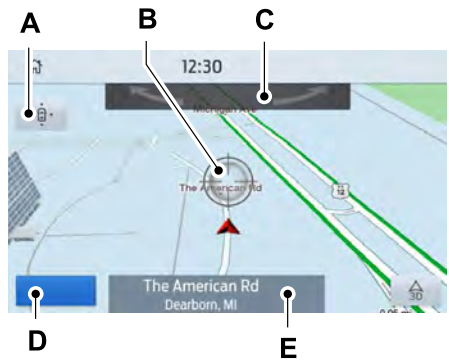

- A Re-center the map.
- B Selected location.
- C 3D map rotation. Swipe left or right.
- D Start route guidance.
- E Destination name.

Select the location on the map.

Select **Start** to begin route guidance.

## Changing the Format of the Map

Display the map in one of the following formats:

- A two-dimensional map with the direction you are traveling toward the top of the screen.
- A two-dimensional map with north toward the top of the screen.
- A three-dimensional map with the direction you are traveling toward the front.

## Zoom

Display more or less detail on the map.

**Note:** You can use pinch gestures to zoom in and out. Place two fingers on the screen and move them apart to zoom in. Place two fingers on the screen and bring them together to zoom out.

## Route Guidance

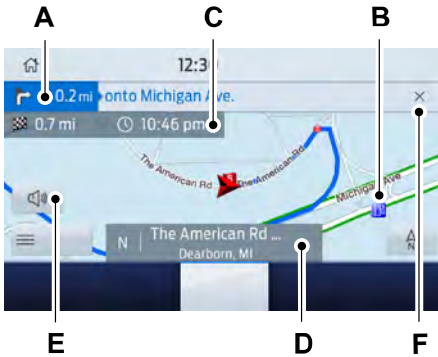

- C Estimated time of arrival, distance to destination or time to destination.
- D Current road.
- E Mute guidance prompts.
- F Cancel route guidance.

**Note:** To change guidance prompt volume, turn the volume control when a guidance prompt plays.

- A Turn indicator. Select to hear the last voice prompt.
- B Point of interest.

## Route Guidance Menu

Menu Item	Description
Screen View	Adjust your map preferences for when route guidance is active.
Full Map	View a full screen map when route guidance is active.
Highway Exit Info	View highway exit information for your current route.
Turn List	View the turn list for your current route. Select a road to avoid it.
Traffic List	You can find the SiriusXM Traffic and Travel Link information by pressing this button. This information requires an active subscription to SiriusXM Traffic and Travel Link. When a route is not active, a list of nearby traffic incidents displays. When a route is active, you can choose to display a list of traffic nearby or on the route.



# SYNC™ 3

Menu Item	Description
Navigation Settings	Adjust navigation settings. See <b>Settings</b> (page 378).
Where Am I?	View information about your current location.
Cancel Route	Cancel route guidance.
View Route	View the entire current route on the map.
Detour	View an alternative route compared to your current one.
Edit Waypoints	Change the order or remove waypoints.
Optimize Order	The system determines the order of waypoints for you.
Go	Go to the next screen and start the new route.

## Adjusting the Guidance Prompt Volume

Turn the volume control when a guidance prompt plays to adjust the volume.

**Note:** *If you have inadvertently adjusted the volume to zero, press the turn indicator button to play the last voice prompt and then adjust the volume to the desired level.*

## Muting Guidance Prompts



Select the mute option on the screen to mute guidance prompts.

**Note:** *The system mutes the next and all future guidance prompts.*

## Adding Waypoints

You can add a waypoint to a navigation route as a destination along your route. You can add up to five waypoints.

1. Select the search option on the map.
2. Set a destination.
3. Select **Add Waypoint**.
4. Select **Go**.

## Canceling Route Guidance



Select the route guidance menu option on the active guidance screen.

Select **Cancel Route**.

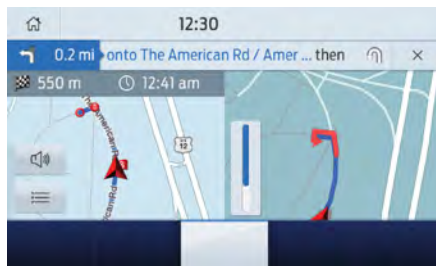

**Note:** *The route guidance menu option is always in the bottom right-hand corner of the main map.*

## cityseeker (If Equipped)

**Note:** *cityseeker point of interest (POI) information is limited to approximately 1,110 cities (1,049 in the United States, 36 in Canada and 15 in Mexico).*



E225487

cityseeker, when available, is a service that provides more information about certain points of interest such as restaurants, hotels and attractions.

When you have selected a point of interest, the location and information appear, such as address, phone number and a star rating.

Press **More Information** to see a photo, a review, a list of services and facilities, the average room or meal price and the web address. This screen displays the point of interest icons.

For restaurants, cityseeker can provide information such as star rating, average cost, review, handicap access, hours of operation, and website address.

For hotels, cityseeker can provide information such as star rating, price category, review, check-in and checkout times, hotel service icons and website address. Hotel service icons include:

- Restaurant
- Business center
- Handicap facilities
- Laundry
- Refrigerator
- 24 hour room service
- Fitness center
- Internet access
- Pool
- Wi-Fi

Attractions include nearby landmarks, amusement parks, historic buildings and more. cityseeker can provide information such as star rating, reviews, hour of operation and admission price.

### **SiriusXM Traffic and Travel Link (If Equipped)**

SiriusXM Traffic and Travel Link is available on vehicles equipped with navigation and only in select markets. You must activate and subscribe to receive SiriusXM Traffic and Travel Link information. It helps you locate the best gas prices, find movie listings, get current traffic alerts, view the weather map, get accurate ski conditions and see current sports scores.

The system calculates a reasonable efficient route based on available speed limits, traffic, and road conditions. You may know a local short cut that is more efficient at a given time than the route provided by SYNC 3, but you should expect a slight difference in minutes or miles with the SYNC 3 route.

### **Michelin Travel Guide (If Equipped)**

The Michelin travel guide is a service which provides additional information about certain places of interest, for example restaurants, hotels and tourist sites. Points of interest that have Michelin travel guide information display a button to show you more information. Push the button to see the additional information. If you have paired your phone with the system, you can press the phone button to directly establish a call with the selected point of interest.

## Navigation Map Accuracy and Updates

HERE is the digital map provider for the navigation application. If you find map data errors, you may report them directly to HERE by going to [www.here.com](http://www.here.com). HERE evaluates all reported map errors and responds with the result of their investigation by e-mail.

The navigation system map data may contain inaccurate or incomplete information due to the passage of time, changing circumstances, sources used and the nature of collecting comprehensive geographic data, any of which may lead to incorrect results. Inaccurate speed limit information, turn restrictions and other road attributes may affect the determined route and associated guidance.

Annual navigation map updates are available for purchase through your dealership. Depending on your purchase agreement, you might be eligible for free Map update. You can choose to download the Map data update onto a USB, order a USB, or use Wi-Fi to deliver automatic updates. To update your Map data over Wi-Fi, your vehicle must be connected to a Wi-Fi access point. Map Data files are large, so it is highly recommended to perform the update when free Wi-Fi is available otherwise high data rates may apply. For USB updates, free map update eligibility, and other details, contact dealers at 1-866-462-8837 in the United States and Canada or 01-800-557-5539 in Mexico or visit our local website for more information.

## APPS

The system allows you interact with select mobile apps while keeping your eyes on the road. Voice commands, your steering wheel buttons, or a quick tap on your touchscreen give you advanced control of compatible mobile apps. You can also stream your favorite music or podcasts, share your time of arrival with friends, and keep connected safely.

When you start an app through the system for the first time, you could be asked to grant certain permissions. You can review and change the permissions that you have granted at any time when your vehicle is not moving. We recommend that you check your data plan before using your apps through the system. Using them could result in additional charges. We also recommend that you check the app provider's terms and conditions and privacy policy before using their app. Make sure that you have an active account for apps that you want to use through the system. Some apps will work with no setup. Others require you to configure some personal settings before you can use them.

**Note:** For more information about available apps, visit [catalog.ford.com](http://catalog.ford.com).

### Using Apps on an iOS Device



Select the apps option on the feature bar.

1. If your device is connected via USB, switch Apple CarPlay off. See **Phone** (page 369).
2. Connect your device to a USB port or pair and connect using Bluetooth.
3. If prompted to enable CarPlay, select **Disable**.
4. Start the apps on your device that you want to use through SYNC.

**Note:** If you close the apps on your device, you will not be able to use them through the system.

5. Select the app that you want to use on the touchscreen.

**Note:** Connect your device to a USB port if you want to use a navigation app. When using a navigation app, keep your device unlocked and the app open.

## Using Apps on an Android Device



Select the apps option on the feature bar.

1. If your device is connected via USB, switch Android Auto off. See **Phone** (page 369).
2. Pair your device. See **Phone** (page 369).
3. Start the apps on your device that you want to use through SYNC.

**Note:** If you close the apps on your device, you will not be able to use them through the system.

4. Select **Find Mobile Apps**.

**Note:** The system searches and connects to compatible apps that are running on your device.

5. Select the app that you want to use on the touchscreen.

**Note:** Mobile Apps on your device use the USB port to establish a connection with SYNC. Some devices may lose the ability to play music over USB when Mobile Apps are enabled.

## Using Mobile Navigation on an Android Device

1. Connect your device to a USB port.
2. Switch Android Auto off. See **Phone** (page 369).
3. Switch on **Enable Mobile Apps via USB** in the Mobile Apps Settings tile.

4. Select the apps option on the feature bar.
5. Select the navigation app that you want to use on the touchscreen.

**Note:** When using a navigation app, keep your device unlocked and the app open.

## SiriusXM Traffic and Travel Link (If Equipped)



**WARNING:** Driving while distracted can result in loss of vehicle control, crash and injury. We strongly recommend that you use extreme caution when using any device that may take your focus off the road. Your primary responsibility is the safe operation of your vehicle. We recommend against the use of any hand-held device while driving and encourage the use of voice-operated systems when possible. Make sure you are aware of all applicable local laws that may affect the use of electronic devices while driving.

**Note:** SiriusXM Traffic and Travel Link may not be available in all markets.

**Note:** In order to use SiriusXM Traffic and Travel Link, your vehicle must have navigation.

**Note:** A paid subscription is required to access and use these features. Go to [www.siriusxm.com/travellink](http://www.siriusxm.com/travellink) for more information.

**Note:** Visit [www.siriusxm.com/traffic](http://www.siriusxm.com/traffic) and click on Coverage map and details for a complete listing of all traffic areas covered by SiriusXM Traffic and Travel Link.

**Note:** Neither Sirius nor Ford is responsible for any errors or inaccuracies in the SiriusXM Traffic and Travel Link services or its use in vehicles.

# SYNC™ 3

When you subscribe to SiriusXM Traffic and Travel Link, it can help you locate the best gas prices, find movie listings, get

current traffic alerts, view the current weather map, get accurate ski conditions and see scores to current sports games.

Menu Item	Action and Description	
Traffic on Route	Touch these buttons to identify traffic incidents on your route, near your vehicle's current location or near any of your favorite places, if programmed.	
Traffic Nearby		
Fuel Prices	Touch this button to view fuel prices at stations close to your vehicle's location or on an active navigation route.	
Movie Listings	Touch this button to view nearby movie theaters and their show times, if available.	
Weather	Touch this button to view the nearby weather, current weather, or the five-day forecast for the chosen area.	
	Map	Select to see the weather map, which can show storms, radar information, charts and winds.
	Area	Select to choose from a listing of weather locations.
Sports Info	Touch this button to view scores and schedules from a variety of sports. You can also save up to 10 favorite teams for easier access. The score automatically refreshes when a game is in progress.	
Ski Conditions	Touch this button to view ski conditions for a specific area.	

## SETTINGS



Press the button to enter the settings menu.



Once you select a tile, press the button next to a menu item to view an explanation of the feature or setting.

### Sound

Select this tile to adjust the sound settings.

### Clock

Select this tile to adjust the clock settings.

### Bluetooth

Select this tile to switch Bluetooth on and off and adjust the settings.

### Phone

Select this tile to connect, disconnect, and manage the connected device settings.

### Audio

Select this tile to adjust the audio settings.

## **Driver Assist (If Equipped)**

Select this tile to adjust Driver Assist features like Parking Aids, Lane Keeping System, Pedestrian Detection, and Auto-Start-Stop.

## **Vehicle**

Select this tile to adjust vehicle settings like windows, alarm, lighting, and MyKey settings.

## **FordPass**

Select this tile to adjust the FordPass settings.

## **General**

Select this tile to adjust settings like language, measurement units, or to reset the system.

## **911 Assist (If Equipped)**

Select this tile to switch 911 Assist on and off.

## **Automatic Updates**

Select this tile to adjust the automatic update settings.

## **Mobile Apps**

Select this tile to adjust permissions, enable, disable, and update mobile apps.

## **Display**

Select this tile to adjust display settings like brightness and auto dim.

## **Charge Settings (If Equipped)**

Select this tile to adjust the electric vehicle charge settings.

## **Voice Control**

Select this tile to adjust voice control settings like command confirmations and displayed lists.

## **Navigation (If Equipped)**

Select this tile to adjust navigation settings like map preferences and route guidance.

## **Multi Contour Seats (If Equipped)**

Select this tile to adjust the position and massage function of your multi contour seats.

## **Seats (If Equipped)**

Select this tile to adjust the lumbar function of your seats.

## **Message Center (If Equipped)**

Select this tile to view vehicle messages.

## **Personal Profiles (If Equipped)**

Select this tile to adjust recalled memory features when using personal profiles.

## **Valet Mode (If Equipped)**

Select this tile to enable and disable valet mode.

## **Ambient Lighting (If Equipped)**

Select this tile to change the color or intensity of the interior lighting.

## SYNC™ 3 TROUBLESHOOTING

### Voice Recognition

Symptom	Possible Cause and Resolution
The system does not understand what I am saying.	<ul style="list-style-type: none"> <li>- You are using the wrong voice commands.               <ul style="list-style-type: none"> <li>• See <b>Using Voice Recognition</b> (page 352).</li> <li>• For a complete list of voice commands, refer to our website.</li> </ul> </li> <li>- You are speaking too soon.               <ul style="list-style-type: none"> <li>• Wait for the voice prompt before you speak.</li> </ul> </li> </ul>
The system does not understand the name of a track or artist.	<ul style="list-style-type: none"> <li>- Device limitation. Bluetooth does not support voice commands.               <ul style="list-style-type: none"> <li>• Connect your device to a USB port.</li> <li>• If you have an iOS device, press and hold the voice control button on the steering wheel to use Siri to play specific tracks.</li> </ul> </li> <li>- You are using the wrong voice commands.               <ul style="list-style-type: none"> <li>• See <b>Using Voice Recognition</b> (page 352).</li> <li>• For a complete list of voice commands, refer to our website.</li> </ul> </li> <li>- You are not saying the name exactly as it appears on your device.               <ul style="list-style-type: none"> <li>• Say the name of the track or artist exactly as it appears on your device. Spell out any abbreviations in the name.</li> </ul> <p>The song or artist name may have some special characters that are not being recognized by the system.</p> </li> <li>- The name contains special characters, for example *, - or +.               <ul style="list-style-type: none"> <li>• Rename the files on your device or use the touch-screen to select and play the track.</li> </ul> </li> </ul>

# SYNC™ 3

Symptom	Possible Cause and Resolution
The system does not understand the name of a contact in the phonebook on my device and calls the wrong contact.	<ul style="list-style-type: none"> <li>– You are not saying the name exactly as it appears on your device.               <ul style="list-style-type: none"> <li>• Say the first and last name of the contact exactly as it appears on your device. Spell out any abbreviations in the name.</li> </ul> </li> <li>– The name contains special characters, for example *, - or +.               <ul style="list-style-type: none"> <li>• Rename the contact on your device or use the touchscreen to select and call the contact.</li> </ul> </li> </ul>
The system does not understand foreign names of contacts in the phonebook on my device.	<ul style="list-style-type: none"> <li>– You are not saying the name exactly as it appears on your device.               <ul style="list-style-type: none"> <li>• Say the first and last name of the contact exactly as it appears on your device. The system applies phonetic pronunciation rules of the selected language to the names of contacts in the phonebook on your device. Select the name of the contact on the touchscreen and use the Hear it option to get an idea of how the system expects you to pronounce it.</li> </ul> </li> </ul>
The system voice prompts and the pronunciation of some words does not seem to be very accurate.	<ul style="list-style-type: none"> <li>– Device limitation.               <ul style="list-style-type: none"> <li>• The system uses text-to-speech technology and uses a synthetically generated voice rather than pre-recorded human voice.</li> </ul> </li> </ul>

## USB and Bluetooth Audio

Symptom	Possible Cause and Resolution
I cannot connect my device.	<ul style="list-style-type: none"> <li>– Device malfunction.               <ul style="list-style-type: none"> <li>• Disconnect your device. Switch your device off, reset it and try again.</li> </ul> </li> <li>– Cable connection issue.               <ul style="list-style-type: none"> <li>• Correctly connect the cable to your device and the vehicle USB port.</li> </ul> </li> <li>– Incompatible cable.               <ul style="list-style-type: none"> <li>• Use the cable recommended by the manufacturer of your device.</li> </ul> </li> </ul>



# SYNC™ 3

Symptom	Possible Cause and Resolution
	<ul style="list-style-type: none"> <li>- Incorrect device settings.               <ul style="list-style-type: none"> <li>• Make sure that your device does not have an auto-install program or active security settings.</li> <li>• Check that your device is not set only to charge.</li> </ul> </li> <li>- Device lock screen enabled.               <ul style="list-style-type: none"> <li>• Unlock your device before connecting it.</li> </ul> </li> </ul>
The system does not recognize my device.	<ul style="list-style-type: none"> <li>- Device limitation.               <ul style="list-style-type: none"> <li>• Do not leave your device in your vehicle during very hot or very cold weather conditions.</li> </ul> </li> <li>- Cable connection issue.               <ul style="list-style-type: none"> <li>• Correctly connect the cable to your device and the vehicle USB port.</li> </ul> </li> <li>- Incompatible cable.               <ul style="list-style-type: none"> <li>• Use the cable recommended by the manufacturer of your device.</li> </ul> </li> </ul>
The system does not understand the name of a track or artist.	<ul style="list-style-type: none"> <li>- Device limitation. Bluetooth does not support voice commands.               <ul style="list-style-type: none"> <li>• Connect your device to a USB port.</li> <li>• If you have an iOS device, press and hold the voice control button on the steering wheel to use Siri to play specific tracks.</li> </ul> </li> </ul>
I cannot stream audio from my Bluetooth device.	<ul style="list-style-type: none"> <li>- Incompatible device.               <ul style="list-style-type: none"> <li>• Check the compatibility of your device on our website.</li> </ul> </li> <li>- Device not connected.               <ul style="list-style-type: none"> <li>• Pair your device. See <b>Phone</b> (page 369).</li> </ul> </li> <li>- Media player not running.               <ul style="list-style-type: none"> <li>• Start the media player on your device.</li> </ul> </li> </ul>
The system does not recognize the music on my device.	<ul style="list-style-type: none"> <li>- Missing or incorrect audio file metadata, for example artist, song title, album or genre.               <ul style="list-style-type: none"> <li>• Repair the files on your device.</li> </ul> </li> <li>- Corrupt files.               <ul style="list-style-type: none"> <li>• Repair the files on your device.</li> </ul> </li> </ul>

# SYNC™ 3

Symptom	Possible Cause and Resolution
	<ul style="list-style-type: none"> <li>– Copyright protected files.               <ul style="list-style-type: none"> <li>• Use a device that contains files that are not copyright protected.</li> </ul> </li> <li>– Unsupported file format.               <ul style="list-style-type: none"> <li>• Repair or convert the files to a supported format. See <b>Entertainment</b> (page 359).</li> </ul> </li> <li>– Device indexing required.               <ul style="list-style-type: none"> <li>• Re-index your device. See <b>Settings</b> (page 378).</li> </ul> </li> <li>– Device lock screen enabled.               <ul style="list-style-type: none"> <li>• Unlock your device before connecting it.</li> </ul> </li> </ul>
Sometimes I cannot hear a track playing on my device.	<ul style="list-style-type: none"> <li>– Device malfunction.               <ul style="list-style-type: none"> <li>• Disconnect your device. Switch your device off, reset it and try again.</li> </ul> </li> </ul>
When I disconnect my iOS device the audio volume is set to maximum.	<ul style="list-style-type: none"> <li>– Device limitation.               <ul style="list-style-type: none"> <li>• Turn the volume down on your device</li> </ul> </li> </ul>
The system does not play the tracks on my USB drive in the correct order.	<p>If the system does not play the tracks on your USB device in the correct order, the following information could help:</p> <ul style="list-style-type: none"> <li>– If you are selecting USB as the audio source when the system is still indexing, SYNC plays tracks sorted alphabetically by file name in the root directory.</li> <li>– If you are selecting USB as the audio source after the system has finished indexing, SYNC plays all tracks sorted alphabetically by the title in the ID3 tag regardless of where they are located. SYNC uses the file name if the title in the ID3 Tag does not exist.</li> <li>– If you are selecting the option to play all tracks from the browsing menu, SYNC plays all tracks sorted alphabetically by the title in the ID3 tag regardless of where they are located. SYNC uses the file name if the title in the ID3 Tag does not exist.</li> <li>– If you are selecting a track when using the explore device option, SYNC plays tracks sorted alphabetically by file name in the folder you have selected. SYNC then plays all tracks in any subfolders in the folder you have selected.</li> </ul>

# SYNC™ 3

## Phone

Symptom	Possible Cause and Resolution
During a call, I can hear excessive background noise.	<ul style="list-style-type: none"> <li>– Incorrect cell phone settings.               <ul style="list-style-type: none"> <li>• Check and adjust the audio settings on your cell phone. Refer to your cell phone's user manual.</li> </ul> </li> </ul>
During a call, I can hear the other person but they cannot hear me.	<ul style="list-style-type: none"> <li>– Cell phone malfunction.               <ul style="list-style-type: none"> <li>• Switch your cell phone and Bluetooth on and off and try again.</li> </ul> </li> <li>– Cell phone microphone muted.               <ul style="list-style-type: none"> <li>• Unmute your cell phone microphone.</li> </ul> </li> </ul>
During a call, I cannot hear the other person and they cannot hear me.	<ul style="list-style-type: none"> <li>– System restart required.               <ul style="list-style-type: none"> <li>• Restart the system. Switch the ignition off and open the door. Close the door and lock the vehicle. Wait until the touchscreen is off and any illuminated USB ports are not illuminated. Unlock the vehicle, switch the ignition on and try again.</li> </ul> </li> </ul>
I cannot download phonebook.	<ul style="list-style-type: none"> <li>– Incompatible cell phone.               <ul style="list-style-type: none"> <li>• Check the compatibility of your cell phone on our website.</li> </ul> </li> <li>– Incorrect cell phone settings.               <ul style="list-style-type: none"> <li>• Allow the system to retrieve contacts from your cell phone. Refer to your cell phone's user manual.</li> </ul> </li> <li>– Incorrect system settings.               <ul style="list-style-type: none"> <li>• Switch automatic phonebook download on. See <b>Settings</b> (page 378).</li> </ul> </li> <li>– Cell phone malfunction.               <ul style="list-style-type: none"> <li>• Switch your cell phone off, reset it and try again.</li> </ul> </li> </ul>
A message displays suggesting that my phonebook has downloaded but it is empty or it has missing contacts.	<ul style="list-style-type: none"> <li>– Incorrect cell phone settings.               <ul style="list-style-type: none"> <li>• Allow the system to retrieve contacts from your cell phone. Refer to your cell phone's user manual.</li> <li>• Check the location of the missing contacts on your cell phone. If they are stored on the SIM card, move them to the cell phone memory.</li> </ul> </li> <li>– Incorrect system settings.               <ul style="list-style-type: none"> <li>• Switch automatic phonebook download on. See <b>Settings</b> (page 378).</li> </ul> </li> </ul>

# SYNC™ 3

<b>Symptom</b>	<b>Possible Cause and Resolution</b>
I cannot connect my cell phone.	<ul style="list-style-type: none"><li>– Incompatible cell phone.<ul style="list-style-type: none"><li>• Check the compatibility of your cell phone on our website.</li></ul></li><li>– Cell phone malfunction.<ul style="list-style-type: none"><li>• Switch your cell phone off, reset it and try again.</li><li>• Install the latest cell phone firmware.</li><li>• Delete your device from system and delete SYNC from your device and try again.</li><li>• Switch automatic phonebook download off. See <b>Settings</b> (page 378).</li></ul></li></ul>
Text messaging does not work.	<ul style="list-style-type: none"><li>– You did not switch on text message notifications.<ul style="list-style-type: none"><li>• Switch text message notifications on. See <b>Phone</b> (page 369).</li></ul></li><li>– Incompatible cell phone.<ul style="list-style-type: none"><li>• Check the compatibility of your cell phone on our website.</li></ul></li><li>– Cell phone malfunction.<ul style="list-style-type: none"><li>• Switch your cell phone off, reset it and try again.</li></ul></li></ul>
I cannot hear text messages.	<ul style="list-style-type: none"><li>– Device message sharing is not enabled.<ul style="list-style-type: none"><li>• Check the permissions on your device to ensure text message sharing is enabled.</li></ul></li><li>– Incompatible cell phone.<ul style="list-style-type: none"><li>• Check the compatibility of your cell phone on our website.</li></ul></li></ul>

# SYNC™ 3

## Navigation (If Equipped)

Symptom	Possible Cause and Resolution
I cannot enter a street name when I am abroad.	– Incorrect entry method. <ul style="list-style-type: none"><li>• Enter the street name with the country.</li></ul>
The system does not recognize coordinates.	– You are using the wrong coordinates format. <ul style="list-style-type: none"><li>• Use the format ##. #####, ##. ##### (for N/S, E/W). Add a minus before coordinates if the direction is West and keep a positive value if the direction is East, for example 12.5412 means East and -12.5412 means West.</li></ul>

# SYNC™ 3

## Apps

Symptom	Possible Cause and Resolution
The system cannot find any apps.	<ul style="list-style-type: none"><li>– Incompatible device.<ul style="list-style-type: none"><li>• You will need an Android device with OS 4.3 or higher or an iOS device with iOS 8.0 or higher. Pair and connect your Android device to find AppLink compatible apps. Connect your iOS device to a USB port or pair and connect using Bluetooth.</li></ul></li></ul>
I have a compatible device and it is correctly connected but the system still cannot find any apps.	<ul style="list-style-type: none"><li>– AppLink compatible apps not installed on your device.<ul style="list-style-type: none"><li>• Download and install the latest version of the app.</li></ul></li><li>– AppLink compatible apps not running on your device.<ul style="list-style-type: none"><li>• Start the apps to allow the system to find them and make sure you sign in to any apps if required.</li></ul></li><li>– Incorrect app settings.<ul style="list-style-type: none"><li>• Check and adjust the app settings on your device and allow SYNC to access the app if required.</li></ul></li></ul>
I have a compatible device, it is correctly connected and my apps are running but the system still cannot find any apps.	<ul style="list-style-type: none"><li>– Apps failed to fully close.<ul style="list-style-type: none"><li>• Restart the apps and try again.</li><li>• If you have an Android device with apps that have an exit or quit option, use this and then restart the apps. Alternatively, use the force stop option in the settings menu on your device.</li><li>• If you have an iOS device with iOS 7.0 or higher, tap the home button on your device twice and then swipe the app upward to close it.</li></ul></li></ul>
I have an Android device that is correctly connected, I have restarted my apps and they are running but the system still cannot find them.	<ul style="list-style-type: none"><li>– An issue on some older versions of the Android operating system could result in apps not being found.<ul style="list-style-type: none"><li>• Switch Bluetooth off and on again to force the system to reconnect to your device.</li></ul></li></ul>

## SYNC™ 3

<b>Symptom</b>	<b>Possible Cause and Resolution</b>
I have an iOS device that is correctly connected, I have restarted my apps and they are running but the system still cannot find them.	<ul style="list-style-type: none"><li>- Cable connection issue.<ul style="list-style-type: none"><li>• Disconnect the cable from your device, wait for a moment and then connect it again to force the system to reconnect to your device.</li></ul></li></ul>
I have an Android device running a media app which the system has found but I cannot hear the sound or the sound is very quiet.	<ul style="list-style-type: none"><li>- Device volume is low.<ul style="list-style-type: none"><li>• Turn the volume up on your device.</li></ul></li></ul>
I have an Android device running a number of compatible apps but the system cannot find all of them.	<ul style="list-style-type: none"><li>- Device limitation. Some Android devices have a limited number of Bluetooth ports that apps can use to connect. If you have more apps running on your device than the number of available Bluetooth ports, the system cannot find all of them.<ul style="list-style-type: none"><li>• Close some of the apps to allow the system to find those that you want to use.</li></ul></li></ul>

## Wi-Fi Connectivity

Symptom	Possible Cause and Resolution
I cannot connect to a Wi-Fi network.	<ul style="list-style-type: none"> <li>– Password error.               <ul style="list-style-type: none"> <li>• Enter the correct network password.</li> </ul> </li> <li>– Weak network signal.               <ul style="list-style-type: none"> <li>• Move your vehicle closer to the Wi-Fi hotspot or to a place where the network signal is not obstructed.</li> </ul> </li> <li>– Multiple access points in range with the same SSID.               <ul style="list-style-type: none"> <li>• Use a unique name for your SSID. Do not use the default name unless it contains a unique identifier, for example as part of the MAC address.</li> </ul> </li> </ul>
The Wi-Fi connection disconnects after successful connection.	<ul style="list-style-type: none"> <li>– Weak network signal.               <ul style="list-style-type: none"> <li>• Move your vehicle closer to the Wi-Fi hotspot or to a place where the network signal is not obstructed.</li> </ul> </li> </ul>
I am close to a Wi-Fi hotspot but the network signal strength is weak.	<ul style="list-style-type: none"> <li>– Obstructed network signal.               <ul style="list-style-type: none"> <li>• If your vehicle has a heated windshield, position your vehicle so that the windshield is not facing the Wi-Fi hotspot.</li> <li>• If your vehicle has metallic tinting on the windows but not on the windshield, position your vehicle so that the windshield is facing the Wi-Fi hotspot or open the windows that are facing the hotspot.</li> <li>• If your vehicle has metallic tinting on the windows and the windshield, open the windows that are facing the hotspot.</li> <li>• If your vehicle is in a garage and you have the garage door closed, open the garage door.</li> </ul> </li> </ul>
I cannot see a network in the list of available networks that I expect to see.	<ul style="list-style-type: none"> <li>– Hidden network.               <ul style="list-style-type: none"> <li>• Make the network visible and try again.</li> </ul> </li> </ul>



# SYNC™ 3

Symptom	Possible Cause and Resolution
I cannot see SYNC when I search for Wi-Fi networks on my cell phone or other device.	<ul style="list-style-type: none"> <li>– System limitation.                             <ul style="list-style-type: none"> <li>• SYNC does not provide a Wi-Fi hotspot at this time.</li> </ul> </li> </ul>
Software downloads take too long.	<ul style="list-style-type: none"> <li>– Weak network signal                             <ul style="list-style-type: none"> <li>• Move your vehicle closer to the Wi-Fi hotspot or to a place where the network signal is not obstructed.</li> </ul> </li> <li>– Wi-Fi hotspot in high demand or has a slow Internet connection.                             <ul style="list-style-type: none"> <li>• Use a more reliable Wi-Fi hotspot.</li> </ul> </li> </ul>
The system seems to connect to a Wi-Fi network and the signal strength is excellent but the software does not update.	<ul style="list-style-type: none"> <li>– No software update available.</li> <li>– Wi-Fi network requires a subscription or acceptance of terms and conditions.                             <ul style="list-style-type: none"> <li>• Test the connection using another device. If the network requires a subscription or acceptance of terms and conditions, contact the network service provider.</li> </ul> </li> </ul>

## Personal Profiles (If Equipped)

Symptom	Possible Cause and Solution
I cannot create a profile.	You have not set up Personal Profiles.
	You entered an invalid profile.
	You did not select a memory button when prompted.
	You did not have the ignition on or in park (P), or you shifted out park (P) when creating a profile.
	Personal Profiles has been switched off.
I cannot link a remote control.	You did not select the lock button on the remote control.
	The remote control selected was already associated with another profile and the system declined to overwrite.
	The system performed a profile recall when linking a remote control.
	You did not have the ignition on or in park (P), or you shifted out park (P) when creating a profile.

# SYNC™ 3

Symptom	Possible Cause and Solution
	You are using the old linking method.
My personalized settings do not save.	Personal Profiles does not support your unsaved settings.
	A different personal profile is active.
	Another user changed the settings for the wrong personal profile.
My profile will not recall.	You did not create a personal profile.
	Personal Profiles is turned off.
	The profile you requested is already active.
	You did not link the memory button you are using to a profile.
	You did not link the remote control you are using to a profile.
	You are using the wrong remote control.
	You are pressing a button other than the unlock or remote start on a linked remote control.
My preset positions recall, but my profile does not.	You switched the personal profiles off.
My profile recalls but my preset positions do not.	The vehicle is in motion.
	The preset positions are the same as the guest or previously active profile.
I lost a remote control.	Unlink and relink your remote control in the Personal Profiles menu. You may need to see your authorized dealer.
I lost all profiles.	You erased and reprogrammed the remote controls. This could happen if you let a dealership add a new remote control to replace a lost one.
	Someone performed a master reset without your knowledge.

## Resetting the System

1. Simultaneously press and hold the seek up and the audio unit power buttons until the screen goes black.
2. Wait three minutes to allow the system to complete the reset.
3. Press the audio unit power button to switch the system on.

**Note:** *You can reset the system to restore functionality that has stopped working. The system reset is designed to restore functionality and not delete any data that you have stored.*

## Additional Information and Assistance

For additional information and assistance, we recommend that you contact an authorized dealer or refer to our website.

# Accessories

For a complete listing of the accessories that are available for your vehicle, please contact your authorized dealer or visit the online store web site:

<b>Web Address (United States)</b>
<a href="http://www.Accessories.Ford.com">www.Accessories.Ford.com</a>

<b>Web Address (Canada)</b>
<a href="http://www.Accessories.Ford.ca">www.Accessories.Ford.ca</a>

We will repair or replace any properly authorized dealer-installed Ford Original Accessory found to be defective in factory-supplied materials or workmanship during the warranty period, as well as any component damaged by the defective accessories.

We will warrant your Ford Original Accessory through the warranty that provides the greatest benefit:

- 24 months, unlimited mileage.
- The remainder of your new vehicle limited warranty.

Contact an authorized dealer for details and a copy of the warranty.

Ford Licensed Accessories are the accessory manufacturer's designs. The manufacturer develops and therefore warrants Ford Licensed Accessories, and does not design or test these accessories to Ford Motor Company engineering requirements. Contact an authorized Ford dealer for the manufacturer's limited warranty details, and request a copy of the Ford Licensed Accessories product limited warranty from the accessory manufacturer.

For maximum vehicle performance, keep the following information in mind when adding accessories or equipment to your vehicle:

- When adding accessories, equipment, passengers and luggage to your vehicle, do not exceed the total weight capacity of the vehicle or of the front or rear axle (GVWR or GAWR as indicated on the Safety Compliance Certification label). Ask an authorized dealer for specific weight information.
- The Federal Communications Commission (FCC) and Canadian Radio Telecommunications Commission (CRTC) regulate the use of mobile communications systems that are equipped with radio transmitters, for example two-way radios, telephones and theft alarms. Any such equipment installed in your vehicle should comply with Federal Communications Commission (FCC) and Canadian Radio Telecommunications Commission (CRTC) regulations and should be installed only by an authorized dealer.
- An authorized dealer needs to install mobile communications systems. Improper installation may harm the operation of your vehicle, particularly if the manufacturer did not design the mobile communication system specifically for automotive use.
- If you or an authorized Ford dealer add any non-Ford electrical or electronic accessories or components to your vehicle, you may adversely affect battery performance and durability. In addition, you may also adversely affect the performance of other electrical systems in the vehicle.

# Ford Protect

---

PROTECT YOURSELF FROM THE RISING COST OF VEHICLE REPAIRS WITH A FORD PROTECT EXTENDED SERVICE PLAN.

## **Ford Protect Extended Service Plans (U.S. Only)**

Ford Protect extended service plan means peace of mind. It's the extended service plan backed by Ford Motor Company, and provides more protection beyond the New Vehicle Limited Warranty coverage. When you visit your Ford Dealer, Insist on Ford Protect extended service plans!

## **Ford Protect Can Quickly Pay for Itself**

One trip to the Service Center could easily exceed the price of your Ford Protect extended service plan. With Ford Protect extended service plan you minimize your risk for unexpected repair bills and rising repair costs.

## **Up to 1,000+ Covered Vehicle Components**

There are four mechanical Ford Protect extended service plans with different levels of coverage. Ask your authorized dealer for details.

1. PremiumCARE - Our most comprehensive coverage. With over 1,000 covered components, this plan is so complete it's probably easier to list what's not covered.
2. ExtraCARE - Covers 113 components, and includes many high-tech items.
3. BaseCARE - Covers 84 components.
4. PowertrainCARE - Covers 29 critical components.

Ford Protect extended service plans are honored by all authorized Ford dealers in the U.S., Canada and Mexico.

That means you get:

- Reliable, quality service at any Ford or Lincoln dealership.
- Repairs performed by factory trained technicians, using genuine parts.

## **Rental Car Reimbursement**

### ***1st day Rental Benefit***

If you bring your car into your dealer for service, we'll give you a loaner to use for the day.

### ***Extended Rental Benefits***

If your vehicle is kept overnight for covered repairs, you are eligible for rental car coverage, including warranty repairs, and Field Service Actions.

## **Roadside Assistance**

Exclusive 24/7 roadside assistance, including:

- Towing, flat-tire change and battery jump starts.
- Out of fuel and lock-out assistance.
- Travel expense reimbursement for lodging, meals and rental car.
- Assistance for taxi, shuttle, rental car coverage or other transportation.

## **Transferable Coverage**

If you sell your vehicle before your Ford Protect extended service plan coverage expires, you can transfer any remaining coverage to the new owner. Which should give you and your potential buyer a little more peace of mind.

# Ford Protect

---

## Less Cost to Properly Maintain Your Vehicle

Ford Protect extended service plan also offers a Premium Maintenance Plan that covers all scheduled maintenance, and selected wear items. The coverage is prepaid, so you never have to worry about the cost of your vehicle's maintenance.

Covered maintenance includes:

- Windshield wiper blades.
- Spark plugs.
- The clutch disc (if equipped).
- Brake pads and linings.
- Shock absorbers.
- Struts.
- Engine Belts.
- Engine coolant hoses, clamps and o-rings.
- Diesel exhaust fluid replenishment (if equipped).
- Cabin air filter replacement every 20,000 mi (32,000 km) (electric vehicles only).

## Interest Free Finance Options

Just a 5% down payment will provide you with an affordable, no interest, no fee payment program allowing you all the security and benefits Ford Protect extended service plan has to offer while paying over time. You are pre-approved with no credit check or hassles. To learn more, call our Ford Protect extended service plan specialists at 800-367-3377.

Ford Protect Extended Service Plan  
P.O. Box 321067  
Detroit, MI 48232

## Ford Protect Extended Service Plan (CANADA ONLY)

You can get more protection for your vehicle by purchasing a Ford Protect extended service plan. Ford Protect extended service plan is the only service contract backed by Ford Motor Company of Canada, Limited. Depending on the plan you purchase, Ford Protect extended service plan provides benefits such as:

- Rental reimbursement.
- Coverage for certain maintenance and wear items.
- Protection against repair costs after your New Vehicle Limited Warranty Coverage expires.
- Roadside Assistance benefits.

There are several Ford Protect extended service plans available in various time, distance and deductible combinations. Each plan is tailored to fit your own driving needs, including reimbursement for towing and rental. When you purchase Ford Protect extended service plan, you receive added peace-of-mind protection throughout Canada, the United States and Mexico, provided by a network of participating authorized Ford Motor Company dealers.

**Note:** *Repairs performed outside of Canada and the United States are not eligible for Ford Protect extended service plan coverage.*

This information is subject to change. For more information; visit your local Ford of Canada dealer or [www.ford.ca](http://www.ford.ca) to find the Ford Protect extended service plan that is right for you.

# Scheduled Maintenance

---

## GENERAL MAINTENANCE INFORMATION

### Why Maintain Your Vehicle?

Carefully following the maintenance schedule helps protect against major repair expenses resulting from neglect or inadequate maintenance and may help to increase the value of your vehicle when you sell or trade it. Keep all receipts for completed maintenance with your vehicle.

We have established regular maintenance intervals for your vehicle based upon rigorous testing. It is important that you have your vehicle serviced at the proper times. These intervals serve two purposes; one is to maintain the reliability of your vehicle and the second is to keep your cost of owning your vehicle down.

It is your responsibility to have all scheduled maintenance performed and to make sure that the materials used meet the specifications identified in this owner's manual. See **Capacities and Specifications** (page 323).

Failure to perform scheduled maintenance invalidates warranty coverage on parts affected by the lack of maintenance.

### Why Maintain Your Vehicle at Your Dealership?

#### Factory-Trained Technicians

Service technicians participate in extensive factory-sponsored certification training to help them become experts on the operation of your vehicle. Ask your dealership about the training and certification their technicians have received.

### Genuine Ford and Motorcraft® Replacement Parts

Dealerships stock Ford, Motorcraft and Ford-authorized branded re-manufactured replacement parts. These parts meet or exceed our specifications. Parts installed at your dealership carry a nationwide 24-month or unlimited mile (kilometer) parts and labor limited warranty.

If you do not use our authorized parts they may not meet our specifications and depending on the part, it could affect emissions compliance.

### Convenience

Many dealerships have extended evening and Saturday hours to make your service visit more convenient and they offer one stop shopping. They can perform any services that are required on your vehicle, from general maintenance to collision repairs.

**Note:** *Not all dealers have extended hours or body shops. Please contact your dealer for details.*

### Protecting Your Investment

Maintenance is an investment that pays dividends in the form of improved reliability, durability and resale value. To maintain the proper performance of your vehicle and its emission control systems, make sure you have scheduled maintenance performed at the designated intervals.

Your vehicle has an Intelligent Oil-Life Monitor system, a message appears in the information display at the proper oil change interval. This interval may be up to one year or 10,000 mi (16,000 km).

# Scheduled Maintenance

When the oil change message appears in the information display, it is time for an oil change. Make sure you perform the oil change within two weeks or 500 mi (800 km) of the message appearing. Make sure you reset the Intelligent Oil-Life Monitor after each oil change. See **Oil Change Indicator Reset** (page 275).

If your information display resets prematurely or becomes inoperative, you should perform the oil change interval at six months or 5,000 mi (8,000 km) from your last oil change. Never exceed one year or 10,000 mi (16,000 km) between oil change intervals.

Your vehicle is very sophisticated and built with multiple, complex, performance systems. Every manufacturer develops these systems using different specifications and performance features. That is why it is important to rely upon your dealership to properly diagnose and repair your vehicle.

We have recommended maintenance intervals for various parts and component systems based upon engineering testing. We rely upon this testing to determine the most appropriate mileage for replacement of oils and fluids to protect your vehicle at the lowest overall cost to you. We recommend against maintenance schedules that deviate from the scheduled maintenance information.

We strongly recommend the use of only genuine Ford, Motorcraft or Ford-authorized re-manufactured replacement parts engineered for your vehicle.

## Additives and Chemicals

This owner's manual and our Workshop Manual list the recommended additives and chemicals for your vehicle. We do not recommend using chemicals or additives not approved by us as part of your vehicle's normal maintenance. Please consult your warranty information.

## Oils, Fluids and Flushing

In many cases, fluid discoloration is a normal operating characteristic and, by itself, does not necessarily indicate a concern or that the fluid needs to be changed. However, a qualified expert, such as the factory-trained technicians at your dealership, should inspect discolored fluids that also show signs of overheating or foreign material contamination immediately.

Make sure to change your vehicle's oils and fluids at the specified intervals or in conjunction with a repair. Flushing is a viable way to change fluid for many vehicle sub-systems during scheduled maintenance. It is critical that systems are flushed only with new fluid that is the same as that required to fill and operate the system or using a Ford-approved flushing chemical.

## Owner Checks and Services

Make sure you perform the following basic maintenance checks and inspections every month or at six-month intervals.

Check Every Month
Engine oil level.
Function of all interior and exterior lights.
Tires, including spare, for wear and proper pressure.



# Scheduled Maintenance

## Check Every Month

Windshield washer fluid level.

Fuel and water separator. Drain if necessary, or if indicated by the information display.

Holes and slots in the tail pipe to make sure they are functional and clear of debris.

## Check Every Six Months

Battery connections. Clean if necessary.

Body and door drain holes for obstructions. Clean if necessary.

Cooling system fluid level and coolant strength.

Door weatherstrips for wear. Lubricate if necessary.

Hinges, latches and outside locks for proper operation. Lubricate if necessary.

Parking brake for proper operation.

Seatbelts and seat latches for wear and function.

Safety warning lamps (brake, ABS, airbag and seatbelt) for operation.

Washer spray and wiper operation. Clean or replace blades as necessary.

## Multi-Point Inspection

In order to keep your vehicle running right, it is important to have the systems on your vehicle checked regularly. This can help identify potential issues and prevent major problems. We recommend having the following multi-point inspection performed at every scheduled maintenance interval to help make sure your vehicle keeps running great.

### Multi-Point Inspection

Accessory drive belt(s)	Hazard warning system operation
Battery performance	Horn operation
Engine air filter	Radiator, cooler, heater and air conditioning hoses

# Scheduled Maintenance

Multi-Point Inspection	
Exhaust system	Suspension components for leaks or damage
Exterior lamps operation	Steering and linkage
Fluid levels <sup>1</sup> ; fill if necessary	Tires, including spare, for wear and proper pressure <sup>2</sup>
For oil and fluid leaks	Windshield for cracks, chips or pits
Half-shaft dust boots	Washer spray and wiper operation

<sup>1</sup> Brake, coolant recovery reservoir, automatic transmission and window washer.

<sup>2</sup> If your vehicle has a temporary mobility kit, check the tire sealant expiration Use By date on the canister. Replace as needed.

Be sure to ask your dealership service advisor or technician about the multi-point vehicle inspection. It is a comprehensive way to perform a thorough inspection of your vehicle. Your checklist gives you immediate feedback on the overall condition of your vehicle.

This means you do not have to remember to change the oil on a mileage-based schedule. Your vehicle lets you know when an oil change is due by displaying a message in the information display.

The following table provides examples of vehicle use and its impact on oil change intervals. It is a guideline only. Actual oil change intervals depend on several factors and generally decrease with severity of use.

## NORMAL SCHEDULED MAINTENANCE

### Intelligent Oil-Life Monitor™

Your vehicle has an Intelligent Oil-Life Monitor that determines when you should change the engine oil based on how you use your vehicle. By using several important factors in its calculations, the monitor helps reduce the cost of owning your vehicle and reduces environmental waste at the same time.

When to Expect the OIL CHANGE REQUIRED Message	
Interval	Vehicle Use and Example
7,500–10,000 mi (12,000–16,000 km)	<b>Normal</b>
	Normal commuting with highway driving

## Scheduled Maintenance

<b>When to Expect the OIL CHANGE REQUIRED Message</b>	
<b>Interval</b>	<b>Vehicle Use and Example</b>
	No, or moderate, load or towing Flat to moderately hilly roads No extended idling
5,000–7,500 mi (8,000–12,000 km)	<b>Severe</b>
	Moderate to heavy load or towing Mountainous or off-road conditions Extended idling Extended hot or cold operation
3,000–5,000 mi (5,000–8,000 km)	<b>Extreme</b>
	Maximum load or towing Extreme hot or cold operation Extended engine idling

### Normal Maintenance Intervals

<b>At Every Oil Change Interval as Indicated by the Information Display<sup>1</sup></b>
Change the engine oil and filter.
Rotate the tires.
Perform a multi-point inspection, recommended.
Inspect the automatic transmission fluid level. Consult your dealer for requirements.
Inspect the brake pads, rotors, hoses and the parking brake.
Inspect the engine coolant level/strength and the hoses.
Inspect the exhaust system and heat shields.
Inspect the rear axle and U-joints.
Inspect the half-shaft boots.
Inspect the steering linkage, ball joints, suspension, tire-rod ends, driveshaft and the U-joints.

# Scheduled Maintenance

## At Every Oil Change Interval as Indicated by the Information Display<sup>1</sup>

Inspect the tires, tire wear and measure the tread depth.

Inspect the wheels and related components for abnormal noise, wear, looseness or drag.

<sup>1</sup> Do not exceed one year or 10,000 mi (16,000 km) between service intervals.

## Brake Fluid Maintenance<sup>1</sup>

Every 3 Years

Change the brake fluid.<sup>2</sup>

<sup>1</sup> Perform this maintenance item every 3 years. Do not exceed the designated time for the interval.

<sup>2</sup> Brake fluid servicing requires special equipment available at your authorized dealer.

## Other Maintenance Items<sup>1</sup>

Every 20,000 mi  
(32,000 km)

Replace the cabin air filter.

Every 30,000 mi  
(48,000 km)

Replace the engine air filter.

Every 100,000 mi  
(160,000 km)

Replace the spark plugs.

Inspect the accessory drive belt(s).<sup>2</sup>

Every 150,000 mi  
(240,000 km)

Change the automatic transmission fluid.

Replace the accessory drive belt(s).<sup>3</sup>

Replace the timing belt (1.5L engine).

At 200,000 mi  
(322,000 km)

Change the engine coolant.<sup>4</sup>

<sup>1</sup> Perform these maintenance items within 3,000 mi (4,800 km) of the last engine oil and filter change. Do not exceed the designated distance for the interval.

<sup>2</sup> After initial inspection, inspect every other oil change until replaced.

<sup>3</sup> If not replaced within the last 100,000 mi (160,000 km).

<sup>4</sup> Initial replacement at 10 years or 200,000 mi (322,000 km), then every five years or 100,000 mi (160,000 km).

# Scheduled Maintenance

## SPECIAL OPERATING CONDITIONS SCHEDULED MAINTENANCE

If you operate your vehicle **primarily** in any of the following conditions, you need to perform extra maintenance as indicated. If you operate your vehicle **occasionally** under any of these conditions, it is not necessary to perform the extra maintenance. For specific recommendations, see your dealership service advisor or technician.

Perform the services shown in the following tables when specified or within 3,000 mi (4,800 km) of the **OIL CHANGE REQUIRED** message appearing in the information display.

- **Example 1:** The **OIL CHANGE REQUIRED** message comes on at 28,751 mi (46,270 km). Perform the 30,000 mi (48,000 km) automatic transmission fluid replacement.
- **Example 2:** The **OIL CHANGE REQUIRED** message has **not** come on, but the odometer reads 30,000 mi (48,000 km) (for example, the Intelligent Oil-Life Monitor was reset at 25,000 mi (40,000 km)). Perform the engine air filter replacement.

<b>Towing a Trailer or Using a Car-top Carrier</b>	
As required	Change engine oil and filter as indicated by the information display and perform services listed in the Normal Scheduled Maintenance chart.
Inspect frequently, service as required	Inspect rear axle and U-joints.
Every 30,000 mi (48,000 km)	Change automatic transmission fluid.
Every 60,000 mi (96,000 km)	Replace spark plugs.

<b>Extensive Idling or Low-speed Driving for Long Distances, as in Heavy Commercial Use (Such as Delivery, Taxi, Patrol Car or Livery)</b>	
As required	Change engine oil and filter as indicated by the information display and perform services listed in the Normal Scheduled Maintenance chart.
Inspect frequently, service as required	Replace cabin air filter. <sup>1</sup>
	Replace engine air filter.

# Scheduled Maintenance

<b>Extensive Idling or Low-speed Driving for Long Distances, as in Heavy Commercial Use (Such as Delivery, Taxi, Patrol Car or Livery)</b>	
Every 30,000 mi (48,000 km)	Change automatic transmission fluid.
Every 60,000 mi (96,000 km)	Replace spark plugs.

<sup>1</sup> This is an optional feature.

<b>Operating in Dusty or Sandy Conditions (Such as Unpaved or Dusty Roads)</b>	
Inspect frequently, service as required	Replace cabin air filter. <sup>1</sup>
	Replace engine air filter.
Every 5,000 mi (8,000 km)	Inspect the wheels and related components for abnormal noise, wear, looseness or drag.
	Rotate tires, inspect tires for wear and measure tread depth.
Every 5,000 mi (8,000 km) or six months	Change engine oil and filter.
	Perform multi-point inspection.
Every 30,000 mi (48,000 km)	Change automatic transmission fluid.

<sup>1</sup> This is an optional feature.

<b>Exclusive Use of E85 (Flex Fuel Vehicles Only)</b>	
Every oil change	If ran exclusively on E85, fill the fuel tank full with regular unleaded fuel.

## Exceptions

There are several exceptions to the Normal Schedule:

# Scheduled Maintenance

---

## **California Fuel Filter Replacement**

If you register your vehicle in California, the California Air Resources Board has determined that the failure to perform this maintenance item does not nullify the emission warranty or limit recall liability before the completion of your vehicle's useful life. Ford Motor Company, however, urges you to have all recommended maintenance services performed at the specified intervals and to record all vehicle service.

## **Hot Climate Oil Change Intervals**

The normal oil change interval for vehicles operating in the Middle East, North Africa, Sub-Saharan Africa or locations with similar climates using an American Petroleum Institute (API) Certified for Gasoline Engines (Certification mark) oil of SM or SN quality is 3,000 mi (5,000 km).

If the available API SM or SN oils are not available, then the oil change interval is 2,000 mi (3,000 km).

## **Engine Air Filter and Cabin Air Filter Replacement**

The life of the engine air filter and cabin air filter is dependent on exposure to dusty and dirty conditions. Vehicles operated in these conditions require frequent inspection and replacement of the engine air filter and cabin air filter.

# Appendices

## ELECTROMAGNETIC COMPATIBILITY



**WARNING:** Do not place objects or mount equipment on or near the airbag cover, on the side of the front or rear seatbacks, or in areas that may come into contact with a deploying airbag. Failure to follow these instructions may increase the risk of personal injury in the event of a crash.



**WARNING:** Do not fasten antenna cables to vehicle wiring, fuel pipes and brake pipes.



**WARNING:** Keep antenna and power cables at least 4 in (10 cm) from any electronic modules and airbags.

**Note:** We test and certify your vehicle to meet electromagnetic compatibility legislation. It is your responsibility to make sure that any equipment an authorized dealer installs on your vehicle complies with applicable local legislation and other requirements. Installation of some aftermarket electronic devices could degrade the performance of vehicle functions, which use radio frequency signals such as broadcast radio receiver, tire pressure monitoring system, push button start, **Bluetooth®** connectivity or satellite navigation.

**Note:** Any radio frequency transmitter equipment in your vehicle (such as cellular telephones and amateur radio transmitters) must keep to the parameters in the following illustrations and table. We do not provide any other special provisions or conditions for installations or use.

### Car/SUV

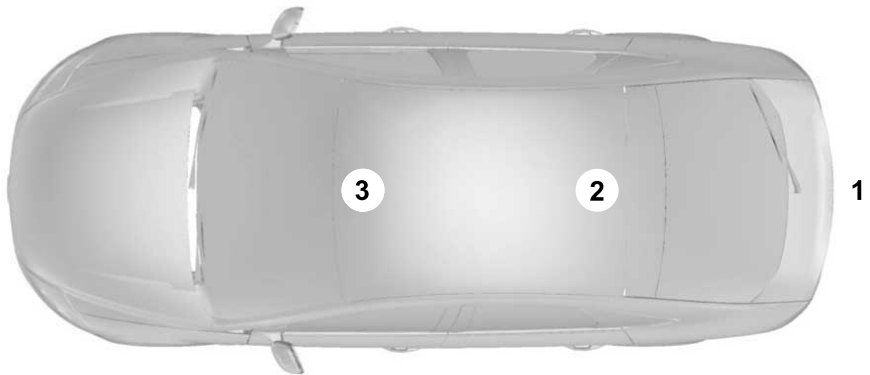



# Appendices

---

## Van



## Truck

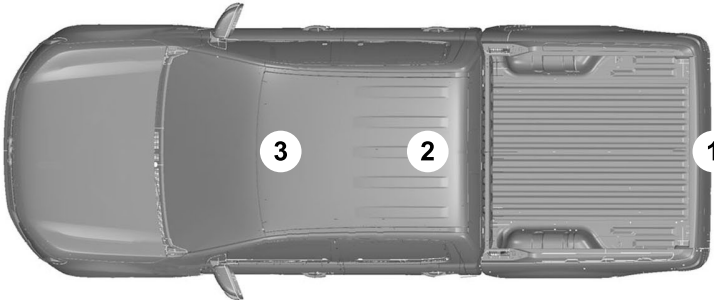

# Appendices

---

<b>Frequency Band MHz</b>	<b>Maximum output power Watt (Peak RMS)</b>	<b>Antenna Positions</b>
1-30	50	1
50-54	50	2, 3
68-88	50	2, 3
142-176	50	2, 3
380-512	50	2, 3
806-870	10	2, 3

# Appendices

## END USER LICENSE AGREEMENT

### VEHICLE SOFTWARE END USER LICENSE AGREEMENT (EULA)

- You ("You" or "Your" as applicable) have acquired a vehicle having several devices, including SYNC ® and various control modules, ("DEVICES") that include software licensed or owned by Ford Motor Company and its affiliates ("FORD MOTOR COMPANY"). Those software products of FORD MOTOR COMPANY origin, as well as associated media, printed materials, and "online" or electronic documentation ("SOFTWARE") are protected by international intellectual property laws and treaties. The SOFTWARE is licensed, not sold. All rights reserved.
- The SOFTWARE may interface with and/or communicate with, or may be later upgraded to interface with and/or communicate with additional software and/or systems provided by FORD MOTOR COMPANY.

**IF YOU DO NOT AGREE TO THIS END USER LICENSE AGREEMENT ("EULA") DO NOT USE THE DEVICES OR COPY THE SOFTWARE. ANY USE OF THE SOFTWARE, INCLUDING BUT NOT LIMITED TO USE ON THE DEVICES, WILL CONSTITUTE YOUR AGREEMENT TO THIS EULA (OR RATIFICATION OF ANY PREVIOUS CONSENT).**

**GRANT OF SOFTWARE LICENSE:** This EULA grants you the following license:

- You may use the SOFTWARE as installed on the DEVICES and as otherwise interfacing with systems and/or services provide by or through FORD MOTOR COMPANY or its third party software and service providers.

## Description of Other Rights and Limitations

- **Speech Recognition:** If the SOFTWARE includes speech recognition component(s), you should understand that speech recognition is an inherently statistical process and that recognition errors are inherent in the process. Neither FORD MOTOR COMPANY nor its suppliers shall be liable for any damages arising out of errors in the speech recognition process. It is your responsibility to monitor any speech recognition functions included in the system.
- **Limitations on Reverse Engineering, Decompilation and Disassembly:** You may not reverse engineer, decompile, translate, disassemble or attempt to discover any source code or underlying ideas or algorithms of the SOFTWARE nor permit others to reverse engineer, decompile or disassemble the SOFTWARE, except and only to the extent that such activity is expressly permitted by applicable law notwithstanding this limitation or to the extent as may be permitted by the licensing terms governing use of any open source components included with the SOFTWARE.
- **Limitations on Distributing, Copying, Modifying and Creating Derivative Works:** You may not distribute, copy, make modifications to or create derivative works based on the SOFTWARE, except and only to the extent that such activity is expressly permitted by applicable law notwithstanding this limitation or to the extent as may be permitted by the licensing terms governing use of any open source components included with the SOFTWARE.

# Appendices

---

- **Single EULA:** The end user documentation for the DEVICES and related systems and services may contain multiple EULAs, such as multiple translations and/or multiple media versions (e.g., in the user documentation and in the software). Even if you receive multiple EULAs, you are licensed to use only one (1) copy of the SOFTWARE.
- **SOFTWARE Transfer:** You may permanently transfer your rights under this EULA only as part of a sale or transfer of the DEVICES, provided you retain no copies, you transfer all of the SOFTWARE (including all component parts, the media and printed materials, any upgrades, and, if applicable, the Certificate(s) of Authenticity), and the recipient agrees to the terms of this EULA. If the SOFTWARE is an upgrade, any transfer must include all prior versions of the SOFTWARE.
- **Termination:** Without prejudice to any other rights, FORD MOTOR COMPANY may terminate this EULA if you fail to comply with the terms and conditions of this EULA.
- **Internet-Based Services Components:** The SOFTWARE may contain components that enable and facilitate the use of certain Internet-based services. You acknowledge and agree that FORD MOTOR COMPANY, third party software and service suppliers, its affiliates and/or its designated agent may automatically check the version of the SOFTWARE and/or its components that you are utilizing and may provide upgrades or supplements to the SOFTWARE that may be automatically downloaded to your DEVICES.
- **Additional Software/Services:** The SOFTWARE may permit FORD MOTOR COMPANY, third party software and service suppliers, its affiliates and/or its designated agent to provide or make available to you SOFTWARE updates, supplements, add-on components, or Internet-based services components of the SOFTWARE after the date you obtain your initial copy of the SOFTWARE ("Supplemental Components".) SOFTWARE updates may cause you to incur additional charges from your wireless service provider. If FORD MOTOR COMPANY or third party software and services suppliers provide or make available to you Supplemental Components and no other EULA terms are provided along with the Supplemental Components, then the terms of this EULA shall apply. FORD MOTOR COMPANY, its affiliates and/or its designated agent reserve the right to discontinue without liability any Internet-based services provided to you or made available to you through the use of the SOFTWARE.

# Appendices

---

- **Links to Third Party Sites:** The SOFTWARE may provide you with the ability to link to third party sites. The third party sites are not under the control of FORD MOTOR COMPANY, its affiliates and/or its designated agent. Neither FORD MOTOR COMPANY nor its affiliates nor its designated agent are responsible for (i) the contents of any third party sites, any links contained in third party sites, or any changes or updates to third party sites, or (ii) webcasting or any other form of transmission received from any third party sites. If the SOFTWARE provides links to third party sites, those links are provided to you only as a convenience, and the inclusion of any link does not imply an endorsement of the third party site by FORD MOTOR COMPANY, its affiliates and/or its designated agent.
- **Obligation to Drive Responsibly:** You recognize your obligation to drive responsibly and keep attention on the road. You will read and abide with the DEVICES operating instructions particularly as they pertain to safety and you agree to assume any risk associated with the use of the DEVICES.

## **UPGRADES AND RECOVERY MEDIA:**

If the SOFTWARE is provided by FORD MOTOR COMPANY separate from the DEVICES on media such as a ROM chip, CD ROM disk(s) or via web download or other means, and is labeled "For Upgrade Purposes Only" or "For Recovery Purposes Only" you may install one (1) copy of such SOFTWARE onto the DEVICES as a replacement copy for the existing SOFTWARE, and use it in accordance with this EULA, including any additional EULA terms accompanying the upgrade SOFTWARE.

## **INTELLECTUAL PROPERTY RIGHTS:**

All title and intellectual property rights in and to the SOFTWARE (including but not limited to any images, photographs, animations, video, audio, music, text and "applets" incorporated into the SOFTWARE), the accompanying printed materials, and any copies of the SOFTWARE, are owned by FORD MOTOR COMPANY, or its affiliates or suppliers. The SOFTWARE is licensed, not sold. You may not copy the printed materials accompanying the SOFTWARE. All title and intellectual property rights in and to the content which may be accessed through use of the SOFTWARE is the property of the respective content owner and may be protected by applicable copyright or other intellectual property laws and treaties. This EULA grants you no rights to use such content outside its intended use. All rights not specifically granted under this EULA are reserved by FORD MOTOR COMPANY, its affiliates, and third party software and service providers and suppliers. Use of any on-line services which may be accessed through the SOFTWARE may be governed by the respective terms of use relating to such services. If this SOFTWARE contains documentation that is provided only in electronic form, you may print one copy of such electronic documentation.

**EXPORT RESTRICTIONS:** You acknowledge that the SOFTWARE is subject to U.S. and European Union export jurisdiction. You agree to comply with all applicable international and national laws that apply to the SOFTWARE, including the U.S. Export Administration Regulations, as well as end-user, end-use and destination restrictions issued by U.S. and other governments.

# Appendices

---

**TRADEMARKS:** This EULA does not grant you any rights in connection with any trademarks or service marks of FORD MOTOR COMPANY, its affiliates, and third party software and service providers.

The **Bluetooth®** word mark and logos are registered trademarks owned by **Bluetooth SIG, Inc.** and any use of such marks by Ford Motor Company is under license. Other trademarks and trade names are those of their respective owners.

**PRODUCT SUPPORT:** Please refer to FORD MOTOR COMPANY instructions provided in the documentation for the DEVICES product support, such as the vehicle owner guide.

Should you have any questions concerning this EULA, or if you desire to contact FORD MOTOR COMPANY for any other reason, please refer to the address provided in the documentation for the DEVICES.

**No Liability for Certain Damages:** EXCEPT AS PROHIBITED BY LAW, FORD MOTOR COMPANY, ANY THIRD PARTY SOFTWARE OR SERVICES SUPPLIERS, AND THEIR AFFILIATES SHALL HAVE NO LIABILITY FOR ANY INDIRECT, SPECIAL, CONSEQUENTIAL OR INCIDENTAL DAMAGES ARISING FROM OR IN CONNECTION WITH THE USE OR PERFORMANCE OF THE SOFTWARE. THIS LIMITATION SHALL APPLY EVEN IF ANY REMEDY FAILS OF ITS ESSENTIAL PURPOSE. THERE ARE NO WARRANTIES OTHER THAN THOSE THAT MAY BE EXPRESSLY PROVIDED FOR YOUR NEW VEHICLE.

## **SYNC® Automotive Important Safety Information Read and follow instructions:**

- Before using your SYNC® system, read and follow all instructions and safety information provided in this end user manual ("Owner Guide".) Not following precautions found in the Owner Guide can lead to an accident or other serious injuries.

### General Operation

- **Voice Command Control:** Certain functions within the SYNC® system may be accomplished using voice commands. Using voice commands while driving helps you to operate the system without removing your hands from the wheel or eyes from the road.
- **Prolonged Views of Screen:** Do not access any function requiring a prolonged view of the screen while you are driving. Pull over in a safe and legal manner before attempting to access a function of the system requiring prolonged attention.
- **Volume Setting:** Do not raise the volume excessively. Keep the volume at a level where you can still hear outside traffic and emergency signals while driving. Driving while unable to hear these sounds could cause an accident.
- **Navigation Features:** Any navigation features included in the system are intended to provide turn by turn instructions to get you to a desired destination. Please make certain all persons using this system carefully read and follow instructions and safety information fully.

# Appendices

---

- **Distraction Hazard:** Any navigation features may require manual (non-verbal) setup. Attempting to perform such set-up or insert data while driving can distract your attention and could cause an accident or other serious injury. Stop the vehicle in a safe and legal manner before attempting these operations.
- **Let Your Judgment Prevail:** Any navigation features are provided only as an aid. Make your driving decisions based on your observations of local conditions and existing traffic regulations. Any such feature is not a substitute for your personal judgment. Any route suggestions made by this system should never replace any local traffic regulations or your personal judgment or knowledge of safe driving practices.
- **Route Safety:** Do not follow the route suggestions if doing so would result in an unsafe or illegal maneuver, if you would be placed in an unsafe situation, or if you would be directed into an area that you consider unsafe. The driver is ultimately responsible for the safe operation of the vehicle and therefore, must evaluate whether it is safe to follow the suggested directions.
- **Potential Map Inaccuracy:** Maps used by this system may be inaccurate because of changes in roads, traffic controls or driving conditions. Always use good judgment and common sense when following the suggested routes.
- **Emergency Services:** Do not rely on any navigation features included in the system to route you to emergency services. Ask local authorities or an emergency services operator for these locations. Not all emergency services such as police, fire stations, hospitals and clinics are likely to be contained in the map database for such navigation features.

## Your Responsibilities and Assumptions of Risk

- You agree to each of the following: (a) Any use of the SOFTWARE while driving an automobile or other vehicle in violation of applicable law or otherwise driving in an unsafe manner presents a significant risk of distracted driving and should not be attempted under any circumstances; (b) Use of the SOFTWARE at excessive volume poses a significant risk of hearing damage and should not be attempted under any circumstances; (c) The SOFTWARE may not be compatible with new or different versions of an operating system, third party software, or third party services, and the SOFTWARE may potentially cause a critical failure of an operating system, third party software, or third party service; (d) Any third party service accessed by or third party software used with the SOFTWARE (i) may charge an additional fee for access, (ii) may not work correctly, on an uninterrupted basis, or error free, (iii) may change streaming formats or discontinue operation, (iv) may contain adult, profane or offensive content; and (v) may contain inaccurate, false or misleading traffic, weather, financial or safety information or other content; and (e) Use of the SOFTWARE may cause you to incur additional charges from your wireless service provider (WSP) and any data or minute calculators that may be included in the software program are for reference only, are not warranted in any way and should not be relied upon in anyway.
- When using the SOFTWARE, you agree to be responsible for and assume the entire risk to the items set forth in Section (a) – (e) above.

# Appendices

## Disclaimer of Warranty

YOU EXPRESSLY ACKNOWLEDGE AND AGREE THAT USE OF THE DEVICES AND SOFTWARE IS AT YOUR SOLE RISK AND THAT THE ENTIRE RISK AS TO SATISFACTORY QUALITY, PERFORMANCE, COMPATIBILITY, ACCURACY AND EFFORT IS WITH YOU. TO THE MAXIMUM EXTENT PERMITTED BY APPLICABLE LAW, THE SOFTWARE AND ANY THIRD PARTY SOFTWARE OR THIRD-PARTY SERVICES ARE PROVIDED "AS IS" AND "AS AVAILABLE", WITH ALL FAULTS AND WITHOUT WARRANTY OF ANY KIND, AND FORD MOTOR COMPANY HEREBY DISCLAIMS ALL WARRANTIES AND CONDITIONS WITH RESPECT TO THE SOFTWARE, THIRD PARTY SOFTWARE, AND THIRD-PARTY SERVICES, EITHER EXPRESS, IMPLIED OR STATUTORY, INCLUDING, BUT NOT LIMITED TO, THE IMPLIED WARRANTIES AND/OR CONDITIONS OF MERCHANTABILITY, OF SATISFACTORY QUALITY, OF FITNESS FOR AN PARTICULAR PURPOSE, OF ACCURACY, OF QUIET ENJOYMENT, AND NON-INFRINGEMENT OF THIRD-PARTY RIGHTS. FORD MOTOR COMPANY DOES NOT WARRANT (a) AGAINST INTERFERENCE WITH YOUR ENJOYMENT OF THE SOFTWARE, THIRD PARTY SOFTWARE, OR THIRD-PARTY SERVICES, (b) THAT THE SOFTWARE, THIRD PARTY SOFTWARE, OR THIRD-PARTY SERVICES WILL MEET YOUR REQUIREMENTS, (c) THAT THE OPERATION OF THE SOFTWARE, THIRD PARTY SOFTWARE, OR THIRD-PARTY SERVICES WILL BE UNINTERRUPTED OR ERROR-FREE, (d) OR THAT DEFECTS IN THE SOFTWARE, THIRD PARTY SOFTWARE, OR THIRD-PARTY SERVICES WILL BE CORRECTED. NO ORAL OR WRITTEN INFORMATION OR ADVICE GIVEN BY FORD MOTOR COMPANY OR ITS AUTHORIZED REPRESENTATIVE SHALL

CREATE A WARRANTY. SHOULD THE SOFTWARE, THIRD PARTY SOFTWARE, OR THIRD-PARTY SERVICES PROVE DEFECTIVE, YOU ASSUME THE ENTIRE COST OF ALL NECESSARY SERVICING, REPAIR OR CORRECTION. SOME JURISDICTIONS DO NOT ALLOW THE DISCLAIMER OF IMPLIED WARRANTIES OR LIMITATIONS ON APPLICABLE STATUTORY RIGHTS OF A CONSUMER, SO THE ABOVE DISCLAIMER MAY NOT FULLY APPLY TO YOU. THE SOLE WARRANTY PROVIDED BY FORD MOTOR COMPANY SHALL BE FOUND IN THE WARRANTY INFORMATION INCLUDING WITH YOUR OWNER GUIDE. TO THE EXTENT THAT THERE IS ANY CONFLICT BETWEEN THE TERMS OF THIS SECTION AND THE WARRANTY BOOKLET, THE WARRANTY BOOKLET SHALL CONTROL.

## Applicable Law, Venue, Jurisdiction

- The laws of the State of Michigan govern this EULA and Your use of the SOFTWARE. Your use of the SOFTWARE may also be subject to other local, state, national, or international laws. Any litigation arising out of or related to this EULA shall be brought and maintained exclusively in a court of the State of Michigan located in Wayne County or in the United States District Court for the Eastern District of Michigan. You hereby consent to submit to the personal jurisdiction of a court in the State of Michigan located in Wayne County and the United States District Court for the Eastern District of Michigan for any dispute arising out of or relating to this EULA.



# Appendices

## **Binding Arbitration and Class Action Waiver**

**(a) Application.** This Section applies to any dispute EXCEPT IT DOES NOT INCLUDE A DISPUTE RELATING TO COPYRIGHT INFRINGEMENT, OR TO THE ENFORCEMENT OR VALIDITY OF YOUR, FORD MOTOR COMPANY, OR ANY OF FORD MOTOR COMPANY'S LICENSORS' INTELLECTUAL PROPERTY RIGHTS. Dispute means any dispute, action, or other controversy between You and FORD MOTOR COMPANY, other than the exceptions listed above, concerning the SOFTWARE (including its price) or this EULA, whether in contract, warranty, tort, statute, regulation, ordinance, or any other legal or equitable basis.

**(b) Notice of Dispute.** In the event of a Dispute, You or FORD MOTOR COMPANY must give the other a "Notice of Dispute", which is a written statement of the name, address, and contact information of the party giving it, the facts giving rise to the dispute, and the relief requested. You and FORD MOTOR COMPANY will attempt to resolve any dispute through informal negotiation within 60 days from the date the Notice of Dispute is sent. After 60 days, You or FORD MOTOR COMPANY may commence arbitration.

**(c) Small claims court.** You may also litigate any dispute in small claims court in your county of residence or FORD MOTOR COMPANY'S principal place of business, if the dispute meets all requirements to be heard in the small claims court. You may litigate in small claims court whether or not You negotiated informally first.

**(d) Binding arbitration.** If You and FORD MOTOR COMPANY, do not resolve any dispute by informal negotiation or in small claims court, any other effort to resolve the dispute will be conducted exclusively by binding arbitration. You are giving up

the right to litigate (or participate in as a party or class member) all disputes in court before a judge or jury. Instead, all disputes will be resolved before a neutral arbitrator, whose decision will be final except for a limited right of appeal under the Federal Arbitration Act. Any court with jurisdiction over the parties may enforce the arbitrator's award.

**(e) Class action waiver.** Any proceedings to resolve or litigate any dispute in any forum will be conducted solely on an individual basis. Neither you nor FORD MOTOR COMPANY, will seek to have any dispute heard as a class action, as a private attorney general action, or in any other proceeding in which any party acts or proposes to act in a representative capacity. No arbitration or proceeding will be combined with another without the prior written consent of all parties to all affected arbitrations or proceedings.

**(f) Arbitration procedure.** Any arbitration will be conducted by the American Arbitration Association (the "AAA"), under its Commercial Arbitration Rules. If You are an individual and use the SOFTWARE for personal or vehicle use, or if the value of the dispute is \$75,000 or less whether or not You are an individual or how You use the SOFTWARE, the AAA Supplementary Procedures for Consumer-Related Disputes will also apply. To commence arbitration, submit a Commercial Arbitration Rules Demand for Arbitration form to the AAA. You may request a telephonic or in-person hearing by following the AAA rules. In a dispute involving \$10,000 or less, any hearing will be telephonic unless the arbitrator finds good cause to hold an in-person hearing instead. For more information, see [adr.org](http://adr.org) or call 1-800-778-7879. You agree to commence arbitration only in your county of residence or FORD MOTOR COMPANY'S principal place of business. The arbitrator

# Appendices

may award the same damages to You individually as a court could. The arbitrator may award declaratory or injunctive relief only to You individually, and only to the extent required to satisfy Your individual claim.

## **(g) Arbitration fees and incentives.**

- I. Disputes involving \$75,000 or less. FORD MOTOR COMPANY will promptly reimburse your filing fees and pay the AAA's and arbitrator's fees and expenses. If you reject FORD MOTOR COMPANY'S last written settlement offer made before the arbitrator was appointed ("last written offer"), your dispute goes all the way to an arbitrator's decision (called an "award"), and the arbitrator awards you more than the last written offer, FORD MOTOR COMPANY will give you three incentives: (1) pay the greater of the award or \$1,000; (2) pay twice your reasonable attorney's fees, if any; and (3) reimburse any expenses (including expert witness fees and costs) that your attorney reasonably accrues for investigating, preparing, and pursuing your claim in arbitration. The arbitrator will determine the amounts.
- ii. Disputes involving more than \$75,000. The AAA rules will govern payment of filing fees and the AAA's and arbitrator's fees and expenses.
- iii. Disputes involving any amount. In any arbitration you commence, FORD MOTOR COMPANY will seek its AAA or arbitrator's fees and expenses, or Your filing fees it reimbursed, only if the arbitrator finds the arbitration frivolous or brought for an improper purpose. In any arbitration FORD MOTOR COMPANY commences, it will pay all

filing, AAA, and arbitrator's fees and expenses. It will not seek its attorney's fees or expenses from you in any arbitration. Fees and expenses are not counted in determining how much a dispute involves.

**(h) Claims or disputes must be filed within one year.** To the extent permitted by law, any claim or dispute under this EULA to which this Section applies must be filed within one year in small claims court (Section c) or in arbitration (Section d). The one-year period begins when the claim or dispute first could be filed. If such a claim or dispute is not filed within one year, it is permanently barred.

**(i) Severability.** If the class action waiver (Section e) is found to be illegal or unenforceable as to all or some parts of a dispute, then that portion of Section e will not apply to those parts. Instead, those parts will be severed and proceed in a court of law, with the remaining parts proceeding in arbitration. If any other provision of that portion Section e is found to be illegal or unenforceable, that provision will be severed with the remainder of Section e remaining in full force and effect.

## **Telenav Software End User License Agreement**

Please read these terms and conditions carefully before you use the TeleNav Software. Your use of the TeleNav Software indicates that you accept these terms and conditions. If you do not accept these terms and conditions, do not break the seal of the package, launch, or otherwise use the TeleNav Software. TeleNav may revise this Agreement and the privacy policy at any time, with or without notice to you. You agree to visit <http://www.telenav.com> from time to time to review the then current version of this Agreement and of the privacy policy.

# Appendices

---

## 1. Safe and Lawful Use

You acknowledge that devoting attention to the TeleNav Software may pose a risk of injury or death to you and others in situations that otherwise require your undivided attention, and you therefore agree to comply with the following when using the TeleNav Software:

- (a) observe all traffic laws and otherwise drive safely;
- (b) use your own personal judgment while driving. If you feel that a route suggested by the TeleNav Software instructs you to perform an unsafe or illegal maneuver, places you in an unsafe situation, or directs you into an area that you consider to be unsafe, do not follow such instructions;
- (c) do not input destinations, or otherwise manipulate the TeleNav Software, unless your vehicle is stationary and parked;
- (d) do not use the TeleNav Software for any illegal, unauthorized, unintended, unsafe, hazardous, or unlawful purposes, or in any manner inconsistent with this Agreement;
- (e) arrange all GPS and wireless devices and cables necessary for use of the TeleNav Software in a secure manner in your vehicle so that they will not interfere with your driving and will not prevent the operation of any safety device (such as an airbag).

You agree to indemnify and hold TeleNav harmless against all claims resulting from any dangerous or otherwise inappropriate use of the TeleNav Software in any moving vehicle, including as a result of your failure to comply with the directions above.

## 2. Account Information

You agree: (a) when registering the TeleNav Software, to provide TeleNav with true, accurate, current, and complete information about yourself, and (b) to inform TeleNav promptly of any changes to such information, and to keep it true, accurate, current and complete.

## 3. Software License

- Subject to your compliance with the terms of this Agreement, TeleNav hereby grants to you a personal, non-exclusive, non-transferable license (except as expressly permitted below in connection with your permanent transfer of the TeleNav Software license), without the right to sublicense, to use the TeleNav Software (in object code form only) in order to access and use the TeleNav Software. This license shall terminate upon any termination or expiration of this Agreement. You agree that you will use the TeleNav Software only for your personal business or leisure purposes, and not to provide commercial navigation services to other parties.

### 3.1 License Limitations

- **(a)** reverse engineer, decompile, disassemble, translate, modify, alter or otherwise change the TeleNav Software or any part thereof; **(b)** attempt to derive the source code, audio library or structure of the TeleNav Software without the prior express written consent of TeleNav; **(c)** remove from the TeleNav Software, or alter, any of TeleNav's or its suppliers' trademarks, trade names, logos, patent or copyright notices, or other notices or markings; **(d)**

# Appendices

---

distribute, sublicense or otherwise transfer the TeleNav Software to others, except as part of your permanent transfer of the TeleNav Software; or **(e)** use the TeleNav Software in any manner that

- i. infringes the intellectual property or proprietary rights, rights of publicity or privacy or other rights of any party,
- ii. violates any law, statute, ordinance or regulation, including but not limited to laws and regulations related to spamming, privacy, consumer and child protection, obscenity or defamation, or
- iii. is harmful, threatening, abusive, harassing, tortuous, defamatory, vulgar, obscene, libelous, or otherwise objectionable; and (f) lease, rent out, or otherwise permit unauthorized access by third parties to the TeleNav Software without advanced written permission of TeleNav.

## 4. Disclaimers

- To the fullest extent permissible pursuant to applicable law, in no event will TeleNav, its licensors and suppliers, or agents or employees of any of the foregoing, be liable for any decision made or action taken by you or anyone else in reliance on the information provided by the TeleNav Software. TeleNav also does not warrant the accuracy of the map or other data used for the TeleNav Software. Such data may not always reflect reality due to, among other things, road closures, construction, weather, new roads and other changing conditions. You are responsible for the entire risk arising out of your use of the TeleNav Software. For example but without limitation, you agree not to rely on the TeleNav Software for critical navigation in areas where the well-being or survival of you or others

is dependent on the accuracy of navigation, as the maps or functionality of the TeleNav Software are not intended to support such high risk applications, especially in more remote geographical areas.

- TELENAV EXPRESSLY DISCLAIMS AND EXCLUDES ALL WARRANTIES IN CONNECTION WITH THE TELENAV SOFTWARE, WHETHER STATUTORY, EXPRESS OR IMPLIED, INCLUDING ALL WARRANTIES WHICH MAY ARISE FROM COURSE OF DEALING, CUSTOM OR TRADE AND INCLUDING, BUT NOT LIMITED TO, THE IMPLIED WARRANTIES OF MERCHANTABILITY, FITNESS FOR A PARTICULAR PURPOSE AND NON-INFRINGEMENT OF THIRD PARTY RIGHTS WITH RESPECT TO THE TELENAV SOFTWARE.
- Certain jurisdictions do not permit the disclaimer of certain warranties, so this limitation may not apply to you.

## 5. Limitation of Liability

- TO THE EXTENT PERMITTED UNDER APPLICABLE LAW, UNDER NO CIRCUMSTANCES SHALL TELENAV OR ITS LICENSORS AND SUPPLIERS BE LIABLE TO YOU OR TO ANY THIRD PARTY FOR ANY INDIRECT, INCIDENTAL, CONSEQUENTIAL, SPECIAL OR EXEMPLARY DAMAGES (INCLUDING IN EACH CASE, BUT NOT LIMITED TO, DAMAGES FOR THE INABILITY TO USE THE EQUIPMENT OR ACCESS DATA, LOSS OF DATA, LOSS OF BUSINESS, LOSS OF PROFITS, BUSINESS INTERRUPTION OR THE LIKE) ARISING OUT OF THE USE OF OR INABILITY TO USE THE TELENAV SOFTWARE, EVEN IF TELENAV HAS BEEN ADVISED OF THE POSSIBILITY OF SUCH DAMAGES. NOTWITHSTANDING ANY DAMAGES THAT YOU MIGHT INCUR FOR ANY

# Appendices

---

REASON WHATSOEVER (INCLUDING, WITHOUT LIMITATION, ALL DAMAGES REFERENCED HEREIN AND ALL DIRECT OR GENERAL DAMAGES IN CONTRACT, TORT (INCLUDING NEGLIGENCE) OR OTHERWISE), THE ENTIRE LIABILITY OF TELENAV AND OF ALL OF TELENAV'S SUPPLIERS SHALL BE LIMITED TO THE AMOUNT ACTUALLY PAID BY YOU FOR THE TELENAV SOFTWARE. SOME STATES AND/OR JURISDICTIONS DO NOT ALLOW THE EXCLUSION OR LIMITATION OF INCIDENTAL OR CONSEQUENTIAL DAMAGES, SO THE ABOVE LIMITATIONS OR EXCLUSIONS MAY NOT APPLY TO YOU.

## **6. Arbitration and Governing Law**

- You agree that any dispute, claim or controversy arising out of or relating to this Agreement or the TeleNav Software shall be settled by independent arbitration involving a neutral arbitrator and administered by the American Arbitration Association in the County of Santa Clara, California. The arbitrator shall apply the Commercial Arbitration Rules of the American Arbitration Association, and the judgment upon the award rendered by the arbitrator may be entered by any court having jurisdiction. Note that there is no judge or jury in an arbitration proceeding and the decision of the arbitrator shall be binding upon both parties. You expressly agree to waive your right to a jury trial. This Agreement and performance hereunder will be governed by and construed in accordance with the laws of the State of California, without giving effect to its conflict of law provisions. To the extent judicial action is necessary in connection with the binding arbitration, both TeleNav and you agree to submit

to the exclusive jurisdiction of the courts of the County of Santa Clara, California. The United Nations Convention on Contracts for the International Sale of Goods shall not apply.

## **7. Assignment**

- You may not resell, assign, or transfer this Agreement or any of your rights or obligations, except in totality, in connection with your permanent transfer of the TeleNav Software, and expressly conditioned upon the new user of the TeleNav Software agreeing to be bound by the terms and conditions of this Agreement. Any such sale, assignment or transfer that is not expressly permitted under this paragraph will result in immediate termination of this Agreement, without liability to TeleNav, in which case you and all other parties shall immediately cease all use of the TeleNav Software. Notwithstanding the foregoing, TeleNav may assign this Agreement to any other party at any time without notice, provided the assignee remains bound by this Agreement.

## **8. Miscellaneous**

### **8.1**

This Agreement constitutes the entire agreement between TeleNav and you with respect to the subject matter hereof.

### **8.2**

Except for the limited licenses expressly granted in this Agreement, TeleNav retains all right, title and interest in and to the TeleNav Software, including without limitation all related intellectual property rights. No licenses or other rights which are not expressly granted in this Agreement are intended to, or shall be, granted or

# Appendices

---

conferred by implication, statute, inducement, estoppel or otherwise, and TeleNav and its suppliers and licensors hereby reserve all of their respective rights other than the licenses explicitly granted in this Agreement.

## 8.3

By using the TeleNav Software, you consent to receive from TeleNav all communications, including notices, agreements, legally required disclosures or other information in connection with the TeleNav Software (collectively, "Notices") electronically. TeleNav may provide such Notices by posting them on TeleNav's Website or by downloading such Notices to your wireless device. If you desire to withdraw your consent to receive Notices electronically, you must discontinue your use of the TeleNav Software.

## 8.4

TeleNav's or your failure to require performance of any provision shall not affect that party's right to require performance at any time thereafter, nor shall a waiver of any breach or default of this Agreement constitute a waiver of any subsequent breach or default or a waiver of the provision itself.

## 8.5

If any provision herein is held unenforceable, then such provision will be modified to reflect the intention of the parties, and the remaining provisions of this Agreement will remain in full force and effect.

## 8.6

The headings in this Agreement are for convenience of reference only, will not be deemed to be a part of this Agreement, and will not be referred to in connection with the construction or interpretation of this Agreement. As used in this Agreement, the words "include" and "including" and variations thereof, will not be deemed to be terms of limitation, but rather will be deemed to be followed by the words "without limitation".

## 9. Other Vendors Terms and Conditions

- The Telenav Software utilizes map and other data licensed to Telenav by third party vendors for the benefit of you and other end users. This Agreement includes end-user terms applicable to these companies (included at the end of this Agreement), and thus your use of the Telenav Software is also subject to such terms. You agree to comply with the following additional terms and conditions, which are applicable to Telenav's third party vendor licensors:

## 9.1 End User Terms Required by HERE North America, LLC

The data ("Data") is provided for your personal, internal use only and not for resale. It is protected by copyright, and is subject to the following terms and conditions which are agreed to by you, on the one hand, and Telenav ("Telenav") and its licensors (including their licensors and suppliers) on the other hand.

© 2013 HERE. All rights reserved.

The Data for areas of Canada includes information taken with permission from Canadian authorities, including: © Her Majesty the Queen in Right of Canada, © Queen's Printer for Ontario, © Canada Post Corporation, GeoBase®, © Department of Natural Resources Canada.

# Appendices

---

HERE holds a non-exclusive license from the United States Postal Service® to publish and sell ZIP+4® information.

©United States Postal Service® 2014. Prices are not established, controlled or approved by the United States Postal Service®. The following trademarks and registrations are owned by the USPS: United States Postal Service, USPS, and ZIP+4

The Data for Mexico includes certain data from Instituto Nacional de Estadística y Geografía.

## **9.2 End User Terms Required by NAV2 (Shanghai) Co., Ltd**

The data (“Data”) is provided for your personal, internal use only and not for resale. It is protected by copyright, and is subject to the following terms and conditions which are agreed to by you, on the one hand, and NAV2 (Shanghai) Co., Ltd (“NAV2”) and its licensors (including their licensors and suppliers) on the other hand. 20xx. All rights reserved

### **Terms and Conditions**

**Permitted Use.** You agree to use this Data together with the Telenav Software solely for the internal business and personal purposes for which you were licensed, and not for service bureau, time-sharing or other similar purposes. Accordingly, but subject to the restrictions set forth in the following paragraphs, you agree not to otherwise reproduce, copy, modify, decompile, disassemble, create any derivative works of, or reverse engineer any portion of this Data, and may not transfer or distribute it in any form, for any purpose, except to the extent permitted by mandatory laws.

**Restrictions.** Except where you have been specifically licensed to do so by Telenav, and without limiting the preceding paragraph, you may not use this Data (a) with any products, systems, or applications installed or otherwise connected to or in communication with vehicles, capable of vehicle navigation, positioning, dispatch, real time route guidance, fleet management or similar applications; or (b) with or in communication with any positioning devices or any mobile or wireless-connected electronic or computer devices, including without limitation cellular phones, palmtop and handheld computers, pagers, and personal digital assistants or PDAs.

**Warning.** The Data may contain inaccurate or incomplete information due to the passage of time, changing circumstances, sources used and the nature of collecting comprehensive geographic data, any of which may lead to incorrect results.

**No Warranty.** This Data is provided to you “as is,” and you agree to use it at your own risk. Telenav and its licensors (and their licensors and suppliers) make no guarantees, representations or warranties of any kind, express or implied, arising by law or otherwise, including but not limited to, content, quality, accuracy, completeness, effectiveness, reliability, fitness for a particular purpose, usefulness, use or results to be obtained from this Data, or that the Data or server will be uninterrupted or error-free.

**Disclaimer of Warranty:** TELENAV AND ITS LICENSORS (INCLUDING THEIR LICENSORS AND SUPPLIERS) DISCLAIM ANY WARRANTIES, EXPRESS OR IMPLIED, OF QUALITY, PERFORMANCE, MERCHANTABILITY, FITNESS FOR A

# Appendices

---

PARTICULAR PURPOSE OR NON-INFRINGEMENT. Some States, Territories and Countries do not allow certain warranty exclusions, so to that extent the above exclusion may not apply to you.

**Disclaimer of Liability:** TELENAV AND ITS LICENSORS (INCLUDING THEIR LICENSORS AND SUPPLIERS) SHALL NOT BE LIABLE TO YOU: IN RESPECT OF ANY CLAIM, DEMAND OR ACTION, IRRESPECTIVE OF THE NATURE OF THE CAUSE OF THE CLAIM, DEMAND OR ACTION ALLEGING ANY LOSS, INJURY OR DAMAGES, DIRECT OR INDIRECT, WHICH MAY RESULT FROM THE USE OR POSSESSION OF THE INFORMATION; OR FOR ANY LOSS OF PROFIT, REVENUE, CONTRACTS OR SAVINGS, OR ANY OTHER DIRECT, INDIRECT, INCIDENTAL, SPECIAL OR CONSEQUENTIAL DAMAGES ARISING OUT OF YOUR USE OF OR INABILITY TO USE THIS INFORMATION, ANY DEFECT IN THE INFORMATION, OR THE BREACH OF THESE TERMS OR CONDITIONS, WHETHER IN AN ACTION IN CONTRACT OR TORT OR BASED ON A WARRANTY, EVEN IF TELENAV OR ITS LICENSORS HAVE BEEN ADVISED OF THE POSSIBILITY OF SUCH DAMAGES. Some States, Territories and Countries do not allow certain liability exclusions or damages limitations, so to that extent the above may not apply to you.

**Export Control.** You shall not export from anywhere any part of the Data or any direct product thereof except in compliance with, and with all licenses and approvals required under, applicable export laws, rules and regulations, including but not limited to the laws, rules and regulations administered by the Office of Foreign Assets Control of the U.S. Department of Commerce and the Bureau of Industry and Security of the U.S. Department of Commerce. To the extent that any such

export laws, rules or regulations prohibit HERE from complying with any of its obligations hereunder to deliver or distribute Data, such failure shall be excused and shall not constitute a breach of this Agreement.

**Entire Agreement.** These terms and conditions constitute the entire agreement between Telenav (and its licensors, including their licensors and suppliers) and you pertaining to the subject matter hereof, and supersedes in their entirety any and all written or oral agreements previously existing between us with respect to such subject matter.

**Governing Law.** The above terms and conditions shall be governed by the laws of the State of Illinois [insert "Netherlands" where European HERE Data is used], without giving effect to (i) its conflict of laws provisions, or (ii) the United Nations Convention for Contracts for the International Sale of Goods, which is explicitly excluded. You agree to submit to the jurisdiction of the State of Illinois [insert "The Netherlands" where European HERE Data is used] for any and all disputes, claims and actions arising from or in connection with the Data provided to you hereunder.

**Government End Users.** If the Data is being acquired by or on behalf of the United States government or any other entity seeking or applying rights similar to those customarily claimed by the United States government, this Data is a "commercial item" as that term is defined at 48 C.F.R. ("FAR") 2.101, is licensed in accordance with these End-User Terms, and each copy of Data delivered or otherwise furnished shall be marked and embedded as appropriate with the following "Notice of Use," and shall be treated in accordance with such Notice:



# Appendices

## NOTICE OF USE

CONTRACTOR (MANUFACTURER/  
SUPPLIER) NAME: HERE

CONTRACTOR (MANUFACTURER/  
SUPPLIER) ADDRESS: c/o Nokia, 425  
West Randolph Street, Chicago, Illinois  
60606

This Data is a commercial item as  
defined in FAR 2.101 and is subject to  
these End-User Terms under which this  
Data was provided.

© 1987 – 2014 HERE – All rights reserved.

If the Contracting Officer, federal government agency, or any federal official refuses to use the legend provided herein, the Contracting Officer, federal government agency, or any federal official must notify HERE prior to seeking additional or alternative rights in the Data.

### I. US/Canada Territory

A. United States Data. The End-User Terms for any Application containing Data for the United States shall contain the following notices:

“HERE holds a non-exclusive license from the United States Postal Service® to publish and sell ZIP+4® information.”

“©United States Postal Service® 20XX. Prices are not established, controlled or approved by the United States Postal Service®. The following trademarks and registrations are owned by the USPS: United States Postal Service, USPS, and ZIP+4.”

B. Canada Data. The following provisions apply to the Data for Canada, which may include or reflect data from third party licensors (“Third Party Data”), including Her Majesty the Queen in Right of Canada (“Her Majesty”), Canada Post Corporation (“Canada Post”) and the Department of Natural Resources of Canada (“NRCan”):

1. Disclaimer and Limitation: Client agrees that its use of the Third Party Data is subject to the following provisions:

a. Disclaimer: The Third Party Data is licensed on an “as is” basis. The licensors of such data, including Her Majesty, Canada Post and NRCan, make no guarantees, representations or warranties respecting such data, either express or implied, arising by law or otherwise, including but not limited to, effectiveness, completeness, accuracy or fitness for a particular purpose.

b. Limitation on Liability: The Third Party Data licensors, including Her Majesty, Canada Post and NRCan, shall not be liable: (i) in respect of any claim, demand or action, irrespective of the nature of the cause of the claim, demand or action alleging any loss, injury or damages, direct or indirect, which may result from the use or possession of such Data; or (ii) in any way for loss of revenues or contracts, or any other consequential loss of any kind resulting from any defect in the Data.

# Appendices

---

2. Copyright Notice: In connection with each copy of all or any portion of the Data for the Territory of Canada, Client shall affix in a conspicuous manner the following copyright notice on at least one of: (i) the label for the storage media of the copy; (ii) the packaging for the copy; or (iii) other materials packaged with the copy, such as user manuals or end user license agreements: "This data includes information taken with permission from Canadian authorities, including © Her Majesty the Queen in Right of Canada, © Queen's Printer for Ontario, © Canada Post Corporation, GeoBase®, © The Department of Natural Resources Canada. All rights reserved!"

3. End-User Terms: Except as otherwise agreed by the parties, in connection with the provision of any portion of the Data for the Territory of Canada to End-Users as may be authorized under the Agreement, Client shall provide such End-Users, in a reasonably conspicuous manner, with terms (set forth with other end user terms required to be provided under the Agreement, or as otherwise may be provided, by Client) which shall include the following provisions on behalf of the Third Party Data licensors, including Her Majesty, Canada Post and NRCan:

The Data may include or reflect data of licensors, including Her Majesty the Queen in the Right of Canada ("Her Majesty"), Canada Post Corporation ("Canada Post") and the Department of Natural Resources Canada ("NRCan"). Such data is licensed on an "as is" basis. The licensors, including Her Majesty, Canada Post and NRCan, make no guarantees, representations or warranties respecting such data,

either express or implied, arising by law or otherwise, including but not limited to, effectiveness, completeness, accuracy or fitness for a particular purpose. The licensors, including Her Majesty, Canada Post and NRCan, shall not be liable in respect of any claim, demand or action, irrespective of the nature of the cause of the claim, demand or action alleging any loss, injury or damages, direct or indirect, which may result from the use or possession of the data or the Data. The licensors, including Her Majesty, Canada Post and NRCan, shall not be liable in any way for loss of revenues or contracts, or any other consequential loss of any kind resulting from any defect in the data or the Data.

End User shall indemnify and save harmless the licensors, including Her Majesty, Canada Post and NRCan, and their officers, employees and agents from and against any claim, demand or action, irrespective of the nature of the cause of the claim, demand or action, alleging loss, costs, expenses, damages or injuries (including injuries resulting in death) arising out of the use or possession of the data or the Data.

4. Additional Provisions: The terms contained in this Section are in addition to all of the rights and obligations of the parties under the Agreement. To the extent that any of the provisions of this Section are inconsistent with, or conflict with, any other provisions of the Agreement, the provisions of this Section shall prevail.

# Appendices

II. Mexico. The following provision applies to the Data for Mexico, which includes certain data from the Instituto Nacional de Estadística y Geografía (“INEGI”):

A. Any and all copies of the Data and/or packaging containing Data for Mexico shall contain the following notice: “Fuente: INEGI (Instituto Nacional de Estadística y Geografía)”

## III. Latin America Territory

A. Third Party Notices. Any and all copies of the Data and/or packaging relating thereto shall include the respective Third Party Notices set forth below and used as described below corresponding to the Territory (or portion thereof) included in such copy:

Territory Notice

Argentina IGN “INSTITUTO GEOGRAFICO NACIONAL ARGENTINO”

Ecuador “INSTITUTO GEOGRAFICO MILITAR DEL ECUADOR AUTORIZACION N° IGM-2011-01- PCO-01 DEL 25 DE ENERO DE 2011”  
“source: © IGN 2009 - BD TOPO ®”

Guadeloupe, French Guiana and Martinique Mexico “Fuente: INEGI (Instituto Nacional de Estadística y Geografía)”

## IV. Middle East Territory

A. Third Party Notices. Any and all copies of the Data and/or packaging relating thereto shall include the respective Third Party Notices set forth below and used as described below corresponding to the Territory (or portion thereof) included in such copy:

Country Notice

Jordan “© Royal Jordanian Geographic Centre”. The foregoing notice requirement for Jordan Data is a material term of the Agreement. If Client or any of its permitted sublicensees (if any) fail to meet such requirement, HERE shall have the right to terminate Client’s license with respect to the Jordan Data.

B. Jordan Data. Client and its permitted sublicensees (if any) are restricted from licensing and/or otherwise distributing HERE’s database for the country of Jordan (“Jordan Data”) for use in Enterprise Applications to (i) non-Jordanian entities for use of the Jordan Data solely in Jordan or (ii) Jordan-based customers. In addition, Client, its permitted sublicensees (if any) and End-Users are restricted from using the Jordan Data in Enterprise Applications if such party is (i) a non-Jordanian entity using the Jordan Data solely in Jordan or (ii) a Jordan-based customer. For purposes of the foregoing, “Enterprise Applications” shall mean Geomarketing applications, GIS applications, mobile business asset management applications, call center applications, telematics applications, public organization Internet applications or for providing geocoding services.

# Appendices

---

## V. Europe Territory

### A. Use of Certain Traffic Codes in Europe

1. General Restrictions Applicable to Traffic Codes. Client acknowledges and agrees that in certain countries of the Europe Territory, Client will need to obtain rights directly from third party RDS-TMC code providers to receive and use the Traffic Codes in the Data and to deliver to End-Users Transactions in any way derived from or based on such Traffic Codes. For such countries, HERE shall deliver the Data incorporating Traffic Codes to Client only after receiving certification from Client of its having obtained such rights.

2. Display of Third Party Rights Legends for Belgium. Client shall, for each Transaction that uses Traffic Codes for Belgium, provide the following notice to the End-User: "Traffic Codes for Belgium are provided by the Ministerie van de Vlaamse Gemeenschap and the Ministère de l'Équipement et des Transports."

B. Paper Maps. With respect to any license granted to Client relating to making, selling or distributing paper maps (i.e., a map fixed on a paper or paper-like medium): (a) such license with respect to Data for the Territory of Great Britain is conditioned on Client's entering into and complying with a separate written agreement with the Ordnance Survey ("OS") to create and sell paper maps, Client's paying to the OS any and all applicable paper map royalties, and Client's complying with the OS copyright notice requirements; (b) such license for selling or otherwise distributing for charge with respect to Data for the Territory of Czech Republic

is conditioned on Client's obtaining prior written consent from Kartografie a.s.; (c) such license for selling or distributing with respect to Data for the Territory of Switzerland is conditioned on Client's obtaining a permit from Bundesamt für Landestopografie of Switzerland; (d) Client is restricted from using Data for the Territory of France to create paper maps with a scale between 1:5,000 and 1:250,000; and (e) Client is restricted from using any Data to create, sell or distribute paper maps that are the same or substantially similar, in terms of data content and specific use of color, symbols and scale, to paper maps published by the European national mapping agencies, including without limitation, Landvermessungämter of Germany, Topografische Dienst of the Netherlands, Nationaal Geografisch Instituut of Belgium, Bundesamt für Landestopografie of Switzerland, Bundesamt für Eich-und Vermessungswesen of Austria, and the National Land Survey of Sweden.

C. OS Enforcement. Without limiting Section IV(B) above, with respect to Data for the Territory of Great Britain, Client acknowledges and agrees that the Ordnance Survey ("OS") may bring a direct action against Client to enforce compliance with the OS copyright notice (see Section IV(D) below) and paper map requirements (see Section IV(B) above) contained in this Agreement.

D. Third Party Notices. Any and all copies of the Data and/or packaging relating thereto shall include the respective Third Party Notices set forth below and used as described below corresponding to the Territory (or portion thereof) included in such copy:

Country(ies) Notice

## Appendices

Austria	“© Bundesamt für Eich- und Vermessungswesen”	Spain	“Información geográfica propiedad del CNIG”
Croatia		Sweden	“Based upon electronic data © National Land Survey Sweden.”
Cyprus,		Switzerland	“Topografische Grundlage: © Bundesamt für Landestopographie.
Estonia,			E. Respective Country Distribution. Client acknowledges that HERE has not received approvals to distribute map data for the following countries in such respective countries: Albania, Belarus, Kyrgyzstan, Moldova and Uzbekistan. HERE may update such list from time to time. The license rights granted to Client under this TL with respect to the Data for such countries are contingent upon Client’s compliance with all applicable laws and regulations, including, without limitation, any required licenses or approvals to distribute the Application incorporating such Data in such respective countries.
Latvia,	“© EuroGeographics”		
Lithuania,			
Moldova,			
Poland,			
Slovenia			
and/or			
Ukraine			
France	“source: © IGN 2009 – BD TOPO ®”		
Germany	“Die Grundlagendaten wurden mit Genehmigung der zuständigen Behörden entnommen”		
Great Britain	“Contains Ordnance Survey data © Crown copyright and database right 2010 Contains Royal Mail data © Royal Mail copyright and database right 2010”		
Greece	“Copyright Geomatics Ltd.”	VI. Australia Territory	
Hungary	“Copyright © 2003; Top-Map Ltd.”		A. Third Party Notices. Any and all copies of the Data and/or packaging relating thereto shall include the respective Third Party Notices set forth below and used as described below corresponding to the Territory (or portion thereof) included in such copy:
Italy	“La Banca Dati Italiana è stata prodotta usando quale riferimento anche cartografia numerica ed al tratto prodotta e fornita dalla Regione Toscana.”		Copyright. Based on data provided under license from PSMA Australia Limited ( <a href="http://www.pasma.com.au">www.pasma.com.au</a> ).
Norway	“Copyright © 2000; Norwegian Mapping Authority”		
Portugal	“Source: IgeoE – Portugal”		

# Appendices

Product incorporates data which is © 20XX Telstra Corporation Limited, GM Holden Limited, Intelomatics Australia Pty Ltd and Continental Pty Ltd.

B. Third Party Notices for Australia. In addition to the foregoing, the End-User Terms for any Application containing RDS-TMC Traffic Codes for Australia shall contain the following notice: “Product incorporates traffic location codes which is © 20XX Telstra Corporation Limited and its licensors.”

## **AT&T Vehicle Network Carrier Telematics Disclosure**

END USER FOR PURPOSES OF THIS SECTION MEANS YOU AND YOUR HEIRS, EXECUTORS, LEGAL PERSONAL REPRESENTATIVES AND PERMITTED ASSIGNS. FOR PURPOSES OF THIS SECTION “UNDERLYING WIRELESS SERVICE CARRIER” INCLUDES ITS AFFILIATES AND CONTRACTORS AND THEIR RESPECTIVE OFFICERS, DIRECTORS, EMPLOYEES, SUCCESSORS AND ASSIGNS. END USER HAS NO CONTRACTUAL RELATIONSHIP WITH THE UNDERLYING WIRELESS SERVICE CARRIER AND END USER IS NOT A THIRD PARTY BENEFICIARY OF ANY AGREEMENT BETWEEN FORD AND UNDERLYING CARRIER. END USER UNDERSTANDS AND AGREES THAT THE UNDERLYING CARRIER HAS NO LEGAL, EQUITABLE, OR OTHER LIABILITY OF ANY KIND TO END USER. IN ANY EVENT, REGARDLESS OF THE FORM OF THE ACTION, WHETHER FOR BREACH OF CONTRACT, WARRANTY, NEGLIGENCE, STRICT LIABILITY IN TORT OR OTHERWISE, END USER'S EXCLUSIVE REMEDY FOR CLAIMS ARISING IN ANY WAY IN CONNECTION WITH THIS AGREEMENT, FOR ANY CAUSE WHATSOEVER, INCLUDING BUT NOT LIMITED TO ANY FAILURE OR

DISRUPTION OF SERVICE PROVIDED HEREUNDER, IS LIMITED TO PAYMENT OF DAMAGES IN AN AMOUNT NOT TO EXCEED THE AMOUNT PAID BY END USER FOR THE SERVICES DURING THE TWO-MONTH PERIOD PRECEDING THE DATE THE CLAIM AROSE.

(ii) END USER AGREES TO INDEMNIFY AND HOLD HARMLESS THE UNDERLYING WIRELESS SERVICE CARRIER AND ITS OFFICERS, EMPLOYEES, AND AGENTS AGAINST ANY AND ALL CLAIMS, INCLUDING WITHOUT LIMITATION CLAIMS FOR LIBEL, SLANDER, OR ANY PROPERTY DAMAGE, PERSONAL INJURY OR DEATH, ARISING IN ANY WAY, DIRECTLY OR INDIRECTLY, IN CONNECTION WITH THIS AGREEMENT OR THE USE, FAILURE TO USE, OR INABILITY TO USE THE DEVICE EXCEPT WHERE THE CLAIMS RESULT FROM THE UNDERLYING CARRIER'S GROSS NEGLIGENCE OR WILLFUL MISCONDUCT. THIS INDEMNITY WILL SURVIVE THE TERMINATION OF THE AGREEMENT.

(iii) END USER HAS NO PROPERTY RIGHT IN ANY NUMBER ASSIGNED TO THE DEVICE.

(iv) END USER UNDERSTANDS THAT FORD AND THE UNDERLYING CARRIER CANNOT GUARANTEE THE SECURITY OF WIRELESS TRANSMISSIONS, AND WILL NOT BE LIABLE FOR ANY LACK OF SECURITY RELATING TO THE USE OF THE SERVICES

THE SERVICE IS FOR [END USER'S] USE ONLY AND END USER MAY NOT RESELL THE SERVICE TO ANY OTHER PARTY END USER UNDERSTANDS THAT THE UNDERLYING CARRIER DOES NOT GUARANTEE ANY END USER UNINTERRUPTED SERVICE OR COVERAGE. THE UNDERLYING CARRIER DOES NOT WARRANT THAT END USERS CAN OR WILL BE LOCATED USING THE SERVICE. THE UNDERLYING CARRIER

# Appendices

---

MAKES NO WARRANTY, EXPRESS OR IMPLIED, OF MERCHANTABILITY OR FITNESS FOR A PARTICULAR PURPOSE, SUITABILITY, OR PERFORMANCE REGARDING ANY SERVICES OR GOODS, AND IN NO EVENT SHALL AT&T BE LIABLE, WHETHER OR NOT DUE TO ITS OWN NEGLIGENCE, FOR ANY: (A) ACT OR OMISSION OF A THIRD PARTY; (B) MISTAKES, OMISSIONS, INTERRUPTIONS, ERRORS, FAILURES TO TRANSMIT, DELAYS, OR DEFECTS IN THE SERVICE PROVIDED BY OR THROUGH THE UNDERLYING CARRIER; (C) DAMAGE OR INJURY CAUSED BY SUSPENSION OR TERMINATION BY THE UNDERLYING CARRIER; OR (D) DAMAGE OR INJURY CAUSED BY A FAILURE OR DELAY IN CONNECTING A CALL TO ANY ENTITY, INCLUDING 911 OR ANY OTHER EMERGENCY SERVICE. TO THE FULL EXTENT ALLOWED BY LAW, THE END USER RELEASES, INDEMNIFIES AND HOLDS THE UNDERLYING CARRIER HARMLESS FROM AND AGAINST ANY AND ALL CLAIMS OF ANY PERSON OR ENTITY FOR DAMAGES OF ANY NATURE ARISING IN ANY WAY FROM OR RELATING TO, DIRECTLY OR INDIRECTLY, SERVICES PROVIDED BY THE UNDERLYING CARRIER OR ANY PERSON'S USE THEREOF, INCLUDING CLAIMS ARISING IN WHOLE OR IN PART FROM THE ALLEGED NEGLIGENCE OF THE UNDERLYING CARRIER.

## **VII. China Territory**

### ***Personal Use Only***

You agree to use this Data together with [insert name of Client Application] for the solely personal, non-commercial purposes for which you were licensed, and not for service bureau, time-sharing or other similar purposes. Accordingly, but subject to the restrictions set forth in the following paragraphs, you may copy this Data only as necessary for your personal use to (i)

view it, and (ii) save it, provided that you do not remove any copyright notices that appear and do not modify the Data in any way. You agree not to otherwise reproduce, copy, modify, decompile, disassemble or reverse engineer any portion of this Data, and may not transfer or distribute it in any form, for any purpose, except to the extent permitted by mandatory laws.

### ***Restrictions***

Except where you have been specifically licensed to do so by NAV2, and without limiting the preceding paragraph, you may not (a) use this Data with any products, systems, or applications installed or otherwise connected to or in communication with vehicles, capable of vehicle navigation, positioning, dispatch, real time route guidance, fleet management or similar applications; or (b) with or in communication with any positioning devices or any mobile or wireless-connected electronic or computer devices, including without limitation cellular phones, palmtop and handheld computers, pagers, and personal digital assistants or PDAs. You agree to cease using this Data if you fail to comply with these terms and conditions.

### ***Limited Warranty***

NAV2 warrants that (a) the Data will perform substantially in accordance with the accompanying written materials for a period of ninety (90) days from the date of receipt, and (b) any support services provided by NAV2 shall be substantially as described in applicable written materials provided to you by NAV2, and NAV2's support engineers will make commercially reasonable efforts to solve any problem issues.

# Appendices

## **Customer Remedies**

NAV2 and its suppliers' entire liability and your exclusive remedy shall be, at NAV2's sole discretion, either (a) return of the price paid, if any, or (b) repair or replacement of the Data that do not meet NAV2's Limited Warranty and that are returned to NAV2 with a copy of your receipt. This Limited Warranty is void if failure of the Data has resulted from accident, abuse, or misapplication. Any replacement Data will be warranted for the remainder of the original warranty period or thirty (30) days, whichever is longer. Neither these remedies nor any product support services offered by NAV2 are available without proof of purchase from an authorized international source.

## **No Other Warranty:**

EXCEPT FOR THE LIMITED WARRANTY SET FORTH ABOVE AND TO THE EXTENT PERMITTED BY APPLICABLE LAW, NAV2 AND ITS LICENSORS (INCLUDING THEIR LICENSORS AND SUPPLIERS) DISCLAIM ANY WARRANTIES, EXPRESS OR IMPLIED, OF QUALITY, PERFORMANCE, MERCHANTABILITY, FITNESS FOR A PARTICULAR PURPOSE, OWNERSHIP OR NON-INFRINGEMENT. Certain warranty exclusions may not be permitted under applicable law, so to that extent the above exclusion may not apply to you.

## **Limited Liability:**

TO THE EXTENT PERMITTED BY APPLICABLE LAW, NAV2 AND ITS LICENSORS (INCLUDING THEIR LICENSORS AND SUPPLIERS) SHALL NOT BE LIABLE TO YOU: IN RESPECT OF ANY CLAIM, DEMAND OR ACTION, IRRESPECTIVE OF THE NATURE OF THE CAUSE OF THE CLAIM, DEMAND OR ACTION ALLEGING ANY LOSS, INJURY OR DAMAGES, DIRECT OR INDIRECT, WHICH MAY RESULT FROM THE USE OR POSSESSION OF THE INFORMATION; OR

FOR ANY LOSS OF PROFIT, REVENUE, CONTRACTS OR SAVINGS, OR ANY OTHER DIRECT, INDIRECT, INCIDENTAL, SPECIAL OR CONSEQUENTIAL DAMAGES ARISING OUT OF YOUR USE OF OR INABILITY TO USE THIS INFORMATION, ANY DEFECT IN THE INFORMATION, OR THE BREACH OF THESE TERMS OR CONDITIONS, WHETHER IN AN ACTION IN CONTRACT OR TORT OR BASED ON A WARRANTY, EVEN IF NAV2 OR ITS LICENSORS HAVE BEEN ADVISED OF THE POSSIBILITY OF SUCH DAMAGES. UNDER NO CIRCUMSTANCES SHALL NAV2'S OR ITS SUPPLIERS' LIABILITY HEREUNDER EXCEED THE PRICE PAID. Certain liability exclusions may not be permitted under applicable law, so to that extent the above exclusion may not apply to you.

## **Export Control**

You agree not to export to anywhere any part of the Data provided to you or any direct product thereof except in compliance with, and with all licenses and approvals required under, applicable export laws, rules and regulations.

## **IP Protection**

The Data are owned by NAV2 or its suppliers and are protected by applicable copyright and other intellectual property law and treaties. The Data are provided solely on the basis of a license to use, not sale.

## **Entire Agreement**

These terms and conditions constitute the entire agreement between NAV2 (and its licensors, including their licensors and suppliers) and you pertaining to the subject matter hereof, and supersedes in their entirety any and all written or oral agreements previously existing between us with respect to such subject matter.



# Appendices

---

## **Governing Law.**

The above terms and conditions shall be governed by the laws of the People's Republic of China, without giving effect to (i) its conflict of laws provisions, or (ii) the United Nations Convention for Contracts for the International Sale of Goods, which is explicitly excluded. Any dispute arising from or in connection with the Data provided to you hereunder shall be submitted to the Shanghai International Economic and Trade Arbitration Commission for arbitration.

## **Gracenote® Copyright**

CD and music-related data from Gracenote, Inc., copyright©

2000-2007 Gracenote. Gracenote Software, copyright © 2000-2007 Gracenote. This product and service may practice one or more of the following U.S. Patents 5,987,525; 6,061,680; 6,154,773; 6,161,132; 6,230,192; 6,230,207; 6,240,459; 6,330,593 and other patents issued or pending. Some services supplied under license from Open Globe, Inc. for U.S. Patent 6,304,523.

Gracenote and CDDB are registered trademarks of Gracenote. The Gracenote logo and logotype, and the "Powered by Gracenote™" logo are trademarks of Gracenote.

## **Gracenote® End User License Agreement (EULA)**

This device contains software from Gracenote, Inc. of 2000 Powell Street Emeryville, California 94608 ("Gracenote").

The software from Gracenote (the "Gracenote Software") enables this device to do disc and music file identification and obtain music-related information, including name, artist, track, and title information ("Gracenote Data") from online servers

("Gracenote Servers"), and to perform other functions. You may use Gracenote Data only by means of the intended End User functions of this device. This device may contain content belonging to Gracenote's providers. If so, all of the restrictions set forth herein with respect to Gracenote Data shall also apply to such content and such content providers shall be entitled to all of the benefits and protections set forth herein that are available to Gracenote. You agree that you will use the content from Gracenote ("Gracenote Content"), Gracenote Data, the Gracenote Software, and Gracenote Servers for your own personal, non-commercial use only. You agree not to assign, copy, transfer or transmit the Gracenote Content, Gracenote Software or any Gracenote Data (except in a Tag associated with a music file) to any third party. YOU AGREE NOT TO USE OR EXPLOIT GRACENOTE CONTENT, GRACENOTE DATA, THE GRACENOTE SOFTWARE, OR GRACENOTE SERVERS, EXCEPT AS EXPRESSLY PERMITTED HEREIN.

You agree that your non-exclusive licenses to use the Gracenote Content, Gracenote Data, the Gracenote Software, and Gracenote Servers will terminate if you violate these restrictions. If your licenses terminate, you agree to cease any and all use of the Gracenote Content, Gracenote Data, the Gracenote Software, and Gracenote Servers.

Gracenote, respectively, reserve all rights in Gracenote Data, the Gracenote Software, and the Gracenote Servers and Gracenote Content, including all ownership rights. Under no circumstances will either Gracenote become liable for any payment to you for any information that you provide,

# Appendices

including any copyrighted material or music file information. You agree that Gracenote may enforce its respective rights, collectively or separately, under this agreement against you, directly in each company's own name.

Gracenote uses a unique identifier to track queries for statistical purposes. The purpose of a randomly assigned numeric identifier is to allow Gracenote to count queries without knowing anything about who you are. For more information, see the web page at [www.gracenote.com](http://www.gracenote.com) for the Gracenote Privacy Policy.

THE GRACENOTE SOFTWARE, EACH ITEM OF GRACENOTE DATA AND THE GRACENOTE CONTENT ARE LICENSED TO YOU "AS IS". NEITHER GRACENOTE MAKES ANY REPRESENTATIONS OR WARRANTIES, EXPRESS OR IMPLIED, REGARDING THE ACCURACY OF ANY GRACENOTE DATA FROM THE GRACENOTE SERVERS OR GRACENOTE CONTENT. GRACENOTE COLLECTIVELY AND SEPARATELY RESERVE THE RIGHT TO DELETE DATA AND/OR CONTENT FROM THE COMPANIES' RESPECTIVE SERVERS OR, IN THE CASE OF GRACENOTE, CHANGE DATA CATEGORIES FOR ANY CAUSE THAT GRACENOTE DEEMS SUFFICIENT. NO WARRANTY IS MADE THAT EITHER GRACENOTE CONTENT OR THE GRACENOTE SOFTWARE OR GRACENOTE SERVERS ARE ERROR-FREE OR THAT THE FUNCTIONING OF THE GRACENOTE SOFTWARE OR GRACENOTE SERVERS WILL BE UNINTERRUPTED. GRACENOTE IS NOT OBLIGATED TO PROVIDE YOU WITH ANY ENHANCED OR ADDITIONAL DATA TYPES THAT GRACENOTE MAY CHOOSE TO PROVIDE IN THE FUTURE AND IS FREE TO DISCONTINUE ITS ONLINE SERVICES AT ANY TIME. GRACENOTE DISCLAIM ALL WARRANTIES EXPRESS OR IMPLIED, INCLUDING, BUT NOT LIMITED TO,

IMPLIED WARRANTIES OF MERCHANTABILITY, FITNESS FOR A PARTICULAR PURPOSE, TITLE, AND NON-INFRINGEMENT. NEITHER GRACENOTE WARRANTS THE RESULTS THAT WILL BE OBTAINED BY YOUR USE OF THE GRACENOTE SOFTWARE OR ANY GRACENOTE SERVER. IN NO CASE WILL GRACENOTE BE LIABLE FOR ANY CONSEQUENTIAL OR INCIDENTAL DAMAGES OR FOR ANY LOST PROFITS OR LOST REVENUES FOR ANY REASON WHATSOEVER. © Gracenote 2007.

## **Radio Frequency Statement**

FCC ID: ACJ-SYNCG3-L

IC: 216B-SYNCG3-L

This device complies with Part 15 of the FCC Rules and with RSS-210 of Industry Canada. Operation is subject to the following two conditions:

- (1)** This device may not cause harmful interference, and
- (2)** this device must accept any interference received, including interference that may cause undesired operation.

 **WARNING:** Changes or modifications not expressly approved by the party responsible for compliance could void the user's authority to operate the equipment. The term "IC:" before the radio certification number only signifies that Industry Canada technical specifications were met.

The antenna used for this transmitter must not be co-located or operating in conjunction with any other antenna or transmitter.

# Appendices

## Taiwan Territory

Note: In accordance with the management approach of low-power radio wave radiation motors:

Article 12: For approved and certified low-power radiation motor models, companies, firms or users must not alter the frequency, increase the power or change the characteristics and functions of the original design without authorization.

Article 14: The usage of low-power radio-frequency motors must not affect aviation safety and interfere with legal telecommunications. Should interference be detected, immediately stop using the device and only resume usage after ensuring that there is no longer any interference. For the legal telecommunication and wireless telecommunication of the telco, the low-power radio frequency motor must be able to tolerate legal limits of interference from telecommunication, industrial, scientific and radio wave equipment.

## SUNA TRAFFIC CHANNEL – TERMS AND CONDITIONS

By activating, using and/or accessing the SUNA Traffic Channel, SUNA Predictive or other content or material provided by Intelematics (together, **SUNA Products and/or Services**), you must accept certain terms and conditions. The following is a brief summary of the terms and conditions that apply to you. To view the full terms and conditions relevant to your use of the SUNA Products and/or Services, please consult:

Website
<a href="http://www.sunatrafic.com.au/termsandconditions/">www.sunatrafic.com.au/termsandconditions/</a>

### 1. Acceptance

By using SUNA Products and/or Services, you will be deemed to have accepted and agreed to be bound by the terms and conditions fully detailed at:

Website
<a href="http://www.sunatrafic.com.au/termsandconditions/">www.sunatrafic.com.au/termsandconditions/</a>

### 2. Intellectual Property

SUNA Products and/or Services are for your personal use. You may not record, or retransmit the content, nor use the content in association with any other traffic information or route guidance service or device not approved by Intelematics. You obtain no right of ownership in any Intellectual Property Rights (including copyright) in the data that is used to provide SUNA Products and/or Services.

### 3. Appropriate Use

SUNA Products and/or Services are intended as an aid to personal motoring and travel planning, and do not provide comprehensive or accurate information on all occasions. On occasions, you may experience additional delay as a result of using SUNA Products and/or Services. You acknowledge that it is not intended, or suitable, for use in applications where time of arrival or driving directions may impact the safety of the public or yourself.

### 4. Use of SUNA Products and Services while driving

You, and other authorised drivers of the vehicle in which SUNA Products and/or Services are available or installed and active, remain at all times responsible for observing all relevant laws and codes of safe driving. In particular, you agree to only actively operate SUNA Products and/or Services when the Vehicle is at a complete stop and it is safe to do so.

# Appendices

## 5. Service Continuity and Reception of the SUNA Traffic Channel

We will use reasonable endeavours to provide the SUNA Traffic Channel 24 hours a day, 365 days a year. The SUNA Traffic Channel may occasionally be unavailable for technical reasons or for planned maintenance. We will try to perform maintenance at times when congestion is light. We reserve the right to withdraw SUNA Products and/or Services at any time.

Also, we cannot assure the uninterrupted reception of the SUNA Traffic Channel RDS-TMC signal at any particular location.

## 6. Limitation of Liability

Neither Intelematics (nor its suppliers or the manufacturer of your device (the “**Suppliers**”)) shall be liable to you or to any third party for any damages either direct, indirect, incidental, consequential or otherwise arising out of the use of or

inability to use SUNA Products and/or Services even if Intelematics or a Supplier has been advised of the possibility of such damages. You also acknowledge that the neither Intelematics nor any Supplier guarantees nor make any warranties that relate to the availability, accuracy or completeness of SUNA Products and/or Services, and to the extent which it is lawful to do so, both Intelematics and each Supplier excludes any warranties which might otherwise be implied by any State or Federal legislation in relation to SUNA Products and/or Services.

## 7. Please Note

Great care has been taken in preparing this manual. Constant product development may mean that some information is not entirely up-to-date. The information in this document is subject to change without notice.

# DECLARATION OF CONFORMITY

## Radio Frequency Statement

SYNC Version	FCC Identification Number	IC Identification Number
3.0	ACJ-SYNCG3-L	216B-SYNCG3-L
3.1	ACJ-FA-170-BCARHS	216B-FA170BCARHS
3.2	ACJ-FG-185-SG32MH	216B-FG185SG32MH



**WARNING:** Changes or modifications not expressly approved by the party responsible for compliance could void the user's authority to operate the equipment. The term "IC:" before the radio certification number only signifies that Industry Canada technical specifications were met.

These devices comply with Part 15 of the FCC Rules and with RSS-210 of Industry Canada. Operation is subject to the following two conditions:

1. The device does not cause harmful interference.
2. The device accepts any interference received, including interference that could cause undesired operation.

# Appendices

## TYPE APPROVALS

### Radio Frequency Certifications for Blind Spot Information System (if

Equipped)

#### Argentina



#### Brazil



#### Canada and United States of America

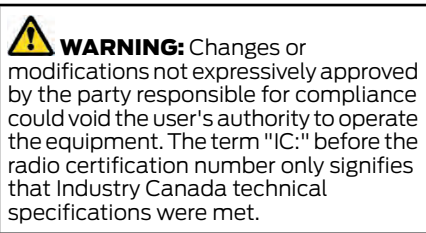

FCC ID: OAYSRR3B

IC: 4135A-SRR3B

This device complies with Part 15 of the FCC Rules and with Innovation, Science and Economic Development Canada's licence-exempt RSS(s). Operation is subject to the following two conditions:

1. This device may not cause harmful interference, and
2. This device must accept any interference received, including interference that may cause undesired operation.

#### European Union EU



#### Ghana

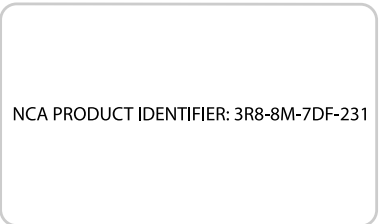

# Appendices

## Malaysia



## United Arab Emirates (U.A.E.)

TRA  
REGISTERED No. ER39534/15  
DEALER No.: DA37380/15

## Paraguay



## Vietnam



## South Africa



## Radio Frequency Certifications for Body Control Module

### Canada and United States of America

 **WARNING:** Changes or modifications not expressly approved by the party responsible for compliance could void the user's authority to operate the equipment. The term "IC:" before the radio certification number only signifies that Industry Canada technical specifications were met.

FCC ID: LXPP004

IC: 2298A-P004

# Appendices

This device complies with Part 15 of the FCC Rules and with Innovation, Science and Economic Development Canada's licence-exempt RSS(s). Operation is subject to the following two conditions:

1. This device may not cause harmful interference, and
2. This device must accept any interference received, including interference that may cause undesired operation.

## Radio Frequency Certifications for Cruise Control Module

### Argentina



### Brazil



## Canada and United States of America



**WARNING:** Changes or modifications not expressly approved by the party responsible for compliance could void the user's authority to operate the equipment. The term "IC:" before the radio certification number only signifies that Industry Canada technical specifications were met.

FCC ID: L2C0065TR

IC: 3432A-0065TR

This device complies with Part 15 of the FCC Rules and with Innovation, Science and Economic Development Canada's licence-exempt RSS(s). Operation is subject to the following two conditions:

1. This device may not cause harmful interference, and
2. This device must accept any interference received, including interference that may cause undesired operation.

## Radio Frequency Certifications for Integrated Keyhead Transmitter

### Canada and United States of America



**WARNING:** Changes or modifications not expressly approved by the party responsible for compliance could void the user's authority to operate the equipment. The term "IC:" before the radio certification number only signifies that Industry Canada technical specifications were met.

FCC ID: N5F-A08TAA

IC: 3248A-A08TAA

# Appendices

This device complies with Part 15 of the FCC Rules and with Innovation, Science and Economic Development Canada's licence-exempt RSS(s). Operation is subject to the following two conditions:

1. This device may not cause harmful interference, and
2. This device must accept any interference received, including interference that may cause undesired operation.

## Radio Frequency Certifications for Passive Anti-Theft System

### Canada and United States of America



**WARNING:** Changes or modifications not expressly approved by the party responsible for compliance could void the user's authority to operate the equipment. The term "IC:" before the radio certification number only signifies that Industry Canada technical specifications were met.

FCC ID: OUC26006559

IC: 850K-26006559

This device complies with Part 15 of the FCC Rules and with Innovation, Science and Economic Development Canada's licence-exempt RSS(s). Operation is subject to the following two conditions:

1. This device may not cause harmful interference, and
2. This device must accept any interference received, including interference that may cause undesired operation.

## Radio Frequency Certifications for Passive Key

### Argentina



CNC ID: H-16355



CNC ID: H-22290

### Brazil



02444-16-01821



# Appendices



## Ghana

**NCA APPROVED: 2R9-1H-7E0-01A**

## Canada and United States of America

**NCA APPROVED: 2R9-8M-7E0-x94**



**WARNING:** Changes or modifications not expressly approved by the party responsible for compliance could void the user's authority to operate the equipment. The term "IC:" before the radio certification number only signifies that Industry Canada technical specifications were met.

## Jamaica

This product has been Type Approved by Jamaica: SMA – M3N-A2C931423

FCC ID: M3N-A2C931423

FCC ID: M3N-A2C931426

IC: 7812A-A2C931423

IC: 7812A-A2C931426

This device complies with Part 15 of the FCC Rules and with Innovation, Science and Economic Development Canada's licence-exempt RSS(s). Operation is subject to the following two conditions:

1. This device may not cause harmful interference, and
2. This device must accept any interference received, including interference that may cause undesired operation.

**This product has been Type Approved by Jamaica: SMA – A2C93142100**

This product has been Type Approved by Jamaica: SMA – A2C97102000

## Djibouti

AGREE PAR LE MCPT (REPUBLIQUE DE DJIBOUTI)

Numéro d'agrément : 289/MCPT/SC/116

Date d'agrément : 02/07/2016

# Appendices

## Jordan

Type Approval No.: TRC/LPD/2016/142  
Equipment Type: Low Power Device (LPD)

## Morocco

AGREE PAR L'ANRT MAROC  
Numéro d'agrément : MR 12433 ANRT 2016  
Date d'agrément : 31/08/2016

## Malaysia



F17000176

## Mauritania

AGREE PAR L'ANE MAURITANIE  
Numéro d'agrément : 0323/ARE/2016  
Date d'agrément : 07/03/2016

## Moldova



## Pakistan

Pakistan Telecommunication Authority



Approved by PTA 2016

## Paraguay



NR: 2016-9-I-000220

NR: 2016-9-I-000222

NR: 2016-9-I-000223

# Appendices

---

## Serbia



## South Korea



MSIP-CRM-TAL-A2C97102000

## Singapore

Complies with IMDA Standards

DA 00461

## Taiwan, China



## South Africa



# Appendices

## South Korea



MSIP-CRM-TAL-A2C97102000

## United Arab Emirates (U.A.E)

TRA  
REGISTERED No:  
ER46754/16

DEALER No:  
DA37380/15

TRA  
REGISTERED No:  
ER46454/16

DEALER No:  
DA37380/15

## Vietnam



## Zambia



## Radio Frequency Certifications for SYNC3.2

## Argentina



# Appendices

## Brazil



## Djibouti

AGREE PAR LE MCPT (REPUBLIQUE DE DJIBOUTI)  
Numéro d'agrément: 634/MCPT/DPT/17  
Date d'agrément: 04/12/2017

## Canada and United States of America

 **WARNING:** Changes or modifications not expressly approved by the party responsible for compliance could void the user's authority to operate the equipment. The term "IC:" before the radio certification number only signifies that Industry Canada technical specifications were met.

FCC ID: ACJ-FG-185-SG32MH

IC: 216B-FG185SG32MH

This device complies with Part 15 of the FCC Rules and with Innovation, Science and Economic Development Canada's licence-exempt RSS(s). Operation is subject to the following two conditions:

1. This device may not cause harmful interference, and
2. This device must accept any interference received, including interference that may cause undesired operation.

## China

CMIIT ID: 2017AJ4997

## European Union EU

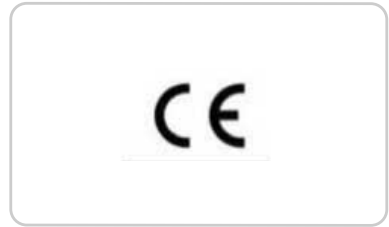

## Ghana

NCA APPROVED: BR3-1M-GE2-04F

# Appendices

## Malaysia



RBAB/57H/0318/S(18-0624)

## Morocco

AGREE PAR L'ANRT MAROC  
Numéro d'agrément: MR 15193 ANRT 2017  
Date d'agrément: 22/11/2017

## Serbia



## Singapore

Complies with IDA Standards

N4414-17

## Paraguay



NR: 2017-12-I-0000413

## South Africa



# Appendices

---

## South Korea



MSIP-CMM-pAs-FA-170-BCAR-HS

## Taiwan, China

## United Arab Emirates (U.A.E.)

TRA

REGISTERED No. ER61783/18

## Vietnam



## Zambia

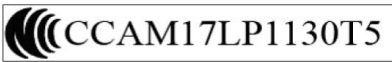

## Ukraine



# Appendices

## Radio Frequency Certifications for Radio Transceiver Module

### Argentina



This device complies with Part 15 of the FCC Rules and with Innovation, Science and Economic Development Canada's licence-exempt RSS(s). Operation is subject to the following two conditions:

1. This device may not cause harmful interference, and
2. This device must accept any interference received, including interference that may cause undesired operation.

### Djibouti

AGREE PAR LE MCPT (REPUBLIQUE DE DJIBOUTI)  
Numéros d'agrément : 033/DDTIC/2020  
Date d'agrément : 07/06/2020

### Brazil



### Ghana

NCA APPROVED: SRO-1M-7E4-108

### Canada and United States of America

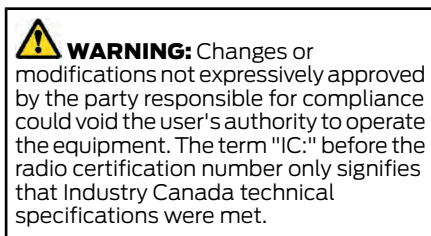

FCC ID: FO1-TR903BDA

IC: FO1-TR903BDA

### Mauritania

AGREE PAR L'ANE MAURITANIE  
Numéro d'agrément: 0803/ARE/2020  
Date d'agrément: 03/06/2020



# Appendices

## Moldova



## Serbia



## Morocco

AGREE PAR L'ANE MAROC  
Numéro d'agrément : MR 24102 ANRT 2020  
Date d'agrément : 18/05/2020

## South Africa



## Pakistan



## Taiwan, China

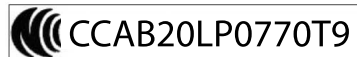

# Appendices

## Ukraine



## Radio Frequency Certifications for Telematics Control Unit

### Brazil



## United Arab Emirates (U.A.E.)

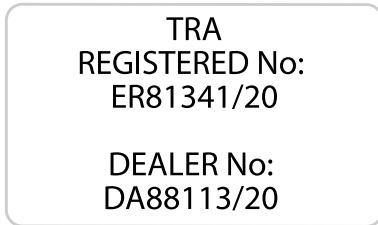

## Canada and United States of America



FCC ID: LHJ-FB40ND1

This device complies with Part 15 of the FCC Rules and with Innovation, Science and Economic Development Canada's licence-exempt RSS(s). Operation is subject to the following two conditions:

1. This device may not cause harmful interference, and
2. This device must accept any interference received, including interference that may cause undesired operation.

## Zambia



# Appendices

## Radio Frequency Certifications for Tire Pressure Monitoring Sensor(s)

### Argentina



### Brazil



### Canada and United States of America

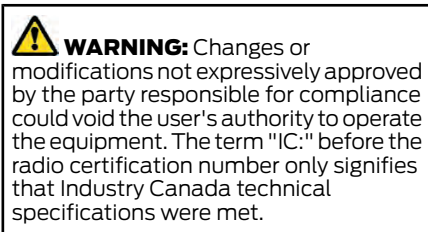

FCC ID: MRXAG2SZ3

FCC ID: MRXAG2SZ4

IC: 2546A- AG2SZ3

IC: 2546A- AG2SZ4

This device complies with Part 15 of the FCC Rules and with Innovation, Science and Economic Development Canada's licence-exempt RSS(s). Operation is subject to the following two conditions:

1. This device may not cause harmful interference, and
2. This device must accept any interference received, including interference that may cause undesired operation.

### China

CMIIT ID:2014DJ1923

### European Union EU

Hereby, Schrader Electronics Ltd. declares that the radio equipment type AG2SZ4 is in compliance with Directive 2014/53/EU.  
The full text of the EU declaration of conformity is available at the following internet address:  
[http://www.tpsensuroshop.com/documents/declaration\\_conformite](http://www.tpsensuroshop.com/documents/declaration_conformite)  
F=433.92MHzP < 10mW (e.i.r.p)  
Schrader Electronics Ltd. 11 Technology Park, Belfast Road, Antrim BT41 1QS, Northern Ireland United Kingdom.

### Ghana

NCA APPROVED: 3R88M14030

E253824

### Jamaica

This product has been Type Approved by Jamaica: SMA – AG2SZ3

# Appendices

## Jordan

Kingdom of Jordan Type approval for tyre presse sensor  
Model : AG2SZ4  
Manufacturer:Schrader Electronics Ltd  
Type Approval Number:TRC/LPD/2014/56  
Equipment Type: Low Power Device (LPD)

## Malaysia



## Mexico

**IFT: RLVSCMR15-1238**

E253812

IFT: RLVSCFP15-1249

"La operación de este equipo está sujeta a las siguientes dos condiciones: (1) es posible que este equipo o dispositivo no cause interferencia perjudicial y (2) este equipo o dispositivo debe aceptar cualquier interferencia, incluyendo la que pueda causar su operación no deseada."

## Moldova



## Morocco

AGREE PAR L'ANRT MAROC  
Numéro d'agrément: MR9098  
ANRT 2014  
Date d'agrément: 14/03/2014

## Oman

OMAN TRA  
TA-R/1752/14  
D090258

## Paraguay



**NR: 2014-07-1-000191**

# Appendices

---

## Philippines



Type Approved

**NTC**

No:ESD-1408639C

## South Africa



TA-2014/064

Approved

## Russia



## South Korea



MSIP-CRM-SRD-AG2SZ4

## Serbia



## Taiwan, China



CCAM14LP0090T3

## Singapore

Complies with  
IDA Standards  
DA 105282

# Appendices



CCAM14LP0460T0

本產品符合低功率電波輻射性電機管理辦法第十二條、第十四條等條文規定

1. 原型式認證合格之低功率射頻電機，未經許可，公司、商號或使用者均不得擅自變更頻率、加大功率或變更原設計之特性及功能。

2. 低功率射頻電機之使用不得影響飛航安全及干擾合法通信；經發現有干擾現象時，應立即停用，並改善至無干擾時方得繼續使用。

前述合法通信，指依電信法規定作業之無線電通信。

低功率射頻電機須忍受合法通信或工業、科學及醫療用電波輻射性電機設備之干擾。

## Ukraine



109

## United Arab Emirates (U.A.E.)

TRA  
REGISTERED No.:  
ER0130238/14  
DEALER No.:  
DA0047074/10

## Radio Frequency Certifications for Wireless Accessory Charging Module

### Brazil



### Canada and United States of America

 **WARNING:** Changes or modifications not expressly approved by the party responsible for compliance could void the user's authority to operate the equipment. The term "IC:" before the radio certification number only signifies that Industry Canada technical specifications were met.

FCC ID: L2C0066T

This device complies with Part 15 of the FCC Rules and with Innovation, Science and Economic Development Canada's licence-exempt RSS(s). Operation is subject to the following two conditions:

1. This device may not cause harmful interference, and
2. This device must accept any interference received, including interference that may cause undesired operation.



# Index

## 1

180 Degree Camera.....	191
Camera Views.....	192
Using the System.....	192

## 4

4WD	
See: Four-Wheel Drive.....	172

## 9

911 Assist.....	51
-----------------	----

## A

### A/C

See: Climate Control - Vehicles With: Dual Automatic Temperature Control (DATC).....	121
See: Climate Control - Vehicles With: Electronic Automatic Temperature Control (EATC).....	125
See: Climate Control - Vehicles With: Manual Temperature Control.....	129

About This Manual.....	9
------------------------	---

### ABS

See: Brakes.....	176
ABS driving hints	
See: Hints on Driving With Anti-Lock Brakes.....	176

Accessories.....	393
------------------	-----

### Accessories

See: Replacement Parts Recommendation.....	16
--	----

Adaptive Cruise Control.....	195
------------------------------	-----

Adaptive Cruise Control – Troubleshooting.....	204
--	-----

Adaptive Cruise Control Indicators.....	201
---	-----

Intelligent Adaptive Cruise Control Indicators.....	202
---	-----

Lane Centering Indicators.....	201
--------------------------------	-----

### Adaptive Cruise Control

Limitations.....	196
Lane Centering Limitations.....	198
Sensor Limitations.....	196

### Adaptive Cruise Control

Precautions.....	195
Hilly Condition Usage.....	196
Lane Centering Precautions.....	196
When Following a Vehicle.....	196

### Adaptive Cruise Control –

Troubleshooting.....	204
Adaptive Cruise Control – Information Messages.....	204

Adjusting the Headlamps.....	284
------------------------------	-----

Horizontal Aim Adjustment.....	285
--------------------------------	-----

Vertical Aim Adjustment.....	284
------------------------------	-----

### Adjusting the Luggage Compartment

Divider.....	233
Divider Position.....	234
Folded Shelf Position.....	233
Full Shelf Position.....	233
Storage Position.....	234
Table Position.....	233

### Adjusting the Luggage Compartment

Load Floor.....	233
Adjusting the Set Speed	
Tolerance.....	204

Adjusting the Steering Wheel.....	74
-----------------------------------	----

Airbag Disposal.....	50
----------------------	----

### Air Conditioning

See: Climate Control - Vehicles With: Dual Automatic Temperature Control (DATC).....	121
--	-----

See: Climate Control - Vehicles With: Electronic Automatic Temperature Control (EATC).....	125
--	-----

See: Climate Control - Vehicles With: Manual Temperature Control.....	129
---	-----

Air Conditioning System Capacity and Specification - 1.5L EcoBoost™.....	334
--	-----

Air Conditioning System Capacity and Specification - 2.0L EcoBoost™.....	333
--	-----

### Air Filter

See: Changing the Engine Air Filter.....	276
--	-----

### Alarm

See: Anti-Theft Alarm.....	72
----------------------------	----

Ambient Lighting.....	85
-----------------------	----

Adjusting the Brightness.....	85
-------------------------------	----

Switching Ambient Lighting Off.....	85
-------------------------------------	----

Switching Ambient Lighting On.....	85
------------------------------------	----

Anti-Theft Alarm.....	72
-----------------------	----

Arming the Alarm.....	73
-----------------------	----



# Index

Disarming the Alarm.....	73
Appendices.....	405
Apps.....	376
SiriusXM Traffic and Travel Link.....	377
Using Apps on an Android Device.....	377
Using Apps on an iOS Device.....	376
Using Mobile Navigation on an Android Device.....	377
At a Glance.....	20
Audible Warnings and Indicators.....	98
Headlamps On Warning Chime.....	98
Key in Ignition Warning Chime.....	98
Keyless Warning Alert.....	98
Parking Brake On Warning Chime.....	98
Audio Control.....	74
You can operate the following functions with the control:.....	74
Audio System.....	342
General Information.....	342
Audio Unit.....	342
Adjusting the Volume.....	343
Changing Radio Stations.....	343
Muting the Audio.....	343
Pausing or Playing Media.....	343
Switching the Audio Unit On and Off.....	343
Switching the Display On and Off.....	343
Using Seek, Fast Forward and Reverse.....	343
Auto Hold.....	179
Auto Hold Indicator.....	180
Switching Auto Hold On and Off.....	179
Using Auto Hold.....	180
Autolamps.....	81
Windshield Wiper Activated Headlamps.....	81
Automatic High Beam Control.....	86
Automatic High Beam Control Indicators.....	86
Automatic Transmission.....	166
Automatic Return to Park.....	168
Drive (D).....	167
If Your Vehicle Gets Stuck in Mud or Snow.....	171
Low(L).....	167
Manual (M).....	167
Manual Park Release.....	169
Neutral (N).....	167
Park (P).....	167
Reverse (R).....	167
SelectShift.....	167
Stay in Neutral Mode.....	168
Understanding the Shift Positions of Your Automatic Transmission.....	166
Automatic Transmission Fluid Check.....	281
Auto Mode.....	123
Auto Mode Indicators.....	123
Switching Auto Mode On and Off.....	123
Switching Dual Mode On and Off.....	124
Auto-Start-Stop.....	153
Disabling Auto-Start-Stop.....	154
Enabling Auto-Start-Stop.....	153
Autowipers.....	77
Autowipers Settings.....	78

## B

Battery	
See: Changing the 12V Battery.....	282
Blind Spot Information System	
Blind Spot Information System Indicator.....	212
Blind Spot Information System Information Messages.....	213
Blind Spot Information System Sensors.....	212
Switching the Blind Spot Information System On and Off.....	212
Using the Blind Spot Information System.....	212
BLIS	
See: Blind Spot Information System.....	211
Bonnet Lock	
See: Opening and Closing the Hood.....	271
Booster Seats.....	28
Types of Booster Seats.....	29
Brake Fluid Check.....	281
Brake Fluid Service Interval.....	282
Brake Fluid Specification.....	335
Brakes.....	176
General Information.....	176
Breaking-In.....	248
Brakes and Clutch.....	248
Tires.....	248
Bulb Specification Chart.....	326

# Index

## C

Canceling the Set Speed.....	185
Capacities and Specifications.....	323
Car Wash	
See: Cleaning the Exterior.....	290
Catalytic Converter.....	163
On-Board Diagnostics (OBD-II).....	164
Readiness for Inspection and Maintenance (I/M) Testing.....	164
Changing a Bulb.....	287
Replacing Fog Lamp Bulbs.....	287
Replacing Headlamp Bulbs.....	287
Replacing High Mount Brake Lamp Bulbs.....	288
Replacing License Plate Lamp Bulbs.....	288
Replacing Reverse Lamp Assembly Bulbs.....	288
Replacing the Side Marker Bulbs.....	287
Replacing Turn Signal Lamps.....	287
Changing a Fuse.....	269
Engine Compartment Fuse Box.....	269
Fuse Types.....	270
General Information.....	269
Changing a Road Wheel.....	316
Dissimilar Spare Wheel and Tire Assembly Information.....	316
Tire Change Procedure.....	317
Changing the 12V Battery.....	282
Remove and Reinstall the Battery.....	283
Changing the Engine Air Filter.....	276
Changing the Front Wiper Blades.....	286
Changing the Rear Wiper Blades.....	286
Changing the Vehicle Wi-Fi Hotspot Name or Password.....	341
Charging a Wireless Device.....	144
Checking MyKey System Status.....	61
MyKey Distance.....	61
Number of Admin Keys.....	62
Number of MyKeys.....	62
Checking the Wiper Blades.....	286
Child Restraint and Seatbelt Maintenance.....	40
Child Restraint Positioning.....	30
Child Safety.....	21
General Information.....	21
Child Safety Locks.....	32
Left-Hand Side.....	33
Right-Hand Side.....	33
Cleaning Products.....	289
Materials.....	289
Cleaning the Engine.....	291
Cleaning the Exterior.....	290
Cleaning the Exterior Lamps.....	290
Cleaning the Exterior Precautions.....	290
Exterior Chrome Parts.....	290
Exterior Plastic Parts.....	290
Stripes or Graphics.....	290
Underbody.....	291
Under Hood.....	291
Cleaning the Instrument Panel and Instrument Cluster Lens.....	293
Cleaning the Interior.....	292
Mirrors.....	293
Cleaning the Wheels.....	294
Cleaning the Windows and Wiper Blades.....	292
Clearing All MyKeys.....	61
Climate Control.....	121
Auto Mode.....	123
Climate Control – Troubleshooting.....	124
Climate Control – Troubleshooting.....	124
Climate Control – Frequently Asked Questions.....	124
Closing the Liftgate.....	70
Closing the Liftgate From Outside Your Vehicle.....	70
Connected Vehicle.....	337
Connecting the Vehicle to a Mobile Network - Vehicles With: Modem.....	337
Connected Vehicle Limitations.....	337
Connected Vehicle Requirements.....	337
Connected Vehicle – Troubleshooting - Vehicles With: Modem.....	338
Connected Vehicle – Troubleshooting - Vehicles With: SYNC 3.....	339
Connecting the Vehicle to a Mobile Network - Vehicles With: Modem.....	337
Connecting FordPass to the Modem.....	337
Enabling and Disabling the Modem.....	337
What Is the Modem.....	337
Connecting the Vehicle to a Wi-Fi Network - Vehicles With: SYNC 3.....	337
Coolant Check	
See: Engine Coolant Check.....	277

# Index

Cooling System Capacity and Specification - 1.5L EcoBoost™.....	332
Cooling System Capacity and Specification - 2.0L EcoBoost™.....	331
Cornering Lamps.....	83
Crash Sensors and Airbag Indicator.....	49
Creating a MyKey.....	60
Programming and Changing Configurable Settings.....	61
Creating a Vehicle Wi-Fi Hotspot.....	341
Connecting a Device to the Wi-Fi Hotspot.....	341
Finding the Wi-Fi Hotspot Name and Password.....	341
Cross Traffic Alert.....	213
Cross Traffic Alert Behavior When Trailer is Attached.....	215
Cross Traffic Alert Indicator.....	215
Cross Traffic Alert Information Messages.....	216
Cross Traffic Alert System Limitations.....	215
Cross Traffic Alert System Sensors.....	215
Switching the System On and Off.....	215
Using Cross Traffic Alert.....	213
Cruise Control.....	75
Cruise Control Indicators.....	194
Cruise Control - Vehicles With: Lane Centering.....	75
Cup Holders.....	146
Cup Holder Precautions.....	146
Customer Assistance.....	255
<b>D</b>	
Data Recording.....	11
Comfort, Convenience and Entertainment Data.....	13
Event Data.....	13
Service Data.....	12
Services That Third Parties Provide.....	14
Services That We Provide.....	14
Vehicles With a Modem.....	14
Vehicles With an Emergency Call System.....	15
Vehicles With SYNC.....	14
Daytime Running Lamps - Vehicles With: Configurable Daytime Running Lamps.....	82
Daytime Running Lamps - Vehicles With: Daytime Running Lamps (DRL).....	82
Declaration of Conformity.....	433
Radio Frequency Statement.....	433
Digital Radio.....	344
HD Radio Reception and Station Troubleshooting.....	345
Directing the Flow of Air.....	123
Directing Air to the Footwell Air Vents.....	123
Directing Air to the Instrument Panel Air Vents.....	123
Directing Air to the Windshield Air Vents.....	123
Direction Indicators.....	84
Direction Indicator.....	84
Switching the Direction Indicators On and Off.....	84
Doors and Locks.....	64
Drive Mode Control.....	223
Drive Modes.....	224
Drive Modes.....	224
Eco.....	224
Mud/Ruts.....	224
Normal.....	224
Rock Crawl.....	225
Sand.....	225
Slippery.....	225
Sport.....	226
Driver Alert.....	206
Using Driver Alert.....	206
Driver and Passenger Airbags.....	43
Children and Airbags.....	44
Proper Driver and Front Passenger Seating Adjustment.....	43
Driver Knee Airbag.....	47
Driving Aids.....	206
Driving Economically.....	248
Driving Hints.....	241
Off-Road Driving.....	241

# Index

DRL	
See: Daytime Running Lamps - Vehicles With: Configurable Daytime Running Lamps.....	82
See: Daytime Running Lamps - Vehicles With: Daytime Running Lamps (DRL).....	82
<b>E</b>	
Electric Parking Brake.....	177
Applying the Electric Parking Brake.....	177
Automatically Releasing the Electric Parking Brake.....	178
Manually Releasing the Electric Parking Brake.....	177
Releasing the Electric Parking Brake if the Vehicle Battery is Running Out of Charge.....	178
Electromagnetic Compatibility.....	405
Emergency Call Limitations.....	52
Emergency Call Requirements.....	51
Emission Law.....	162
Noise Emissions Warranty, Prohibited Tampering Acts and Maintenance.....	163
Tampering With a Noise Control System.....	162
Enabling Remote Start.....	118
End User License Agreement.....	408
VEHICLE SOFTWARE END USER LICENSE AGREEMENT (EULA) .....	408
Engine Block Heater.....	151
Using the Engine Block Heater.....	152
Engine Coolant Check.....	277
Adding Coolant.....	277
Coolant Change.....	279
Engine Coolant Temperature Management.....	280
Fail-Safe Cooling.....	279
Recycled Coolant.....	278
Severe Climates.....	279
Engine Emission Control.....	162
Engine Immobilizer	
See: Passive Anti-Theft System.....	72
Engine Oil Capacity and Specification - 1.5L EcoBoost™.....	329
Alternative Engine Oil for Extremely Cold Climates.....	330
Engine Oil Capacity and Specification - 2.0L EcoBoost™.....	328
Alternative Engine Oil for Extremely Cold Climates.....	329
Engine Oil Check.....	274
Adding Engine Oil.....	274
Engine Oil Dipstick.....	274
Engine Specifications - 1.5L	
EcoBoost™.....	323
Drivebelt Routing.....	323
Engine Specifications - 2.0L	
EcoBoost™.....	323
Drivebelt Routing.....	324
Entertainment.....	359
AM/FM Radio.....	360
Apps.....	368
Bluetooth Stereo or USB.....	367
CD.....	366
HD Radio™ Information (If Available).....	363
SiriusXM® Satellite Radio (If Activated).....	361
Sources.....	359
Supported Media Players, Formats and Metadata Information.....	368
USB Ports.....	368
Environment.....	19
EPB	
See: Electric Parking Brake.....	177
Essential Towing Checks.....	237
Before Towing a Trailer.....	239
Hitches.....	238
Launching or Retrieving a Boat or Personal Watercraft (PWC).....	239
Safety Chains.....	238
Trailer Brakes.....	238
Trailer Lamps.....	239
Trailer Towing Connector.....	238
When Towing a Trailer.....	239
Event Data Recording	
See: Data Recording.....	11
Export Unique Options.....	18
Extending the Remote Start	
Duration.....	118
Exterior Mirrors.....	89
Blind Spot Monitor.....	90
Fold-Away Exterior Mirrors.....	90
Power Exterior Mirrors.....	89

# Index

Signal Indicator Mirrors.....	90
<b>F</b>	
Fastening the Seatbelts.....	35
How to Extract Seatbelts in the Rear	
Outermost Positions.....	37
Seatbelt Locking Modes.....	36
Using Seatbelts During Pregnancy.....	35
Flat Tire	
See: Changing a Road Wheel.....	316
Floor Mats.....	248
Fog Lamps - Front	
See: Front Fog Lamps.....	82
Ford Credit.....	15
US Only.....	15
Ford Protect.....	394
Ford Protect Extended Service Plan	
(CANADA ONLY).....	395
Ford Protect Extended Service Plans (U.S.	
Only).....	394
Four-Wheel Drive.....	172
Principle of Operation.....	172
Front Fog Lamps.....	82
Front Fog Lamp Indicator.....	83
Switching the Front Fog Lamps On or	
Off.....	82
Front Passenger Sensing System.....	44
Front Wiper Blades	
See: Changing the Front Wiper Blades.....	286
Fuel and Refueling.....	155
Fuel Consumption.....	160
Advertised Capacity.....	160
Calculating Fuel Economy.....	160
Fuel Filler Funnel Location.....	156
Fuel Filter.....	285
Fuel Quality.....	155
Choosing the Right Fuel.....	155
Fuel Shutoff.....	251
Fuel Tank Capacity.....	332
Fuse Box Locations.....	262
Engine Compartment Fuse Box.....	262
Passenger Compartment Fuse Box.....	262
Fuses.....	262
Fuse Specification Chart.....	262
Engine Compartment Fuse Box.....	262
Passenger Compartment Fuse Box.....	267

## G

Gauges - Vehicles With: 4.2 Inch	
Instrument Cluster Display	
Screen.....	92
4 Inch Display.....	92
Engine Coolant Temperature Gauge.....	92
Fuel Gauge.....	93
Gauges - Vehicles With: 6.5 Inch	
Instrument Cluster Display	
Screen.....	93
Distance to Empty.....	94
Engine Coolant Temperature Gauge.....	94
Fuel Gauge.....	94
Information Bar.....	94
Information Display.....	94
Low Fuel Reminder.....	94
Gearbox	
See: Transmission.....	166
General Information on Radio	
Frequencies.....	53
Intelligent Access.....	53
General Maintenance Information.....	396
Multi-Point Inspection.....	398
Owner Checks and Services.....	397
Protecting Your Investment.....	396
Why Maintain Your Vehicle?.....	396
Why Maintain Your Vehicle at Your	
Dealership?.....	396
Getting Assistance Outside the U.S. and	
Canada.....	258
Getting the Services You Need.....	255
Away From Home.....	255
Glasses Holder.....	146
Locating the Glasses Holder.....	146
Global Opening and Closing.....	89
Closing the Windows.....	89
Opening the Windows.....	89

## H

Hazard Flashers.....	251
Headlamp Adjusting	
See: Adjusting the Headlamps.....	284
Headlamp Exit Delay.....	81
Headrest	
See: Head Restraints.....	133

# Index

Head Restraints.....	133	Doors and Locks.....	107
Folding the Head Restraint.....	135	Driver Alert.....	108
Front Seat Head Restraints.....	134	Four-Wheel Drive.....	108
Installing the Head Restraint.....	135	Fuel.....	109
Lowering the Head Restraint.....	134	Hill Start Assist.....	109
Raising the Head Restraint.....	134	Keys and Intelligent Access.....	109
Removing the Head Restraint.....	135	Lane Keeping System.....	110
Removing the Head Restraints.....	134	Maintenance.....	111
Tilting the Front Seat Head Restraint.....	135	MyKey.....	112
Heated Seats.....	139	Park Aid.....	113
Heating		Park Brake.....	113
See: Climate Control - Vehicles With: Dual Automatic Temperature Control (DATC).....	121	Power Steering.....	114
See: Climate Control - Vehicles With: Electronic Automatic Temperature Control (EATC).....	125	Pre-Collision Assist.....	114
See: Climate Control - Vehicles With: Manual Temperature Control.....	129	Remote Start.....	114
Hill Start Assist.....	178	Seats.....	115
Switching the System On and Off.....	179	Starting System.....	115
Using Hill Start Assist.....	179	Tire Pressure Monitoring System.....	115
Hints on Driving With Anti-Lock Brakes.....	176	Trailer.....	116
Hood Lock		Transmission.....	116
See: Opening and Closing the Hood.....	271	Installing Child Restraints.....	23
Horn.....	75	Child Restraints.....	23
How Does Adaptive Cruise Control With Stop and Go Work.....	195	Using Lap and Shoulder Belts.....	23
How Does the Rear Occupant Alert System Work.....	140	Using Lower Anchors and Tethers for Children (LATCH).....	25
<b>I</b>			
Identifying the Climate Control Unit.....	121	Using Tether Straps.....	27
Ignition Switch.....	148	Instrument Cluster.....	92
In California (U.S. Only).....	256	Instrument Lighting Dimmer.....	81
Information Display Control.....	75	Instrument Panel.....	20
Information Displays.....	99	Interior Air Quality.....	132
General Information.....	99	Interior Lamps.....	84
Information Messages.....	104	Interior Lamp Function.....	84
Adaptive Cruise Control.....	104	Switching All of the Interior Lamps Off.....	84
AdvanceTrac™ and Traction Control.....	105	Switching All of the Interior Lamps On.....	84
Alarm.....	105	Switching the Front Interior Lamps On and Off.....	84
Auto-Start-Stop.....	105	Switching the Rear Interior Lamps On and Off.....	85
Battery and Charging System.....	106	Interior Mirror.....	90
Blind Spot Information and Cross Traffic Alert System.....	107	Automatic Dimming Mirror.....	90
		Manual Dimming Mirror.....	90
		Introduction.....	9
		<b>J</b>	
		Jump Starting the Vehicle.....	252
		To Connect the Booster Cables.....	252

# Index

To Start the Engine.....	253	Smart Unlocks for Integrated Keyhead Transmitter.....	65
<b>K</b>		Smart Unlocks for Passive keys.....	66
Keyless Entry.....	67	Luggage Compartment.....	233
SECURICODE™ KEYLESS ENTRY		Lug Nuts	
KEYPAD.....	67	See: Changing a Road Wheel.....	316
Keyless Starting.....	148	<b>M</b>	
Ignition Modes.....	149	Maintenance.....	271
Keys and Remote Controls.....	53	General Information.....	271
<b>L</b>		Manual Seats.....	136
Lane Keeping System.....	207	Adjusting the Seat Backrest.....	136
Switching the System On and Off.....	208	Adjusting the Seat Height.....	136
Liftgate.....	70	Moving the Seat Backward and Forward.....	136
Closing the Liftgate.....	70	Map Pocket.....	146
Opening the Liftgate.....	70	Locating the Map Pocket.....	146
Lighting Control.....	80	Message Center	
Flashing High Beam Headlamps.....	81	See: Information Displays.....	99
Lighting Control Selections.....	80	Mirrors	
Switching High Beam Headlamps On and Off.....	80	See: Windows and Mirrors.....	88
Lighting.....	80	Mobile Communications Equipment.....	17
General Information.....	80	Moonroof.....	91
Load Carriers		Bounce-Back.....	91
See: Roof Racks and Load Carriers.....	227	Opening and Closing the Moonroof.....	91
Load Carrying.....	227	Motorcraft Parts - 1.5L	
Load Limit.....	227	EcoBoost™.....	325
Special Loading Instructions for Owners of Pick-up Trucks and Utility-type Vehicles.....	231	Motorcraft Parts - 2.0L	
Vehicle Loading - with and without a Trailer.....	227	EcoBoost™.....	325
Locating the Cabin Air Filter.....	132	MyKey – Troubleshooting.....	62
Locating the Power Outlet.....	142	MyKey™.....	59
Locating the Wireless Accessory Charger.....	144	Principle of Operation.....	59
Locking and Unlocking.....	64	<b>N</b>	
Activating Intelligent Access.....	65	Navigation.....	370
Autolock.....	66	Changing the Format of the Map.....	372
Battery Saver.....	67	cityseeker.....	374
Illuminated Entry.....	66	Michelin Travel Guide.....	375
Illuminated Exit.....	66	Navigation Map Accuracy and Updates.....	376
Opening a Rear Door from the Inside.....	64	Route Guidance.....	373
Power Door Locks.....	64	Setting a Destination.....	371
Remote Control.....	64	SiriusXM Traffic and Travel Link.....	375
		Zoom.....	372
		Normal Scheduled Maintenance.....	399
		Intelligent Oil-Life Monitor™.....	399

# Index

Normal Maintenance Intervals.....	400	Personal Safety System™.....	41
<b>O</b>		How Does the Personal Safety System Work?.....	41
Off-Road Driving.....	241	Phone.....	369
After Driving Your Vehicle Off-Road.....	247	Android Auto.....	370
Basic Off-Road Driving Techniques.....	241	Apple CarPlay.....	370
Driving Off-Road.....	242	Pairing Your Cell Phone for the First Time.....	369
Driving Through Water Limitations.....	246	Text Messaging.....	370
Off-Road Driving Aids.....	246	Using Your Cell Phone.....	369
Off-Road Driving Precautions.....	241	Post-Crash Alert System.....	253
What Is Off-Road Driving.....	241	Power Door Locks See: Locking and Unlocking.....	64
Oil Change Indicator Reset.....	275	Power Outlet Indicators.....	143
Oil Check See: Engine Oil Check.....	274	Power Outlet.....	142
Opening and Closing the Hood.....	271	Power Outlet Precautions - 1.5L EcoBoost™.....	143
Closing the Hood.....	272	Power Outlet Precautions - 2.0L EcoBoost™.....	143
Opening the Hood.....	271	Power Outlet Precautions.....	142
Opening and Closing the Liftgate Window.....	71	Power Seats.....	137
Opening the Liftgate.....	70	Adjusting the Lumbar Support.....	137
Opening the Liftgate From Outside Your Vehicle.....	70	Adjusting the Seat Backrest.....	137
Opening the Liftgate Using the Remote Control.....	70	Adjusting the Seat Height.....	137
Ordering Additional Owner's Literature.....	260	Moving the Seat Backward and Forward.....	137
Obtaining a French Owner's Manual.....	260	Power Steering Fluid Check.....	282
Overriding Automatic High Beam Control.....	87	Power Windows.....	88
Overriding the Set Speed.....	201	Accessory Delay.....	89
<b>P</b>		Bounce-Back.....	88
Parking Aids.....	186	One-Touch Down.....	88
Principle of Operation.....	186	One-Touch Up.....	88
Passive Anti-Theft System.....	72	Rear Window Lock.....	88
Programming a Spare Intelligent Access Key.....	72	Pre-Collision Assist.....	218
SecuriLock®.....	72	Adjusting the Pre-Collision Assist Settings.....	221
PATS See: Passive Anti-Theft System.....	72	Blocked Sensors.....	221
Perchlorate.....	15	Distance Indication and Alert.....	220
Personalized Settings.....	103	Evasive Steering Assist.....	220
Fuel Economy.....	103	Using the Pre-Collision Assist System.....	219
Trip 1 and 2.....	104	Protecting the Environment.....	19
		Puncture See: Changing a Road Wheel.....	316
		<b>R</b>	
		Rear Floodlamps.....	85



# Index

Rear Occupant Alert System Audible Warnings.....	141
Rear Occupant Alert System Indicators.....	141
Rear Occupant Alert System Limitations.....	140
Rear Occupant Alert System Precautions.....	140
Rear Occupant Alert System.....	140
Rear Parking Aid.....	187
Object Distance Indicator.....	188
Rear Seats.....	138
Folding the Seat Backrest.....	138
Unfolding the Seat Backrest.....	139
Rear View Camera.....	188
Using the Rear View Camera System.....	189
Rear View Camera See: Rear View Camera.....	188
Rear Window Wiper and Washers.....	79
Rear Camera Washer.....	79
Rear Window Washer.....	79
Rear Window Wiper.....	79
Rear Wiper Blades See: Changing the Rear Wiper Blades.....	286
Recommended Towing Weights.....	236
Refueling.....	158
Refueling System Overview.....	158
Refueling System Warning.....	159
Refueling Your Vehicle.....	158
Remote Control.....	53
Car Finder.....	57
Integrated Keyhead Transmitter.....	53
Passive Key.....	54
Replacing the Battery.....	55
Sounding a Panic Alarm.....	57
Remotely Starting and Stopping the Vehicle.....	118
Remotely Starting the Vehicle.....	118
Remotely Stopping the Vehicle.....	118
Remote Start Limitations.....	118
Remote Start Precautions.....	118
Remote Start Remote Control Indicators.....	119
Remote Control Feedback.....	119
Remote Start.....	118
Remote Start Settings.....	119
Remote Start Settings.....	119
Setting the Remote Start Duration.....	120
Switching Climate Control Auto Mode On and Off.....	119
Switching Climate Control Last Settings On and Off.....	119
Switching the Heated Seat Settings On and Off.....	119
Switching the Heated Steering Wheel Settings On and Off.....	119
Repairing Minor Paint Damage.....	294
Replacement Parts Recommendation.....	16
Collision Repairs.....	16
Scheduled Maintenance and Mechanical Repairs.....	16
Warranty on Replacement Parts.....	16
Replacing a Lost Key or Remote Control.....	58
Replacing the Cabin Air Filter.....	132
Reporting Safety Defects (Canada Only).....	260
Reporting Safety Defects (U.S. Only).....	260
Resuming the Set Speed.....	194
Resuming the Set Speed from a Complete Stop.....	201
Roadside Assistance.....	250
Vehicles Sold in Canada: Getting Roadside Assistance.....	251
Vehicles Sold in the United States: Getting Roadside Assistance.....	250
Vehicles Sold in the United States: Using Roadside Assistance.....	250
Roadside Emergencies.....	250
Roof Racks and Load Carriers.....	227
Maximum Roof Load Amounts.....	227
Running-In See: Breaking-In.....	248
Running Out of Fuel.....	156
Adding Fuel From a Portable Fuel Container.....	157
Filling a Portable Fuel Container.....	156

## S

Safety Canopy™.....	48
Safety Precautions.....	155

# Index

Satellite Radio.....	346	Setting the Adaptive Cruise Control Speed.....	199
Satellite Radio Electronic Serial Number (ESN).....	347	Manually Changing the Set Speed.....	199
Satellite Radio Reception Factors.....	347	Setting the Adaptive Cruise Speed from a Complete Stop.....	199
SiriusXM Satellite Radio Service.....	347	Setting the Blower Motor Speed.....	122
Troubleshooting.....	348	Setting the Cruise Control Speed.....	193
Scheduled Maintenance.....	396	Changing the Set Speed.....	193
Seatbelt Extensions.....	40	Setting the Temperature.....	122
Seatbelt Height Adjustment.....	37	Setting the Trail Control Speed.....	184
Seatbelt Reminder.....	38	Side Airbags.....	46
Seatbelt Status.....	39	Sitting in the Correct Position.....	133
Seatbelts.....	34	Snow Chains	
Principle of Operation.....	34	See: Using Snow Chains.....	312
Seatbelt Warning Lamp and Indicator		Spare Wheel	
Chime.....	38	See: Changing a Road Wheel.....	316
Conditions of operation.....	38	Special Notices.....	16
Seats.....	133	New Vehicle Limited Warranty.....	16
Security.....	72	Notice to Owners of Pickup Trucks and Utility Type Vehicles.....	17
Selecting a Drive Mode - 1.5L		On Board Diagnostics Data Link Connector.....	17
EcoBoost™.....	223	Special Instructions.....	16
Selecting a Drive Mode - 2.0L		Using Your Vehicle as an Ambulance.....	17
EcoBoost™.....	224	Using Your Vehicle With a Snowplow.....	17
Settings.....	378	Special Operating Conditions Scheduled Maintenance.....	402
911 Assist.....	379	Exceptions.....	403
Ambient Lighting.....	379	Speed Control	
Audio.....	378	See: Cruise Control.....	193
Automatic Updates.....	379	Speed Sign Recognition.....	216
Bluetooth.....	378	Principle of Operation.....	216
Charge Settings.....	379	Using Speed Sign Recognition.....	217
Clock.....	378	Stability Control.....	182
Display.....	379	Principle of Operation.....	182
Driver Assist.....	379	Starter Switch	
FordPass.....	379	See: Ignition Switch.....	148
General.....	379	Starting a Gasoline Engine.....	149
Message Center.....	379	Automatic Engine Shutdown.....	150
Mobile Apps.....	379	Failure to Start.....	150
Multi Contour Seats.....	379	Guarding Against Exhaust Fumes.....	151
Navigation.....	379	Important Ventilating Information.....	151
Personal Profiles.....	379	Stopping the Engine When Your Vehicle is Moving.....	151
Phone.....	378	Stopping the Engine When Your Vehicle is Stationary.....	151
Seats.....	379	Vehicles with an Ignition Key.....	149
Sound.....	378	Vehicles with Keyless Start.....	149
Valet Mode.....	379		
Vehicle.....	379		
Voice Control.....	379		
Setting the Adaptive Cruise Control			
Gap.....	200		
Following a Vehicle.....	200		

# Index

Starting and Stopping the Engine.....	148
General Information.....	148
Steering.....	218
Electric Power Steering.....	218
Steering Wheel.....	74
Storage.....	146
Cup Holders.....	146
Glasses Holder.....	146
Map Pocket.....	146
Under Seat Storage.....	146
Sunroof	
See: Moonroof.....	91
Sun Visors.....	90
Illuminated Vanity Mirror.....	91
Supplementary Restraints System.....	42
Principle of Operation.....	42
Switching Adaptive Cruise Control On and Off.....	198
Automatic Cancellation or Deactivation.....	199
Switching Adaptive Cruise Control Off.....	199
Switching Adaptive Cruise Control On.....	199
Switching Air Conditioning On and Off.....	121
Switching Automatic High Beam Control On and Off.....	86
Activating the Automatic High Beam Control.....	86
Switching Climate Control On and Off.....	121
Switching Cruise Control On and Off.....	193
Switching Cruise Control Off.....	193
Switching Cruise Control On.....	193
Switching From Adaptive Cruise Control to Cruise Control.....	202
Switching Intelligent Mode On and Off.....	203
Changing the Set Speed with Intelligent Adaptive Cruise Control.....	204
Switching Lane Centering On and Off.....	202
Activating Lane Centering.....	203
System Alerts and Automatic Cancellation.....	203
Switching Maximum Cooling On and Off.....	121
Switching Maximum Defrost On and Off.....	121
Switching Rear Occupant Alert System On and Off.....	140
Semiannual Reminder.....	140
Switching Recirculated Air On and Off.....	121
Switching the Heated Mirrors On and Off.....	122
Switching the Heated Rear Window On and Off.....	122
Switching the Heated Steering Wheel On and Off.....	76
Switching the Heated Wiper Park On and Off.....	122
Switching Trail Control On and Off.....	184
Symbols Glossary.....	9
SYNC™ 3.....	350
General Information.....	350
SYNC™ 3 Troubleshooting.....	380
Additional Information and Assistance.....	392
Apps.....	387
Navigation.....	386
Personal Profiles.....	390
Phone.....	384
Resetting the System.....	392
USB and Bluetooth Audio.....	381
Voice Recognition.....	380
Wi-Fi Connectivity.....	389
<b>T</b>	
Technical Specifications	
See: Capacities and Specifications.....	323
The Better Business Bureau (BBB) Auto Line Program (U.S. Only).....	257
Tire Care.....	299
Glossary of Tire Terminology.....	300
Information About Uniform Tire Quality Grading.....	299
Information Contained on the Tire	
Sidewall.....	301
Temperature A B C.....	300
Traction AA A B C.....	299
Treadwear.....	299

# Index

Tire Pressure Monitoring System.....	312
Changing Tires With a Tire Pressure Monitoring System.....	314
Understanding Your Tire Pressure Monitoring System .....	314
Tires	
See: Wheels and Tires.....	297
Towing a Trailer.....	235
Load Placement.....	235
Towing Points.....	254
Towing the Vehicle on Four	
Wheels.....	240
Emergency Towing.....	240
Recreational Towing - All-Wheel and Four-Wheel Drive Vehicles.....	240
Recreational Towing - Front-Wheel Drive Vehicles.....	240
Recreational Towing - Rear-Wheel Drive Vehicles.....	240
Towing.....	235
Traction Control.....	181
Principle of Operation.....	181
Trail Control Indicators.....	185
Trail Control.....	184
Trail Control – Troubleshooting.....	185
Trail Control – Troubleshooting.....	185
Trail Control – Information Messages.....	185
Trailer Sway Control.....	236
Transmission.....	166
Transporting the Vehicle.....	253
Type Approvals.....	434
Radio Frequency Certifications for Blind Spot Information System.....	434
Radio Frequency Certifications for Body Control Module.....	435
Radio Frequency Certifications for Cruise Control Module.....	436
Radio Frequency Certifications for Integrated Keyhead Transmitter.....	436
Radio Frequency Certifications for Passive Anti-Theft System.....	437
Radio Frequency Certifications for Passive Key.....	437
Radio Frequency Certifications for Radio Transceiver Module.....	445
Radio Frequency Certifications for SYNC3.2.....	441
Radio Frequency Certifications for Telematics Control Unit.....	447
Radio Frequency Certifications for Tire Pressure Monitoring Sensor(s).....	448
Radio Frequency Certifications for Wireless Accessory Charging Module.....	451
<b>U</b>	
Under Hood Overview - 1.5L EcoBoost™.....	272
Under Hood Overview - 2.0L EcoBoost™.....	273
Under Seat Storage.....	146
Locating the Under Seat Storage Compartment.....	146
Unique Driving Characteristics.....	153
USB Port.....	349
Locating the USB Ports.....	349
Using Four-Wheel Drive.....	172
Driving in Special Conditions With Four-Wheel Drive.....	173
Four-Wheel Drive Lock.....	174
Maintenance and Modifications.....	175
Rear Differential Lock.....	174
Using MyKey With Remote Start Systems.....	62
Using Snow Chains.....	312
Using Stability Control.....	183
Using Traction Control.....	181
Switching the System Off.....	181
System Indicator Lights and Messages.....	181
Using a Switch.....	181
Using the Information Display Controls.....	181
Using Voice Recognition.....	352
Audio Voice Commands.....	353
Climate Voice Commands.....	354
Mobile App Voice Commands.....	357
Navigation Voice Commands.....	356
Phone Voice Commands.....	354
SiriusXM Traffic and Travel Link Voice Commands.....	358
Voice Settings Commands.....	358
Utilizing the Mediation/Arbitration Program (Canada Only).....	258

# Index

<b>V</b>	
Vehicle Care.....	289
General Information.....	289
Vehicle Dimensions.....	324
Vehicle Identification Number.....	336
Locating the Vehicle Identification Number.....	336
Vehicle Identification Number Overview.....	336
Vehicle Identification.....	336
Vehicle Identification Number.....	336
Vehicle Storage.....	294
Body.....	294
Brakes.....	295
Cooling system.....	295
Disconnecting Your 12 Volt Battery.....	295
Engine.....	295
Fuel system.....	295
General.....	294
Miscellaneous.....	295
Removing Vehicle From Storage.....	295
Tires.....	295
Vehicle Wi-Fi Hotspot.....	341
Ventilation	
See: Climate Control - Vehicles With: Dual Automatic Temperature Control (DATC).....	121
See: Climate Control - Vehicles With: Electronic Automatic Temperature Control (EATC).....	125
See: Climate Control - Vehicles With: Manual Temperature Control.....	129
Voice Control.....	75
<b>W</b>	
Warning Lamps and Indicators.....	95
4WD Lock.....	98
Adaptive Cruise Control.....	95
Anti-Lock Braking System.....	95
Auto Hold Active.....	95
Auto Hold Unavailable.....	95
Automatic High Beam Control.....	95
Auto-Start-Stop.....	95
Battery.....	95
Blind Spot Monitor.....	95
Brake System Warning Lamp.....	96
Cruise Control.....	96
Direction Indicator.....	96
Door Ajar.....	96
Electric Park Brake.....	96
Engine Coolant Temperature Warning Lamp.....	96
Engine Oil.....	96
Fasten Rear Seatbelt.....	97
Fasten Seatbelt.....	96
Front Airbag.....	97
Front Fog Lamps.....	97
High Beam.....	97
Hood Ajar.....	97
Lamps On.....	97
Liftgate Ajar.....	97
Low Beam Warning.....	97
Low Fuel Level.....	97
Low Tire Pressure Warning.....	97
Low Washer Fluid.....	97
Malfunction Indicator Lamp.....	97
Powertrain Fault.....	98
Rear Differential Lock.....	98
Stability Control.....	98
Stability Control Off.....	98
Trail Control.....	98
Washer Fluid Check.....	285
Washer Fluid Specification.....	334
Washers	
See: Cleaning the Exterior.....	290
See: Wipers and Washers.....	77
Waxing.....	291
What Is 911 Assist.....	51
What Is a Connected Vehicle.....	337
What Is Adaptive Cruise Control With Lane Centering.....	195
What Is Automatic High Beam Control.....	86
What Is Cruise Control.....	193
Requirements.....	193
What Is Drive Mode Control.....	223
What Is Intelligent Adaptive Cruise Control.....	195
What Is Remote Start.....	118
What Is the Cabin Air Filter.....	132
What Is the Power Outlet.....	142
What is the Rear Occupant Alert System.....	140

# Index

---

What Is the Wireless Accessory Charger.....	144
What Is Trail Control.....	184
Wheel Nuts	
See: Changing a Road Wheel.....	316
Wheels and Tires.....	297
General Information.....	297
Technical Specifications.....	322
Windows and Mirrors.....	88
Windshield Washers.....	78
Front Camera Washer.....	79
Windshield Wipers.....	77
Intermittent Wipe.....	77
Speed Dependent Wipers.....	77
Wiper Blades	
See: Checking the Wiper Blades.....	286
Wipers and Washers.....	77
Wireless Accessory Charger	
Precautions.....	144
Wireless Accessory Charger.....	144

