

---

# OWNER'S MANUAL

Operation  
Maintenance  
Specifications

All information in this Owner's Manual is current at the time of publication. However, Genesis reserves the right to make changes at any time so that our policy of continual product improvement may be carried out.

This manual applies to all Genesis Branded Vehicle models and includes descriptions and explanations of optional as well as standard equipment.

As a result, you may find material in this manual that does not apply to your specific vehicle.

## **CAUTION: MODIFICATIONS TO YOUR GENESIS BRANDED VEHICLE**

Your Genesis Branded Vehicle should not be modified in any way. Such modifications may adversely affect the performance, safety or durability of your Genesis Branded Vehicle and may, in addition, violate conditions of the limited warranties covering the vehicle. Certain modifications may also be in violation of regulations established by the U.S. Department of Transportation and other federal or state agencies.

## **TWO-WAY RADIO INSTALLATION**

Your vehicle is equipped with a Tire Pressure Monitoring System, Passenger Occupant Classification System and other CAN bus systems. It is possible for an improperly installed/adjusted high powered two-way radio to adversely affect electronic systems. For this reason, we recommend that you carefully follow the radio manufacturer's instructions if you choose to install one of these devices.

---

## **SAFETY AND VEHICLE DAMAGE WARNING**

This manual includes information titled as DANGER, WARNING, CAUTION and NOTICE. These titles indicate the following:

### **DANGER**

DANGER indicates a hazardous situation which, if not avoided, will result in death or serious injury.

---

### **WARNING**

WARNING indicates a hazardous situation which, if not avoided, could result in death or serious injury.

---

### **CAUTION**

CAUTION indicates a hazardous situation which, if not avoided, could result in minor or moderate injury.

---

### **NOTICE**

NOTICE indicates a situation which, if not avoided, could result in vehicle damage.

---

## **GENESIS BRANDED VEHICLE OWNER PRIVACY POLICY**

Your Genesis Branded Vehicle may be equipped with technologies and service that use information collected, generated, recorded or stored by the vehicle. Genesis Branded Vehicle has created a Vehicle Owner Privacy Policy to explain how these technologies and services collect use and share this information.

You may read our Vehicle Owner Privacy Policy at  
“<http://www.genesis.com/us/en/my-privacy-rights.html#owner>”

If you would like to receive a hard copy of our Vehicle Owner Privacy Policy, please contact our Genesis Customer Care at:

Genesis Customer Care  
PO BOX 20650  
Fountain Valley, CA 92728  
844-340-9741

Genesis Customer Care Center representatives are available Monday through Friday between the hours of 5:00 AM and 5:00 PM PST and Saturday between 6:30 AM and 3:00 PM PST (English)

For Genesis Customer Care assistance in Spanish or Korean, representatives are available Monday through Friday between 6:30 AM and 3:00 PM PST.

## Table of contents

Foreword	1
Vehicle Information, Consumer Information and Reporting Safety Defects	2
Safety System	3
Instrument Cluster	4
Convenience Features	5
Driving Your Vehicle	6
Driver Assistance System	7
Emergency Situations	8
Maintenance	9
Index	I



# 1. Foreword

Introduction .....	1-2
Genesis customer care.....	1-2
Guide to Genesis Parts .....	1-3
How to Use This Manual .....	1-6
Safety messages.....	1-7
Fuel requirements .....	1-8
Vehicle modifications.....	1-10
Vehicle break-in process.....	1-10
Vehicle Data Collection And Event Data Recorders .....	1-11

## INTRODUCTION

Congratulations, and thank you for choosing this Genesis Branded Vehicle. We are pleased to welcome you to the growing number of discerning people who drive the Genesis Branded Vehicle. We are very proud of the advanced engineering and high-quality construction of each Genesis Branded Vehicle we build.

Your Owner's Manual will introduce you to the features and operation of your new Genesis Branded Vehicle. To become familiar with your new Genesis Branded Vehicle, so that you can fully enjoy it, read this Owner's Manual carefully before driving your new vehicle.

This manual contains important safety information and instructions intended to familiarize you with your vehicle's controls and safety features so you can safely operate your vehicle.

This manual also contains information on maintenance designed to enhance safe operation of the vehicle. It is recommended that all service and maintenance on your car be performed by an authorized retailer of Genesis Branded products. Retailers of Genesis Branded products are prepared to provide high-quality service, maintenance and any other assistance that may be required.

This Owner's Manual should be considered a permanent part of your vehicle, and should be kept in the vehicle so you can refer to it at any time. The manual should stay with the vehicle if you sell it to provide the next owner with important operating, safety and maintenance information.

## GENESIS CUSTOMER CARE

### CAUTION

Severe engine and transmission damage may result from the use of poor quality fuels and lubricants that do not meet Genesis Branded Vehicle specifications. You must always use high quality fuels and lubricants that meet the specifications listed on Page 2-12 in the Vehicle Specifications section of the Owner's Manual.

---

Copyright 2024 Genesis Customer Care. All rights reserved. No part of this publication may be reproduced, stored in any retrieval system or transmitted in any form or by any means without the prior written permission of Genesis Customer Care.



## GUIDE TO GENESIS PARTS

### 1. What are Genesis Parts?

Genesis Parts are the same parts used by HYUNDAI Motor Company to manufacture vehicles. They are designed and tested for the optimum safety, performance, and reliability to our customers.

Type A



Type B



## 2. Why should you use Genesis Parts?

Genesis Parts are engineered and built to meet rigid manufacturing requirements. Damage caused by using imitation, counterfeit or used salvage parts is not covered under the Genesis Branded New Vehicle Limited Warranty or any other Genesis Branded Vehicle warranty.

In addition, any damage to or failure of Genesis Part caused by the installation or failure of an imitation, counterfeit or used salvage part is not covered by any Genesis Branded Vehicle Warranty.

Type A



Type B



### 3. How can you tell if you are purchasing Genesis Parts?

Look for the Genesis Parts Logo on the package.

Genesis Parts exported to the U.S. are packaged with labels written only in English.

Genesis Parts are only sold through an authorized retailer of Genesis Branded products.

Type A



Type B



## HOW TO USE THIS MANUAL

We want to help you get the greatest possible driving pleasure from your vehicle. Your Owner's Manual can assist you in many ways. To gain an overview of the contents of your Owner's Manual, use the Table of Contents in the front of the manual. The first page of each Chapter includes a detailed Table of Contents of the topics in that Chapter.

To quickly locate information about your vehicle, use the Index in the back of the manual. It is an alphabetical list of what is in this manual and the page number where it can be found.

For your convenience, we have incorporated tabs on the right-hand page edges. These tabs are coded with the Chapter titles to assist you with navigating through the manual.

## SAFETY MESSAGES

Your safety, and the safety of others, are very important. This Owner's Manual provides you with many safety precautions and operating procedures. This information alerts you to potential hazards that may hurt you or others, and may damage your vehicle.

Safety messages found on vehicle labels and in this manual describe these hazards and what to do to avoid or reduce the risks.

Warnings and instructions contained in this manual are for your safety. Failure to follow safety warnings and instructions can lead to serious injury or death.

Throughout this manual DANGER, WARNING, CAUTION, NOTICE, and the SAFETY ALERT SYMBOL will be used.



This is the safety alert symbol. It is used to alert you to potential physical injury hazards. Obey all safety messages that follow this symbol to avoid possible injury or death. The safety alert symbol precedes the signal words DANGER, WARNING, and CAUTION

### **DANGER**

DANGER indicates a hazardous situation that, if not avoided, will result in death or serious injury.

### **WARNING**

WARNING indicates a hazardous situation that, if not avoided, could result in death or serious injury.

### **CAUTION**

CAUTION indicates a hazardous situation that, if not avoided, could result in minor or moderate injury.

### **NOTICE**

NOTICE indicates a situation that, if not avoided, could result in vehicle damage.

## FUEL REQUIREMENTS

Your new vehicle is designed to obtain maximum performance with UNLEADED FUEL, as well as minimize exhaust emissions and spark plug fouling.

Your new vehicle is designed to perform optimally using unleaded fuel having an octane number  $((R+M)/2)$  of 87 (Research Octane Number 91) or higher. For improved vehicle performance, premium unleaded fuel with an octane number  $((R+M)/2)$  of 91 (Research Octane Number 95) or higher is recommended. (Do not use methanol blended fuels.)

### NOTICE

To prevent damage to the engine and engine components, never add any fuel system cleaning agents to the fuel tank other than what has been specified.

Consult an authorized retailer of Genesis Branded products for additional information.

---

### WARNING

- Do not “top off” after the nozzle automatically shuts off when refueling.
  - Always check that the fuel cap is installed securely to prevent fuel spillage in the event of an accident.
- 

### *Gasohol Containing Alcohol and Methanol*

Gasohol, a mixture of gasoline and ethanol (also known as grain alcohol) are being marketed along with or instead of leaded or unleaded gasoline. For example, “E15” is a gasohol comprised of 15% ethanol and 85% gasoline. Do not use gasohol containing more than 15% ethanol, and do not use gasoline or gasohol containing any methanol. Either of these fuels may cause drivability problems and damage to the fuel system, engine control system and emission control system.

Discontinue using gasohol of any kind if drivability problems occur. “E85” fuel is an alternative fuel comprised of 85 percent ethanol and 15 percent gasoline, and is manufactured exclusively for use in Flexible Fuel Vehicles. “E85” is not compatible with your vehicle. Use of “E85” may result in poor engine performance and damage to your vehicle’s engine and fuel system. Genesis Branded Vehicle recommends that customers do not use fuel with an ethanol content exceeding 15 percent.

### NOTICE

To prevent damage to your vehicle’s engine and fuel system:

- Never use gasohol which contains methanol.
- Never use gasohol containing more than 15% ethanol.
- Never use leaded fuel or leaded gasohol.
- Never use “E85” fuel.

Your New Vehicle Limited Warranty does not cover damage to the fuel system or any performance problems caused by the use of “E85” fuel.

---

### ***Using Fuel Additives (except Detergent Fuel Additives)***

Using fuel additives such as:

- Silicone fuel additive
- Ferrocene (iron-based) fuel additive
- Other metallic-based fuel additives

may result in cylinder misfire, poor acceleration, engine stalling, damage to the catalyst, or abnormal corrosion, and may cause damage to the engine resulting in a reduction in the overall life of the powertrain.

The Malfunction Indicator Lamp (MIL) may illuminate.

#### **NOTICE**

Damage to the fuel system or performance problem caused by the use of these fuels or fuel additives may not be covered by your New Vehicle Limited Warranty.

### ***Gasoline Containing MMT***

Some gasoline contains harmful manganese-based fuel additives such as MMT (Methylcyclopentadienyl Manganese Tricarbonyl).

Genesis Branded Vehicle does not recommend the use of gasoline containing MMT.

This type of fuel can reduce vehicle performance and affect your emission control system.

The malfunction indicator lamp on the cluster may come on.

### ***Detergent Fuel Additives***

Genesis Branded Vehicle recommends that you use good quality gasolines treated with detergent additives such as TOP TIER Detergent Gasoline, which help prevent deposit formation in the engine. These gasolines will help the engine run cleaner and enhance performance of the Emission Control System. For more information on TOP TIER Detergent Gasoline, please go to the website ([www.toptiergas.com](http://www.toptiergas.com)).

For customers who do not use TOP Tier Detergent Gasoline regularly, and have problems starting or the engine does not run smoothly, detergent-based fuel additives that you can purchase separately may be added to the gasoline. If TOP TIER Detergent Gasoline is not available, one bottle of additive added to the fuel tank at every 8,000 miles or 12 months is recommended.

Additives are available from your authorized retailer of Genesis Branded products along with information on how to use them. Do not mix other additives.

### ***Operation in Foreign Countries***

If you are going to drive your vehicle in another country, be sure to:

- Observe all regulations regarding registration and insurance.
- Determine that acceptable fuel is available.

## VEHICLE MODIFICATIONS

- This vehicle should not be modified. Modification of your vehicle could affect its performance, safety or durability and may even violate governmental safety and emissions regulations.

In addition, damage or performance problems resulting from any modification may not be covered under warranty.

- If you use unauthorized electronic devices, it may cause the vehicle to operate abnormally, wire damage, battery discharge, and fire. For your safety, do not use unauthorized electronic devices.

### **NOTICE**

Some warning sounds (including welcome/good-bye sound, road active noise control, etc.) are generated from the interior speakers or external amplifiers. If necessary, purchase Genesis Part to replace an interior speaker or external amplifier. Any unauthorized product may cause a malfunction of the interior speakers or external amplifiers.

---

## VEHICLE BREAK-IN PROCESS

- Do not race the engine.
- While driving, avoid sudden acceleration.
- Do not maintain a single speed for long periods of time, either fast or slow. Varying engine speed is needed to properly break-in the engine.
- Avoid hard stops, except in emergencies, to allow the brakes to seat properly.
- Fuel economy and engine performance may vary depending on vehicle break-in process and be stabilized after 4,000 miles (6,000 km). New engines may consume more oil during the vehicle break-in period.
- Do not tow a trailer during the first 1,200 miles (2,000 km) of operation.

### **NOTICE**

#### CALIFORNIA PROPOSITION 65 WARNING

Items contained in motor vehicles or emitted from them are known to the State of California to cause cancer and birth defects or reproductive harm. These include:

- Gasoline and its vapors
- Engine exhaust
- Used engine oil
- Interior passenger compartment components and materials
- Component parts which are subject to heat and wear

In addition, battery posts, terminals and related accessories contain lead, lead compounds and other chemicals known to the State of California to cause cancer and reproductive harm.

---



## VEHICLE DATA COLLECTION AND EVENT DATA RECORDERS

This vehicle is equipped with an event data recorder (EDR). The main purpose of an EDR is to record, in certain crash or near crash-like situations, such as an air bag deployment or hitting a road obstacle, data that will assist in understanding how a vehicle's systems performed. The EDR is designed to record data related to vehicle dynamics and safety systems for a short period of time, typically 30 seconds or less. The EDR in this vehicle is designed to record such data as:

- How various systems in your vehicle were operating;
- Whether or not the driver and passenger safety belts were buckled/fastened;
- How far (if at all) the driver was depressing the accelerator and/or brake pedal; and,
- How fast the vehicle was traveling.

These data can help provide a better understanding of the circumstances in which crashes and injuries occur.

### *i* Information

EDR data are recorded by your vehicle only if a non-trivial crash situation occurs; no data are recorded by the EDR under normal driving conditions and no personal data (for example, name, gender, age, and crash location) are recorded. However, other parties, such as law enforcement, could combine the EDR data with the type of personally identifying data routinely acquired during a crash investigation.

To read data recorded by an EDR, special equipment is required, and access to the vehicle or the EDR is needed. In addition to the vehicle manufacturer, other parties, such as law enforcement, that have the special equipment, can read the information if they have access to the vehicle or the EDR.



# 2. Vehicle Information, Consumer Information and Reporting Safety Defects

Exterior Overview (Front View).....	2-2
Exterior Overview (Rear View).....	2-4
Interior Overview .....	2-6
Center Console Overview .....	2-7
Steering Wheel Control Overview .....	2-9
Engine Compartment.....	2-10
Dimensions .....	2-12
Engine.....	2-12
Bulb Wattage .....	2-13
Tires and Wheels.....	2-14
Air Conditioning System .....	2-15
Vehicle Weight and Luggage Volume.....	2-16
Reference Weight and Distance When Towing a Trailer .....	2-16
Recommended Lubricants and Capacities .....	2-17
Recommended SAE viscosity number .....	2-19
Vehicle Identification Number (VIN).....	2-21
Vehicle Certification Label.....	2-21
Tire Specification and Pressure Label.....	2-21
Engine Number.....	2-22
Air Conditioner Compressor Label.....	2-22
Consumer Information.....	2-23
Reporting Safety Defects.....	2-23
Open Source Software Notice .....	2-24

## Exterior Overview (Front View)

GV80



The actual shape may differ from the illustration.

(1) Hood .....	5-65
(2) Headlight .....	5-80, 9-67
(3) Side repeater lamp .....	9-68
(4) Tires and wheels .....	9-34
(5) Side view mirror .....	5-55
(6) Panorama sunroof .....	5-61
(7) Front windshield wiper blades .....	5-90, 9-28
(8) Windows .....	5-58
(9) Front radar .....	7-6, 7-7
(10) Wide-front view camera .....	7-5, 7-7

## GV80 Coupe



The actual shape may differ from the illustration.

(1) Hood .....	5-65
(2) Headlight.....	5-80, 9-67
(3) Side repeater lamp .....	9-68
(4) Tires and wheels .....	9-34
(5) Side view mirror.....	5-55
(6) Panorama sunroof .....	5-61
(7) Front windshield wiper blades .....	5-90, 9-28
(8) Windows.....	5-58
(9) Front radar .....	7-6, 7-7
(10)Wide-front view camera .....	7-5, 7-7

## Exterior Overview (Rear View)

GV80



The actual shape may differ from the illustration.

(1) Door .....	5-27
(2) Fuel filler door.....	5-74
(3) Rear combination lamp.....	9-68
(4) Liftgate .....	5-66
(5) Power liftgate open/close button .....	5-68
(6) High mounted stop lamp .....	9-69
(7) Rear window wiper blades.....	5-92, 9-28
(8) Antenna .....	5-133
(9) Wide-rear view camera .....	7-5, 7-95
(10) Reverse light .....	9-68

GV80 Coupe



The actual shape may differ from the illustration.

(1) Door .....	5-27
(2) Fuel filler door .....	5-74
(3) Rear combination lamp .....	9-68
(4) Liftgate .....	5-66
(5) Power liftgate open/close button .....	5-68
(6) High mounted stop lamp .....	9-69
(7) Antenna .....	5-133
(8) Wide-rear view camera .....	7-5, 7-95
(9) Reverse light .....	9-68

## Interior Overview



The actual shape may differ from the illustration.

(1) Inside door handle .....	5-28
(2) Integrated memory system .....	5-35
(3) Side view mirror control switch .....	5-55
(4) Side view mirror folding button .....	5-56
(5) Central door lock switch .....	5-29
(6) Power window switches .....	5-58
(7) Power window lock button, Electronic child safety lock button .....	5-60, 5-31
(8) Instrument panel illumination control switch .....	4-3
(9) DBC (Downhill Brake Control) button .....	6-31
(10) ESC (Electronic Stability Control) OFF button .....	6-25
(11) Power liftgate open/close button .....	5-68
(12) EPB (Electronic Parking Brake) switch .....	6-19
(13) Hood release lever .....	5-65
(14) Steering wheel tilt/telescopic switch .....	5-39
(15) Steering wheel .....	5-38
(16) Seat .....	3-4



## Center Console Overview



The actual shape may differ from the illustration.

(1) Instrument cluster .....	4-2
(2) Horn .....	5-40
(3) Driver's front airbag .....	3-51
(4) Engine Start/Stop button .....	6-6
(5) Infotainment system .....	5-132
(6) Hazard warning flasher button .....	8-2
(7) Automatic climate control system .....	5-93
(8) Passenger's front airbag .....	3-51
(9) Glove box .....	5-118
(10) USB port .....	5-132
(11) USB charger .....	5-122
(12) Wireless charging system .....	5-124
(13) Power outlet .....	5-121
(14) Fingerprint authentication system .....	5-24
(15) Auto Hold button .....	6-22
(16) Rotary shifter (Rotary gear shift dial) .....	6-11
(17) P-release cap-cover .....	6-11
(18) Parking/View button .....	7-96, 7-99
(19) Parking Safety button .....	7-112
(20) Drive mode button .....	6-47

(21)ISG (Idle Stop & Go) OFF button.....6-42  
(22)Second row climate control system .....5-95  
(23)Second row USB charger.....5-122  
(24)Power outlet / AC inverter..... 5-121, 5-123  
(25)Center console storage.....5-117  
(26)AWD (All Wheel Drive) Lock button.....6-34

## Steering Wheel Control Overview

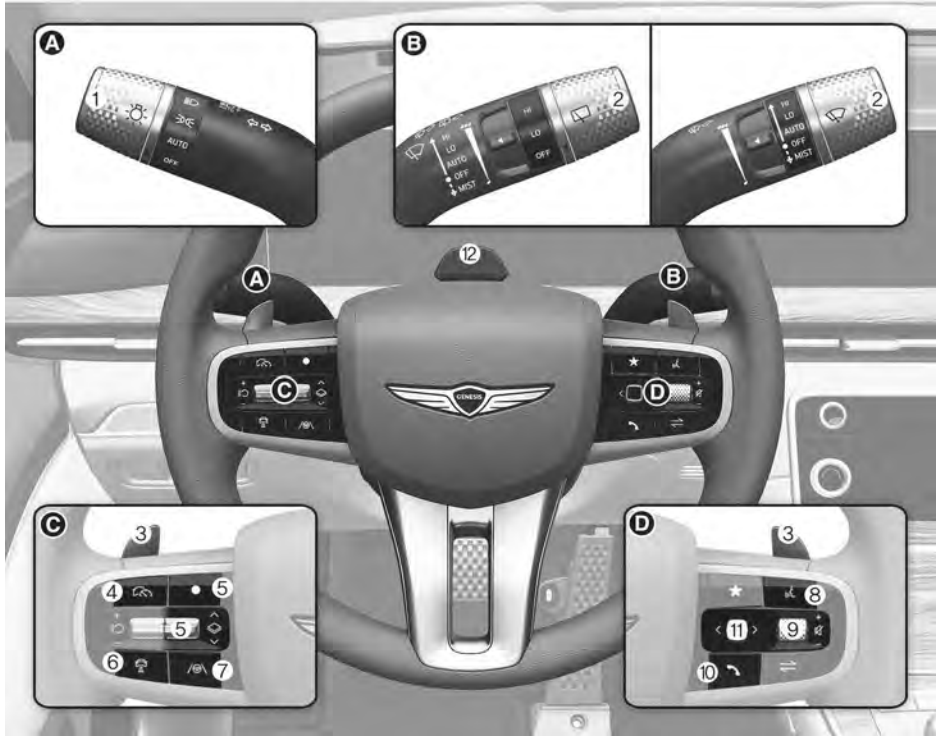

The actual shape may differ from the illustration.

(1) Lighting control lever .....	5-80
(2) Wiper and washer control lever .....	5-90
(3) Paddle shifter .....	6-16
(4) Driving Assist button .....	7-65
(5) Cluster display control .....	4-25
(6) Vehicle Distance button .....	7-65
(7) Lane Driving Assist button .....	7-30, 7-83
(8) Voice recognition button .....	5-134
(9) Audio remote control buttons .....	5-133
(10) Bluetooth® hands-free phone button .....	5-134
(11) Optical mouse .....	4-25
(12) Forward Attention Warning camera .....	7-57

## Engine Compartment

2.5 T-GDI

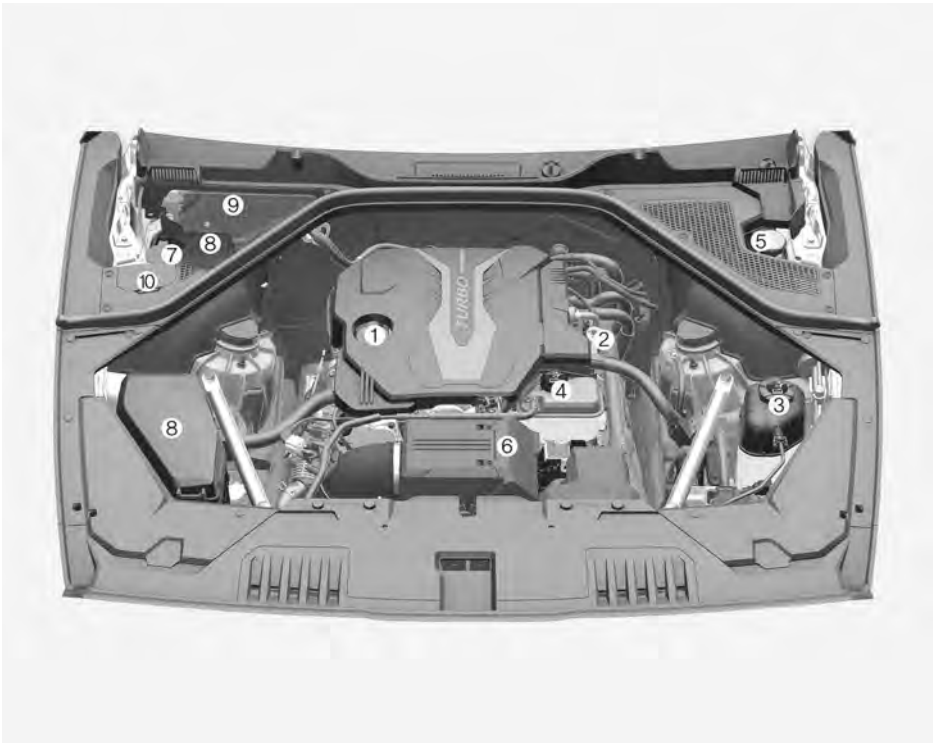

The actual engine compartment in the vehicle may differ from the illustration.

(1) Engine oil filler cap .....	9-18
(2) Engine oil dipstick .....	9-18
(3) Engine coolant reservoir .....	9-20
(4) Liquid-cooled intercooler coolant reservoir .....	9-20
(5) Brake fluid reservoir .....	9-23
(6) Air cleaner .....	9-24
(7) Windshield washer fluid reservoir .....	9-24
(8) Fuse box .....	9-46
(9) Cabin air filter .....	9-26
(10) Negative (-) battery terminal .....	8-4

## 3.5 T-GDI/3.5 T-GDI (48 V) MHEV

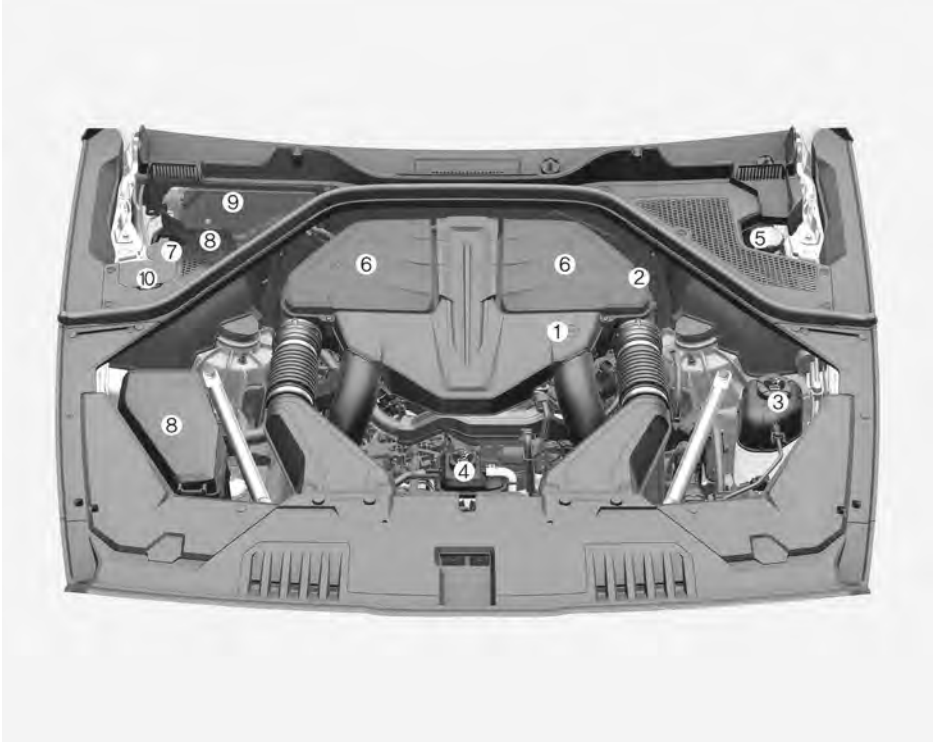

The actual engine compartment in the vehicle may differ from the illustration.

(1) Engine oil filler cap .....	9-18
(2) Engine oil dipstick .....	9-18
(3) Engine coolant reservoir .....	9-20
(4) Liquid-cooled intercooler coolant reservoir .....	9-20
(5) Brake fluid reservoir .....	9-23
(6) Air cleaner .....	9-24
(7) Windshield washer fluid reservoir .....	9-24
(8) Fuse box .....	9-46
(9) Cabin air filter .....	9-26
(10) Negative (-) battery terminal .....	8-4

## Dimensions

Items		in (mm)	
		GV80	GV80 Coupe
Overall length		194.49 (4,940)	195.47 (4,965)
Overall width		77.76 (1,975)	77.76 (1,975)
Overall height		67.52 (1,715)	67.32 (1,710)
Tread (Front)	265/55R19	65.91 (1,674)	-
	265/50R20	65.91 (1,674)	65.91 (1,674)
	265/40R22	65.91 (1,674)	65.91 (1,674)
Tread (Rear)	265/55R19	66.50 (1,689)	-
	265/50R20	66.50 (1,689)	66.50 (1,689)
	265/40R22	66.50 (1,689)	66.50 (1,689)
Wheelbase		116.34 (2,955)	116.34 (2,955)

## Engine

Engine	Displacement	Bore x Stroke	Firing order	No. of cylinders
2.5 T-GDI	2497 cc (152.4 cu. in)	88.5 x 101.5 mm (3.5 x 4 in.)	1-3-4-2	4
3.5 T-GDI	3470 cc (211.8 cu. in)	92 x 87 mm (3.6 x 3.4 in.)	1-2-3-4-5-6	6
3.5 T-GDI (48 V) MHEV				

## Bulb Wattage

Light bulb		Bulb type	Wattage
Front	Headlight	Low	LED
		High, Low beam assist	LED
	Turn signal light		LED
	Parking light		LED
	Daytime Running Light (DRL)		LED
	Side marker		LED
	Puddle light		LED
Rear	Stop light		LED
	Tail light		LED
	Turn signal light		LED
	Reverse light		LED
	Side marker		LED
	License plate light		LED
	High mounted stop light		LED
Interior	First row lamp (map lamp, room lamp)		LED
	Second row room lamp (without sunroof), Third row room lamp (Type A)		LED
	Second row personal lamp (with sunroof)		LED
	Third row room lamp (Type B)		LED
	Vanity mirror lamp		LED
	Glove box lamp		LED
	Inner door handle lamp/Foot lamp/Door courtesy lamp/Mood lamp		LED
Cargo area lamp		LED	

## Tires and Wheels

Items	Tire size	Wheel size	Inflation pressure psi (kPa)				Wheel bolt torque lbf-ft (kgf-m, N·m)
			Normal load		Maximum load		
			Front	Rear	Front	Rear	
Full size tire (5-seater/ Coupe)	265/55R19	8.5J X 19	33 (230)	36 (250)	35 (240)	38 (260)	101-116 (14-16, 137-157)
	265/50R20	8.5J X 20	33 (230)	36 (250)	35 (240)	38 (260)	
	265/40R22	9.5J X 22	33 (230)	36 (250)	35 (240)	38 (260)	
Full size tire (Coupe e-S/C)	265/50R20	8.5J X 20	33 (230)	36 (250)	36 (250)	39 (270)	
	265/40R22	9.5J X 22	33 (230)	38 (260)	39 (270)	45 (310)	
Full size tire (7-seater)	265/55R19	8.5J X 19	33 (230)	36 (250)	36 (250)	39 (270)	
	265/50R20	8.5J X 20	33 (230)	36 (250)	36 (250)	39 (270)	
	265/40R22	9.5J X 22	36 (250)	42 (290)	39 (270)	45 (310)	
Compact spare tire *1	T175/80R19	4.5T X 19	60 (420)	60 (420)	60 (420)	60 (420)	

\*1 If your vehicle is not equipped with a compact spare tire, a Tire Mobility Kit will be provided with your vehicle.

### NOTICE

- Ambient temperature affects tire pressure (about 1 psi (7 kPa) for every 12°F (7°C) change). If colder temperatures are anticipated, it is permissible to increase cold tire inflation pressure by up to 3 psi (20 kPa) over the specification. If extreme temperature changes are expected, be sure to check and adjust tire pressure accordingly.
- Tire inflation pressure decreases with higher elevation, and increases with lower elevation (about 2.4 psi (10 kPa) for every mile (or kilometer) elevation change). Be sure to check and adjust tire pressure accordingly when driving through changing elevations.
- Do not exceed the maximum inflation pressure, as found on the sidewall of the tire(s).



**⚠ CAUTION**

When replacing tires, ALWAYS use the same size, type, brand, construction, and tread pattern supplied with the vehicle. If not, it can damage the related parts or make it work irregularly.

## Air Conditioning System

Items		Weight of volume	Classification
Refrigerant	5-seater	22.9-24.7 oz. (650-700 g)	R-1234yf
	7-seater	34.4-36.2 oz. (975-1,025 g)	
Compressor lubricant	5-seater	3.2-3.9 oz. (90-110 g)	PAG
	7-seater	6.3-7.1 oz. (180-200 g)	

Contact an authorized retailer of Genesis Branded products for more details.

## Vehicle Weight and Luggage Volume

Gross vehicle weight			
Items		5-seater	7-seater
2.5 T-GDI	GV80	6030 lbs. (2735 kg)	-
	GV80	6173 lbs. (2800 kg)	6526 lbs. (2960 kg)
3.5 T-GDI	GV80 Coupe	6118 lbs. (2775 kg)	-
	GV80 Coupe	6229 lbs. (2825 kg)	-

Luggage volume				
Items		GV80		GV80 Coupe
		5-seater	7-seater	
SAE	Min.	38.7 cu ft. (1,097 ℓ)	36.5 cu ft. (1,033 ℓ)	29.3 cu ft. (829 ℓ)
	Max.	71.8 cu ft. (2,034 ℓ)	71.7 cu ft. (2,030 ℓ)	61.1 cu ft. (1,729 ℓ)

Min: Behind rear seat to upper edge of the seatback.

Max: Behind front seat to roof.

## Reference Weight and Distance When Towing a Trailer

Item		GV80	GV80 Coupe
Maximum trailer weight	With brake system	6000 lbs. (2722 kg)	6000 lbs. (2722 kg)
	Without brake system	1654 lbs. (750 kg)	1654 lbs. (750 kg)
Maximum tongue weight *1		600 lbs. (272 kg)	600 lbs. (272 kg)

\*1 : Tongue weight should be between allowable 10-15 %

## Recommended Lubricants and Capacities

To help achieve proper engine and powertrain performance and durability, use only lubricants of the proper quality. The correct lubricants also help promote engine efficiency that results in improved fuel economy.

These lubricants and fluids are recommended for use in your vehicle.

Lubricant		Volume	Classification
Engine oil <sup>*1*2</sup> Recommends 	2.5 T-GDI	6.5 US qt. (6.2 ℓ)	SAE 0W-30, API SN PLUS/SP or ILSAC GF-6 <sup>*3</sup>
	3.5 T-GDI, 3.5 T-GDI (48 V) MHEV	7.4 US qt. (7.0 ℓ)	SAE 0W-30, API SN PLUS/SP or ILSAC GF-6 <sup>*3</sup>
Automatic transmission fluid		9.7 US qt. (9.2 ℓ)	GS ATF SP-IV-RR, Genesis/HYUNDAI genuine ATF SP-IV-RR or other brands meeting the above specification approved by Genesis Customer Care
Engine coolant	2.5 T-GDI	5-seater	10.6 US qt. (10.1 ℓ)
	3.5 T-GDI	5-seater	11.6 US qt. (11.0 ℓ)
		7-seater	16.3 US qt. (15.5 ℓ)
	3.5 T-GDI (48 V) MHEV	5-seater	12.8 US qt. (12.1 ℓ)
Mixture of antifreeze and water (Phosphate-based Ethylene glycol coolant for aluminum radiator)			
Liquid-cooled intercooler coolant	2.5 T-GDI		3.79 US qt. (3.6 ℓ)
	3.5 T-GDI, 3.5 T-GDI (48 V) MHEV		4.12 US qt. (3.9 ℓ)
Brake fluid <sup>*4</sup>		As required	SAE J1704 DOT-4 LV, FMVSS 116 DOT-4, ISO4925 CLASS-6
Front differential oil (AWD) <sup>*5</sup>		0.71 ± 0.026 US qt. (0.67 ± 0.025 ℓ)	Hypoid Gear Oil API GL-5 SAE 75W/85 (SK HK SYN Gear Oil 75W-85 FM plus or equivalent)

Lubricant	Volume	Classification
Rear differential oil *5	1.37 ± 0.05 US qt. (1.3 ± 0.05 ℓ)	Hypoid Gear Oil API GL-5 SAE 75W/85 (SK HK SYN Gear Oil 75W-85 FM plus or equivalent)
Transfer case oil (AWD)	1.11 ± 0.022 US qt. (1.05 ± 0.021 ℓ)	FUCHS ATF 134 MPT
Electronic Limited Slip Differential (e-LSD) oil	0.433 ± 0.015 qt. (410 ± 15 mℓ)	SHELL TF0870 C
Fuel	21.1 US gal. (80 ℓ)	Refer to the "Fuel requirements" section in chapter 1.

\*1 Refer to the recommended SAE viscosity numbers.

\*2 Engine oils labeled Energy Conserving Oil are now available. Along with other additional benefits, they contribute to fuel economy by reducing the amount of fuel necessary to overcome engine friction. Often, these improvements are difficult to measure in everyday driving, but in a year's time, they can offer significant cost and energy savings.

\*3 Requires <API SN PLUS (or above) Full synthetic> grade engine oil. If a lower grade engine oil (mineral oil including Semi-synthetic) is used, then the engine oil and engine oil filter must be replaced as indicated severe maintenance condition.

\*4 To maintain the best braking performance and ABS/ESC performance, use genuine brake fluid that conform to specifications.

\*5 If the front/rear differential is submerged, visit an authorized retailer of Genesis Branded products to replace the differential oil.

## NOTICE

Severe engine and transmission damage may result from the use of poor quality fuels and lubricants that do not meet Genesis Branded Vehicle specifications. Always use high quality fuels and lubricants that meet the specifications listed in the recommended table.

## Recommended SAE viscosity number

### NOTICE

- Always be sure to clean the area around any filler plug, drain plug, or dipstick before checking or draining any lubricant. This is especially important in dusty or sandy areas and when the vehicle is used on unpaved roads. Cleaning the plug and dipstick areas will prevent dirt and grit from entering the engine and other mechanisms that could be damaged.
- Never add any additives to the engine oil. Engine oil additives can change the properties of engine oil and may cause serious engine failure.

Engine oil viscosity (thickness) has an effect on fuel economy and cold weather operating (engine start and engine oil flowability). Lower viscosity engine oils can provide better fuel economy and cold weather performance, however, higher viscosity engine oils are required for satisfactory lubrication in hot weather. Using oils of any viscosity other than those recommended may result in engine damage.

When choosing an oil, consider the range of temperature your vehicle is operated in before the next oil change. Proceed to select the recommended oil viscosity from the chart.

Temperature		Temperature Range for SAE Viscosity Numbers									
		°C	-30	-20	-10	0	10	20	30	40	50
		(°F)		-10	0	20	40	60	80	100	120
Gasoline Engine Oil	2.5 T-GDI *1	0W-30									
	3.5 T-GDI *1	0W-30									
	3.5 T-GDI *2, 3.5 T-GDI (48 V) MHEV *2	5W-30									

\*1 Requires <API SN PLUS (or above) Full synthetic> grade engine oil. If a lower grade engine oil (mineral oil including Semi-synthetic) is used, then the engine oil and engine oil filter must be replaced as indicated severe maintenance condition.

\*2 Requires <API SN PLUS (or above) or ACEA A5/B5 Full synthetic> grade engine oil. If a lower grade engine oil (mineral oil including Semi-synthetic) is used, then the engine oil and engine oil filter must be replaced as indicated severe maintenance condition.



An engine oil displaying this American Petroleum Institute (API) Certification Mark conforms to the International Lubricant Specification Advisory Committee (ILSAC). It is recommended to only use engine oils that uphold this API Certification Mark.

## Vehicle Identification Number (VIN)

Frame number

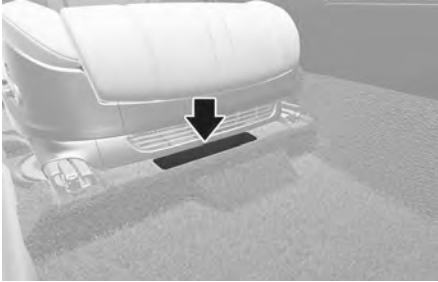

The vehicle identification number (VIN) is the number used in registering your vehicle and in all legal matters pertaining to its ownership, etc.

The number is punched on the floor under the right front seat. To check the number, open the cover.

Vin label (if equipped)



The VIN is also on a plate attached to the top of the left side dashboard. The number on the plate can easily be seen through the windshield from outside.

## Vehicle Certification Label



The vehicle certification label attached on the driver's (or front passenger's) side center pillar gives the vehicle identification number (VIN).

## Tire Specification and Pressure Label



The tires supplied on your new vehicle are chosen to provide the best performance for normal driving.

The tire label located on the driver's side center pillar gives the tire pressures recommended for your vehicle.

## Engine Number

2.5 T-GDI

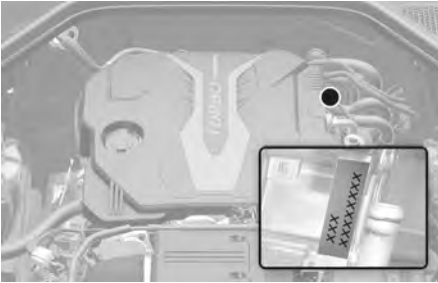

3.5 T-GDI/3.5 T-GDI (48 V) MHEV



The engine number is stamped on the engine block as shown in the drawing.

## Air Conditioner Compressor Label



A compressor label informs you the type of compressor your vehicle is equipped with such as model, supplier part number, production number, refrigerant (1), and refrigerant oil (2).



## Consumer Information

This consumer information has been prepared in accordance with regulations issued by the National Highway Traffic Safety Administration of the U.S. Department of Transportation. Your retailer of Genesis Branded products will help answer any questions you may have as you read this information.

Genesis Branded Vehicles are designed and manufactured to meet or exceed all applicable safety standards.

For your safety, however, we strongly urge you to read and follow all directions in this Owner's Manual, particularly the information under the headings "NOTICE", "CAUTION" and "WARNING".

## Reporting Safety Defects

If you believe that your vehicle has a defect which could cause a crash or could cause injury or death, you should immediately inform the National Highway Traffic Safety Administration (NHTSA) in addition to notifying Genesis Customer Care.

If NHTSA receives similar complaints, it may open an investigation, and if it finds that a safety defect exists in a group of vehicles, it may order a recall and remedy campaign. However, NHTSA cannot become involved in individual problems between you, your dealer, or Genesis Customer Care.

To contact NHTSA, you may call the Vehicle Safety Hotline toll-free at 1-888-327-4236 (TTY: 1-800-424-9153);

go to <http://www.safercar.gov>;

download the SaferCar mobile application;

or write to: Administrator, NHTSA.

1200 New Jersey Ave, SE.,

Washington, DC. 20590.

You can also obtain other information about motor vehicle safety from

<http://www.safercar.gov>.

## Open Source Software Notice

This vehicle contains software with open source licenses.

Open source software information including the source code, copyright notices and referred license terms may be obtained on the website <https://www.genesis.com/worldwide/en/opensource.html>.

Hyundai Motor Company will provide the open source code to you in storage medium such as CD-ROM for minimum charge covering the cost of performing source distribution upon email request to [opensource@genesis.com](mailto:opensource@genesis.com) within a period of 3 years from the date of product purchase.

# 3. Safety System

- Important Safety Precautions..... 3-2
  - Always Wear Your Seat Belt ..... 3-2
  - Restrain All Children ..... 3-2
  - Airbag Hazards ..... 3-2
  - Driver Distraction ..... 3-2
  - Never Drink or Take Drugs and Drive ..... 3-2
  - Control Your Speed..... 3-3
  - Keep Your Vehicle in Safe Condition ..... 3-3
- Seats ..... 3-4
  - Safety Precautions ..... 3-8
  - Front Seats..... 3-9
  - Rear Seats..... 3-13
  - Head restraint..... 3-22
  - Seat Warmers ..... 3-26
  - Air Ventilation Seats..... 3-29
- Seat Belts ..... 3-31
  - Seat Belt Safety Precautions ..... 3-31
  - Seat Belt Warning Light ..... 3-32
  - Seat Belt Restraint System ..... 3-34
  - Pre-Active Seat Belt (PSB)..... 3-38
  - Additional Seat Belt Safety Precautions ..... 3-39
  - Care of Seat Belts..... 3-41
- Child Restraint System (CRS) ..... 3-41
  - Children Always in the Rear ..... 3-41
  - Selecting a Child Restraint System..... 3-42
  - Installing a Child Restraint System ..... 3-44
- Supplemental Restraint System - Airbags ..... 3-50
  - Where are the Airbags? ..... 3-51
  - How does the Airbags System Operate?..... 3-55
  - What to Expect After an Airbag Inflates ..... 3-58
  - Occupant Classification System (OCS) ..... 3-59
  - Do Not Install a Child Restraint System on the Front Passenger Seat..... 3-64
  - Why Didn't My Airbag Go Off in a Collision? ..... 3-65
  - SRS Care ..... 3-69
  - Additional Safety Precautions..... 3-70
  - Airbag Warning Labels..... 3-70

## Important Safety Precautions

You will find many safety precautions and recommendations throughout this section, and throughout this manual. The safety precautions in this section are among the most important.

### Always Wear Your Seat Belt

A seat belt is your best protection in all types of accidents. Airbags are designed to supplement seat belts, not replace them. So even though your vehicle is equipped with airbags, always make sure you and your passengers wear your seat belts, and wear them properly.

### Restrain All Children

All children under age 13 should ride in your vehicle properly restrained in a rear seat, not the front seat. Infants and small children should be restrained in an appropriate Child Restraint System. Larger children should use a booster seat with the lap/shoulder belt until they can use the seat belt properly without a booster seat.

### Airbag Hazards

While airbags can save lives, they can also cause serious or fatal injuries to occupants who sit too close to them, or who are not properly restrained. Infants, young children, and short adults are at the greatest risk of being injured by an inflating airbag. Follow all instructions and warnings in this manual.

### Driver Distraction

Driver distraction presents a serious and potentially deadly danger, especially for inexperienced drivers. Safety should be the first concern when behind the wheel and drivers need to be aware of the wide array of potential distractions, such as drowsiness, reaching for objects, eating, personal grooming, other passengers, and using mobile phones.

Drivers can become distracted when they take their eyes and attention off the road or their hands off the wheel to focus on activities other than driving. To reduce your risk of distraction and an accident:

- Set up your mobile devices (i.e. MP3 players, phones, navigation units, etc.) when your vehicle is parked or safely stopped.
- ONLY use your mobile device when allowed by laws and conditions permit safe use. NEVER text or email while driving. Most countries have laws prohibiting drivers from texting. Some countries and cities also prohibit drivers from using handheld phones.
- NEVER let the use of a mobile device distract you from driving. You have a responsibility to your passengers and others on the road to always drive safely, with your hands on the wheel as well as your eyes and attention on the road.

### Never Drink or Take Drugs and Drive

Drinking alcohol or taking drugs can reduce your ability to respond to changing conditions and emergencies. Do not drink or take drugs and drive, and do not let your friends drink or take drugs and drive.

## **Control Your Speed**

Excessive speed is a major factor in crash injuries and deaths. Generally, the higher the speed, the greater the risk, but serious injuries can also occur at lower speeds. Never drive faster than is safe for current conditions, regardless of the maximum speed posted.

## **Keep Your Vehicle in Safe Condition**

Having a tire blowout or a mechanical failure can be extremely hazardous. To reduce the possibility of a tire hazard while driving, check your tire pressures regularly and also inspect the condition of your tires (tread depth, uneven wear, etc.). Be sure to perform all regularly scheduled maintenance as indicated in your Owner's Manual.

## Seats

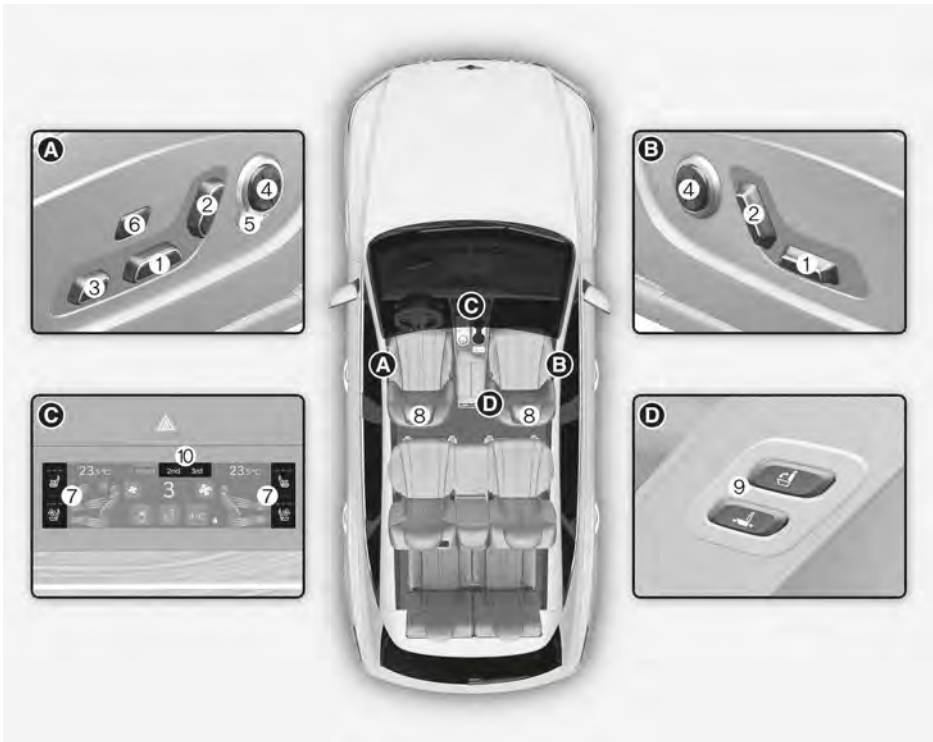

The position of the switches may vary depending on the feature available to your vehicle.

### **Front seat**

- (1) Seat sliding forward or rearward / Seat cushion tilt / Seat height
- (2) Seatback angle
- (3) Seat cushion extension / Seat cushion support
- (4) Lumbar support
- (5) Seatback bolster
- (6) Comfortable stretch
- (7) Seat warmer / Air ventilation seat
- (8) Head restraint adjustment
- (9) Walk-in seat switch
- (10) Rear adjustment

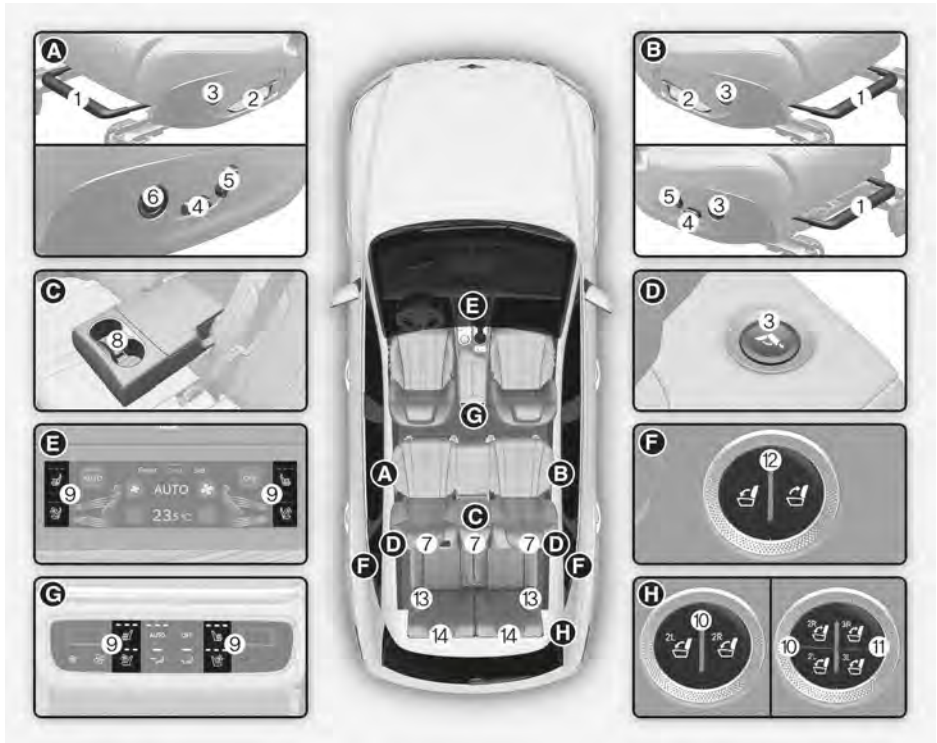

The position of the switches may vary depending on the feature available to your vehicle.

### **Second row seat (5-seater)**

- (1) Seat sliding forward or rearward
- (2) Seatback angle
- (3) Automatic folding switch
- (4) Seat sliding forward or rearward / Seat cushion tilt
- (5) Seatback angle
- (6) Automatic folding or unfolding switch
- (7) Head restraint adjustment
- (8) Armrest
- (9) Seat warmer / Air ventilation seat
- (10) 2<sup>nd</sup> row seat folding switch (2<sup>nd</sup> row manual seat) / 2<sup>nd</sup> row seat folding or unfolding switch (2<sup>nd</sup> row power seat)

### **Second row and Third row seat (7-seater)**

- (1) Seat sliding forward or rearward
- (2) Seatback angle
- (3) Walk-in switch
- (4) Seat sliding forward or rearward / Seat cushion tilt
- (5) Seatback angle
- (6) Automatic folding or unfolding switch

- (7) Head restraint adjustment
- (8) Armrest
- (9) Seat warmer / Air ventilation seat
- (10) 2<sup>nd</sup> row seat folding switch (2<sup>nd</sup> row manual seat) / 2<sup>nd</sup> row seat folding or unfolding switch (2<sup>nd</sup> row power seat)
- (11) 3<sup>rd</sup> row seat folding or unfolding switch (3<sup>rd</sup> row power seat)
- (12) 3<sup>rd</sup> row seat seatback angle switch (3<sup>rd</sup> row power seat)
- (13) 3<sup>rd</sup> row seat seatback angle strap
- (14) Head restraint adjustment



## Infotainment system



Select **Setup > Vehicle > Seat** from the Settings menu in the infotainment system, you may use various convenience functions.

- **Seat Switch Alert:** Detailed information of the seat switch and image is displayed when the switch is touched or the switch is moved.
- **Warmer/Ventilated Features or Heating/Ventilation**
  - **Automatic Controls Linked to Climate Control Settings**(for driver's seat): The seat temperature is automatically controlled.
  - **Seat heater balance:** When the seat heater is on, you may lower the seat heater (warmer) setting, or may turn the seat heater off for either the seatback or seat cushion.
- **Seating easy access**
  - **Steering wheel easy access:** Moves the steering wheel when the driver enters or leaves the vehicle.
  - **Driver seat easy access:** The distance (Normal/Extended/Off) the seat automatically moves when the driver enters or leaves the vehicle may be selected.
  - **Passenger seat easy access:** Moves the passenger seat when the passenger enters or leaves the vehicle.
- **Ergo-Motion Seat**
  - **Comfortable stretch:** The operation intensity and operation time for Comfortable Stretch may be selected.
  - **Smart posture assist:** The seat is adjusted to assist the driver's posture after driving for an hour.
  - **Smart support:** The driver's seat bolster is increased when SPORT mode is selected or when driving at high speed.

### *i* Information

- The infotainment system may change after software updates. For more information, refer to the manual provided in the infotainment system and the quick reference guide.
- The information provided may differ depending on which functions are applicable to your vehicle.

## Safety Precautions

Adjusting the seats to sit in a safe and comfortable position plays an important role for the safety of the driver and passengers. Proper seating positions, secured seat belts, and protection from airbags work together to provide a measure of safety in the event of a collision.

### WARNING

Do not use a cushion that reduces friction between the seat and the passenger. The passenger's hips may slide under the lap portion of the seat belt during an accident or a sudden stop.

Serious or fatal internal injuries could result because the seat belt cannot operate properly.

---

## Airbags

You can take steps to reduce the risk of being injured by an inflating airbag. Sitting too close to an airbag greatly increases the risk of injury in the event the airbag inflates. Move your seat as far back as possible from front airbags, while still maintaining control of the vehicle.

### WARNING

To reduce the risk of serious injury or death from an inflating airbag:

- Adjust the driver's seat as far to the rear as possible while maintaining your ability to control the vehicle.
- Adjust the front passenger seat as far to the rear as possible.
- Hold the steering wheel with hands at the 9 o'clock and 3 o'clock positions to minimize the risk of injuries to your hands and arms.
- Never place anything or anyone between you and the airbag.

- Do not allow the front passenger to place feet or legs on the dashboard to minimize the risk of leg injuries.
- 

## Seat belts

Always fasten your seat belt before starting any trip. At all times, passengers should sit upright and be properly restrained with a seat belt. Infants and small children must be restrained in appropriate Child Restraint Systems.

### WARNING

To prevent serious injury or death:

- Never use one seat belt for more than one occupant.
  - Always position the seatback upright with the lap portion of the seat belt snug and low across the hips.
  - Never allow children or small infants to ride on a passenger's lap.
  - Do not route the seat belt across your neck, across sharp edges, or reroute the shoulder strap away from your body.
  - Do not allow the seat belt to become caught or jammed.
-

## Front Seats

### WARNING

Take the following precautions when adjusting your seat:

- Never attempt to adjust the seat while the vehicle is moving. The seat could respond with unexpected movement and may cause loss of vehicle control resulting in a collision
- Do not place anything under the front seats. Loose objects, including unsecured floor mats, in the driver's foot area could interfere with the operation of the foot pedals.
- Do not allow anything to interfere with the normal position and proper locking of the seatback.
- Do not place a cigarette lighter on the floor or seat.
- Use extreme caution when picking up small objects trapped under the seats or between the seat and the center console. Your hands might be cut or injured by the sharp edges of the seat mechanism.
- If there are occupants in the rear seats, be careful while adjusting the front seat.
- Make sure that the seat is locked in place after the adjustment. If not, the seat might move unexpectedly resulting in an accident.

### CAUTION

To prevent injury:

- Do not adjust your seat while wearing your seat belt. Moving the seat cushion forward may cause strong pressure on your abdomen.
- Do not allow your hands or fingers to get caught in the seat mechanisms while the seat is moving.

## Reclining seatback

Sitting in a reclined position when the vehicle is moving can be dangerous. Even when buckled up, the protections of your restraint system (seat belts and/or airbags) is greatly reduced by reclining your seatback.

Seat belts must be snug against your hips and chest to work properly.

The more the seatback is reclined, the greater the chance for the passenger's hips to slide under the lap belt or the passenger's neck to strike the shoulder belt.

### WARNING

Never ride with a reclined seatback when the vehicle is moving.

Riding with a reclined seatback increases your chance of serious or fatal injuries in the event of a collision or sudden stop.

Driver and passengers should always sit well back in their seats, properly belted, and with the seatbacks upright.

Seat belts must be snug against your hips and chest to work properly. When the seatback is reclined, the shoulder belt cannot do its job because it will not be snug against your chest. Instead, it will be in front of you. During a collision, you could be thrown into the seat belt, causing neck or other injuries.

The more the seatback is reclined, the greater chance the passenger's hips will slide under the lap belt or the passenger's neck will strike the shoulder belt.

### Power seats

The front seat can be adjusted by using the control switches located on the outside of the seat cushion.

**⚠ WARNING**

NEVER allow children to remain in the vehicle unattended. The power seats are operable when the vehicle is turned off.

**NOTICE**

To prevent damage to the seats:

- Always stop adjusting the seats when the seat has been adjusted as far forward or rearward as possible.
- Do not adjust the seats longer than necessary when the vehicle is turned off. This may result in unnecessary battery drain.
- Do not operate two or more seats at the same time. This may result in an electrical malfunction.

### Forward and rearward

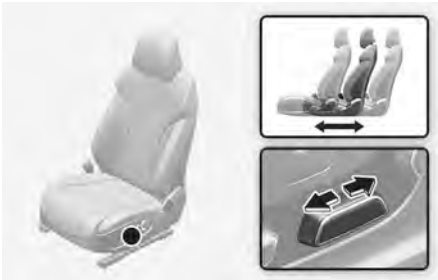

To move the seat forward or rearward:

1. Push the control switch forward or rearward.
2. Release the switch once the seat reaches the desired position.

### Seatback angle



To recline the seatback:

1. Push the control switch forward or rearward.
2. Release the switch once the seatback reaches the desired position.

### Seat cushion tilt/Seat height



- **Seat cushion tilt (1)**  
To change the angle of the front part of the seat cushion:
  1. Push the front portion of the control switch up to raise or down to lower the front part of the seat cushion.
  2. Release the switch once the seat reaches the desired position.
- **Seat height (2)**  
To change the height of the seat:
  1. Push the rear portion of the control switch up to raise or down to lower the height of the seat.
  2. Release the switch once the seat reaches the desired position.

### Seat cushion extension

 if equipped



To move the front part of the cushion forward or rearward:

1. Push the control switch forward or rearward.
2. Release the switch once the seat cushion reaches the desired length.

### Seat cushion support

 if equipped

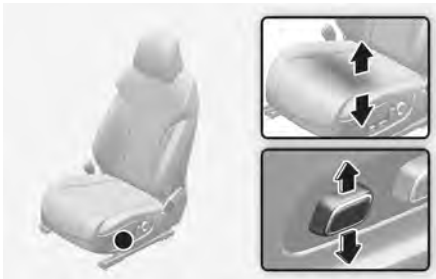

To adjust cushion support:

1. Push the control switch up to increase cushion support or down to decrease cushion support.
2. Release the switch once the seat cushion support reaches the desired position.

### Lumbar support

 if equipped

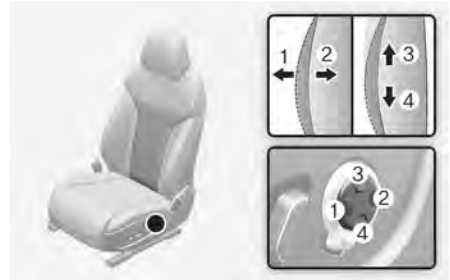

To adjust the lumbar support:

1. Press the front portion of the switch (1) to increase support or the rear portion of the switch (2) to decrease support.
2. Press switch (3) or (4) to move the support position up or down.
3. Release the switch once the lumbar support reaches the desired position.

### Seat bolster

 if equipped



To adjust seat bolster:

1. Push the adjustment lever clockwise, the seatback bolster is adjusted inward. Push the switch counterclockwise, the seatback bolster is adjusted outward.
2. Release the lever once the bolster reaches the desired position.

## Ergo-motion seat

 if equipped

Select **Setup > Vehicle > Seat > Ergo-Motion Seat** from the infotainment system's Settings menu to select and set up supplemental functions.

### **WARNING**

Before actually using each function, try the functions with the vehicle parked.

### Comfortable stretch

Comfortable stretch is a function that helps relieve fatigue of the driver's pelvis and lower back due to driving.



Every time you press the button, you may select a mode or turn off the function in the following order.

- Pelvic stretching: The cushion portion moves, helping the left and right movement of the pelvis.
- Lumbar stretching: The seatback portion moves, helping back and forth movement of the lower back.
- Whole Body stretching: The cushion and seatback moves in sequence, helping the whole body reduce fatigue.
- Off: Turns off Comfortable Stretch.

Also, you can change the operation intensity and operation time from the Settings menu in the infotainment system.

- Intensity: **Setup > Vehicle > Seat > Ergo-Motion Seat > Comfortable Stretch > Intensity > High/Moderate**
- Time: **Setup > Vehicle > Seat > Ergo-Motion Seat > Comfortable Stretch > Session Length > Long (20 min)/Medium (15 min)/Short (10 min)**

### Smart posture assist

After driving for an hour, Smart Posture Assist automatically adjusts the pelvis and back portion of the seat to assist the posture.

You can activate or deactivate Smart Posture Assist function from the Settings menu in the infotainment system. Select:

- **Setup > Vehicle > Seat > Ergo-Motion Seat > Smart Posture Assist**

### Smart support

The driver's seat bolster support increases when SPORT mode is selected for Drive Mode and when driving at high speed.

You can activate or deactivate Smart Support function from the Settings menu in the infotainment system. Select:

- **Setup > Vehicle > Seat > Ergo-Motion Seat > Smart Support**

### **Information**

The infotainment system may change after software updates. For more information, refer to the manual provided in the infotainment system and the quick reference guide.

### Walk-in switch



The rear seat passenger may use the switches to control the front passenger seat.

- Sliding forward or rearward:  
Press the switch (1) or (2) to move the front passenger seat forward or rearward.
- Seatback angle:  
Press the switch (3) or (4) to recline the front passenger seatback forward or rearward.

### WARNING

The rear passenger should not adjust the front seat when a passenger is seated.

### Seatback pocket



The seatback pocket is provided on the back of the front seatbacks.

### CAUTION

Do not put heavy or sharp objects in the seatback pockets. In a collision, they can come loose from the pocket and injure occupants.

### Rear Seats

#### WARNING

To prevent serious injury or death:

- Adjusting the seats
  - Never attempt to adjust the seat while the vehicle is moving.  
The seat could respond with unexpected movement and may cause loss of vehicle control resulting in a collision.
  - Make sure that the seat is locked in place after the adjustment. If not, the seat might move unexpectedly.
  - Use extreme caution when adjusting the rear seats. Your hands might be cut or injured by the sharp edges of the seat mechanism.
- Folding the seats
  - Do not fold the seatback when the seat is occupied.
  - Never allow passengers to sit on top of the folded down seatback while the vehicle is moving. This is not a proper seating position and no seat belts are available for use. This could result in serious injury or death in a collision or sudden stop.
  - Objects carried on the folded down seatback should not extend higher than the top of the front seatbacks. This could allow cargo to slide forward and property damage or serious injury or even death during a collision or sudden stop.

- Lock the seatback properly. In a collision or sudden stop, an unlocked seatback may allow cargo to move forward with great force and may result in serious injury or death.
- Loading cargo
  - Make sure the engine is off, the gear shifted to P (Park), and the parking brake is applied before loading or unloading cargo to prevent unintended movement of the vehicle.
  - Cargo should always be secured to prevent it from moving in a collision and causing serious injury or death to the vehicle occupants.
  - Do not place objects in the rear seats, because they cannot be properly secured and may hit the front seat occupants in a collision.

### NOTICE

To prevent damage to the vehicle:

- Rear seat belts
  - Before folding the seatback, insert the seat belt buckle in the holder between the seatback and cushion. And insert the seat belt webbing in the guide.



- Cargo
  - Be careful when loading cargo through the rear passenger seats.

### WARNING



Be careful when closing the liftgate with passenger's seated on the third row seat. If the passenger's head is not properly against a adjusted head restraint or a tall person is seated, the liftgate may hit the passenger's head, that could cause injury.

### Manual adjustment (second row)

#### Forward and rearward



To move the seat forward or rearward:

1. Pull up the seat slide adjustment lever and hold it.
2. Slide the seat to the desired position.
3. Release the lever and make sure the seat is locked in place. Move forward and rearward without using the lever. If the seat moves, it is not locked properly.



### *i* Information

If equipped with 5-seater or 7-seater, the central seat moves together with the left side second row seat.

#### Seatback angle

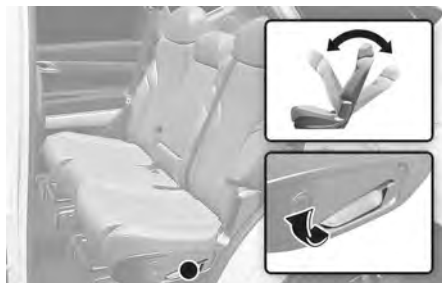

To recline the seatback:

1. Pull up the seatback recline lever.
2. Carefully lean back on the seat and adjust the seatback to the desired position.
3. Release the lever and make sure the seatback is locked in place. The lever MUST return to its original position for the seatback to lock.

### *i* Information

The seatbacks can be folded with the seatback recline lever.

### Seatback folding (5-seater) / Walk-in function (7-seater)

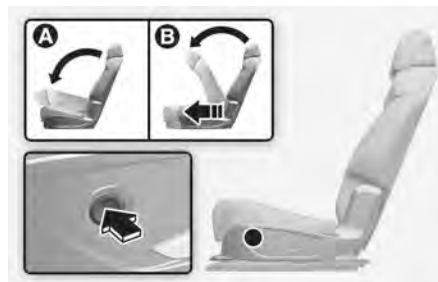

[A] 5-seater  
[B] 7-seater

- 5-seater (↙)
- The seatback folds if the switch is pressed.
- 7-seater (↙)
- The seatback folds and the seat slightly moves forward, if the switch is pressed.
- The function operates when the gear is in P (Park) with the door open.
- While the seatback folding or walk-in function is operating, if the switch is pressed, the seat stops moving. If the switch is pressed again, the seat continues the adjustment.
- While the seatback folding or walk-in function is operating, if the engine is started, the seat stops moving momentarily. If the engine starts, the seat continues the adjustment.

### *i* Information

If equipped with 5-seater or 7-seater, the central seat moves together with the left side second row seat.

### Power adjustment (second row)

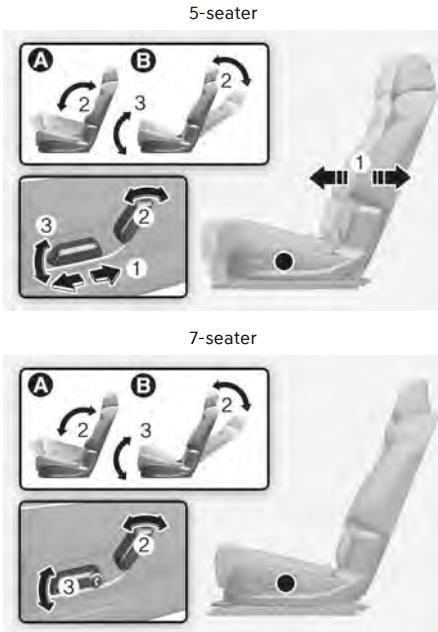

#### Forward and rearward (1) (5-seater)

To move the seat forward or rearward:

1. Push the control switch forward or rearward.
2. Release the switch once the seat reaches the desired position.

#### Seatback angle (2)

To recline the seatback:

1. Push the upper portion of the control switch forward or rearward. If the seatback is reclined rearward a certain angle, the seat cushion will be raised.
2. Release the switch once the seatback reaches the desired position.

#### Seatback folding/unfolding (2) (5, 7-seater)

To fold or unfold the seatback:

1. Push the upper portion of the control switch forward or rearward for one second.
  2. The seatback is fold or unfold.
- The function operates when the gear is in P (Park) with the door open.
  - While the seatback is folding or unfolding, if the switch is pressed, the seat stops moving. If the switch is pressed again, the seat continues the adjustment.
  - While the seatback is folding or unfolding, if the engine is started, the seat stops moving momentarily. If the engine starts, the seat continues the adjustment.

#### Seat cushion tilt (3)

To change the angle of the front part of the seat cushion:

1. Push the front portion of the control switch up to raise or down to lower the front part of the seat cushion.
2. Release the switch once the seat reaches the desired position.

### Seatback folding (5-seater) / Walk-in function (7-seater)



[A] 5-seater

[B] 7-seater

- 5-seater (↶)

The seatback folds if the switch is pressed. The seatback unfolds if the switch is pressed again.

- 7-seater (↶↷)

The seatback folds and the seat slightly moves forward, if the switch is pressed.

After using the walk-in function, push the seat rearward till it is stopped, the seatback automatically unfolds.

- The function operates when the gear is in P (Park) with the door open.
- While the seatback folding or walk-in function is operating, if the switch is pressed, the seat stops moving. If the switch is pressed again, the seat continues the adjustment.
- While the seatback folding or walk-in function is operating, if the engine is started, the seat stops moving momentarily. If the engine starts, the seat continues the adjustment.

### *i* Information

If equipped with 5-seater or 7-seater, the central seat moves together with the left side second row seat.

### Manual adjustment (third row)

#### Seatback angle



To recline the seatback:

1. Pull the seatback recline strap (1).
2. Hold the strap (1) and adjust the seatback angle to the desired position.
3. Release the strap and make sure the seatback is locked in place. The strap **MUST** return to its original position for the seatback to lock.

### Power adjustment (third row)

#### Seatback angle



Press the (↶) or (↷) switch to adjust the seatback angle.

When the seatback is folded, press the (↶) switch, the seatback automatically unfolds.

### Seat adjustment (infotainment system)

Forward and rearward position / Seatback recline / Cushion tilt

 If equipped

Second row seat adjustments can be done from the infotainment system.

#### Relax mode

 If equipped



The second row seat is adjusted to a resting/relaxing position.

You can activate or deactivate Relax Mode function from the infotainment system. Select:

- **Setup > Seat > Relax Mode**

### Information

The infotainment system may change after software updates. For more information, refer to the manual provided in the infotainment system and the quick reference guide.







### WARNING

Do not use relax mode while the vehicle is moving. The shoulder belt may not adhere to your chest firmly.

### Seatback remote folding/unfolding (cargo area)



- The function operates when the gear is in P (Park) with the door open.
- While the seatback is folding or unfolding, if the switch is pressed, the seat stops moving. If the switch is pressed again, the seat continues the adjustment.
- While the seatback is folding or unfolding, if the engine is started, the seat stops moving momentarily. If the engine starts, the seat continues the adjustment.
- When you fold or unfold the third row seatback, the second row seatback may be slightly folded forward. This is to avoid interference with the second row seats when folding the third row seats. (only for vehicles with is a 7-seater with a second row power adjustment seat)

Switch type		Seat adjustment
5-seater	Type A	 <p>Press <sup>2L</sup> switch or <sup>2R</sup> switch, the second row left or right seatback folds.</p>
	Type B	 <p>Press <sup>2L</sup> switch or <sup>2R</sup> switch, the second row left or right seatback folds. If the switch is pressed again, the seatback unfolds.</p>
7-seater	Type A	 <p>Press <sup>2L</sup> switch or <sup>2R</sup> switch, the second row left or right seatback folds.</p>
	Type B	 <p>Press <sup>2L</sup> switch or <sup>2R</sup> switch, the second row left or right seatback folds. Press <sup>3L</sup> switch or <sup>3R</sup> switch, the third row left or right seatback folds. If the switch is pressed again, the seatback unfolds.</p>
	Type C	 <p>Press <sup>2L</sup> switch or <sup>2R</sup> switch, the second row left or right seatback folds. If the switch is pressed again, the seatback unfolds.</p>
	Type D	 <p>Press <sup>2L</sup> switch or <sup>2R</sup> switch, the second row left or right seatback folds. If the switch is pressed again, the seatback unfolds. Press <sup>3L</sup> switch or <sup>3R</sup> switch, the third row left or right seatback folds. If the switch is pressed again, the seatback unfolds.</p>

### **i** Information

When the 6, 7-seater third row seatback is folded, the head restraints are automatically folded. Therefore, lower the head restraint to the lowest position before folding the third row seats. If you want to use the head restraint after unfolding the seatback, raise the head restraint by hand.

When the automatic reverse function is enabled, the angle of the seatback may be changed. Reset the seatback angle by pressing the remote folding/unfolding button.

### **!** WARNING

Do not place any body part or object in the operating area to intentionally check the automatic reverse function.

### **NOTICE**



If there is a problem with the second row and/or third row seat automatic folding/unfolding, a warning will sound. If this occurs, have your vehicle inspected by an authorized retailer of Genesis Branded products.

### **Walk-in seat (7-seater)**

To get in or out of the third row seat:

7-seater

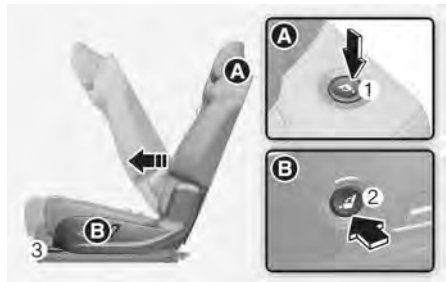

1. Shift the gear to P (Park) and open the rear door.
2. Press the walk-in switch located on the upper part (1) or the outer part (2) of the second row seat.
3. The second row seatback folds and the seat slightly moves forward (3).
4. After getting in or out, push the second row seat to the rearward position and pull the seatback firmly backward until it clicks into place. Make sure that the seat is locked in place.

### **Automatic reverse**

While folding or unfolding the second row or third row seats, when a consistent force is detected, the seat returns to its original position or stops operation.

However, automatic reverse function may not work when the detected resistance is below a specific level or the seat is almost folded or unfolded. When a strong impact is applied to the seat, the automatic reverse function may be activated even if no object is present.

If this occurs, check for objects caught and then operate the switch again to check for abnormality.

### **i** Information

For vehicles with a second row power adjustment seat, if the seat is pushed rearward till it is stopped, the seatback unfolds automatically.

### Folding the rear seats

The rear seatbacks can be folded to facilitate carrying long items or to increase the rear cargo volume in the vehicle.

#### Second row center seatback manual folding (5, 7-seater)



To fold the center seatback:

1. Pull up and hold the lever located behind the seatback.
2. Fold the seatback forward.

#### Second row seatback manual folding (7-seater)

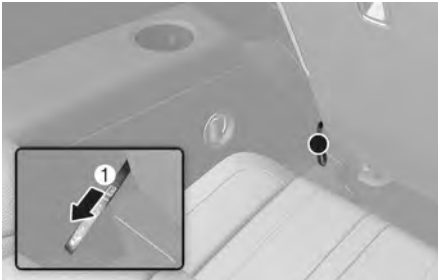

Use the folding strap (1), when the folding switch or walk-in switch does not work.

- Second row manual adjustment seat  
When the strap (1) is pulled, the seatback folds and the seat slightly slides forward.
- Second row power adjustment seat  
When the strap (1) is pulled, the seatback folds.

### Armrest (second row)

5, 7-seater



The armrest is located in the center of the rear seat.

## Head restraint

The vehicle's front and rear (second row and/or third row) seats have adjustable head restraints. The head restraints are designed to help protect passengers from whiplash and other neck and spinal injuries during a collision, especially a rear impact collision. When there are no occupants in the rear seats, adjust the rear head restraints to the lowest height to improve the driver's visibility.

### WARNING

To help reduce the risk of serious injury or death in an accident, take the following precautions when adjusting your head restraints:

- Always adjust the head restraints properly for all passengers BEFORE starting the vehicle.
- Never let anyone ride in a seat with the head restraint removed or reversed.
- Adjust the head restraints so that the middle of the head restraint is at the same height as the top of the eyes.

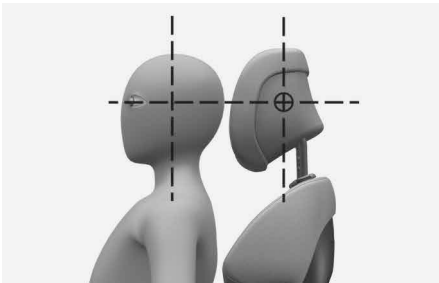

- Never adjust the driver's head restraint when the vehicle is moving.
- Adjust the head restraint as close to the passenger's head as possible.
- Make sure the head restraint is locked in place after adjustment.

### WARNING



When passengers are sitting on the rear seats, always raise the head restraints above the lowest stored position.

### CAUTION

When there is no occupant in the rear seats, adjust the height of the head restraint to the lowest position. The rear seat head restraint can reduce the visibility of the rear area.

### **NOTICE**

To prevent damage, NEVER hit or pull on the head restraints.



### Front seat head restraints

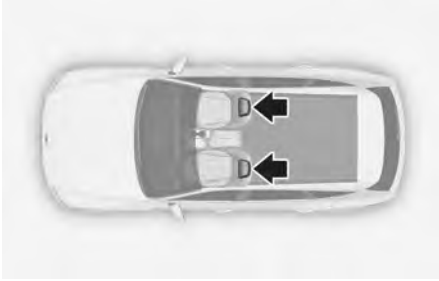

The driver's and front passenger's seats are equipped with adjustable head restraints for passenger safety and comfort.

#### Adjusting the height up and down

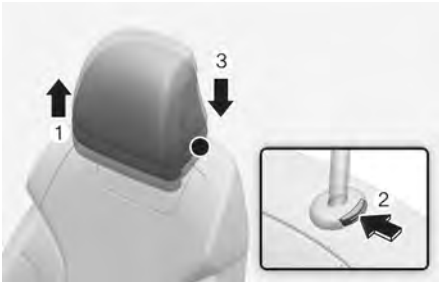

To raise the head restraint:

1. Pull it up to the desired position (1).

To lower the head restraint:

1. Push and hold the release button (2) on the head restraint support.
2. Lower the head restraint to the desired position (3).

### Forward and rearward adjustment



The head restraint may be adjusted forward to 3 different positions by pulling the head restraint forward to the desired detent. To adjust the head restraint to its furthest rearwards position, pull it fully forward to the farthest position and release it.

#### NOTICE



If you recline the seatback towards the front with the head restraint and seat cushion raised, the head restraint may come in contact with the sunvisor or other parts of the vehicle.

### Removal/Reinstall

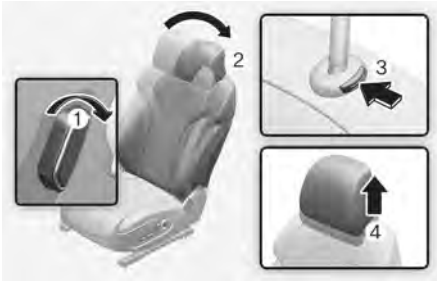

To remove the head restraint:

1. Recline the seatback (2) with the seatback angle switch (1).
2. Raise the head restraint as far as it can go.
3. Press the head restraint release button (3) while pulling the head restraint up (4).



To reinstall the head restraint:

1. Recline the seatback.
2. Put the head restraint poles (2) into the holes while pressing the release button (1).
3. Adjust the head restraint to the appropriate height.
4. Return the seatback (4) with the seatback angle switch (3).

### WARNING

Always make sure the head restraint is locked in place and properly adjusted for the passenger.

### Second row seat head restraints

6-seater



7-seater



The second row seats are equipped with head restraints in all the seating positions for the passenger's safety and comfort.

### Adjusting the height up and down



To raise the head restraint:

1. Pull it up to the desired position (1).

To lower the head restraint:

1. Push and hold the release button (2) on the head restraint support.
2. Lower the head restraint to the desired position (3).

### Removal/Reinstallation



To remove the head restraint:

1. Raise the head restraint as far as it can go.
2. Press the head restraint release button (1) while pulling the head restraint up (2).

To reinstall the head restraint:

1. Put the head restraint poles into the holes (3) while pressing the release button (1).
2. Adjust the head restraint to the appropriate height.

### Wing-out head restraints

**+** if equipped



Grab both sides of the head restraint and pull the head restraint inward.

The head restraint can be adjusted to support your head on the head restraint.

When the head restraint is not in use, return the head restraint to its original position.

### Third row seat head restraints (7-seater)



The third row seats are equipped with head restraints in all the seating positions for the passenger's safety and comfort.

### Removal/Reinstallation

To remove the head restraint:

Pull the head restraint up.

To reinstall the head restraint:

1. Put the head restraint poles into the holes.
2. Push the head restraint down to the desired position.

**⚠ WARNING**

Always make sure the head restraint is locked in place and properly adjusted for the passenger.

---

**Third row seat head restraint folding (infotainment system)**

The third row seat can be folded automatically from the infotainment system.



- Before folding the third row head restraint automatically, lower the head restraint to the lowest position.
- Never fold the third row head restraint manually.
- To use the third row head restraint, unfold the head restraint manually.

***i* Information**

The infotainment system may change after software updates. For more information, refer to the manual provided in the infotainment system and the quick reference guide.

---

**Seat Warmers**

Seat warmers are provided to warm the seats during cold weather.

During mild weather or under conditions where the operation of the seat warmer is not needed, keep the seat warmers off.

**⚠ WARNING**

The seat warmers may cause serious burns, even at low temperatures and especially if used for long periods of time.

Passengers must be able to feel if the seat is becoming too warm so they can turn it off, if needed.

People who cannot detect temperature change or pain to the skin should use extreme caution, especially the following types of passengers:

- Infants, children, elderly or disabled persons, or hospital outpatients.
  - People with sensitive skin or who burn easily.
  - Fatigued individuals.
  - Intoxicated individuals.
  - People taking medication that may cause drowsiness or sleepiness.
- 

**⚠ WARNING**

Never place anything on the seat that insulates against heat when the seat warmer is operating, such as a blanket or seat cushion.

---

**NOTICE**

To prevent damage to the seat warmers and seats:

- Never use a solvent such as paint thinner, benzene, alcohol, or gasoline to clean the seats.
- Do not place heavy or sharp objects on seats equipped with seat warmers.
- Do not change the seat cover.

**Front seat warmers**

1. While the engine is running, press **Front** on the upper part of the climate control information screen.
  - The climate control information screen for the front seats are displayed.
2. Press the button to warm the driver's seat or front passenger's seat.
  - The seat warmer temperature changes from high, medium, low, and to off each time the button is pressed.

**i Information**

- The seat warmer is automatically turned off if the seat temperature goes above a certain level. The seat warmer turns on again if the temperature is low.
- The armrest warmer automatically turns on when the function is enabled from the infotainment system and the seat warmer turns on. (if equipped)

- Automatic Controls Linked to Climate Control Settings (for driver's seat)

The seat warmer automatically controls the seat temperature depending on the ambient temperature when the engine is running.

To use this function, enable it from the Settings menu in the infotainment system. Select:

- **Setup > Vehicle > Seat > Warmer/Ventilated Features (or Heating/Ventilation) > Automatic Controls Linked to Climate Control Settings > Driver Seat Warmer/Ventilation (or Seat heating/ventilation)**

- Seat Heater Balance

The seat warmer temperature can be adjusted or turned off for the seatback or seat cushion, when the seat warmer is on.

To use this function, enable it from the Settings menu in the infotainment system. Select:

- **Setup > Vehicle > Seat > Warmer/Ventilated Features (or Heating/Ventilation) > Seat Warmer Balance (or Seat heater balance)**
- The seat warmer defaults to the OFF position whenever the Engine Start/ Stop button is pressed to the ON position. However, if the Automatic Controls Linked to Climate Control Settings function is on, the driver's seat warmer turns on and off depending on the ambient temperature.

**i Information**

The infotainment system may change after software updates. For more information, refer to the user's manual provided in the infotainment system and the quick reference guide.

### Second row seat warmers

 if equipped

Type A



Type B



While the engine is running, press the button to warm the rear seats.

- The seat warmer temperature changes from high, medium, low, and to off each time the button is pressed.

#### *i* Information

- The seat warmer temperature is lowered automatically after a certain time to prevent low temperature burn.
- The seat warmer defaults to the OFF position whenever the Engine Start/Stop button is in the ON position.

### Operating the rear seat warmer from the front seat

 if equipped



Rear seat heaters can be turned on or off from the front seats.

1. Press **2nd** or **Rear** on the upper part of the climate control information screen while the engine is running.
  - The climate control information screen for the rear seats are displayed.
2. Press the button next to the seat which requires heating from the climate control information screen.
  - The temperature changes from high, medium, low, and to off each time the button is pressed.

## Air Ventilation Seats

The air ventilation seats cool the front seats by blowing air through small vent holes on the surface of the seat cushions and seatbacks.

When air ventilation is not desired, keep the air ventilation seats off.

### NOTICE

To prevent damage to the air ventilation seats:

- Never use a solvent such as paint thinner, benzene, alcohol or gasoline to clean the seats.
- Avoid spilling liquids on the surface of the front seats and seatbacks. This may cause the air vent holes to become blocked and not work properly.
- Do not place materials such as plastic bags or newspapers under the seats. They may block the air intake causing the air vents not to work properly.
- Do not change the seat covers.
- If the air vents do not operate, restart the vehicle. If there is no change, have your vehicle inspected by an authorized retailer of Genesis Branded products.

### Front air ventilation seats

 if equipped



1. While the engine is running, press **Front** on the upper part of the climate control information screen.

- The climate control information screen for the front seats are displayed.

2. Press the button to cool the driver's seat or front passenger's seat.

- The fan speed changes from high, medium, low, and to off each time the button is pressed.

### Information

- If the air ventilation seat is positioned to high, fan speed increases depending on the vehicle speed and driving time.
- Use the air ventilation seat with the air conditioning on for more effective ventilation.
- After the air ventilation seat is turned on, it takes 3-5 minutes for the passengers to notice the temperature change.

- Automatic Controls Linked to Climate Control Settings (for driver's seat)

The air ventilation seat automatically controls the seat temperature depending on the ambient temperature when the engine is running.

To use this function, enable it from the Settings menu in the infotainment system. Select:

- **Setup > Vehicle > Seat > Heated/Ventilated Features > Automatic Controls Linked to Climate Control Settings > Driver Seat Warmer/Ventilation (or Seat heating/ventilation)**

- The air ventilation seats default to the OFF position whenever the Engine Start/Stop button is pressed to the ON position. However, if the Automatic Controls Linked to Climate Control Settings function is on, the driver's air ventilation seat turns on and off depending on the ambient temperature.

## *i* Information

The infotainment system may change after software updates. For more information, refer to the user's manual provided in the infotainment system and the quick reference guide.

### Second row air ventilation seats

**+** if equipped



While the engine is running, press the button to cool the seat.

- The fan speed changes from high, medium, low, and to off each time the button is pressed.

## *i* Information

- If the air ventilation seat is positioned to high, fan speed increases depending on the vehicle speed and driving time.
- Use the air ventilation seat with the air conditioning on for more effective ventilation.
- After the air ventilation seat is turned on, it takes 3-5 minutes for the passengers to notice the temperature change.
- The air ventilation seat defaults to the OFF position whenever the Engine Start/Stop button is pressed to the ON position.

### Operating the rear ventilation seat from the front seat

**+** if equipped



Rear seat air ventilation can be turned on or off from the front seats.

1. Press **2nd** or **Rear** on the upper part of the climate control information screen while the engine is running.
  - The climate control information screen for the rear seats are displayed.
2. Press button next to the seat which requires ventilating from the climate control information screen.
  - The fan speed changes from high, medium, low, and to off each time the button is pressed.



## Seat Belts

### Seat Belt Safety Precautions

Always fasten your seat belt and make sure all passengers have fastened their seat belts before starting any trip. Airbags are designed to supplement the seat belt as an additional safety device, but they are not a substitute. Most states require all occupants of a vehicle to wear seat belts.

#### WARNING

Seat belts must be used by ALL passengers whenever the vehicle is moving. To prevent serious injury or death:

- Children under the age of 13 should be properly restrained in the rear seats.
- Never allow children to ride in the front passenger seat, unless the airbag is deactivated. If a child age 13 or older must be seated in the front passenger seat, move the seat as far back as possible. And the child must always be restrained in the seat properly.
- Never allow an infant or child to be carried on an occupant's lap.
- Never ride with the seatback reclined when the vehicle is moving.
- Do not allow children to share a seat or seat belt.
- Do not wear the shoulder belt under your arm or behind your back.
- Do not use the seat belt if it is twisted. A twisted seat belt may not protect you properly in an accident.
- Do not latch the seat belt into the buckles intended for other seating positions.
- Never unfasten the seat belt while driving. This may cause loss of vehicle control resulting in a collision.

- Make sure there is nothing in the buckle that could interfere with the seat belt latch mechanism from fastening securely.
- Never modify seat belt or install devices that may prevent seat belt assembly from removing slack.
- Do not use a seat belt if the webbing or hardware is damaged. Have the seat belt be replaced by an authorized retailer of Genesis Branded products.

#### WARNING

Damaged seat belts and seat belt assemblies do not operate properly. Always replace:

- Frayed, contaminated, or damaged webbing.
- Damaged hardware.
- The entire seat belt assembly after it has been worn in an accident, even if damage to webbing or assembly is not apparent.

## Seat Belt Warning Light

Instrument cluster



### ***Driver's seat belt warning***

As a reminder to the driver, the seat belt warning light illuminates for about 6 seconds each time the Engine Start/Stop button is in the ON position regardless of seat belt fastening.

If the seat belt is not fastened, when vehicle speed is between 5.5 mph (9 km/h) and 12 mph (20 km/h) the warning light will continue to illuminate and warning chime will sound until the seat belt is fastened.

If the seat belt is not fastened, when vehicle speed is above 12 mph (20 km/h), the warning light will blink and warning chime will sound for approximately 100 seconds (warning chime will sound in three stages).

### ***Front passenger's seat belt warning***

As a reminder to the front passenger, the front passenger's seat belt warning light illuminates for about 6 seconds each time the Engine Start/Stop button is in the ON position regardless of seat belt fastening.

If the seat belt is not fastened, when vehicle speed is between 5.5 mph (9 km/h) and 12 mph (20 km/h) the warning light will continue to illuminate and warning chime will sound until the seat belt is fastened.

If the seat belt is not fastened, when vehicle speed is above 12 mph (20 km/h), the warning light will blink and warning chime will sound for approximately 100 seconds (warning chime will sound in three stages).

### ***! WARNING***

Riding in an improper position may adversely affect the front passenger's seat belt warning system. Instruct the passenger to properly be seated when the vehicle is moving.

### ***i Information***

- Although the front passenger seat is not occupied, the seat belt warning light blinks or illuminates for 6 seconds.
- The front passenger's seat belt warning may operate when luggage is placed on the front passenger seat.

### Rear passenger's seat belt warning

**+** if equipped

5-seater



7-seater



### 2nd row outboard seat and 3rd row seat seat belt

As a reminder to the rear seat passengers, with the Engine Start/Stop button in the ON position, if the rear seat passenger's seat belt is not fastened, the corresponding seat belt warning light will illuminate for 70 seconds. But, if the seatbelt is fastened after 6 seconds, the corresponding seat belt warning light will immediately turn off.

If the seat belt is fastened, and then unfastened while driving below 12 mph (20 km/h), the corresponding seat belt warning light will illuminate for 70 seconds.

If the seat belt is fastened, and then unfastened while driving above 12 mph (20 km/h), the corresponding seat belt warning light will blink and the warning chime will sound for approximately 35 seconds.

### Second row center seat belt

**+** if equipped

With the Engine Start/Stop button in the ON position, if the second row center seat passenger's seat belt is not fastened, the corresponding seat belt warning light will illuminate for 70 seconds. But, if the seatbelt is fastened after 6 seconds, the corresponding seat belt warning light will immediately turn off.

If the seat belt is fastened, and then unfastened while driving below 12 mph (20 km/h), the corresponding seat belt warning light will illuminate for 70 seconds.

If the seat belt is fastened, and then unfastened while driving above 12 mph (20 km/h), the corresponding seat belt warning light will blink and the warning chime will sound for approximately 35 seconds.

## Seat Belt Restraint System

### **WARNING**



Improperly positioned seat belts may increase the risk of serious injury in an accident. Take the following precautions when adjusting the seat belt:

- Position the lap portion of the seat belt as low as possible across your hips, not on your waist, so that it fits snugly. This allows your strong pelvic bones to absorb the force of a collision, reducing the chance of internal injuries.
- Position one arm under the shoulder belt and the other over the belt, as shown in the illustration.
- Always position the shoulder belt anchor into the locked position at an appropriate height.
- Never position the shoulder belt across your neck or face.

### *Lap/shoulder belt*

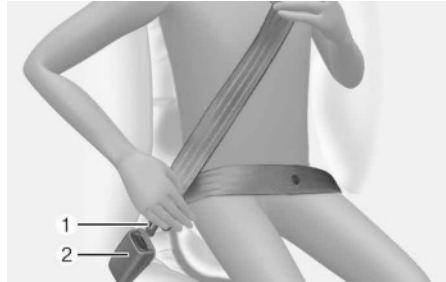

#### **To fasten your seat belt:**

Pull the seat belt out of the retractor and insert the metal tab (1) into the buckle (2). An audible “click” sounds when the tab locks into the buckle. Make sure the seat belt is not twisted.



Place the lap belt (1) portion across your hips and the shoulder belt (2) portion across your chest.

The seat belt automatically adjusts to the proper length after the lap belt portion is adjusted manually so that it fits snugly around your hips. If you lean forward in a slow, easy motion, the belt extends and moves with you.

If there is a sudden stop or collision, the belt is locked in place. It also locks if you try to lean forward too quickly.

**NOTICE**

If you cannot smoothly pull the seat belt out from the retractor, firmly pull the seat belt out and release it. After release, the belt may be pulled out smoothly.

**Height adjustment**

Adjust the height of the shoulder belt so that it lies across your chest and midway over your shoulder nearest the door, not over your neck.

Front seat

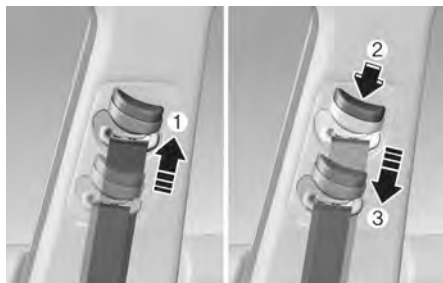

To adjust the height of the seat belt anchor:

Pull it up (1) to raise the height. To lower it, push it down (3) while pressing the height adjuster button (2).

Release the button to lock the anchor in place. Try pushing the height adjuster down to make sure that it is locked in place.

**To release your seat belt:**

Press the release button (1) in the locking buckle.

The belt should automatically draw back into the retractor. If this does not happen, check the belt to be sure it is not twisted, then try again.

**Rear Seat Belt – Passenger's 3point system with convertible locking retractor**

This type of seat belt combines the features of both an emergency locking retractor seat belt and an automatic locking retractor seat belt. Convertible retractor type seat belts are installed in the rear seat positions to help accommodate the installation of child restraint systems.

Although a convertible retractor is also installed in the front passenger seat position, NEVER place any infant/child restraint system in the front seat of the vehicle.

**To fasten your seat belt:**

Pull the seat belt out of the retractor and insert the metal tab into the buckle. There will be an audible “click” when the tab locks into the buckle. When not securing a child restraint, the seat belt operates in the same way as the driver's seat belt (Emergency Locking Retractor Type). It automatically adjusts to the proper length only after the lap belt portion of the seat belt is adjusted manually so that it fits snugly across your hips.

When the seat belt is fully extended from the retractor to allow the installation of a child restraint system, the seat belt operation changes to allow the belt to retract, but not to extend (Automatic Locking Retractor Type). Refer to the “Using a Child Restraint System” section in this chapter.

**To release your seat belt:**



Press the release button (1) in the locking buckle.

When it is released, the belt should automatically draw back into the retractor. If this does not happen, check the belt to be sure it is not twisted, then try again.

**NOTICE**

Although the seat belt retractor provides the same level of protection for seated passengers in either emergency or automatic locking modes, the emergency locking mode allows seated passengers to move freely in their seat while keeping some tension on the belt. During a collision or sudden stop, the retractor automatically locks the belt to help restrain your body. To deactivate the automatic locking mode, unbuckle the seat belt and allow the belt to fully retract.

**Second row center seat belt (3-point rear center seat belt) (5, 7-seater)**

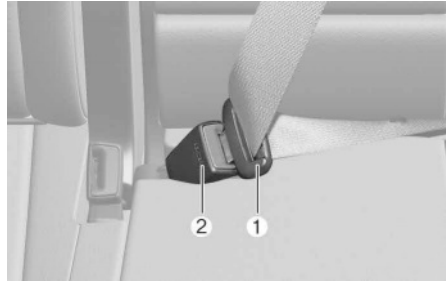

Insert the tongue plate (1) into the buckle (2) until an audible "click" is heard, indicating the latch is locked. Pull the shoulder portion of the belt to snug the belt across your hips and remove slack. Make sure the seat belt is not twisted.

When using the rear center seat belt, use the buckle with the "CENTER" mark.

**i Information**

If you cannot pull out the safety belt from the retractor, firmly pull the belt out and release it. After release, pull out the belt smoothly.

**⚠ WARNING**

Make sure the seatback is locked in place when using the rear center seat belt.

If not secure, the seatback may move if there is a sudden stop or collision and result in serious injury or death.

### Pretensioner seat belt



Your vehicle is equipped with driver's, front passenger's and second row outboard seat passengers' (except for the rear center seat) pretensioner seat belts (retractor pretensioner). The pretensioner makes sure the seat belts fit tightly against your body in certain frontal or side collision(s). The pretensioner seat belts may be activated in some crashes where the frontal or side collision(s) is severe enough, together with the airbags.

When the vehicle stops suddenly, or if you try to lean forward too quickly, the seat belt retractor locks in place. In some frontal collisions, the pretensioner activates and pulls the seat belt against your body.

If the system senses excessive tension on the driver or passenger's seat belt when the pretensioner system activates, the load limiter inside the retractor pretensioner releases some of the pressure on the affected seat belt. (for vehicles equipped with load limiter)

#### WARNING

To prevent serious injury or death:

- Always wear your seat belt and sit properly in your seat.
- Do not use the seat belt if it is loose or twisted.
- Do not place anything near the buckle.
- Always replace your pretensioner after activation or an accident.
- Have the pretensioner inspected, serviced, repaired, or replaced by an authorized retailer of Genesis Branded products.
- Do not hit the seat belt assemblies.

#### WARNING

Do not touch the pretensioner seat belt assemblies for several minutes after they have been activated. When the pretensioner seat belt mechanism deploys during a collision, the pretensioner can become hot and can burn you.

#### WARNING

Have the system serviced by an authorized retailer of Genesis Branded products. Body work on the front of the vehicle may damage the pretensioner seat belt system.

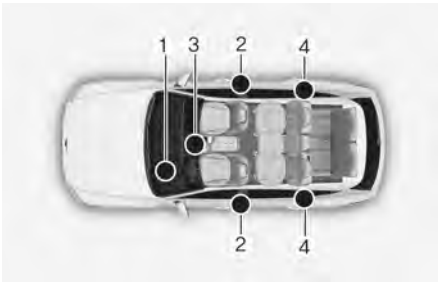

The Pretensioner Seat Belt System consists mainly of the following components. Their locations are shown in the illustration above:

- (1) SRS airbag warning light
- (2) Front retractor pretensioner
- (3) SRS control module
- (4) Rear retractor pretensioner

### NOTICE

The sensor that activates the SRS control module is connected with the pretensioner seat belts. The SRS airbag warning light on the instrument cluster illuminates for about 3-6 seconds after the Engine Start/Stop button is in the ON position, and then it turns off.

If the pretensioner is not working properly, the warning light illuminates even if the SRS airbag is not malfunctioning. If the warning light does not illuminate when starting the engine or stays illuminated or illuminates while driving, have the pretensioner seat belts and/or SRS control module inspected by an authorized retailer of Genesis Branded products as soon as possible.

### i Information

- The pretensioner seat belts may be activated in certain frontal or side collisions or rollover situations (if equipped with rollover sensor).
- When the pretensioner seat belts are activated, a loud noise may be heard and fine dust, which may appear to be smoke, may be visible in the passenger compartment.
- Although it is non-toxic, the fine dust may cause skin irritation and should not be inhaled for prolonged periods. Wash all exposed skin areas thoroughly after an accident in which the pretensioner seat belts were activated.

### Pre-Active Seat Belt (PSB)

**+ if equipped**

The purpose of the Pre-Active Seat Belt is to tighten the seat belt when a collision is sensed, during emergency braking, or when a loss of control is sensed.

### NOTICE

Pre-Active Seat Belt is a supplementary system. Pre-Active Seat Belt activates only when the passenger is wearing his/her seat belt.

### Pre-Active Seat Belt operation

In order to maximize the safety of the passenger, Pre-Active Seat Belt system operates as below:

- Full retraction
  - The seat belt is tightened when:
    - Emergency braking situation occurs
    - Losing control of the vehicle
    - The vehicle detects a collision
    - Driving on a slippery frozen road
    - Unstable rolling of the vehicle occurs



- Slack removal  
Tightens a loose seat belt if vehicle speed is over 9.3 mph (15 km/h).
- Belt parking  
Tightens a loose seat belt when the seat belt is unfastened.

### **Warning message**

The "**Check Pre-active Seat Belt**" warning message appears if there is a problem with your Pre-Active Seat Belt.

Have the system inspected by an authorized retailer of Genesis Branded products if the warning message comes on while the vehicle is moving. When the Pre-Active Seat Belt warning message disappears, the master warning light (⚠) illuminates.

## **Additional Seat Belt Safety Precautions**

### **Seat belt use during pregnancy**

The seat belt should always be used during pregnancy. The best way to protect your unborn child is to protect yourself by always wearing the seat belt.

Pregnant women should always wear a lap-shoulder seat belt. Place the shoulder belt across your chest, routed between your breasts and away from your neck. Place the lap belt below your belly and pull the shoulder portion so that it fits SNUGLY across your hips and pelvic bone, under the rounded part of your belly.

### **⚠ WARNING**

- Pregnant women and patients are more vulnerable to any impacts on the abdomen during an abrupt stop or collision. If you are in an accident while pregnant, consult your doctor.
- To reduce the risk of serious injury or death to an unborn child during an accident, pregnant women should NEVER place the lap portion of the seat belt above or over the area of the abdomen where the unborn child is located.

### **Seat belt use and children**

#### **Infant and small children**

All 50 states have Child Restraint System laws that require children to travel in approved Child Restraint System devices, including booster seats. The age at which seat belts can be used instead of Child Restraint System differs among states, so you should be aware of the specific requirements in your states, and where you are travelling. Infant and Child Restraint System must be properly placed and installed in a rear seat.

For more information, refer to the "Child Restraint System (CRS)" section in this chapter.

### **⚠ WARNING**

Always properly restrain infants and small children in a Child Restraint System appropriate for the child's height and weight.

To reduce the risk of serious injury or death to a child and other passengers. Never hold a child in your lap or arms when the vehicle is moving. Violent forces created during a collision will tear the child from your arms and throw the child against the interior or to be ejected from the vehicle.

Small children are best protected from injury in an accident when properly restrained in the rear seat by a Child Restraint System that meets the requirements of the Federal Motor Vehicle Safety Standards. Before buying any Child Restraint System, make sure that it has a label certifying that it meets the Federal Motor Vehicle Safety Standards FMVSS 213.

The Child Restraint System must be appropriate for your child's height and weight. Check the label on the Child Restraint System for this information. Refer to the "Child Restraint System (CRS)" section in this chapter.

### Larger children

Children under age 13 and who are too large for a booster seat should always occupy the rear seat and use the available lap/shoulder belts. A seat belt should lie across the upper thighs and be snug across the shoulder and chest to restrain the child safely. Check belt fit periodically. A child's squirming could put the belt out of position. In the event of an accident, children are afforded the best safety restrained by a proper Child Restraint System in the rear seats. Always have the LATCH system inspected by your authorized retailer of Genesis Branded products after an accident. An accident can damage the LATCH system and may not properly secure the child restraint.

If a larger child over age 13 must be seated in the front seat, the child must be securely restrained by the available seat belt and the seat should be placed in the rearmost position.

If the shoulder belt portion slightly touches the child's neck or face, try placing the child closer to the center of the vehicle. If the shoulder belt still touches their face or neck, the child needs to return to an appropriate booster seat in the rear seat.

### WARNING

- Always make sure larger children's seat belts are buckled and properly adjusted.
- Never allow the shoulder belt to contact the child's neck or face.
- Do not allow more than one child to use a single seat belt.

### *Transporting an injured person*

A seat belt should still be used when an injured person is being transported. Consult a physician for specific recommendations.

### *One person per belt*

When two people (children or adults) are sitting together, never attempt to use a single seat belt. This could increase the severity of injuries in a collision.

### *Do not lie down*

Sitting in a reclined position when the vehicle is moving, can be dangerous. Even when buckled up, the protections of your restraint system (seat belts and/or airbags) is greatly reduced by reclining your seatback.

Seat belts must be snug against your hips and chest to work properly.

During a collision, you could be thrown into the seat belt, causing neck or other injuries.

The more the seatback is reclined, the greater the chance for the passenger's hips to slide under the lap belt or the passenger's neck to strike the shoulder belt.

**⚠ WARNING**

- Never ride with a reclined seatback when the vehicle is moving.
- Riding with a reclined seatback increases your chance of serious or fatal injuries in the event of a collision or sudden stop.
- The driver and all passengers should always sit well back in their seats, properly belted, and with the seatbacks upright.

**Care of Seat Belts**

Seat belt systems should never be disassembled or modified. In addition, care should be taken to assure that seat belts and belt hardware are not damaged by seat hinges, doors or other abuse.

***Periodic inspection***

All seat belts should be inspected periodically for wear or damage of any kind. Any damaged parts should be replaced as soon as possible by an authorized retailer of Genesis Branded products.

***Keep belts clean and dry***

Seat belts should be kept clean and dry. If belts become dirty, they can be cleaned by using a mild soap solution and warm water. Bleach, dye, strong detergents, or abrasives should not be used because they may damage and weaken the fabric.

***When to replace seat belts***

The entire seat belt assembly or assemblies should be replaced if the vehicle has been involved in an accident. This should be done even if no damage is visible. Consult an authorized retailer of Genesis Branded products for assistance.

**Child Restraint System (CRS)****Children Always in the Rear****⚠ WARNING**

Always properly restrain children in the rear seats of the vehicle. Children of all ages are safer when restrained in the rear seats. A child riding in the front passenger seat can be forcefully struck by an inflating airbag resulting in SERIOUS INJURY or DEATH.

Children under age 13 should always ride in the rear seats and must always be properly restrained to minimize the risk of injury in an accident, sudden stop or sudden maneuver.

According to accident statistics, children are safer when properly restrained in the rear seats than in the front seat. Even with air bags, children can be seriously injured or killed. Children too large for a Child Restraint System must use the seat belts provided.

All 50 states have child restraint laws which require children to travel in approved Child Restraint Systems.

The laws governing the age or height/weight restrictions at which seat belts can be used instead of Child Restraint System differs among states, so you should be aware of the specific requirements in your state, and where you are traveling.

Child Restraint Systems must be properly placed and installed in the rear seat. You must use a commercially available Child Restraint System that meets the requirements of the Federal Motor Vehicle Safety Standards (FMVSS 213).

Child Restraint Systems are generally designed to be secured in a vehicle seat by lap belt portion of a lap/shoulder belt, or by a LATCH system in the rear seats of the vehicle.

### **Child Restraint System**

Infants and younger children must be restrained in an appropriate rearward-facing or forward-facing CRS that has first been properly secured to the seats of the vehicle. Read and comply with the instructions for installation and use provided by the manufacturer of the Child Restraint System.

#### **WARNING**

An improperly secured child restraint can increase the risk of **SERIOUS INJURY** or **DEATH** in an accident. Always take the following precautions when using a Child Restraint System:

- NEVER install a child or infant restraint in the front passenger's seat.
- Always properly secure the child restraint to a rear seat of the vehicle.
- Always follow the child restraint system manufacturer's instructions for installation and use.
- Always properly restrain your child in the child restraint.
- If the vehicle head restraint prevents proper installation of a child seat (as described in the child restraint system manual), the head restraint of the respective seating position shall be readjusted or entirely removed.
- Do not use an infant carrier or a child safety seat that "hooks" over a seatback, it may not provide adequate protection in an accident.
- After an accident, have an authorized retailer of Genesis Branded products check the child restraint system, seat belts, tether anchors and lower anchors.

### **Selecting a Child Restraint System**

When selecting a Child Restraint System for your child, always:

- Make sure the Child Restraint System has a label certifying that it meets applicable Federal Motor Vehicle Safety Standards (FMVSS 213).
- Select a Child Restraint System based on your child's height and weight. The required label or the instructions for use typically provide this information.
- Select a Child Restraint System that fits the vehicle seating position where it is to be used.
- Read and comply with the warnings and instructions for installation and use provided with the Child Restraint System.

### Child Restraint System types

There are three main types of Child Restraint Systems: rearward-facing, forward-facing, and booster seat Child Restraint Systems. They are classified according to the child's age, height, and weight.

#### Rearward-facing Child Restraint System



With a rearward-facing Child Restraint System, the collision forces are absorbed by its shell instead of the child's body. The shell also supports the system's cradles and protects the head, neck and spine of the child. All children under the age of one year must always ride in a rearward-facing Child Restraint System. Convertible and 3-in-1 Child Restraint Systems typically have higher height and weight limits for the rearward-facing position, allowing you to keep your child rearward-facing for a longer period of time.

Continue using the Child Restraint Systems in the rearward-facing position as long as the child is within the height and weight limits allowed by the Child Restraint System's manufacturer. It's the best way to keep them safe. Once your child has outgrown the rearward-facing Child Restraint System, your child is ready for a forward-facing Child Restraint System with a harness.

### WARNING

NEVER install a child or infant restraint in the front passenger's seat.

Placing a rearward-facing child restraint in the front seat can result in SERIOUS INJURY or DEATH if the child restraint is struck by an inflating air bag.

#### Forward-facing Child Restraint System



A forward-facing Child Restraint System provides restraint for the child's body with a harness. Keep children in a forward-facing Child Restraint System with a harness until they reach the height or weight limit allowed by your Child Restraint System's manufacturer.

Once your child outgrows the forward-facing Child Restraint System, your child is ready for a booster seat.

### Booster seats

A booster seat is a Child Restraint System designed to improve the fit of the vehicle's seat belt system. A booster seat positions the seat belt so that it fits properly over the stronger parts of your child's body. Keep your children in booster seats until they are big enough to fit in a seat belt properly.

For a seat belt to fit properly, the lap belt must lie snugly across the upper thighs, not the stomach. The shoulder belt should lie snug across the shoulder and chest and not across the neck or face. Children under age 13 must always be properly restrained to minimize the risk of injury in an accident, sudden stop, or sudden maneuver.

## Installing a Child Restraint System

### WARNING

Before installing your Child Restraint System, always read and follow the instructions provided by the manufacturer of the Child Restraint System and in this manual to prevent serious injury or death if a collision occurs.

---

### WARNING

If the vehicle head restraint prevents proper installation of a Child Restraint System (as described in the Child Restraint System manual), readjust or remove the head restraint for that seating position.

---

After selecting a proper Child Restraint System for your child and checking that the Child Restraint System fits properly in a seating position, there are three general steps for a proper installation:

- **Properly secure the Child Restraint System to the vehicle.** All Child Restraint Systems must be secured to the vehicle with the lap belt or lap part of a lap/shoulder belt or with the LATCH top tether and/or LATCH anchorage and/or with a support leg.
- **Make sure the Child Restraint System is firmly secured.** After installing a Child Restraint System in the vehicle, push and pull the seat forward and from side-to-side to verify that it is securely attached to the seat. A Child Restraint System secured with a seat belt should be installed as firmly as possible. However, some side-to-side movement can be expected.

When installing a Child Restraint System, adjust the vehicle seat and seatback (up and down, forward and rearward) so that your child fits in the Child Restraint System in a comfortable manner.

- **Secure the child in the Child Restraint System.** Make sure the child is properly strapped in the Child Restraint System according to the Child Restraint System manufacturer's instructions.

### CAUTION

Check the seating surface and buckles before placing your child in the Child Restraint System to prevent burns. A Child Restraint System in a closed vehicle can become very hot.

---

### **Lower Anchors and Tether for Children (LATCH System)**

The LATCH system holds a Child Restraint System during driving and in an accident. This system is designed to make installation of the Child Restraint System easier and reduce the possibility of improperly installing your Child Restraint System. The LATCH system uses anchors in the vehicle and attachments on the Child Restraint System. The LATCH system eliminates the need to use seat belts to secure the Child Restraint System to the rear seats.

Lower anchors are metal bars built into the vehicle. There are two lower anchors for each LATCH seating position that will accommodate a Child Restraint System with lower attachments.

To use the LATCH system in your vehicle, you must have a Child Restraint System with LATCH attachments.

The Child Restraint System manufacturer will provide you with instructions on how to use the Child Restraint System with its attachments for the LATCH lower anchors.

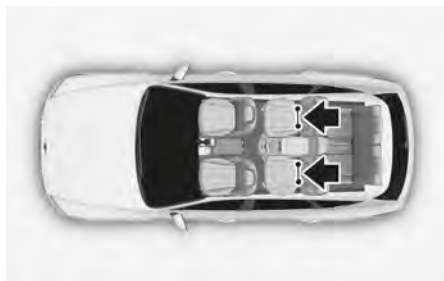

LATCH anchors have been provided in the left and right outboard rear seating positions. Their locations are shown in the illustration.

There are no LATCH anchors provided for the center rear seating position.

### **⚠ WARNING**

Do not attempt to install a Child Restraint System using LATCH anchors in the rear center seating position. There are no LATCH anchors provided for this seat. Using the outboard seat anchors can damage the anchors which may break or fail in a collision resulting in serious injury or death.

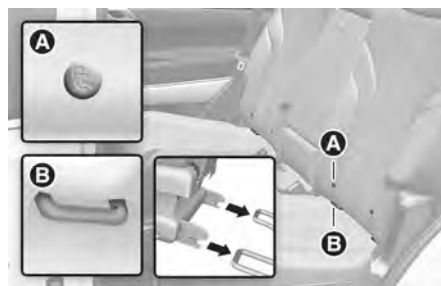

[A] Lower Anchor Position Indicator  
[B] Lower Anchor

The lower anchor position indicator symbols are located on the left and right rear seat backs to identify the position of the lower anchors in your vehicle (see arrows in illustration).

The LATCH anchors are located between the seatback and the seat cushion of the rear seat left and right outboard seating positions.

### **⚠ WARNING**

Before installing the Child Restraint System, make sure that there are no objects (for example, toy, pen, wire) around the lower anchor area. Those objects may damage either the seat belt system or the Child Restraint System during the installment procedure. If necessary, have the vehicle inspected by an authorized retailer of Genesis Branded products.

### **Securing a Child Restraint System with the "LATCH Anchors System"**

To install a LATCH-compatible Child Restraint System in either of the rear outboard seating positions:

1. Move the seat belt buckle away from the lower anchors.
2. Move any other objects away from the anchors that could prevent a secure connection between the Child Restraint System and the lower anchors.
3. Place the Child Restraint System on the vehicle seat, then attach the seat to the lower anchors according to the instructions provided by the Child Restraint System manufacturer.
4. Follow the instructions of the Child Restraint System's manufacturer for proper installation and connection of the lower attachments on the Child Restraint System to the lower anchors.

### **⚠ WARNING**

Take the following precautions when using the LATCH system:

- Read and follow all installation instructions provided with your Child Restraint System.
- To prevent the child from reaching and taking hold of unretracted seat belts, buckle all unused rear seat belts and retract the seat belt webbing behind the child. Children can be strangled if a shoulder belt becomes wrapped around their neck and the seat belt tightens.
- NEVER attach more than one Child Restraint System to a single anchor. This could cause the anchor or attachment to come loose or break.
- Always have the LATCH system inspected by your authorized retailer of Genesis Branded products after an accident. An accident can damage the LATCH system and may not properly secure the Child Restraint System.

### **NOTICE**

The recommended weight for the LATCH system is under 65 lb. (30 kg).

How to determine an appropriate child restraint weight:  $\text{Child weight} + \text{Child restraint weight} < 65 \text{ lb. (30kg)}$ .

### **Securing a Child Restraint System seat with "Tether Anchor" system**



First secure the child restraint with the LATCH lower anchors or the seat belt. If the child restraint manufacturer recommends that the top tether strap be attached, attach and tighten the top tether strap to the top tether strap anchor.

Child restraint hook holders are located on the rear of the seatbacks.





To install the tether anchor:

1. Route the Child Restraint System top-tether strap over the seatback. Route the tether strap under the head restraint and between the head restraint posts, or route the tether strap over the top of the vehicle seatback. Make sure the strap is not twisted.
2. Connect the tether strap hook to the tether anchor, then tighten the top-tether strap according to the instructions of your Child Restraint System's manufacturer to firmly attach the Child Restraint System to the seat.
3. Check that the Child Restraint System is securely attached to the seat by pushing and pulling the seat forward-and-back and side-to-side.

### WARNING

Take the following precautions when installing the tether strap:

- Read and follow all installation instructions provided with your Child Restraint System.
- NEVER attach more than one Child Restraint System to a single tether anchor. This could cause the anchor or attachment to come loose or break.
- Do not attach the tether strap to anything other than the correct top-tether anchor. It may not work properly if attached to something else.
- Child Restraint System anchors are designed to withstand only those loads imposed by correctly fitted Child Restraint System.  
Do not use them for adult seat belts, harnesses, or for attaching other items or equipment to the vehicle.

### ***Securing a Child Restraint System with a lap/shoulder belt***

When not using the LATCH system, all Child Restraint Systems must be secured to a rear seat using the lap part of a lap/shoulder belt.

### WARNING

ALWAYS place a rearward-facing Child Restraint System in the rear seat of the vehicle.

Placing a rearward-facing child restraint in the front seat can result in serious injury or death if the Child Restraint System is struck by an inflating air bag.

### Automatic locking mode



Since all passenger seat belts move freely under normal conditions and only lock under extreme or emergency conditions (emergency locking mode), you must manually pull the seat belt all the way out to shift the retractor to the "Automatic Locking" mode to secure a Child Restraint System.

The "Automatic Locking" mode will help prevent the normal movement of the child in the vehicle from causing the seat belt to loosen and compromise the Child Restraint System. To secure a Child Restraint System, use the following procedure.

To install a Child Restraint System on the rear seats:

1. Place the Child Restraint System on a rear seat and route the lap/shoulder belt around or through the Child Restraint System, following the Child Restraint System manufacturer's instructions. Make sure the seat belt webbing is not twisted.



### *i* Information

When using the rear center seat belt, you should also refer to the "Rear Seat Belt – Passenger's 3-point system" section in this chapter.

2. Fasten the lap/shoulder belt latch into the buckle. Listen for the distinct "click" sound.



### *i* Information

Position the release button so it is easy to access in an emergency.

3. Pull the shoulder portion of the seat belt all the way out. When the shoulder portion of the seat belt is fully extended, it will shift the retractor to the "Automatic Locking" (child restraint) mode.



4. Slowly allow the shoulder portion of the seat belt to retract and listen for an audible "clicking" or "ratcheting" sound. This indicates that the retractor is in the "Automatic Locking" mode. If no distinct sound is heard, repeat steps 3 and 4.



5. Remove as much slack from the belt as possible by pushing down on the Child Restraint System while feeding the shoulder belt back into the retractor.
6. Push and pull on the Child Restraint System to confirm that the seat belt is holding it firmly in place. If it is not, release the seat belt and repeat steps 2 through 6.

7. Double check that the retractor is in the "Automatic Locking" mode by attempting to pull more of the seat belt out of the retractor. If you cannot, the retractor is in the "Automatic Locking" mode.

If your Child Restraint System manufacturer instructs or recommends you to use a tether anchor with the lap/shoulder belt, refer to the previous pages for more information.

### Information

When the seat belt is allowed to retract to its fully stowed position, the retractor will automatically switch from the "Automatic Locking" mode to the emergency lock mode for normal adult usage.

---

### WARNING

If the retractor is not in the "Automatic Locking" mode, the child restraint can move when your vehicle turns or stops suddenly. A child can be seriously injured or killed if the child restraint is not properly anchored in the car, including manually pulling the seat belt all the way out to shift the retractor to the "Automatic Locking" mode.

---

To remove the Child Restraint System, press the release button on the buckle and then pull the seat belt out of the Child Restraint System and allow the seat belt to retract fully.

### WARNING

If a child restraint is installed in the second row center seat, move the second row seat far back as possible, to minimize contact with the front center side airbag.

---

## Supplemental Restraint System - Airbags

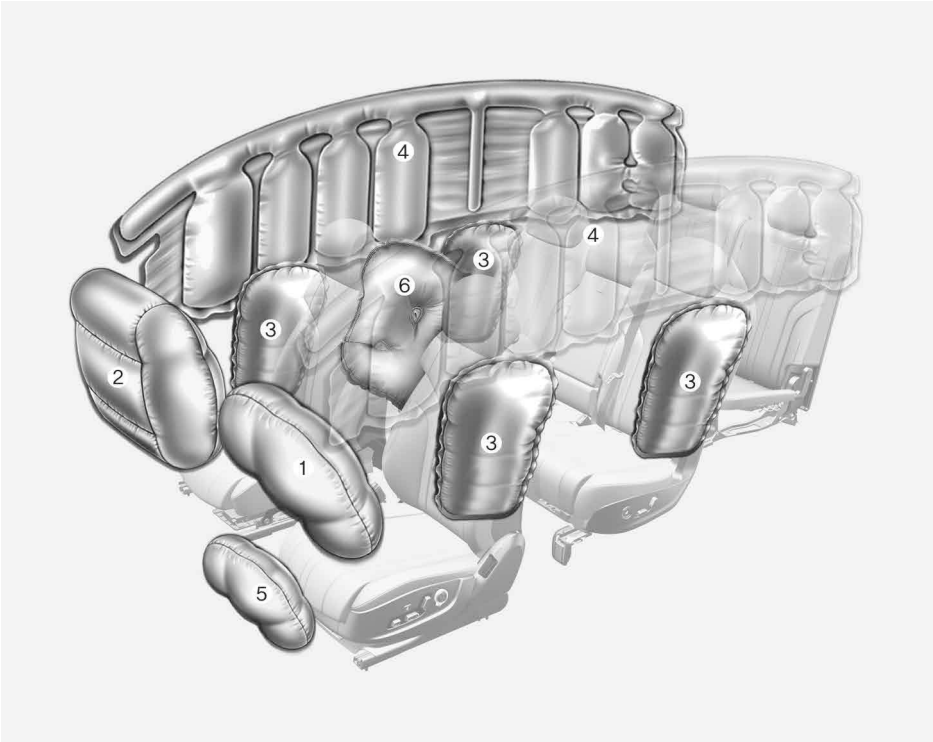

The actual airbags in the vehicle may differ from the illustration.

- (1) Driver's front airbag
- (2) Passenger's front airbag
- (3) Side airbag
- (4) Curtain airbag
- (5) Driver's knee airbag
- (6) Front center side airbag

This vehicle is equipped with an Advanced Supplemental Air Bag System for the driver's seat and front passenger's seats. The front air bags are designed to supplement the three-point seat belts. For these air bags to provide protection, the seat belts must be worn at all times when driving.

You can be severely injured or killed in an accident if you are not wearing a seat belt. Air bags are designed to supplement seat belts, but do not replace them. Also, air bags are not designed to deploy in every collision. In some accidents, the seat belts are the only restraint protecting you.

### **WARNING**

#### **AIR BAG SAFETY PRECAUTIONS**

**ALWAYS** use seat belts and Child Restraint Systems - every trip, every time, everyone! Even with air bags, you can be seriously injured or killed in a collision if you are improperly belted or not wearing your seat belt when the air bag inflates.

**NEVER** place a child in any Child Restraint System or booster seat in the front passenger seat. An inflating air bag could forcefully strike the infant or child causing serious or fatal injuries.

**ABC** - Always Buckle Children under age 13 in the back seat. It is the safest place for children of any age to ride. If a child age 13 or older must be seated in the front seat, he or she must be properly belted and the seat should be moved as far back as possible.

All occupants should sit upright with the seatback in an upright position, centered on the seat cushion with their seat belt on, legs comfortably extended and their feet on the floor until the vehicle is parked and the vehicle is turned off. If an occupant is out of position during an accident, the rapidly deploying air bag may forcefully contact the occupant causing serious or fatal injuries.

You and your passengers should never sit or lean unnecessarily close to the air bags or lean against the door or center console.

Move your seat as far back as possible from front air bags, while still maintaining control of the vehicle. The U.S. National Highway Traffic Safety Administration (NHTSA) recommends that drivers allow at least 10 inches (25 cm) between the center of the steering wheel and the chest.

## **Where are the Airbags?**

### *Driver's and passenger's front airbags*

Driver's front airbag



Driver's knee airbag (if equipped)

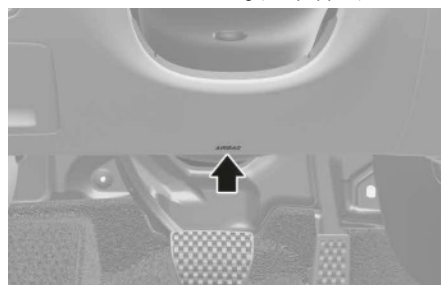

Passenger's front airbag

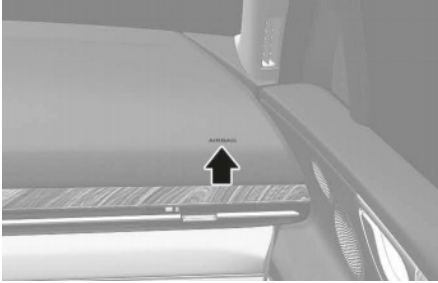

Your vehicle is equipped with an Advanced Supplemental Restraint System (SRS) and lap/shoulder belts at both the driver and passenger seating positions.

The SRS consists of air bags which are located in the center of the steering wheel, in the driver's side lower crash pad below the steering wheel, and the passenger's side front panel pad above the glove box. The air bags are labeled with the letters "AIR BAG" embossed on the pad covers. The purpose of the SRS is to provide the vehicle's driver and front passengers with additional protection than that offered by the seat belt system alone in case of a frontal impact of sufficient severity.

The SRS uses sensors to gather information about the driver's and front passenger's seat belt usage and impact severity.

The seat belt buckle sensors determine if the driver and front passenger's seat belts are fastened. These sensors provide the ability to control the SRS deployment based on whether or not the seat belts are fastened, and how severe the impact is. The advanced SRS offers the ability to control the air bag inflation within two levels. A first stage level is provided for moderate-severity impacts. A second stage level is provided for more severe impacts.

According to the impact severity, and seat belt usage, the SRS Control Module (SRSCM) controls the air bag inflation. Failure to properly wear seat belts can increase the risk or severity of injury in an accident.

### **WARNING**

To reduce the risk of serious injury or death from inflating front airbags:

- Seat belts must be worn at all times to help keep occupants positioned properly.
- Move your seat as far back as possible from front airbags, while still maintaining control of the vehicle.
- Never lean against the door or center console.
- Hold the steering wheel at the 9 o'clock and 3 o'clock positions, to minimize the risk of injuries to your hands and arms.
- Do not allow the front passenger to place their feet or legs on the dashboard.
- Never place any objects (such as dashboard cover, mobile phone holder, cup holder, perfume or stickers) over or near the airbag modules on the steering wheel, instrument panel, windshield glass, and the front passenger's panel above the glove box. Such objects may cause harm if the vehicle is in a crash severe enough to cause the airbags to deploy.
- Do not attach any objects on the front windshield and inside mirror.

## Side airbags and front center side airbag

Side airbag (Front row, Second row)

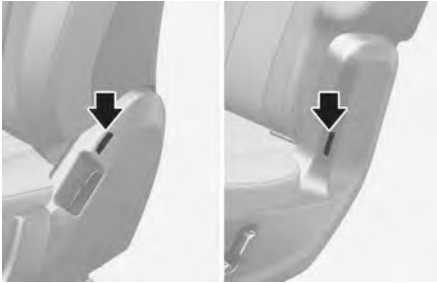

Front center side airbag

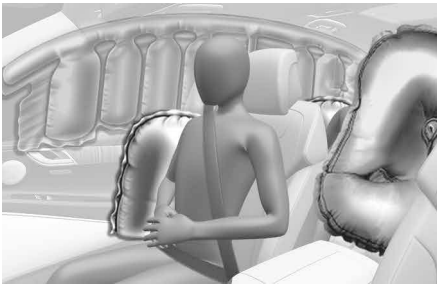
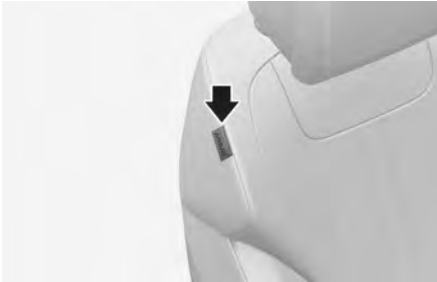

Side airbags are located in each front and outboard second row seats. Additionally, a front center side airbag is located in the inboard side of the driver seatback.

The purpose of the air bag is to provide the vehicle's additional protection than that offered by the seat belt alone.

The side airbags and front center side airbag are designed to deploy during certain side impact collisions, depending on the crash severity.

The front center side airbag, side and/or curtain airbags and pretensioners on both sides of the vehicle may deploy if a rollover or possible rollover is detected.

The side airbags and front center side airbag are not designed to deploy in all side impact or rollover situations.

### **WARNING**

To reduce the risk of serious injury or death from an inflating side airbag:

- Seat belts must be worn at all times to help keep occupants positioned properly.
- Do not allow passengers to lean their heads or bodies onto doors, put their arms on the doors, stretch their arms out of the window, or place objects between the doors and seats.
- Hold the steering wheel at the 9 o'clock and 3 o'clock positions, to minimize the risk of injuries to your hands and arms.
- Do not use any accessory seat covers. It may reduce or prevent the effectiveness of the system.
- Do not hang other objects except clothes. In an accident it may cause vehicle damage or personal injury especially when airbag is inflated.
- Do not place any objects over the airbag or between the airbag and yourself. Also, do not attach any objects around the area the airbag inflates such as the door, side door glass, front and rear pillar.
- Do not place any objects between the door and the seat. They may become dangerous projectiles if the side airbag inflates.
- Do not install any accessories on the side or near the side airbags.

- Do not cause impact to the doors when the Engine Start/Stop button is in the ON or START position as this may cause the side airbags to inflate.
- If the seat or seat cover is damaged, have the that the system serviced by an authorized retailer of Genesis Branded products.

### Curtain airbags

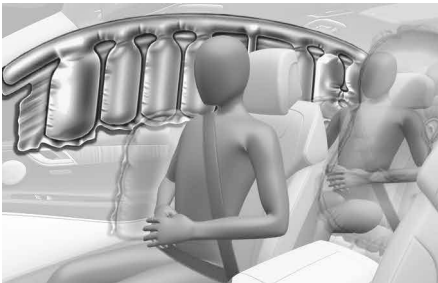

Curtain airbags are located along both sides of the roof rails above the front and rear doors.

They are designed to help protect the heads of the front seat occupants and the rear outboard seat occupants in certain side impact collisions.

The curtain airbags are designed to deploy during certain side impact collisions, depending on the crash severity.

The side and/or curtain airbags and pretensioners on both sides of the vehicle may deploy if a rollover or possible rollover is detected.

The curtain airbags are not designed to deploy in all side impact or rollover situations.

### WARNING

To reduce the risk of serious injury or death from an inflating curtain airbag:

- Seat belts must be worn at all times to help keep occupants positioned properly.
- Properly secure Child Restraint System as far away from the door as possible.
- Do not place any objects over the airbag. Also, do not attach any objects around the area the airbag inflates such as the door, side door glass, front and rear pillar, and roof side rail.
- Do not hang other objects except clothes, especially hard or breakable objects near airbag locations. In an accident, it may cause vehicle damage or personal injury.
- Do not allow passengers to lean their heads or bodies onto doors, put their arms on the doors, stretch their arms out of the window, or place objects between the doors and seats.
- Do not open or repair the side curtain airbags yourself. If necessary, have the airbag inspected by an authorized retailer of Genesis Branded products.



## How does the Airbags System Operate?

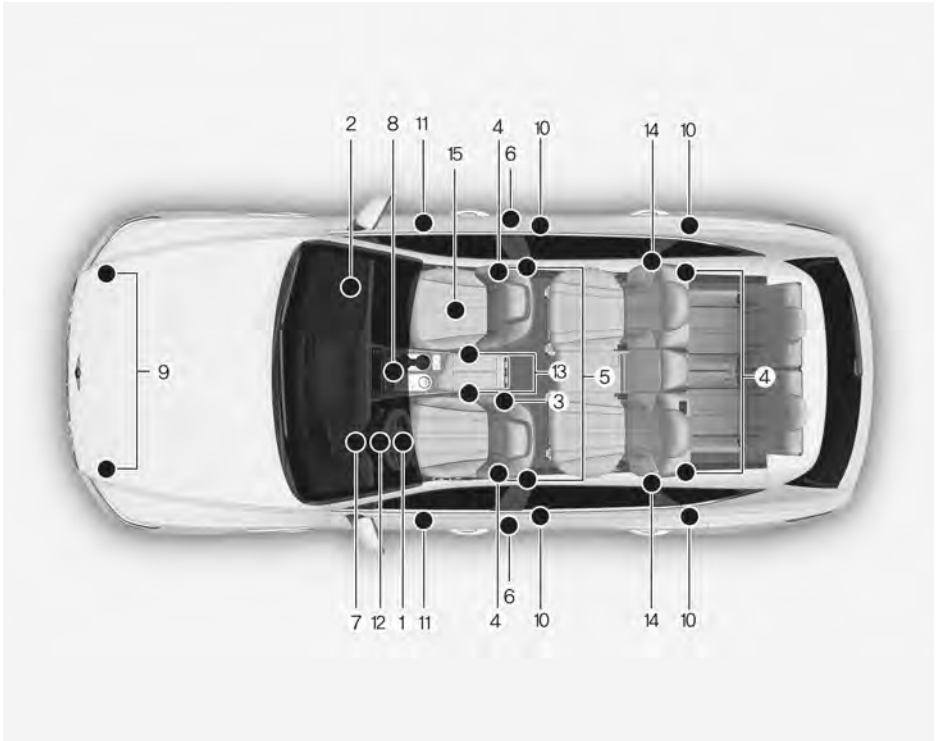

- (1) Driver's front airbag module
- (2) Passenger's front airbag module
- (3) Front center side airbag module
- (4) Side airbag modules
- (5) Curtain airbag modules
- (6) Front retractor pretensioner
- (7) Airbag warning light
- (8) SRS control module (SRSCM) / Rollover sensor
- (9) Front impact sensors
- (10) Side impact sensors (acceleration)
- (11) Side impact sensors (pressure)
- (12) Driver's knee airbag module
- (13) Driver's and front passenger's seat belt buckle sensors.
- (14) Rear retractor pretensioner (if equipped)
- (15) Occupant Classification System (OCS)

### *i* Information

Front passenger's air bag OFF lamp is located on the overhead console.

The SRSCM (Supplemental Restraint System Control Module) continually monitors all SRS components while the Engine Start/Stop button is ON to determine if a crash impact is severe enough to require air bag deployment or pre-tensioner seat belt deployment.

### SRS warning light



The SRS (Supplemental Restraint System) air bag warning light on the instrument panel displays the air bag symbol depicted in the illustration. The system checks the air bag electrical system for malfunctions. The light indicates that there is a potential problem with your air bag system, which could include your side and curtain air bags used for rollover protection.

### WARNING

If your SRS malfunctions, the air bag may not inflate properly during an accident, increasing the risk of serious injury or death.

If any of the following conditions occur, your SRS is malfunctioning:

- The light does not turn on for approximately three to six seconds when the Engine Start/Stop button is in the ON position.
- The light stays on after illuminating for approximately three to six seconds.
- The light comes on while the vehicle is in motion.
- The light blinks when the engine is running.

Have an authorized retailer of Genesis Branded products inspect the SRS as soon as possible if any of these conditions occur.

During a moderate to severe frontal collision, sensors will detect the vehicle's rapid deceleration. If the rate of deceleration is high enough, the control unit will inflate the front air bags, at the time and with the force needed.

The front air bags help protect the driver and front passenger by responding to frontal impacts in which seat belts alone cannot provide adequate restraint. When needed, the side air bags help provide protection in the event of a side impact or rollover by supporting the side upper body area.

- Air bags are activated (able to inflate if necessary) only when the Engine Start/Stop button is in the ON or START position, and it can be activated within about 3 minutes after the engine is turned off.
- Air bags inflate in the event of certain frontal or side collisions to help protect the occupants from serious physical injury.
- The front air bags will completely inflate and deflate in an instant. It is virtually impossible for you to see the air bags inflate during an accident. It is much more likely that you will simply see the deflated air bags hanging out of their storage compartments after the collision.
- In addition to inflating in serious side collisions, vehicles equipped with a rollover sensor, side and curtain air bags and front center side air bag will inflate if the sensing system detects a rollover.  
When a rollover is detected, curtain air bags will remain inflated longer to help provide protection from ejection, especially when used in conjunction with the seat belts.

- To help provide protection, the air bags must inflate rapidly. The speed of air bag inflation is a consequence of extremely short time in which to inflate the air bag between the occupant and the vehicle structures before the occupant impacts those structures. This speed of inflation reduces the risk of serious or life-threatening injuries and is thus a necessary part of air bag design.

However, the rapid air bag inflation can also cause injuries which can include facial abrasions, bruises and broken bones because the inflation speed also causes the air bags to expand with a great deal of force.

- There are even circumstances under which contact with the air bag can cause fatal injuries, especially if the occupant is positioned excessively close to the air bag.

You can take steps to reduce the risk of being injured by an inflating air bag. The greatest risk is sitting too close to the air bag. An air bag needs about 10 in. (25 cm) of space to inflate. NHTSA recommends that drivers allow at least 10 in. (25 cm) between the center of the steering wheel and the chest.

### WARNING

To reduce the risk of serious injury or death from an inflating air bag, take the following precautions:

- NEVER place a child restraint in the front passenger seat.  
Always properly restrain children under age 13 in the rear seats of the vehicle.
- Adjust the front passenger's and driver's seats as far to the rear as possible while allowing you to maintain full control of the vehicle.
- Hold the steering wheel with hands at the 9 o'clock and 3 o'clock positions.

- Never place anything or anyone between the air bag and the seat occupant.
- Do not allow the front passenger to place their feet or legs on the dashboard.

Driver's front airbag (1)

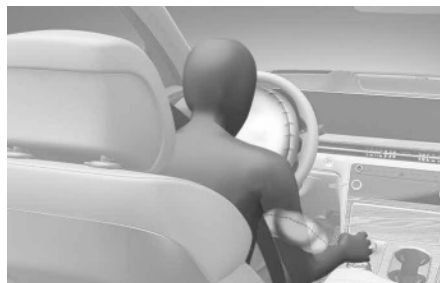

When the SRSCM detects a sufficiently severe impact to the front of the vehicle, it will automatically deploy the front air bags.

Driver's front airbag (2)



Upon deployment, tear seams molded directly into the pad covers will separate under pressure from the expansion of the air bags. Further opening of the covers allows full inflation of the air bags.

A fully inflated air bag, in combination with a properly worn seat belt, slows the driver's or the front passenger's forward motion, reducing the risk of head and chest injury.

Driver's front airbag (3)

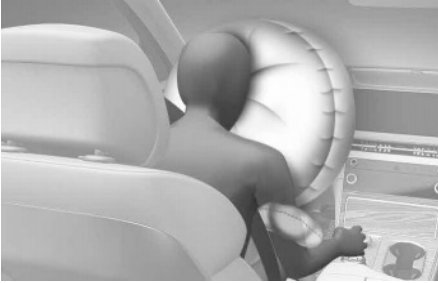

Passenger's front airbag



After complete inflation, the air bag immediately starts deflating, enabling the driver to maintain forward visibility and the ability to steer or operate other controls.

**⚠ WARNING**

To prevent objects from becoming dangerous projectiles when the passenger's air bag inflates:

- Do not install or place any objects (drink holder, CD holder, stickers, etc.) on the front passenger's panel above the glove box where the passenger's air bag is located.
- Do not install or place any objects (drink holder, CD holder, stickers, etc.) on the front passenger's panel above the glove box where the passenger's air bag is located.

## What to Expect After an Airbag Inflates

After a frontal or side air bag inflates, it will deflate very quickly. Air bag inflation will not prevent the driver from seeing out of the windshield or being able to steer. Curtain air bags may remain partially inflated for some time after they deploy.

**⚠ WARNING**

After an air bag inflates, take the following precautions:

- Open your windows and doors as soon as it is safe to do so after impact to reduce prolonged exposure to the smoke and powder released by the inflating air bag.
- Do not touch the air bag storage area's internal components immediately after an air bag has inflated. The parts that come into contact with an inflating air bag may be very hot.
- Always wash exposed skin areas thoroughly with cold water and mild soap.
- Always have an authorized retailer of Genesis Branded products replace the air bag immediately after deployment. Air bags are designed to be used only once.

### **Noise and smoke from inflating airbag**

When the air bags inflate, they make a loud noise and may produce smoke and powder in the air inside of the vehicle. This is normal and is a result of the ignition of the air bag inflator. After the air bag inflates, you may feel substantial discomfort in breathing because of the contact of your chest with both the seat belt and the air bag, as well as from breathing the smoke and powder. The powder may aggravate asthma for some people. If you experience breathing problems after an air bag deployment, seek medical attention immediately.

Though the smoke and powder are nontoxic, they may cause irritation to the skin, eyes, nose, throat, etc. If this is the case, wash and rinse with cold water immediately and seek medical attention if the symptoms persist.

### **Occupant Classification System (OCS)**



Your vehicle is equipped with an Occupant Classification System (OCS) in the front passenger's seat.

#### **Main components of the Occupant Classification System**

- A detection device located within the front passenger seat cushion.
- Electronic system to help determine whether the passenger air bag systems should be activated or deactivated.
- An indicator light located on the overhead console which illuminates the words "PASSENGER AIR BAG OFF" indicating the front passenger air bag system is deactivated.
- The overhead console air bag indicator light is interconnected with the OCS.

The OCS is designed to help detect the presence of a properly-seated front passenger and determine if the passenger's front air bag should be enabled (may inflate) or not.

The purpose is to help reduce the risk of injury or death from an inflating air bag to certain front passenger seat occupants, such as children, by requiring the air bag to be automatically turned OFF.

For example, if a child restraint of the type specified in the regulations is on the seat, the occupant classification sensor can detect it and cause the air bag to turn OFF.

Front passenger seat adult occupants who are properly seated and wearing the seat belt properly, should not cause the passenger air bag to be automatically turned OFF. For smaller adults it may turn OFF, however, if the occupant does not sit in the seat properly (for example, by not sitting upright, by sitting on the edge of the seat, or by otherwise being out of position), this could cause the sensor to turn the air bag OFF.

You will find the “PASSENGER AIR BAG OFF” indicator on the center fascia panel. This system detects the conditions 1-4 in the following table and activates or deactivates the front passenger air bag based on these conditions.

Always be sure that you and all vehicle occupants are seated properly and wearing the seat belt properly for the most effective protection by the air bag and the seat belt.

The OCS may not function properly if the passenger takes actions which can affect the classification system. These include:

- Failing to sit in an upright position.
- Leaning against the door or center console.
- Sitting towards the sides of the front of the seat.
- Putting their legs on the dashboard or resting them on other locations which reduce the passenger weight on the front seat.
- Wearing the seat belt improperly.
- Reclining the seatback.
- Wearing thick clothes like ski wear or hip protection wear.
- Putting an additional thick cushion on the seat.
- Putting electrical devices (for example, notebook, satellite radio) on the seat with inverter charging.

### Condition and operation in the front passenger Occupant Classification System

Condition detected by the occupant classification system	Indicator/Warning light		Devices
	"PASSENGER AIRBAG OFF" indicator light	SRS warning light	Front passenger airbag
Adult *1	off	off	Activated
Infant *2 or child restraint system with 12 months old* 3*4	on	off	Deactivated
Unoccupied	on	off	Deactivated
Malfunction in the system	off	on	Activated

\*1 The system judges a person of adult size as an adult. When a smaller adult sits in the front passenger seat, the system may recognize him/her as a child depending on his/her physique and posture.

\*2 Do not allow children to ride in the front passenger seat. When a larger child who has outgrown a child restraint system sits in the front passenger seat, the system may recognize him/her as an adult depending upon his/her physique or sitting position.

\*3 Never install a child restraint system on the front passenger seat.

\*4 The PASSENGER AIRBAG "OFF" indicator may turn on or off when a child above 12 months to 12 years old (with or without child restraint system) sits in the front passenger seat. This is a normal condition.

**⚠ WARNING**

Riding in an improper position or placing weight on the front passenger's seat when it is unoccupied by a passenger adversely affects the OCS. To reduce the risk of serious injury or death:

- NEVER put a heavy load in the front seat or seatback pocket, or hang any items on the front passenger seat.



- NEVER place your feet on the front passenger seatback.



- NEVER sit with your hips shifted towards the front of the seat.



- NEVER ride with the seatback reclined when the vehicle is moving.



- NEVER place your feet or legs on the dashboard.



- NEVER lean on the door or center console or sit on one side of the front passenger seat.





- Do not sit on the passenger seat wearing heavily padded clothes such as ski wear and hip protector.



- Do not use car seat accessories such as thick blankets and cushions which cover up the car seat surface.



- Do not place electronic devices such as laptops, DVD player, or conductive materials such as water bottles on the passenger seat.
- Do not use electronic devices such as laptops and satellite radios which use inverter chargers.



- If large quantity of liquid has been spilled on the passenger seat, the airbag warning light may illuminate or malfunction.

Therefore, make sure the seat has been completely dried before driving the vehicle.



- Do not place sharp objects on the front passenger seat. These may damage the occupant detection system, if they puncture the seat cushion.
- Do not place any items under the front passenger seat.
- When replacing the seat, use original Genesis parts only. The OCS has been developed based on using original Genesis Branded products seats only. Altering or changing the authentic parts may result in system malfunction and increase risk of injury when in collision. Any of the above could interfere with the proper operation of the OCS sensor thereby increasing the risk of an injury in an accident.

### Proper seated position for OCS



If the “PASSENGER AIR BAG OFF” indicator is on when an adult is seated in the front passenger seat, place the Engine Start/Stop button in the OFF position and ask the passenger to sit properly (sitting upright with the seat back in an upright position, centered on the seat cushion with their seat belt on, legs comfortably extended and their feet on the floor). Restart the engine and have the person remain in that position. This will allow the system to detect the person and to enable the passenger air bag. If the “PASSENGER AIR BAG OFF” indicator is still on, ask the passenger to move to the rear seat.

#### **WARNING**

NEVER allow an adult passenger to ride in the front passenger seat when the “PASSENGER AIR BAG OFF” indicator is illuminated. During a collision, the air bag will not inflate if the indicator is illuminated. Have your passenger reposition themselves in the seat. If the “PASSENGER AIR BAG OFF” indicator remains illuminated after the passenger repositions themselves properly and the vehicle is restarted, have the passenger move to the rear seat because the air bag will not inflate.

#### **NOTICE**

The “PASSENGER AIR BAG OFF” indicator generally illuminates for approximately 4 seconds after the Engine Start/Stop button is in the ON or START position. But, if the Engine Start/Stop button is pressed to the ON or START position within 3 minutes after the engine is turned OFF, the indicator does not illuminate. If the front passenger seat is occupied, the OCS will then classify the front passenger after several more seconds.

### Do Not Install a Child Restraint System on the Front Passenger Seat



Even though your vehicle is equipped with the OCS, never install a child restraint in the front passenger's seat. An inflating air bag can forcefully strike a child or child restraint resulting in serious or fatal injury.

#### **WARNING**

- NEVER place a rearward-facing or forward-facing child restraint in the front passenger's seat of the vehicle.
- An inflating frontal air bag could forcefully strike a child resulting in serious injury or death.
- Always properly restrain children in an appropriate child restraint in the rear seat of the vehicle.

## Why Didn't My Airbag Go Off in a Collision?

There are certain types of accidents in which the air bag would not be expected to provide additional protection. These include rear impacts, second or third collisions in multiple impact accidents, as well as low speed impacts. Damage to the vehicle indicates a collision energy absorption, and is not an indicator of whether or not an air bag should have inflated.

### *Airbag collision sensors*

#### **WARNING**

To reduce the risk of an air bag deploying unexpectedly and causing serious injury or death:

- Do not hit or allow any objects to impact the locations where air bags or sensors are installed.
  - Do not perform maintenance on or around the air bag sensors. If the location or angle of the sensors is altered, the air bags may deploy when they should not or may not deploy when they should.
  - Do not install bumper guards or replace the bumper with a non-genuine part. This may adversely affect the collision and air bag deployment performance.
  - Press the Engine Start/Stop button to the OFF or ACC position and wait for 3 minutes when the vehicle is being towed to prevent inadvertent air bag deployment.
  - Have all air bag repairs performed by an authorized retailer of Genesis Branded products.
-

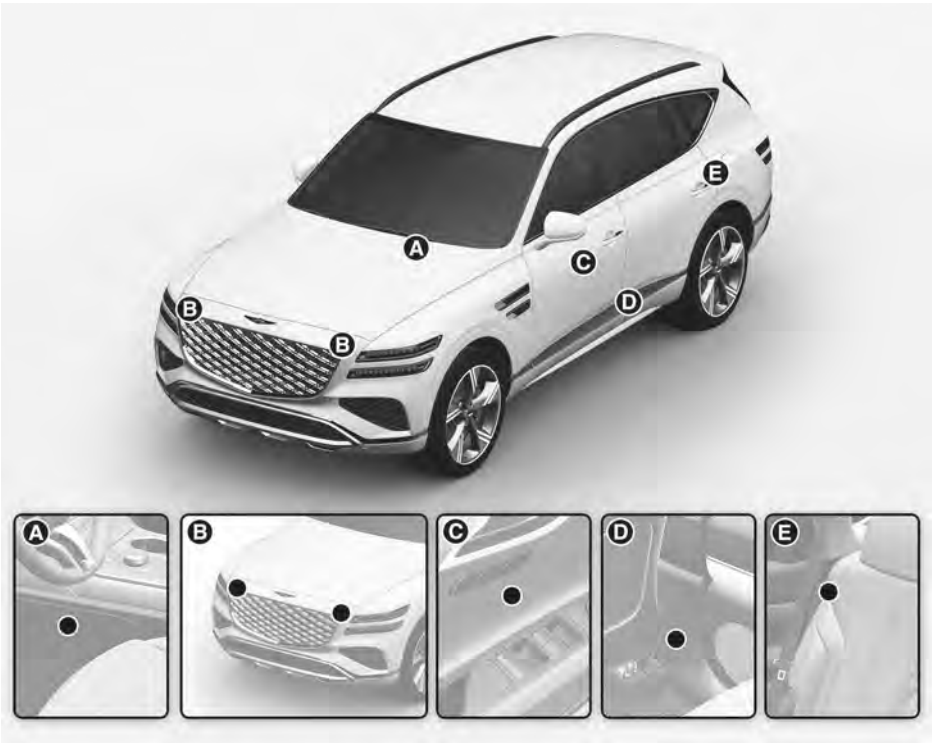

- [A] SRS control module / Rollover sensor
- [B] Front impact sensor
- [C] Side impact sensor (Pressure)
- [D] Side impact sensor (Acceleration)
- [E] Side impact sensor (Acceleration)

## ***Airbag inflation conditions***

### **Front airbags**



Front air bags are designed to inflate in a frontal collision depending on the severity of impact of the front collision.

### **Side and curtain airbags and front center side airbag**

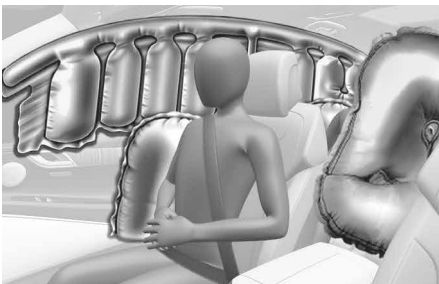

Side and curtain air bags and the front center side air bag are designed to inflate when an impact is detected by side collision sensors depending on the severity of impact resulting from a side impact collision.

Although the driver's and front passenger's air bags are designed to inflate in frontal collisions, they also may inflate in other types of collisions if the front impact sensors detect a sufficient impact. Side and curtain air bags and the front center side air bag are designed to inflate in side impact collisions, but they may inflate in other collisions if the side impact sensors detect a sufficient impact.

Also, the side and curtain air bags and the front center side air bag are designed to inflate when a rollover is detected by a rollover sensor.

If the vehicle chassis is impacted by bumps or objects on unimproved roads, the air bags may deploy. Drive carefully on unimproved roads or on surfaces not designed for vehicle traffic to prevent unintended air bag deployment.

### ***Airbag non-inflation conditions***



In certain low-speed collisions the air bags may not deploy. The air bags are designed not to deploy in such cases because they may not provide benefits beyond the protection of the seat belts.



Front air bags are not designed to inflate in rear collisions, because occupants are moved backward by the force of the impact. In this case, inflated air bags would not provide any additional benefit.



Front air bags may not inflate in side impact collisions, because occupants move in the direction of the collision, and thus in side impacts, front air bag deployment would not provide additional occupant protection.

However, side and curtain air bags and front center side air bag may inflate depending on the severity of impact.



In an angled collision, the force of impact may direct the occupants in a direction where the air bags would not be able to provide any additional benefit, and thus the sensors may not deploy any air bags.



Just before impact, drivers often brake heavily. Such heavy braking lowers the front portion of the vehicle causing it to “ride” under a vehicle with a higher ground clearance. Air bags may not inflate in this “underride” situation because deceleration forces that are detected by sensors may be significantly reduced by such “underride” collisions.

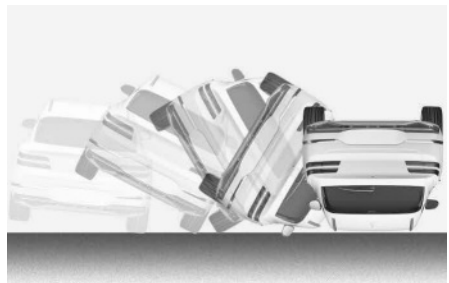

Front air bags may not inflate in rollover accidents because front air bag deployment would not provide additional occupant protection.

However, the side and curtain air bags and front center side air bag may inflate in a rollover situation, when it is detected by the rollover sensor.



Air bags may not inflate if the vehicle collides with objects such as utility poles or trees, where the point of impact is concentrated and the collision energy is absorbed by the vehicle structure.

## SRS Care

The SRS is virtually maintenance-free and there are no parts you can safely service by yourself. If the SRS air bag warning light does not illuminate when the Engine Start/Stop button is in the ON position, or continuously remains on, have the vehicle immediately inspected by an authorized retailer of Genesis Branded products.

Any work on the SRS system, such as removing, installing, repairing, or any work on the steering wheel, the front passenger's panel, front seats and roof rails be performed by an authorized retailer of Genesis Branded products. Improper handling of the SRS system may result in serious personal injury.

### WARNING

To reduce the risk of serious injury or death take the following precautions:

- Do not attempt to modify or disconnect the SRS components or wiring, including the addition of any kind of badges to the pad covers or modifications to the body structure.
- Do not place objects over or near the air bag modules on the steering wheel, instrument panel, and the front passenger's panel above the glove box.
- Clean the air bag pad covers with a soft cloth moistened with plain water. Solvents or cleaners could adversely affect the air bag covers and proper deployment of the system.
- Always have inflated air bags replaced by an authorized retailer of Genesis Branded products.
- If components of the air bag system must be discarded, or if the vehicle must be scrapped, certain safety precautions must be observed. Consult an authorized retailer of Genesis Branded products for the necessary information. Failure to follow these precautions could increase the risk of personal injury.

## Additional Safety Precautions

**Passengers should not move out of or change seats while the vehicle is moving.** A passenger who is not wearing a seat belt during a crash or emergency stop can be thrown against the inside of the vehicle, against other occupants, or be ejected from the vehicle.

**Do not use any accessories on seat belts.** Devices claiming to improve occupant comfort or reposition the seat belt can reduce the protection provided by the seat belt and increase the chance of serious injury in a crash.

**Do not modify the front seats.** Modification of the front seats could interfere with the operation of the supplemental restraint system sensing components or side air bags.

**Do not place items under the front seats.** Placing items under the front seats could interfere with the operation of the supplemental restraint system sensing components and wiring harnesses.

**Do not cause impact to the doors.** Impact to the doors when the Engine Start/Stop button is in the ON or START position may cause the air bags to inflate.

**Modifications to accommodate disabilities.** If you require modification to your vehicle to accommodate a disability, contact Genesis Customer Care at 844 340-9741.

### ***Adding equipment to or modifying your airbag equipped vehicle***

If you modify your vehicle by changing your vehicle's frame, bumper system, front end or side sheet metal or ride height, this may affect the operation of your vehicle's air bag system.

## Airbag Warning Labels



Air bag warning labels, required by the U.S. National Highway Traffic Safety Administration (NHTSA), are attached to alert the driver and passengers of potential risks of the air bag system. Be sure to read all of the information about the air bags that are installed on your vehicle in this Owners Manual.



# 4. Instrument Cluster

Instrument Cluster.....	4-2
Instrument Cluster Control .....	4-3
Gauges and Meters .....	4-3
Transmission Shift Indicator .....	4-7
Warning and Indicator Lights.....	4-7
Cluster Display Messages.....	4-20
Cluster Display .....	4-25
Cluster Display Control.....	4-25
View Modes .....	4-26
Vehicle Settings (Infotainment System) .....	4-30
Setting Your Vehicle .....	4-30

## Instrument Cluster

Type A



Type B



The actual cluster in the vehicle may differ from the illustration.  
For more information, refer to the "Gauges and Meters" section in this chapter.

- (1) Speedometer
- (2) Tachometer
- (3) Fuel gauge
- (4) Engine coolant temperature gauge
- (5) Warning and indicator lights
- (6) Cluster display
- (7) Widget

### *i* Information

Press the mode () button on the steering wheel to select between instrument cluster Type A or Type B.

## Instrument Cluster Control

### Instrument panel illumination



When the vehicle's parking lights or headlights are on, press the illumination control switch to adjust the brightness of the instrument panel illumination.

When pressing the illumination control switch, the interior switch illumination intensity is also adjusted.

### **WARNING**

Never adjust the instrument cluster while driving. This could result in loss of control and lead to an accident that may cause death, serious injury, or vehicle damage.



- The brightness of the instrument panel illumination is displayed.
- When the brightness setting reaches either the minimum or maximum level, a chime sounds.

## Gauges and Meters

### Speedometer

Type A

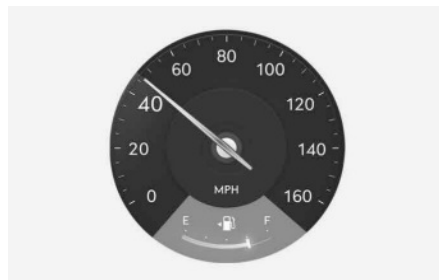

Type B (km/h)



The speedometer indicates the speed of the vehicle and is calibrated in miles per hour (MPH).

### Tachometer

Type A



Type B

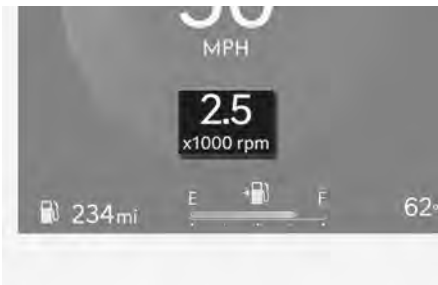

The tachometer indicates the approximate number of engine revolutions per minute (RPM).

Use the tachometer to select the correct shift points and to prevent lugging and/or over-revving the engine.

#### **NOTICE**

Do not operate the engine within the tachometer's RED ZONE to prevent severe engine damage.

### Engine coolant temperature gauge

Type A



Type B



The engine coolant temperature gauge indicates the temperature of the engine coolant when the Engine Start/Stop button is in the ON position.

#### **NOTICE**

If the gauge pointer moves beyond the normal range area toward the H (Hot) position, it indicates overheating that may damage the engine.

Do not continue driving with an overheated engine. If your vehicle overheats, refer to the "If the Engine Overheats" section in chapter 8.

**⚠ WARNING**

Never remove the engine coolant reservoir cap when the engine is hot. The engine coolant is under pressure and may cause burn or injury. Wait until the engine is cool before adding coolant to the reservoir.

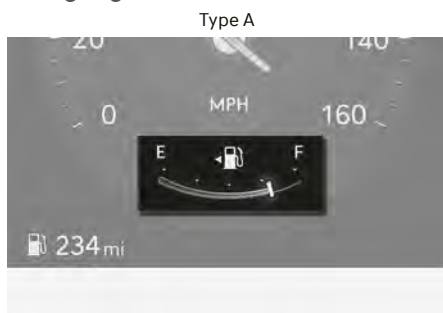
**Fuel gauge**

The fuel gauge indicates the approximate amount of fuel remaining in the fuel tank.

**i Information**

- The fuel tank capacity is given in chapter 2.
- The fuel gauge is supplemented by a low fuel warning light, that illuminates when the fuel tank is nearly empty.

- On inclines or curves, the fuel gauge pointer may fluctuate or the low fuel warning light may come on earlier than usual due to the movement of fuel in the tank.

**⚠ WARNING**

Running out of fuel can expose vehicle occupants to danger.

You must stop and obtain additional fuel as soon as possible after the warning light comes on or when the gauge indicator comes close to the "E (Empty)" level.

**NOTICE**

Avoid driving with an extremely low fuel level. Running out of fuel may cause the engine to misfire and cause damage to the catalytic converter.

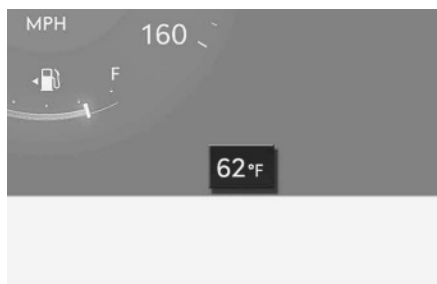
**Outside temperature gauge**

The outside ambient temperature appears in the lower portion of the cluster display. The temperature reads in Fahrenheit or Celsius depending on the units selected from the Settings menu in the infotainment system.

The temperature indicated on the instrument cluster may not change as quickly as the outside temperature.

Select:

- **Setup > General > Units > Temperature Unit > °F/°C**

For vehicles equipped with Automatic Climate Control, you can also:

- Press the **AUTO** button for 3 seconds, and then within 5 seconds press the driver's side mode (air flow) selection for more than 3 seconds.

Both the temperature unit on the instrument cluster and climate control information screen is changed.

### NOTICE

The infotainment system may change after software updates. For more information, refer to the manual provided in the infotainment system and the quick reference guide.

### Odometer

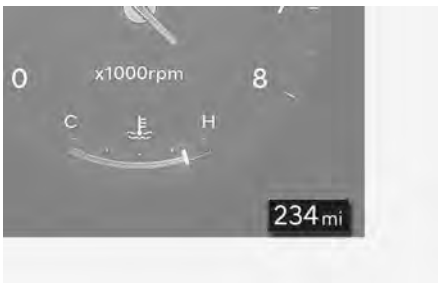

The odometer indicates the total distance that the vehicle has been driven and is used to determine when periodic maintenance should be performed.

### Distance to empty

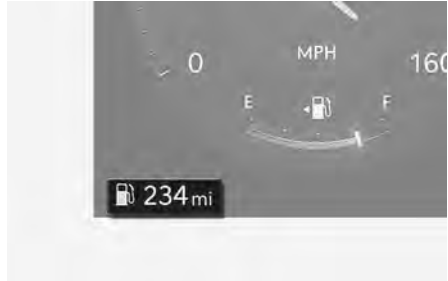

- The distance to empty is the estimated distance the vehicle can be driven with the remaining fuel.
- If the estimated distance is below 1 mi. (1 km), the trip computer displays "---" as the distance to empty. When this occurs, refuel the vehicle immediately.
- The trip computer may not register additional fuel if less than 2.4 gallon (9 liters) of fuel are added to the vehicle.

### i Information

- The distance to empty may differ from the actual driving distance because it is only an estimate of the available driving distance.
- The distance to empty may differ significantly based on driving conditions, driving habits, and condition of the vehicle.
- If the vehicle is not on level ground or the battery power has been interrupted, the distance to empty function may not operate correctly.
- The distance to empty indicator may not change accurately if less than 2.4 gallon (9 liters) of fuel are added to the vehicle.

## Transmission Shift Indicator

### *Automatic transmission shift indicator*

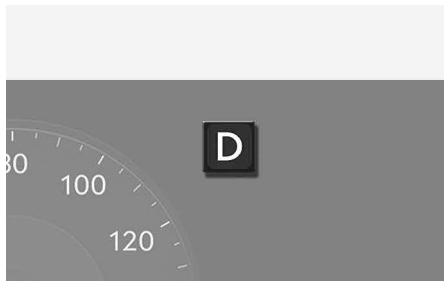

The automatic transmission shift indicator in the upper corner of the cluster display indicates the current gear or P (Park).

## Warning and Indicator Lights

### *i* Information

Make sure that all warning lights are OFF after starting the engine. If any light is still ON, this indicates a situation that needs attention.

### *Seat belt warning light*



This warning light informs the driver that the seat belt is not fastened.

For more information, refer to the "Seat Belt Warning Light" section in chapter 3.

### *Airbag warning light*



#### **This warning light illuminates:**

- When the Engine Start/Stop button is in the ON position. It illuminates for 3-6 seconds and then goes off.
- When there is a malfunction with the SRS.

If the Airbag warning light remains illuminated while driving, have the vehicle inspected by an authorized retailer of Genesis Branded products.

### *Parking brake & Brake fluid warning light*



#### **This warning light illuminates:**

- When the Engine Start/Stop button is in the ON position. It illuminates for 3 seconds and then goes off once the parking brake is released.
- Whenever the parking brake is applied.
- Whenever the brake fluid level in the reservoir is low.
  - If the warning light illuminates with the parking brake released, it indicates the brake fluid level in the reservoir is low.

If the brake fluid level in the reservoir is low:

1. Drive carefully to the nearest safe location and stop your vehicle.
2. With the engine stopped, check the brake fluid level immediately and add fluid as required. For more information, refer to the "Brake Fluid" section in chapter 9. After adding brake fluid, check all brake components for fluid leaks. If a brake fluid leak is found, or if the warning light remains on, or if the brakes do not operate properly, do not drive the vehicle. Have your vehicle inspected by an authorized retailer of Genesis Branded products.

### Dual-diagonal braking system

Your vehicle is equipped with the dual-diagonal braking system. This means you still have braking on two wheels even if one of the dual systems should fail.

With only one of the dual systems working, more than normal pedal travel and greater pedal force are required to stop the vehicle.

Also, the vehicle does not stop in as short a distance if only a portion of the brake system is working.

If you experience a malfunction with the braking system while driving, attempt to slow your vehicle by coasting or by using engine braking. You may be able to reduce your vehicle speed by manually downshifting to a lower gear. Use the paddle shifters to shift to a lower gear.

### WARNING

If the Parking Brake & Brake Fluid warning light illuminates with the parking brake released, it indicates that the brake fluid level is low. If this occurs, have the vehicle inspected by an authorized retailer of Genesis Branded products.

### Anti-lock Brake System (ABS) warning light



This warning light illuminates:

- When the Engine Start/Stop button is in the ON position. It illuminates for about 3 seconds and then goes off.
- Whenever there is a malfunction with the ABS.

The hydraulic braking system still operates even if there is a malfunction with the ABS.

If the ABS warning light remains illuminated while driving, have the vehicle inspected by an authorized retailer of Genesis Branded products.

### Electronic Brake Force Distribution (EBD) system warning light



When the ABS warning and Parking Brake warning lights are on simultaneously, it may indicate a problem with the Electronic Brake Force Distribution system.

If both the ABS warning light and the Parking Brake warning light remain illuminated while driving, have your vehicle inspected by an authorized retailer of Genesis Branded products.



**! WARNING**

When both ABS and Parking Brake & Brake Fluid warning lights are on, the braking system will not work normally and you may experience an unexpected and dangerous situation during sudden braking.

Avoid high speed driving and abrupt braking.

Have your vehicle inspected by an authorized retailer of Genesis Branded products as soon as possible.

**NOTICE**

When the ABS warning light is on or both ABS and Parking Brake & Brake Fluid warning lights are on, the speedometer, odometer, or tripmeter may not work. Also, the MDPS warning light may illuminate and the steering effort may increase or decrease.

**Motor Driven Power Steering (MDPS) warning light****This warning light illuminates:**

- When the Engine Start/Stop button is in the ON position. It illuminates for about 3 seconds and then goes off.
- Whenever there is a malfunction with the Motor Driven Power Steering.

If the MDPS warning light remains illuminated while driving, have your vehicle inspected by an authorized retailer of Genesis Branded products.

**Charging system warning light****This warning light illuminates:**

- When the Engine Start/Stop button is in the ON position. It illuminates for about 3 seconds and then goes off.
- When there is a malfunction with either the alternator or electrical charging system.

**If there is a malfunction with either the alternator or electrical charging system:**

1. Drive carefully to the nearest safe location and stop your vehicle.
2. Turn the engine off and check the alternator drive belt for looseness or breakage.

If the belt is adjusted properly, there may be a problem in the electrical charging system.

If this occurs, have the vehicle inspected by an authorized retailer of Genesis Branded products as soon as possible.

### **Engine oil pressure warning light**



**This warning light illuminates:**

When the engine oil pressure is low.

**If the engine oil pressure is low:**

1. Drive carefully to the nearest safe location and stop your vehicle.
2. Turn the engine off and check the engine oil level (For more details, refer to "Engine Oil" section in chapter 9). If the level is low, add oil as required.

If the warning light remains on after adding oil or if oil is not available, have your vehicle inspected by an authorized retailer of Genesis Branded products as soon as possible. Continued driving with the warning light on may cause engine failure.

#### ***i* Information**

When engine oil pressure decreases due to insufficient engine oil, etc., the Engine Oil Pressure warning light will illuminate. In addition, the enhanced engine protection system which limits engine power will be activated. If the engine oil pressure is restored, the Engine Oil Pressure warning light and the enhanced engine protection system will turn off.

However, when the engine oil pressure is restored, the warning light and the enhanced engine protection system will turn off after the engine is restarted.

#### **NOTICE**

If the engine is not stopped immediately after the Engine Oil Pressure warning light is illuminated, severe damage could occur.

### **Low fuel level warning light**



**This warning light illuminates:**

When the fuel tank is nearly empty.

Refuel the vehicle as soon as possible.

#### **NOTICE**

Driving with the Low Fuel Level warning light on or with the fuel level below "E" may cause the engine to misfire and damage the catalytic converter.

### **Malfunction Indicator Lamp (MIL)**



**This indicator light illuminates:**

- When the Engine Start/Stop button is in the ON position. It illuminates for about 3 seconds and then goes off.
- Whenever there is a malfunction with either the emission control system or the engine or the vehicle powertrain.

If the MIL warning light remains illuminated while driving, have your vehicle inspected by an authorized retailer of Genesis Branded products.

**CAUTION**

- Driving with the Malfunction Indicator Lamp (MIL) on may cause damage to the emission control system that may affect drivability and/or fuel economy.
- If the Malfunction Indicator Lamp (MIL) illuminates, catalytic converter damage is possible that may result in loss of engine power.
- If the enhanced engine protection system becomes activated due to lack of engine oil, engine power will be limited. If such condition continues repeatedly, the Malfunction Indicator Lamp will illuminate.

**Exhaust system (GPF) warning light**

 if equipped

**This warning light illuminates:**

When accumulated soot reaches a certain amount. It may turn off after driving the vehicle at more than 80 km/h (50 mph) for about 30 minutes (above 3rd gear with 1500-4000 engine RPM).

If this warning light blinks and a message appears on the cluster, have the GPF system checked by an authorized retailer of Genesis Branded products.

**NOTICE**

If you continue to drive with the GPF warning light blinking for a long time, the GPF system may be damaged and the fuel consumption may increase.

**Master warning light****This warning light illuminates:**

If a malfunction is detected in any of the following:

- Forward Collision-Avoidance Assist malfunction
- Forward Collision-Avoidance Assist radar blocked
- Blind-Spot Collision-Avoidance Assist malfunction
- Blind-Spot Collision-Avoidance Assist radar blocked
- LED headlight malfunction (if equipped)
- High Beam Assist malfunction
- Smart Cruise Control malfunction
- Smart Cruise Control radar blocked
- Tire Pressure Monitoring System (TPMS) malfunction
- Electronic Limited Slip Differential (e-LSD) malfunction (if equipped)

If the issue is resolved, the Master warning light turns off.

## Electronic Parking Brake (EPB) warning light

# EPB

### This warning light illuminates:

- When the Engine Start/Stop button is in the ON position. It illuminates for about 3 seconds and then goes off.
- Whenever there is a malfunction with EPB.

If the EPB warning light remains illuminated while driving, have your vehicle inspected by an authorized retailer of Genesis Branded products.

### *i* Information

The Electronic Parking Brake (EPB) warning light may illuminate when the Electronic Stability Control (ESC) indicator light comes on to indicate that ESC is not working properly. This does not indicate malfunction of EPB.

## Low tire pressure warning light



### This warning light illuminates:

- When the Engine Start/Stop button is in the ON position. It illuminates for about 3 seconds and then goes off.
- When one or more tires are significantly underinflated. (The location of the under-inflated tire appears on the cluster display.)

For more information, refer to the "Tire Pressure Monitoring System (TPMS)" section in chapter 8.

This warning light remains ON after blinking for about 60 seconds, or repeatedly blinks ON and OFF at 3 second intervals:

When there is a malfunction with the TPMS.

If this occurs, have your vehicle inspected by an authorized retailer of Genesis Branded products as soon as possible.

For more information, refer to the "Tire Pressure Monitoring System (TPMS)" section in chapter 8.

### WARNING

#### Safe Stopping

- The TPMS cannot alert you to severe and sudden tire damage caused by external factors.
- If you notice any vehicle instability, immediately take your foot off the accelerator pedal, apply the brakes gradually with light force, and slowly move to a safe position off the road.

## Forward Safety warning light



### This warning light illuminates:

- When the Start/Stop button is in the ON position. It illuminates for about 3 seconds and then goes off.
- Yellow: When Forward Safety of Forward Collision-Avoidance Assist is deselected, disabled, or a malfunction is detected.

If the yellow warning light remains on after the sensor has been uncovered or unblocked when the Forward Safety is set, have your vehicle inspected by an authorized retailer of Genesis Branded products.

**This warning light blinks:**

- Red: When Forward Safety or Forward Cross-Traffic Safety function is operating.

For more information, refer to the "Forward Collision-Avoidance Assist (FCA)" section in chapter 7.

**Emergency steering warning light**

 if equipped

**This warning light illuminates:**

- When the Engine Start/Stop button is in the ON position, the yellow warning light illuminates for about 3 seconds and then goes off.
- Continuously Yellow: When Forward/Side Safety is deselected or Forward Collision-Avoidance Assist is disabled or a malfunction is detected.
- Blinking Red: When Forward/Side Safety of Forward Collision-Avoidance Assist is operating.

If the yellow warning light is still on even after removing foreign material from the front of the sensors after Forward Safety is set, have your vehicle inspected by an authorized retailer of Genesis Branded products.

For more information, refer to the "Forward Collision-Avoidance Assist (FCA)" section in chapter 7.

**Lane Safety indicator light****This indicator light illuminates:**

- Green: When Lane Keeping Assist operating conditions are satisfied.
- Gray: When Lane Keeping Assist operating conditions are not satisfied.
- Yellow: When Lane Safety is deselected, disabled, or a malfunction is detected.

If the yellow warning light remains on after the sensor has been uncovered or unblocked when Lane Safety is set, have your vehicle inspected by an authorized retailer of Genesis Branded products.

For more information, refer to the "Lane Keeping Assist (LKA)" section in chapter 7.

**Inattentive Driving warning light****This indicator light illuminates:**

- When the Engine Start/Stop button is in the ON position. It illuminates for about 3 seconds and then goes off.
- Yellow: When Driver Attention Warning is disabled or a malfunction is detected.

If the yellow indicator light remains on after the front view camera has been uncovered or unblocked, have your vehicle inspected by an authorized retailer of Genesis Branded products.

**This indicator light blinks:**

- Yellow: When Driver Attention Warning recommends to take a break.

For more information, refer to the "Driver Attention Warning (DAW)" section in chapter 7.

**Forward Attention Warning light**

 if equipped



**This warning light illuminates:**

- When the Engine Start/Stop button is in the ON position. It illuminates for about 3 seconds and then goes off.
- Red: When Forward Attention Warning is disabled or a malfunction is detected. If the red warning light remains on after the in-cabin camera has been uncovered or unblocked, have your vehicle inspected by an authorized retailer of Genesis Branded products.

**This warning light blinks:**

- Red: When Forward Attention Warning warns the driver to keep eyes on the road.

For more information, refer to the "Forward Attention Warning (FAW)" section in chapter 7.

**Intelligent Speed Limit Assist indicator light**

 if equipped



**This indicator light illuminates:**

- When the Engine Start/Stop button is in the ON position. It illuminates for about 3 seconds and then goes off.
- Yellow: When Intelligent Speed Limit Assist is off, disabled, or a malfunction is detected.

If the yellow indicator light remains on after the front view camera has been uncovered or unblocked, have your vehicle inspected by an authorized retailer of Genesis Branded products.

For more information, refer to the "Intelligent Speed Limit Assist (ISLA)" section in chapter 7.

**Lane Following Assist indicator light****This indicator light illuminates:**

- When the Engine Start/Stop button is in the ON position. It illuminates for about 3 seconds and then goes off.
- Green: When Lane Following Assist is operating.
- Gray: When Lane Following Assist operating conditions are not satisfied.

**This indicator light blinks:**

- White: When the steering wheel assist is cancelled.

For more information, refer to the "Lane Following Assist (LFA)" section in chapter 7.

**All Wheel Drive (AWD) warning light****This warning light illuminates:**

Whenever a malfunction with the AWD system is detected.

If this occurs, have your vehicle inspected by an authorized retailer of Genesis Branded products.

For more information, refer to the "All Wheel Drive (AWD)" section in chapter 6.

**LED headlight warning light****This warning light illuminates:**

- When the Engine Start/Stop button is in the ON position. It illuminates for about 3 seconds and then goes off.
- Whenever there is a malfunction with a LED headlight.

If the LED headlight warning light remains illuminated while driving, have your vehicle inspected by an authorized retailer of Genesis Branded products.

**This warning light blinks:**

Whenever there is a malfunction with a LED headlight related part.

If this occurs, have your vehicle inspected by an authorized retailer of Genesis Branded products.

**NOTICE**

Driving with the LED headlight warning light on or blinking may reduce LED headlight life.

### *Icy road warning light*



#### **This warning light illuminates:**

To warn the driver the road may be icy.

When the outside temperature on the outside temperature gauge is below 4 °C (40 °F), a single chime sounds, both the outside temperature gauge and Icy Road Warning indicator blink several times and then illuminates.

You can activate or deactivate the Icy Road Warning function from the Settings menu in the infotainment system. Select:

- **Setup > Vehicle > Cluster > Content Selection > Icy Road Warning**

#### ***i* Information**

- If the Icy Road warning light appears while driving, avoid speeding, rapid acceleration, sudden braking, or sharp turning.
  - The infotainment system may change after software updates. For more information, refer to the user's manual provided in the infotainment system and the quick reference guide.
- 

### *Electronic Stability Control (ESC) indicator light*



#### **This indicator light illuminates:**

- When the Engine Start/Stop button is in the ON position. It illuminates for about 3 seconds and then goes off.
- Whenever there is a malfunction with ESC system.

If this occurs, have your vehicle inspected by an authorized retailer of Genesis Branded products.

#### **This indicator light blinks:**

While ESC is operating.

For more information, refer to the "Electronic Stability Control (ESC)" section in chapter 6.

### *Electronic Stability Control (ESC) OFF indicator light*



#### **This indicator light illuminates:**

- When the Engine Start/Stop button is in the ON position. It illuminates for about 3 seconds and then goes off.
- When you deactivate ESC system by pressing the ESC OFF button.

For more information, refer to the "Electronic Stability Control (ESC)" section in chapter 6.



### **Immobilizer indicator light**



**This indicator light illuminates for up to 30 seconds:**

When the vehicle detects the smart key in the vehicle with the Engine Start/Stop button in the ACC or ON position.

- At this time, you can start the engine.
- The indicator light goes off after starting the engine.

**This indicator light blinks for a few seconds:**

When the smart key is not in the vehicle, you cannot start the engine.

**This indicator light illuminates for 2 seconds and goes off:**

If the smart key is in the vehicle and the Engine Start/Stop button is ON, but the vehicle cannot detect the smart key.

If this occurs, have your vehicle inspected by an authorized retailer of Genesis Branded products.

**This indicator light blinks:**

Whenever there is a malfunction with the immobilizer system.

If this occurs, have your vehicle inspected by an authorized retailer of Genesis Branded products.

### **AUTO STOP indicator light**

**if equipped**



**This indicator light illuminates:**

- White: When the ISG system is in the standby mode.
- Green: When the engine enters the Idle Stop mode of ISG (Idle Stop and Go) system.
- Yellow: When there is a problem with the ISG system. Contact an authorized retailer of Genesis Branded products.

For more information, refer to the "Idle Stop and Go (ISG)" section in chapter 6.

#### ***i* Information**

When the ISG system automatically starts the engine, some warning lights (ABS, ESC, ESC OFF, MDPS or Parking brake warning light) may turn on for a few seconds because of a low battery voltage but not a system malfunction.

**Door open indicator light**



**This indicator light illuminates:**

When any door or liftgate is left open.

**WARNING**

Before driving the vehicle, confirm the door and liftgate are fully closed.

---

**NOTICE**

The 12 V battery may discharge if you leave the vehicle with the Door Open indicator light illuminated.

---

**Turn signal indicator light**



**This indicator light blinks:**

When you operate the turn signal lever.

If any of the following occur, there may be a malfunction with the turn signal system.

- The turn signal indicator light illuminates but does not blink.
- The turn signal indicator light blinks rapidly.
- The turn signal indicator light does not illuminate at all.

If any of these conditions occur, have your vehicle inspected by an authorized retailer of Genesis Branded products.

**High beam indicator light**



**This indicator light illuminates:**

- When the headlamps are on and the turn signal lever is moved to the high beam position.
- When the turn signal lever is pulled into the Flash-to-Pass position.

**Low beam indicator light**



**This indicator light illuminates:**

When the headlamps are on.

**Light ON indicator light**



**This indicator light illuminates:**

When the position lights or headlights are on.

**High Beam Assist indicator light****This indicator light illuminates:**

When the high beam is on with the light switch in the AUTO position.

- White: When High Beam Assist is ready to operate.
- Green: When High Beam Assist is operating.

If your vehicle detects oncoming or preceding vehicles, High Beam Assist switches the high beam to low beam automatically.

For more information, refer to the "High Beam Assist (HBA)" section in chapter 5.

**Downhill Brake Control (DBC) indicator light**

 if equipped

**This indicator light illuminates:**

- When the Engine Start/Stop button is in the ON position. It illuminates for about 3 seconds and then goes off.
- When you activate the system by pressing the DBC button.

**This indicator light blinks:**

When Downhill Brake Control system is operating.

**This indicator light illuminates yellow:**

Whenever there is a malfunction with Downhill Brake Control system.

If this occurs, have your vehicle inspected by an authorized retailer of Genesis Branded products.

For more information, refer to the "Downhill Brake Control (DBC)" section in chapter 6.

**AUTO HOLD indicator light****This indicator light illuminates:**

- White: When you activate Auto Hold by pressing the AUTO HOLD switch.
- Green: When you stop the vehicle completely by depressing the brake pedal with Auto Hold activated.
- Yellow: Whenever a malfunction with the Auto Hold is detected.

If the AUTO HOLD indicator light remains yellow while driving, have your vehicle inspected by an authorized retailer of Genesis Branded products.

For more information, refer to the "Auto Hold" section in chapter 6.

**Speed Limiter indicator light****This indicator light illuminates:**

When the speed limiter is enabled.

For more information, refer to the "Manual Speed Limit Assist (MSLA)" section in chapter 7.

## Cluster Display Messages

### **Low key battery**

When the Engine Start/Stop button is pressed to the OFF position, a message may appear, indicating the internal battery of the smart key is low. Replace the smart key battery.

### **Press START button while turning wheel**

 if equipped

This message appears if the steering wheel does not unlock normally when the Engine Start/Stop button is pressed.

Press the Engine Start/Stop button while turning the steering wheel right and left.

### **Check steering wheel lock system**

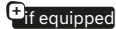
 if equipped

This message appears if the steering wheel does not lock normally while the Engine Start/Stop button is pressed to the OFF position.

### **Press brake pedal to start engine**

This message appears if the Engine Start/Stop button is pressed repeatedly without depressing the brake pedal.

Start the vehicle by depressing the brake pedal and then pressing the Engine Start/Stop button.

### **Key not in vehicle**

This message appears if the smart key is not in the vehicle when you left the vehicle with the Engine Start/Stop button in the ON or Start position.

Always turn off the engine before leaving your vehicle.

### **Key not detected**

This message appears if the smart key is not detected when you press the Engine Start/Stop button.

### **Press START button again**

If you cannot start the vehicle after the Engine Start/ Stop button is pressed, attempt to start the engine by pressing the Engine Start/ Stop button again.

If the warning message appears each time you press the Engine Start/Stop button, have the vehicle inspected by an authorized retailer of Genesis Branded products.

### **Press START button with key**

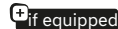
 if equipped

This message appears and the immobilizer indicator blinks if you press the Engine Start/Stop button while the warning message, "Key not detected" appears.

### **Check BRAKE SWITCH fuse**

This message appears if the brake switch fuse is disconnected.

Replace the fuse before starting the engine.

If that is not possible, start the engine by pressing the Engine Start/Stop button for 10 seconds in the ACC position.

### **Shift to P or N to start engine**

This message appears if you try to start the engine in any other position except P (Park) or N (Neutral).

Start the engine with the vehicle in P (Park) with your foot depressing the brake pedal.

***Authenticated. The vehicle can now be started*****+ if equipped**

This message appears for 4 seconds when you place your finger on the fingerprint sensor, and it is verified while the engine is off.

You can start the vehicle by depressing the brake pedal and then pressing the Engine Start/Stop button. However, the engine starts when the Engine Start/ Stop button is pressed within 30 seconds after your fingerprint is verified and the immobilizer (🚫) indicator light is illuminated. If the immobilizer indicator light is off, your fingerprint must be verified again.

***Fingerprint authentication is locked out. Try again in XX min.*****+ if equipped**

This message appears for 4 seconds when fingerprint authentication has failed more than five times while the engine is off. While the message is displayed, fingerprint authentication does not work even if you place your finger on the fingerprint sensor, and the engine does not start even if the Engine Start/Stop button is pressed.

Try again after the time indicated in the message has passed. Start the engine with the smart key or digital key.

If fingerprint authentication still does not work, refer to the "Fingerprint Authentication System" section in chapter 5.

***Place digital key on the wireless charger to keep the vehicle running*****+ if equipped**

If the vehicle is remotely started and **Start Vehicle** is deselected from the Settings menu in the infotainment system for Driver 1 and Driver 2, this message appears for up to 30 seconds when a door is opened after unlocking the doors with a digital key.

To drive your vehicle, place the registered digital key on the wireless charger, when this message appears.

***Scan an authorized fingerprint to keep the vehicle running*****+ if equipped**

If the vehicle is remotely started and **Start Vehicle** is selected from the Settings menu in the infotainment system for Driver 1 or Driver 2, this message appears for up to 30 seconds when a door is opened after unlocking the doors with a digital key or the Genesis Connected Services app.

To drive your vehicle, have an authorized fingerprint verified on the fingerprint sensor when this message appears.

***Place digital key on the wireless charger or scan an authorized fingerprint*****+ if equipped**

If the vehicle is remotely started and **Start Vehicle** is selected from the Settings menu in the infotainment system for Driver 1 or Driver 2, this message appears for up to 30 seconds when a door is opened after unlocking the doors with a digital key or the Genesis Connected Services app.

To drive your vehicle, place the registered digital key on the wireless charger, or have your fingerprint verified on the fingerprint sensor when this message appears.

### ***Vehicle is On (started by fingerprint)***

**+** if equipped

This message appears for up to 10 seconds if the driver's door is opened and the driver's seat belt is not fastened after turning on the engine with a fingerprint. After the message appears, a warning sounds when the door is closed.

#### ***i* Information**

Since the engine was started with a fingerprint, if the engine is turned off, and there is no smart key, digital key or a registered fingerprint in the vehicle, it may be difficult to start the engine again.

### ***Check user authentication system***

**+** if equipped

This message appears if there is a problem with the Digital Key or Fingerprint Authentication System. Contact an authorized retailer of Genesis Branded products.

### ***Battery discharging due to external / additional electrical devices***

This message appears if the 12 V battery voltage is low or if a current draw is detected that could drain the vehicle battery. Do not connect any external electronic devices to the battery system or battery discharge may occur.

If this message appears on the cluster and there are no other external electronic devices connected to the vehicle, have your vehicle inspected by an authorized retailer of Genesis Branded products.

### ***Door, Hood, Liftgate open indicator***



This warning appears if any door or hood or liftgate is left open. The warning will indicate which door is open on the display.

#### **⚠ CAUTION**

Before driving the vehicle, confirm that the door, hood and liftgate are fully closed.

### ***Sunroof open indicator***

**+** if equipped



This warning appears if you turn off the engine when the sunroof is open.

Close the sunroof securely before leaving your vehicle.

### Low tire pressure



This warning message appears if the tire pressure is low. The corresponding tire on the vehicle illuminates.

For more information, refer to the "Tire Pressure Monitoring System (TPMS)" section in chapter 8.

### Lights



This indicator displays which exterior light is selected using the lighting control.

You can activate or deactivate Wiper/Lights display function from the Settings menu in the infotainment system. Select:

- **Setup > Vehicle > Cluster > Content Selection > Wiper/Lights Display**

#### *i* Information

The infotainment system may change after software updates. For more information, refer to the user's manual provided in the infotainment system and the quick reference guide.

### Wiper

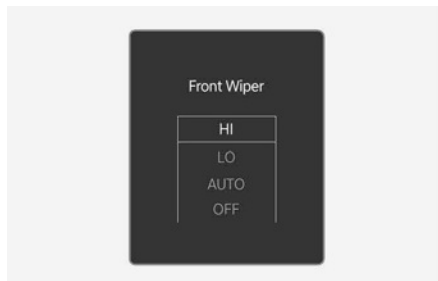

This indicator displays which wiper speed is selected using the wiper control.

You can activate or deactivate Wiper/Lights display function from the Settings menu in the infotainment system. Select:

- **Setup > Vehicle > Cluster > Content Selection > Wiper/Lights Display**

#### *i* Information

The infotainment system may change after software updates. For more information, refer to the user's manual provided in the infotainment system and the quick reference guide.

### Low washer fluid

This message appears if the washer fluid level in the reservoir is nearly empty.

Have the washer fluid reservoir refilled.

### Low fuel

This message appears if the fuel tank is almost out of fuel.

When this message appears, the low fuel level warning light on the cluster comes on.

Refuel as soon as possible.

### **Low engine oil**

 if equipped

This warning message appears when the engine oil level should be checked.

Check the engine oil level as soon as possible and add engine oil as required. Slowly pour the recommended oil into a funnel.

Refer to the "Recommended Lubricants and Capacities" section in chapter 2.

Do not overfill the engine oil. Make sure the oil level is not above F (Full) mark on the dipstick.

#### **WARNING**

When the engine oil level warning message is displayed, it is necessary to check whether maintenance schedule (Engine oil replacement) in owner's manual has been followed before, and if not followed, the engine oil must be replaced first.

---

#### **Information**

After adding engine oil, if you travel about 31-62 mi. (50-100 km) after the engine warms up, the warning message should disappear. If the warning message remains on, have your vehicle inspected by an authorized retailer of Genesis Branded products as soon as possible.

---

### **Engine overheated**

This message appears when the engine coolant temperature is above about 248 °F (120 °C). The engine is overheated and may be damaged.

If your vehicle is overheated, refer to the "If the Engine Overheats" section in chapter 8.

### **Check exhaust system**

 if equipped

This message appears if there is a problem with the GPF system. At this time, the GPF warning light will also blink. If this occurs, have the GPF system inspected by an authorized retailer of Genesis Branded products.

GPF: Gasoline Particulate Filter

### **Check haptic steering wheel system**

 if equipped

This message appears if there is a problem with the haptic steering wheel system. Have your vehicle inspected by an authorized retailer of Genesis Branded products.

### **Check headlight**

 if equipped

This message appears if the headlamps are not operating properly.

Replace the burned out bulb with a new one with the same wattage rating.

### **Check turn signal**

 if equipped

This message appears if the turn signal lamps are not operating properly.

Replace the burned out bulb with a new one with the same wattage rating.

### **Check headlight LED**

 if equipped

This message appears if there is a problem with the LED headlight. Have your vehicle inspected by an authorized retailer of Genesis Branded products.



## Cluster Display

### Cluster Display Control

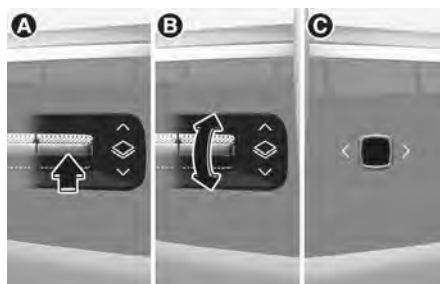

Switch	Operation	Function
[A] ◆	Press	MODE button for changing gauge mode.
[B] ^, v	Press	UP, DOWN switch for changing View modes.
[C] ■	Press	SELECT/RESET switch for selecting pop up. SELECT/RESET switch for entering or exiting widget navigation mode.
	Press and hold	SELECT/RESET switch for selecting certain pop up. SELECT/RESET switch for hiding or showing widget mode.
	Press 2 times	SELECT/RESET switch for resetting the selected Normal view mode.
	Tap up, down, left, right	When in widget mode, the switch is used to navigate the widgets. When not in widget mode, the switch is used to change to previous or next song.

## View Modes

View modes	Explanation
Normal view	Show trip computer or widget on center without background information.
Driving Assist view	Driving Assist view displays the status of the vehicle's Driver Assistance systems.
Map view	Show map and navigation related information.
Wide Map	Show map and navigation related information.
AR view	Show AR navigation and navigation related information.

**The information provided may differ depending on which functions are available on your vehicle.**

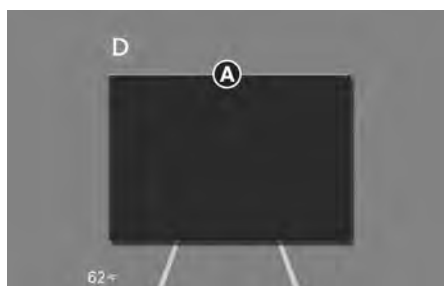

Normal view, Driving Assist view, Map view, Wide Map view, and AR view mode are displayed in the instrument cluster [A].

Normal view is also shown in the widget mode.

### Normal view

In the Normal view, using the  (Optical mouse), you may change through items in the following order.

### Current trip

Type A

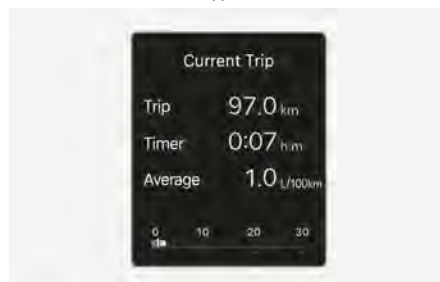

Type B



Trip distance, total driving time, average fuel economy, and instant fuel economy are displayed.

The information is combined for each ignition cycle.

To reset manually, press the  button two times on the steering wheel when "Current trip" appears.

Since refuelling

Type A

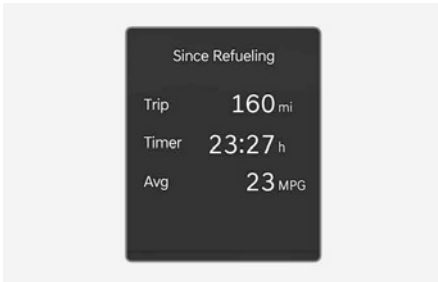

Type B



After the vehicle has been refueled, the trip distance, total driving time, average fuel economy, and instant fuel economy are displayed.

To reset manually, press the  button two times on the steering wheel when "**Since refuelling**" appears.

Since last reset

Type A



Type B



Accumulated trip distance, driving time, average fuel economy, and instant fuel economy are displayed.

The information is accumulated starting from the last reset.

To reset manually, press the  button two times on the steering wheel when "**Since last reset**" appears.

### Auto stop

 if equipped



Displays the elapsed time of engine stop by the Idle Stop and Go system.

To reset manually, press the  button two times on the steering wheel when "AUTO STOP" appears.

For more information, refer to the "Idle Stop and Go (ISG)" section in chapter 6.

### Drive power distribution

 if equipped



Displays information related to AWD driving force distribution.

For more information, refer to the "Drive Mode Integrated Control System (AWD)" section in chapter 6.

### Tire pressure



The tire pressure of each tire is displayed.

For more information, refer to the "Tire Pressure Monitoring System (TPMS)" section in chapter 8.

### Driving Assist view

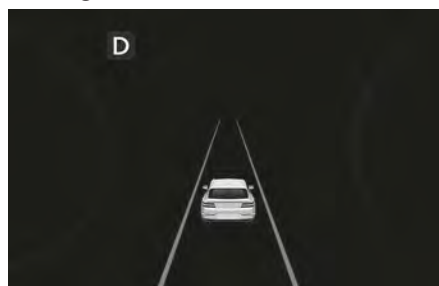

Displays the state of Smart Cruise Control, Lane Following Assist, Lane Keeping Assist, Highway Driving Assist, etc., when Driving Assist view is selected.

For more information, refer to each system information section in chapter 7.

## Vehicle Settings (Infotainment System)



Vehicle Settings in the infotainment system provide user options for the settings including door lock/unlock features, convenience features, driver assistance, etc.

### Vehicle Settings menu

- Driver Assistance
- Drive Mode
- Active Sound Design
- Head-Up Display
- Cluster
- Climate
- Seat
- Lights
- Door/Liftgate
- Digital key
- Convenience

### WARNING

Do not operate the Vehicle Settings while driving. You may be distracted from the driving task and could collide.

## Setting Your Vehicle

1. Press the **SETUP** button on the main keyboard.

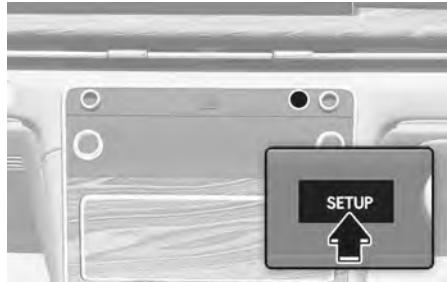

2. Select **Vehicle** and change the settings for features.



### *i* Information

The infotainment system may change after software updates. For more information, refer to the manual provided in the infotainment system and the quick reference guide.

# 5. Convenience Features

Accessing Your Vehicle .....	5-6
Smart Key .....	5-6
Immobilizer System .....	5-11
Genesis Digital Key .....	5-12
Digital Key (Smartphone) .....	5-12
Digital Key (Card Key) .....	5-18
Used Vehicle/Digital Key Maintenance .....	5-23
Limitations of the System .....	5-23
Fingerprint Authentication System .....	5-24
Fingerprint Authentication System Settings .....	5-24
Fingerprint Authentication System Operation .....	5-25
Limitations of the System .....	5-26
When Purchasing a Used Vehicle .....	5-26
Door Locks .....	5-27
Operating Door Locks From Outside the Vehicle .....	5-27
Operating Door Locks From Inside the Vehicle .....	5-28
Automatic Door Lock and Unlock Features .....	5-30
Electronic Child Safety Lock .....	5-31
Theft Alarm System .....	5-32
Advanced Rear Occupant Alert (ROA) .....	5-33
System Setting .....	5-33
System Operation .....	5-33
Rear Occupant Alert Precautions .....	5-34
Declaration of Conformity .....	5-34
Integrated Memory System .....	5-35
Storing Memory Positions .....	5-36
Recalling Memory Positions .....	5-36
Resetting the System .....	5-36
Seat Easy Access .....	5-37
Smart Posture Care System .....	5-38
Steering Wheel .....	5-38
Motor Driven Power Steering (MDPS) .....	5-38
Tilt / Telescopic Steering .....	5-39
Horn .....	5-40
Heated Steering Wheel .....	5-40
Steering Wheel Grip Sensor .....	5-41

Haptic Warning / Steering Wheel Vibration Warning .....	5-42
Mirrors.....	5-42
Inside Side View Mirror .....	5-42
Side View Mirrors .....	5-55
Reverse Parking Aid .....	5-57
Windows .....	5-58
Power Windows.....	5-59
Panoramic Sunroof .....	5-61
Power Sunshade.....	5-61
Tilt Open/Close.....	5-62
Slide Open/Close.....	5-62
Resetting the Sunroof .....	5-64
Sunroof Open Warning .....	5-64
Hood .....	5-65
Opening the Hood .....	5-65
Closing the Hood.....	5-65
Power Liftgate .....	5-66
Power Liftgate Operating Conditions .....	5-66
Operating the Power Liftgate .....	5-68
Setting the Power Liftgate.....	5-70
Resetting the Power Liftgate.....	5-71
Emergency Liftgate Safety Release .....	5-71
Smart Liftgate.....	5-72
Using Smart Liftgate .....	5-72
Deactivating Smart Liftgate.....	5-73
Detecting Area .....	5-73
Fuel Filler Door .....	5-74
Opening the Fuel Filler Door.....	5-74
Closing the Fuel Filler Door .....	5-75
Head-Up Display (HUD).....	5-76
Head-Up Display Settings.....	5-76
Head-Up Display Information .....	5-77
Precautions While Using the Head-Up Display.....	5-77
OTA Software Update .....	5-78
Downloading Software .....	5-78



# 5. Convenience Features

Approving Software Update.....	5-78
Preparing Software Update.....	5-78
Updating Software.....	5-79
Exterior Lights.....	5-80
Lighting Control.....	5-80
High Beam Operation.....	5-82
Turn Signals and Lane Change Signals.....	5-82
Battery Saver Function.....	5-83
Headlight Delay Function.....	5-83
Headlight Moisture Removal Function.....	5-83
High Beam Assist (HBA).....	5-84
High Beam Assist Setting.....	5-84
High Beam Assist Operation.....	5-84
High Beam Assist Malfunction and Limitations.....	5-85
Welcome System.....	5-86
Puddle Light and Door Handle Light.....	5-86
Interior Light.....	5-87
Interior Lights.....	5-87
Interior Light AUTO Cut.....	5-87
Front Lamps.....	5-87
Rear Room Lamp.....	5-88
Vanity Mirror Lamp.....	5-88
Rear Mirror Lamp.....	5-88
Glove Box Lamp.....	5-88
Door Handle Lamp/Foot Lamp/Door Courtesy Lamp.....	5-89
Mood Lamp.....	5-89
Interior Lights Always On.....	5-89
Cargo Area Lamp.....	5-89
Puddle Light.....	5-90
Wipers and Washers.....	5-90
Front Windshield Wipers.....	5-90
Front Windshield Washers.....	5-91
Rear Window Wiper and Washer.....	5-92
Automatic Climate Control System.....	5-93
Automatic Heating and Air Conditioning.....	5-97
Manual Heating and Air Conditioning.....	5-97

System Operation.....	5-107
System Maintenance.....	5-109
Windshield Defrosting and Defogging .....	5-112
To Defog Inside Windshield.....	5-112
To Defrost Outside Windshield .....	5-113
Rear Window Defroster.....	5-113
Climate Control Additional Features .....	5-114
Air Conditioning Auto-Drying .....	5-114
Auto Defogging System .....	5-114
Auto Dehumidify .....	5-115
Recirculating Air When Washer Fluid is Used .....	5-115
Sunroof Inside Air Recirculation.....	5-116
Automatic Controls Linked to Climate Control Settings (for Driver's Seat).....	5-116
Recirculating Air When Entering a Tunnel.....	5-116
Storage Compartment.....	5-117
Center Console Storage .....	5-117
Rear Console Storage .....	5-118
Glove Box .....	5-118
Sunglass Holder.....	5-118
Storage Box.....	5-119
Cargo Tray.....	5-119
Interior Features.....	5-119
Cup Holder.....	5-119
Ashtray .....	5-120
Armrest Warmer .....	5-120
Sunvisor.....	5-121
Rear Mirror .....	5-121
Power Outlet.....	5-121
USB Charger .....	5-122
AC Inverter .....	5-123
Wireless Smartphone Charging System .....	5-124
Clock.....	5-126
Coat Hook .....	5-126
Floor Mat Anchor(s).....	5-127
Rear Side Window Sunshades .....	5-127
Cargo Net Holder .....	5-129
Cargo Security Screen .....	5-129

# 5. Convenience Features

Cargo Shelf .....	5-130
Exterior Features .....	5-131
Roof Side Rails .....	5-131
Infotainment System .....	5-132
USB Port .....	5-132
Antenna .....	5-133
Steering Wheel Remote Controls .....	5-133
Infotainment System .....	5-134
Voice Recognition .....	5-134
Bluetooth® Wireless Technology .....	5-134
BANG & OLUFSEN Sound System .....	5-135

## Accessing Your Vehicle

### Smart Key

Your Genesis Branded Vehicle uses a Smart Key, which you can use to lock or unlock the driver's and passenger's doors and the rear liftgate, and start the engine.



- (1) Door lock
- (2) Door unlock
- (3) Liftgate open/close
- (4) Panic
- (5) Remote start
- (6) Remote Smart Parking Assist (Forward/Backward) (if equipped)

### Locking your vehicle



To lock:

1. Close all doors, hood, and liftgate.
2. Have the smart key with you.
3. Touch the door handle touch sensor or press the Door lock button (1) on the smart key. The hazard warning lights blink.

4. Make sure the doors are locked by pulling the door handle.

### *i* Information

- The side view mirror will fold if **On Door Unlock** is selected from the Settings menu in the infotainment system. Select:
  - **Setup > Vehicle > Lights > Welcome Mirror > On Door Unlock**
- The door handle touch sensor only operates when the smart key is within 40 in. (1 m) from the outside door handle.
- If you lock the doors using the door handle button or touch sensor, the doors are not locked under the following circumstances:
  - The smart key is in the vehicle.
  - The Engine Start/Stop button is in the ACC or ON position.
  - Any door is open.If this occurs, a chime sounds for a few seconds. Check the vehicle before attempting to lock the vehicle again.

### *i* Information

If the smart key is not recognized, the touch sensor will not work. For more information, refer to the "Smart key precautions" section in this chapter.

### **!** WARNING

Do not leave the Smart Key in your vehicle with children that are unattended or unsupervised. Children could unintentionally press the Engine Start/Stop button or could operate the power windows or other vehicle controls or even cause the vehicle to move. This may result in serious injury or death.

### Unlocking your vehicle (When the Two Press Unlock feature is off)



To unlock:

1. Have the smart key with you.
2. Put your hand in the door handle or press the Door unlock button (2) on the smart key. All doors unlock and the hazard warning lights blink two times.

### Unlocking your vehicle (When the Two Press Unlock feature is on)

To unlock your vehicle using the door handle touch sensor or the Smart Key:

1. Make sure you have the smart key in your possession.
2. Put your hand in the door handle or press the Door Unlock button (2) on the smart key.
3. The driver's door will unlock.
4. If you touch the door unlock sensor inside of the front door handle to unlock the doors within 4 seconds, all of the doors will unlock. When the doors unlock, the hazard warning lights will blink two times and the chime will sound.
5. After unlocking the doors, the doors will automatically re-lock after 30 seconds unless a door is opened.

### Two Press Unlock Feature

The priority for unlocking the driver door only, or unlocking all the doors with one press may be adjusted in the Settings menu in the infotainment system.

The Two Press Unlock feature, when enabled, will require the user to press the door unlock button once for driver door only and twice for unlocking all the doors.

- **Setup > Vehicle > Door > Two Press Unlock**

The Two Press Unlock feature can also be enabled or disabled by pressing the door lock and unlock buttons simultaneously on the Key:

Press and hold both the Door Lock button and the Door Unlock button simultaneously until the hazard warning lights blink.

This will enable or disable the Two Press Unlock feature. Repeat this procedure to enable/disable the mode again.

#### *i* Information

- If you press the front passenger outside door handle with the smart key in your possession, all the doors will unlock.
- The Two Press Unlock feature is off when the vehicle is first delivered. To use the feature, enable the feature from the Settings menu in the infotainment system.

#### *i* Information

- The side view mirror will unfold if **On Door Unlock** is selected from the Settings menu in the infotainment system. Select:
  - **Setup > Vehicle > Lights > Welcome Mirror > On Door Unlock**
- The door handle touch sensor only operates when the smart key is within 40 in. (1 m) from the outside door handle.

- After unlocking the doors, the doors are locked automatically after 30 seconds unless a door is opened.
- The infotainment system may change after software updates. For more information, refer to the manual provided in the infotainment system and the quick reference guide.

### Setting the door lock/unlock prevention feature

The doors may lock or unlock if the touch sensor of the outer door handle is recognized while washing your car or due to heavy rain.

To prevent unintentional door lock or unlock, press the lock button on the smart key and immediately press the unlock button along with the lock button for more than 4 seconds. The hazard warning lights blink four times.

At this time, the doors are not lock or unlock even though the touch sensor is touched on the outside door handle.

To deactivate the function, press the door lock or unlock button on the smart key.

### *i* Information

- During a car wash or rain, in order to minimize unintentional operation of the touch sensor, the touch sensor may become insensitive. This is not a malfunction.
- The doors may not lock or unlock in the following situations.
  - If the touch sensor is touched with gloves on
  - If the door is suddenly approached

### Opening the liftgate

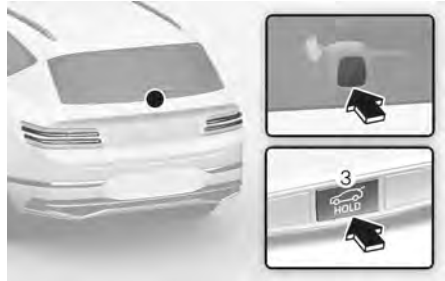

To open the liftgate:

1. Have the smart key with you.
2. Press the liftgate open/close button on the vehicle or press and hold the Liftgate open/close button (3) on the smart key for more than one second. The hazard warning lights blink two times and the liftgate opens.

### *i* Information

The liftgate open/close button only operates when the smart key is within 40 in. (1 m) from the liftgate.

### Panic

Press and hold the Panic button (4) for more than one second. The horn sounds and hazard warning lights will blink for about 30 seconds. To cancel the panic mode, press any button on the Smart Key.

### Remotely starting vehicle

 if equipped

To start the vehicle remotely:

1. Press the door lock button on the smart key within about 32 feet (10 m) from the vehicle.
2. Press and hold the Remote start button (5) on your smart key within 4 seconds from when you have pressed the door lock button. The engine starts.
3. To turn off the engine, press the Remote start button (5) once.

### *i* Information

- The vehicle must be in P (Park) for the remote start function to start.
- The engine turns off if you get inside the vehicle without a registered smart key.
- The engine turns off if you do not get inside the vehicle within 10 minutes after remotely starting the vehicle.
- The Remote start button (5) may not operate if the smart key is not within 32 feet (10 m) from the vehicle.
- The vehicle does not remotely start if the engine hood or liftgate is open.
- Do not idle the engine for a long time.
- Do not operate remote start in closed areas where there is no adequate ventilation for the engine exhaust.

### **Remotely moving vehicle forward or backward**

 if equipped

Some models are equipped with the Remote Smart Parking Assist feature. With the smart key, the vehicle can be moved forward or backward remotely using the Forward or Backward button (6) on the smart key.

For more information, refer to the "Remote Smart Parking Assist 2 (RSPA 2)" section in chapter 7.

### **Starting the vehicle**

Your vehicle is equipped with a Engine Start/Stop button instead of a key cylinder. You can leave your smart key in your pocket or purse when you start your vehicle.

For more information, refer to the "Engine Start/Stop Button" section in chapter 6.

### *i* Information

If the smart key is not moved for some time, the detection function for smart key operation will pause. Lift the smart key to activate the detection function again.

### **NOTICE**

To prevent damaging the smart key:

- Keep the smart key in a cool, dry place to avoid damage or malfunction. Exposure to moisture or high temperature may cause the internal circuit of the smart key to malfunction. This may not be covered under warranty.
- Avoid dropping or throwing the smart key.
- Protect the smart key from extreme temperatures.

### **Using mechanical key**

If the smart key does not operate normally, you can lock or unlock the driver's door by using the mechanical key.



1. Press the **GENESIS** text section of the Mechanical key to remove the case.

2. Remove the mechanical key from the case.



3. After use, reinstall the mechanical key in the reverse order of removal.

### **Loss of a smart key**

A maximum of two smart keys can be registered to a single vehicle. If you happen to lose your smart key, immediately take the vehicle and remaining keys to your authorized retailer of Genesis Branded products or tow the vehicle, if necessary.

### **Smart key precautions**

The smart key may not work if any of the following occur:

- The smart key is close to a radio transmitter such as radio station or airport that may interfere with normal operation of the transmitter.
- The smart key is near a mobile two way radio system or a mobile phone.
- Another vehicle's smart key is being operated close to your vehicle.
- If your windows are tinted, especially with metallic window tint, it may cause frequency interference, reducing the smart key operating range.
- The vehicle battery is discharged.
- Connecting an external device to the power outlet and placing the smart key near the external device.

If the smart key does not work correctly, open and close the door with the mechanical key. To start the engine, press the Engine Start/Stop button directly with the smart key. If you have a problem with the smart key, contact an authorized retailer of Genesis Branded products.

If the smart key is in close proximity to your mobile phone, the signal could be blocked by your mobile phone's normal operational signals. This is specifically relevant when the phone is active such as making and receiving calls, text messaging, and/or sending/receiving emails. If possible, avoid keeping the smart key and your mobile phone in the same location such as pants or jacket pocket to avoid interference between the two devices.

### **NOTICE**

- Keep the smart key away from electromagnetic materials that blocks electromagnetic waves to the key surface.
- Always have the smart key with you when leaving the vehicle. If the smart key is left near the vehicle, the vehicle battery may be discharged.

---

### **i Information**

This device complies with Part 15 of the FCC rules. Operation is subject to the following three conditions:

1. This device may not cause harmful interference, and
  2. This device must accept any interference received, including interference that may cause undesired operation.
  3. Changes or modifications not expressly approved by the party responsible for compliance could void the user's authority to operate the device.
-



### Replacing the battery

If the smart key is not working properly, replace the battery.

Battery Type: CR2032

To replace the battery:

1. Press the button [A] to remove the keyring fixed appliance.



2. Insert a flat head screwdriver into the inner groove to remove the smart key cover.
3. Remove the old battery.



4. Install a new battery and reinstall the smart key cover in the reverse order of removal. Make sure the battery position is correct. An improperly positioned battery may discharge the battery, causing smart key failure.

If you suspect your smart key might have sustained some damage, or you feel your smart key is not working correctly, contact an authorized retailer of Genesis Branded products.

### WARNING

This product contains a button battery.

If swallowed, a lithium button battery can cause severe or fatal injuries within 2 hours. Keep batteries out of reach of children.

If you think batteries may have been swallowed or placed inside any part of the body, seek immediate medical attention.

### Information



An inappropriately disposed battery may be harmful to the environment and human health. Always dispose used batteries in accordance with local law(s) or regulations.

### Immobilizer System

The immobilizer system helps protect your vehicle from theft. If an improperly coded key (or other device) is used, the engine's fuel system is disabled.

When the Engine Start/Stop button is pressed to the ON position, the immobilizer system indicator should come on briefly, then go off. If the indicator starts to blink, the system does not recognize the coding of the key.

Press the Engine Start/Stop button to the OFF position, then press the Engine Start/Stop button to the ON position again.

In some circumstances, the vehicle system may not recognize your smart key if another smart key device is nearby or a metal object such as a key chain is causing interference with the smart key.

If this occurs, your vehicle may not start. Remove any metal objects or additional keys near the smart key before attempting to start the vehicle again.

If the system repeatedly does not recognize the coding of the key, contact an authorized retailer of Genesis Branded products.

Do not attempt to alter this system or add other devices to it. Electrical problems could result that may make your vehicle inoperable.

### *i* Information

To prevent theft of your vehicle, do not leave spare keys anywhere in your vehicle. Your immobilizer password is a customer unique password and should be kept confidential.

---

### **NOTICE**

Avoid exposing the key to moisture, static electricity, and rough handling. The Immobilizer system may malfunction.

---

### *i* Information

This device complies with Part 15 of the FCC rules. Operation is subject to the following three conditions:

1. This device may not cause harmful interference, and
  2. This device must accept any interference received, including interference that may cause undesired operation.
  3. Changes or modifications not expressly approved by the party responsible for compliance could void the user's authority to operate the device.
- 

## Genesis Digital Key

Genesis digital key provides convenience to the driver, which the driver can use to lock or unlock the driver and passenger doors or the liftgate and turn on the vehicle.

### Digital Key (Smartphone)

#### *i* Information

- Genesis digital keys are only available on smartphone that support digital key functions, and digital key functions of smartphones are provide by smartphone manufacturers.
  - Available smartphone brands and models can be found on smartphone manufactures' website or Genesis website (<https://owners.genesis.com>).
  - Certain functions may not operate depending on whether the service is provided in the vehicle.
  - Depending on the availability of service on the vehicle, some functions may not operated.
- 

#### **Setting your smartphone**

To use the digital key (smartphone), download the Genesis Digital Key App and sign up for a Genesis account and service.

## Registering your digital key (smartphone)



[A] Vehicle authentication pad (wireless charging pad)

1. Turn on the vehicle with a smart key and have your smart key with you in the vehicle.
2. Put the gear in P (Park), select **Setup > Vehicle > Digital keys > Smartphone key > My Smartphone Key** from the infotainment system.
3. After selecting **Digital Key > Set Up Digital Key** from the Genesis Intelligent Assistant App in the smart phone, register the digital key according to the guidance in the smart phone screen.
  - Ultra Wide Band unsupported smartphone
    - Place your smartphone on the vehicle authentication pad (wireless charging pad) with the screen facing up.
    - The NFC Antenna position on Samsung device can be found in the following path: **Setup > Connections > NFC and contactless payments.**
    - The NFC Antenna position on Google Pixel phone can be found in the following path: **Setup > Connected devices > Connection preference > NFC.**
    - Ensure that the NFC Antenna position on the smartphone is in contact with the vehicle authentication pad (wireless charging pad).

- The NFC Antenna position on Apple iPhone is located at the top of the rear [A] and Apple WATCH is located at the center of the screen [B].



- The location of the NFC Antenna on the smartphone may vary by phone model, so please contact the smartphone manufacturer for details.
  - NFC communication may not work for some smartphones depending on the internal structure of the smartphone. Move the smartphone to the left or right of the vehicle authentication pad (wireless charging pad) to operate.
- Ultra Wide Band supported smartphone
    - The digital key can be registered if the smartphone is inside the vehicle even without placing it on the vehicle authentication pad (wireless charging pad).
4. Press **Save** button in the infotainment system to start registration. When the digital key (smartphone) is saved, a message appears on the infotainment system.

### *i* Information

- If you want to register a different digital key (smartphone), refer to "Deleting your digital key (smartphone)" and delete the digital key (smartphone) before re-registering. An active Digital Key can be shared through the Genesis Connected Services App with a different smartphone (Only for countries available with Genesis Connected Services).
  - During the digital key saving process, the process may cancel when:
    - The smartphone is removed from the vehicle authentication pad (wireless charging pad)
    - The infotainment system is changed
    - The engine is turned off
    - The gear is shifted
  - The registering process does not start if a smart key is not in the vehicle.
  - Some smartphones may not start the registering process depending on the internal structure. Move the smartphone to the left or right on the vehicle authentication pad (wireless charger pad) and try registering the smartphone.
  - Ultra Wide Band (UWB) is a radio technology that can use a very low energy level for short-range, high-bandwidth communications over a large portion of the radio spectrum.
- 

### *Using the digital key (smartphone)*

#### **Digital key touch control**

The driver can lock or unlock the door by placing the smartphone on the outside door handle, and the vehicle can be started by placing the smartphone on the vehicle authentication pad (wireless charging pad).

### *i* Information

The location of the NFC Antenna on the smartphone may vary by phone model, so please contact the smartphone manufacturer for details.

---

#### **Digital key close proximity control**

- If you have the smartphone in possession, the doors can be locked or unlocked without touching the smartphone to the door handle, but by touching the door lock/unlock sensor (engraved part) on the door handle. Also, the vehicle can be started by pressing the Engine Start/ Stop button without placing the smartphone on the vehicle authentication pad (wireless charging pad).
- When the smartphone and vehicle is connected by Bluetooth, the Remote Start, and Door Lock/Unlock functions are available using the App provided by the smartphone manufacturer.

### *i* Information

- The function is only available for Ultra Wide Band supported smartphone digital keys. To use the function, the smartphone's Bluetooth must be activated.
  - The necessary distance between the smartphone and vehicle for Bluetooth connection may vary depending on the surroundings of the vehicle and smartphone.
  - The Remote Start, Panic or liftgate open function may not be available depending on the country or vehicle type (hybrid, plug-in hybrid or electric vehicle).
-

### Locking/Unlocking the doors

- Ultra Wide Band unsupported smartphone

Samsung smartphones

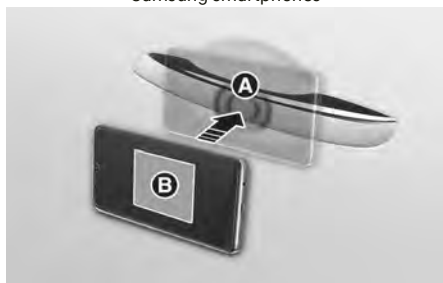

[A] Door handle authentication pad  
[B] NFC Antenna

Apple iPhone



[A] Door handle authentication pad  
[B] NFC Antenna

- If the driver places the digital key (smartphone) NFC antenna [B] to the driver's or passenger's door handle authentication pad [A] for more than 2 seconds, the door locks or unlocks.
- Ultra Wide Band supported smartphone
  - If you touch the door lock/unlock sensor (engraved part) on the door handle with the smart phone in possession, the door locks or unlocks.

After unlocking the doors, the doors are automatically re-locked after 30 seconds unless a door is opened.

If the smartphone digital key does not operate, try again after moving the smartphone away from the door handle authentication pad (more than 0.1 m (4 in.)).

### *i* Information

- You cannot lock your vehicle using the digital key (smartphone) if any of the following occurs:
  - The smart key is in the vehicle.
  - The Engine Start/Stop button is in the ACC or ON position.
  - Any of the doors, hood, or liftgate are open.
- If the smartphone is kept in the back pocket or bag, it may cause poor Bluetooth connection, or the door lock/unlock or vehicle start-up operation may be delayed.

### Starting the vehicle

- Ultra Wide Band unsupported smartphone
  - After placing your registered digital key (smartphone) on the vehicle authentication pad (wireless charging pad), depress the brake pedal and press the Engine Start/Stop button.
  - After starting the vehicle, the digital key (smartphone) may be removed from the vehicle authentication pad (wireless charging pad).
  - NFC communication may not work for some smartphones depending on the internal structure of the smartphone. Move the smartphone to the left or right of the vehicle authentication pad (wireless charging pad) to operate.

- Ultra Wide Band supported smartphone
  - With the smartphone inside the vehicle, depress the brake pedal and press the Engine Start/Stop button.
  - To start the vehicle remotely, use the App provided by the smartphone manufacturer to lock the vehicle with the door lock button, and press the remote start button within 4 seconds. The vehicle starts and the hazard warning lights blink.
  - Press the remote start button again to turn off the vehicle.

For more information on the basic way to start the vehicle, refer to the "Engine Start/Stop Button" section in chapter 6.

### *i* Information

If a shared digital key (smartphone) is used for the first time, the activating time may take longer.

- Place the shared digital key (smartphone) on the door handle authentication pad until the vehicle door lock/unlock activates.
  - If a shared digital key (smartphone) is first used on the vehicle authentication pad (wireless charger pad), the initial start of the vehicle may fail.
  - If the door lock/unlock is activated once with the shared digital key (smartphone) or the vehicle is started with the digital key (smartphone) on the vehicle authentication pad, the digital key (smartphone) is registered in the vehicle.
- 

### WARNING

The vehicle can be started when the registered smartphone is placed on the vehicle authentication pad (wireless charging pad). Therefore, do not leave unsupervised children or people who are not aware of the system since it can result in serious injury or death. In addition, always have the registered smartphone with you to prevent vehicle theft when leaving the vehicle.

---

### Operating the liftgate



- Ultra Wide Band supported smartphone
  - If the vehicle is locked, press the liftgate open button with the smartphone in possession to open the liftgate.
  - If you are in the detecting area behind the liftgate for more than 3 seconds with the smartphone in possession when **Smart Liftgate** is set, the liftgate opens automatically.

## WARNING

The vehicle can be started when the registered smartphone is placed on the vehicle authentication pad (wireless charging pad). Therefore, do not leave unsupervised children or people who are not aware of the system since it can result in serious injury or death. In addition, always have the registered smartphone with you to prevent vehicle theft when leaving the vehicle.

## Information

- The Ultra Wide Band supported smartphone digital key can be used only when the smartphone and vehicle are connected with Bluetooth.
  - The necessary distance between the smartphone and vehicle for Bluetooth connection may vary depending on the surroundings.
  - Window tinting substances may cause poor Bluetooth connection.
  - If the smartphone is kept in the back pocket or bag, it may cause poor Bluetooth connection, or the door lock/unlock or vehicle start-up operation may be delayed.
- The Ultra Wide Band supported smartphone digital key can be used only for a certain amount of time to optimize the performance of the smartphone and vehicle battery. If you stay near the vehicle for several minutes with the Ultra Wide Band supported smartphone, the Auto Unlock feature may not operate.
- Check the smartphone's setting menu or the App provided by the smartphone manufacturer for the connection of the vehicle and smartphone.
- The Ultra Wide Band supported smartphone digital key can also use the NFC function.

## Deleting your digital key (smartphone)

Turn on the vehicle with a smart key. Have your smart key with you in the vehicle.

## Deleting all registered digital key (smartphone)

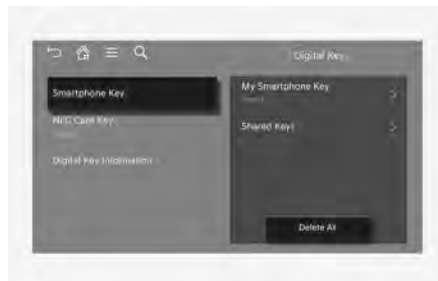

To delete all the registered digital key (smartphone), select **Setup > Vehicle > Digital Keys > Smartphone Key > Delete All** from the infotainment system.

- The **Delete All** button is disabled if there is no registered digital key (smartphone).

## Deleting my registered digital key (smartphone)



To delete only my registered digital key (smartphone), select **Setup > Vehicle > Digital Keys > Smartphone Key > My Smartphone Key > Delete** from the infotainment system.

- If a shared digital key (smartphone) is registered, it cannot be deleted.

- A new smartphone can be registered after deleting the existing digital key (smartphone) from **My Smartphone Key** menu.

### *i* Information

- If the registered digital key (smartphone) is deleted, the digital key saved in the smartphone is also deleted.
- If the digital key is deleted from the smartphone, the digital key (smartphone) registered in the vehicle is also deleted.
- The shared digital key registered in the vehicle cannot be deleted individually.
- Even though the Genesis Connected Services App is deleted from the smartphone, the digital key saved in the smartphone is not deleted.
- Management of the digital key saved in the smartphone is available from the Digital Key App provided by the smartphone manufacturer.

## Digital Key (Card Key)

### *How to register Digital key (Card Key)*

To use the card key as a digital key, follow the following procedure.



[A] Vehicle authentication pad (Wireless charging pad)

1. Have both of your smart keys with you in the vehicle.
2. Select **Setup > Vehicle > Digital Keys > NFC Card Key**, and check whether "Use" is selected in the infotainment system.
3. Place your card key on the vehicle authentication pad (wireless charging pad) while the engine is on.
4. Register your card key by selecting **Setup > Vehicle > Digital Keys > NFC Card Key > Save** from the Settings menu in the infotainment system.

### *i* Information

- Only one digital key (card key) can be registered to the vehicle. If it must be replaced, delete the existing card key before registering the new card key.
- To register a digital key (card key), both of your smart keys must be in the vehicle.
- Once a digital key (card key) is registered, it cannot be registered in another vehicle. It is possible to re-register it to the original vehicle.



### Using the digital key (card key)

The driver can lock or unlock the door by placing the card key on the outside door handle, and the vehicle can be started by placing the card key on the vehicle authentication pad (wireless charging pad).



[A] Door handle authentication pad

### Locking/Unlocking the doors

If the driver places the digital key (card key) to the driver's or passenger's door handle authentication pad [A] for more than 2 seconds, the door locks or unlocks.

If Two Press Unlock function is set, only the driver's door will be unlocked by touching the card key on the driver's door handle. Touch the card key once more within 4 seconds to unlock all doors.

After unlocking the doors, the doors are automatically re-locked after 30 seconds unless a door is opened.

### *i* Information

You cannot lock your vehicle using the digital key (card key) if any of the following occurs:

- The smart key is in the vehicle.
- The Engine Start/Stop button is in the ACC or ON position.
- Any of the doors, hood, or liftgate are open.

### Starting the vehicle

After placing your registered digital key (card key) on the vehicle authentication pad (wireless charging pad), depress the brake pedal and press the Engine Start/Stop button.

For more information on the basic way to start the vehicle, refer to the "Engine Start/Stop Button" section in chapter 6.

### **!** WARNING

The vehicle can be started when the registered card key is placed on the vehicle authentication pad (wireless charging pad). Therefore, do not leave unsupervised children or people who are not aware of the system since it can result in serious injury or death. In addition, always have the registered card key with you to prevent vehicle theft when leaving the vehicle.

### NOTICE

- The digital key (card key) may not work under the following conditions:
  - The digital key (card key) is not placed on the door handle authentication pad or vehicle authentication pad (wireless charging pad) correctly.
  - The digital key (card key) is near NFC-enabled cards such as credit cards or smartphones.
    - If the digital key (card key) does not work, try again after moving the digital key (card key) away from the door handle authentication pad (more than 4 in. (0.1 m)).
- The digital key (card key) can be damaged by impacts. If the digital key (card key) is damaged, replace the digital key (card key) with a new one and register it again.

- Long-time exposure to high temperature may cause the digital key (card key) to malfunction. Be careful not to expose the digital key (card key) to direct sunlight or high temperature.
- Leaving the digital key (card key) on the in-vehicle authentication pad (wireless charging pad) while driving may cause the digital key (card key) to malfunction. Remove the digital key (card key) from the in-vehicle authentication pad (wireless charging pad) after starting the vehicle.
- Keep the digital key (card key) away from the smartphone when charging the smartphone. If the digital key (card key) is placed between the smartphone and the in-vehicle authentication pad (wireless charging pad) while the smartphone is being charged, the digital key (card key) may malfunction. For example, when charging smartphone while the digital key (card key) is attached to the back of the smartphone case.

### Deleting your digital key (card key)

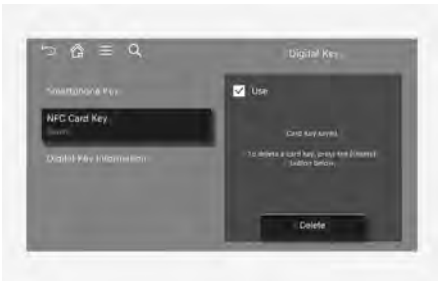

1. Turn on the engine with a smart key. Have your smart key with you in the vehicle.
2. Select **Setup > Vehicle > Digital Keys > Card Key > Delete** from the infotainment system.
  - The "**Delete**" button is disabled if there is no digital key (card key) registered.

## *i* Information

The infotainment system may change after software updates. For more information, refer to the user's manual provided in the infotainment system and the quick reference guide.

### **Personalized profile and vehicle settings**

You can set the registered digital key (smartphone) profiles for Driver 1 and Driver 2. When you use the digital key (smartphone), the vehicle can be set to the user-defined personalized profile (includes items such as vehicle settings and audio preferences).

### **Linking/Unlinking profile**

#### **How to link user profile**

1. Select **Setup > User Profile > Profile Settings > Link Digital Key (Smartphone)** from Settings menu in the infotainment system.
2. Select "**Link**" to connect the registered smartphone's digital key and the user's profile.
3. Follow the instructions according to the message on the infotainment system.

#### **How to unlink user profile**

Select **Setup > User Profile > Profile Settings**, and then deselect "**Link Digital Key (Smartphone)**" from Settings menu in the infotainment system.

- Unlinking is possible only when user profile is linked.

### *i* Information

- User profile cannot be linked to both Driver 1 and Driver 2 that are connected to single smartphone. Personalization operates with the recently linked user profile, and the previously linked user profile will be automatically canceled.
- User profile link works only when the digital key is registered to the vehicle.
- Digital key (card key) cannot be linked with a user profile.
- If the user profile linked digital key in the smartphone is deleted, the digital key should be re-registered and personalized by linking the user profile again.
- If you remove the smart phone from the in-vehicle authentication pad (wireless charging pad) before completing the user profile link, the linking process will not be completed normally.
- The infotainment system may change after software updates. For more information, refer to the user's manual provided in the infotainment system and the quick reference guide.

### *Vehicle personalization operation*

- The personalization function linked with digital key works when the profile linked smartphone is placed on the outside door handle authentication pad to lock or unlock the doors.
- The profile set by the digital key can be changed manually from the infotainment system.
- The personalization function using the digital key can be operated after linking the digital key in the infotainment system profile menu.
- The personalization function works only when the vehicle is OFF or when the vehicle is started remotely. If the vehicle is not started remotely, the personalization function does not work with the digital key.

### *i* Information

User profile operation according to door lock/unlock system is as follows:

Item	Personalization Operation
Initial value	Guest
Profile linked smartphone key	Linked profile
Profile unlinked smartphone key	Recently activated profile
NFC card key	
Smart key	

**Vehicle personalization with digital key**

The available personalization function in the vehicle is as follows.

System	Personalization Item	
Vehicle settings	Head-Up Display (HUD)	Position adjustment of image, Information display selection
	Lamp	Blink number of one-touch signal lamps
	Instrument Cluster	Information display on the cluster, Voice volume, Welcome sound
	Seat/Mirror/Steering wheel	Seat position, O/S mirror position, Steering wheel position, Easy Access
		Smart heating wire/ventilation On/Off
	Door	Automatic door lock/unlock, Two Press Unlock
	Smart phone wireless charging	Wireless charging On/Off
Air conditioning	Setting up temperature unit, Block air inflow/Automatic ventilation/Window defroster On/Off	
Infotainment system menu	Navigation	Preferred volume of the navigation system
		Recent destination
	User preset	My menu list settings, Radio preset
	Phone connectivity	Bluetooth preferential connection
CarPlay/Android Auto/MirrorLink On/Off		
Air conditioning	Operating condition	Latest operation setup of the following functions: Temperature (AUTO), air flow direction, air volume, air conditioner, air intake control, SYNC, Front windshield defroster, OFF

**⚠ CAUTION**

If you leave the digital key in the vehicle after locking or unlocking the doors or starting the vehicle with the smart key, the doors can be locked with the central door lock. Have the digital key with you at all times.

## *i* Information

The infotainment system may change after software updates. For more information, refer to the user's manual provided in the infotainment system and the quick reference guide.

## Used Vehicle/Digital Key Maintenance

### *Purchasing used vehicle*

When purchasing a used vehicle, make sure to delete the smartphone key and card key registered by the previous user.

If any of the digital key devices (smartphone key, card key) are registered in the vehicle, the message 'Digital key(s) active' will appear on the instrument cluster once when the vehicle is turned on after unlocking the vehicle door.

When purchasing a used car, be sure to check the message and delete the smart phone key and card key registered by the previous user. Please let us know the purchase of a used vehicle through Genesis Customer Care.

Check whether the card key that came with the used vehicle operates properly. If the card key does not work properly, delete the card key and register the smartphone key, and then re-register the card key.

### *Digital Key maintenance*

If you need to have your Digital Key system repaired or replaced, the registered smartphone key or card key can be deleted. In this case, you should delete the digital key on the smart phone and re-register the key.

## Limitations of the System

- Genesis Digital Key may not operate if any of the following occurs:
  - Smartphone battery or the vehicle battery is discharged.
  - NFC or Bluetooth is turned off on the smartphone settings.
  - A credit card is near your smartphone, or a metal or thick smartphone case is used.
  - The card key is in a wallet or card holder, or overlapped with other cards.
  - There is electronic interference by other vehicles, objects, etc.
  - If you use a smartphone cover that uses wireless communication or is made of metal, remove the smartphone cover.
- When you try to log in from another smart phone instead of the registered smart phone with same user account
- Smart phone rooting or app hacking is detected
- Smartphone's screen is off or locked
- Smartphone's mobile network setting is off or airplane mode is activated
- The vehicle may not be controlled by the smartphone if any of the following occurs:
  - Other smartphone functions (calls, urgent calls, or audio), apps, or wireless earphones are operating.
  - The Genesis Connected Services App function such as basic setting or app launching is limited by the prior policy according to the manufacturer.

## Fingerprint Authentication System

 If equipped

Fingerprint Authentication system provides features such as starting the engine, having access to personal information, unlocking profile, and exiting valet mode with a registered fingerprint.

A fingerprint must be registered in the User Profile Settings from the infotainment system to use the system.

The maximum of two fingerprints can be registered. Driver 1 and Driver 2 can register one fingerprint each.

### *i* Information

If no fingerprint is registered in the infotainment system, Fingerprint Authentication system does not operate.

## Fingerprint Authentication System Settings

You can set or delete a fingerprint through the infotainment system.

Follow the following procedure.

### *Registering fingerprint*



[A] Fingerprint sensor

1. Have both of your smart keys with you in the vehicle.

2. Turn on the engine and select **Setup > User Profile > Driver 1 > Fingerprint Identification** from the infotainment system.

3. After entering the profile password, select **Set/Delete Fingerprint > Set**.

4. Place your finger that you wish to register on the fingerprint sensor according to the instruction.

5. Following the instructions, place several parts of your fingerprint until the scanning process is complete.

When scanning is complete, the "**Saving fingerprint....**" appears and the fingerprint registering process is proceeded.

### *i* Information

- Remove all substances including protection film on the fingerprint sensor, and then register your fingerprint.
- The fingerprint registering process is canceled when the following condition occurs:
  - The infotainment system screen is altered.
  - The Engine Start/Stop button turns on or off.
  - The gear is shifted, and the vehicle is driven.

### *Deleting fingerprint*

1. Have one of your smart key with you in the vehicle.

2. Turn on the engine and select **Setup > User Profile > Driver 1 > Fingerprint Identification** from the infotainment system.

3. After entering the profile password, select **Set/Delete Fingerprint > Delete**.

4. Delete the registered fingerprint according to the message "**Delete all Driver 1 fingerprints?**".

### CAUTION

Do not participate in duplicating your fingerprint with anyone.

## Fingerprint Authentication System Operation

### *Using features with touch control*

The convenience features such as starting the engine, accessing personal information, unlocking profile, and exiting valet mode are available with the Fingerprint Authentication system.

When the fingerprint shape appears on the infotainment system screen, you should place your finger on the fingerprint sensor in the vehicle according to the instruction message for authorization and then you can operate the linked features without entering the password.

If the Fingerprint Authentication system does not work, pull your finger away from the fingerprint authentication sensor and then try again.

Fingerprint linked features can be turned on or off from the Settings menu.

Select: **Setup > User Profile > Driver 1 (or Driver 2) > Fingerprint Identification**

Fingerprint linked features	Characteristic
Starting engine	Start engine with fingerprint but without smart key.
Personal information access	Use features with fingerprint but without a password.
Profile unlock	
Valet mode exit	

## *i* Information

If the same fingerprint is registered for Driver 1 and Driver 2, the authentication result is linked to Driver 1, when authentication is successful.

### *Starting the engine*

 if equipped

Place your finger on the fingerprint sensor (1) to verify your fingerprint. After it is successfully verified, start the engine by pressing the Engine Start/Stop button (2) within 30 seconds.



Fingerprint authentication status	Light color	Message on cluster
Standby	White	-
Succeed	Blue	"Authenticate d. The vehicle can now be started"
Fail	Yellow	-
Restricted due to consecutive failure	Red	"Fingerprint authorization is locked out. Try again in XX min"

### **i** Information

- Fingerprint authorization is restricted for 1 minute, 3 minutes, or 5 minutes when failed every 5 times.
- For more information on how to start your vehicle with the Engine Start/Stop button, refer to the "Engine Start/Stop Button" section in chapter 6.
- If you are in the vehicle for an extended period without starting the engine, the fingerprint sensor may turn off. If this occurs, depress the brake pedal and verify your fingerprint again when the fingerprint sensor illuminates.

### Limitations of the System

- Fingerprint Authentication system may not work when:
  - Fingerprint authentication is performed with an unregistered fingerprint.
  - The fingerprint is not placed on the center of the fingerprint sensor.
  - The fingerprint sensor or fingerprint is wet or dirty.
  - The film on the sensor is not removed.
  - The registered fingerprint is wounded or swollen.
  - The hand is overly dry.
  - The sensor is touched shortly.
- If fingerprint authentication fails repeatedly, fingerprint recognition is temporarily restricted. You should try it later or try other methods such as inputting your password.
- All registered fingerprints may be deleted during repair due to a malfunction of the fingerprint authentication system or related parts. Have your smart key when you visit an authorized retailer of Genesis Branded products.

- You cannot use the fingerprint sensor when the vehicle is discharged.
- Gently place your finger on the fingerprint sensor. Fingerprint authentication attempts with excessive force may fail.

### **⚠** WARNING

Do not register children's fingerprints in the vehicle.

If you register children's fingerprints and leave them in the vehicle, unexpected accidents may occur.

---

### When Purchasing a Used Vehicle

If you purchase a used vehicle, you should confirm and delete all of the registered fingerprints in Driver 1 and Driver 2 profile.



## Door Locks

### Operating Door Locks From Outside the Vehicle

#### Using mechanical key



[A] Lock  
[B] Unlock

1. Pull the door handle (1).
2. Insert the mechanical key into the key cylinder and rotate (2) counterclockwise to lock [A] the vehicle and clockwise to unlock [B] the vehicle.

Once the doors are unlocked, they may be opened by pulling the door handle.

#### NOTICE

Do not apply excessive force to the door and door handle.

#### Using smart key

For more information, refer to the "Smart Key" in the previous pages.

#### *i* Information

- In cold and wet climates, door lock and door mechanisms may not work properly due to freezing conditions.
- If the door is locked/unlocked multiple times in rapid succession with either the vehicle key or door lock switch, the system may stop operating temporarily in order to protect the circuit and prevent damage to system components.

#### In case of an emergency



Doors without an outside key hole can be locked as follows:

1. Open the door.
2. Insert the long & flat objects like keys into the emergency door lock hole and turn the long & flat objects like keys to the lock position.
3. Close the door securely.

#### *i* Information

If the electrical power door lock switch does not operate (ex. dead car battery) and the liftgate is closed, you will not be able to open the liftgate until power is restored.

### Power door latch

 if equipped



If a door does not close completely but is closed to the first detent position, the door closes automatically.

#### CAUTION

To reduce the risk of injury:

- Before closing the door, check there are no obstructions in the path of the door.
- Keep your fingers away from the edge of the door or they may become caught when the power door latch operates.

#### Resetting the power door latch

The power door latch may need to be reset after the battery is discharged or disconnected or a related fuse has been replaced or disconnected.

To reset the power door latch, perform the following steps:

1. Close the door to the first detent position.
2. Open the door.

When this is complete, the power door latch is reset.

If the power door latch do not operate properly after resetting, have your vehicle inspected by an authorized retailer of Genesis Branded products.

## Operating Door Locks From Inside the Vehicle

### With the door inside handle



#### Front door

If the inner door handle is pulled when the door is locked, the door is unlocked and opened.

#### Rear door

If the inner door handle is pulled once when the door is locked, the door is unlocked. If the inner door handle is pulled once more, the door is opened.

#### Information

If a power door lock ever fails to function while you are in the vehicle try one or more of the following techniques to exit:

Operate the door unlock feature repeatedly (both electronic and manual) while simultaneously pulling on the door handle.

Operate the other door locks and handles, front and rear.

Lower a front window and use the mechanical key to unlock the door from outside.

## With the central door lock/unlock switch

### Driver and passenger door

Driver's door



Front passenger's door



When pressing the  portion (1) on the switch, all vehicle doors are locked.

- If any door is opened, the doors are not locked even though the lock switch (1) of the door is pressed.
- If the smart key is in the vehicle and any door is opened, the doors are not locked even though the lock switch (1) of the door is pressed.

When pressing the  portion (2) on the switch, all vehicle doors are unlocked.

When all vehicle doors are locked, the indicator lights on the driver's door and passenger's door turn off. If any door is unlocked, the indicator turns on.

### Rear door

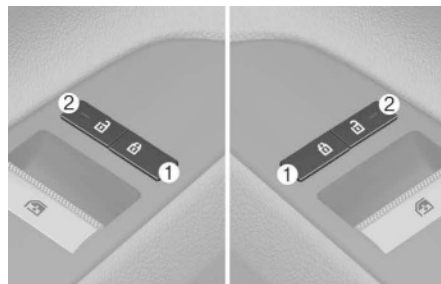

When the lock switch (1) is pressed, all the vehicle doors will lock.

When the unlock switch (2) is pressed (door indicator light ON), all the vehicle doors will unlock.

### Information

If all doors are locked with the rear door lock button, and the electronic child safety lock button (if equipped) in the driver's seat is turned ON (indicator light ON), the rear doors cannot be opened. If you want to open the rear doors:

- Unlock the door with the smart key from outside.
- Press the electronic child safety lock button on the driver's door to turn it off (indicator light OFF), then unlock the doors with the driver's or passenger's central door lock switch. (Electronic child lock OFF → Door unlocked)
- Press the electronic child safety lock button on the driver's door to turn it off (indicator light OFF), then pull the rear inner door handle twice.

 **WARNING**

- Always close and lock the doors while the vehicle is moving. If the doors are unlocked, the risk of being thrown from the vehicle in a collision increases.
  - Do not pull the inner door handle of the driver's or passenger's door while the vehicle is moving.
- 

 **WARNING**

Do not leave the elderly, children, or animals unattended in your vehicle. An enclosed vehicle can become extremely hot and the elderly, unattended children or animals who cannot escape the vehicle may be seriously injured or killed.

---

 **WARNING**

Always park your vehicle properly. Depress the brake, shift the gear to the P (Park), apply the parking brake, press the Engine Start/Stop button to the OFF position, close all windows, lock all doors, and always take the key with you.

---

 **WARNING**

Be careful when opening doors and watch for vehicles, motorcycles, bicycles, or pedestrians approaching the vehicle to prevent serious injury or death.

---

 **WARNING**

If you stay in the vehicle for a long time while the weather is very hot or cold, there are risks of injuries or danger to life. Do not lock the vehicle from the outside when someone is in the vehicle.

---

## Automatic Door Lock and Unlock Features

Your vehicle is equipped with features that will automatically lock or unlock your vehicle based on settings you select in the infotainment system.

### *Auto Lock Enable on speed*

When this feature is set in the infotainment system, all the doors will be locked automatically when the vehicle exceeds 15 km/h (9 mph).

### *Auto Lock Enable on shift*

When this feature is set in the infotainment system, all the doors will be locked automatically when the vehicle is shifted out of P (Park) while the engine is running.

### *Auto Unlock On shift to P*

When this feature is set in the infotainment system, all the doors will be unlocked automatically when the vehicle is shifted back into P (Park) while the engine is running.

### *Auto Unlock Upon vehicle off*

When this feature is set in the infotainment system, all the doors will be unlocked automatically when the vehicle is turned off.

 **Information**

The infotainment system may change after software updates. For more information, refer to the manual provided in the infotainment system and the quick reference guide.

---

### **Additional unlock safety feature airbag deployment**

As an additional safety feature, all doors will be automatically unlocked when an impact causes the airbags to deploy.

## **Electronic Child Safety Lock**



When the electronic child safety lock button is pressed and the indicator light on the button illuminates, the rear doors cannot be opened from inside the vehicle.

- The rear door window cannot be opened or closed while the electronic child safety lock button is in the LOCK position (indicator light ON).

For more information, refer to the "Windows" section in this chapter.

- Electronic child safety lock does not automatically turn on unless the driver presses the electronic child safety lock button.
- If 3 minutes passes after the Engine Start/Stop button is pressed to the OFF or ACC position, the indicator on the button turns off, and the driver cannot turn off electronic child safety lock by pressing the button. To turn off the function, press the Engine Start/Stop button to the ON position, and then press the electronic child safety lock button.

- If the power is supplied again after removing the battery or battery is discharged while the electronic child safety lock button is in the LOCK position, press the button once more to match the state of the indicator on the electronic child safety lock button and the actual state of the electronic child safety lock function.
- If the airbag is activated while the electronic child safety lock button is in the LOCK position (indicator light ON), the rear doors will unlock automatically.
- Vehicles equipped with the electronic child safety lock feature is not provided with a manual child safety lock.

### **⚠ WARNING**

Never allow children to open the rear doors while the vehicle is moving. They may fall out of the vehicle. Be sure to use the electronic child safety lock whenever children are in the vehicle.

### **NOTICE**

#### **Child safety lock failure / Child safety lock error**

When electronic child safety lock does not work even though the button is pressed, the message "**Child safety lock failure**" or "**Child safety lock error**" may be displayed and an alarm sounds. If this occurs, have your vehicle inspected by an authorized retailer of Genesis Branded products.

### **Safe Exit Assist (with electronic child safety lock)**

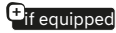
 if equipped

Safe Exit Assist helps prevent the rear occupant from opening the rear door. When an approaching vehicle from the rear area is detected after the vehicle stops, the rear doors will not unlock even when the driver tries to unlock the rear doors using the electronic child safety lock button.

For more information, refer to the "Safe Exit Assist (SEA)" section in chapter 7.

## Theft Alarm System

This system helps protect your vehicle and valuables. The horn sounds and the hazard warning lights blinks continuously if any of the following occur:

- A door is opened without using the smart key.
- The liftgate is opened without using the smart key.
- The engine hood is opened.

The alarm continues for 30 seconds, then the system resets. To turn off the alarm, unlock the doors with the smart key.

The Theft Alarm System automatically sets 30 seconds after you lock the doors and the liftgate. For the system to activate, you must lock the doors and the liftgate from outside the vehicle with the smart key or by touching the touch sensor on the outside of the door handle with the smart key in your possession.

The hazard warning lights blink and the chime sounds once to indicate the system is armed.

Once the security system is set, opening any door, liftgate, or hood without using the smart key causes the alarm to activate.

The Theft Alarm System is not set if the hood, liftgate, or door is not fully closed. If the system is not set, check the hood, liftgate, or doors are fully closed.

Do not attempt to modify this system or add other devices to it.

### ***i* Information**

- Do not lock the doors until all passengers have left the vehicle. If a door is opened after the system is armed, the alarm is activated.
  - If the vehicle is not disarmed with the smart key, open the doors by using the mechanical key and start the engine by directly pressing the Engine Start/Stop button with the smart key.
  - If the system is disarmed by unlocking the vehicle, but a door or liftgate is not opened within 30 seconds, the doors are relocked and the system is rearmed automatically.
  - It is not recommended to install any secondary aftermarket theft-alarm systems into the vehicle factory electrical system.
-

## Advanced Rear Occupant Alert (ROA)

 if equipped

Rear Occupant Alert is provided to help prevent the driver from leaving the vehicle with the rear passenger left in the vehicle.

### System Setting

To use Rear Occupant Alert, enable it from the Settings menu in the infotainment system. Select:

- **Setup > Vehicle > Convenience > Rear Occupant Alert**

### Information

The infotainment system may change after software updates. For more information, refer to the manual provided in the infotainment system and the quick reference guide.

### System Operation

- **First alert**  
When you turn off the engine and open the driver's door after opening and closing the rear door, the "**Check rear seat for passengers and belongings**" warning message appears on the cluster.
- **Second alert (if equipped)**  
After the first alert, the second alert operates when any movement is detected in the vehicle after the driver's door is closed and all the doors are locked. The horn sounds for about 25 seconds. If the system continues to detect a movement, the alert operates up to 8 times.  
Unlock the doors with the smart key to stop the alert.

- The system detects movement in the vehicle for 10 minutes after the door is locked.

### Information

- The second alert is available for vehicles equipped with the ROA sensor.
- The second alert is activated only after the prior activation of the first alert.
- If you do not want to use Rear Occupant Alert, press the **OK** button on the steering wheel when the first alert is displayed on the cluster. Doing so deactivates the second alert one time.

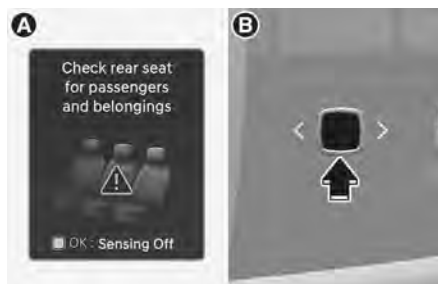

[A] Cluster  
[B] Steering wheel

- If the vehicle is started remotely (if equipped with Remote Start), inside movement detection stops.

## Rear Occupant Alert Precautions

- Make sure that all the windows are closed. If any window is open, the alert may occur when the sensor has detected any movement (e.g. wind or bugs).
- The alert may occur if any movement is detected in the driver's or passenger's seat.
- If all doors are locked with a passenger in the vehicle, the alert may occur.
- The alert may occur if there is an impact on the vehicle.
- If boxes or objects are stacked in the vehicle, the system may not detect passengers. The alert may occur if the boxes or objects fall off or move.
- The alert may occur with the doors locked if the vehicle is pushed or shaken, or washed, or if there is sufficient external vibration or noise.
- The alert may occur when there are metallic or liquid objects in the vehicle.

### **WARNING**

Even if your vehicle is equipped with Rear Occupant Alert, always check the rear seats before you leave the vehicle.

Rear Occupant Alert may not operate when:

- Movement does not continue for a certain period of time or the movement is small.
- A child is not seated in a child restraint system.
- The detection signal is weak because the signal is obscured by a seat or CRS (e.g. child is restrained in the forward-facing CRS).
- Movement is detected in areas other than the rear seats.
- The rear passenger is a child over 6 years.

- The rear passenger is covered with a fabric containing metallic substance such as a blanket.
- The sensor is dirty or blocked with foreign substances.
- An animal at the rear seat is not large enough to be detected by the sensor or there is hardly any movement.
- Attaching objects or modifying the interior ceiling, or the interior ceiling is deformed or damaged.
- There are electronic interference around the vehicle.

## Declaration of Conformity

The radio frequency components (ROA Radar Sensor) complies:

- For USA

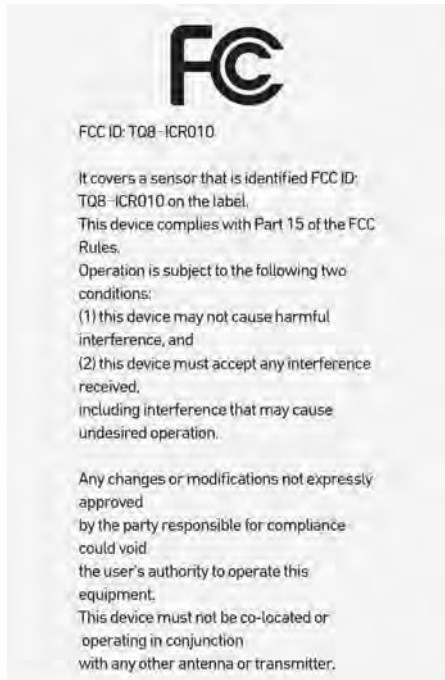



- For Canada

Model : ICR010  
IC ID : 5074A-ICR010

This device contains license exempt transmitter(s)/receiver(s) that comply with Innovation, Science and Economic Development Canada's license-exempt RSS(s). Operation is subject to the following two conditions:

- (1) This device may not cause interference.
- (2) This device must accept any interference, including interference that may cause undesired operation of the device.

L'émetteur/récepteur exempt de licence contenu dans le présent appareil est conforme aux CNR d'Innovation, Sciences et Développement économique

Canada applicables aux appareils radio exempts de licence.

L'exploitation est autorisée aux deux conditions suivantes :

- 1) L'appareil ne doit pas produire de brouillage;
- 2) L'appareil doit accepter tout brouillage radioélectrique subi, même si le brouillage est susceptible d'en compromettre le fonctionnement.

## Integrated Memory System



The Integrated Memory System for the driver's seat and the front passenger's seat (if equipped) allows the driver and front passenger to store and recall the following memory settings with a simple button operation.

- Driver's or front passenger's (if equipped) seat position
- Steering wheel position (power adjustment)
- Side view mirror position
- Head-Up Display (HUD) position (if equipped)

### WARNING

Never attempt to operate the Integrated Memory System while the vehicle is moving to prevent serious injury or death.

### *i* Information

- If the battery is disconnected, the memory settings are erased.
- If Integrated Memory System does not operate normally, contact an authorized retailer of Genesis Branded products.

## Storing Memory Positions

1. Make sure the Engine Start/Stop button is in the ON position and the gear is in P (Park).
2. Adjust the driver's seat or front passenger's seat, side view mirror, steering wheel, and head-up display to the desired position.
3. Press the **SET** button. The system beeps once and "**Press button to save settings**" appears on the infotainment system.
4. Press one of the memory buttons (1 or 2) within 4 seconds. The system beeps twice when successfully stored.
5. "**Driver 1 (or 2) settings saved**" appears on the infotainment system.

## Recalling Memory Positions

1. Make sure the Engine Start/Stop button is in the ON position and the gear is in P (Park).
2. Press the desired memory button (1 or 2). The system beeps once, and then the seat position, side view mirror position, steering wheel position, and head-up display position are automatically adjusted to the stored positions.
3. "Driver 1 (or 2) settings applied" appears on the infotainment system.

### *i* Information

- If you press the **SET** button or the corresponding IMS memory (1 or 2) for which the settings are being recalled, the IMS temporarily deactivates.  
If you press the **SET** button or the number 1 button with the number 1 setting in operation, the IMS temporarily deactivates.  
If you press the number 2 button, the IMS memory settings activate according to number 2.

- If you adjust the driver seat while IMS is adjusting the seat and the mirror, the system stops the adjustments.
- 

## Resetting the System

Take the following procedures to reset integrated memory system, when it does not operate properly.

### *Resetting the Integrated Memory System*

1. Make sure that the gear is in P (Park) and the engine is ON, and then open the driver's door.
2. Adjust the driver's seat and seatback to the foremost position.
3. Press and hold both the number 1 button and the driver's seat movement switch for about two seconds.
4. Release the number 1 button and the driver's seat switch when a beep sounds.

### *While resetting the Integrated Memory System*

A notification sound is heard and the seat is adjusted to the most reward position. Then the seat and seatback move to the default center position.

The resetting procedure and the notification sound may stop if:

- The memory button is pressed.
- The seat control switch is operated.
- The gear is shifted out of P (Park).
- The driving speed exceeds 3 mph (5 km/h).
- The driver's door is closed.

**NOTICE**

- If the seat movement or notification sound stops before the process is complete, restart the resetting procedure.
- Before resetting the IMS, make sure there are no objects on or around the driver's seat.

**Seat Easy Access**

The system moves the driver's seat and the front passenger's seat automatically as follows:

- Exiting the vehicle:
 

The driver's seat and steering wheel move as follows when the Engine Start/Stop button is in the OFF position with the gear in P (Park), and the driver's door open.

  - Driver seat: Moves rearward depending on the distance selected from the Settings menu in the infotainment system.
  - Steering wheel: Moves upward
  - Seat bolster (if equipped): Adjusted to the default position.

***i* Information**

- On a regular basis, the steering wheel moves forward to adjust its location by itself.
- The driver's seat or the front passenger's seat may not move rearward if there is not enough space between the driver's seat or the front passenger's seat and the second row seats.

- Entering the vehicle:
 

The driver's seat and steering wheel move back to its original position when the Engine Start/Stop button is pressed to the ACC, ON or START position or while carrying the smart key, the driver's door is closed with the Engine Start/Stop button in the OFF position.
- The passenger seat moves forward or rearward when the passenger side door is closed or opened. (if equipped)
- You can set the Seat Easy Access function from the Settings menu in the infotainment system. Select:
  - Driver seat
 

**Setup > Vehicle > Seat > Seating Easy Access > Driver Seat Easy Access > Normal/Extended/Off**
  - Steering wheel
 

**Setup > Vehicle > Seat > Seating Easy Access > Steering Easy Access**
  - Passenger seat (if equipped)
 

**Setup > Vehicle > Seat > Seating Easy Access > Front Passenger Seat**

***i* Information**

The infotainment system may change after software updates. For more information, refer to the manual provided in the infotainment system and the quick reference guide.

## Smart Posture Care System

 If equipped

The Smart Posture Care system automatically provides a healthy posture (position) for the driver's back, and sets the steering wheel, side view mirrors, head-up display positions according to the driver's body measurements.

### *i* Information

If the Seat Posture Care system does not operate normally, have the system inspected by an authorized retailer of Genesis Branded products.



1. Check that the gear is in P (Park) while the Engine Start/Stop button is in the ON position.
2. Select **Setup > Vehicle > Seat > Smart Posture Care > Enter Driver's Information** from the Settings menu in the infotainment system.
3. Enter information (Height, Seat height, Weight) in the infotainment system.
4. After entering the driver's information, press **Posture Analysis > Adjust Posture > Save Current Posture**. The driver's seat, steering wheel, side view mirrors, and head-up display will be adjusted.

### *i* Information

The infotainment system may change after software updates. For more information, refer to the manual provided in the infotainment system and the quick reference guide.

## Steering Wheel

### Motor Driven Power Steering (MDPS)

The system assists you with steering the vehicle. If the vehicle is turned off or if the power steering system becomes inoperative, you can still steer the vehicle, but it requires increased steering effort.

If you notice any change in the effort required to steer during normal vehicle operation, contact an authorized retailer of Genesis Branded products.

### NOTICE

If Motor Driven Power Steering () warning light and the message "**Check motor driven power steering**" appear on the instrument cluster, you can continue to steer the vehicle, but it requires increased effort. Contact an authorized retailer of Genesis Branded products and have the system inspected as soon as possible.

## *i* Information

During normal vehicle operation:

- The steering effort may be high immediately after pressing the Engine Start/Stop button to the ON position. This happens as the system performs the MDPS system diagnostics. When the diagnostics are completed, the steering wheel effort returns to its normal condition.
- When the battery voltage is low, you may have to use more effort to steer. This is a temporary condition and returns to normal condition after charging the battery.
- A click noise may be heard from the MDPS relay after the Engine Start/Stop button is in the ON or OFF position.
- Motor noise may be heard when the vehicle is at a stop or at low speeds.
- When you operate the steering wheel in low temperatures, abnormal noise may occur. When the temperature rises, the noise disappears.
- When an error is detected from MDPS, the steering effort assist function is not activated. Instrument cluster warning lights may illuminate or the steering effort may be high. If these symptoms occur, drive the vehicle to a safe location as soon as possible. Have your vehicle inspected by an authorized retailer of Genesis Branded products as soon as possible.

## Tilt / Telescopic Steering

Adjust the steering wheel toward your chest, not toward your face. Make sure you can see the instrument cluster warning lights and gauges. After adjusting, push the steering wheel up and down to be in the locked position.

### WARNING

Never adjust the steering wheel while driving. This may cause loss of vehicle control resulting in a collision.

### Power adjustment



To adjust:

- Push the switch (1) up and down to adjust the angle (2).
- Push the switch forward or rearward to adjust the height (3).

### NOTICE

Do not adjust the steering wheel longer than necessary when the engine is turned off. This may result in unnecessary battery drain.

### Resetting the steering wheel power adjustment

If adjustment is no longer possible within the operable range while adjusting the steering wheel position (angle or height), reset as follows:

1. From the position the steering wheel has stopped, push the control switch (1) for 10 seconds in the direction you were adjusting the steering wheel. The steering wheel moves in the direction the control switch is pushed.
2. Continue pushing the switch (1) for at least 2 seconds after the steering wheel has stopped. Resetting is completed after the operational range is recognized.

If the adjustment is still not possible after resetting the steering wheel power adjustment, have the system inspected by authorized retailer of Genesis Branded products.

### Horn



To sound the horn, press the area indicated by the horn symbol on your steering wheel (see illustration). The horn operates only when this area is pressed.

#### **NOTICE**

Do not strike the horn severely or hit it with your fist. Do not press on the horn with a sharp-pointed object.

### Heated Steering Wheel



While the engine is running, touch the heated steering wheel icon to warm the steering wheel.

#### **Manually adjusting temperature**

Each time you press the heated steering icon, the temperature changes as follows:

- Off > High > Low
- Pressing the icon when temperature is low, the heated steering wheel turns off.

#### **Automatically adjusting temperature**

- When high is manually selected, the heated steering wheel automatically changes to the low position after 30 minutes. You can turn off the heated steering wheel by pressing the icon to the OFF position.
- When low is manually selected, the heated steering wheel is not be controlled manually.

### **Automatic Controls Linked to Climate Control Settings**

The heated steering wheel automatically controls the steering wheel temperature depending on the ambient temperature when the engine is running.

- To use this feature, enable it from the Settings menu in the infotainment system.  
Select: **Setup > Vehicle > Seat > Warmer/Ventilation Features > Automatic Controls Linked to Climate Control Settings > Steering Wheel Warmer** (or **Steering wheel heating**)
- If you press the heated steering wheel icon when the feature is set, you must control the heated steering wheel manually.
- The heated steering wheel defaults to the OFF position whenever the Engine Start/Stop button is pressed to the ON position. However, if the Automatic Controls Linked to Climate Control Settings feature is ON, the heated steering wheel turns on and off depending on the outside temperature.

#### ***i* Information**

The infotainment system may change after software updates. For more information, refer to the user's manual provided in the infotainment system and the quick reference guide.

#### **NOTICE**

- Do not install any cover or accessories on the steering wheel to prevent damage to the heated steering wheel system.
- Do not strike the steering wheel grip surface with sharp sharp-pointed objects. This may damage the heating element in the steering wheel.
- Do not clean the steering wheel surface using the following products.
  - Organic solvents such as thinner, alcohol, and gasoline
  - Chemical products such as leather cleaner, coating agent, and wax

### **Steering Wheel Grip Sensor**

While driving the vehicle with the Driver Assistance system on, it detects whether the driver is holding the steering wheel and displays the Hands-off warning when the driver is not holding the steering wheel. Refer to "Hands-off warning" from "Lane Keeping Assist (LKA)", "Lane Following Assist (LFA)", and "Highway Driving Assist (HDA)" sections in chapter 7 for details.

In the following situations, the sensor may fail to detect the driver's hands although the driver is holding the steering wheel.

- When the driver is wearing gloves.
- When accessories such as a cover is attached on the steering wheel.
- When electronic device is touching the steering wheel.
- When the steering wheel is wet.

 **CAUTION**

The steering wheel sensor may not work properly if the following precautions are not followed.

- Do not modify the steering wheel cover.
  - Do not attach accessories on the rim of the steering wheel.
  - Do not touch the steering wheel with electronic devices. (e.g. laptop, tablet PC, etc.)
  - Do not touch the steering wheel with metallic or conductive objects. (e.g. tumbler, soda can, etc.)
  - Do not excessively wet the steering wheel. (e.g. spilled water, wet tissue, vapor from steam wash)
- 

## Haptic Warning / Steering Wheel Vibration Warning

If equipped with haptic steering wheel, the Driver Assistance system vibrates the steering wheel to warn the driver when the system indicates hazardous situations.

### *Setting haptic warning*

While the engine is running, select:

**Setup > Vehicle > Driver Assistance > Haptic Warning** in the infotainment system.

See description of each function from "Driver Assistance System" in chapter 7 for details.

## Mirrors

### Inside Side View Mirror

Before driving your vehicle, check to see that your inside side view mirror is properly positioned. Adjust the side view mirror so that the view through the rear window is properly centered.

 **WARNING**

Make sure your line of sight is not obstructed. Do not place objects on the rear seat or in the cargo area that may interfere with your vision through the rear window.

---

 **WARNING**

To prevent serious injury during a collision or deployment of the airbag, do not modify the side view mirror and do not install a wide mirror.

---

 **WARNING**

Never adjust the mirror while driving. This may cause loss of vehicle control and result in a collision.

---

**NOTICE**

When cleaning the mirror, use a paper towel or similar material dampened with glass cleaner. Do not spray glass cleaner directly on the mirror as this may cause the liquid cleaner to enter the mirror housing.

---



### Electric Chromic Mirror (ECM)



[A] Indicator

When the engine is running, the glare from vehicle headlamps behind you is automatically controlled by the sensor mounted in the rearview mirror.

Whenever the gear is shifted to R (Reverse), the mirror automatically goes to the brightest setting in order to improve the driver's view behind the vehicle.

### Digital center mirror (DCM)

 if equipped

The digital center mirror is a system that uses the camera on the rear of the vehicle and displays the rear image on the screen of the digital center mirror. The digital center mirror allows the driver to see the rear view despite obstructions, such as the head restraint or luggage, ensuring rear visibility.

### WARNING

Be sure to read the precautions and instructions before using the digital center mirror. Failure to follow the precautions and instructions for proper use of digital center mirror may result in serious injury:

- You are responsible for driving safely when using the digital center mirror. It is not a substitute for safe driving practices. Always check the blind spot of the digital center mirror before driving.

- Never operate the digital center mirror while driving. This may cause loss of vehicle control and result in a collision.
- Never disassemble or modify the digital center mirror's camera unit or wirings.

If you notice smoke or any smell coming from the digital center mirror, stop using the system immediately. Have the system inspected by an authorized retailer of Genesis Branded products.

### CAUTION

- The image areas displayed in the conventional rearview mirror mode and the digital center mirror mode are different. Check the image areas displayed in different modes before driving the vehicle.
- Switch to the conventional rearview mirror mode when the digital center mirror is not functioning normally. A light beam or flash may appear if strong light sources such as direct sunlight or vehicle headlights obstruct the rearview camera.
- Always keep the rear view camera lens clean. If the lens is blocked or covered, the digital center mirror may not operate normally. Clean with a damp soft cloth.

### Digital center mirror components

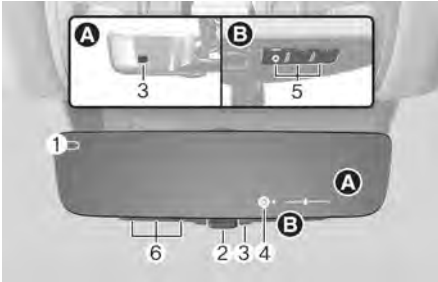

- (1) Camera indicator
- (2) Mode selection lever (conventional rearview mirror/digital center mirror)
- (3) Sensor
- (4) Icon display area
- (5) Menu/Adjustment button
- (6) HomeLink Channel

### Changing modes

Pull the lever towards you to use the digital center mirror mode or push the lever towards the front windshield to use the conventional rearview mirror mode.

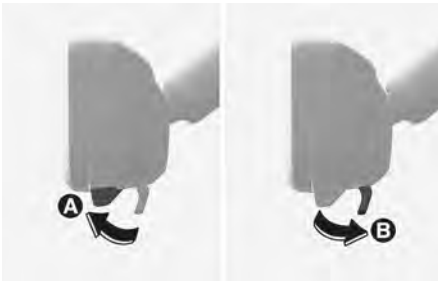

- [A] Digital center mirror mode  
[B] Conventional rearview mirror mode

### *i* Information

- If the digital center mirror mode is selected, the rear view is shown on the inside rearview mirror and the camera (📷) indicator appears on the top left side of the mirror.
- The digital center mirror turns on when the Engine Start/Stop button is in the ON or START position and turns off when the Engine Start/Stop button is in the ACC or OFF position.
- The conventional rearview mirror can be used when the digital center mirror mode is turned off.
- Use the conventional rearview mirror mode when the display of the digital center mirror mode seems blur due to strong light sources.
- If the display is difficult to see due to reflected light, close the sunshade of the sunroof (if equipped).
- When driving at night, the color of the objects displayed on the digital center mirror may differ from the actual color.
- Depending on your physical condition or age, it may take longer than usual to focus on the displayed image. If this occurs, use the conventional rearview mirror mode.

### Adjusting the mirror height

Select the conventional rearview mirror mode, adjust the height of the rearview mirror so that the view through the rear window is properly centered.



### Setting the digital center mirror

1. Press the Engine Start/Stop button to the ON or START position and pull the lever towards you to use the digital center mirror mode [A].

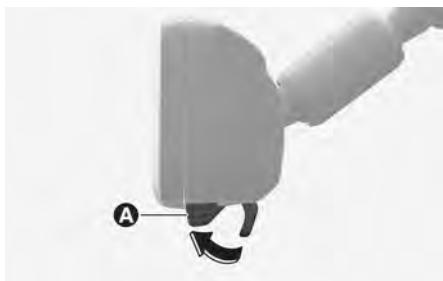

2. Press the menu button (1), and then press the adjustment button (2 or 3) to adjust the brightness and vertical angle of the display.

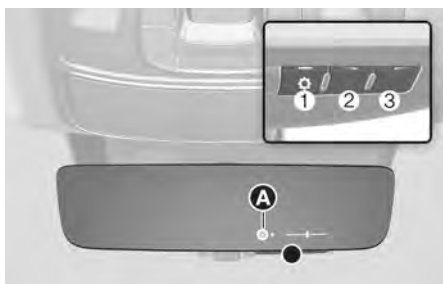

- Each time the menu button (1) is pressed the brightness (☀️) icon or angle (📏) icon appears in the icon display area [A].
- The brightness and vertical angle can be adjusted by using the adjustment button (2 or 3) when the icon is displayed.
- If a button is not operated for about 5 seconds or more, the icon disappears, and the display cannot be adjusted.

### ⚠️ CAUTION

- Make sure the liftgate is closed before driving. When the liftgate is open, the rear image may not be displayed normally on the digital center mirror.
- Do not let the passengers stare at the displayed image when the vehicle is being driven. It may cause motion sickness.
- Adjust the digital center mirror to an appropriate brightness. If your eyes become tired, change the to conventional rearview mirror mode.
- Do not block or cover the light sensors. If the light sensors are blocked or covered, the brightness may not be displayed normally.

### Precautions while using the digital center mirror

- Do not clean the mirror with cleaning agents containing thinner, benzene, alcohol, or other petroleum based cleaning products.
- Do not contaminate the rear view camera lens with organic solvent, vehicle wax, window cleaner, or glass coating when washing the vehicle. If contaminated, wipe it off as soon as possible.
- Clean the camera lens with a damp soft cloth. Scratching or damaging the lens surface may reduce digital center mirror performance.

## Convenience Features

- Never disassemble or modify the digital center mirror's camera unit or wirings, and never apply any impact on it.
- To prevent the battery from discharging, do not use the digital center mirror when the engine is not running.
- Do not attach an antenna of a wireless device near the digital center mirror. Electric wave from a wireless device may cause disturbed images.
- Never rotate the body of digital center mirror more than 90 degrees or excessively press the adjustment buttons.

### CAUTION

If you suspect a malfunction while using the digital center mirror, push the mode selection lever towards the front windshield to switch to the conventional rearview mirror mode. Have your vehicle inspected by an authorized retailer of Genesis Branded products.

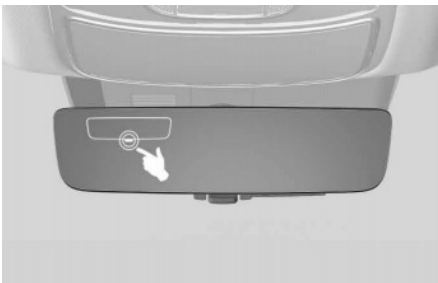

- If the error (⚠) icon appears, the digital center mirror may not be working properly. Change to conventional rearview mirror mode.
- If the digital center mirror is extremely hot, the high temp (🔥) icon appears, and the display gradually becomes dimmer.
  - If the temperature continues to increase, the digital center mirror turns off.

- The icon disappears when the mirror becomes cool.

### **HomeLink® system**

Your vehicle may be equipped with a Gentex Automatic-Dimming Mirror with an Integrated HomeLink® Wireless Control System.

During night time driving, this feature will automatically detect and reduce inside rearview mirror glare. The HomeLink® Universal Transceiver allows you to activate your garage door(s), electric gate, home lighting, etc.

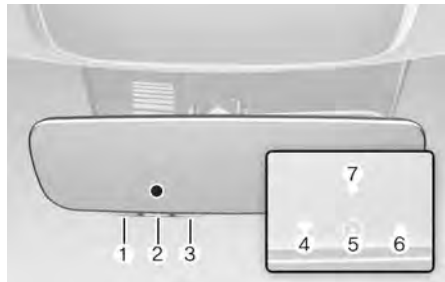

- (1) HomeLink Channel 1
- (2) HomeLink Channel 2
- (3) HomeLink Channel 3
- (4) Garage Door Opener Status Indicator: Closing or Closed
- (5) HomeLink Operation Indicator
- (6) Garage Door Opener Status Indicator: Opening or Opened
- (7) HomeLink User Interface Indicator

### Automatic-Dimming Night Vision Safety™ (NVS®) Mirror

 if equipped

The NVS® Mirror automatically helps reduce glare by monitoring light levels in the front and the rear of the vehicle. Any object that obstructs either light sensor will degrade the automatic dimming control feature.

For more information regarding NVS® mirrors and other applications, please refer to the Gentex website:

[www.gentex.com](http://www.gentex.com)

Your mirror will automatically dim upon detecting glare from the vehicles traveling behind you.

The mirror defaults to the ON position each time the vehicle is started.

### Integrated HomeLink® Wireless Control System

The HomeLink® Wireless Control System provides a convenient way to replace up to three handheld radio-frequency transmitters used to activate compatible devices such as gate operators, garage door openers, entry door locks, security systems, and home lighting.

### NOTICE

HomeLink® operates while the Engine Start/Stop button is in the ACC or ON position for safety reasons. It is to prevent unintentional security problems from happening when the vehicle is parked outside the garage.

### WARNING

Before programming HomeLink® to a garage door opener or gate operator, make sure people and objects are out of the way of the device to prevent potential harm or damage. Do not use the HomeLink® with any garage door opener that lacks the safety stop and reverse features required by U.S. federal safety standards (this includes any garage door opener model manufactured before April 1, 1982). A garage door that cannot detect an object - signaling the door to stop and reverse - does not meet current U.S. federal safety standards. Using a garage door opener without these features increases the risk of serious injury or death.

For more information, contact HomeLink® at [www.homelink.com](http://www.homelink.com), or call Home-Link customer support at 1-800-355-3515.

It is also recommended that a new battery be replaced in the handheld transmitter of the device being trained to HomeLink® for quicker training and accurate transmission of the radio frequency.

### 1. Programming HomeLink®

The following steps show how to program HomeLink. If you have any questions or are having difficulty programming your HomeLink buttons, refer to the HomeLink website or call the HomeLink customer support toll-free number. Do this, before going back to the dealer who sold you the vehicle.

- Visit the HomeLink website at: [www.homelink.com](http://www.homelink.com). Then at the top of the page, choose your vehicle make. Then watch the YouTube video, and/or access additional website information.
- If you choose to access the website via your cell phone, scan the QR code.



- Or, call HomeLink customer support at 1-800-355-3515 (Please have your vehicle maker/model AND the opener device maker/model readily available.)

### 1) Programming Preparation

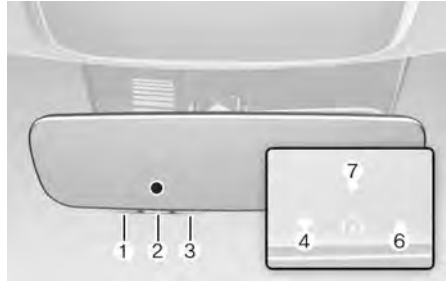

1. When programming a garage door opener, it is advised to park the vehicle outside of the garage.
2. It is recommended that a new battery be placed in the handheld transmitter of the device being programmed to HomeLink for quicker training and accurate transmission of the radio-frequency signal.
3. Press the Engine Start/Stop button to the ACC (Accessory) position for programming of HomeLink.

### 2) Programming a New HomeLink®



1. Press and release the HomeLink button (1), (2) or (3), you would like to program. The HomeLink indicator light (7) will flash orange slowly (if not, perform the steps of "Erasing HomeLink Buttons" section, and start over).

Type A

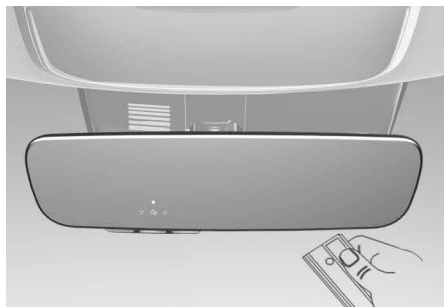

Type B

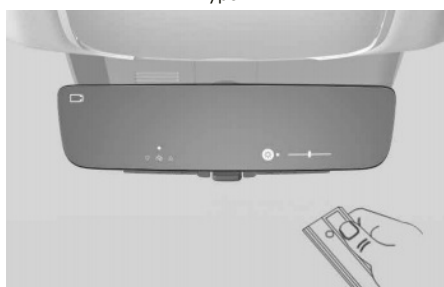

2. Position the garage door opener remote 1–3 inches (2–8 cm) away from the HomeLink buttons.
3. While the HomeLink indicator light (7) is flashing orange, press and hold the handheld remote button. Continue pressing the handheld remote button until the HomeLink indicator light (7) light changes from orange to green. You may now release the handheld remote button.
4. Wait until your garage door comes to a complete stop, regardless of position, before proceeding to the next steps.
5. Press and release the HomeLink button you are programming and observe the indicator light.
  - If the indicator light remains solid green, your device should operate when the HomeLink button is pressed. At this point, if your device operates, programming is complete.

- If the indicator light rapidly flashes green, firmly press, hold for two seconds and release the HomeLink button up to three times in a row slowly to complete the programming process. Do not press the HomeLink button rapidly. At this point if your device operates, programming is complete. If the device does not operate, continue with step 6.

6. At the garage door opener motor, (security gate motor, etc.) locate the "Learn", "Smart", "Set" or "Program" button. This can usually be found where the hanging antenna wire is attached to the motor-head unit (see the device's manual to identify this button). The name and color of the button may vary by manufacturer.

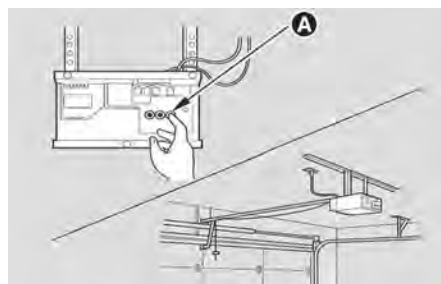

[A] Learn button

- A ladder and/or second person may simplify the following steps.
7. Firmly press and release the "Learn", "Smart", "Set" or "Program" button. You now have up to 30 seconds in which to complete the next step.

8. Return to the vehicle and firmly press, hold for two seconds and release, the HomeLink button up to three times in a row slowly. Do not press the HomeLink button rapidly. As soon as you see the garage door start to move, stop pressing any buttons until a few seconds after the garage door has come to a complete stop, regardless of position. At this point, programming is complete and your device should operate when the HomeLink button is pressed and released.

### 3) Two-Way Communication Programming (For select garage door openers)

If your garage door opener has the 'myQ' logo on its side, your opener likely has Two-Way Communication capability. HomeLink has the capability to establish Two-Way Communication with your garage door opener. HomeLink can receive and display "closing" or "opening" status messages from compatible garage door openers. At any time, Home-Link can also recall and display the last recorded status communicated by the garage door opener to indicate your garage door being "closed" or "opened".

To check if your garage door opener is compatible with this feature, refer to [www.homelink.com/compatible/two-way-communication](http://www.homelink.com/compatible/two-way-communication). If your garage door opener has this functionality, AND the Two-Way Communication indicators (4), (6) in the mirror appear while the garage door is opening/closing, then no further steps are needed. Two-Way Communication Programming is already complete. However, if your garage door opener has this functionality, AND the Two-Way Communication indicators (4), (6) in the mirror DO NOT appear while the garage door is opening/closing, use the following instructions to enable this functionality.

1. In your vehicle, press and hold the programmed HomeLink button for 2 seconds, then release. Confirm that the garage door is moving. AFTER it stops, you will have one minute to complete the following steps:
  - A ladder and/or second person may simplify the following steps.
2. On your garage door opener in your garage, locate the "Learn" button (usually near where the hanging antenna wire is attached to the garage door opener). If there is difficulty locating this button, reference the device's owner's manual.
3. Press and release the "Learn" button.
4. A light on your garage door opener may flash, and your Two-Way Communication indicators (4), (6) in your vehicle may flash, confirming completion of the process.
5. Return to the vehicle and firmly press and release the programmed HomeLink button to activate your garage door. The Two-Way Communication indicators (4), (6) flash in orange when the door is moving. Do not make any additional button presses until AFTER the garage door has come to a complete stop.
6. Your Two-Way Communication programming is now complete.

### *i* Information

If your garage door opener has Two-Way Communication functionality, it is possible for HomeLink to stop functioning the garage door shortly after initial programming, IF the Two-Way Communication Programming wasn't properly completed. This usually happens after the first 10 times a programmed HomeLink button is pressed. If you experience this, completing the "Programming a New HomeLink Button" and "Two-Way Communication Programming" will restore door operation.

---



#### 4) Canadian Programming

Canadian radio-frequency laws require transmitter remote signals to "time-out" (or quit) after a couple seconds of transmission, which may not be long enough for HomeLink to pick up the signal during programming.

If you live in Canada or you are having difficulties programming a gate operator or garage door opener by using the programming procedures, replace "Programming a New HomeLink Button" step 3 with the following:

While the HomeLink indicator light (7) is flashing orange, press and release ("cycle") your device's handheld remote every two seconds until the HomeLink indicator light (7) changes from orange to green. You may now release the handheld remote button. Then proceed with "Programming a New HomeLink Button" step 4.

### 2. Operating HomeLink®

#### 1) Operating HomeLink®



1. Press and release the desired programmed HomeLink button (1, 2 or 3).

### *i* Information

The HomeLink indicator (7) should light green, solid or flashing, and your programmed device should operate.

If your device does not operate, the HomeLink programming was not successful, and you'll need to reprogram the button.

#### 2) Two-Way Communication Display Behavior

Type A

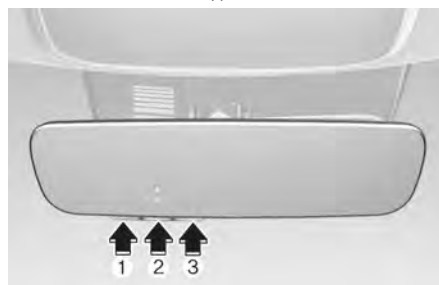

Type B



1. Press and release one of the programmed HomeLink buttons (1, 2 or 3).

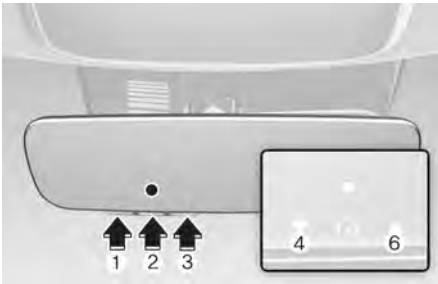

2. The indicator (4) and (6) operates as below, if your garage door opener has Two-Way Communication functionality.

- If the indicator (4) flashes in Orange, it indicates that the garage door is "Closing".
- The indicator (4) turns solid green once the garage door has closed.
- If the indicator (6) flashes in Orange, it indicates that the garage door is "Opening".
- The indicator (6) turns solid green once the garage door has fully opened.
- If the indicator (4) or (6) does not turn to green, it indicates that the last status of garage door was not received properly. The HomeLink mirror tries to receive the last known status of the garage door for a few seconds.

### 3) Recalling Garage Door Status

HomeLink mirror with Two-Way Communication provides a way to view the last stored message from the garage door opener. In order to recall the last known status of the last activated device, press the buttons "1 and 2" OR "2 and 3" simultaneously.

- If the indicator (4) appears solid Green, it indicates that the last activated device was "closed" properly.

- If the indicator (6) appears solid Green, it indicates that the last activated device was "open" properly.

### 3. Erasing HomeLink® Buttons

#### 1) Erasing and Reprogramming a Single HomeLink® Button:

1. Press and hold the desired HomeLink button you want to re-program. DO NOT release the button.
2. The HomeLink indicator light (7) will illuminate solid green. Release the button as soon as the HomeLink indicator light (7) begins to flash orange, usually about 20 seconds.
3. Proceed with the steps in the "Programming a New HomeLink Button" section.

#### *i* Information

If you do not complete the re-programming of a new device to the button, it will revert to the previously stored programming.

#### 2) The following instructions will erase ALL HomeLink® programming from ALL buttons:

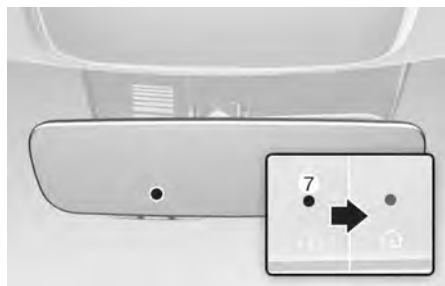

1. Press and hold the buttons (1) and (3) simultaneously.
2. The HomeLink indicator light (7) will illuminate solid Orange for about 10 seconds.

3. Release the buttons once the HomeLink indicator light (7) changes to Green and flashes rapidly.
4. Now all three HomeLink buttons (1), (2) and (3) are cleared of any programming.

### *i* Information

HomeLink® and the HomeLink® House logo are registered trademarks of Gentex Corporation.

The myQ logo is a registered trademark of The Chamberlain Group, Inc.

### **FCC (USA) and ISED (Canada)**

This device complies with FCC rules part 15 and Innovation, Science, and Economic Development Canada RSS-210. Operation is subject to the following two conditions: (1) This device may not cause harmful interference, and (2) This device must accept any interference that may be received including interference that may cause undesired operation. **WARNING:** The transmitter has been tested and complies with FCC and ISED rules. Changes or modifications not expressly approved by the party responsible for compliance could void the user's authority to operate the device.

This equipment complies with FCC and ISED radiation exposure limits set forth for an uncontrolled environment. End Users must follow the specific operating instructions for satisfying RF exposure compliance. This transmitter must be at least 20cm from the user and must not be co-located or operating in conjunction with any other antenna or transmitter.

### **FCC (Etats-Unis) et ISED (Canada)**

Cet appareil est conforme aux règlements de la FCC, section 15, et au CNR-210 d'Innovation, Sciences et Développement économique Canada. Le fonctionnement est assujéti aux deux conditions suivantes: (1) cet appareil ne doit pas causer d'interférences nuisibles et (2) cet appareil doit accepter toute interférence reçue, y compris celle qui pourrait entraîner un dysfonctionnement. **MISE EN GARDE :** L'émetteur a subi des tests et est conforme aux règlements de la FCC et d'ISDE. Les changements ou modifications non approuvés explicitement par la partie responsable de la conformité pourraient rendre caduque l'autorisation de l'utilisateur de se servir du dispositif.

Cet appareil est conforme aux limites d'exposition aux radiations de la FCC et d'ISDE établies pour un environnement non contrôlé. Les utilisateurs finaux doivent respecter les instructions d'utilisation spécifiques pour satisfaire aux exigences de conformité aux expositions de RF. L'émetteur doit se trouver à 20 cm au minimum de l'utilisateur et ne doit pas être situé au même endroit que tout autre émetteur ou antenne ni fonctionner avec un autre émetteur ou antenne.

### **Mejico**

La operación de este equipo está sujeta a las siguientes dos condiciones: (1) es posible que este equipo o dispositivo pueda no causar interferencia dañina, y (2) este dispositivo o dispositivos deben aceptar cualquier interferencia, que incluye la interferencia que puede causar su operación no deseada.

## HomeLink 5 Programing Flow Chart

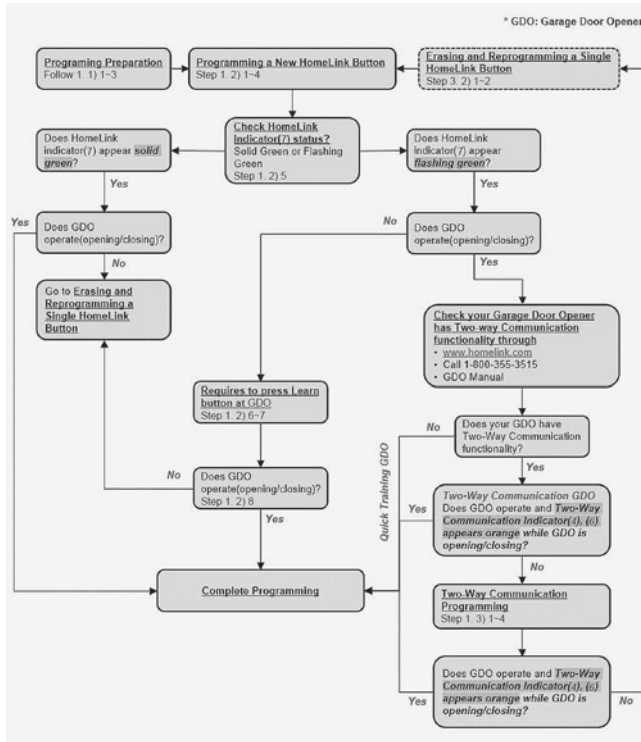

## Side View Mirrors

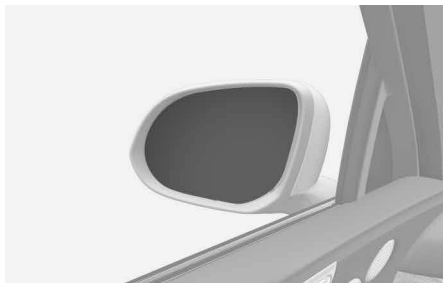

Your vehicle is equipped with both left-hand and right-hand side view mirrors. The mirrors can be adjusted remotely with the mirror adjustment control switch. Adjust the side view mirrors to your desired position before driving.

### WARNING

The right side view mirror is convex. Objects seen in the mirror are closer than they appear.

Use the inside rear view mirror or turn your head and look directly to determine the actual distance of other vehicles prior to changing lanes.

### WARNING

Do not adjust or fold the side view mirrors while driving. This may cause loss of vehicle control resulting in a collision.

### NOTICE

- Do not scrape ice off the mirror face. This may damage the surface of the glass.
- If the mirror is jammed with ice, do not adjust the mirror by force. Use an approved de-icer (not radiator antifreeze) spray, or a sponge or soft cloth with very warm water, or move the vehicle to a warm place and allow the ice to melt.
- Do not clean the mirror with harsh abrasives, fuel, or other petroleum based cleaning products.

### Adjusting the side view mirrors



1. Press the L (Left side) or R (Right side) button (1) to select the side view mirror you want to adjust.
2. Use the mirror adjustment control (2) to position the selected mirror up, down, left, or right.
3. After adjustment, press both L and R button off (indicator light off) to prevent unintended adjustment.

### NOTICE

- The mirrors stop moving when they reach the maximum adjusting angles, but the motor continues to operate while the switch is pressed. Do not press the switch longer than necessary, because this can damage the motor.
  - Do not adjust the side view mirror by hand to prevent damage to the motor.
- 

### Folding the side view mirrors

#### Folding button

Press the button to fold or unfold the side view mirrors.



#### Infotainment system setting

- Enable on door unlock  
If **Setup > Vehicle > Welcome Mirror > Enable on Door Unlock** is selected from the Settings menu in the infotainment system,
  - The mirror folds or unfolds when the door is locked or unlocked by the smart key.
  - The mirror folds or unfolds when the door is locked or unlocked by the touch sensor on the outside door handle.

- Enable on driver approach  
If **Setup > Vehicle > Welcome Mirror > Enable on driver approach** is selected from the Settings menu in the infotainment system, the mirror unfolds when the vehicle is approached with the smart key in possession.

### *i* Information

The infotainment system may change after software updates. For more information, refer to the manual provided in the infotainment system and the quick reference guide.

---

### NOTICE

The electric type side view mirror operates even though the Engine Start/Stop button is in the OFF position. However, to prevent unnecessary battery discharge, do not adjust the mirrors longer than necessary while the engine is not running.

---

### NOTICE

Do not fold the electric type side view mirror by hand. It could cause motor failure.

---

## Reverse Parking Aid

 if equipped



When the gear is shifted to the R (Reverse) position, the side view mirror(s) rotates downward to aid with driving in reverse.

The state of the side view mirror button (1) determines whether or not the mirrors move:

### How it works

- When the L or R button (1) is pressed (indicator lights ON), both side view mirrors move.
- If the L and R buttons (1) are not pressed (indicator lights OFF), both side view mirrors does not move.

The side view mirrors automatically revert to their original positions if any of the following occur:

- The Engine Start/Stop button is pressed to either the OFF position or the ACC position.
- The gear is shifted to any position except R (Reverse).
- The side view mirror adjustment button is not selected.

## Windows

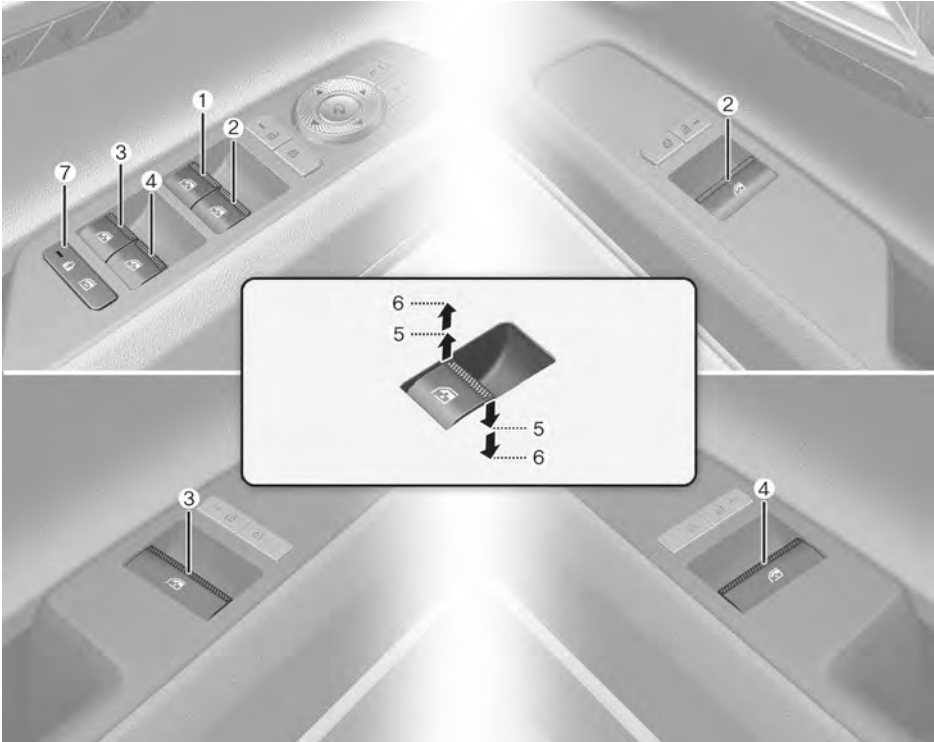

- (1) Driver's door power window switch
- (2) Front passenger's door power window switch
- (3) Rear door (left) power window switch
- (4) Rear door (right) power window switch
- (5) Window opening and closing
- (6) Automatic power window
- (7) Power window lock switch



## Power Windows

The Engine Start/Stop button must be in the ON position to be able to raise or lower the windows. Each door has a Power Window switch to control the door's window. The driver has a Power Window Lock button that can block the operation of rear passenger windows. The power windows operate for about 3 minutes after the Engine Start/Stop button is in the ACC or OFF position, as long as the front doors remain closed.

If the front doors are opened, the battery power is turned OFF and the Power Windows do not operate.

### Window opening and closing

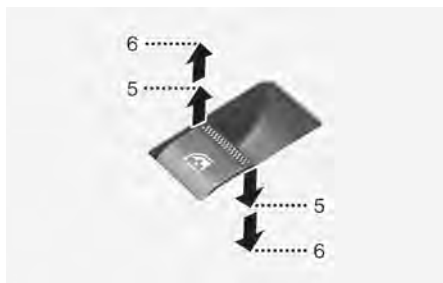

To open:

Press the window switch down to the first detent position (5). Release the switch when you want the window to stop.

To close:

Pull the window switch up to the first detent position (5). Release the window switch when you want the window to stop.

### Auto up/down window

Pressing or pulling up the power window switch momentarily to the second detent position (6) completely lowers or lifts the window even when the switch is released. To stop the window at the desired position while the window is operating, pull up or press down and release the switch.

### Resetting the power windows

If the power windows do not operate normally, the automatic power window system must be reset as follows:

1. Press the Engine Start/Stop button to the ON position.
2. Close the window and continue pulling up on the power window switch for at least one second.

If the power windows do not operate properly after resetting, contact an authorized retailer of Genesis Branded products.

### WARNING

Make sure body parts or other objects are out of the way before closing the windows. The automatic reverse feature does not operate while resetting the power window system.

### Automatic reversal

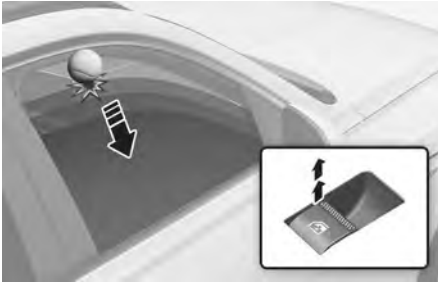

If a window senses any obstacle while it is closing automatically, it stops and lowers about 12 in. (30 cm) to allow the object to be cleared.

If the window detects any resistance while the power window switch is pulled up continuously, the window stops upward movement and then lowers about 1 in. (2.5 cm).

If the power window switch is pulled up continuously again within 5 seconds after the window is lowered by the automatic window reverse feature, the automatic window reverse does not operate.

### *i* Information

The automatic reverse feature is active only when the "Auto Up" feature is used by fully pulling up the switch to the second detent.

### NOTICE

Do not install any accessories on the windows. The automatic reverse feature may not operate.

### WARNING

Make sure body parts or other objects are safely out of the way before closing the windows to avoid injuries or vehicle damage.

Objects less than 0.16 in. (4 mm) in diameter caught between the window glass and the upper window channel may not be detected by the automatic reverse window and the window does not stop and reverse direction.

### Power window lock button



The driver can disable the power window switches on the rear passenger doors by pressing the power window lock button.

When the power window lock button is pressed:

- The driver's master control can operate all the power windows.
- The front passenger's control can operate the front passenger's power window.
- The rear passenger's control cannot operate the rear passengers' power window.

### WARNING

Do not allow children to play with the power windows. Keep the driver's door power window lock button in the LOCK position. Serious injury or death may result from unintentional window operation by a child.

**NOTICE**

- To prevent possible damage to the power window system, do not open or close two windows or more at the same time. This also ensures the longevity of the fuse.
- Never try to operate the main switch on the driver's door and the individual door window switch in opposite directions at the same time. If this is done, the window stops and cannot be opened or closed.

**Panoramic Sunroof**

**+** if equipped

If your vehicle is equipped with a sunroof, you can slide or tilt your sunroof with the sunroof control switch located on the overhead console.



The sunroof can only be operated when the Engine Start/Stop button is in the ON or START position.

The sunroof can be operated for about 3 minutes after the Engine Start/Stop button is in the ACC or OFF position unless a front door is opened.

**! WARNING**

To prevent serious injury or death:

- Adjust the sunroof or sunshade when your vehicle stops.
- Do not leave the engine running and the key in your vehicle with unsupervised children. Unattended children could operate the sunroof.
- Do not sit on the top of the vehicle.

**NOTICE**

Do not operate the sunroof if it contacts any roof rack or cargo.

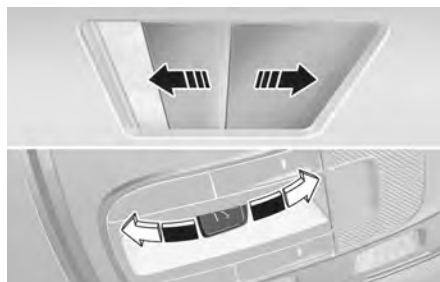
**Power Sunshade**

Use the power sunshade to block direct sunlight coming through the sunroof glass.

- Push the sunroof switch rearward to the first detent position, the power sunshade automatically slides open.
- Push the sunroof switch forward to the first detent position, the power sunshade automatically closes. If the sunroof glass is open, the sunroof glass closes and then the sunshade closes.

To stop the power sunshade, push the sunroof switch in any direction.

### NOTICE

Do not pull or push the power sunshade by hand to prevent damage.

### *i* Information

Wrinkles formed on the power sunshade are normal due to material characteristic.

### Tilt Open/Close

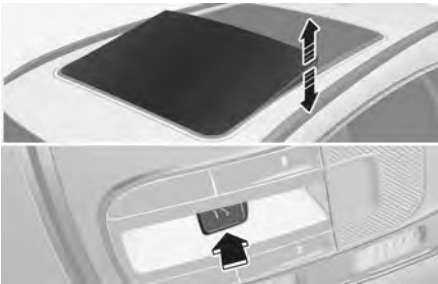

- Push the sunroof switch up to tilt the sunroof glass open. If the power sunshade is closed, the sunshade opens first and then the sunroof tilts.
- Push the sunroof switch upward or forward when the sunroof glass is tilt opened. The sunroof glass automatically closes.

To stop the sunroof movement at any point, push the sunroof switch in any direction.

### Slide Open/Close



- Push the sunroof switch rearward to the first detent position. The sunroof glass slides open. If the power sunshade is closed, the power sunshade opens first and then the sunroof glass opens.

Push the sunroof switch forward to the first detent position. The sunroof glass closes. If the sunroof glass is closed, the power sunshade closes.

- Push the sunroof switch forward or rearward to the second detent position. The power sunshade and sunroof glass operate automatically (auto slide feature).

To stop the sunroof movement, push the sunroof switch in any direction.

### Automatic reversal

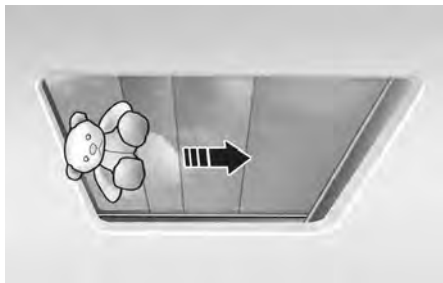

If the power sunshade or sunroof glass senses any obstruction while closing, it reverses direction then stops.

The automatic reverse feature may not work if a thin or soft object is caught between the sliding power sunshade or sunroof glass and sunroof sash.

#### **WARNING**

- Make sure that heads, hands, arms or any other body parts or objects are out of the way before operating the sunroof. Body parts or objects may get caught causing injuries or vehicle damage.
- Never deliberately use your body parts to test the automatic reverse feature.

#### **NOTICE**

- Do not continue to push the sunroof switch after the sunroof is fully opened, closed, or tilted. Damage to the sunroof motor may occur or may cause the sunroof system to malfunction.
- Using the sunroof for a long time may make noise caused by dust accumulated between the sunroof and vehicle body. Open the sunroof and remove dust regularly using a clean cloth on the sunroof rail.
- Do not try to open the sunroof when the temperature is below freezing or the sunroof is covered with snow or ice. Otherwise, the motor may be damaged. In a cold and wet weather, the sunroof may not work properly.
- Do not open or drive with the sunroof glass open immediately after rain or washing the vehicle. Water may wet the interior of the vehicle.
- Do not try to open the sunroof when the temperature is below freezing or when the sunroof is covered with snow or ice. The sunroof may not work properly and may break if opened by force.
- Do not extend any cargo outside the sunroof while driving.

#### **WARNING**

Do not extend your head, arms, body parts, or objects outside the sunroof while driving. Injuries may occur if the vehicle suddenly stops.

## Resetting the Sunroof



In some circumstances resetting the sunroof operation may need to be performed. Some instances where resetting the sunroof may be required include:

- When the 12-volt battery is either disconnected or discharged
- When the sunroof fuse is replaced
- If the sunroof one-touch Auto open/close operation is not functioning properly

To reset the sunroof:

1. Start the vehicle in P (Park).
2. Make sure the power sunshade and sunroof glass are in the fully closed position.
3. Release the switch when the power sunshade and sunroof glass are fully closed.
4. Push the switch forward until the power sunshade and sunroof glass move slightly. Then release the switch.
5. Push and hold the sunroof switch forward again until the power sunshade and sunroof glass slide open and close.

Do not release the switch until the operation is completed. If you release the switch, start the procedure again from step 2.

## *i* Information

If the sunroof is not reset after the vehicle battery is disconnected or discharged, or the sunroof fuse is blown, the sunroof may not operate normally.

## Sunroof Open Warning



If the driver turns off the engine when the sunroof is not fully closed, the warning chime sounds for several seconds and the sunroof open warning appears on the cluster display. Close the sunroof securely when leaving your vehicle.

## CAUTION

Do not leave sunroof open when leaving the vehicle to prevent theft or damage from water entering the vehicle.

## Hood

### Opening the Hood

1. Park the vehicle and apply the parking brake.
2. Pull the release lever to unlatch the hood. The hood pops open slightly.

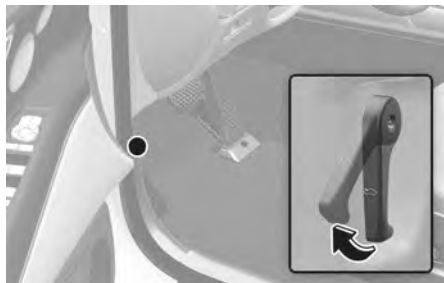

3. Go to the front of the vehicle, raise the hood slightly, push up the secondary hood release lever (1) inside of the hood center and lift the hood (2).

After the hood has been lifted halfway, it is raised completely by itself.



### Closing the Hood

1. Before closing the hood, check in and around the engine compartment to ensure the following:
  - Any tools or other loose objects have been removed.
  - All glove, rags, or other combustible material have been removed.
  - All filler caps are tightly and correctly installed.
2. Lower the hood until it is about 12 in. (30 cm) above the closed position and then let it drop.
3. Check the hood has locked properly. If the hood is raised slightly, open it again and drop it from a little higher. Check again.

#### WARNING

- Before closing the hood, ensure all obstructions are removed from around the hood opening.
- Always double check to make sure that the hood is firmly latched before driving away. Check there is no hood open warning light or message displayed on the instrument cluster. Driving with the hood open may cause a total loss of visibility, resulting in a collision.
- Do not move the vehicle with the hood raised. It may block your vision and may result in a collision.

## Power Liftgate

 if equipped

### Power Liftgate Operating Conditions

The power liftgate operates when the gear is in P (Park) with the engine running. The liftgate operates regardless of the gear position when the engine is off.

For safety, before attempting to open or close the liftgate, make sure the vehicle is in P (Park).

#### WARNING

- Never leave children or animals unattended in your vehicle. Children may operate the power liftgate that could result in serious injury or property damage.
- Make sure that there are no people or objects in the path of the power liftgate or smart liftgate prior to use. Serious injury, damage to the vehicle or damage to surrounding objects (for example, walls, ceilings, vehicles, etc.) may result if contact with the liftgate occurs.

Type A

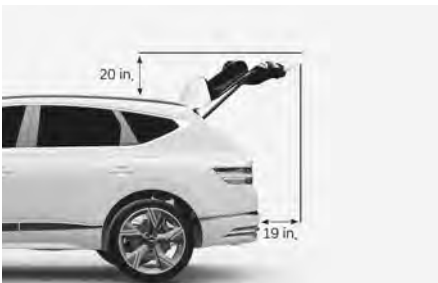

Type B



- The liftgate may not open or may close unintentionally injuring people around the liftgate under the following situation:
  - There is a lot of snow on the liftgate.
  - There is a heavy object on the liftgate such as a bicycle carrier, ladder, etc.Do not open the liftgate before removing snow or heavy object on the liftgate.



**NOTICE**

- Do not close or open the liftgate manually or it may be damaged. If you need to close the liftgate manually, do not apply excessive force.
- Do not operate the power liftgate more than 10 times continuously when the engine is not running. Use the power liftgate with the engine running when the power liftgate is used repeatedly to prevent battery discharge.
- Do not leave the power liftgate open for a long time. This may drain the battery.
- Do not apply excessive force when the power liftgate is operating. Doing so could result in vehicle damage.



- Always close the liftgate before driving. Do not grab or hold on to the liftgate support struts or they may be damaged.  
Deformation of the liftgate support struts may result in vehicle damage and personal injury.
- Do not modify or repair any part of the power liftgate by yourself. Have the power liftgate modified or repaired by an authorized retailer of Genesis Branded products.
- Do not operate the power liftgate under the following conditions. The power liftgate may not operate properly.
  - One side of the vehicle is lifted to inspect the vehicle or change a tire

- Parking on an uneven road such as a slope, etc.
- Close the liftgate completely and lock all doors and liftgate using the central door lock button before using an automatic car wash.
- Do not spray high pressure water directly on the power liftgate outside open/close button. The liftgate may open unintentionally.

**i Information**

- If the liftgate is not fully closed and vehicle speed is at or above 1.8 mph (3 km/h), a warning will sound 10 times. Immediately park the vehicle at a safe place, close the liftgate, and check that the liftgate open warning on the instrument cluster is turned off.
- In cold and wet climates, the outside power liftgate open/close button may not work properly due to freezing conditions. If this occurs, remove the ice before using the outside power liftgate open/close button or use the power liftgate open/close button on the smart key or the instrument panel.
- Operating the power liftgate more than 5 times continuously could cause damage to the operating motor. If this occurs, the power liftgate will not operate to prevent the motor from overheating. If any of the power liftgate buttons are pressed to try to open the liftgate, the chime will sound 3 times, but the liftgate will remain closed. Allow the power liftgate system to cool for about 1 minute before operating the system again.

## Operating the Power Liftgate

### Power liftgate open/close button (Smart key, Instrument panel)

Smart key



Instrument panel



Press the power liftgate open/close button for 1 second. The liftgate opens or closes with a warning sound.

While the liftgate is opening or closing, press the button to stop liftgate operation.

If the smart key is not within operation range (about 32 ft. (10 m)) from the vehicle, liftgate operation stops with a warning sound for 5 seconds.

### Power liftgate open/close button (Outside the power liftgate)

Type A



Type B



When the liftgate is closed, press the power liftgate open/close button to open the liftgate.

If the vehicle is locked, press the power liftgate open/close button with the smart key in your possession.

If the liftgate is unlocked, the liftgate opens or closes with a warning sound when the power liftgate open/close button is pressed without carrying the smart key.

### Power liftgate open/close button (Inside the power liftgate)

Type A



Type B



Press the power liftgate open/close button. The liftgate opens or closes automatically.

### Power liftgate lock button (Inside the power liftgate)

Type A



Type B



Press the power liftgate lock button while carrying the smart key. The liftgate closes and locks automatically. Additionally, all doors will lock.

The liftgate can be closed and locked, and all doors are locked only when the button is pressed while the engine is off.

### **Automatic reversal**

During power liftgate operation if the power liftgate senses any obstacle, the liftgate stops or fully opens. The automatic reverse feature may not operate properly, or it may operate unexpectedly under the following circumstances :

- The automatic reverse feature may not detect the resistance if the detected resistance is below a certain level, or if the liftgate is almost fully closed near the latched position.

- The automatic reverse feature may operate if a strong impact is applied with no obstructions placed.

### **WARNING**

Never intentionally place any object or part of your body in the path of the power liftgate to make sure the automatic reverse feature operates. Serious injury, or damage to the vehicle or object may occur.

---

### **Information**

The power liftgate may stop operating if the automatic reverse feature operates more than two times while attempting to open or close the liftgate. If this occurs, carefully open or close the liftgate manually, and then after 30 seconds try to operate the power liftgate automatically again.

---

## Setting the Power Liftgate

To use each feature, you must select the opening speed or opening height from the settings menu. Deselect the settings when you do not want to use the feature.

### *Power liftgate opening speed*

To adjust the power liftgate speed, select **Setup > Vehicle > Door/Liftgate > Power Liftgate Opening Speed > Fast/Slow** in the infotainment system. (Default setting is **Fast**)

### *Power liftgate opening height*

To adjust the power liftgate opening height, select **Setup > Vehicle > Door/Liftgate > Power Liftgate Opening Height > Full Open/Level 3/Level 2/Level 1/User Height Setting** in the infotainment system.

### *User height setting*

1. Position the liftgate manually to the height you prefer.
2. Press the power liftgate open/close button located inside the liftgate for more than 3 seconds.

If **User Height Setting** is selected for the power liftgate opening height, the power liftgate will automatically open to the height manually set by you.

### **Information**

- If the power liftgate opening height has not been manually set, the power liftgate will fully open when **User Height Setting** from the infotainment system is selected.
  - If one of the height setting (**Full Open/Level 3/Level 2/Level 1**) is selected from the settings menu in the infotainment system, and then **User Height Setting** is selected, the liftgate will open to the height manually set by you.
  - The power liftgate opening speed and opening height settings change according to the linked User Profile. If the User Profile is changed, power liftgate opening speed and opening height settings will change accordingly.
  - The infotainment system may change after software updates. For more information, refer to the manual provided in the infotainment system and the quick reference guide.
-

## Resetting the Power Liftgate

In some circumstances resetting the power liftgate operation may need to be performed. Some instances where resetting the power liftgate may be required include:

- When the 12 V battery is recharged
- When the 12 V battery is reinstalled after removal or replacement
- When the related fuse is reinstalled after removal or replacement

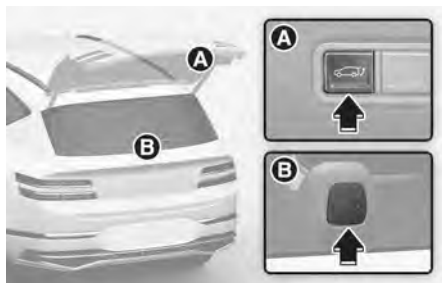

1. With the engine off or running, put the gear in P (Park).
2. Press the power liftgate open/close inner button [A] and outer button [B] simultaneously until a chime sounds.
3. Slowly close the liftgate manually.
4. Press the power liftgate open/close outer button. The power liftgate will open with a chime sound.

Wait until the liftgate fully opens to complete resetting. If the liftgate stops before it is fully open, resetting cannot be completed.

### *i* Information

If the power liftgate does not operate properly after the above procedure, have the system inspected by an authorized retailer of Genesis Branded products.

## Emergency Liftgate Safety Release

Type A

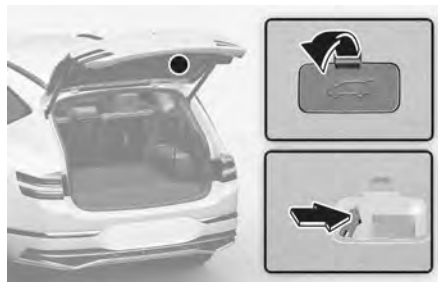

Type B

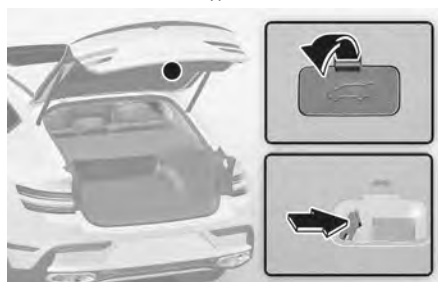

To unlock and open the liftgate manually from inside the cargo area, perform the following procedure:

1. Remove the cover at the bottom of the liftgate.
2. Slide the latch in the direction of the arrow to unlock the liftgate.
3. Push the liftgate to open.

**⚠ WARNING**

- For emergencies, be fully aware of the location of the emergency liftgate safety release latch in the vehicle and how to open the liftgate if you are accidentally locked in the cargo area.
  - No one, including animals, should be allowed to occupy the cargo area of the vehicle at any time. The cargo area is a very dangerous location in the event of a collision.
  - Use the release latch for emergencies only. Use extreme caution, especially while the vehicle is moving.
- 

## Smart Liftgate



### Using Smart Liftgate

The hands-free smart liftgate system can be used when:

- The smart liftgate option is enabled in the Settings menu in the infotainment system.
- The smart liftgate is activated and ready 15 seconds after all the doors are closed and locked.
- The smart liftgate opens when the smart key is detected in the area behind the vehicle for 3 seconds.

***i* Information**

The smart liftgate does not operate when:

- A door is not locked or closed.
  - The smart key is detected within 15 seconds from when the doors were closed and locked.
  - The smart key is detected within 15 seconds after the doors are closed and locked, and within 60 in. (1.5 m) from the front door handles.
  - The smart key is in the vehicle.
-

### 1. Settings

To use smart liftgate, enable it from the Settings menu in the infotainment system. Select:

- **Setup > Vehicle > Door/Liftgate > Smart Liftgate**

#### *i* Information

The infotainment system may change after software updates. For more information, refer to the manual provided in the infotainment system and the quick reference guide.

### 2. Detect and Alert



The smart liftgate detecting area extends about 20-40 in. (50-100 cm) behind the vehicle. If you are positioned in the detecting area and are carrying the smart key, the hazard warning lights blink and the chime sounds 6 times before opening.

#### *i* Information

If you unintentionally enter the detecting area and the hazard warning lights and chime starts, move away from the vehicle with the smart key. The liftgate remains closed.

### 3. Automatic opening

After the hazard warning lights blink and the chime sounds 6 times, the smart liftgate opens.

## Deactivating Smart Liftgate

If you press any button on the smart key during the Detect and Alert stage, the smart liftgate is deactivated.

- If you press the door unlock button, the smart liftgate is deactivated temporarily. If you do not open any door for 30 seconds, the smart liftgate is activated again.
- If you press the liftgate open button for more than 1 second, the liftgate opens.
- The smart liftgate is still activated if you press the door lock button or liftgate open/close button as long as the smart liftgate is not in the Detect and Alert stage.

## Detecting Area

#### *i* Information

- The smart liftgate may not operate properly if any of the following occur:
  - The smart key is close to a radio transmitter such as radio station or airport that may interfere with normal operation of the transmitter.
  - The smart key is near a mobile two way radio system or a mobile phone.
  - Another vehicle's smart key is being operated close to your vehicle.
- Smart liftgate detecting area may change when:
  - The vehicle is parked on an incline or slope.
  - One side of the vehicle is lifted or lowered relative to the opposite side.

## Fuel Filler Door

### Opening the Fuel Filler Door

1. Shift the gear to the P (Park) position and turn off the engine.
2. Make sure that the doors are unlocked.
3. Press the rear center edge of the fuel filler door [A].



4. Pull the fuel filler door (1) outward to access the fuel tank cap.
5. To remove the fuel tank cap (2), turn it counterclockwise. Hissing noise is heard because the pressure inside the tank equalizes.



6. Place the cap on the fuel filler door.

### *i* Information

- The fuel filler door unlocks when the doors are unlocked.  
To unlock fuel filler door:
  - Press the unlock button on your smart key.
  - Press the central door unlock switch on the driver's door.
  - Set the auto door unlock feature **Upon vehicle off** in the infotainment system.  
When all doors are automatically unlocked when the vehicle is turned off, the fuel filler door is automatically unlocked.
- If the fuel filler door does not open because of electrical failure or other reasons, have your vehicle inspected by an authorized retailer of Genesis Branded products.

### *i* Information

If the fuel filler door does not open because ice has formed around it, tap lightly or push on the door to break the ice and release the door. Do not open the door. If necessary, spray around the door with an approved deicer fluid (do not use radiator antifreeze) or move the vehicle to a warm place and allow the ice to melt.



## Closing the Fuel Filler Door

1. To install the fuel tank cap, turn it clockwise until it "clicks" one time.
2. Close the fuel filler door until it is latched securely.

### *i* Information

To lock the fuel filler door, make sure the fuel filler door is completely closed. Press the lock button on the smart key to lock your vehicle. The fuel filler door also locks. If you lock the driver's door while fueling, unlock it before closing the fuel filler door.

If the fuel filler door is not completely closed when the vehicle is locked, the fuel filler door is not locked.

### WARNING

Automotive fuel is highly flammable and explosive. Failure to follow these guidelines may result in serious injury or death:

- Read and follow all warnings posted at the gas station.
  - Before refueling, note the location of the Emergency Fuel Shut-Off, if available, at the gas station.
  - Before touching the fuel nozzle, eliminate the potential build-up of static electricity by touching a metal part of the vehicle, a safe distance away from the fuel filler neck, nozzle, or other gas source, with your bare hand.
  - Do not use mobile phones while refueling. Electric current and/or electronic interference from cellular phones may potentially ignite fuel vapors and cause a fire.
- Do not get back into a vehicle once you have begun refueling. You can generate a buildup of static electricity by touching, rubbing, or sliding against any item or fabric capable of producing static electricity. Static electricity discharge may ignite fuel vapors causing a fire. If you must re-enter the vehicle, once again eliminate potentially dangerous static electricity discharge by touching a metal part of the vehicle, away from the fuel filler neck, nozzle, or other fuel source, with your bare hand.
  - When using an approved portable fuel container, be sure to place the container on the ground prior to refueling. Static electricity discharge from the container may ignite fuel vapors causing a fire.
- Once refueling has begun, contact between your bare hand and the vehicle should be maintained until the filling is complete.
- Use only approved portable plastic fuel containers designed to carry and store fuel.
  - When refueling, always shift the gear to the P (Park) position, apply the parking brake, and press the Engine Start/Stop button to the OFF position. Sparks produced by electrical components related to the engine may ignite fuel vapors causing a fire.
  - Do not use matches or a lighter and do not smoke or leave a lit cigarette in your vehicle while at a gas station, especially during refueling.
  - Do not over-fill or top-off your vehicle tank, which may cause fuel spillage.
  - If a fire breaks out during refueling, get away from the vehicle, and immediately contact a gas station employee and then contact the local fire department.

- If pressurized fuel sprays out, it can cover your clothes or skin and increase the risk of fire and burns. If the cap is venting fuel or if you hear a hissing sound, wait until the condition stops before completely removing the cap.
- Always check that the fuel cap is installed securely to prevent fuel spillage in the event of a collision.

### NOTICE

- Do not spill fuel on the exterior surfaces. It may damage the paint.
- If the cap needs to be replaced, Only use a genuine Genesis cap or the equivalent (of the genuine part) specified for your vehicle. An incorrect fuel filler cap can result in fuel system or emission control system may malfunction.

## Head-Up Display (HUD)

 if equipped

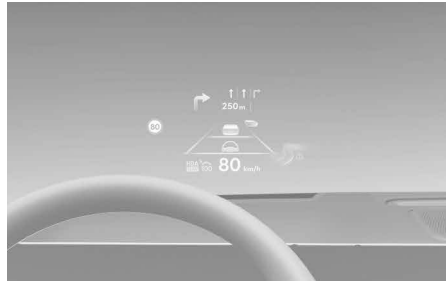

The head-up display is an optional feature that allows the driver to view information projected onto a transparent screen while still keeping your eyes safely on the road ahead while driving.

## Head-Up Display Settings



- Head-up display can be enabled from the Settings menu in the infotainment system. Select:
  - **Setup > Vehicle > Head- Up Display > Enable Head-Up Display**
- After turning on the head-up display, you can change the settings of **Display Adjustment** and **Content Selection** of the head-up display.

## *i* Information

The infotainment system may change after software updates. For more information, refer to the manual provided in the infotainment system and the quick reference guide.

## Head-Up Display Information



- (1) Turn by Turn (TBT) navigation
- (2) Traffic signs or speed limit
- (3) Speedometer
- (4) SCC set speed
- (5) SCC vehicle distance
- (6) Lane Following Assist
- (7) Lane Safety
- (8) Blind-Spot Safety
- (9) Highway Auto Speed Change
- (10) Highway Driving Assist
- (11) Surrounding vehicles (if equipped)

## Precautions While Using the Head-Up Display

- It may sometimes be difficult to read information on the head-up display in the following situations:
  - The driver is improperly positioned in the driver's seat.
  - The driver wears polarizing-filter sunglasses.
  - An object is located above the head-up display cover.
  - The vehicle is driven on a wet road.

- Any improper lighting accessory is installed inside the vehicle, or there is incoming light from outside of the vehicle.
- The driver wears glasses.
- The driver wears contact lenses.

When it is difficult to read the head-up display information, adjust the image height or brightness level from the Settings menu in the infotainment system.

- Only change the settings after parking your vehicle at a safe location.
- Do not tint the front windshield glass or add other types of metallic coating. Otherwise, the head-up display image may be invisible.
- Do not place any accessories on the dashboard or attach any objects on the windshield glass.
- When replacing the front windshield glass, replace it with a windshield glass designed for head-up display operation. Otherwise, duplicated images may be displayed on the windshield glass.

## WARNING

The warning information of Blind-Spot Safety on the head-up display is a supplemental function only. Do not solely depend on them to change lanes. Always take a look around before changing lanes.

## *i* Information

Head-up Display includes GPL, LGPL, MPL and other open source license softwares. All license notices including related source code are provided at <http://www.mobis.co.kr/opensource/list.do>. If the driver requests on-board software open source code via MOBIS\_OSSrequest@mobis.co.kr within 3 years after buying this product, a CD-ROM or other storage device will be sent with the minimum cost covering storage device cost and delivery cost.

## OTA Software Update

 If equipped

The OTA (Over-the-Air) software update feature allows you to wirelessly update software to the latest version. Using this feature, you can keep your vehicle system up to date with the latest software.

### *i* Information

The OTA software update feature is only available for Genesis Connected Services users.

## Downloading Software

The latest software can be downloaded automatically while driving. After the latest software has been successfully downloaded, you will receive a notification on your phone or the vehicle screen that the software update and ready to install.

## Approving Software Update



After the vehicle is turned off, the vehicle system allows you to start the update.

- To start the update, press **Start** (1).
- To postpone the update, press **Later** (2).

## Preparing Software Update

If you press the **Start** button on the screen, the vehicle begins installing the update automatically. The following conditions must be satisfied:

- The vehicle must be off.
- The gear must be in P (Park).
- The Electronic Parking Brake (EPB) must be applied.
- The exterior lights must be turned off.
- The hood must be closed.
- The battery level must be sufficient.
- The systems to be updated must not be running.



- To update immediately, press **Update Now**.
- To cancel the update, press **Cancel Update**.

## Updating Software

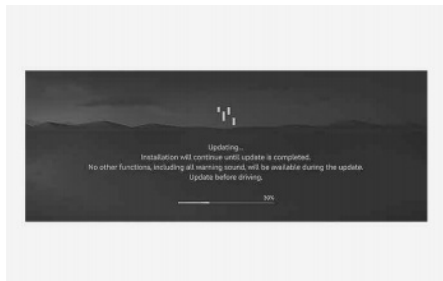

You can see the progress of the update on the screen.

After the update is complete, you will receive a notification on your phone, or the vehicle screen that the software update is complete.

### *i* Information

The screen turns off automatically after 3 minutes to save the battery. If the screen turns off automatically, you can check the update progress by pressing the Engine Start/Stop button.

### *i* Information

- After the update starts, you can exit the vehicle.
- The Over-The-Air software update feature is only available for Active and Enrolled Genesis Connected Services users.
- The update details may vary depending on the installed software version, for details you can visit the What's New link.
- Check the notice for the OTA software update on [mYGenesis.com/resources](https://mYGenesis.com/resources).
- If the update fails, the ECU will attempt to recover itself automatically (rollback). If you want to retry the software update, even after a successful recovery, contact Genesis Customer Care.

- If the update or recovery fails, contact Genesis Customer Care.
- After the update is complete, it may provide new functions or improvements. For more information, see the “Over-The-Air software update” page on [mYGenesis.com/resources](https://mYGenesis.com/resources).

### NOTICE

- Observe the following restrictions during the update.
  - You cannot use the vehicle during the update. Be sure to have enough time for the update, and safely park the vehicle before starting the update process.
  - You cannot use remote features, including remote start.
  - The Rear Occupant Alert feature may not work. Check if there are any occupants in the rear seat.
  - If there is an update for the Genesis Digital Key feature, the doors cannot be locked or unlocked using the digital key, or fingerprint recognition. If the Genesis Digital Key feature is being updated, use the smart key to lock or unlock the doors.
- The update will be automatically canceled if any vehicle conditions required for the update are changed before starting the update.
- Once the update has started, you cannot cancel the update.
- You cannot use the OTA software update feature if you modify or replace any vehicle software.
- Do not open the hood or replace the battery in the vehicle during the update. The update may fail.

- If a diagnostic tool of any kind is connected to the vehicle OBD (On-Board Diagnostic) terminal, the vehicle cannot be updated. The vehicle can be updated by removing the diagnostic tool connected to the OBD terminal and then restarting the vehicle.
  - If the update is not complete successfully, contact Genesis Customer Care.
  - Vehicle reception must be identified as Verizon to safely install any downloaded software.
  - Vehicle signal strength, must be strong (above -82 dbm) to safely install any downloaded software.
- 

## Exterior Lights

### Lighting Control

To operate the lights, turn the switch at the end of the control lever to one of the following positions:

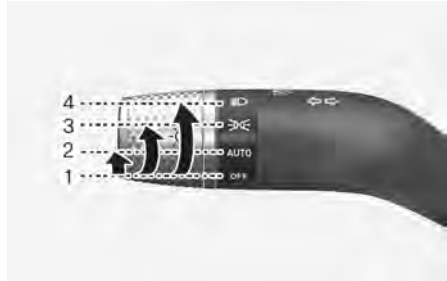

- (1) OFF
- (2) AUTO headlight
- (3) Parking light
- (4) headlight

### ***Daytime Running Lights (DRL)***

The Daytime Running Lights (DRL) can make it easier for others to see the front of your vehicle during the day, especially after dawn and before sunset.

The DRL system turns off the dedicated lamp when:

- The headlamps are ON.
- The parking brake is applied.
- The vehicle is turned off.

### **AUTO Headlight**

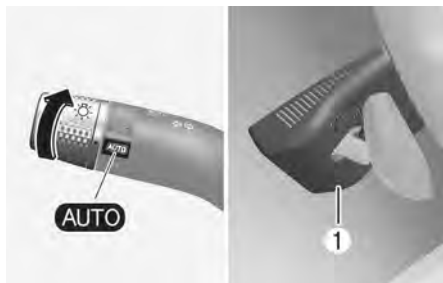

The parking light and headlight are turned ON or OFF automatically depending on the amount of daylight as measured by the ambient light sensor (1) at the upper end of the windshield glass.

Even with the AUTO headlight feature in operation, it is recommended to manually turn ON the headlamps when driving at night or in a fog, driving in the rain, or when you enter dark areas, such as tunnels and parking facilities.

#### **NOTICE**

- Do not cover or spill anything on the sensor (1) located at the upper end of the windshield glass.
- Do not clean the sensor using a window cleaner, the cleaner may leave a light film which could interfere with sensor operation.
- If your vehicle has window tint or other types of metallic coating on the front windshield, the AUTO headlight system may not work properly.

### **Parking light**



The parking light, license plate light, and instrument panel lamp are turned ON.

### **Headlight**



The headlight, parking light, license plate light, and instrument panel lamp are turned ON.

#### **i Information**

The Engine Start/Stop button must be in the ON position to turn on the headlight.

## High Beam Operation



To turn on the high beam headlight, push the lever away from you. The lever returns to its original position.

The high beam indicator illuminates when the headlight high beams are switched on.

To turn off the high beam headlight, pull the lever toward you. The low beams turn on.



To flash the high beam headlight, pull the lever toward you, then release the lever. The high beams remain ON as long as you hold the lever.

## Turn Signals and Lane Change Signals

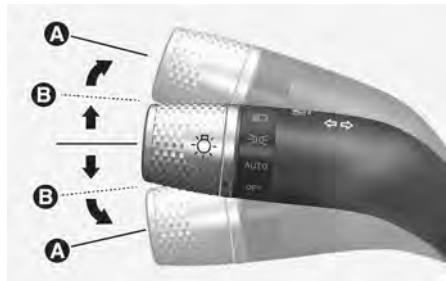

To signal a turn, push down on the lever for a left turn or up for a right turn in position [A].

If an indicator stays on and does not flash or if it flashes abnormally, one of the turn signal bulbs may be burned out and require replacement. Contact an authorized retailer of Genesis Branded products.

### **One touch turn signal**

To use One Touch Turn Signal, push the turn signal lever up or down to position [B] and then release it.

The lane change signals blinks 3, 5 or 7 times.

You can enable the One Touch Turn Signal function or choose the number of blinking by selecting **Setup > Vehicle > Lights > One Touch Turn Signal (or One-touch indicator) > 3 flashes/5 flashes/7 flashes/Off** in the infotainment system.

### **i Information**

The infotainment system may change after software updates. For more information, refer to the manual provided in the infotainment system and the quick reference guide.



## Battery Saver Function

To prevent the battery discharging, the system automatically turns off the parking lights when the driver turns the vehicle off and opens the driver's door.

To keep the lamps on when the vehicle is turned off:

1. Open the driver's door.
2. Turn the parking lights OFF and ON again using the headlight switch.

## Headlight Delay Function

If the Engine Start/Stop button is in the ACC or OFF position with the headlamps ON, the headlamps (and/or parking lights) remain on for about 5 minutes. If the driver's door is opened and closed, the headlamps are turned off after 15 seconds. Also, with the vehicle off if the driver's door is opened and closed, the headlamps (and/or parking lights) are turned off after 15 seconds.

The headlamps (and/or parking lights) can be turned off by pressing the lock button on the smart key twice or turning the headlight switch to the OFF or AUTO position.

You can enable the headlight delay function by selecting **Setup > Vehicle > Lights > Headlight Delay** (or **Headlight time-out**) in the infotainment system.

### *i* Information

The infotainment system may change after software updates. For more information, refer to the manual provided in the infotainment system and the quick reference guide.

### NOTICE

If the driver exits the vehicle through another door besides the driver's door, the battery saver function does not operate and the headlight delay function does not turn OFF automatically.

To avoid battery discharge, turn OFF the headlamps manually before exiting the vehicle.

## Headlight Moisture Removal Function

When moisture fogs up inside of the headlight with the headlight on for a certain period of time, the fan circulates air inside the headlight to remove moisture. If moisture is not removed, have your vehicle inspected by an authorized retailer of Genesis Branded products.

## High Beam Assist (HBA)

 If equipped



High Beam Assist automatically adjust the headlights between high beam and low beam depending on the light detected from oncoming vehicles or vehicles in front using the front view camera.

### Detecting sensor

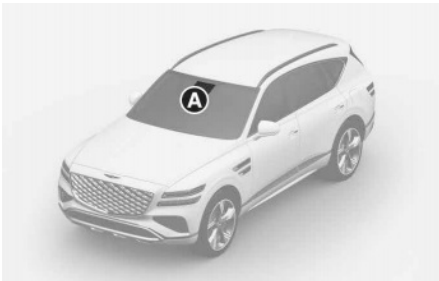

[A] Front view camera

The front view camera is used as a detecting sensor to detect ambient light and brightness while driving.

### NOTICE

- Always keep the front view camera in good condition to maintain optimal performance of High Beam Assist.
- Refer to the "Driver Assistance System Sensors" section in Chapter 7 for the location and the general precautions of front view camera.

## High Beam Assist Setting



With the Engine Start/Stop button in the ON position, select **Setup > Vehicle > Lights > High Beam Assist** (or **HBA (High Beam Assist)**) from the Settings menu to turn on High Beam Assist and deselect to turn off the function.

### WARNING

Only change the settings after parking your vehicle at a safe location.

## High Beam Assist Operation

- After selecting **High Beam Assist** (or **HBA (High Beam Assist)**) from the settings menu to operate High Beam Assist:
  - Place the headlight switch in the **AUTO** position and push the headlight lever toward the instrument cluster. The High Beam Assist (AUTO) indicator light illuminates on the cluster and the system will be enabled.
  - When High Beam Assist is enabled, high beams turn on when vehicle speed is above 30 km/h (19 mph) and the high beam (H) indicator illuminates on the cluster.
  - When the vehicle speed is below 20 km/h (12 mph), high beams do not turn on.

- When High Beam Assist is operating:
  - If the turn signal lever is pulled toward you when the high beams are off, the high beams turn on. When you let go of the turn signal lever, High Beam Assist operates again.
  - If the turn signal lever is pulled towards you when the high beams are on by High Beam Assist, low beams turn on and High Beam Assist turns off.
  - If the headlight switch is moved from **AUTO** to another position (headlight/position/off), the corresponding light turns on and High Beam Assist turns off.
- When High Beam Assist is operating, high beam switches to low beam if:
  - The headlights of an oncoming vehicle is detected.
  - The tail lamps of a vehicle in front is detected.
  - The headlight or tail lamp of a motorcycle or a bicycle is detected.
  - The surrounding ambient light is bright enough so high beams are not required.
  - Streetlights or other lights are detected.

## High Beam Assist Malfunction and Limitations

### *High Beam Assist malfunction*



When High Beam Assist is not working properly, the "**Check Driver Assistance system.**" warning message may appear and  warning light may illuminate on the instrument cluster. Have the system inspected by an authorized retailer of Genesis Branded products.

### *Limitations of High Beam Assist*

High Beam Assist may not operate normally in the following situations if:

- The headlights from an oncoming or front vehicle is damaged or out of the detection range.
- The headlights from an oncoming or front vehicle headlights are covered with dust, snow, or water.
- An oncoming or front vehicle's headlights are off but the fog lamps are on.
- There are lamps that have a similar shape as a vehicle's lamp ahead.
- The headlights are not repaired or replaced properly.
- The headlights are not aimed properly.
- You are driving on a narrow curved road, rough road, uphill, or downhill.
- A front vehicle is partially visible at a crossroad or on a curved road.

- There is a traffic light, reflecting sign, LED sign, or reflectors ahead.
- There is a temporary reflector or flash ahead (construction area).
- The road conditions are bad such as being wet, iced or covered with snow.
- A vehicle suddenly appears from a curve.
- The vehicle is tilted due to a flat tire or being towed.
- The headlights from an oncoming or front vehicle is not detected because of exhaust fumes, smoke, fog, snow, blizzard, water spray on the road, or windshield condensation, etc.

### NOTICE

For more information on the limitations of the front view camera, refer to the "Driver Assistance System Sensors" section in chapter 7.

---

### WARNING

- Always check road conditions, and if necessary, take appropriate actions to drive safely. It is your responsibility to operate your vehicle in a safe manner.
  - If High Beam Assist does not operate properly, use the turn signal lever to switch between high beam and low beam.
- 

## Welcome System



Welcome system helps keep the driver visible by turning on vehicle lights when the driver approaches the vehicle.

## Puddle Light and Door Handle Light

When all the doors (and liftgate) are closed and locked, the puddle light and door handle light come on for about 15 seconds if:

- When the door unlock button is pressed on the smart key.
- When you put your hand in the outside door handle with the smart key in possession.
- If **Setup > Vehicle > Convenience > Welcome Mirror > Enable on Driver Approach** is selected from the Settings menu in the infotainment system, the lights turn on when the vehicle is approached with the smart key in possession.

### *i* Information

The infotainment system may change after software updates. For more information, refer to the manual provided in the infotainment system and the quick reference guide.

---

## Interior Light

When the interior light switch is in the  position and all doors (and liftgate) are closed and locked, the room lamp come on for 30 seconds when:

- The door unlock button is pressed on the smart key.
- You put your hand in the outside door handle while carrying the smart key.

If you press the door lock or unlock button on the smart key the lights turn off immediately.

## Interior Lights

### WARNING

Do not use the interior lights when driving in the dark. The interior lights may obscure your view and result in a collision.

### NOTICE





Do not use the interior lights for extended periods when the vehicle is turned off. Otherwise, the battery discharges.

## Interior Light AUTO Cut

The interior lights automatically go off about 20 minutes after the vehicle is turned off and the doors are closed. If a door is opened, the lights go off 25 minutes after the vehicle is turned off. If the doors are locked by the remote key or smart key and the vehicle enters the armed stage of the theft alarm system, the lights go off five seconds later.

## Front Lamps



- **Map lamp** (, ): Touch either icons to turn the map lamp on or off. This light produces a spot beam for convenient use as a map lamp at night or as a personal lamp for the driver and the front passenger.
- **Door lamp** (): The front or rear room lamps come on when the front or rear doors are opened. When doors are unlocked by the smart key, the front and rear lamps come on for approximately 30 seconds as long as any door is not opened. The front and rear room lamps go out gradually after about 30 seconds when the door is closed. However, if the Engine Start/Stop button is in the ON position or all doors are locked, the front and rear lamps turn off. If a door is opened with the Engine Start/Stop button in the ACC position or OFF position, the front and rear lamps stay on for about 5 minutes.
- **Room lamp** (): Press the button to turn on the room lamp for the front and rear seats.

## Rear Room Lamp

if equipped

2nd row room lamp (without sunroof), 3rd row room lamp (Type A)

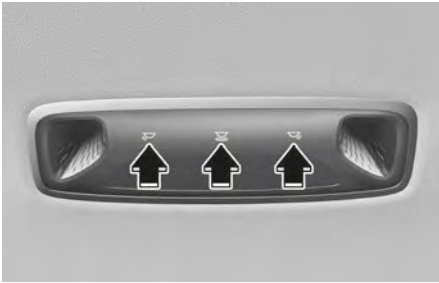

3rd row room lamp (Type B)

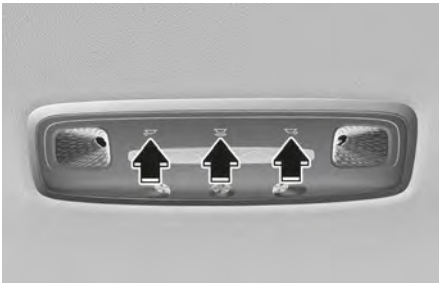

- , : Touch the icon to turn either lamp on or off.
- : Touch the icon to turn the mood lamp on or off.

Personal lamps



- : Press the button to turn the lamp on or off.

## Vanity Mirror Lamp



Opening the lid of the vanity mirror. The vanity mirror lamp turns on when the lid is opened and off when the lid is closed.

## Rear Mirror Lamp

if equipped

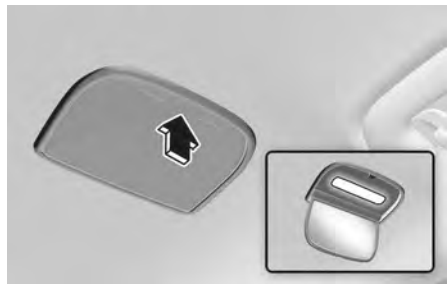

Press the mirror cover. The cover opens slowly and the mirror lamp turns on.

## Glove Box Lamp

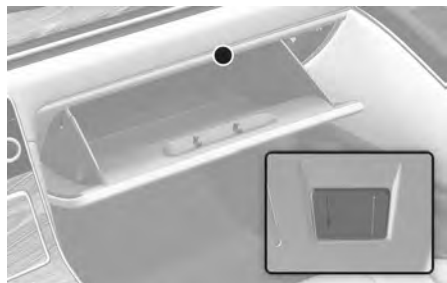

The glove box lamp turns on when the glove box is opened.

## Door Handle Lamp/Foot Lamp/Door Courtesy Lamp

if equipped



- [A] Door handle lamp
- [B] Foot lamp
- [C] Door courtesy lamp

The lamp turns on when a door is opened and turns off when the door is closed.

## Mood Lamp

if equipped



If **Setup > Vehicle > Lights > Ambient Lighting** (or **Ambient light**) is selected from the infotainment system, you can adjust the brightness and select color.

- If **Based on DRIVE MODE** (or **Link to drive mode**) is selected, the mood lamps change color according to the selected drive mode.
- To turn off the mood lamps, set the brightness level to "0" in the infotainment system.

## *i* Information

The infotainment system may change after software updates. For more information, refer to the manual provided in the infotainment system and the quick reference guide.

## Interior Lights Always On

The Interior Lights Always On function turns on the interior button lights regardless of the day or night condition.

You can enable the Interior Lights Always On function by selecting **Setup > Vehicle > Lights > Interior Lights Always On** (or **Interior lights On**) in the infotainment system.

After the function is enabled, the interior button lights are turned on or off in the following situations:

- When all doors are closed and locked, if you unlock the door, the interior button lights illuminate for about 5 minutes.
- When the vehicle is turned off, the interior button lights are turned on for about 5 minutes. At this time, if you open and close the door or lock the doors, the interior button lights are turned off immediately.

## Cargo Area Lamp



The cargo area lamp turns on when the liftgate is opened and off when the liftgate is closed.

## Puddle Light



### Escort light

When the Engine Start/Stop button is in the OFF position and the driver's door is opened, the puddle light turns on for 30 seconds. If the driver's door is closed within the 30 second period, the puddle light turns off after 15 seconds. If the driver's door is closed and locked, the puddle light turns off immediately.

The Puddle Light Escort Light turns on only the first time the driver's door is opened after the engine is turned off.

## Wipers and Washers

### Front Windshield Wipers

Type A

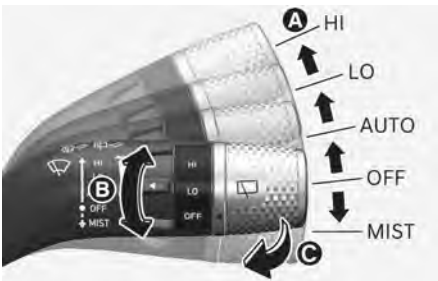

Type B

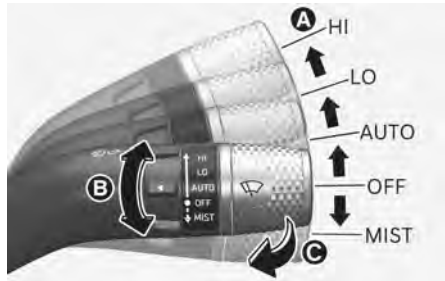

[A] Wiper speed control

[B] Intermittent or Auto control wipe time adjustment

[C] Wash with brief wipes

Operates as follows when the Engine Start/Stop button is in the ON position.

- **HI:** The wiper runs at a higher speed.
- **LO:** The wiper runs at a lower speed
- **AUTO:**

The rain sensor located on the upper end of the windshield glass senses the amount of rainfall and controls the interval of the wiping cycle.

To change the sensitivity setting, turn the sensitivity control switch.

- **OFF:** Wipers are not in operation.
- **MIST:** For a single wiping cycle, push the lever down and release. The wipers operate continuously if the lever is held in this position.

### NOTICE

If there is heavy accumulation of snow or ice on the windshield, defrost the windshield for about 10 minutes, or until the snow and/or ice is removed to prevent damage to the wiper and washer system.



### *AUTO (Automatic) control*

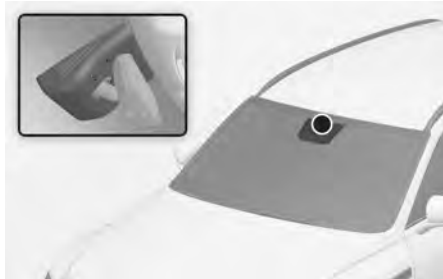

The rain sensor located on the upper end of the windshield glass senses the amount of rainfall and controls the interval of the wiping cycle.

To change the sensitivity setting, turn the sensitivity control switch.

If the wiper switch is set in the AUTO mode when the Engine Start/Stop button is in the ON position, the wiper operates once to perform a self-check of the system. Set the wiper to the **OFF** position when the wiper is not used.

#### **⚠ WARNING**

To prevent personal injury:

- Do not touch the upper end of the windshield glass near the rain sensor.
- Do not wipe the upper end of the windshield glass with a damp or wet cloth.
- Do not put pressure on the windshield glass.

#### **NOTICE**

To prevent damage:

- When washing the vehicle, set the wiper to the **OFF** position to stop the auto wiper operation.
- Do not remove the sensor cover located on the upper end of the passenger side windshield glass.

### **Front Windshield Washers**



In the **OFF (O)** position, pull the lever gently toward you to spray washer fluid on the windshield and to run the wipers 1-3 cycles. The spray and wiper operation continues until you release the lever. If the washer does not work, you may need to add washer fluid to the washer fluid reservoir.

#### ***Recirculating air when washer fluid is used***

When washer fluid is used, in order to reduce any objectionable scent of the washer fluid from entering the cabin, recirculation mode and air conditioning are automatically activated depending on the outside temperature. If you select fresh mode while the function is operating, the function resumes after a certain amount of time. It may not work in some conditions such as cold weather or engine OFF.

For more information, refer to the "Climate Control Additional Features" section in this chapter.

#### ***i* Information**

For Gasoline 3.5T-GDI 48 V MHEV vehicles, outside air may enter the vehicle even while preventing washer fluid scent from flowing in the cabin to cool the 48 V battery.

**WARNING**

When the outside temperature is below freezing, always warm the windshield using the defroster to help prevent the washer fluid from freezing on the windshield and obscuring your vision that could lead to a collision and serious injury or death. Always use appropriate washer fluids in the winter season or cold weather.

**NOTICE**

To prevent damage:

- Do not operate the washer when the fluid reservoir is empty or when the windshield is dry.
- Do not attempt to move the wipers manually.

## Rear Window Wiper and Washer

 If equipped



The rear window wiper and washer switch is located at the end of the wiper and washer switch lever. Turn the switch to the desired position to operate the rear wiper and washer.

- **HI:** High wiper speed.
- **LO:** Low wiper speed.
- **OFF:** Off



Push the lever away from you to spray rear washer fluid and to run the rear wipers 1-3 cycles. The spray and wiper operation continues until you release the lever.

### *Auto rear wiper*

The rear wiper operates while the vehicle is in reverse with the front wiper on by selecting the function from the Settings menu in the infotainment system. Select:

- **Setup > Vehicle > Convenience > Auto Rear Wiper (in R)**

### *i Information*

The infotainment system may change after software updates. For more information, refer to the manual provided in the infotainment system and the quick reference guide.

## Automatic Climate Control System

### Front seat control



The actual shape of climate control system may differ from the illustration.

- (1) Driver's temperature control
- (2) Passenger's temperature control
- (3) Fan speed control
- (4) Driver's mode selection
- (5) Passenger's mode selection
- (6) AUTO (automatic control)
- (7) OFF (system off)
- (8) Front windshield defroster
- (9) Air intake control
- (10) SYNC
- (11) Rear window defroster
- (12) A/C (air conditioning)
- (13) Built in diffuser (if equipped)
- (14) Clean Air system
- (15) 5 seater: Rear control/7 seater: 2nd/3rd control

### *i* Information

Use microfiber cloth when wiping fingerprints off the touchscreen.

**Rear seat control from the front**



The actual shape of climate control system may differ from the illustration.

- (1) Temperature control
- (2) Mode selection
- (3) AUTO
- (4) OFF
- (5) Fan speed control (if equipped)

***i* Information**

Use microfiber cloth when wiping fingerprints off the touchscreen.

---

## Second row seat / Third row seat control

<sup>+</sup>if equipped

Second row seat

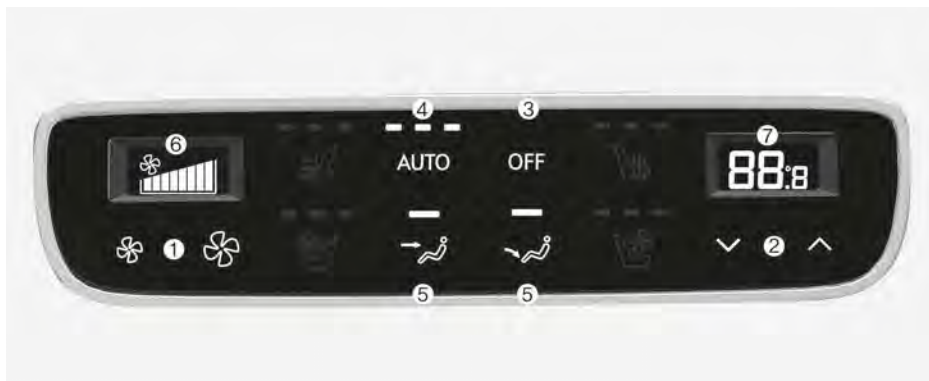

Third row seat (7-seater) (Type A)



Third row seat (7-seater) (Type B)



The climate control system may differ depending on vehicle specification.

- (1) Fan speed control
- (2) Temperature control
- (3) OFF (system off)
- (4) AUTO (automatic control)
- (5) Mode selection
- (6) Fan speed display
- (7) Temperature display

### *i* Information

- Temperature, Mode selection (air flow direction), and Fan speed can be controlled from the rear seat. However, if **Setup > Vehicle > Climate > Climate Features > Lock the Rear Climate Control** is selected, the rear climate control can be operated only from the front seat.
  - Use the climate control system with the engine running for more effectiveness of the system, and to prevent battery discharge.
-

## Automatic Heating and Air Conditioning

The Automatic Climate Control System is controlled by setting the desired temperature.

### 1. Press the **AUTO** button.

The mode selection, fan speed, air intake and air conditioning are controlled automatically by the temperature setting.

You can control the fan speed in three stages by pressing the **AUTO** button during automatic operation.

- High: Provides rapid air conditioning and heating with the maximum fan speed setting.
- Medium: Provides air conditioning and heating with the mid-level fan speed setting.
- Low: Fan speed is set to the lowest setting range.

### 2. Turn the temperature control knob to set the desired temperature. If the temperature is set to the lowest setting, the air conditioning system operates continuously. After the interior has cooled sufficiently, adjust the knob to a higher temperature set point whenever possible.

To turn off the automatic operation, select any button of the following buttons:

- Mode selection button
- Front windshield defroster button (Press the button one more time to deselect the front windshield defroster function. The "AUTO" illuminates on the information screen once again.)
- Fan speed control icon or knob
- **A/C** (air conditioning) icon

The selected function is controlled manually while other functions operate automatically.

For your convenience and to improve the effectiveness of the climate control, use the **AUTO** button and set the temperature to 72 °F (22 °C).

### *i* Information



Never place anything near the sensor to ensure better control of the heating and cooling system.

## Manual Heating and Air Conditioning

1. Start the engine.
2. Set the mode to the desired position.

For improving the effectiveness of heating and cooling, select:

- Heating: ~↗
- Cooling: ~↘

3. Set the temperature control to the desired position.
4. Set the air intake control to the outside (fresh) air position.
5. Set the fan speed control to the desired speed.
6. If air conditioning is desired, turn on the air conditioning system.
7. Press the **AUTO** button to convert to full automatic control of the system.

## Mode selection

### Front seat mode selection

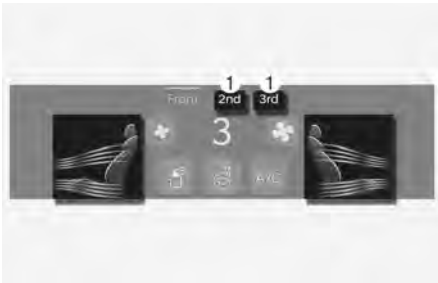

- Touch each air flow direction on the information screen to select the desired flow direction.
- Press the **SYNC** button and when the indicator light on the button turns off, the air flow direction of the driver's seat, passenger seat, and rear seats can be controlled individually. The front passenger and rear passenger seats cannot select  position.
- Touch **Rear** or **2nd** or **3rd** to control the rear seat's mode selection from the front seats.
- You may select 2-3 modes at the same time.

### Rear seat mode selection

Second row



Third row (Type A, Type B)

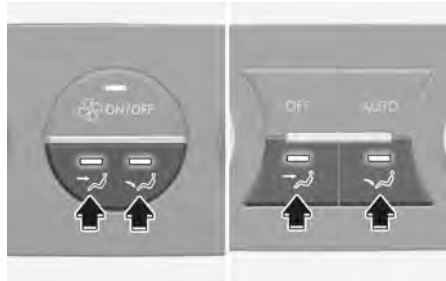

- Press the button to select the direction of the air flow to the desired position.
- You may select 2 modes at the same time.

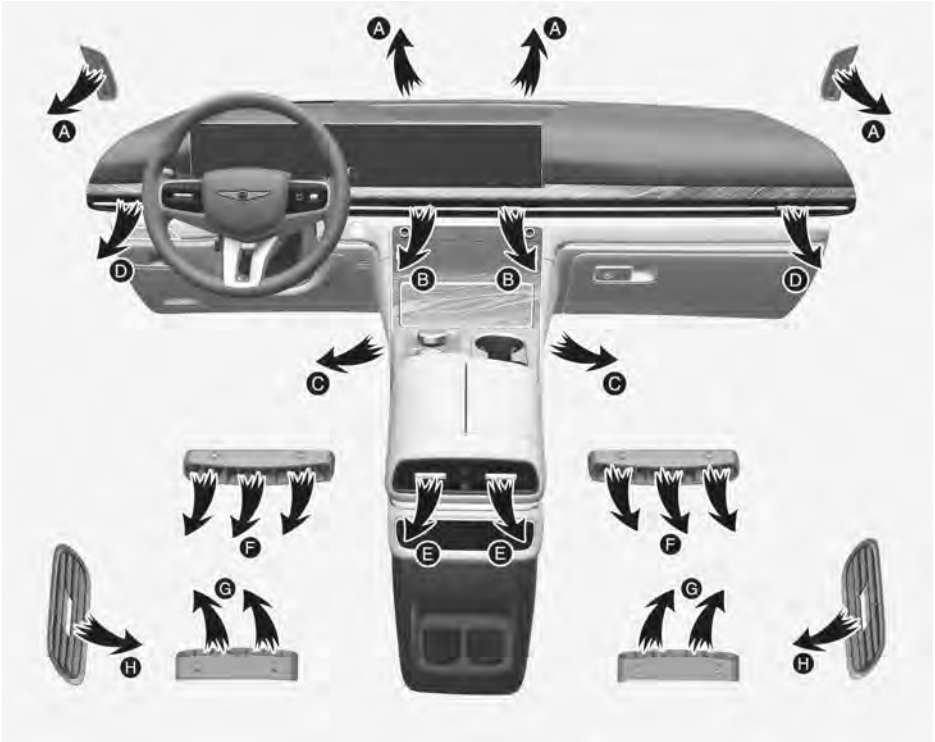

**Air flow direction**

The mode selection icon or button controls the direction of the air flow through the ventilation system.

• **Front seat**

**Defrost (A, D)**



Most of the air flow is directed to the windshield.

**Face-level (B, D)**



Air flow is directed toward the upper body and face. Additionally, each outlet can be controlled to direct the air discharged from the outlet.

**Floor-level (A, C)**



Most of the air flow is directed to the floor, with a small amount of the air being directed to the windshield and side window defrosters.

• **Rear seat**

**Face-level (E, H)**

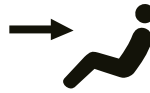

Air flow is directed toward the upper body and face.

**Floor-level (F, G)**



Most of the air flow is directed to the floor.

### Front windshield defroster



#### Defrost-level (A, D)

Press the button, and the indicator light on the button illuminates.

Most of the air flow is directed to the windshield with a small amount of air directed to the side window defrosters.

Press the button again, the indicator light turns off and the previous settings are selected.

### Instrument panel vents

Front seat



Second row

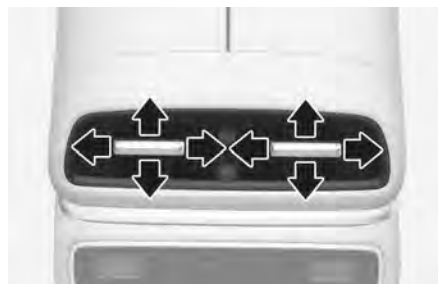

Third row (7-seater)



The instrument panel vent air flow can be directed up/down or left/right using the vent adjustment lever.

The air flow can be closed using the vent adjustment lever.

Move the lever to ⊗ position to close, and to ☰ position to open.

#### *i* Information

The third row air vent cannot be closed.

### Temperature control

Front seat control from the front



Rear seat control from the front



Second row



Third row seat control (7-seater) (Type A, Type B)



The temperature setting increases when you turn the knob to the right or press the ^ arrow on the touchscreen.

The temperature setting decreases when you turn the knob to the left or press the v arrow on the touchscreen.

#### Temperature conversion

If the battery has been discharged or disconnected, the temperature mode display is reset to Celsius.

To change the temperature unit from °F to °C or °C to °F:

- For infotainment system, select: **Setup > General > Units > Temperature Unit > °F/°C**
- For vehicles equipped with Automatic Climate Control, you can also:  
Press the **A/C** button for 3 seconds, and then within 5 seconds press the driver's side face-level (↔) position for more than 3 seconds.

Both the temperature unit on the instrument cluster and climate control information screen is changed.

#### SYNC



#### Adjusting the temperature, air flow direction, and fan speed equally

Press the **SYNC** button from the front seat, (indicator light ON), to adjust the driver, front passenger, and rear passenger side temperature, air flow direction, and fan speed equally.

### Adjusting the temperature, air flow direction, and fan speed individually

Press the **SYNC** button (indicator light OFF) from the front seat again to adjust the driver, front passenger, and rear passenger side temperature, air flow direction, and fan speed individually.

### Air intake control



To select outside (fresh) air or recirculated air, press this button.

### Recirculated air position



With the recirculated air selected, air from the passenger compartment is drawn through the climate control system.

### Outside (fresh) air position



With the outside (fresh) air selected, air enters the vehicle from outside and is drawn through the climate control system.

### *i* Information

Using the system in the fresh air position is recommended.

Prolonged operation of the heater in the recirculated air position (without air conditioning selected) can cause fogging of the windshield and side windows and the air within the passenger compartment will become stale.

In addition, prolonged use of the air conditioning with the recirculated air position selected will result in excessively dry air in the passenger compartment.

### WARNING

To prevent serious injury or death:

- Continued climate control system operation in the recirculated air position may allow humidity to increase inside the vehicle that could fog the windshield and the side windows and obscure visibility.
- Do not sleep in a vehicle with the air conditioning or heating system on.
- Continued climate use of recirculated air may cause drowsiness or sleepiness, and loss of vehicle control. Set the air intake control to the outside (fresh) air position while driving.

### Fan speed control

Front seat control from the front

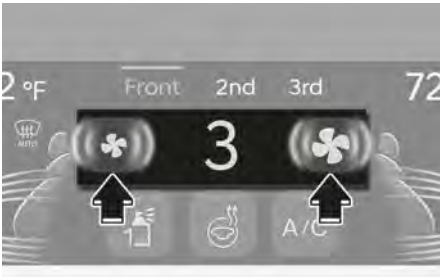

Rear seat control from the front (if equipped)



Second row seat control

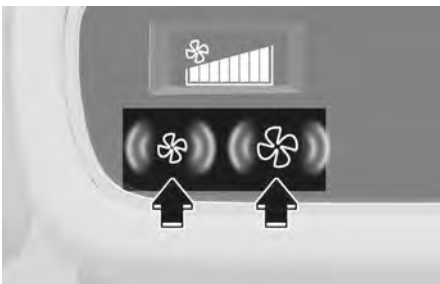

Third row (7-seater) (Type A, Type B)

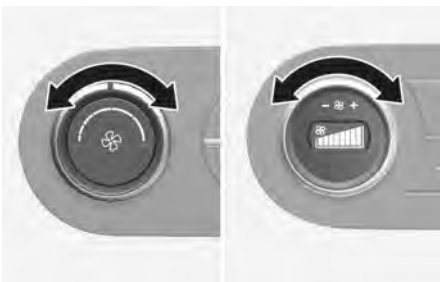

Press the **+** button or turn the knob to the right to increase fan speed and airflow. Press the **-** button or turn the knob to the left to decrease fan speed and airflow.

Pressing the **OFF** button turns off the fan.

### NOTICE

Operating the fan when the Engine Start/Stop button is in the OFF position may cause the battery to discharge.

### Air conditioning



Press the **A/C** button to manually turn the air conditioning on (indicator light ON) and off.

## Clean Air system



The fine dust concentration in the cabin is measured by the fine dust sensor installed in the vehicle. The cabin air status is displayed on the screen.

If necessary, the system prevents contaminated air from entering the cabin and the cabin air filter purifies the cabin air by filtering the fine dust.

### Cabin air status display

The air status is displayed in four levels when the climate control system turns on.

Cabin air system	Level displayed				
	Cabin Air Condition	Good	Normal	Poor	Very poor
Green		Yellow	Orange	Red	

### *i* Information

- The cabin air filter should be replaced per every 15,000 km to maximize performance of the clean air system.
- If the vehicle is being driven in an inner-city area with high air pollution or severe conditions such as dusty or rough roads or the indoor fine dust concentration is not presented as Good on the screen due to prolonged heavy fine dust, more frequent cabin air filter changes are required than per 15,000 km.
  - Driving in an inner-city area with high air pollution
  - Frequently driving on dusty or rough roads
  - Prolong air pollution such as fine dust
- Using genuine cabin air filter to maintain the optimal performance of the clean air system.
- The dust concentration level measured inside the vehicle is in real-time. The measured value differs from the dust concentration in the atmosphere.
- The displayed level may differ depending on the measurement method or location. The displayed levels are for reference only.

### Built in diffuser

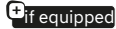
 if equipped

3 types of fragrances are provided. The fragrance type is automatically recognized when the cartridge is installed.

#### Diffuser setting

Fragrance and its intensity can be set as follows in the infotainment system:

- **Setup > Vehicle > Climate > Fragrance > Intensity/Scent**



Press  button to select the desired fragrance intensity.

- Intensity can be selected among Strong, Medium, and Light. Pressing the button each time changes the intensity in the order of Strong, Medium, Light and Off.
- The fragrance cannot be selected with the button. Fragrance can only be selected from the settings menu in the infotainment system.

### Replacing cartridges

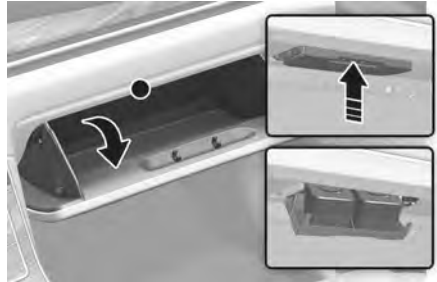

1. Turn the engine off, and open the glove box.
2. Press the upper part of the diffuser tray.
3. Replace the cartridge.

#### *i* Information

- For smooth operation of the diffuser, it is recommended to install 2 cartridges.
- If the cartridge is empty or has been used for about one year or more replace with a new cartridge.
- The built-in diffuser may not work if the cartridge is not installed properly. Check whether the cartridge is installed properly.



**OFF**

Front seat control from the front



Rear seat control from the front

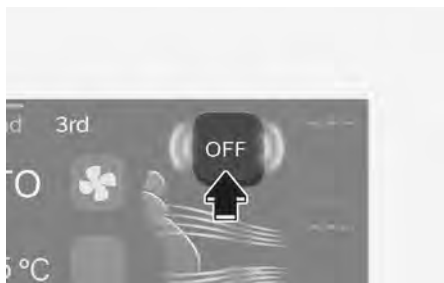

Second row seat control



Third row seat control (7-seater) (Type A, Type B)



Press the **OFF** button to turn off the climate control system. You can still operate the mode buttons and air intake buttons as long as the Engine Start/Stop button is in the ON position.

- If OFF is pressed from the front seat, the front and rear climate control system turns off.
- If OFF is pressed from the rear seat, only the rear climate control system turns off.

**System Operation****Cooling/Ventilation**

1. Set the mode to the  position.
2. Set the air intake control the outside (fresh) air or recirculated air position.
3. Set the temperature control to the desired position.
4. Set the fan speed control to the desired speed.

**Heating**

1. Set the mode to the  position.
2. Set the air intake control the outside (fresh) air or recirculated air position.
3. Set the temperature control to the desired position.
4. Set the fan speed control to the desired speed.
5. If desired, turn the air conditioning ON with the temperature control knob set to heat in order to dehumidify the air before it enters into the cabin.

If the windshield fogs up, set the mode to the  position.

### Operation Tips

- To keep dust or unpleasant fumes from entering the vehicle through the ventilation system, temporarily set the air intake control to the recirculated air position. Return the control to the outside (fresh) air position when the unpleasant air outside has diminished. This can help keep the driver alert and comfortable.
- To help prevent the inside of the windshield from fogging, set the air intake control to outside (fresh) air position and the fan speed to the desired position, turn on the air conditioning system, and adjust the temperature control to the desired temperature.

### Air conditioning

Your Genesis Branded Vehicle air conditioning system is filled with R-1234yf refrigerant.

1. Start the engine. Press the air conditioning button.
2. Set the mode to the  position.
3. Set the air intake control to the recirculated air position temporarily to allow the cabin to cool quickly. When the desired temperature in the cabin is reached, change the air intake control back to the outside (fresh) air position.
4. Adjust the fan speed control and temperature control to as desired.

### NOTICE

- When using the air conditioning system, monitor the temperature gauge closely while driving up hills or in heavy traffic when outside temperatures are high. Continue to use the fan but turn off the air conditioning system if the temperature gauge indicates the engine is overheating.
- Always use the air conditioning with the windows closed. In humid weather, if the windows are open and the air conditioning is running, water droplets may form inside the vehicle and potentially damage electrical equipment.

### Air conditioning system operation tips

- If the vehicle has been parked in direct sunlight during hot weather, open the windows for a short time to let the hot air inside the vehicle escape.
- After sufficient cooling has been achieved, switch back from the recirculated air position to the outside (fresh) air position.
- To help reduce moisture inside of the windows on rainy or humid days, decrease the humidity inside the vehicle by operating the air conditioning system with the windows and sunroof closed.
- Use the air conditioning system every month only for a few minutes to ensure maximum system performance.
- If you operate air conditioner excessively, the difference between the temperature of the outside air and that of the windshield may cause the outer surface of the windshield to fog up, causing loss of visibility. In this case, set the mode selection to the  position and fan speed control to the lowest speed.

## System Maintenance

### *Cabin air filter*

The cabin air filter is installed behind the glove box. It filters the dust or other pollutants that enter the vehicle through the heating and air conditioning system.

Have the cabin air filter replaced by an authorized retailer of Genesis Branded products according to the maintenance schedule. If the vehicle is being driven in severe conditions such as dusty or rough roads, more frequent cabin air filter inspections and changes are required.

### *Checking the amount of air conditioner refrigerant and compressor lubricant*

If the amount of refrigerant is too low or too high, the performance of the air conditioning is reduced. Have the system inspected by an authorized retailer of Genesis Branded products.

### **NOTICE**

- The refrigerant system should only be serviced by trained and certified technicians in a well-ventilated area to ensure proper and safe operation.
- The air conditioning evaporator (cooling coil) shall never be repaired or replaced with one removed from a used or salvaged vehicle and new replacement MAC evaporators shall be certified (and labeled) as meeting SAE Standard J2842.

### **WARNING**



Since the refrigerant is mildly flammable and operated at high pressure, the air conditioning system should only be serviced by trained and certified technicians. It is important that the correct type and amount of oil and refrigerant are used.

All refrigerants should be reclaimed with proper equipment.

Venting refrigerants directly to the atmosphere is harmful to individuals and environment. Failure to heed these warnings can lead to serious injuries.

### **Air Conditioning refrigerant label**



You can find out which air conditioning refrigerant is applied to your vehicle on the label located inside of the hood.

Each symbols and specification on the air conditioning refrigerant label is represented as below:



- (1) Classification of refrigerant
- (2) Amount of refrigerant
- (3) Classification of compressor lubricant
- (4) Caution
- (5) Flammable refrigerant
- (6) To require registered technician to service air conditioning system

**Photo-catalyst Module**



Freshens a vehicle’s inner space by deodorization of lingering odor through PCM installed in HVAC system.

Your Genesis is equipped with the PCM which includes a visible ray LED and photo-catalytic material. The PCM is activated automatically when the vehicle is started.

The PCM deodorizes harmful gases such as NH3 or HCHO and reduces the number of floating viruses and bacteria nearby PCM and eventually air inside cabin of your vehicle will be refreshed by continuous air flow through PCM installed in HVAC system.

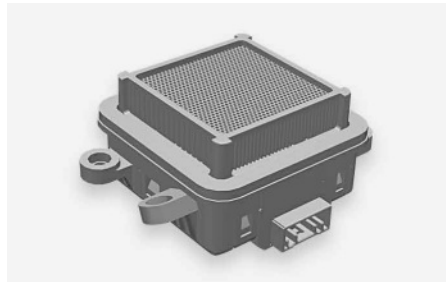

Ex)  $2\text{HCHO} + 2\text{H}_2\text{O} + 2\text{O}_2 \rightarrow 2\text{CO}_2 + 4\text{H}_2\text{O}$

- Photocatalytic radical reaction  
-> Removal of harmful substances (VOC gases/microorganisms)

**Air cleaning mechanism**

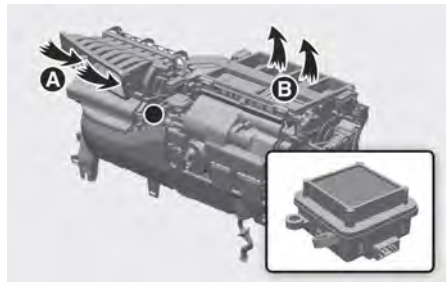

- (1) Outdoor air
- (2) Clean air

Part	Function
HVAC	Intakes indoor and outdoor air into the HVAC, passes it through the PCM, and then supplies clean air to the interior of the vehicle.
PCM	The visible ray LED photo-catalyst module produces radicals by photocatalytic reaction.

Part	Function
Radicals	Radicals generated by the PCM attach to viruses, bacteria and harmful gases such as NH <sub>3</sub> and HCHO and reduce the number of them in HVAC system.

### PCM parts

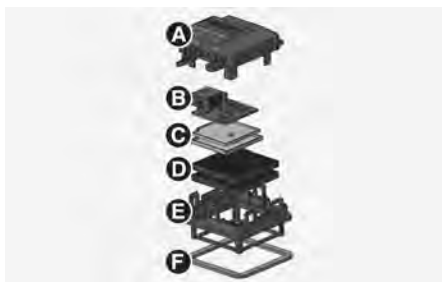

- [A] Upper cover
- [B] PCB & Connector
- [C] Water protection PCB cover
- [D] Photo-catalyst
- [E] Lower cover
- [F] Leakage protection seal

- Size: 2x2x1 in. (53x53x27 mm)
- Weight: 1.6 oz (46 g)

### Direction for use

The PCM, Photo-catalyst Air Purifier Module for HVAC is activated automatically when the engine of automobile is started and deactivated automatically when the engine is turned off.

### NOTICE

- Do not disassemble, modify or repair. Any changes or modifications to product can void your manufacturer's warranty.
- If you need servicing, visit a designated service center.
- Do not use the product for anything other than its original purpose.
- Do not drop or cause excessive impact to the product.

- Do not apply any other substances on the photo catalyst surface.
- If water is on the product, dry it thoroughly before using it.

### NOTICE

- Disposal
  - Dispose of contents and containers according to the regulations stipulated in the wastes control act.
- Storage
  - Do not store near acids. As packed massive products may constitute a manual handling risk. (e.g., sharp)
  - Do not store in areas with high concentrations of dust or airborne materials.

### ⚠ WARNING

- This product should be sold only through and be installed by automobiles. Other uses are not acceptable device.
- PCM may be particularly helpful when additional ventilation with outdoor air is not possible without compromising indoor comfort (temperature or humidity), or when outdoor air pollution is high.
- The use of PCM alone cannot ensure adequate indoor air quality, particularly where significant pollutant sources are present, and ventilation is insufficient.

### *i* Information

EPA company number: 101282-KOR-1

## Windshield Defrosting and Defogging

### **⚠ WARNING**

Do not use the defrost-level (☃) position during the cooling operation in extremely humid weather. The outer surface of the windshield may fog and reduce visibility, causing a collision that results in serious injury or death. Set the mode selection button to the face-level (→) position and fan speed control knob to a lower speed.

- For maximum defrost performance, set the temperature control to the highest temperature setting and the fan speed control to the highest setting.
- If warm air to the floor is desired while defrosting or defogging, select the floor-defrost position.
- Before driving, clear all snow and ice from the windshield, rear window, side view mirrors, and all side windows.
- Clear all snow and ice from the hood and air inlet to improve heater and defroster efficiency and to reduce the probability of fogging up the inside of the windshield.

### **NOTICE**

If the engine temperature is still cold after starting, then a brief engine warm up period may be required for the vented air flow to become warm or hot.

## To Defog Inside Windshield



1. Select the desired fan speed.
2. Select the desired temperature.
3. Press the defroster (☃) button.

The air conditioning turns on according to the detected ambient temperature, the outside (fresh) air position and higher fan speed are selected automatically.

If the air conditioning, outside (fresh) air position and higher fan speed are not selected automatically, adjust the corresponding button or knob.

If the defrost-level (☃) position is selected, lower fan speed is adjusted to higher fan speed.

## To Defrost Outside Windshield



1. Set the fan speed to the highest position.
2. Set the temperature to the hottest position.
3. Press the defroster (☃) button.

The air conditioning turns on according to the detected ambient temperature and the outside (fresh) air position is selected automatically.

If the front defrost-level (☃) position is selected, lower fan speed is adjusted to a higher fan speed.

## Rear Window Defroster

### NOTICE

Never use sharp instruments or window cleaners containing abrasives to clean the window to prevent damage to the rear window defroster.



The defroster heats the window to remove frost, fog, and thin ice from the interior and exterior of the rear window, while the engine is running.

- To activate it press the rear window defroster button located in the center control panel. The indicator on the rear window defroster button illuminates when the defroster is ON.
- To turn it off press the rear window defroster button again.

### *i* Information

- If there is heavy accumulation of snow on the rear window, brush it off before operating the rear defroster.
- The rear window defroster automatically turns off after about 20 minutes or when the Engine Start/Stop button is in the OFF position.

### *Side view mirror defroster*

if equipped

The side view mirror defrosters operate when you turn on the rear window defroster.

## Climate Control Additional Features

### *i* Information

The infotainment system may change after software updates. For more information, refer to the manual provided in the infotainment system and the quick reference guide.

### Air Conditioning Auto-Drying

 If equipped

The Air Conditioner Auto Drying feature dries the moisture in the air conditioner and reduces air conditioner odor. The blower motor automatically operates after 30 minutes the engine is turned off.

#### *Turning Air Conditioner Auto Drying on or off*

The Air Conditioner Auto Drying feature can be turned on and off by selecting **Setup > Vehicle > Climate > Air Conditioner Auto Drying**.

If the operating conditions are satisfied after setting the feature, the operating condition appears on the infotainment system and the blower motor automatically operates.

When the Air Conditioner Auto Drying feature is activated, the air conditioner sets the fan speed to the third level, selects outside (fresh) air position, and directs the air flow to the upper body and face.

#### **Operating conditions**

- The engine is turned off after operating the air conditioner for a certain period.
- The battery level is sufficient and the outside temperature is above a certain level.

#### **Non-operating conditions**

- The Air Conditioner Auto Drying feature has operated for 10 minutes.
- The Engine Start/Stop button is pressed, or the engine is on.
- The climate control system is operated remotely.

### *i* Information

The Air Conditioner Auto Drying feature reduces air conditioner odors but may not remove all odors.

### Auto Defogging System

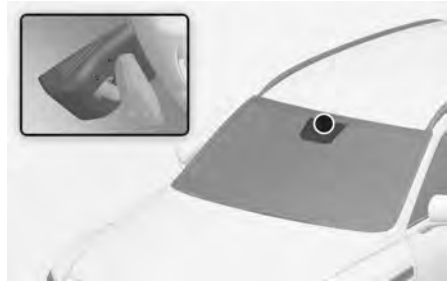

Auto defogging helps reduce the likelihood of fogging up the inside of the windshield by sensing the moisture on the inside of the windshield.

The Auto Defogging system operates when the heater or air conditioning is on.

### *i* Information

The Auto Defogging system may not operate normally, when the outside temperature is below -15 °C (5 °F).





If high amount of humidity is detected in the vehicle, the Auto Defogging system is enabled.

The following steps are performed automatically:

1. Air conditioning turns on and outside (fresh) air is selected.
2. Defrost-level is selected.
3. Fan speed is set to MAX.

### **Turning the Auto Defogging System ON or OFF**

#### **Climate control system**

Press the front windshield defroster button for three seconds when the Engine Start/Stop button is in the ON position to turn the system on or off.

To check whether the system is on or off, go to the settings menu in the infotainment system and see if **Auto Defog** is selected or not.

#### **Infotainment system**

Auto Defogging system can be turned on and off by selecting **Setup > Vehicle > Climate > Defog/Defrost Options > Auto Defog** from the Settings menu.

### **i Information**

- Do not select recirculated air while the Auto defogging system is operating.
- When Auto Defogging system is operating, fan speed adjustment, temperature adjustment, and air intake control selection are all disabled.

### **NOTICE**

Do not remove the sensor cover located on the top of the windshield glass. Damage may not be covered by your vehicle warranty.

## **Auto Dehumidify**

**+** if equipped

Recirculated air position switches off automatically after about 5 to 30 minutes, depending on the outside temperature, and the air intake will change to outside (fresh) air position.

### **Turning Auto Dehumidify ON or OFF**

#### **Climate control system**

To turn the Auto Dehumidify feature on or off, select face-level (↔) position and press the air intake control (🌀) button at least five times within three seconds. When Auto Dehumidify is turned on, the air intake control button indicator blinks 6 times. When turned off, the indicator blinks 3 times.

#### **Infotainment system**

Auto Dehumidify can be turned on and off by selecting **Setup > Vehicle > Climate > Automatic Ventilation > Automatic Dehumidify** from the Settings menu.

## **Recirculating Air When Washer Fluid is Used**

Recirculated air position automatically activates to reduce the scent of the washer fluid entering the cabin when the windshield washer is used.

However, in cold weather to prevent the windshield from fogging up, the recirculated air position may not be selected.

## **Turning Activate upon Washer Fluid Use ON or OFF**

### **Climate control system**

To turn the Activate upon Washer Fluid Use feature on or off, select floor-level (↶↷) position, and then press the air intake control (🌀) button five times within three seconds.

When Activate upon Washer Fluid Use ON is turned on, the air intake control button indicator blinks 6 times. When turned off, the indicator blinks 3 times.

### **Infotainment system**

Activate upon Washer Fluid Use can be turned on and off by selecting **Setup > Vehicle > Climate > Recirculate Air > Activate upon Washer Fluid Use** (or **Activation on washer fluid use**) from the Settings menu.

## **Sunroof Inside Air Recirculation**

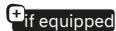
 if equipped

When the sunroof is opened, the outside (fresh) air position is automatically selected. If you press the air intake control button, the recirculated air position is selected but changes back to the outside (fresh) air position after 3 minutes. When the sunroof is closed, the air intake position returns to the previous position.

## **Automatic Controls Linked to Climate Control Settings (for Driver's Seat)**

The temperature of the driver's seat warmer, the air ventilated seat, and heated steering wheel is automatically controlled depending on the inside and outside temperature of the vehicle when the engine is running.

To use these features, it can be enable the Settings menu in the infotainment system. Select:

- **Setup > Vehicle > Seat > Heating/Ventilation > Automatic Controls Linked to Climate Control Settings**

For more information on Auto Comfort Control, refer to the "Seat Warmers" and "Air Ventilation Seats" sections in chapter 3 and "Heated Steering Wheel" section in chapter 5.

## **Recirculating Air When Entering a Tunnel**

 if equipped

To prevent the inflow of polluted air into the vehicle when passing through a tunnel, this function automatically closes the windows and switches the climate control system to recirculated air position for about 7 seconds before entering a tunnel based on the map information of the navigation and the speed of the vehicle.

The windows automatically closes before entering a tunnel and area requiring air recirculation. The windows open to the previous position after passing through the area. If the power window switch is operated before the window opens, the window does not open to the previous position.

To use this feature, it can be enabled from the Settings menu in the infotainment system. Select:

- **Setup > Vehicle > Climate > Recirculate Air > Activate upon Entering Tunnels (or When entering tunnels)**

### *Operating conditions*

One or more of the windows are opened or outside (fresh) air position is selected.

### *i* Information

- The activation time for the function may differ depending on the gap between the GPS data and vehicle speed.
- The function activates until you have passed through continuous tunnels.
- When entering a tunnel, recirculated air position may cause fogging of the windshield. Press the windshield defroster button.
- The function does not operate in short tunnels.
- The function may not activate if the GPS is not working properly.

## Storage Compartment

### **⚠ WARNING**

Never store cigarette lighters, propane cylinders, or other flammable/explosive materials in the vehicle. These items may catch fire and/or explode if the vehicle is exposed to hot temperatures for an extended period of time.

### **⚠ WARNING**

Always keep the storage compartment covers closed securely while driving. Items inside your vehicle are moving as fast as the vehicle. If you have to stop or turn quickly, or if there is a crash, the items may fly out of the compartment and may cause an injury if they strike the driver or a passengers.

### **NOTICE**

To avoid possible theft, do not leave valuables in the storage compartments.

## Center Console Storage



To open:  
Press the button.

## Rear Console Storage

Second row (5, 7-seater)

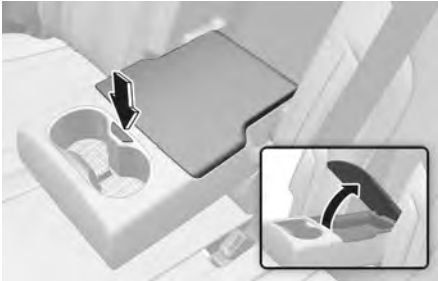

To open:  
Press the button.

## Glove Box

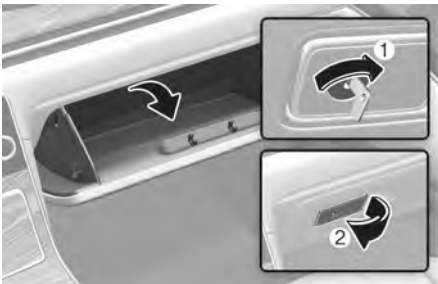

The glove box can be locked and unlocked with the mechanical key (1).

To open:  
Pull the lever (2).

### **WARNING**

Always close the glove box door after use. An open glove box door may cause serious injury to a passenger in a collision, even if the passenger is wearing a seat belt.

## Sunglass Holder

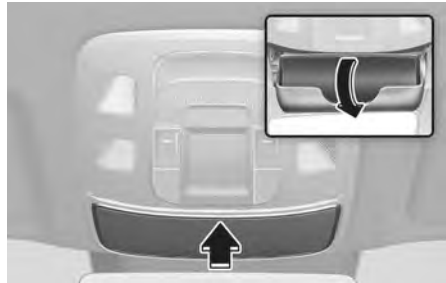

To open:  
Push and release the cover and the holder will slowly open. Place your sunglasses in the compartment door with the lenses facing out.

To close:  
Push back into position.

Make sure the sunglasses holder is closed while driving.

### **WARNING**

- Do not keep objects except sunglasses inside the sunglasses holder. Such objects can be thrown from the holder in the event of a sudden stop or an accident, possibly injuring the passengers in the vehicle.
- Do not open the sunglasses holder while the vehicle is moving. The rear view mirror of the vehicle can be blocked by an open sunglasses holder.
- Do not put the glasses forcibly into a sunglasses holder. It may cause personal injury if you try to open it forcibly when the glasses are jammed in holder.

### Storage Box

**+** if equipped

Third row

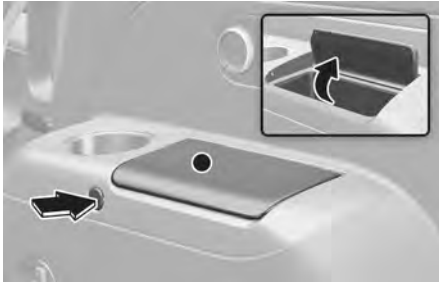

To open:  
Press the button.

### Cargo Tray

**+** if equipped

Type A



Type B



You can place a first aid kit, a reflector triangle (front tray), tools, etc. in the box for easy access.

- Grasp the handle on the top of the cover and lift it.

### Interior Features

#### Cup Holder

Front



Second row



Third row (7-seater)

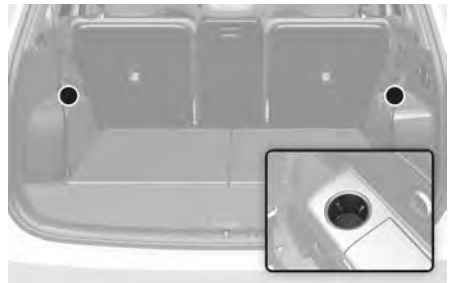

Cups or small beverage cups may be placed in the cup holders.

**WARNING**

- Avoid abrupt starting and braking when the cup holder is used to prevent spilling your drink. If hot liquid spills, you may be burned. Such a burn to the driver may cause loss of vehicle control resulting in a collision.
- Do not place uncovered or unsecured cups, bottles, cans, etc., in the cup holder containing hot liquid while the vehicle is moving.
- Only use soft cups in the cup holders.

**NOTICE**

- Keep your drinks sealed while driving to prevent spilling. If spilled, it may damage the vehicle's electrical/electronic system.
- When cleaning spilled liquids, do not use hot air to blow out or dry the cup holder.
- Keep cans or bottles out of direct sun light and do not put them in a hot vehicle. Otherwise, they may explode.

**Ashtray**

**If equipped**



To use the ashtray, open the cover.

To clean the ashtray:

The plastic receptacle should be removed by lifting the plastic ashtray receptacle upward and pulling it out.

**WARNING**

Putting lit cigarettes or matches in an ashtray with other combustible materials may cause a fire.

**Armrest Warmer**

**If equipped**

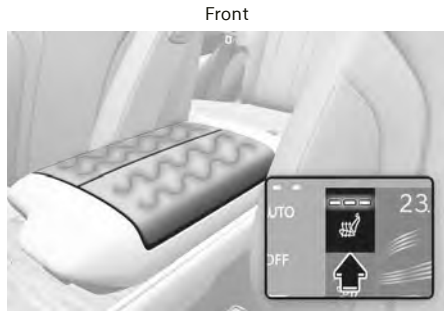

Press the front seat warmer button to warm the front seat and armrest.

Enable the armrest warmer from the Settings menu in the infotainment system. Select:

- **Setup > Vehicle > Seat > Heated/Ventilated Features > Automatic Controls Linked to Climate Control Settings > Driver's Armrest Warmer or Passenger's Armrest Warmer**

**i Information**

- The temperature is automatically controlled to prevent low temperature burns.
- The seat warmer defaults to the OFF position whenever the Engine Start/Stop button is in the ON position.
- For more information on seat warmer operation, refer to the "Seat Warmers" section in chapter 3.

## Sunvisor



To use the sunvisor, pull it downward.

To use the sunvisor to block the sun from the side window, pull it downward, release it from the bracket (1) and swing it to the side (2) toward the window.

To use the vanity mirror, pull down the sunvisor and slide the mirror cover (3).

Adjust the sunvisor forward or backward (4) as needed (if equipped). Use the ticket holder (5) to hold tickets.

Close the vanity mirror cover securely and return the sunvisor to its original position after use.

### **WARNING**

Do not block your view when using the sunvisor.

### **NOTICE**

The tab (5) adjacent to the vanity mirror on the sunvisor can be used for toll road tickets or self parking tickets. Use caution when inserting tickets into the ticket holder to avoid damage. Refrain from putting several tickets in the ticket holder as this could also damage the retaining tab.

## Rear Mirror

 if equipped

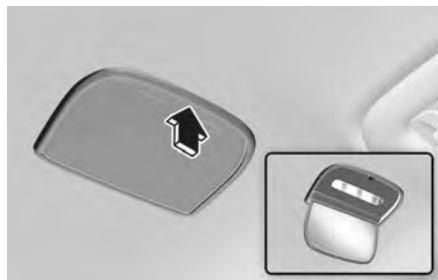

To open:

Press the cover and it will slowly open and the mirror lamp turns on.

To close:

Push back into position.

## Power Outlet

Front



Second row



## Convenience Features

Cargo area



The power outlet is designed to provide power for mobile phones or other devices designed to operate with vehicle electrical systems. The devices should draw less than 180 watts with the engine running.

### WARNING

Avoid electrical shocks. Do not place your fingers or foreign objects (pin, etc.) into a power outlet or touch the power outlet with a wet hand.

### NOTICE

To prevent damage to the power outlets:

- Use the power outlet only when the engine is running and remove the accessory plug after use. Using the accessory plug for an extended period of time with the engine off may cause the battery to discharge.
- Only use 12 volts electric accessories that are less than 180 watts in the electric capacity.
- Adjust the air conditioner or heater to the lowest operating level when using the power outlet.
- Close the cover when not used.

- Some electronic devices may cause electronic interference when plugged into a vehicle's power outlet. These devices may cause excessive audio static and malfunctions in other electronic systems or devices used in your vehicle.
- Push the plug in as far as it goes. The plug may overheat and the fuse may open.
- Only connect devices with reverse current protection or the current from the device battery may cause the vehicle's electrical/electronic system to malfunction.

## USB Charger

Front

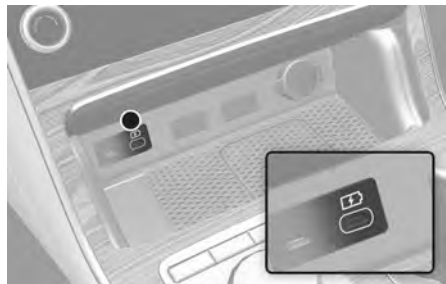

Second row



The USB charger is designed to recharge batteries of small size electronic devices using a USB cable.

The electrical devices can be charged while the engine is running.



## *i* Information

- The battery charging state may be monitored on the electronic device.
- Disconnect the USB cable from the USB port after use.
- A smartphone or a tablet PC that does not use a USB cable to charge should be charged using its own charger.
- Do not attempt to use the charging terminal to turn ON an audio or to play media with the infotainment system.
- Charging may not be possible when using a Type-C to A converter sold by a mobile phone manufacturer or commercially available.

## NOTICE

- Use the USB charger when the engine is running. Using USB charger for prolonged periods of time with the engine off may cause the battery to discharge.
- To prevent damage to the USB charger:
  - Do not insert foreign objects or spill liquid into the outlet. The USB charging terminal may be damaged.
  - Do not use devices with working current exceeding 2,100 mA (2.1 A).

## AC Inverter

 if equipped



The AC inverter supplies 115 volts/150 watts electric power to operate electric accessories or equipment.

## *i* Information



- Rated voltage: AC 115 volts
- Maximum electric power: 150 watts
- In order to avoid an electrical system failure, electric shock, etc., read the owner's manual before use.

**⚠ WARNING**

To reduce a risk of serious or fatal injuries:

- Do not use a heated electric device such as a coffeepot, toaster, heater, iron, etc.
- Do not place your fingers or foreign objects (pin, etc.) into a outlet or touch the outlet with a wet hand.
- Do not let children touch the AC inverter.

**NOTICE**

To prevent damage to the AC inverter:

- Use the AC inverter only when the engine is running and remove the accessory plug after use. Using the accessory plug for an extended period of time with the engine off may cause the battery to discharge.
- Close the cover when not used.
- Only use 115 volts electric accessories that are less than 150 watts in the electric capacity.
- Some electronic devices may cause electronic interference when plugged into a vehicle's AC inverter.
- Do not use broken electric accessories or equipment.
- Do not use two or more electric accessories or equipment at the same time.
- When the input voltage is low, the outlet LED blinks and the AC inverter turns off automatically. If the input voltage goes up to normal, the AC inverter turns on again.

## Wireless Smartphone Charging System

Front

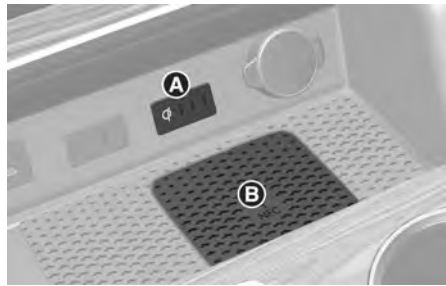

[A] Indicator light  
[B] Charging pad

### Charging your smartphone

The wireless smartphone charging system charges only the Qi-enabled smartphones (☑). Visit your smartphone manufacturer's website to check whether your smartphone supports the Qi technology.

The wireless charging process starts when you put a Qi-enabled smartphone on the wireless charging unit.

1. The wireless smartphone charger is available when all doors are closed, and when the Engine Start/Stop button is in the ON or START position.
2. Turn on the wireless charging function in the infotainment system. Select:
  - **Setup > Vehicle > Convenience > Wireless Charging System for Mobile Devices**
3. Set the indicator type to be displayed when a smartphone is being charged. Select:
  - **Setup > Vehicle > Convenience > Mobile Phone Wireless Charging Indicator**
4. Place the smartphone on the center of the wireless charging pad. The indicator light is displayed depending on the type selected while the smartphone is being charged.

### *i* Information

- Remove other items, including the smart key from the wireless charging pad.
- For flip type smartphones, when using wireless charging, place the smartphone folded with the device's back placed on the center of the wireless charging unit.

If your smartphone is not charging:

- Move the smartphone on the charging pad.
- Make sure the indicator light is orange.

The indicator light will blink orange for 10 seconds if there is a malfunction in the wireless charging system.

The system warns you with a chime if the smartphone is still on the wireless charging pad after the engine is turned OFF and the front door is opened.

### *i* Information

The infotainment system may change after software updates. For more information, refer to the user's manual provided in the infotainment system and the quick reference guide.

### NOTICE

- The wireless smartphone charging system may not support certain smartphones, that do not meet the Qi specification (Φ).
- When placing your smartphone on the charging pad, position the phone in the middle of the mat for optimal charging performance. If your smartphone is off to the side, the charging rate may be less and in some cases the smartphone may experience higher heat conduction.
- The wireless charging may stop temporarily when the smart key is used, either when starting the vehicle or locking/unlocking the doors, etc.
- For some manufacturer's smartphones, the system may not warn you even though the smartphone is left on the wireless charging unit. This is due to the particular characteristic of the smartphone and not a malfunction of the wireless charging.
- When charging certain smartphones, the charging indicator may not change to blue when the smartphone is fully charged.
- The wireless charging process may temporarily stop, when temperature abnormally increases inside the wireless smartphone charging system. The wireless charging process does not restart, until the temperature falls.
- The wireless charging process may temporarily stop when there is any metallic item, such as a coin, between the wireless smartphone charging system and smartphone.
- When charging some smartphones with a self-protection feature, the wireless charging speed may decrease and the wireless charging may stop.
- If the smartphone has a thick case, it may not charge.

- If the smartphone is not completely contacting the charging pad, wireless charging may not operate properly.
- Some magnetic items like credit cards, phone cards, or transit cards may be damaged if left with the smartphone during the charging process.
- When any smartphone without a wireless charging function or a metallic object is placed on the charging pad, a small noise may sound. This small sound because the vehicle discerns compatibility of the object placed on the charging pad. It does not affect your vehicle or the smartphone in any way.
- If the Engine Start/Stop button is in the OFF position, the charging stops.
- Some smartphones may not be able to charge depending on the internal structure of the smartphone. If this occurs, try charging the smartphone by moving it to the left or right side of the wireless charging pad. However, for some foldable smartphones that have magnets inside the smartphone, try charging the smartphone while holding it close to the left side of the wireless charging pad.

---

### Clock

The clock can be set from the infotainment system.

#### *i* Information

The infotainment system may change after software updates. For more information, refer to the manual provided in the infotainment system and the quick reference guide.

---

#### **⚠** WARNING

Do not attempt to adjust the clock while driving.

---

### Coat Hook



These hooks are not designed to hold large or heavy items.

#### **⚠** WARNING



Only hang soft clothing without heavy, sharp or breakable objects in the pockets. In a collision or when the curtain airbag is inflated, the objects could move and cause serious injury.

---

## Floor Mat Anchor(s)

ALWAYS use the Floor Mat Anchors to attach the front floor mats to the vehicle and prevent the mats from sliding forward.

### WARNING

To prevent serious injury or death from a floor mat interfering with the brake or accelerator pedals:

- Remove any protective film on the carpet before installing a floor mat.
- Check floor mats are securely attached to the vehicle's floor mat anchor(s) before driving.
- Do not use ANY floor mat that cannot be firmly attached to the vehicle's floor mat anchors.
- Do not stack floor mats on top of another mat (e.g. all weather rubber mat on top of a carpeted floor mat). Only a single floor mat must be installed in each position.
- To avoid any interference with pedal operation, install only Genesis floor mats designed for use in your vehicle.

### NOTICE

Your vehicle was manufactured with driver's side floor mat anchors that are designed to securely hold the floor mat in place. To avoid any interference with pedal operation, Genesis Branded Vehicle recommends that the Genesis floor mat designed for use in your vehicle be installed.

## Rear Side Window Sunshades

 if equipped

Use the rear side window sunshade to block external light coming through the rear window glass.

### Manual sunshades

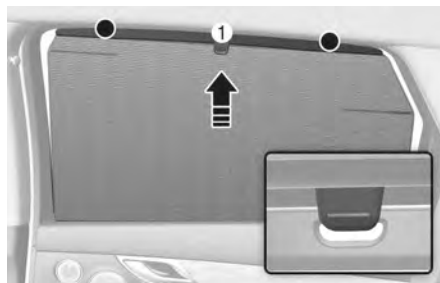

1. Lift the sunshade by the handle (1).
2. Hang the sunshade on both sides of the hook. If the sunshade is hung on one side of the hook, the sunshade may be wrinkled.

### NOTICE

- Do not hang any other object except the rear side window sunshade on the hooks.
- If you pull the rear side window sunshade or apply force to return the sunshade to its original position after use, you may find the sunshade wrinkled or out of shape. To lower the sunshade, be sure to put the handle downward and slowly return the sunshade to its original position.
- Sunshades may not work properly if foreign objects (coins, toys, cookies, etc.) are stuck in the door. Be careful that the foreign objects do not get into the door.

## Power sunshades

Driver's window switch



Rear window switch

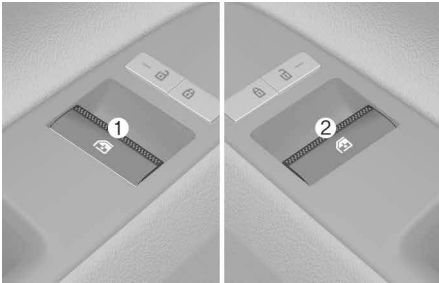

To raise:

1. Close the window by pulling up the power window switch.
2. To unfold the sunshade, pull up the power window switch once more.

To lower:

1. If you want to open the shaded window, push down the power window switch one time to store the sunshade.
2. Push down the power window switch one more time to open the window.

Also, if the window is closed, press and hold the smart key door lock button to raise the rear side window sunshade.

### **i** Information

If the upward or downward movement of the sunshade is blocked by an object or part of the body, the sunshade will detect the resistance and will stop movement and move downward or upward.

## NOTICE

- Do not apply excessive external force on the rear side window sunshade while operating. It may cause a malfunction.
- If excessive force is applied on the antenna rod (1), the sunshade may deform and malfunction.



## Resetting the rear side window sunshades

If the sunshade is not operating normally, it must be reset as follows:

1. Start the engine.
2. Continue pulling up on the power window switch for at least 10 seconds.

If the rear side window sunshade does not work properly after following the above procedure, it is recommended that the system be inspected by an authorized retailer of Genesis Branded products.

## Cargo Net Holder

 if equipped



To keep items from shifting in the cargo area, use the 4 holders located in the cargo area side trim to attach the cargo net.

Make sure the cargo net is securely attached to the holders in the cargo board.

If necessary, contact an authorized retailer of Genesis Branded products to obtain a luggage net.

### WARNING

Avoid eye injury. Do not overstretch the cargo net. Always keep your face and body out of the cargo net's recoil path. Do not use the cargo net when the strap has visible signs of wear or damage.

- Use the cargo net to keep only light items from shifting in the cargo area.

## Cargo Security Screen

 if equipped

### Using the cargo security screen

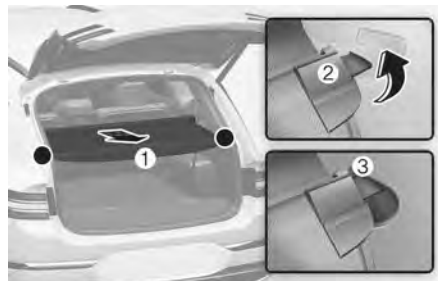

1. Pull the cargo security screen towards the rear of the vehicle by the handle (1).
2. Insert the guide pin (2) into the guides on both sides (3).

### *i* Information

Pull out the cargo security screen with the handle in the center to prevent the guide pin from falling out of the guide.

### When the cargo security screen is not use:

Pull the cargo security screen backward and up to release it from the guides.

The cargo security screen automatically slides back in.

### *i* Information

The cargo security screen may not automatically slide back in if the cargo security screen is not fully pulled out. Pull the cargo screen out all the way and then slowly allow the screen to retract back in.

**! WARNING**

- Do not place objects on the cargo security screen. Such objects may be thrown about inside the vehicle and possibly injure vehicle occupants during a collision or when braking.
- Never allow anyone to ride in the cargo area.

**Removing the cargo security screen**



1. Push one side of the cargo screen inward to compress the spring and then release the screen from the vehicle.
2. While the spring is compressed, pull out the cargo security screen.
3. Open the cargo tray and keep the cargo security screen in the tray.

**Cargo Shelf**

**+** If equipped

**Removing the cargo shelf**

1. Fully fold the cargo shelf (1).
2. While holding both sides, pull out the cargo shelf.

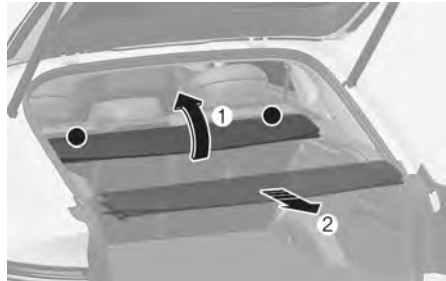

3. To reinstall, insert the cargo shelf into the fixing part [A] on both sides of the cargo area.



**! CAUTION**

- Do not place objects on the cargo shelf. Such objects may be thrown about inside the vehicle and possibly injure vehicle occupants during a collision or when braking.
- Do not put excessive pressure or weight on the cargo shelf. The cargo shelf may be damaged.
- Never allow anyone to ride in the cargo area.



### Storing the cargo shelf



1. Fully fold the cargo shelf.
2. Open the cargo tray and keep the cargo shelf in the tray.

## Exterior Features

### Roof Side Rails

Type A



If your vehicle comes with roof side rails, then roof side rails crossbars can be installed on top of your vehicle.

The roof side rails crossbars are an accessory and are available at your local retailer of Genesis Branded products.

Type B

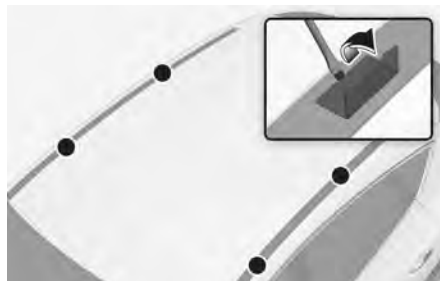

Using the mounting bracket, roof racks or crossbars can be installed.

1. Using a flat-blade screwdriver, open the cover.
2. Install a roof rack or crossbar.
3. Remove a roof rack or crossbar in the reverse order. Close the cover.

#### **NOTICE**

If the vehicle is equipped with a sunroof, be sure not to position cargo onto the roof side rails in such a way that it could interfere with sunroof operation.

#### **NOTICE**

- When carrying cargo on the roof side rails, take the necessary precautions to make sure the cargo does not damage the roof of the vehicle.
- When carrying large objects on the roof side rails, make sure they do not exceed the overall roof length or width.

**⚠ WARNING**

- The following specification is the maximum weight that can be loaded onto the roof side rails. Distribute the load as evenly as possible onto the roof side rails and secure the load firmly. Loading cargo or luggage in excess of the specified weight limit on the roof side rails may damage your vehicle.

ROOF SIDE RAILS	Type A	220 lb (100 kg) EVENLY DISTRIBUTED
	Type B	110 lb (50 kg) EVENLY DISTRIBUTED

- The vehicle center of gravity will be higher when items are loaded onto the roof side rails. Avoid sudden starts, braking, sharp turns, abrupt maneuvers or high speeds that may result in loss of vehicle control or rollover resulting in an accident.
- Always drive slowly and turn corners carefully when carrying items on the roof side rails. Severe wind updrafts, caused by passing vehicles or natural causes, can cause sudden upward pressure on items loaded on the roof side rails. This is especially true when carrying large, flat items such as wood panels or mattresses. This could cause the items to fall off the roof side rails and cause damage to your vehicle or others around you.
- To prevent damage or loss of cargo while driving, check frequently before or while driving to make sure the items on the roof side rails are securely fastened.

## Infotainment System

**NOTICE**

Do not install an aftermarket HID headlight. Your vehicle's audio and electronic devices may not function properly.

### USB Port



The USB port can be used while the engine is running.

- After connecting a media storage device such as a MP3 or USB to the USB port, you can listen to music through the vehicle's speakers or play it on the infotainment system.

***i* Information**

When using a portable audio device connected to the power outlet, noise may occur during playback. If this happens, disconnect the USB cable and use the portable audio device's power source.

## Antenna



The shark fin antenna receives transmitted data (e.g. AM/FM).

## Steering Wheel Remote Controls



### NOTICE

Do not operate multiple audio remote control buttons simultaneously.

#### 1. Volume (+, -)

- Rotate the VOLUME up to increase volume.
- Rotate the VOLUME down to decrease volume.

#### Mute (M)

- Press the MUTE button to mute the sound.
- Press the MUTE button again to activate the sound.

#### 2. SEEK/PRESET (◀, ▶)

If the SEEK/PRESET switch (optical mouse) is swiped to the left or right and held for 0.8 second or more, it functions in the following modes:

- RADIO mode: It functions as the AUTO SEEK select button. It seeks until you release the button.
- MEDIA mode: It functions as the FF/RW button.

If the SEEK/PRESET switch (optical mouse) is swiped to the left or right, it will function in the following modes:

- RADIO mode: It functions by moving between stored PRESET STATIONS.
- MEDIA mode: It functions as the TRACK UP/DOWN button.

#### 3. Mode (↔)

Press the MODE button to toggle through Radio mode or Media mode.

#### 4. Custom (★)

Press the Custom button to set frequently used features.

## Infotainment System

Front



Second row (If equipped)



### *i* Information

The infotainment system may change after software updates. For more information, refer to the manual provided in the infotainment system and the quick reference guide.

## Voice Recognition



### *i* Information

The infotainment system may change after software updates. For more information, refer to the manual provided in the infotainment system and the quick reference guide.

## Bluetooth® Wireless Technology



- (1) Call / Answer / Call end button
- (2) Microphone

### *i* Information

The infotainment system may change after software updates. For more information, refer to the manual provided in the infotainment system and the quick reference guide.

---

### WARNING

To prevent driver distraction, minimize your use of these features while driving. Distraction may cause a collision, resulting in serious injury or death.

---

## **BANG & OLUFSEN Sound System**

 if equipped

### CAUTION

BANG & OLUFSEN sound system is equipped with door speaker grills made of stainless steel. The grill surface can be heated when the vehicle is exposed to hot weather for a long period of time. Keep away from the speaker grill when it is hot.

---



# 6. Driving Your Vehicle

Before Driving .....	6-5
Before Entering the Vehicle .....	6-5
Before Starting .....	6-5
Engine Start/Stop Button.....	6-6
Engine Start/Stop Button Positions.....	6-7
Starting the Engine .....	6-8
Emergency Starting .....	6-9
Turning Off the Engine .....	6-9
Remote Start.....	6-9
Vehicle Auto-Shut Off .....	6-10
Operating Conditions .....	6-10
Deactivating Conditions.....	6-10
System Operation .....	6-10
Automatic Transmission .....	6-11
Automatic Transmission Operation.....	6-11
Cluster Display Messages.....	6-15
Paddle Shifter (Manual Shift Mode) .....	6-16
Good Driving Practices.....	6-17
Braking System .....	6-18
Power-Assist Brakes .....	6-18
Disc Brakes Wear Indicator .....	6-18
High Performance Brake .....	6-19
Electronic Parking Brake (EPB) .....	6-19
Auto Hold.....	6-22
Anti-Lock Brake System (ABS).....	6-24
Electronic Stability Control (ESC).....	6-25
Vehicle Stability Management (VSM).....	6-27
Hill-Start Assist Control (HAC) .....	6-28
Crosswind Stability Control (CSC).....	6-29
Emergency Stop Signal (ESS).....	6-29
Multi-Collision Brake (MCB).....	6-30
Brake Assistant System (BAS) .....	6-30
Downhill Brake Control (DBC).....	6-31
Good Braking Practices .....	6-33
All Wheel Drive (AWD).....	6-34
All Wheel Drive (AWD) Operation .....	6-35

Emergency Precautions .....	6-37
Electronic Limited Slip Differential .....	6-39
Drive Mode Selection .....	6-39
Warning Messages .....	6-39
Electronic Control Suspension .....	6-40
System Malfunction .....	6-40
Electronically Controlled Suspension With Road Preview .....	6-40
System Malfunction .....	6-41
Limitations of the System .....	6-41
Idle Stop and Go (ISG) .....	6-42
ISG System Operation .....	6-42
ISG System Off .....	6-44
Conditions that Restart the Engine .....	6-44
ISG Malfunction .....	6-45
Calibrating the Battery Sensor .....	6-45
Coasting .....	6-46
Coasting Setting .....	6-46
Coasting Operating Conditions .....	6-46
Coasting Release Conditions .....	6-46
Drive Mode Integrated Control System (AWD) .....	6-47
Drive Mode .....	6-47
Active Air Flap (AAF) .....	6-50
System Malfunction .....	6-50
Road Active Noise Control .....	6-50
System Malfunction .....	6-50
Active Sound Design .....	6-51
Semi Active Engine Mount .....	6-51
Special Driving Conditions .....	6-51
Hazardous Driving Conditions .....	6-51
Rocking the Vehicle .....	6-52
Smooth Cornering .....	6-52
Driving at Night .....	6-52
Driving in the Rain .....	6-53
Driving in Flooded Areas .....	6-53
Highway Driving .....	6-53



# 6. Driving Your Vehicle

Reducing the Risk of a Rollover .....	6-54
Winter Driving .....	6-54
Snow or Icy Conditions.....	6-54
Winter Precautions .....	6-58
Trailer Towing .....	6-60
If You Decide to Pull a Trailer .....	6-60
Trailer Towing Equipment .....	6-63
Driving With a Trailer .....	6-64
Maintenance When Towing a Trailer .....	6-66
Vehicle Load Limit .....	6-66
The Loading Information Label.....	6-67

 **WARNING**

**Carbon monoxide (CO) gas is toxic. Breathing CO may cause unconsciousness and death.**

Engine exhaust contains carbon monoxide that cannot be seen or smelled.

**Do not inhale engine exhaust.**

If at any time you smell engine exhaust inside the vehicle, open the windows immediately. Exposure to CO may cause unconsciousness and death by asphyxiation.

**Make sure the exhaust system does not leak.**

The exhaust system should be checked whenever the vehicle is raised to change the oil or for any other purposes. If you hear a change in the sound of the exhaust or drive over something that strikes the underneath side of the vehicle, have the exhaust system checked as soon as possible by an authorized retailer of Genesis Branded products.

**Do not run the engine in an enclosed area.**

Letting the engine idle in your garage, even with the garage door open, is a hazardous practice. Run the engine only long enough to start the engine and to move the vehicle out of the garage.

**Avoid idling the engine for an extended period of time with people inside the vehicle.**

If it is necessary to idle the engine for a long time with people inside the vehicle, be sure to do so only in an open area with the air intake set at "Fresh" and fan control set to high so fresh air is drawn into the interior.

**Keep the air intakes clear.**

To ensure proper operation of the ventilation system, keep the ventilation air intakes located in front of the windshield clear of snow, ice, leaves, or other obstructions.

**If you must drive with the liftgate open:**

Close all windows.

Open instrument panel air vents.

Set the air intake control at "Fresh", the air flow control at "Floor" or "Face", and the fan control set to high.

---

 **WARNING**

**CALIFORNIA PROPOSITION 65 WARNING**

Engine exhaust and a wide variety of automobile components including components found in the interior furnishings in a vehicle, contain or emit harmful chemicals known to the State of California to cause cancer and birth defects and reproductive harm. In addition, certain fluids contained in vehicles and certain products of components contain or emit chemicals known to the State of California to cause cancer and birth defects or other reproductive harm.

---

## Before Driving

### Before Entering the Vehicle

- Make sure all windows, outside mirror(s), and outside lights are clean and unobstructed.
- Remove frost, snow, or ice from both the front windshield and rear window as well as the front side windows.
- Visually check the tires for uneven wear and damage.
- Check under the vehicle for any sign of leaks.
- Make sure there are no obstacles behind you if you intend to back up.

### Before Starting

- Make sure the hood, the liftgate, and the doors are securely closed and locked.
- Adjust the position of the seat and steering wheel.
- Adjust the inside and side view mirrors.
- Verify all the lights work.
- Fasten your seat belt. Check that all passengers have fastened their seat belts.
- Check the gauges and indicators in the instrument panel and the messages on the instrument display when the Engine Start/Stop button is in the ON position.
- Check that any items you are carrying are stored properly or fastened down securely.

#### WARNING

To reduce the risk of serious injury or death:

- Always wear your seat belt. All passengers must be properly belted whenever the vehicle is moving. For more information, refer to the "Seat Belts" section in chapter 3.

- Always drive defensively. Do not assume that the other drivers are seeing your vehicle. They may not act as you expect. Be prepared to react to avoid a possible collision. Plan your movements anticipating the "worst-case" scenario.
- Stay focused on driving. Driver distraction may cause a collision.
- Leave plenty of space between you and the vehicle in front of you.

#### WARNING

Never drink or take drugs while driving.

Drinking or taking drugs and driving is dangerous and may result in an accident and SERIOUS INJURY or DEATH.

Drunk driving is the number one contributor to the highway death toll each year. Even a small amount of alcohol can affect your reflexes, perceptions, and judgment. Just one drink may reduce your ability to respond to changing conditions and emergencies and your reaction time gets worse with each additional drink.

Driving while under the influence of drugs is as dangerous as or more dangerous than driving under the influence of alcohol.

You are much more likely to have a serious accident if you drink or take drugs while driving. If you are drinking or taking drugs, never drive. Do not ride with a driver who has been drinking or taking drugs. Choose a designated driver or call a taxi.

## Engine Start/Stop Button



Whenever the front door is opened, the Engine Start/Stop button illuminates and goes off 30 seconds after the door is closed.

### WARNING

To turn the vehicle off in an emergency: Press and hold the Engine Start/Stop button for more than two seconds. Or rapidly press and release the Engine Start/Stop button three times (within three seconds).

If the vehicle is still moving, you can restart the vehicle without depressing the brake pedal by pressing the Engine Start/Stop button with the gear in the N (Neutral) position.

### WARNING

- NEVER press the Engine Start/Stop button while the vehicle is moving except in an emergency. This may result in the vehicle turning off and loss of power assist for the steering and brake systems. This may cause loss of directional control and braking function, which could cause a collision.
- Before leaving the driver's seat, always make sure the gear is in the P (Park) position, apply the parking brake, press the Engine Start/Stop button to the OFF position, and take the smart key with you to prevent unintended vehicle movement.
- Never reach through the steering wheel for the Engine Start/Stop button or any other control while the vehicle is moving. The presence of your hand or arm in this area may cause a loss of vehicle control resulting in a collision.

## Engine Start/Stop Button Positions

Button Position	Action	Notes
<b>OFF</b>	To turn off the engine, press the Engine Start/Stop button with the vehicle shifted to P (Park). If the Engine Start/Stop button is pressed with the vehicle shifted to D (Drive), R (Reverse), or N (Neutral), the gear automatically shifts to P (Park). The steering wheel locks to protect the vehicle from theft. (if equipped)	Always stop the vehicle before pressing the Engine Start/Stop button to the OFF position.
<b>ACC</b>	Press the Engine Start/Stop button when the button is in the OFF position without depressing the brake pedal. Some of the electrical accessories are usable. The steering wheel unlocks. (if equipped)	<ul style="list-style-type: none"> <li>• If you leave the Engine Start/Stop button in the ACC position for more than one hour, the battery power turns off automatically to prevent the battery from discharging.</li> <li>• If the steering wheel does not unlock properly, the Engine Start/Stop button does not work. Press the Engine Start/Stop button while turning the steering wheel right and left to release. (if equipped)</li> </ul>
<b>ON</b>	Press the Engine Start/Stop button while it is in the ACC position without depressing the brake pedal. The warning lights can be checked before the engine is started.	Do not leave the Engine Start/Stop button in the ON position when the engine is not running to prevent the battery from discharging.
<b>START</b>	To start the engine, depress the brake pedal and press the Engine Start/ Stop button with the gear shifted to the P (Park) or the N (Neutral) position. For your safety, start the engine with the gear shifted to the P (Park) position.	If you press the Engine Start/Stop button without depressing the brake pedal, the engine does not start and the Engine Start/Stop button changes as follows: <b>OFF &gt; ACC &gt; ON &gt; OFF or ACC</b>

### *i* Information

To prevent vehicle battery discharge, the Engine Start/Stop button changes to the OFF position when the Engine Start/Stop button is in the ACC or ON position with the gear in P (Park) for a certain period of time. When the function operates, the tail lamps will turn off. To use the tail lamps again, turn the headlight switch located on the steering column to the OFF and ON position again.

## Starting the Engine

### WARNING

- Always wear appropriate shoes when operating your vehicle. Unsuitable shoes such as high heels, ski boots, sandals, and flip-flops may interfere with your ability to use the brake and accelerator pedals. Do not drive barefoot.
  - Do not start your vehicle with the accelerator pedal depressed. Place your foot firmly on the brake pedal while starting your vehicle.
  - Wait until the engine is at normal idle before shifting gears and releasing the brake. Your vehicle may move suddenly if your vehicle is shifted while the engine RPM is high. It may cause damage to the transmission system.
- 

### *i* Information

- The vehicle will start by pressing the Engine Start/Stop button, only when the smart key is in the vehicle.
  - The vehicle may not start even if the smart key is in the vehicle but it is not near you (e.g. in the cargo area).
  - When the Engine Start/Stop button is in the ACC or ON position, if any door is open, the system checks for the smart key. When the smart key is not in the vehicle, the  indicator blinks and the warning "**Key not in vehicle**" appears. When all doors are closed, the chime also sounds for a few seconds.
- 

1. Always carry the smart key with you.
2. Make sure the parking brake is applied.
3. Make sure the gear is in P (Park).
4. Depress the brake pedal.
5. Press the Engine Start/Stop button.

### *i* Information

- Do not wait for the engine to warm up or race the engine while the vehicle remains stationary.
  - Start driving at moderate engine speeds. Do not rapidly accelerate and decelerate while driving.
- 

### NOTICE

To prevent damage to the vehicle:

- Do not press the Engine Start/Stop button for more than 10 seconds except when the stop lamp fuse is blown.
  - When the stop lamp fuse is blown, replace the fuse. If you cannot replace the fuse, start the engine by pressing and holding the Engine Start/Stop Button for 10 seconds with the Engine Start/Stop Button in the ACC position.
  - If the engine stalls while the vehicle is moving, shift to N (Neutral) and use the Engine Start/Stop button to attempt to restart the engine.
  - Do not push or tow your vehicle to start the engine.
-

## Emergency Starting



If the smart key battery is weak or the smart key does not work correctly, you can start the vehicle by pressing the Engine Start/Stop button with the smart key in the direction of the picture above.

## Turning Off the Engine

1. Stop the vehicle and depress the brake pedal fully.
2. Make sure the gear is in P (Park).
3. Apply the Electronic Parking Brake (EPB).
4. Press the Engine Start/Stop button to the OFF position.
5. Take the key with you when you leave the vehicle.

## Remote Start



You can start the vehicle using the Remote Start button on the smart key.

To start the vehicle remotely:

1. Press the door lock (🔒) button within 32 feet (10 m) from the vehicle.
2. Press and hold the remote start (🔑) button within 4 seconds.

To turn off the engine:

Press the remote start (🔑) button once.

### *i* Information

- The vehicle does not remotely start if the hood or liftgate is opened.
- The vehicle must be in P (Park).
- The engine turns off if you get in the vehicle without a registered smart key or you do not get in the vehicle within 10 minutes.

## Vehicle Auto-Shut Off

If your vehicle is parked and the engine is left on for a long period of time, the engine will turn off automatically to help reduce fuel consumption and prevent accidents caused by carbon dioxide poisoning.

### Operating Conditions

Vehicle Auto-Shut Off timer operates when all the following conditions are satisfied:

- Vehicle speed is below 1.8 mph (3 km/h), and the gear is shifted to P (Park)
- The brake pedal and accelerator pedal are not depressed
- The driver's seat belt is unfastened
- The passenger seat is empty
- The infotainment system is being updated

### Deactivating Conditions

Vehicle Auto-Shut Off timer turns off when one of the situation occurs:

- Vehicle speed is above 1.8 mph (3 km/h)
- The gear is shifted to R (Reverse), D (Drive) or N (Neutral)
- The brake pedal or accelerator pedal is depressed
- The driver's seat belt is fastened
- A passenger is in the passenger's seat

## System Operation



When all the conditions are satisfied, the Vehicle Auto-Shut Off operates and turns the engine off automatically after 60 minutes.

A timer appears on the cluster display 30 minutes before vehicle shuts off.

### Resetting cluster timer

To reset the cluster timer, do one of following:

- Release the accelerator pedal or brake pedal after Vehicle Auto-Shut Off is complete.
- Press the **OK** button on the steering wheel while the timer appears on the cluster display.

### **WARNING**

Do not leave a passenger or a pet in the vehicle in hot weather since the air conditioning system turns off when the engine is off.



## Automatic Transmission

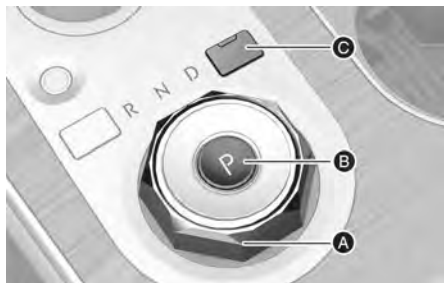

- [A] Rotary shifter (Rotary gear shift dial)  
 [B] P button  
 [C] P-release cap-cover

Depress the brake pedal whenever rotating the shift dial to change gear or shifting to P (Park).

### Automatic Transmission Operation

The automatic transmission has eight forward speeds and one reverse speed.

The individual speeds are selected automatically in the D (Drive) position.

The indicator on the instrument cluster displays the shift dial/button position when the Engine Start/Stop button is in the ON position.

#### WARNING

To reduce the risk of serious injury or death:

- Always check the surrounding areas near your vehicle for people, especially children, before shifting into D (Drive) or R (Reverse).
- Before leaving the driver's seat, always make sure the vehicle is shifted to the P (Park) position, then apply the parking brake, and press the Engine Start/Stop button to the OFF position. Unexpected and sudden vehicle movement may occur if these precautions are not followed.

- Do not use engine braking (using the paddle shifters to shift from a higher gear to a lower gear) on slippery roads. The vehicle may lose traction with the roadway, resulting in a collision.

### Rotary shifter/Rotary gear shift dial

#### P (Park)

Always come to a complete stop before shifting into P (Park).



To shift the gear to P (Park), press the **P** button while depressing the brake pedal. If you turn the engine off in R (Reverse), N (Neutral) or D (Drive), the gear shifts to P (Park).

#### WARNING

- Shifting into P (Park) while the vehicle is moving may cause you to lose control of the vehicle.
- When parking on an incline, shift the gear to P (Park) and apply the parking brake, and turn the wheels toward the curb to prevent the vehicle from rolling downhill.
- Do not use the P (Park) position instead of the parking brake.

### Automatic gear shift to P (Park)

The gear is shifted to P (Park) automatically for safety reasons under the following conditions:

- When the engine is turned off with the gear in R (Reverse), D (Drive), or N (Neutral).
- When the driver's door is opened with the engine running, the gear in R (Reverse), D (Drive) or N (Neutral), the seat belt unfastened and the vehicle at a standstill.
- When the driver's or front passenger's door is opened with the gear in N (Neutral) and the vehicle is turned off.

In situations in which the gear must be in P (Park), always check if the gear is shifted to P (Park) by checking the cluster.

### R (Reverse)

Use this position to drive the vehicle rearward.



To shift the gear to R (Reverse), rotate the shift dial counterclockwise while depressing the brake pedal.

When the vehicle is stopped in the R (Reverse) or D (Drive), if the driver's door is opened and the driver's seat belt is unfastened, the gear shifts to P (Park) automatically.

If the vehicle is moving in R (Reverse) or D (Drive) and the driver's door is opened and the driver's seat belt is unfastened, the gear may not shift to P (Park) automatically to prevent transmission damage.

### NOTICE

Always come to a complete stop before shifting into or out of R (Reverse) to prevent damaging the transmission.

### N (Neutral)

The wheels and transmission are not engaged.

Use N (Neutral) if you need to restart a stalled engine, or if it is necessary to stop with the engine ON. Shift into P (Park) if you need to leave your vehicle for any reason.



To shift the gear to N (Neutral), rotate the shift dial clockwise from R (Reverse) or counterclockwise from D (Drive) while depressing the brake pedal.

Always depress the brake pedal when you are shifting from N (Neutral) to another gear.

If you turn the engine off in N (Neutral), the gear shifts to P (Park).

If you need to stay in N (Neutral) with the engine off, refer to "To stay in N (Neutral) when vehicle is OFF" in the following page.

## ⚠ WARNING

- Do not shift gears unless your foot is firmly on the brake pedal.
- Do not shift gears with the accelerator pedal depressed. Wait until the engine RPM is normal. The vehicle may suddenly move if you shift gears and release the brake pedal when the RPM is high.

### To stay in N (Neutral) when vehicle is OFF

If you want to stay in N (Neutral) after the engine is OFF (Engine Start/Stop button in the ACC position), do the following.

1. Release the parking brake when the engine is running or the Engine Start/Stop button is in the ON position. If Auto Hold is activated, turn off Auto Hold.
2. Rotate the shift dial to N (neutral) while depressing the brake pedal.
3. Take your foot off the brake pedal. The message, "**Press and hold OK button to stay in Neutral when vehicle is Off**" appears on the cluster display.
4. Press and hold the **OK** button [A] on the steering wheel for more than 1 second.



5. When the message, "**Vehicle will stay in (N). Change gear to cancel**" appears on the cluster display, press the Engine Start/Stop button while depressing the brake pedal.

If you open the driver's or front passenger's door, the gear shifts to P (Park) and the Engine Start/Stop button changes to the OFF position.

## NOTICE

With the gear in N (Neutral) the Engine Start/Stop button will be in the ACC position. In the ACC position, the doors cannot be locked. The battery may discharge if left in the ACC position for a long time.

### D (Drive)

The transmission automatically shifts through an 8-gear sequence, providing the best fuel economy and power.

Shift to D (Drive) while depressing the brake pedal with the engine ON. Then release the brake pedal and depress the accelerator pedal.

For extra power when passing another vehicle or driving uphill, depress the accelerator pedal fully. The transmission automatically downshifts to the next lower gear.



To shift the gear to D (Drive), rotate the shift dial clockwise while depressing the brake pedal.

When the vehicle is stopped in the D (Drive), if you open the driver's door with the seat belt unfastened, the gear shifts to P (Park).

If the vehicle is moving in D (Drive), and the driver's door is opened and the seat belt is unfastened, the gear may not shift to P (Park) automatically to protect the automatic transmission.

### NOTICE

Always come to a complete stop before shifting into D (Drive) to prevent damaging the transmission.

### CAUTION

When you start after stopping on a steep incline, even if the gear is in D (Drive), if the accelerator or brake pedal is not depressed, the vehicle may roll backwards, that may cause an accident.

### ***When the battery is discharged:***

You cannot shift gears, when the battery is discharged.

In an emergency:

1. Connect the jumper cables from another vehicle or from another battery following the "Jump Starting" directions in chapter 8.
2. Release the parking brake with the Engine Start/Stop button in the ON position.
3. Press the Engine Start/Stop button to the OFF position.

4. Remove the cap-cover (1) and press and hold the button (2) while depressing the brake pedal.



- The gear changes to the N (Neutral) position.
- The button (2) must be pressed within 3 minutes after the engine is turned off.
- The gear can be changed between P (Park) and N (Neutral) for 20 seconds.

### *i* Information

In situations when the gear needs to be shifted from P (Park) to N (Neutral) when the Engine Start/Stop button is in the OFF position, refer to step 4.

### ***Shift-lock system***

For your safety, the automatic transmission has a shift-lock system that prevents the transmission from shifting from P (Park) or N (Neutral) into R (Reverse) or D (Drive) unless the brake pedal is depressed.

To shift from P (Park) or N (Neutral) into R (Reverse) or D (Drive):

1. Depress and hold the brake pedal.
2. Start the engine.
3. Depress the brake pedal and put the gear in R (Reverse) or D (Drive).

### ***Parking***

Always come to a complete stop and continue to depress the brake pedal. Shift the gear to P (Park), apply the parking brake, and press the Engine Start/Stop button to the OFF position. Take the key with you when leaving the vehicle.

#### **WARNING**

- When you stay in the vehicle with the engine running, be careful not to depress the accelerator pedal for a long time. The engine or exhaust system may overheat and start a fire.
- The exhaust gas and the exhaust system are very hot and may cause burns. Keep away from the exhaust system components.
- Do not stop or park over flammable materials, such as dry grass, paper, or leaves. They may ignite and cause a fire.

## **Cluster Display Messages**

### ***Press brake pedal to change gear***

This message appears when the brake pedal is not depressed while shifting out of gear.

Depress the brake pedal and then shift the gear.

### ***Shift to P after stopping***

This message appears when the gear is shifted to P (Park) while the vehicle is moving.

Stop the vehicle before shifting to P (Park).

### ***Shifting conditions not met***

This message appears when engine RPM is too high, or when driving speed is too fast to shift the gear.

Decrease vehicle speed or slow down before shifting the gear.

### ***Shifter system malfunction***

This message appears when the transmission or the shift button does not properly operate in the P (Park) position.

Immediately have your vehicle inspected by an authorized retailer of Genesis Branded products.

### ***Check shifter dial***

This message appears when there is a malfunction with the shift dial.

Immediately have your vehicle inspected by an authorized retailer of Genesis Branded products.

### ***Check P button***

This message appears when there is a problem with the P button.

Immediately have your vehicle inspected by an authorized retailer of Genesis Branded products.

### ***Rotary shifter stuck***

This message appears when the shift dial does not return back to its normal position after rotating it.

Immediately have your vehicle inspected by an authorized retailer of Genesis Branded products.

### **Transmission overheated warning**

#### **Transmission Hot Park with engine on**

Repeated sudden acceleration and quick start may overheat the transmission. If the transmission is overheated, the self protection mode warns the driver with an audible sound and warning message.

- Move the vehicle to a safe location and shift the gear to P (Park), and stop the vehicle with the engine on. Wait until the transmission is sufficiently cooled down.

#### **Vehicle Power limited due to high transmission temperature**

If you continue to drive with overheated transmission, the above warning message appears and the self-protection mode restricts the power output of the vehicle.

- Move the vehicle to a safe location and shift the gear to P (Park), and stop the vehicle with the engine on. Wait until the transmission is sufficiently cooled down.
- If the above message is continuously displayed, contact an authorized retailer of Genesis Branded products.

#### **Transmission cooled and safe to drive**

This message appears when the vehicle is safe to drive.

### **Paddle Shifter (Manual Shift Mode)**

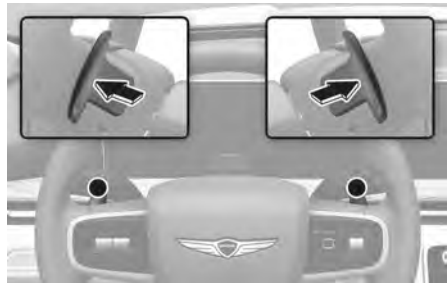

The paddle shifter is available when the shift gear is in the D (Drive) position.

#### **With the shift gear in the D position:**

Pull the **+** or **-** paddle shifter once to shift up or down one gear and the system changes from automatic mode to manual shift mode.

To change back to automatic shift mode from manual shift mode, do one of the followings:

- Pull the **+** paddle shifter for more than one second.
- Drive the vehicle below 4 mph (7 km/h).
- Gently depress the accelerator pedal for more than 6 seconds.
- Rotate the shift dial to the D (Drive) position.

#### **⚠ WARNING**

Do not use engine braking (using the paddle shifters to shift from a higher gear to a lower gear) on slippery roads. The vehicle may lose traction with the roadway, resulting in a collision.

#### ***i* Information**

If the **+** and **-** paddle shifters are pulled at the same time, gear shift may not occur.

## Good Driving Practices

- Never shift the gear from P (Park) or N (Neutral) to any other gear when the accelerator pedal is depressed.
- Never shift the gear into P (Park) when the vehicle is moving.  
Completely stop before shifting into R (Reverse) or D (Drive).
- Do not shift the gear to N (Neutral) when driving to prevent a loss of engine braking and transmission damage that may cause a collision.
- Never attempt to select a gear that is opposite the direction of the vehicle motion. Check the gear position before driving. Stop the vehicle before shifting to the desired gear. The engine may stop, causing a collision.
- Do not drive with your foot resting on the brake pedal. Even light, but consistent pedal pressure may result in the brakes overheating, brake wear, and possibly even brake failure.
- When driving with shifter paddles, slow down before shifting to a lower gear. The vehicle may not shift to a lower gear if the engine RPMs are outside of the allowable range.
- Always apply the parking brake when leaving the vehicle. Do not depend on placing the transmission in P (Park) to keep the vehicle from moving.
- Exercise extreme caution when driving on a slippery surface. Be especially careful when braking, accelerating, or shifting gears. On a slippery surface, an abrupt change in vehicle speed may cause the drive wheels to lose traction and may cause loss of vehicle control resulting in a collision.
- Optimum vehicle performance and economy is obtained by smoothly depressing and releasing the accelerator pedal.

## WARNING

To reduce the risk of serious injury or death:

- Always wear your seat belt. In a collision, an unbelted occupant is significantly more likely to be seriously injured or killed than a properly belted occupant.
- Avoid high speeds when cornering or turning.
- Do not make quick steering wheel movements, such as sharp lane changes or fast, sharp turns.
- The risk of rollover greatly increases if you lose control of your vehicle at highway speeds.
- Loss of control often occurs if two or more wheels drop off the roadway and the driver over steers to reenter the roadway.
- In the event your vehicle leaves the roadway, do not steer sharply. Instead, slow down before pulling back into the travel lanes.
- Genesis Branded Vehicle recommends you to follow all posted speed limits.

## NOTICE

Kickdown mechanism

Use the kickdown mechanism for maximum acceleration. Depress the accelerator pedal beyond the pressure point. The automatic transmission will shift to a lower gear depending on the engine speed.

## Braking System

### Power-Assist Brakes

Your vehicle has power-assisted brakes that adjust automatically through normal usage.

If the engine is not running or is turned off while driving, the power assist for the brakes does not work. You can still stop your vehicle by applying greater force to the brake pedal than typical. The stopping distance, however, may be longer than with power brakes.

When the engine is not running, the reserve brake power is partially depleted each time the brake pedal is depressed. Avoid pumping the brake pedal when the power assist has been interrupted.

#### *i* Information

- When the brake pedal is depressed under certain driving conditions or weather conditions, you may temporarily hear a noise. This is normal and does not indicate a problem with your brakes.
  - While driving on a road with deicing chemicals, brake noise or abnormal tire wear may occur due to deicing chemicals. In a safe traffic condition, additionally apply the brakes to remove deicing chemicals on the brake discs and pads.
- 

#### WARNING

Take the following precautions:

- Do not drive with your foot resting on the brake pedal. This creates abnormal high brake temperatures, excessive brake lining, and pad wear, and increased stopping distances.
  - When descending down a long or steep hill, use the paddle shifter to a lower gear to control your speed without using the brake pedal excessively. Applying the brakes continuously can cause the brakes to overheat and may result in a temporary loss of braking performance.
  - Wet brakes may impair the vehicle's ability to safely slow down and the vehicle may also pull to one side when the brakes are applied. Applying the brakes lightly indicates whether they have been affected in this way. Always test your brakes in this fashion after driving through deep water. To dry the brakes, lightly tap the brake pedal to heat up the brakes while maintaining a safe forward speed until the brake performance returns to normal. Avoid driving at high speeds until the brakes function correctly.
- 

### Disc Brakes Wear Indicator

When your brake pads are worn and new pads are required, you may hear a high pitched warning sound from your front or rear brakes. You may hear this sound come and go or it may occur whenever you depress the brake pedal.

#### *i* Information

Always replace both the left and right brake pads on the front and rear axles at the same time.

---



## High Performance Brake

For vehicles equipped with the High Performance Brake (large diameter monoblock brakes with enhanced braking performance), noise such as a squeal, squeak or groan is generated while braking. This is normal and the friction may create circle patterns on the disc surface. This is also a normal condition which does not affect braking performance.

### WARNING

Frequent braking may deform components and wear the disc brake causing vibration when braking. Observe the speed limit to prevent brake damage from excessive braking.

Brake wear, noise, vibration from excessive braking or deformation of the brakes caused by repeatedly braking in high speed, racing on tracks, etc., can be excluded from warranty coverage.

## Electronic Parking Brake (EPB)

### Applying the parking brake



### To apply EPB (Electronic Parking Brake):

1. Depress and hold the brake pedal.
2. Pull up the EPB switch.

Make sure the Parking Brake warning light comes on.

EPB (Electronic Parking Brake) may be automatically applied when:

- Requested by other systems.
- The driver turns the vehicle off while Auto Hold is operating.

### Emergency braking

If there is a problem with the brake pedal while driving, emergency braking is possible by pulling up and holding the EPB switch. Braking is possible only while you are holding the EPB switch. However, braking distance may be longer than normal.

### WARNING

To reduce the risk of serious injury or death, do not operate the EPB while the vehicle is moving except in an emergency situation. It may damage the brake system and cause a collision.

### Information

During emergency braking, the Parking Brake warning light illuminates and you may hear a clicking noise.

### NOTICE

If you notice a noise or burning smell when the EPB is used for emergency braking, have the system inspected by an authorized retailer of Genesis Branded products.

### Releasing the parking brake



#### To release EPB (Electronic Parking Brake):

1. Press the Engine Start/Stop button to the ON or START position.
2. Press the EPB switch while depressing the brake pedal.

Make sure the Parking Brake warning light goes off.

#### To release EPB (Electronic Parking Brake) automatically:

- Gear in P (Park) or in N (Neutral)  
With the engine running, depress the brake pedal and shift out of P (Park) or N (Neutral) to R (Reverse) or D (Drive). Make sure the doors, hood, and liftgate are closed and the seat belt is fastened.

#### *i* Information

- You can engage EPB even though the Engine Stop/Start button is in the OFF position (only if battery power is available), but you cannot release it.
- Depress the brake pedal and release the parking brake manually with the EPB switch before you drive downhill or when backing up the vehicle.

#### NOTICE

- If the Parking Brake warning light is still on even though the EPB has been released, have the system inspected by an authorized retailer of Genesis Branded products.
- Do not drive your vehicle with EPB applied. It may cause excessive brake pad and brake rotor wear.

#### Warning messages

##### To release EPB, fasten seatbelt and close door, hood and trunk/liftgate

If the driver's seat belt is unfastened, or the hood, liftgate, doors are open, and you try to drive with EPB applied, a warning sounds and a message appears.

#### WARNING

To prevent serious injury or death from unintended vehicle movement:

- Always come to a complete stop and continue to depress the brake pedal before parking, shift the gear into P (Park), pull up the EPB switch, and move the Engine Start/Stop button to the OFF position. Take the key with you when leaving the vehicle.
- Never allow anyone who is unfamiliar with the vehicle to touch the EPB switch.
- Only release EPB when you are seated inside the vehicle with your foot firmly on the brake pedal.

#### NOTICE

Driving with the parking brake on may overheat the braking system and cause premature wear or damage to brake parts.

## *i* Information

- A clicking sound may be heard while operating or releasing the EPB. These conditions are normal and indicate that EPB is functioning properly.
- When leaving your keys with a parking attendant or assistant, be sure to inform him/her how to operate the EPB.

### **AUTO HOLD turning Off! Press brake pedal**

When the conversion from Auto Hold to EPB is not working properly, a warning sounds and a message appears.

### **Parking brake automatically engaged**

When EPB is applied while Auto Hold is activated, a warning sounds and a message appears.

### **EPB malfunction**

Electronic Parking Brake (EPB) warning light illuminates if the Engine Start/Stop button is pressed to the ON position and goes off in about 3 seconds if the system is operating normally.

If the EPB warning light remains on, comes on while driving, or does not come on when the Engine Start/Stop button is pressed to the ON position, the EPB may have malfunctioned.

If this occurs, have the system inspected by an authorized retailer of Genesis Branded products.

The EPB warning light may illuminate when the ESC indicator light comes on to indicate that ESC is not working properly, but it does not indicate a malfunction of EPB.

## **NOTICE**

- If the Parking Brake warning light does not illuminate or blinks after the EPB switch has been pulled, the EPB may not be applied.
- If the EPB warning light is still on or the Parking Brake warning light blinks when the EPB warning light is on, press the switch, and then pull it up. Repeat this one more time. If the EPB warning does not go off, have your vehicle towed on a flatbed tow truck to an authorized retailer of Genesis Branded products.

### **Parking brake warning light**



This light illuminates when the parking brake is applied with the Engine Stop/Start button in the START or ON position.

Before driving, make sure the parking brake is released and the Parking Brake warning light is OFF.

If the Parking Brake warning light remains on after the parking brake is released while the engine is running, there may be a malfunction in the brake system.

If possible, stop driving the vehicle immediately. If that is not possible, use extreme caution while operating the vehicle and only continue to drive the vehicle until you can reach a safe location.

### **When the EPB (Electronic Parking Brake) does not release**

If the EPB does not release normally, contact an authorized retailer of Genesis Branded products by loading the vehicle on a flatbed tow truck and have the system checked.

## **Auto Hold**

Auto Hold maintains the vehicle in a standstill even though the brake pedal is not depressed after the driver brings the vehicle to a complete stop by depressing the brake pedal.

### **To apply:**



1. With the driver's door, hood, and liftgate closed depress the brake pedal and then press the **AUTO HOLD** switch. The white AUTO HOLD indicator comes on and the system is in standby.

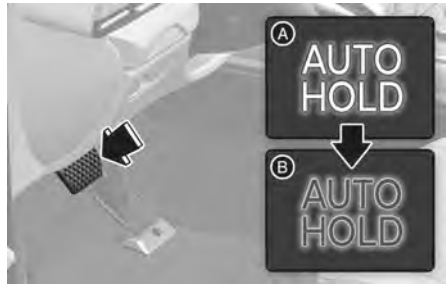

[A] White  
[B] Green

2. When you stop the vehicle completely by depressing the brake pedal, Auto Hold maintains the brake pressure to hold the vehicle stationary. The indicator changes from white to green. The vehicle remains stationary even if you release the brake pedal.

### **To release:**

- If you depress the accelerator pedal with the gear in D (Drive), R (Reverse), or Manual shift mode, the Auto Hold is released automatically and the vehicle starts to move. The AUTO HOLD indicator changes from green to white.

### **⚠ WARNING**

Always look around your vehicle before depressing the accelerator pedal to release Auto Hold.

**To cancel:**

1. Depress and hold the brake pedal.
  2. Press the **AUTO HOLD** switch.
- The **AUTO HOLD** indicator will turn off.

### **WARNING**

To prevent unintended vehicle movement, always depress your foot on the brake pedal to cancel the Auto Hold before you:

- Drive downhill.
- Drive the vehicle in R (Reverse).
- Park the vehicle.

### **Information**

- The Auto Hold does not operate when:
  - The driver's door or hood is opened.
  - The liftgate is opened.
  - The gear is in P (Park).
  - EPB is applied.
- The Auto Hold automatically switches to EPB when:
  - The driver's door or hood is opened.
  - The vehicle is in a standstill for more than 10 minutes.
  - The vehicle is standing on a steep slope.
  - The vehicle moved several times.
  - The liftgate is opened.

In these cases, the Parking Brake warning light comes on, the **AUTO HOLD** indicator changes from green to white, and a warning sounds and a message appears to inform you that EPB has been automatically engaged. Before driving, depress the brake pedal, check the surrounding area, and release the parking brake manually with the EPB switch.

- While operating Auto Hold, you may hear mechanical noise. However, it is normal operating noise.

### **NOTICE**

If the **AUTO HOLD** indicator changes to yellow, or the driver's door, hood, or liftgate open detection system malfunctions, Auto Hold does not work properly. Contact an authorized retailer of Genesis Branded products.

### **Warning messages**

#### **Parking brake automatically engaged**

When EPB is applied while Auto Hold is activated, a warning sounds and a message appears.

#### **AUTO HOLD turning Off! Press brake pedal**

When the conversion from Auto Hold to EPB is not working properly a warning sounds and a message appears.

When this message is displayed, Auto Hold and EPB may not operate. For your safety, depress the brake pedal.

#### **Press brake pedal to deactivate AUTO HOLD**

If you did not apply the brake pedal when you release Auto Hold by pressing the **AUTO HOLD** switch, a warning sounds and a message appears on the cluster display.

### **AUTO HOLD** conditions not met. Close door and hood.

When you press the **AUTO HOLD** switch, if the driver's door and engine hood are not closed, a warning will sound and a message will appear on the cluster display.

Press the **AUTO HOLD** switch after closing the driver's door and hood.

## Anti-Lock Brake System (ABS)

### **WARNING**

Anti-Lock Braking System (ABS) or Electronic Stability Control (ESC) system does not prevent accidents due to improper or dangerous driving maneuvers. Even though vehicle control is improved during emergency braking, always maintain a safe distance between you and objects ahead of you. Vehicle speeds should always be reduced during extreme road conditions. The braking distance for vehicles equipped with ABS or ESC may be longer than for those without these systems in the following road conditions:

Drive your vehicle at reduced speeds during the following conditions:

- Rough, gravel, or snow-covered roads.
- On roads where the road surface is pitted or has different surface height.
- Tire chains are installed on your vehicle.

Never test the safety features of an ABS or ESC equipped vehicle by high speed driving or cornering. It may cause a collision and endanger the safety of yourself or others.

---

ABS is an electronic braking system that helps prevent a braking skid. ABS allows the driver to steer and brake at the same time.

## *Using ABS*

To obtain the maximum benefit from your ABS in an emergency situation, do not attempt to modulate your brake pressure and do not try to pump your brakes. Depress your brake pedal as hard as possible.

When you apply your brakes under conditions that may lock the wheels, you may hear sounds from the brakes, or feel a corresponding sensation in the brake pedal. This is normal and it means your ABS is active.

ABS does not reduce the time or distance to stop the vehicle.

Always maintain a safe distance from the vehicle in front of you.

ABS does not prevent a skid that results from sudden changes in direction, such as trying to take a corner too fast or making a sudden lane change. Always drive at a safe speed for the road and weather conditions.

ABS cannot prevent a loss of stability. Always steer moderately when braking hard. Severe or sharp steering wheel movement can still cause your vehicle to veer into oncoming traffic or off the road.

On loose or uneven road surfaces, operation of the anti-lock brake system may result in a longer stopping distance than for vehicles equipped with a conventional brake system.

The ABS () warning light stays on for several seconds after the Engine Start/Stop button is in the ON position.

During that time, ABS goes through self-diagnosis and the light will go off if everything is normal. If the light stays on, contact an authorized retailer of Genesis Branded products as soon as possible.

**! WARNING**

If the ABS (ABS) warning light is on and stays on, you may have a problem with the ABS. Your power brakes work normally. To reduce the risk of serious injury or death, contact an authorized retailer of Genesis Branded products as soon as possible.

**NOTICE**

When you drive on a road having poor traction, such as an icy road, and apply your brakes continuously, ABS is active continuously and the ABS (ABS) warning light may illuminate. Pull your vehicle over to a safe place and turn off the engine.

Restart the vehicle. If the ABS warning light is off, your ABS system is normal.

If not, contact an authorized retailer of Genesis Branded products as soon as possible.

**i Information**

When you jump start your vehicle because of a drained battery, the ABS (ABS) warning light may turn on at the same time. It does not mean your ABS is malfunctioning. Have the battery recharged before driving the vehicle.

**Electronic Stability Control (ESC)**

Electronic Stability Control helps stabilize the vehicle during cornering maneuvers.

ESC checks where you are steering and where the vehicle is actually going. ESC applies braking pressure to any one of the vehicle's brakes and intervenes in the engine management system to assist the driver with keeping the vehicle on the intended path. It is not a substitute for safe driving practices. Always adjust your speed and driving to the road conditions.

**! WARNING**

Never drive too fast for the road conditions when cornering. ESC does not prevent a collision.

Excessive speed in turns, abrupt maneuvers, and hydroplaning on wet surfaces may result in severe collisions.

## ESC operation

### ESC ON condition

When the Engine Start/Stop button is in the ON position, ESC and the ESC OFF indicator lights illuminate for about three seconds. After both lights go off, ESC is enabled.

### When operating



When ESC is operating, the ESC indicator light blinks:

- When you apply your brakes under conditions that may lock the wheels, you may hear sounds from the brakes, or feel a corresponding sensation in the brake pedal.
- If Cruise Control has been used when ESC activates, Cruise Control automatically disengages. See "Smart Cruise Control (SCC)" section in chapter 7 (if equipped).
- When moving out of the mud or driving on a slippery road, the engine RPM (revolutions per minute) may not increase even if you depress the accelerator pedal all the way. This is to maintain the stability and traction of the vehicle and does not indicate a problem.

### ESC OFF condition



To cancel ESC operation:

- State 1

Press the ESC OFF button briefly. The ESC OFF indicator light and the message,

**"Traction Control disabled"** illuminate.

The traction control function of ESC (engine management) is disabled, but the brake control function of ESC (braking management) still operates.

- State 2

Press and hold the ESC OFF button continuously for more than 3 seconds. The ESC OFF indicator light and the message, **"Traction & Stability Control disabled"** illuminate and a warning chime sounds. In this state, both the traction control function of ESC (engine management) and the brake control function of ESC (braking management) are disabled.

If the Engine Start/Stop button is pressed to the OFF position when ESC is off, ESC remains off. Upon restarting the vehicle, ESC automatically turns on again.

### Indicator lights

ESC indicator light (blinks)



ESC OFF indicator light (comes on)



When the Engine Start/Stop button is pressed to the ON position, the ESC indicator light illuminates, then goes off if the ESC system is operating normally.

The ESC indicator light blinks whenever ESC is operating.

If the ESC indicator light stays on, have your vehicle inspected by an authorized retailer of Genesis Branded products as soon as possible.

The ESC OFF indicator light comes on when ESC is turned off.



**⚠ WARNING**

When ESC is blinking, this indicates ESC is active:

- Drive slowly and NEVER attempt to accelerate.
- Never turn off ESC while the ESC indicator light is blinking. You may lose control of the vehicle and collide.

***i* Information**

Driving with wheels and tires with different sizes may cause the ESC system to malfunction. Before replacing tires, make sure all four tires and wheels are the appropriate size for your vehicle. Never drive the vehicle with different sized wheels and tires installed.

***ESC OFF usage*****When Driving**

The ESC OFF mode should only be used briefly to help free the vehicle if stuck in snow or mud, by temporarily stopping operation of ESC, to maintain wheel torque.

To turn off ESC while driving, press the ESC OFF button while driving on a flat road surface.

**NOTICE**

To prevent damage to the transmission:

- Do not allow wheel(s) of one axle to spin excessively while the ESC, ABS, and Parking Brake warning lights appear. The repairs would not be covered by the vehicle warranty. Reduce engine power and do not spin the wheel(s) excessively while these lights appear.
- When operating the vehicle on a dynamometer, make sure ESC is turned off (ESC OFF light illuminated).

***i* Information**

Turning off ESC does not affect ABS or standard brake system operation.

**Vehicle Stability Management (VSM)**

Vehicle Stability Management is a function of the Electronic Stability Control (ESC) system. It helps the vehicle stay stable when accelerating or braking suddenly on wet, slippery, and rough roads where traction over the four tires can suddenly become uneven.

**⚠ WARNING**

VSM is not a substitute for safe driving practices. To prevent serious injury or death:

- Always monitor the speed and the distance to the vehicle ahead of you.
- Never drive too fast for the road conditions. Excessive speed in bad weather or on slippery and uneven roads may result in severe collisions.

## VSM operation

### When operating

When you apply your brakes under conditions that can activate ESC, you may hear sounds from the brakes, or feel a corresponding sensation in the brake pedal. This is normal and it means your VSM is active.

### *i* Information

VSM does not operate when:

- Driving on a banked road such as gradient or incline.
- Driving in reverse.
- The ESC OFF indicator light is on.
- The MDPS (Motor Driven Power Steering) (⚠) warning light is on or blinks.

### VSM OFF condition

To cancel VSM operation, press the ESC OFF button. ESC OFF (⚠) indicator light illuminates.

To turn on VSM again, press the ESC OFF button again. The ESC OFF indicator light goes out.

### WARNING

If the ESC (⚠) indicator light or MDPS (⚠) warning light stays illuminated or blinks, your vehicle may have a malfunction with the VSM system. Have your vehicle inspected by an authorized retailer of Genesis Branded products as soon as possible.

---

### NOTICE

Driving with wheels and tires with different sizes may cause the VSM system to malfunction. Before replacing tires, make sure all four tires and wheels are the same size. Never drive the vehicle with different sized tires and wheels installed.

---

## Hill-Start Assist Control (HAC)

Hill-Start Assist Control helps prevent the vehicle from rolling backwards when starting from a stop on a hill.

### WARNING

Always be ready to depress the accelerator pedal when starting from a stop on an uphill slope. Hill-Start Assist Control activates only for about 5 seconds.

---

### *i* Information

- Hill-Start Assist Control does not operate when the gear is shifted to P (Park) or N (Neutral).
  - Hill-Start Assist Control activates even when the ESC (Electronic Stability Control) is off. It does not activate, if the ESC is not operating normally.
-

## Crosswind Stability Control (CSC)

 if equipped

Crosswind Stability Control (CSC) works with Electronic Stability Control (ESC) and Motor Driven Power Steering (MDPS) to stabilize the vehicle when it is being shaken or pushed outward due to strong crosswind.

### CSC system operation

- When driving over a bridge or next to a large truck or bus, strong crosswinds may cause the vehicle to shake or pushed outward. The CSC automatically adjusts the vehicle posture and steering wheel to correct the course of the vehicle.
- When activated, the ESC () indicator light illuminates and warning message appears on the instrument cluster with a warning sound.
- When activated, the driver may feel a slight vibration of the vehicle and awkwardness of the steering wheel, due to the braking and MDPS.



### CSC system off

Crosswind Stability Control may not operate, or may cancel its operation in the following conditions when:

- Vehicle speed is about below 45 mph (70 km/h) or about above 112 mph (180 km/h).
- You make sharp turns.
- You depress the brake pedal past a certain level.
- You are driving on a bumpy or slippery road.
- ESC Off () indicator illuminates by turning off the ESC (ESC OFF state 2).
- ESC is activated.
- The Driving Assistance System (FCA, BCA, LKA, LFA, etc.) are activated.

### CSC malfunction

When there is a problem with the ESC or MDPS, CSC does not operate.

- If the ESC () or MDPS () warning light stays illuminated or blinks, have your vehicle to inspected by an authorized retailer of Genesis Branded products.

### WARNING

Crosswind Stability Control is only a supplementary system to assist the driver. The driver should be responsible for the control of the vehicle.

Always hold the steering wheel while driving and depress the brake pedal to reduce speed if necessary.

## Emergency Stop Signal (ESS)

 if equipped

Emergency Stop Signal alerts the driver behind by blinking the stop lights, while sharply and severely braking.

The system is activated when:

- The vehicle suddenly stops. (The deceleration power exceeds  $7 \text{ m/s}^2$ , and the driving speed exceeds 34 mph (55 km/h).)
- ABS is activated.

The hazard warning flasher automatically turns ON after blinking the stop lights when:

- The vehicle speed is below 25 mph (40 km/h),
- ABS is deactivated, and
- The sudden braking situation is over.

The hazard warning flasher turns OFF when:

- The vehicle drives at a low speed for a certain period of time.

The driver manually turns OFF the hazard warning flasher by pressing the button.

## **i** Information

Emergency Stop Signal does not activate, when the hazard warning flashers are already on.

---

## Multi-Collision Brake (MCB)

 if equipped

Multi-Collision Brake controls the brake automatically in the event of an accident where the airbag deploys to reduce the risk of additional accidents that may occur.

### System operation

- From the time the airbag deploys, Multi-Collision Brake monitors the depression intensity of the brake pedal and accelerator pedal for a short period. The system operates when the following conditions are met:
  - Vehicle speed is under 112 mph (180 km/h) at the time of collision.
  - The brake pedal and accelerator pedal are hardly depressed.
- When the driver steps on the brake pedal over a certain level while Multi-Collision Brake is active, the braking power takes priority over automatic braking by Multi-Collision Brake system. However, if the driver takes his/her foot off the brake pedal, the Multi-Collision Brake system will maintain automatic braking.

### System off

Multi-Collision Brake is cancelled in the following situations:

- The accelerator pedal is depressed over a certain level.
- The vehicle stops.
- ESC (Electronic Stability Control) or electronic devices has malfunctioned.

- In a situation system cannot operate normally.
- Ten seconds have passed since the brake has been controlled automatically by Multi-Collision Brake system.

## WARNING

- Multi-Collision Brake decreases vehicle speed after a collision and reduces the risk of a second collision, but it does not prevent a second collision. You may drive away from the collision spot to avoid other dangerous situations by depressing the accelerator pedal.
  - After the vehicle is stopped by Multi Collision Brake, the system stops controlling the brakes. Depending on the situation, the driver should depress the brake or the accelerator pedal to prevent further accidents.
- 

## Brake Assistant System (BAS)

The Brake Assistant System provides additional pressure when the brake pedal is momentarily and strongly depressed in a situation sudden braking is required while driving.

The Brake Assistant System reduces the time for ABS (Anti-Lock Brake System) control to enter and consequently reduces the braking distance, by providing additional pressure up to the point of ABS intervention.

## WARNING

The system may not operate depending on the driver's driving habits, vehicle speed, the degree to which the brake pedal is depressed and the road surface condition.

---

## Downhill Brake Control (DBC)

 if equipped







Downhill Brake Control assists when descending down a steep hill without having to depress the brake pedal.

The system automatically applies the brakes to maintain vehicle speed below a certain speed and allows the driver to concentrate on steering the vehicle down hill.

The system is turned off whenever the engine is turned off.

Press the button to turn on the system and press the button again to turn it off.

**System operation**

Mode	Indicator	Description
Standby	 Green light on	Press the Downhill Brake Control button when vehicle speed is below 37 mph (60 km/h). Downhill Brake Control turns on and enter the standby mode. The system does not turn on if vehicle speed is over 37 mph (60 km/h).
Activated	 Green light blink	In the standby mode, Downhill Brake Control activates under the following conditions: <ul style="list-style-type: none"> <li>• The hill is steep enough.</li> <li>• The brake pedal or accelerator pedal is not depressed.</li> <li>• Vehicle speed is within 2-25 mph (3-40 km/h) range. Within the activation speed range 2-25 mph (3-40 km/h), the driver can control the vehicle speed by depressing the brake pedal or accelerator pedal.</li> </ul>
Deactivated	 Green light off	Downhill Brake Control turns off under the following conditions: <ul style="list-style-type: none"> <li>• The Downhill Brake Control button is pressed again.</li> <li>• Vehicle speed is above 37 mph (60 km/h).</li> </ul>
	 Green light on	Downhill Brake Control is deactivated but maintains the standby mode under the following conditions: <ul style="list-style-type: none"> <li>• The hill is not steep enough.</li> <li>• Vehicle speed is between 25-37 mph (40-60 km/h).</li> </ul>
System malfunction	 Yellow light on	The yellow warning light illuminates when the system may have malfunctioned or may not work properly during activation. If this occurs, Downhill Brake Control is deactivated. Contact an authorized retailer of Genesis Branded products as soon as possible.

### Downhill Brake Control disabled. Control vehicle speed (manually)

If Downhill Brake Control is not working properly, this warning message appears on the cluster display and you may hear a warning sound. If this occurs, control the vehicle speed by depressing the brake pedal.

#### WARNING

Always turn off Downhill Brake Control on normal roads. The system might activate inadvertently from the standby mode when driving through speed bumps or making sharp curves.

#### Information

- Downhill Brake Control may not deactivate on steep inclines even though the brake pedal or accelerator pedal is depressed.
- Downhill Brake Control may not always maintain the vehicle speed at a certain level.
- Downhill Brake Control does not operate when:
  - The gear is in P (Park).
  - ESC is activated.
- Noise or vibration may occur from the brakes when Downhill Brake Control is activated.
- The rear stop lights come on when Downhill Brake Control is activated.

## Good Braking Practices

#### WARNING

Whenever leaving the vehicle or parking, always come to a complete stop and continue to depress the brake pedal. Shift the gear to the P (Park) position, apply the parking brake, and press the Engine Start/Stop button to the OFF position.

Vehicles parked with the parking brake not applied or not in P (Park) may roll unintentionally and may cause injury to the driver and others.

Wet brakes can be dangerous! The brakes may get wet if the vehicle is driven through standing water or if it is washed. Your vehicle may not stop quickly if the brakes are wet. Wet brakes may cause the vehicle to pull to one side.

To dry the brakes, apply the brakes lightly until the braking action returns to normal. If the braking action does not return to normal, stop as soon as it is safe to do so and contact an authorized retailer of Genesis Branded products for assistance.

DO NOT drive with your foot resting on the brake pedal. Even light, but constant pedal pressure may result in the brakes overheating, brake wear, and possibly even brake failure.

If a tire goes flat while you are driving, apply the brakes gently and keep the vehicle pointed straight ahead while you are slowing down. When you are moving slowly enough for it to be safe to do so, pull off the road and stop in a safe location.

Keep your foot firmly on the brake pedal when the vehicle is stopped to prevent the vehicle from rolling forward.

## All Wheel Drive (AWD)

All Wheel Drive (AWD) system delivers engine power to front and rear wheels for maximum traction. AWD is useful when extra traction is required on roads such as slippery, muddy, wet, or snow-covered roads.

### **WARNING**

To reduce the risk of serious injury or death:

- Do not drive in conditions that exceed the vehicle's intended design such as challenging off-road conditions.
  - Avoid high speeds when cornering or turning.
  - Do not make quick steering wheel movements, such as sharp lane changes or fast, sharp turns.
  - The risk of a rollover is greatly increased if you lose control of your vehicle at highway speeds.
  - Loss of control often occurs if two or more wheels drop off the roadway and the driver over steers to reenter the roadway.
  - In the event your vehicle leaves the roadway, do not steer sharply. Instead, slow down before pulling back into the travel lanes.
- 

### **NOTICE**

- Do not drive in water if the water level is higher than the bottom of the vehicle.
  - Check your brake condition once you are out of mud or water. Depress the brake pedal several times as you move slowly until you feel normal braking condition return.
  - Shorten your scheduled maintenance interval if you drive in off-road conditions such as sand, mud, or water (refer to the "Scheduled Maintenance Services" section in chapter 9).
  - Always wash your vehicle thoroughly after off-road use, especially the bottom of the vehicle.
  - Make sure that a full time AWD vehicle is towed by a flat-bed tow truck.
-



## All Wheel Drive (AWD) Operation

### Auto AWD mode (Normal driving)

If the AWD system determines there is a need for four wheel drive, the engine's driving power is distributed to all four wheels automatically.

### All Wheel Drive (AWD) selection



Press the **AUTO LOCK** button to change from Auto AWD (AWD indicator light off) mode to AWD Lock mode (AWD indicator light on).

Selected mode	Description
Auto AWD (Normal driving)	<ul style="list-style-type: none"> <li>Auto AWD is used when driving on roads in normal conditions, roads in urban areas, and on highways.</li> <li>Under normal operating conditions, the vehicle operates similar to conventional 2WD vehicles. If the system determines there is a need for four wheel drive, the engine's driving power is distributed to all four wheels automatically.</li> </ul>
AWD LOCK	<ul style="list-style-type: none"> <li>The main goal of AWD Lock mode is to allow a driver to maximize the vehicle's traction under extreme driving conditions such as unpaved off-road, sandy roads, and muddy roads.</li> <li>Press the AWD Lock mode switch again to switch back to Auto AWD.</li> </ul>

### NOTICE

- Be sure to maintain Auto AWD mode when driving on normal roads.
- If you drive with the AWD Lock mode on normal roads or curved roads, it may damage AWD parts and cause vibration and noise. However, vibration and noise are normal conditions that will disappear when Auto AWD mode is selected. Also, when the vehicle is changed from AWD Lock to Auto AWD, a sensation may be felt as driving power is delivered to the rear wheels.

 **WARNING**

If the AWD (AWD) warning light stays on the instrument cluster, your vehicle may have a malfunction with the AWD system. Have your vehicle inspected by an authorized retailer of Genesis Branded products as soon as possible.

---

**For safe AWD operation**

**Before driving**

- Make sure all passengers always wear their seat belts.
- Sit upright and closer to the steering wheel than usual. Adjust the steering wheel to a position comfortable for you to drive.

**Driving on snow-covered or icy roads**

- Start off slowly by applying the accelerator pedal gently.
- Use snow tires or tire chains.
- Keep a sufficient distance between your vehicle and the vehicle in front.
- Use engine braking during deceleration.
- Avoid speeding, rapid acceleration, sudden brake applications, and sharp turns to prevent skids.

**i Information**

- When using snow tires, mount them on all four wheels.
- When using tire chains, install them on the rear tires. However, driving speed must be below 20 mph (30km/h) and minimize the driving distance. High-speed or long-term driving with the chains installed may malfunction or damage the AWD system.

For more information on Snow Tires and Tire Chains, refer to the "Winter Driving" section later in this chapter.

---

**Driving in sand or mud**

- Maintain slow and constant speeds.
- Use tire chains when driving in mud if necessary.
- Keep a distance between your vehicle and the vehicle in front.
- Reduce the vehicle speed and always check the road condition.
- Avoid speeding, rapid acceleration, sudden brake applications, and sharp turns to prevent getting stuck.

**NOTICE**

When the vehicle is stuck in snow, sand, or mud, place a nonslip material under the drive wheels to provide traction OR slowly spin the wheels in forward and reverse causing a rocking motion that may free the vehicle.

Avoid running the engine continuously at high RPM to prevent damage to the AWD system.

---

**Driving up or down hills**

- Driving uphill
  - Before starting off, check if it is possible to drive uphill.
  - Drive as straight as possible.
- Driving downhill
  - Do not change gears while driving downhill. Select a gear before driving downhill.
  - Drive slowly when using engine braking while driving downhill.
  - Drive straight as possible.

**⚠ WARNING**

- Exercise extreme caution driving up or down steep hills. The vehicle may roll over in the grade, terrain, and water/mud conditions.
- Do not drive across the contour of steep hills. A slight change in the wheel angle may destabilize the vehicle. A stable vehicle may lose stability if the vehicle stops its forward motion. Your vehicle may roll over, resulting in a serious injury or death.

**Driving through water**

- Try to avoid driving in deep standing water. It may stall your engine and clog your exhaust pipes.
- If you need to drive in water, stop your vehicle, and drive below 5 mph (8 km/h).
- Do not change gears while driving in water.

**Additional driving conditions**

- Become familiar with the off-road conditions before driving.
- Always pay attention when driving off-road and avoid dangerous areas.
- Drive slowly when driving in heavy wind.
- Reduce vehicle speed when cornering. The center of gravity of AWD vehicles is higher than conventional 2WD vehicles. The vehicle is more likely to roll over if you turn the steering wheel too quickly.
- Always hold the steering wheel firmly when you are driving off-road.

**⚠ WARNING**

Do not grab the inside of the steering wheel when you are driving off-road. You may hurt your arm by a sudden steering maneuver or from steering wheel rebound due to an impact with objects on the ground. You may lose control of the steering wheel that may lead to serious injury or death.

**Emergency Precautions*****Tires***

Do not use tires or wheels with different size and type from the one originally installed on your vehicle. It may affect the safety and performance of your vehicle, which could cause steering failure or rollover causing serious injury.

When replacing the tires, be sure to equip all four tires with the same size, type, tread, brand, and load-carrying capacity. If you equip your vehicle with any tire/wheel combination not recommended by Genesis Branded Vehicle for off- road driving, do not use these tires for highway driving.

In an emergency situation, a compact spare tire (if equipped) or Tire Mobility Kit (if equipped) may be used. But, do not use the compact spare tire continuously. Repair or replace the original tire as soon as possible to avoid failure of the differential or AWD system.

**⚠ WARNING**



Never start or run the engine while an AWD vehicle is raised on a jack. The vehicle may slip or roll off of a jack causing serious injury or death.

**Towing**

AWD vehicles must be towed with a wheel lift and dollies or flatbed equipment with all the wheels off the ground. For more information, refer to the "Towing" section in chapter 8.

**Vehicle inspection**

- If the vehicle needs to be operated on a vehicle lift, do not attempt to stop any of the four wheels from turning. This may damage the AWD system.
- Never apply the parking brake while running the engine on a vehicle lift. This may damage the AWD system.

**Dynamometer testing**

An AWD vehicle must be tested on a special four wheel chassis dynamometer.

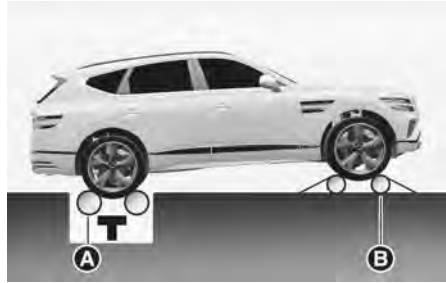

[A] Roll tester (Speedometer),  
[B] Temporary free roller

If a 2WD roll tester must be used:

1. Check the tire pressures recommended for your vehicle.
2. Place the rear wheels on the roll tester for a speedometer test as shown in the illustration.
3. Release the parking brake.
4. Place the front wheels on the temporary free roller as shown in the illustration.

**NOTICE**

- Never engage the parking brake while performing the test.
- When the vehicle is lifted up, do not operate the front and rear wheel separately. All four wheels should be operated.

**⚠ WARNING**

Keep away from the front of the vehicle while the vehicle is in gear on the dynamometer. The vehicle may jump forward and cause serious injury or death.

## Electronic Limited Slip Differential

 if equipped

Electronic Limited Slip Differential controls the differential functions of the wheels to help:

- Improve steering performance when circling at high speed.
- Improve launching performance.
- Prevent slipping on rainy or snowy roads due to dissimilar friction of the left and right wheels.

### WARNING

Never run the wheels with one of the wheels lifted on a jack. It is extremely dangerous for a vehicle equipped with Electronic Limited Slip Differential.

## Drive Mode Selection

The characteristic of Electronic Limited Slip Differential varies according to the drive mode selected.

Selected mode	Characteristic of e-LSD
ECO	COMFORT
COMFORT	COMFORT
SNOW	SNOW
SPORT	COMFORT
SPORT+	COMFORT

For more information, refer to the "Drive Mode Integrated Control System (AWD)" section in this chapter.

## Warning Messages

### *Electronic Limited Slip Differential temporarily disabled due to overheating*

Overheating of related parts will temporarily disable Electronic Limited Slip Differential. Wait until the vehicle cools down.

### *Limited-slip differential disabled. Tire diameter mismatch / Tyre size mismatch. Limited-slip differential disabled. Check tyre sizes*

If your vehicle is equipped with different tires (size, type, etc.), the message appears on the cluster display. To use Electronic Limited Slip Differential, equip the vehicle with the same tires.

### *Check Limited Slip Differential*

When Electronic Limited Slip Differential is not working properly, this warning message appears on the cluster display. If this occurs, have the system inspected by an authorized retailer of Genesis Branded products.

## Electronic Control Suspension

 If equipped

Electronic Control Suspension controls the vehicle suspension automatically using vehicle sensors to maximize driving comfort by taking into account the driving conditions such as speed, surface of the road, cornering, stopping requirements, and acceleration.

### System Malfunction

#### *Check Electronic Suspension*

When Electronic Control Suspension is not working properly, this warning message appears on the cluster display. If this occurs, have the system inspected by an authorized retailer of Genesis Branded products.

## Electronically Controlled Suspension With Road Preview

 If equipped

Electronically Controlled Suspension with Road Preview helps control the vehicle suspension automatically using the front view camera and vehicle sensors to maximize driving comfort by taking into account the driving conditions such as speed, surface of the road, cornering, stopping requirements, and acceleration.

#### *Front view camera*



[A] Front view camera

The front view camera is a sensor that detects the front road. When the front view camera is covered or blocked, its detecting performance is reduced, and the data collected by the camera may be limited.

## NOTICE

To prevent vehicle damage:

- Never disassemble the camera sensors or camera sensor assemblies.
  - Only have the detecting sensor replaced or repaired by an authorized retailer of Genesis Branded products.
  - Never install any accessories, stickers, or tint the front windshield.
  - Always keep the camera dry.
  - Never place any reflective objects (e.g. white paper, mirror) on the dashboard.
- 

## *i* Information

Have the system inspected by an authorized retailer of Genesis Branded products when:

- The windshield glass is replaced.
  - The front view camera or cover gets damaged or replaced.
- 

## System Malfunction

### *Check Electronic Suspension*

When Electronically Controlled Suspension with Road Preview is not working properly, the "**Check Electronic Suspension**" warning message may appear on the cluster display. If this occurs, have the system inspected by an authorized retailer of Genesis Branded products.

## NOTICE

If the battery level is high or low, Electronically Controlled Suspension with Road Preview may not work temporarily to protect the system. If this occurs, "**Check Electronic Suspension**" warning message may appear.

---

## Limitations of the System

Electronically Controlled Suspension with Road Preview always operates while driving according to the vehicle's movement, and the preview function starts to work when the front view camera detects road conditions such as speed bumps. Therefore, the preview function is limited when there is an extreme condition that the front view camera may not work normally. In this case, the electronic control suspension function operates without the preview function in accordance with vehicle movement.

## Idle Stop and Go (ISG)

Idle Stop and Go helps reduce fuel consumption by automatically shutting down the engine, when the vehicle is at a standstill (i.e. red stop light, stop sign, and traffic jam). ISG system is always active, when the engine is running.

### *i* Information

When the engine is automatically started by the ISG system, warning lights (e.g. ABS, ESC, ESC OFF, MDPS, and parking brake warning light) may illuminate for a few seconds if the battery voltage is low and does not indicate a malfunction with the ISG system.

---

## ISG System Operation

### *Prerequisite for activation*

- The driver's seat belt is fastened.
- The driver's door and hood are closed.
- The brake vacuum pressure is adequate.
- The battery sensor is activated and the battery is sufficiently charged.
- Outside temperature is not too low or too high.
- The vehicle is driven over a constant speed and stops.
- The climate control system satisfies the conditions.
- The vehicle is sufficiently warmed up.
- ISG related parts are working properly.
- The incline is gradual.
- The steering wheel is turned less than 180 degrees and then the vehicle stops.

### *i* Information

ISG system is not activated, when the prerequisites to activate the ISG system are unsatisfied.

---

## *Auto stop*

When ISG is on, the engine stops automatically when both of the following occur:

1. Vehicle speed decreases to 0 km/h (0 mph) (full stop condition).
2. Brake pedal is depressed and gear is in D (Drive) or N (Neutral).

The Auto Stop (<sup>A</sup>) indicator light illuminates in green on the instrument cluster, when the engine stops.

### *i* Information

- The gasoline 3.5 turbo 48 V electric supercharger vehicle may automatically stop the engine when the vehicle speed is below 16 mph (25 km/h) with the brake pedal depressed. At this time, the Auto Stop indicator light illuminates in green on the instrument cluster.
  - Idle stop cannot occur again until the vehicle speed goes above 5 mph (8 km/h) and then comes to a full stop again.
-



In the Auto Stop mode, if the hood is opened, ISG system is deactivated.



When the system is deactivated, the ISG OFF (OFF) button indicator illuminates and the message, **"Auto Stop is off. Shift to P or N to start engine manually"** appears on the cluster display with a warning sound.

If this occurs, depress the brake pedal and restart the engine manually.

### Auto start

When ISG stops the engine automatically, the engine restarts if:

- The brake pedal is released.
- You take your foot off the brake pedal and then depress the accelerator pedal when Auto Hold is activated.
- You shift the gear from N (Neutral) or D (Drive) to R (Reverse) or P (Park) while depressing the brake pedal.
- You shift the gear from N (Neutral) to D (Drive) while depressing the brake pedal.

The Auto Stop (A) indicator light illuminates changes to white on the instrument cluster, when the engine is restarted.

### Cluster display messages

**Auto Stop is Off. Shift to P or N and start engine manually.**

When the system is deactivated, the ISG OFF (OFF) button indicator illuminates and a message appears on the cluster display with a warning sound in the following situations.

- The hood is opened.
- ISG system is not working normally.

If this occurs, depress the brake pedal and restart the engine manually. For your safety, restart the vehicle in the P (Park) position.

### Press brake pedal before driving on

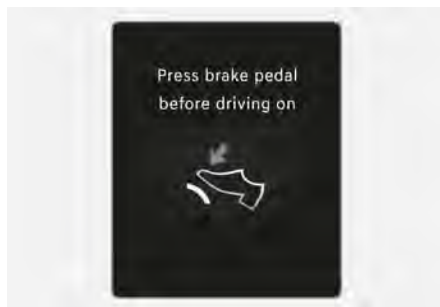

When the gear is shifted from N (Neutral) to R (Reverse), D (Drive) or Manual shift mode without the brake pedal depressed, a message will appear on the cluster display. To activate auto start, depress the brake pedal.

### AUTO STOP elapsed time



AUTO STOP display shows the elapsed time of engine stop by the Idle Stop and Go system.

You may check AUTO STOP elapsed time in the Normal view on the instrument cluster.

Refer to the "View Modes" section in chapter 4.

### ISG System Off



Press the ISG OFF (A) button to turn off the ISG system. The ISG OFF (A) button indicator illuminates. To use the system, press the ISG OFF (A) button again.

### Conditions that Restart the Engine

The engine is automatically restarted in the following situations.

- The brake vacuum pressure is low.
- The engine has stopped for about 5 minutes.
- The air conditioning is ON with the fan speed set to a certain high level.
- The front defroster is ON.
- The battery is weak.
- The cooling and heating performance of the climate control system is unsatisfactory.
- The vehicle is shifted to P (Park) or R (Reverse) when Auto Hold is activated.
- The door is opened or the seat belt is unfastened when Auto Hold is activated.
- The EPB switch is pressed when Auto Hold is activated.

The Auto Stop (A) indicator light blinks in green for 5 seconds on the instrument cluster when the engine is restarted.

### WARNING

When the engine is in Idle Stop mode, the engine may restart without the driver taking any action. Before leaving the vehicle or working on the engine compartment, turn off the engine by pressing the ENGINE Start/Stop button to the OFF position, shifting to P (Park), applying the parking brake, and taking the key with you when you leave the vehicle.

## ISG Malfunction

ISG system may not operate if:

The following will occur, when there is a malfunction with the ISG system:

- The Auto Stop (A) light illuminates in yellow on the instrument cluster.
- The ISG OFF (OFF) button illuminates.

Contact an authorized retailer of Genesis Branded products.

## Calibrating the Battery Sensor

If the AGM battery is reconnected or replaced, the ISG system does not operate immediately. If you want to use the system, the battery sensor needs to be calibrated following the procedure.

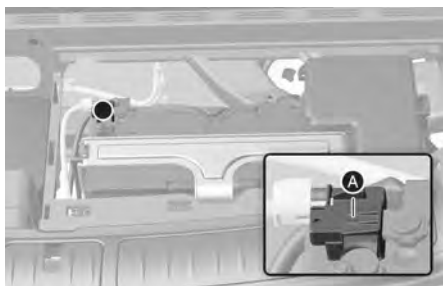

[A] Battery sensor

1. Turn off the engine.
2. Disconnect all electronic devices that were additionally installed after the vehicle was delivered, such as navigation, dashcam, etc.
3. After 4 hours with the engine off, turn the engine on and off 3 to 4 times.

## *i* Information

The ISG system may not operate in the following situations.

- There is a malfunction with the ISG system.
- The battery is weak.
- The brake vacuum pressure is low.

If this occurs, have your vehicle inspected by an authorized retailer of Genesis Branded products.

## NOTICE

- Use only a genuine Genesis AGM battery for replacement. If not, the ISG system may not operate properly.
- Do not recharge the AGM battery with a general battery charger. It may damage or explode the AGM battery.
- Do not remove the battery cap. The battery electrolyte, which is harmful to the human body, may leak out.

## Coasting

 if equipped

When certain conditions are met, the engine is automatically decoupled from the transmission while gear remains in D (Drive). When Coasting is operating, the engine stays at idling speed to reduce fuel consumption and increase coasting distance.

### Coasting Setting

- The Coasting function can be turned ON from the Settings menu in the infotainment system. Select:
  - **Setup > Vehicle > Drive Mode > Coasting**
- When Coasting is turned ON and the conditions are met, the function operates with a "**Coasting**" message illuminated on the instrument cluster.

### *i* Information

The infotainment system may change after software updates. For more information, refer to the manual provided in the infotainment system and the quick reference guide.

---

## Coasting Operating Conditions

The Coasting function operates when the accelerator pedal is depressed and released under the following conditions:

- ECO is selected for driving mode
- ECO or Smart is selected for Powertrain in the CUSTOM menu (if equipped) from the infotainment system. If Smart is selected, driver acceleration should be mild.
- The gear is in D (Drive).
- Smart Cruise Control is OFF.
- The accelerator or brake pedal is not depressed.
- The vehicle speed is within 50-160 km/h (30-100 mph).
- The road gradient is within -5 - +5 %.

### *i* Information

- If the front radar for Smart Cruise Control cannot operate normally, the vehicle-to-vehicle distance and relative speed condition are automatically ignored.
  - The Coasting function works after the engine is turned on, the transmission is warmed up, and the engine sensor self-diagnosis is completed.
  - Depending on the driving situation, Coasting operation may be temporarily delayed even if the above conditions are met.
- 

## Coasting Release Conditions

The Coasting function will be automatically released when the following conditions are met:

- Comfort or Sport is selected for driving mode.
- The driver uses the paddle shifter.
- Smart Cruise Control is activated (Set speed appears on the cluster).

- The vehicle speed is not within the speed range 30-100 mph (50-160 km/h)
- The road gradient is below -5 % or over +5 %.
- If the distance between the vehicle ahead is too close or the relative speed changes momentarily in Smart mode.
- If lane change is predicated in Smart mode (for example, the turn signal is turned ON or a LKA warning appears due to steering wheel control, etc.).

### *i* Information

It is recommended to turn off the Coasting function if you are driving under frequently stop-and-go condition. Change the drive mode to Comfort or Sport or deselect Coasting from the infotainment system.

### NOTICE

- If the accelerator pedal is depressed quickly for accelerating with the Coasting function operating, acceleration may occur after the engagement of the clutch inside the transmission. In turn, the driver may continue to feel the acceleration even after the system is turned off.
- Driving with the Coasting function off may be required in some cases since the engine brake is not applied while the Coasting function is operating.

### WARNING

Do not operate adjust the settings while driving. You may be distracted from the driving task and could crash.

## Drive Mode Integrated Control System (AWD)

The drive mode can be selected according to the driver's preference or road condition.

### Drive Mode

The mode changes whenever the **DRIVE MODE** knob is rotated.



The mode changes, as the following, whenever the **DRIVE MODE** knob is turned to the right or left.

- **ECO > COMFORT > SPORT > SPORT+ (if equipped) > SNOW > MY DRIVE**

### *MY DRIVE mode features*

MY DRIVE mode allows driver to personalize the setting of the powertrain, steering wheel and suspension.

To set MY DRIVE mode, go to **Setup > Vehicle > Drive Mode > MY DRIVE MODE** in the infotainment system.

- Powertrain: ECO/COMFORT/SPORT/SPORT+ (if equipped)/SMART
- Steering: COMFORT/SPORT/SPORT+ (if equipped)
- Suspension: COMFORT/SPORT/SPORT+ (if equipped)
- AWD: COMFORT/SPORT/SPORT+ (if equipped)

## *i* Information

SPORT+ is available when your vehicle is equipped with 3.5 T-GDI (48 V) MHEV.

---

### Setting BRAKE mode

 if equipped

To set the BRAKE mode to adjust brake response, park the vehicle and shift the gear to P (Park). Go to **Setup > Vehicle > Drive Mode > Brakes Mode** in the infotainment system and select a mode.

- COMFORT: Brake response appropriate for comfort driving.
- SPORT: Brake response appropriate for dynamic driving.

## *i* Information

The infotainment system may change after software updates. For more information, refer to the manual provided in the infotainment system and the quick reference guide.

---

## Drive mode features

### ECO mode

ECO mode helps improve fuel economy for eco-friendly driving.

Fuel economy varies according to the driver's driving habit and road condition.

- When ECO mode is selected, the ECO indicator illuminates on the instrument cluster.
- When ECO mode is activated:
  - The acceleration response may be slightly reduced if the accelerator pedal is depressed moderately.
  - The air conditioner performance may be limited.
  - The shift pattern of the transmission may change.
  - Engine noise may be louder at some transmission shifts as downshift requires pressing down more on the accelerator pedal.

### COMFORT mode

COMFORT mode provides smooth driving and comfortable riding.

### SPORT mode / SPORT+ mode

SPORT mode or SPORT+ mode (if equipped) provides sporty but firm riding.

In SPORT mode or SPORT+ mode (if equipped), the fuel economy may decrease.

- When the SPORT mode or SPORT+ mode (if equipped) is selected, the SPORT or SPORT+ indicator illuminates on the instrument cluster.
- The drive mode resets to COMFORT mode when the engine is restarted.
- When the SPORT mode or SPORT+ mode (if equipped) is activated:
  - The engine RPM tends to remain raised over a certain time even after releasing the accelerator pedal.

- Upshifts are delayed when accelerating.

### SMART mode

SMART mode selects the proper driving mode among ECO, COMFORT, SPORT, and SPORT+ by judging the driver's driving habits from the brake pedal depression or the steering wheel operation.

### Various driving situations, which you may encounter in SMART mode

- The driving mode automatically changes to SMART ECO mode after a certain period of time, when you gently depress the accelerator pedal.
- The driving mode automatically changes from SMART ECO mode to SMART COMFORT mode after a certain period of time, when you sharply or repetitively depress the accelerator pedal.
- The driving mode automatically changes to SMART COMFORT mode with the same driving patterns, when the vehicle starts to drive on an upward slope of a certain angle. The driving mode automatically returns to SMART ECO mode, when the vehicle detects a level road.
- The driving mode automatically changes to SMART SPORT mode only in harsh driving conditions. In most driving situations, the driving mode is set to SMART ECO mode or SMART COMFORT mode.
- The driving mode automatically changes to SMART SPORT, when you abruptly accelerate the vehicle or repetitively operate the steering wheel. In this mode, your vehicle drives in a lower gear for abrupt accelerating or decelerating and increases the engine brake performance.

For general description of SMART ECO, SMART COMFORT, and SMART SPORT modes, SMART SPORT+ modes, refer to "Drive mode features".

### SMART mode deactivates automatically

SMART mode may deactivate if:

- The driver manually shifts gears.
- Smart Cruise Control may deactivate the SMART mode. When a higher speed is set by Smart Cruise Control, it starts to control the vehicle speed and deactivates the SMART mode.
- Extremely high/low transmission oil temperatures may temporarily deactivate the SMART mode, because the transmission is outside its normal operating condition.

### *i* Information

- When using the SMART mode, if your acceleration pedal input is gradual, the drive mode maximizes the fuel efficiency.
- When your vehicle is in SMART mode and your driving style is more aggressive so that your acceleration pedal input is more abrupt, the drive mode changes to reflect a more SPORT driving characteristic.

## Active Air Flap (AAF)



The active air flap system controls the air flap below the front bumper to cool vehicle parts and improve fuel efficiency.

### *i* Information

The active air flap system may activate regardless of the vehicle condition (e.g. parked, being driven, etc.).

### System Malfunction

The active air flap system may not operate normally if the air flap is temporarily opened due to external factors or if the controller is covered or blocked by foreign material such as snow, rain, etc.

When the "**Check Active Air Flap system**" warning message appears on the cluster display, stop the vehicle in a safe place and check the status of the air flap.

The system operates normally when the vehicle is started 10 minutes after such foreign material is removed or necessary measures are taken.

If the warning message does not disappear, have the system inspected by an authorized retailer of Genesis Branded products.

### CAUTION

- Regardless of the warning message, if the air flaps are not in the same position, turn off the engine and wait for 10 minutes. Turn on the engine and inspect the air flap.
- The active air flap system is operated by a motor. Do not interfere with the operation or apply excessive force that may cause system failure.

## Road Active Noise Control

 If equipped

Road Active Noise Control helps reduce noise caused while driving.

The system may not operate properly in the following conditions:

- Any of the window is open.
- Any of the door is open.
- The sunroof is open.
- The liftgate is open.
- Vehicle's microphone and speaker is blocked by loads.

### System Malfunction

When Road Active Noise Control is not working properly, the "**Check Road Active Noise Control system**" warning message may appear on the cluster display. If this occurs, have the system inspected by an authorized retailer of Genesis Branded products.



## Active Sound Design

 if equipped

- Active Sound Design is a function that provides enhanced virtual engine sound when the driver is depressing the accelerator pedal.
- You can activate or deactivate the Active Sound Design function from the Settings menu in the infotainment system. Select:
  - **Setup > Vehicle > Active Sound Design > Largest Change/Moderate Change/Smallest Change/off** (or **Enhanced/Normal/Minimized/off**)
  - **Setup > Sound > Active Sound Design > Largest Change/Moderate Change/Smallest Change/off** (or **Enhanced/Normal/Minimized/off**)
- Any unauthorized replacement of the vehicle's speaker and amplifier may cause Active Sound Design to malfunction.

### Information

The infotainment system may change after software updates. For more information, refer to the manual provided in the infotainment system and the quick reference guide.

## Semi Active Engine Mount

 if equipped

If the Semi Active Engine Mount is equipped to improve vehicle's noise and vibration, the solenoid valve of the semi active engine mount makes a clack sound when the vehicle enters or exits a certain mode such as speed or engine RPM. It is not a malfunction but a normal condition.

## Special Driving Conditions

### Hazardous Driving Conditions

When hazardous driving conditions are encountered such as water, snow, ice, mud, and sand:

- Drive cautiously and allow for longer braking distances.
- Avoid abrupt braking or steering.
- If your vehicle is stuck in snow, mud, or sand, use the second gear. Accelerate slowly to avoid unnecessary wheel spin.
- Put sand, rock salt, tire chains, or other non-slip materials under the wheels to provide additional traction if stuck in ice, snow, or mud.

### WARNING

- Downshifting with an automatic transmission while driving on slippery surfaces may cause a collision. The sudden change in tire speed may cause the tires to skid. Be careful when downshifting on slippery surfaces.
- Always check your vehicle for damage and foreign materials after driving. Foreign materials in the wheels or tires can lead to unbalanced tires and cause vehicle vibration.

If you have been driving in hazardous driving conditions, the wheels, tires, brake parts, and axle joints must be checked and cleaned.

## Rocking the Vehicle

If it is necessary to rock the vehicle to free it from snow, sand, or mud, first turn the steering wheel right and left to clear the area around your front wheels. Then, shift back and forth between R (Reverse) and a forward gear.

Try to avoid spinning the wheels, and do not race the engine.

To prevent transmission wear, wait until the wheels stop spinning before shifting gears. Release the accelerator pedal while shifting, and press lightly on the accelerator pedal while the transmission is in gear. Slowly spinning the wheels in forward and reverse directions causes a rocking motion that may free the vehicle.

### **WARNING**

Always turn off the ESC system before rocking the vehicle. If the vehicle is stuck and excessive wheel spin occurs, the temperature in the tires may increase very quickly. If the tires become damaged, a tire blow out or tire explosion may occur - you and others may be injured. Do not attempt this procedure if people or objects are near the vehicle.

If you attempt to free the vehicle, the vehicle may overheat quickly, possibly causing an engine compartment fire or other damage. Try to avoid spinning the wheels as much as possible to prevent overheating of the tires or the engine. **DO NOT** allow the vehicle to spin the wheels above 35 mph (56 km/h).

If you are still stuck after rocking the vehicle a few times, have the vehicle pulled out by a tow vehicle to avoid engine overheating, possible damage to the transmission, and tire damage. Refer to the "Towing" section in chapter 8.

---

## Smooth Cornering

Avoid braking or gear changing in corners, especially when roads are wet. Ideally, cornering should be taken under gentle acceleration.

## Driving at Night

Night driving presents more hazards than driving in the daylight. Here are some important tips to remember:

- Slow down and keep more distance between you and other vehicles, because it may be more difficult to see at night, especially in areas where there are no street lights.
- Adjust your mirrors to reduce the glare from other drivers' headlamps.
- Keep your headlamps clean and properly aimed. Dirty or improperly aimed headlamps can make it much more difficult to see at night.
- Avoid staring directly at the headlamps of oncoming vehicles. You could be temporarily blinded, and it takes several seconds for your eyes to readjust to the darkness.

## Driving in the Rain

Rain and wet roads can make driving dangerous. When driving in the rain or on slick pavement:

- Slow down and allow extra following distance. A heavy rainfall makes it harder to see and increases the distance needed to stop your vehicle.
- Turn OFF your Smart Cruise Control. (if equipped)
- Replace your windshield wiper blades when they show signs of streaking or missing areas on the windshield.
- Make sure your tires have enough tread. If your tires do not have enough tread, making a quick stop on wet pavement may cause a skid and possibly collision. Refer to the "Tire Replacement" section in chapter 9.
- Turn on your headlamps to make it easier for others to see you.
- Driving too fast through large puddles may affect your brakes. If you must go through puddles, try to drive through them slowly.
- If you believe your brakes may be wet, apply them several times while the vehicle is moving slowly.

## Hydroplaning

If the road is wet enough and you are driving fast enough, your vehicle may have little or no contact with the road surface and actually ride on the water. The best advice is SLOW DOWN when the road is wet.

The risk of hydroplaning increases as the depth of tire tread decreases, refer to the "Tire Replacement" section in chapter 9.

## Driving in Flooded Areas

Avoid driving through flooded areas unless you are sure the water is not deeper than the bottom of the wheel hub. If you are not sure, turn around and find a different route.

Drive through any water slowly. Allow adequate stopping distance because the brake performance can be reduced.

After driving through water, dry the brakes by gently applying them several times while the vehicle is moving slowly.

## Highway Driving

### *Tires*

Adjust the tire inflation pressure, as specified. Under-inflation may overheat or damage the tires.

Do not install worn-out or damaged tires, which may reduce traction or fail.

### *i* Information

Never over-inflate your tires above the maximum inflation pressure, as specified on your tires.

### *Fuel, engine coolant and engine oil*

Driving at higher speeds on the highway consumes more fuel and is less efficient than driving at a slower, more moderate speed. Maintain a moderate speed to conserve fuel when driving on the highway.

Check both the engine coolant level and the engine oil before driving.

### *Drive belt*

A loose or damaged drive belt may overheat the engine.

## Reducing the Risk of a Rollover

Your multi-purpose passenger vehicle is defined as a Sports Utility Vehicle (SUV). Some SUVs have higher ground clearance and a narrower track to make them capable of performing in a wide variety of off-road applications. The specific design characteristics give them a higher center of gravity than ordinary vehicles making them more likely to roll over if you make abrupt turns. Utility vehicles have a significantly higher rollover rate than other types of vehicles. Due to this risk, a driver and passengers are strongly recommended to buckle their seat belts. In a rollover crash, an unbelted person is significantly more likely to be seriously injured or killed than a person wearing a seat belt.

There are steps that a driver can make to reduce the risk of a rollover. If possible, avoid sharp turns or abrupt maneuvers, do not load your vehicle with heavy cargo on the roof, and never modify your vehicle in any way.

### WARNING

Some Sports Utility Vehicles (SUVs) can have a significantly higher rollover rate than other types of vehicles. To prevent rollovers or loss of control:

- Take corners at slower speeds than you would with a passenger vehicle.
  - Avoid sharp turns and abrupt maneuvers.
  - Do not modify your vehicle in any way that you would raise the center of gravity.
  - Keep tires properly inflated.
  - Do not carry heavy cargo on the roof.
- 

### WARNING

Fasten your seat belt properly. In a rollover crash, an unbelted person is significantly more likely to be seriously injured or killed than a person wearing a seat belt.

---

## Winter Driving

### Snow or Icy Conditions

You need to keep sufficient distance between your vehicle and the vehicle in front.

Apply the brakes gently. Speeding, rapid acceleration, sudden brake applications, and sharp turns are very hazardous practices. When decelerating, use engine braking to the fullest extent. Sudden brake applications on snowy or icy roads may cause the vehicle to skid.

To drive your vehicle in deep snow, it may be necessary to use snow tires or to install tire chains on your tires.

Always carry emergency equipment. You may want to carry tire chains, tow straps or chains, a flashlight, emergency flares, sand, a shovel, jumper cables, a window scraper, gloves, ground cloth, coveralls, a blanket, etc.

## Snow tires

### WARNING

Snow tires should be equivalent in size and type to the vehicle's standard tires. Otherwise, the safety and handling of your vehicle may be adversely affected.

Use snow tires when road temperature is below 45 °F (7 °C). Refer to the below chart, and mount the recommended snow tire for your vehicle.

Standard tire		Recommended snow tire	
Tire size	Wheel size	Tire size	Wheel size
265/55R19	8.5J X 19	265/55R19	8.5J X 19
		265/50R20	8.5J X 20
		265/40R22	9.5J X 22
265/50R20	8.5J X 20	265/50R20	8.5J X 20
		265/40R22	9.5J X 22
265/40R22	9.5J X 22	265/50R20	8.5J X 20
		265/40R22	9.5J X 22

If you mount snow tires on your vehicle, be sure to use the same inflation pressure as the original tires. Mount snow tires on all four wheels to balance your vehicle's handling in all weather conditions. The traction provided by snow tires on dry roads may not be as high as your vehicle's original equipment tires. Check with the tire dealer for maximum speed recommendations.

## Summer tires

 if equipped

Summer tires are used to maximize the driving performance on dry roads.

If the temperature is below 45 °F (7 °C) or you are driving on snowy or icy roads, the summer tires lose their brake performance and traction as the tire grip weakens significantly.

If the temperature is below 45 °F (7 °C) or you are driving on snowy or icy roads, mount snow tires or all-season tires of the same size with your vehicle's standard tire for safe driving. Both snow and all-season tires have M+S markings.

When using the M+S tires, use tires with the same tread produced by the same manufacturer for safe driving.

When driving with the M+S tires with the lower maximum allowable speed than that of the vehicle's standard summer tire, be careful not to exceed the speed allowed for the M+S tires.

## Tire chains (Wire chain)

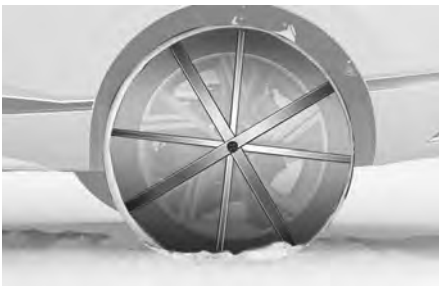

Since the sidewalls of radial tires are thinner than other types of tires, they may be damaged by mounting some types of tire chains on them. Therefore, the use of snow tires is recommended instead of tire chains. If tire chains must be used, use genuine Genesis parts and install the tire chain after reviewing the instructions provided with the tire chains. Damage to your vehicle caused by improper tire chain use is not covered by your vehicle manufacturer's warranty.

## WARNING

The use of tire chains may adversely affect vehicle handling:

- Drive less than 20 mph (30 km/h) or the chain manufacturer's recommended speed limit, whichever is lower.
- Drive carefully and avoid bumps, holes, sharp turns, and other road hazards, which may cause the vehicle to bounce.
- Avoid sharp turns or locked wheel braking.

## Information

- Install tire chains only in pairs and on the rear tires. It should be noted that installing tire chains on the tires will provide a greater driving force, but will not prevent side skids.
- Do not install studded tires without first checking local, state and municipal regulations for possible restrictions against their use.

## Chain installation

When installing tire chains, follow the manufacturer's instructions and mount them as tightly as possible. Drive slowly (less than 20 mph (30 km/h)) with chains installed. If you hear the chains contacting the body or chassis, stop and tighten them. If they still make contact, slow down until the noise stops. Remove the tire chains as soon as you begin driving on cleared roads.

When mounting snow chains, park the vehicle on level ground away from traffic. Turn on the vehicle's Hazard Warning Flasher and place a triangular emergency warning device behind the vehicle (if available).

Always place the vehicle in P (Park), apply the parking brake, and turn off the engine before installing snow chains.

**NOTICE**

When using tire chains:

- Wrong size chains or improperly installed chains may damage your vehicle's brake lines, suspension, body, and wheels.
- Use SAE "S" class or wire chains.
- If you hear noise caused by chains contacting the body, retighten the chains to prevent contact with the vehicle body.
- To prevent body damage, retighten the chains after driving 0.3-0.6 miles (0.5-1.0 km).
- Do not use tire chains on vehicles equipped with aluminum wheels. If possible, use a wire type chain.
- Use wire chains less than 0.47 in. (12 mm) thick to prevent damage to the chain's connection.

**Tire chains (Auto Sock)**

Since the sidewalls on some radial tires are thinner than other types of tires, they may be damaged by mounting certain types of tire chains on them. Therefore, the use of snow tires is recommended instead of tire chains. Do not mount tire chains on vehicles equipped with aluminum wheels; if possible, use AutoSock (fabric snow chain). Install the tire chains after reviewing the instructions provided with the tire chains. Damage to your vehicle caused by improper tire chain use is not covered by your vehicle manufacturer's warranty.

When using tire chains, attach them to the rear wheels.

**! WARNING**

The use of AutoSock (fabric snow chain) may adversely affect vehicle handling:

- Drive less than 20 mph (30 km/h) or the chain manufacturer's recommended speed limit, whichever is lower.
- Drive carefully and avoid bumps, holes, sharp turns, and other road hazards, which may cause the vehicle to bounce.
- Avoid sharp turns or locked wheel braking.
- Install AutoSock (fabric snow chain) only in pairs and on the rear tires. Installing AutoSock (fabric snow chain) on the tires provides a greater driving force, but does not prevent side skids.

## *i* Information

Do not install studded tires without first checking local and municipal regulations for possible restrictions against their use.

---

### Chain installation

When installing AutoSock (fabric snow chain), follow the manufacturer's instructions and mount them as tightly as possible. Drive slowly (less than 20 mph (30 km/h) or the chain manufacturer's recommended speed limit) with chains installed. If you hear the chains contacting the body or chassis, stop and tighten them. If they still make contact, slow down until the noise stops. Remove the AutoSock (fabric snow chain) as soon as you begin driving on cleared roads.

When mounting AutoSock (fabric snow chain), park the vehicle on level ground away from traffic. Turn on the vehicle's Hazard Warning Flasher and place a triangular emergency warning device behind the vehicle (if available).

Always place the vehicle in P (Park), apply the parking brake, and turn off the engine before installing tire chains.

## NOTICE

When using AutoSock (fabric snow chains):

- Wrong size chains or improperly installed chains may damage your vehicle's brake lines, suspension, body, and wheels.
  - Use SAE "S" class or wire chains.
  - If you hear noise caused by chains contacting the body, retighten the chains to prevent contact with the vehicle body.
  - To prevent body damage, retighten the chains after driving 0.3-0.6 miles (0.5-1.0 km).
- 

## Winter Precautions

### *Use high quality ethylene glycol coolant*

Your vehicle is delivered with high quality ethylene glycol coolant in the cooling system. It is the only type of coolant that should be used because it helps prevent corrosion in the cooling system, lubricates the water pump, and prevents freezing. Be sure to replace or replenish your coolant in accordance with the maintenance schedule in chapter 9. Before winter, have your coolant tested to make sure that its freezing point is sufficient for the temperatures anticipated during the winter.

### *Check battery and cables*

Winter temperatures affect battery performance. **Inspect the battery and cables, as specified in chapter 9.** Have the system inspected by an authorized retailer of Genesis Branded products.

### *Change to "winter weight" oil if necessary*

In some regions during winter, it is recommended to use the "winter weight" oil with lower viscosity. In addition, replace the engine oil and filter if it is close to the next maintenance interval. Fresh engine oil ensures optimum engine operation during the winter months. For more information, refer to chapter 2. When you are not sure about a type of winter weight oil, consult an authorized retailer of Genesis Branded products.

### *Check spark plugs and ignition system*

**Inspect the spark plugs, as specified in chapter 9.** If necessary, replace them. Also check all ignition wirings and components for any cracks, wear, and damage.



***To prevent locks from freezing***

Spray approved de-icing fluid or glycerin into key holes. When a lock opening is already covered with ice, spray approved de-icing fluid over the ice to remove it. When an internal part of a lock freezes, try to thaw it with a heated key. Carefully use the heated key to avoid an injury.

***Use approved window washer anti-freeze solution***

Add window washer anti-freeze solution, as specified on the window washer container. The window washer anti-freeze solution is available from an authorized retailer of Genesis Branded products, and most vehicle accessory outlets.

**NOTICE**

Do not use engine coolant or other types of anti-freeze solution, to prevent any damage to the vehicle paint.

***Do not let your parking brake freeze***

Under some conditions, your parking brake may freeze in the engaged position. This is most likely to happen when there is an accumulation of snow or ice around or near the rear brakes or the brakes are wet. When there is the risk that your parking brake may freeze: temporarily apply the parking brake with the gear in P (Park), then block the rear wheels, and then release the parking brake.

***Do not let ice and snow accumulate underneath***

Under some conditions, snow and ice may build up under the fenders and interfere with the steering. When driving in such conditions during the severe winter, you should check underneath the vehicle on a regular basis, to make sure that the front wheels and the steering components is are not blocked.

***Carry emergency equipment***

In accordance with weather conditions, carry appropriate emergency equipment, while driving. Some of the items you may want to carry include tire chains, tow straps or chains, flashlight, emergency flares, sand, shovel, jumper cables, window scraper, gloves, ground cloth, coveralls, blanket, etc.

***Do not place objects or materials in the engine compartment***

Putting objects or materials in the engine compartment may cause an engine failure or a fire, because they may block the engine cooling. Such damage is not be covered by the manufacturer's warranty.

***Drive your vehicle when water vapor condenses and accumulates inside the exhaust pipes***

When the vehicle is stopped for a long time in winter while the engine is running, water vapor may condense and accumulate inside the exhaust pipes. Water in the exhaust pipes may cause noise, etc., but it is drained driving at medium to high speed.

## Trailer Towing

Towing a trailer requires experience. The combination of the vehicle and trailer itself is not as responsive as the vehicle by itself. Towing a trailer also requires additional equipment and adequate planning before a trip. Plan your trip according to the speed limits for towing a trailer that may differ from state to state. Always follow the posted speed limits while towing a trailer.

Remember that driving your vehicle with a trailer is different from normal driving. Driving with a trailer causes changes to acceleration, braking, handling and stability, and fuel economy. For safety of you and passengers, do not overload your vehicle or trailer. Refer to the table in this section for the maximum towing capacity and payload.

This section contains important trailering recommendations and safety rules. Many of these recommendations are important considerations for the safety of you and your passengers. Be sure to read this section carefully and plan ahead before towing a trailer.

### **WARNING**

To prevent serious injury or death:

- If you do not use correct equipment and/or drive improperly, you can lose control of the vehicle when you are pulling a trailer. For example, if the trailer is too heavy, the braking performance may be reduced. Pull a trailer only if you have followed all the steps in this section.
- Before towing, make sure the total trailer weight, GCW (Gross Combination Weight), GVW (Gross Vehicle Weight), GAW (Gross Axle Weight), and trailer tongue load are all within the limits.

- When you tow a trailer, make sure to turn off the Idle Stop and Go system. (if equipped)

### **Information**

- The technically permissible maximum load on the rear axle(s) may be exceeded by not more than 15 % and the technically permissible maximum laden mass of the vehicle may be exceeded by not more than 10 % or 220.4 lbs (100 kg), whichever value is lower. In this case, do not exceed 62.1 mph (100 km/h) for vehicle of category M1 or 49.7 mph (80 km/h) for vehicle of category N1.
  - When a vehicle of category M1 is towing a trailer, the additional load imposed at the trailer coupling device may cause the tire maximum load ratings to be exceeded, but not by more than 15 %. In this case, do not exceed 62.1 mph (100 km/h) and increase the tire inflation pressure by at least 0.2 bar.
- \* M1 : passenger vehicle (9-seater or under)
- \* N1 : commercial vehicle (3.5 ton or under)

## If You Decide to Pull a Trailer

- Consider using a sway control. You can ask a trailer hitch dealer about sway control.
- Genesis Branded Vehicle recommends that you do not tow with your vehicle for the first 1,200 miles (2,000 km) to allow the engine to properly break in.
- Do not exceed 60 mph (100 km/h) or the posted towing speed limit, whichever is lower, when towing a trailer. Always be aware of the posted towing speed limit.

- Trailer instability is more likely to occur when descending steep or long downhill grades. Pay close attention and slow your vehicle speed when descending a long downhill grade. Allow more time and distance for braking and do not brake suddenly. Downshift the transmission to a lower gear to reduce your vehicle speed and also to help prevent brakes from overheating.
- On a long uphill grade, do not exceed 45 mph (70 km/h) the posted towing speed limit, whichever is lower.
- Carefully observe the weight and load limits provided in the following pages.
- When towing a trailer, be sure to consult an authorized retailer of Genesis Branded products for further information on additional requirements such as a towing kit, etc.
- When towing a trailer, be sure to disable Reverse Parking Collision-Avoidance Assist. If towing and going in reverse the system will activate as it detects the trailer. Also, before towing a trailer disable all Driving Assistance systems as precaution such as Forward Collision-Avoidance Assist, Lane Keeping Assist, Smart Cruise Control and others.

### **Towing load limits**

Your vehicle can tow a trailer if you carefully observe the towing load limits, use proper equipment, and follow the towing guidelines. Check the load limits before driving.

### **Total trailer weight**

Do not exceed the maximum allowable weight of the trailer, cargo, and everything in or on it. Refer to the table on the following page for the maximum allowable trailer weight.

### **⚠ WARNING**

Exceeding the load limit or improperly loading your vehicle and trailer can cause a collision, resulting in serious injury or death.

Be sure to check the loading of your vehicle and trailer carefully before driving.

### **Trailer weight**

Tongue Load/Total Trailer Weight

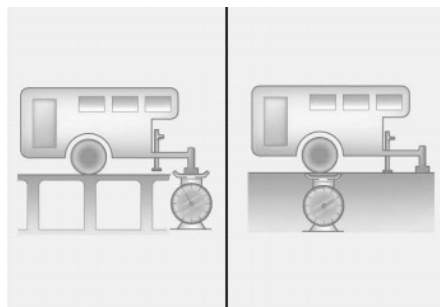

What is the maximum safe weight of a trailer? It should never weigh more than the maximum trailer weight with trailer brakes. But even that can be too heavy. It depends on how you plan to use your trailer. For example, speed, altitude, road grades, outside temperature and how often your vehicle is used to pull a trailer are all important. The ideal trailer weight can also depend on any special equipment that you have on your vehicle.

### Tongue load

Gross Axle Weight/Gross Vehicle Weight

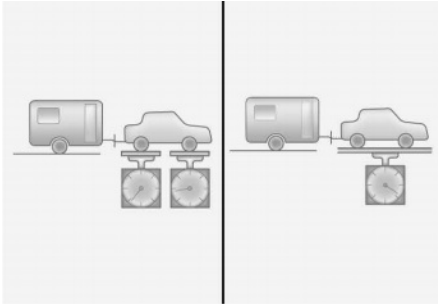

The tongue load is an important weight to measure because it affects the total Gross Vehicle Weight (GVW) of your vehicle. The trailer tongue should weigh a minimum of 10 % of the total loaded trailer weight, within the limits of the maximum (15 %) trailer tongue load permissible.

After you've loaded your trailer, weigh the trailer and then the tongue, separately, to see if the weights are proper. If they aren't, you may be able to correct them simply by moving some items around in the trailer.

#### **WARNING**

Take the following precautions:

- Never load a trailer with more weight in the rear than in the front. The front should be loaded with approximately 60 % of the total trailer load; the rear should be loaded with approximately 40 % of the total trailer load.
- Never exceed the maximum weight limits of the trailer or trailer towing equipment. Improper loading can result in damage to your vehicle and/or personal injury. Check weights and loading at a commercial scale or highway patrol office equipped with scales.

### Reference weight and distance when towing a trailer

The following table indicates the maximum trailer weight for your vehicle. Do not exceed the maximum allowable trailer weight. The maximum trailer weight includes the weight of the trailer, any cargo, and equipment or items attached to the trailer.

The towing load in excess of these limits can seriously affect vehicle steering and performance, and may damage the engine and drivetrain.

Item		With trailer package	Without trailer package
Maximum trailer weight lbs. (kg)	With brake system	6,000 (2,722)	-
Maximum tongue weight *1		600 (272)	-

\*1 Tongue weight should be between allowable 10-15 %

Any additional weight, cargo, or accessories in your vehicle will reduce the maximum trailer weight and corresponding tongue load limits.

#### **WARNING**

Keep flammable materials away from the vehicle's exhaust pipe at all times, especially when using the cargo hitch carrier. Items such as luggage, plastics coolers, camping gear, tarps, and other combustible materials may ignite if placed too close to the hot exhaust pipe, and can cause property damage, injuries, and death.

## Trailer Towing Equipment

### Hitches



It's important to have the correct hitch equipment. Crosswinds, large trucks going by, and rough roads are a few reasons why you'll need the right hitch. Here are some rules to follow:

- Do you have to make any holes in the body of your vehicle when you install a trailer hitch? If you do, then be sure to seal the holes later when you remove the hitch. If you don't seal them, carbon monoxide (CO) from your exhaust can get into your vehicle, as well as dirt and water.
- The bumpers on your vehicle are not intended for hitches. Do not attach rental hitches or other bumper-type hitches to them. Use only a frame-mounted hitch that does not attach to the bumper.
- A Genesis Branded products trailer hitch accessory is available at an authorized distributor of Genesis Branded products.

### Safety chains

You should always attach chains between your vehicle and your trailer.

Instructions about safety chains may be provided by the hitch manufacturer or trailer manufacturer. Follow the manufacturer's recommendation for attaching safety chains. Always leave just enough slack so you can turn with your trailer. And, never allow safety chains to drag on the ground.

### Trailer brakes

If your trailer is equipped with a braking system, make sure it conforms to your country's regulations and that it is properly installed and operating correctly.

If your trailer weighs more than the maximum trailer weight without trailer brakes loaded, then it needs its own braking system. Be sure to read and follow the instructions for the trailer brakes so you can install, adjust, and maintain them properly. Do not modify your vehicle's brake system.

### WARNING

Do not use a trailer with its own brakes unless you are absolutely sure that you have properly set up the braking system. This is not a task for amateurs. Use an experienced, competent trailer shop for this work.

## Driving With a Trailer

Towing a trailer requires a certain amount of experience. Before driving, acquaint yourself with the feel of handling and braking with the added weight of the trailer. And always keep in mind that the vehicle you are driving is now longer and not nearly as responsive as your vehicle is by itself.

Before you start, check the trailer hitch and platform, safety chains, electrical connector(s), lights, tires, and brakes.

During your trip, occasionally check the load is secure, and that the lights and trailer brakes are still working.

### *Following distance*

Stay at least twice as far behind the vehicle ahead as you would when driving your vehicle without a trailer. This can help you avoid situations that require heavy braking and sudden turns.

### *Passing distance*

You need more passing distance when you are towing a trailer. Because of the increased vehicle length, you may need to go much farther beyond the passed vehicle before you can return to your lane.

### *Backing up*

Hold the bottom of the steering wheel with one hand. Then, to move the trailer to the left, move your hand to the left. To move the trailer to the right, move your hand to the right. Always back up slowly and, if possible, have someone guide you.

### *Making turns*

When you are turning with a trailer, make wider turns than normal. Do this so your trailer does not strike soft shoulders, curbs, road signs, trees, or other objects. Avoid jerky or sudden maneuvers. Signal well in advance.

### *Turn signals*

When you tow a trailer, your vehicle has to have a different turn signal flasher and extra wiring. The green arrows on your instrument panel flashes whenever you signal a turn or lane change. Properly connected, the trailer lights will also flash to alert other drivers when you are about to turn, change lanes, or stop.

When towing a trailer, the green arrows on your instrument panel flashes for turns even if the bulbs on the trailer are burned out. Thus, you may think drivers behind you are seeing your signals when, in fact, they are not. It is important to check occasionally to make sure the trailer bulbs are still working. Check the lights every time you disconnect and then reconnect the wires.

### **WARNING**

Do not connect a trailer lighting system directly to your vehicle's lighting system. Use an approved trailer wiring harness. Failure to do so may result in damage to the vehicle electrical system and/or personal injury. Contact an authorized retailer of Genesis Branded products for assistance.

---

### *Driving on hills*

On a long uphill grade, shift down and reduce your vehicle speed to around 70 km/h (45 mph) to reduce the possibility of motor and transmission overheating. If you do not shift down, you might have to use the brakes and your brakes may overheat and may not operate efficiently.

If your trailer weighs more than the maximum trailer weight without trailer brakes and you have an reduction gear, drive in D (Drive) when towing a trailer.

Operating your vehicle in D (Drive) when towing a trailer can minimize heat build-up and extend the life of your transmission.

**NOTICE**

To prevent engine and/or transmission overheating:

- When towing a trailer on steep grades (in excess of 6 %) pay close attention to the engine coolant temperature gauge to make sure the engine does not overheat. If the needle of the coolant temperature gauge moves toward "H" (HOT), pull over and stop as soon as it is safe to do so, and allow the engine to idle until it cools down. You may proceed once the engine has cooled sufficiently.
- If you tow a trailer with the maximum gross vehicle weight and maximum trailer weight, it may cause the engine or transmission to overheat. When driving in such conditions, allow the engine to idle until it cools down. You may proceed once the engine or transmission has cooled sufficiently.
- When towing a trailer, your vehicle speed may be much slower than the general flow of traffic, especially when climbing an uphill grade. Use the right hand lane when towing a trailer on an uphill grade. Choose your vehicle speed according to the maximum posted speed limit for vehicles with trailers, the steepness of the grade, and your trailer weight.

**Parking on hills**

Generally, if you have a trailer attached to your vehicle, do not park your vehicle on a hill.

If you ever have to park your trailer on a hill:

1. Pull the vehicle into the parking space. Turn the steering wheel in the direction of the curb.
2. Shift the gear to P (Park).
3. Apply the parking brake and shut off the vehicle.

4. Place wheel chocks under the trailer wheels on the down hill side of the wheels.
5. Start the vehicle, hold the brakes, shift to neutral, release the parking brake, and slowly release the brakes until the trailer chocks absorb the load.
6. Reapply the brakes and the parking brake.
7. Shift the gear to P (Park) when the vehicle is parked on an uphill grade and in R (Reverse) on a downhill.
8. Shut off the vehicle and release the vehicle brakes but apply the parking brake.

**⚠ WARNING**

To prevent serious injury or death:

- Do not get out of the vehicle without applying the parking brake firmly. If you have left the engine running, the vehicle may move suddenly. You and others may be seriously or fatally injured.
- Do not apply the accelerator pedal to hold the vehicle on an uphill.

***Driving the vehicle after it has been parked on a hill***

1. With the gear in P (Park), apply your brakes and hold the brake pedal down while you:
  - Start your engine.
  - Shift into gear.
  - Release the parking brake.
2. Slowly remove your foot from the brake pedal.
3. Drive slowly until the trailer is clear of the chocks.
4. Stop and have someone pick up and store the chocks.

## Maintenance When Towing a Trailer

Your vehicle needs servicing more often when you regularly pull a trailer. Important items to pay particular attention to include engine oil, transmission fluid, axle lubricant, and cooling system fluid. Brake condition is another important item to frequently check. If you are trailering, it is a good idea to review these items before you start your trip. Do not forget to maintain your trailer and hitch. Follow the maintenance schedule that accompanies your trailer and check it periodically. Preferably, conduct checking at the start of each day's driving. Most importantly, all hitch nuts and bolts must be tight.

### NOTICE

To prevent vehicle damage:

- Due to higher load during trailer use, overheating may occur on hot days or during uphill driving. If the coolant gauge indicates over-heating, switch off the air conditioner and stop the vehicle in a safe area to cool down the engine.
  - Do not switch off the engine while the coolant gauge indicates over-heating. (Keep the engine idle to cool down the engine)
  - When towing, check transmission fluid more frequently.
  - If your vehicle is not equipped with an air conditioner, install a condenser fan to improve the engine performance when towing a trailer.
- 

### WARNING

Keep flammable materials away from the vehicle's exhaust pipe at all times, especially when using the cargo hitch carrier. Items such as luggage, plastics coolers, camping gear, tarps, and other combustible materials may ignite if placed too close to the hot exhaust pipe, and can cause property damage, injuries, and death.

---

## Vehicle Load Limit

Two labels on your driver's door sill show how much weight your vehicle was designed to carry: the Tire and Loading Information Label and the Certification Label.

Before loading your vehicle, familiarize yourself with the following terms for determining your vehicle's weight ratings, from the vehicle's specifications and the Certification Label:

### ***Base curb weight***

This is the weight of the vehicle including a full tank of fuel and all standard equipment. It does not include passengers, cargo, or optional equipment.

### ***Vehicle curb weight***

This is the weight of your new vehicle when you picked it up from your dealer plus any aftermarket equipment.

### ***Cargo weight***

This figure includes all weight added to the Base Curb Weight, including cargo and optional equipment.



**GAW (Gross Axle Weight)**

This is the total weight placed on each axle (front and rear) - including vehicle curb weight and all payload.

**GAWR (Gross Axle Weight Rating)**

This is the maximum allowable weight that can be carried by a single axle (front or rear). These numbers are shown on the Certification Label. The total load on each axle must never exceed its GAWR.

**GVW (Gross Vehicle Weight)**

This is the Base Curb Weight plus actual Cargo Weight plus passengers.

**GVWR (Gross Vehicle Weight Rating)**

This is the maximum allowable weight of the fully loaded vehicle (including all options, equipment, passengers and cargo). The GVWR is shown on the Certification Label located on the driver's door sill.

**The Loading Information Label**

20 inch/Type A

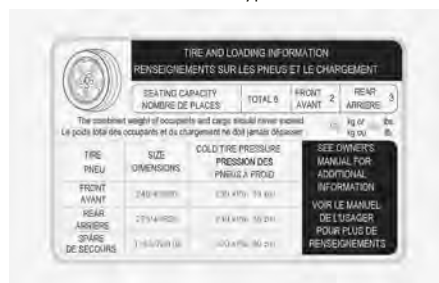

21 inch/Type B



The label located on the driver's door sill gives the original tire size, cold tire pressures recommended for your vehicle, the number of people that can be in your vehicle and vehicle capacity weight.

**Vehicle capacity weight**

1.5 persons: 904 lbs. (410 kg)

2.7 persons: 1128 lbs. (511 kg)

Vehicle capacity weight is the maximum combined weight of occupants and cargo. If your vehicle is equipped with a trailer, the combined weight includes the tongue load.

### **Seating capacity**

1. Total: 5 persons (Front seat: 2 persons, Rear seat: 3 persons)
2. Total: 7 persons (Front seat: 2 persons, Rear seat: 5 persons)

Seating capacity is the maximum number of occupants including a driver, your vehicle may carry.

However, the seating capacity may be reduced based upon the weight of all of the occupants, and the weight of the cargo being carried or towed. Do not overload the vehicle as there is a limit to the total weight, or load limit including occupants and cargo, the vehicle can carry.

### **Towing capacity**

With trailer brakes: 6,000 lbs (2,722 kg)

Towing capacity is the maximum trailer weight including its cargo weight, your vehicle can tow.

### **Cargo capacity**

The cargo capacity of your vehicle will increase or decrease depending on the weight and the number of occupants and the tongue load, if your vehicle is equipped with a trailer.

### **Steps for determining correct load limit**

1. Locate the statement "The combined weight of occupants and cargo should never exceed XXX kg or XXX lbs." on your vehicle's placard.
2. Determine the combined weight of the driver and passengers that will be riding in your vehicle.

3. Subtract the combined weight of the driver and passengers from XXX kg or XXX lbs.

4. The resulting figure equals the available amount of cargo and luggage load capacity. For example, if the "XXX" amount equals 1,400 lbs. and there will be five 150 lb passengers in your vehicle, the amount of available cargo and luggage load capacity is 650 lbs.  $(1,400 - 750 (5 \times 150) = 650 \text{ lbs.})$









5. Determine the combined weight of luggage and cargo being loaded on the vehicle. That weight may not safely exceed the available cargo and luggage load capacity calculated in Step 4.

6. If your vehicle will be towing a trailer, load from your trailer will be transferred to your vehicle. Consult this manual to determine how this reduces the available cargo and luggage load capacity of your vehicle.

### **WARNING**

Do not overload the vehicle as there is a limit to the total weight, or load limit, including occupants and cargo, the vehicle can carry. Overloading can shorten the life of the vehicle. If the GVWR or the GAWR is exceeded, parts on the vehicle can break, and it can change the handling of your vehicle. These could cause you to lose control and result in an accident.

---

<p><b>Example 1</b></p>	<p>  <b>Vehicle Capacity</b>  Maximum Load  (1,400 lbs.)  (635 kg)</p>	<p>≥</p> <p>  <b>Passenger Weight</b>  (150 lbs. × 2 = 300 lbs.)  (68 kg × 2 = 136 kg)</p>	<p>+   <b>Cargo Weight</b>  (1,100 lbs.)  (499 kg)</p>
<p><b>Example 2</b></p>	<p>  <b>Vehicle Capacity</b>  Maximum Load  (1,400 lbs.)  (635 kg)</p>	<p>≥</p> <p>  <b>Passenger Weight</b>  (150 lbs. × 5 = 750 lbs.)  (68 kg × 5 = 340 kg)</p>	<p>+   <b>Cargo Weight</b>  (650 lbs.)  (295 kg)</p>
<p><b>Example 3</b></p>	<p>  <b>Vehicle Capacity</b>  Maximum Load  (1,400 lbs.)  (635 kg)</p>	<p>≥</p> <p>  <b>Passenger Weight</b>  (172 lbs. × 5 = 860 lbs.)  (78 kg × 5 = 390 kg)</p>	<p>+   <b>Cargo Weight</b>  (540 lbs.)  (245 kg)</p>

### Certification label



The certification label is located on the driver's door sill at the center pillar and shows the maximum allowable weight of the fully loaded vehicle. This is called the GVWR (Gross Vehicle Weight Rating). The GVWR includes the weight of the vehicle, all occupants, fuel and cargo. This label also tells you the maximum weight that can be supported by the front and rear axles, called Gross Axle Weight Rating (GAWR).

The total weight of the vehicle, including all occupants, accessories, cargo, and trailer tongue load must not exceed the Gross Vehicle Weight Rating (GVWR) or the Gross Axle Weight Rating (GAWR). To find out the actual loads on your front and rear axles, you need to go to a weigh station and weigh your vehicle. Be sure to spread out your load equally on both sides of the centerline.

### WARNING

#### Overloading

- Never exceed the GVWR for your vehicle, the GAWR for either the front or rear axle and vehicle capacity weight. Exceeding these ratings can affect your vehicle's handling and braking ability, and cause an accident.
- Do not overload your vehicle. Overloading your vehicle can cause heat buildup in your vehicle's tires and possible tire failure, increased stopping distances and poor vehicle handling—all of which may result in a crash.

### NOTICE

Overloading your vehicle may cause damage. Repairs would not be covered by your warranty. Do not overload your vehicle.

### WARNING

If you carry items inside your vehicle (for example, suitcases, tools, packages, or anything else), they are moving as fast as the vehicle. If you have to stop or turn quickly, or if there is a crash, the items will keep going and can cause an injury if they strike the driver or a passenger.

- Put items in the cargo area of your vehicle. Try to spread the weight evenly.
- Do not stack items, like suitcases, inside the vehicle above the tops of the seats.
- Do not leave an unsecured child restraint in your vehicle.
- When you carry something inside the vehicle, secure it.

# 7. Driver Assistance System

Before Using Driver Assistance System .....	7-4
Driver Assistance System Sensors .....	7-5
Forward Collision-Avoidance Assist (FCA) .....	7-7
Forward Collision-Avoidance Assist Settings .....	7-10
Forward Collision-Avoidance Assist Operation .....	7-12
Forward Collision-Avoidance Assist Malfunction And Limitations .....	7-21
Lane Keeping Assist (LKA).....	7-29
Lane Keeping Assist Settings .....	7-29
Lane Keeping Assist Operation .....	7-30
Lane Keeping Assist Malfunction and Limitations .....	7-32
Blind-Spot Collision-Avoidance Assist (BCA) .....	7-34
Blind-Spot Collision-Avoidance Assist Settings .....	7-35
Blind-Spot Collision-Avoidance Assist Operation .....	7-36
Blind-Spot Collision-Avoidance Assist Malfunction And Limitations .....	7-38
Safe Exit Assist (SEA) .....	7-42
Safe Exit Assist Settings.....	7-42
Safe Exit Assist Operation .....	7-44
Safe Exit Assist Malfunction And Limitations.....	7-45
Manual Speed Limit Assist (MSLA).....	7-47
Manual Speed Limit Assist Operation .....	7-47
Intelligent Speed Limit Assist (ISLA) .....	7-49
Intelligent Speed Limit Assist Settings.....	7-49
Intelligent Speed Limit Assist Operation.....	7-50
Intelligent Speed Limit Assist Malfunction And Limitations.....	7-51
Driver Attention Warning (DAW) .....	7-53
Driver Attention Warning Settings.....	7-53
Driver Attention Warning Operation.....	7-54
Driver Attention Warning Malfunction And Limitations.....	7-55
Forward Attention Warning (FAW).....	7-57
Forward Attention Warning Settings.....	7-57
Forward Attention Warning Operation.....	7-58
Forward Attention Warning Malfunction And Limitations.....	7-59
Blind-Spot View Monitor (BVM) .....	7-61
Blind-Spot View Monitor Settings .....	7-61
Blind-Spot View Monitor Operation .....	7-61

Blind-Spot View Monitor Malfunction .....	7-62
Smart Cruise Control (SCC).....	7-62
Smart Cruise Control Settings .....	7-62
Smart Cruise Control Operation .....	7-64
Smart Cruise Control Malfunction And Limitations .....	7-71
Emergency Stop (ES).....	7-76
Emergency Stop Operation .....	7-76
Emergency Stop Malfunction and Limitations.....	7-77
Navigation-based Smart Cruise Control (NSCC).....	7-78
Navigation-based Smart Cruise Control Settings.....	7-78
Navigation-based Smart Cruise Control Operation.....	7-78
Limitations of Navigation-Based Smart Cruise Control .....	7-80
Lane Following Assist (LFA).....	7-83
Lane Following Assist Settings .....	7-83
Lane Following Assist Operation .....	7-83
Lane Following Assist Malfunction And Limitations .....	7-85
Highway Driving Assist (HDA).....	7-86
Highway Driving Assist Settings.....	7-86
Highway Driving Assist Operation .....	7-88
Highway Lane Change Assist .....	7-90
Highway Driving Assist Malfunction And Limitations.....	7-93
Rear View Monitor (RVM).....	7-95
Rear View Monitor Settings .....	7-95
Rear View Monitor Operation .....	7-96
Rear View Monitor Malfunction And Limitations .....	7-97
Surround View Monitor (SVM) .....	7-98
Surround View Monitor Settings .....	7-98
Surround View Monitor Operation .....	7-99
Surround View Monitor Malfunction And Limitations .....	7-102
Rear Cross-Traffic Collision-Avoidance Assist (RCCA) .....	7-103
Rear Cross-Traffic Collision-Avoidance Assist Settings .....	7-103
Rear Cross-Traffic Collision-Avoidance Assist Operation .....	7-104
Rear Cross-Traffic Collision-Avoidance Assist Malfunction And Limitations .....	7-107
Parking Distance Warning (PDW) .....	7-111
Parking Distance Warning Settings.....	7-111

# 7. Driver Assistance System

Parking Distance Warning Operation .....	7-112
Parking Distance Warning Malfunction And Limitations .....	7-114
Forward/Side/Reverse Parking Collision-Avoidance Assist (PCA) .....	7-116
Parking Collision-Avoidance Assist Settings.....	7-116
Parking Collision-Avoidance Assist Operation .....	7-117
Parking Collision-Avoidance Assist Malfunction And Limitations.....	7-118
Remote Smart Parking Assist 2 (RSPA 2) .....	7-121
Remote Smart Parking Assist Settings .....	7-123
Remote Smart Parking Assist Operation .....	7-124
Remote Smart Parking Assist Malfunction And Limitations .....	7-138
Declaration of Conformity .....	7-144
Front Radar .....	7-144
Front Corner Radar (if equipped)/Rear Corner Radar (if equipped) .....	7-145

## Before Using Driver Assistance System

### WARNING

Always maintain a safe distance from the vehicles ahead and adjust your vehicle speed to the road conditions. Driver Assistance system may not operate in all situations and cannot avoid all collisions.

To prevent serious injury or death:

- Control your vehicle at all times. In some cases, the Driver Assistance system may provide unwanted braking or steering.
  - Never attempt to activate any Driver Assistance system by intentionally driving toward people, animals, objects, or other vehicles.
  - The steering, braking, and acceleration inputs from you may override the responses from Driver Assistance system.
  - Do not use Driver Assistance system when towing a trailer or using a hitch mounted carrier.
  - Do not use Driver Assistance system if you believe the sensors or the systems may not be functioning properly.
- 

### WARNING

When the trailer connector is connected, a warning message appears on the cluster, and the driver assistance system listed below stops working. If you disconnect the trailer connector, the functions will work normally again. (if Genesis genuine part equipped)

- Forward/Side Safety of Forward Collision-Avoidance Assist
  - Lane Keeping Assist
  - Blind-Spot Collision-Avoidance Assist
  - Safe Exit Assist
  - Lane Following Assist
  - Highway Driving Assist
  - Rear Cross-Traffic Collision-Avoidance Assist
  - Reverse Parking Distance Warning
  - Parking Collision-Avoidance Assist
  - Remote Smart Parking Assist
- 

### Information

Due to the infotainment software version, the description of each function of the driver assistance system may differ from the owner's manual.

---



## Driver Assistance System Sensors

The Driver Assistance Systems on your vehicle uses cameras and sensors to detect potential hazards in the vicinity of your vehicle.

### Detecting sensors

#### Cameras

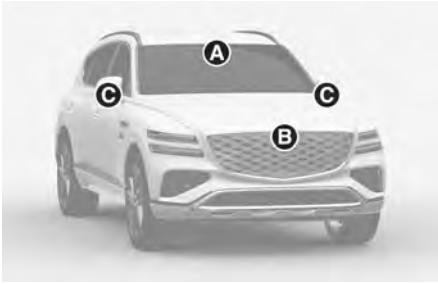

Type A

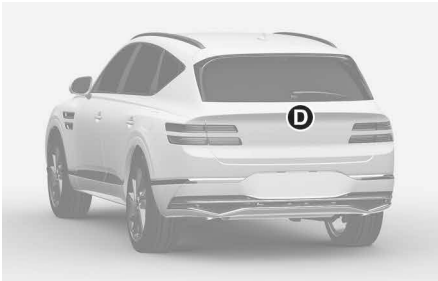

Type B



The actual shape may differ from the illustration.

- [A] Front view camera  
[B] Wide-front view camera (if equipped)

- [C] Wide-side view camera (if equipped)  
[D] Wide-rear view camera

### **⚠ CAUTION**

To prevent serious injury or death:

- Never disassemble the camera sensors or camera sensor assemblies.
- Have the detecting sensor replaced or repaired by an authorized retailer of Genesis Branded products.
- Never install any accessories, stickers, or tint the front windshield.
- Always keep the camera dry.
- Never place any reflective objects (e.g. white paper, mirror) on the dashboard.
- Do not use any cleanser containing acid or alkaline detergents when cleaning the camera lenses. Use only a mild soap or neutral detergent, and rinse thoroughly with water.

## Radars

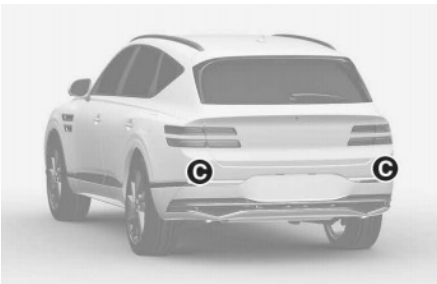
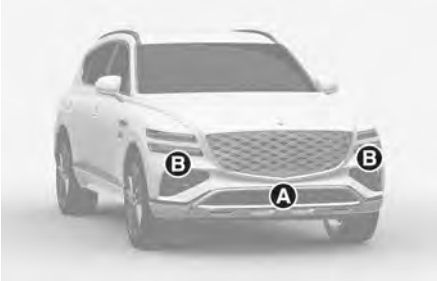

The actual shape may differ from the illustration.

- [A] Front radar
- [B] Front corner radar (if equipped)
- [C] Rear corner radar

### CAUTION

To prevent serious injury or death:

- Never disassemble the radar or radar assembly, and never apply any impact on it.
- If there is impact on or near the radar, the sensors may be damaged or not be properly aligned near the radar, even though a warning message does not appear on the instrument cluster, Driver Assist system may not operate properly. Have your vehicle inspected by an authorized retailer of Genesis Branded products.
- If the radar have been replaced or repaired, have your vehicle inspected by an authorized retailer of Genesis Branded products.

- Use genuine Genesis parts to repair the bumper where the radar is located. Their performance have been proven.
  - Do not install a license plate frame or other objects such as bumper sticker, film, bumper guard, or bumper wrap near the radar.
  - Driver Assistance system may not work properly if the bumper has been replaced, or the surroundings of the radar has been damaged or painted.
  - If a trailer or hitch mounted carrier is attached, it may adversely affect the performance of the rear corner radar or the function may not operate.
-

## Ultrasonic sensors

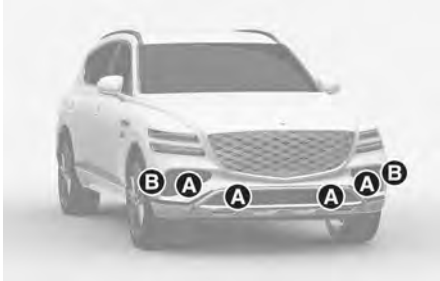

The actual shape may differ from the illustration.

- [A] Front ultrasonic sensors
- [B] Front side ultrasonic sensors (if equipped)
- [C] Rear ultrasonic sensors
- [D] Rear side ultrasonic sensors (if equipped)

### CAUTION

To prevent serious injury or death:

- Always keep the ultrasonic sensors clean.
- Do not spray the ultrasonic sensors or the surrounding area directly with high pressure water.
- Do not apply objects such as bumper sticker or bumper guard, near the ultrasonic sensors or never apply paint to the bumper or other locations.
- Never disassemble or strike the ultrasonic sensors components.
- Do not modify the vehicle bumper height or ultrasonic sensor installations. Any non-factory installed equipment or accessories may also interfere with the sensor performance.

- If the ultrasonic sensors have been forcibly moved out of proper alignment or are damaged, have the vehicle inspected by an authorized retailer of Genesis Branded products.

## Forward Collision-Avoidance Assist (FCA)

### Basic function

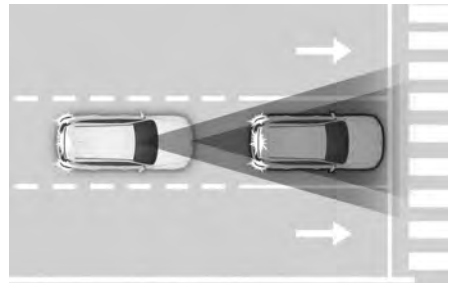

Forward Collision-Avoidance Assist helps detect a vehicle, a powered two-wheeler, a pedestrian, or a cyclist ahead on the road and may warn you of a possible collision with a warning message on the instrument cluster and a warning sound. Also, Forward Collision-Avoidance Assist may assist with braking your vehicle to help reduce collision speed or help avoid a collision.

In addition, when driving at high speeds, Forward Collision-Avoidance Assist helps detect vehicles in front and adjacent lanes. If a collision is imminent when changing lanes, Forward Collision-Avoidance Assist will apply emergency braking to help reduce collision speed or help avoid a collision. (if equipped)

### Junction Turning function



Junction Turning function helps avoid a collision with an oncoming vehicle or powered two-wheeler in an adjacent lane when turning left at a crossroad with the turn signal on by applying emergency braking.

### Direct Oncoming function

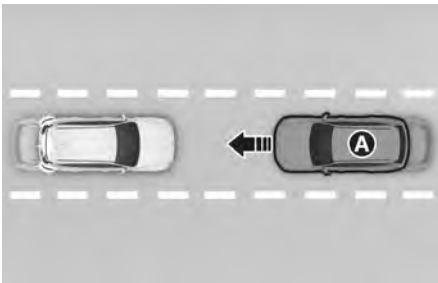

[A] Oncoming vehicle

Direct Oncoming function helps reduce the speed at a collision when a vehicle or powered two-wheeler approaching from the opposite side is detected.

### Junction Crossing function

if equipped



Junction Crossing function helps avoid a collision with oncoming vehicles on the left or right side when crossing an intersection by applying emergency braking.

### Lane-Change Oncoming function

if equipped

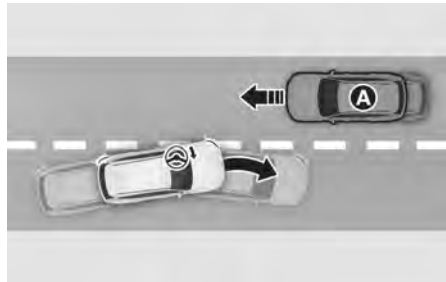

[A] Oncoming vehicle

Lane-Change Oncoming function helps avoid a collision with an oncoming vehicle or powered two-wheeler when changing lanes by assisting the driver's steering.

## Lane-Change Side function

 if equipped

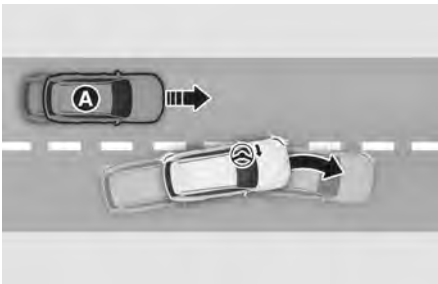
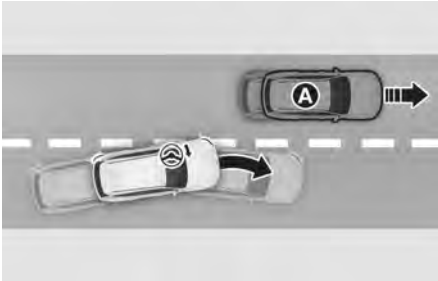

[A] Front-side vehicle

Lane-Change Side function helps avoid a collision with the vehicle or powered two-wheeler ahead in the next lane when changing lanes by assisting the driver's steering.

## Evasive Steering Assist function

 if equipped



- Driver steering assist

Evasive Steering Assist function helps avoid a collision with a vehicle, powered two-wheeler, pedestrian, or cyclist ahead in the same lane. When a collision risk is detected, Evasive Steering Assist function warns the driver and if the driver steers to avoid collision it assists the driver's steering.

- Evasive steering assist

Evasive Steering Assist function helps avoid a collision with a powered two-wheeler, pedestrian or cyclist ahead in the same lane. When a collision risk is detected, Evasive Steering Assist function warns the driver and if there is space to avoid collision in the lane, it assists the driver's steering.

## Forward Collision-Avoidance Assist Settings

### Forward Safety



With the engine on, select **Setup** > **Vehicle** > **Driver Assistance** from the Settings menu in the infotainment system to select the following:

- If **Forward Safety** is selected, Forward Collision-Avoidance Assist displays a warning message and sounds an audible warning depending on the collision risk levels. Braking assist is applied depending on the collision risk levels. If **Forward Safety** is deselected, Forward Safety turns off. The warning light (🚦) illuminates on the cluster.

### Forward Cross-Traffic Safety

**+ if equipped**

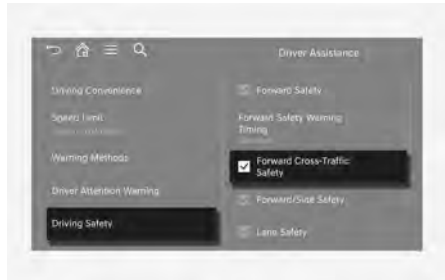

With the engine on, select **Setup** > **Vehicle** > **Driver Assistance** > **Driving Safety** > **Forward Cross-Traffic Safety** from the Settings menu to turn on Junction Crossing function and deselect to turn off the function.



### Forward/Side Safety

**+ if equipped**



With the engine on, select or deselect **Setup** > **Vehicle** > **Driver Assistance** > **Driving Safety** > **Forward/Side Safety** from the Settings menu to turn on Lane-Change Oncoming function, Lane-Change Side function, and Evasive Steering Assist function.

- If **Forward/Side Safety** is selected, Forward Collision-Avoidance Assist warns the driver, steering wheel vibration, a warning message, an audible warning depending on the collision risk levels. Steering assist is applied depending on the collision risk levels. If **Forward/Side Safety** is deselected, Forward/Side Safety turns off. The  warning light illuminates on the instrument cluster.

You can check whether Forward Collision-Avoidance Assist is on or off from the Settings menu. If the  or  warning light remains ON when Forward Collision-Avoidance Assist is on, have your vehicle inspected by an authorized retailer of Genesis Branded products.

### WARNING

Each time the engine is restarted, Forward Collision-Avoidance Assist turns on. If **Forward Safety**, **Forward-Cross Traffic Safety**, and **Forward/Side Safety** are deselected the driver should always be aware of the surroundings and drive safely.

### CAUTION

- The setting for **Forward Safety** include 'Basic function', 'Junction Turning function', and 'Direct Oncoming function'.
- The setting for **Forward-Cross Traffic Safety** includes 'Junction Crossing function'. (if equipped)
- The setting for **Forward/Side Safety** includes 'Lane-Change Oncoming function', 'Lane-Change Side function', and 'Evasive Steering Assist function' (if equipped).
- If **Forward Safety** is deselected, Junction Crossing function does not operate even when **Forward-Cross Traffic Safety** and **Forward/Side Safety** are selected.

## Forward Safety Warning Timing

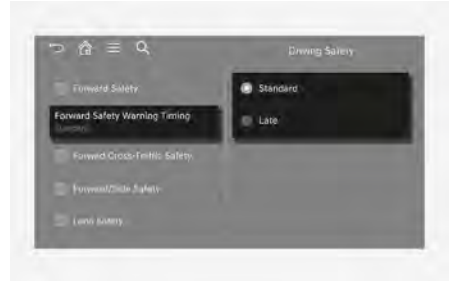

With the engine on, select **Setup > Vehicle > Driver Assistance > Driving Safety > Forward Safety Warning Timing** from the Settings menu in the infotainment system to change the initial warning activation time for Forward Collision-Avoidance Assist. The warning time can be set to either **Standard** (or **Normal**) or **Late**.

- Use **Standard** in normal driving conditions. If the Forward Safety Warning Timing seems sensitive, change it to **Late**.
- If **Late** is selected, Forward Collision-Avoidance Assist warns the driver more slowly.

### CAUTION

- Even though **Standard** is selected for Forward Safety Warning Timing, if the front vehicle suddenly stops, the warning may seem late.
- Select **Late** for Forward Safety Warning Timing when traffic is light and your speed is slow.

### Information

- The Forward Safety Warning Timing settings do not apply to **Forward/Side Safety**.
- When the engine is restarted, the Forward Safety Warning Timing maintains its last setting.

## Warning methods

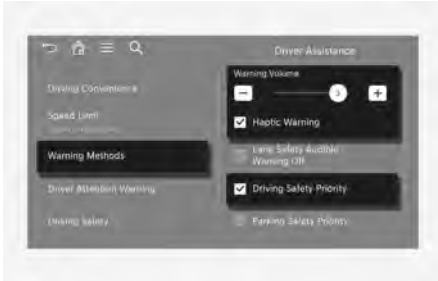

With the engine on, select **Setup > Vehicle > Driver Assistance > Warning Methods** from the Settings menu in the infotainment system to select the following:

- **Warning Volume:** The warning volume can be adjusted. If you set the warning volume to '0', the warning volume does not turn off but sounds as '1'.
- **Haptic Warning:** The steering wheel vibration can be set.
- **Driving Safety Priority:** Your vehicle lowers all other audio volumes when the Driver Assistance system warning sounds.

### *i* Information

- If you change the warning methods, the warning methods of other Driver Assistance systems may change.
- The warning volume and haptic warning cannot be turned off at the same time. When one of the warning is turned off the other is activated.
- When the engine is restarted, the warning methods maintains its last setting.
- The setting menu may not be available for your vehicle depending on the vehicle features and specifications.

## Forward Collision-Avoidance Assist Operation

### Basic function

Forward Collision-Avoidance Assist may warn and brake your vehicle depending on the collision risk level.

### Collision warning



- To warn the driver of a collision, the  warning light blinks and the "**Collision Warning**" warning message appears on the instrument cluster, an audible warning sounds, and the steering wheel vibrates.
- If a vehicle or powered two-wheeler is detected in front, the function operates when your vehicle speed is between about 6-124 mph (10-200 km/h).
- If a pedestrian or cyclist is detected in front, the function operates when your vehicle speed is between about 6-53 mph (10-85 km/h).



## Emergency braking



To warn the driver that emergency braking is assisted, the  warning light blinks and the **"Emergency Braking"** warning message appears on the instrument cluster, an audible warning sounds, and the steering wheel vibrates.

Emergency braking operates under the following conditions:

- Vehicle or powered two-wheeler:

	Driving vehicle	Stopped vehicle
Weak braking power	About 6-125 mph (10-200 km/h)	
Strong braking power	About 6-81 mph (10-130 km/h)	About 6-47 mph (10-75 km/h) (6-62 mph (10-100 km/h)) <sup>*1</sup>

\*1 If Forward Collision-Avoidance Assist judges that avoiding a collision is difficult even by changing the driving lane, braking is assisted more earlier. (if equipped)

- Pedestrian or cyclist:

The function operates when your vehicle speed is between about 6-40 mph (10-65 km/h).

## Stopping vehicle and ending brake control

After your vehicle has stopped following an Emergency Braking event, the **"Drive carefully"** warning message may appear on the instrument cluster.

Depress the brake pedal immediately and check the surroundings.

- Braking control ends about 2 seconds after your vehicle is stopped following an Emergency Braking event.

## Information

The audible warning can be turned off while collision warning or emergency braking is operating by pressing the hazard warning flasher button.

## Junction Turning function

Junction Turning function may warn and brake your vehicle depending on the collision risk level.

## Collision warning



- To warn the driver of a collision, the  warning light blinks and the **"Collision Warning"** warning message appears on the instrument cluster, an audible warning sounds, and the steering wheel vibrates.

- The function operates when your vehicle speed is between about 6-19 mph (10-30 km/h) and the oncoming vehicle or powered two-wheeler speed is between about 19-44 mph (30-70 km/h)\*.
- \*: It operates when a powered two-wheeler or cyclist speed is about 15-70 km/h (10-44 mph). (if equipped)

### Emergency braking



- To warn the driver that emergency braking is assisted, the  warning light blinks and the "**Emergency Braking**" warning message appears on the instrument cluster, an audible warning sounds, and the steering wheel vibrates.
- In an emergency braking situation, braking is assisted with strong braking power by the function to help prevent collision with the oncoming vehicle.
- The function operates when your vehicle speed is between about 6-19 mph (10-30 km/h) and the oncoming vehicle or powered two-wheeler speed is between about 19-44 mph (30-70 km/h)\*.
- \*: It operates when powered two-wheeler or cyclist speed is about 10-44 mph (15-70 km/h). (if equipped)

### *i* Information

If the driver's seat is on the left side, Junction Turning function operates only when you turn left. If the driver's seat position is on the right side, the function will operate only when you turn right.

---

### Stopping vehicle and ending brake control

After your vehicle has stopped following an Emergency Braking event, the "**Drive carefully**" warning message may appear on the instrument cluster.

Depress the brake pedal immediately and check the surroundings.

- Braking control ends about 2 seconds after your vehicle is stopped following an Emergency Braking event.

### *i* Information

- The audible warning can be turned off while collision warning or emergency braking is operating by pressing the hazard warning flasher button.
  - When turning right at an intersection, braking is assisted to reduce or avoid collisions if there is a collision risk with a cyclist approaching at the speed of 9 to 12 mph (15 to 20 km/h) from the opposite side. (if equipped)
-

### Direct Oncoming function

Direct Oncoming function may warn and brake your vehicle depending on the collision risk level.

#### Collision warning



- To warn the driver of a collision, the  warning light blinks and the "**Collision Warning**" warning message appears on the instrument cluster, an audible warning sounds, and the steering wheel vibrates.
- The function operates when your vehicle speed is between about 19-81 mph (30-130 km/h) (or 6-81 mph (10-130 km/h)\*) and the detected oncoming vehicle or powered two-wheeler speed is about above 6 mph (10 km/h).

\*: If equipped

#### Emergency braking



- To warn the driver that emergency braking is assisted, the  warning light blinks and the "**Emergency Braking**" warning message appears on the instrument cluster, an audible warning sounds, and the steering wheel vibrates.
- In an emergency braking situation, braking is assisted with strong braking power by the function to help prevent collision with the oncoming vehicle.
- The function operates when your vehicle speed is between about 19-80 mph (30-130 km/h) and the detected oncoming vehicle or powered two-wheeler speed is about above 6 mph (10 km/h).

#### Stopping vehicle and ending brake control

After your vehicle has stopped following an Emergency Braking event, the "**Drive carefully**" warning message may appear on the instrument cluster.

Depress the brake pedal immediately and check the surroundings.

- Braking control ends about 2 seconds after your vehicle is stopped following an Emergency Braking event.

#### CAUTION

If your vehicle or the oncoming vehicle is not driving straight, Direct Oncoming function warning and control may be late or may not operate.

## *i* Information

The audible warning can be turned off while collision warning or emergency braking is operating by pressing the hazard warning flasher button.

### Junction Crossing function

 If equipped

Junction Crossing function may warn and brake your vehicle depending on the collision risk level.

### Collision warning



- To warn the driver of a collision, the  warning light blinks and the "**Collision Warning**" warning message appears on the instrument cluster, an audible warning sounds, and the steering wheel vibrates.
- The function operates when your vehicle speed is between about 6-34 mph (10-55 km/h) and the crossing vehicle speed is between about 6-37 mph (10-60 km/h).

### Emergency braking



- To warn the driver that emergency braking is assisted, the  warning light blinks and the "**Emergency Braking**" warning message appears on the instrument cluster, an audible warning sounds, and the steering wheel vibrates.
- In an emergency braking situation, braking is assisted with strong braking power by the function to help prevent collision with the crossing vehicle.
- The function operates when your vehicle speed is between about 6-34 mph (10-55 km/h) and the crossing vehicle speed is between about 6-25 mph (10-40 km/h).

### Stopping vehicle and ending brake control

After your vehicle has stopped following an Emergency Braking event, the "**Drive carefully**" warning message may appear on the instrument cluster.

Depress the brake pedal immediately and check the surroundings.

- Braking control ends about 2 seconds after your vehicle is stopped following an Emergency Braking event.

## CAUTION

If your vehicle or the oncoming vehicle is not driving straight, Front Oncoming function's warning and vehicle control may be late or may not operate.

## *i* Information

The audible warning can be turned off while collision warning or emergency braking is operating by pressing the hazard warning flasher button.

### **Lane-Change Oncoming function**

**+** if equipped

Lane-Change Oncoming function warn and steer your vehicle depending on the collision risk levels.

### **Collision warning**



- To warn the driver of a collision, the  warning light blinks and the "**Collision Warning**" warning message appears on the instrument cluster, an audible warning sounds, and the steering wheel vibrates.
- The function operates when your vehicle speed is between about 25-90 mph (40-145 km/h) and the oncoming vehicle or powered two-wheeler speed is about above 6 mph (10 km/h) and the relative speed with your vehicle is about below 124 mph (200 km/h).

### **Emergency steering**



- To warn the driver that emergency steering is assisted, the  warning light blinks and the "**Emergency Steering**" warning message appears on the instrument cluster, an audible warning sounds, and the steering wheel vibrates.
- In an emergency steering situation, steering is assisted by the function to help prevent collision with the oncoming vehicle.
- The function operates when your vehicle speed is between about 25-90 mph (40-145 km/h) and the oncoming vehicle or powered two-wheeler speed is about above 6 mph (10 km/h) and the relative speed with your vehicle is about below 124 mph (200 km/h).

### Lane-Change Side function

 if equipped

Lane-Change Side function may warn and steer your vehicle depending on the collision risk level.

#### Collision warning



- To warn the driver of a collision, the  warning light blinks and the "**Collision Warning**" warning message appears on the instrument cluster, an audible warning sounds, and the steering wheel vibrates.
- The function operates when your vehicle speed is between about 25-90 mph (40-145 km/h).

#### Emergency steering

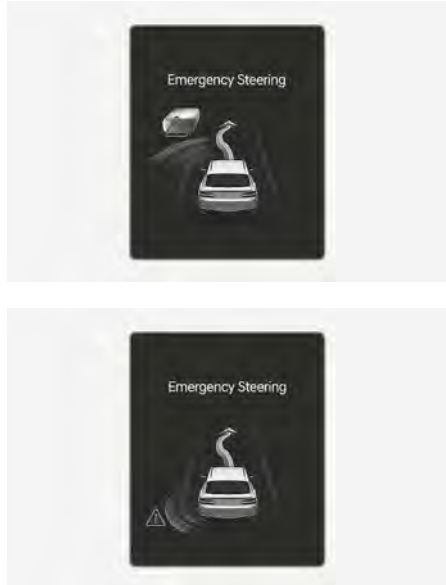

- To warn the driver that emergency steering is assisted, the  warning light blinks and the "**Emergency Steering**" warning message appears on the instrument cluster, an audible warning sounds, and the steering wheel vibrates.
- In an emergency steering situation, steering is assisted by the function to help prevent collision with the front-side vehicle.
- The function operates when your vehicle speed is between about 25-90 mph (40-145 km/h) and front-side vehicle and powered two-wheeler is driving.

#### CAUTION

Lane-Change Side function does not operate if the vehicle speed of the preceding vehicle from the front side is 0 mph (0 km/h).

## Evasive Steering Assist function

**+** if equipped

Evasive Steering Assist function may warn and steer your vehicle with Emergency steering.

### Emergency Steering (Driver steering assist)



- To warn the driver that emergency steering is assisted, the  warning light blinks and the "**Emergency Steering**" message appears on the instrument cluster, an audible warning sounds, and the steering wheel vibrates.
- If there is a risk of collision with a vehicle, powered two-wheeler, pedestrian, or cyclist in front, the steering is assisted to help prevent collision when the driver steers the vehicle to avoid collision.
- The function operates when your vehicle speed is between about 25-53 mph (40-85 km/h).

### Emergency steering (Evasive steering assist)



- To warn the driver that emergency steering is assisted, the  warning light blinks and the "**Emergency Steering**" message appears on the instrument cluster, an audible warning sounds, and the steering wheel vibrates.
- If there is high risk of collision with a pedestrian and cyclist in front, and the vehicle speed to operate emergency braking has exceeded, the steering is assisted to help prevent collision when there is space to avoid collision in the driving lane.
- The function operates when your vehicle speed is between about 40-47 mph (65-75 km/h).

### CAUTION

- The steering wheel may turn automatically when emergency steering is operating.
- Emergency steering automatically cancels when risk factors disappear. If necessary, the driver must steer the vehicle.
- Emergency steering may not operate or may cancel during operation if the steering wheel is held tight or steered in the opposite direction.

- When steering is assisted to avoid collision with a vehicle, powered two-wheeler, pedestrian and cyclist, Evasive steering assist will be cancelled if collisions with other objects (vehicles, powered two-wheeler, pedestrians, or cyclists) are expected.
- Evasive steering assist may not operate if space to avoid collision in the driving lane is insufficient.
- When driving at night, the recognition performance for the powered two-wheeler may decrease, that may temporarily limit or disable the Forward Collision-Avoidance Assist.

### Information

For more information on warning messages, refer to Collision Warning in "Basic function".

### WARNING

Forward Collision-Avoidance Assist may not operate in all situations and cannot avoid all collisions.

To prevent serious injury or death:

- Only change the settings after parking your vehicle at a safe location.
- Forward Collision-Avoidance Assist does not operate in all situations or cannot avoid all collisions.
- Control your vehicle at all times. Do not depend on Forward Collision-Avoidance Assist to avoid a collision. Always maintain a safe distance from the vehicles ahead and reduce your vehicle speed as needed.
- Never attempt to activate Forward Collision-Avoidance Assist by intentionally driving toward people, animals, objects, or other vehicles.

- Forward Collision-Avoidance Assist may not assist braking your vehicle if you depress the brake pedal sufficiently in response to the potential hazard detected by the function to avoid all collisions.
- Depending on the road and driving conditions, Forward Collision-Avoidance Assist may warn the driver late or may not warn the driver.
- During Forward Collision-Avoidance Assist operation, your vehicle may stop suddenly. Always wear your seat belt, check your passengers have their seat belts fastened and secure loose objects that may become projectiles.
- When other system's warning message appears or audible warning is heard, Forward Collision-Avoidance Assist may not warn you.
- You may not hear the audible warning of Forward Collision-Avoidance Assist if the surrounding environment is too noisy.
- Forward Collision-Avoidance Assist may stop operating, or may not operate properly, or may operate unnecessarily depending on the road conditions and the surroundings.

### WARNING

- Even if there is a problem with Forward Collision-Avoidance Assist, the vehicle's basic braking system operates normally.
- During emergency braking, braking by Forward Collision-Avoidance Assist automatically cancels if you excessively depress the accelerator pedal or sharply steer your vehicle.



## ⚠ CAUTION

- Depending on the condition of the vehicle, powered two-wheeler, pedestrian, and cyclist detected in front, and the surroundings, the speed ranges Forward Collision-Avoidance Assist may be reduced. Forward Collision-Avoidance Assist may only warn the driver, or it may not operate.
- Forward Collision-Avoidance Assist operates only under certain conditions that determines the risk level:
  - Condition of other vehicles
  - The direction vehicles are driven
  - Vehicle speed
  - Surroundings
- If your vehicle speed is too fast or the speed difference with the other vehicle, powered two-wheeler, or cyclist is large, Forward Collision-Avoidance Assist may be limited or may not operate properly.
- When a collision with a surrounding vehicle is expected, Lane-Change Oncoming, Lane-Change Side and Evasive Steering Assist does not assist you with steering but only warn the you of a collision (if equipped).

## *i* Information

- When a collision is imminent, braking may be assisted if you depress the brake pedal insufficiently.
- The images and colors in the instrument cluster may differ depending on the cluster type or theme selected from the settings menu.

## Forward Collision-Avoidance Assist Malfunction And Limitations

### *Forward Collision-Avoidance Assist malfunction*





When Forward Collision-Avoidance Assist is not working properly, the "**Check Driver Assistance system.**" warning message may appear, and the ⚠, 🚗, and 🚲 warning lights illuminate on the cluster. Have your vehicle inspected by an authorized retailer of Genesis Branded products.

### *Forward Collision-Avoidance Assist disabled*



If the front view camera, front radar, bumper, or sensor is covered or blocked by foreign material, such as snow, rain, or dirt, or when a trailer or hitch mounted carrier is installed, the detecting performance may decrease and temporarily limit or disable Forward Collision-Avoidance Assist.

The "**Driver Assistance system limited. Camera obscured.**" or the "**Driver Assistance system limited. Radar blocked.**" warning message may appear, and the , , and  warning lights may illuminate on the instrument cluster.

The function operates normally when such foreign material, trailer, or carrier is removed, and the engine is restarted.

If Forward Collision-Avoidance Assist does not operate normally after anything covering or blocking the sensors is removed, have your vehicle inspected by an authorized retailer of Genesis Branded products.

### **WARNING**

- Forward Collision-Avoidance Assist may not operate properly even if there is no warning message or warning light on the instrument cluster.
- Forward Collision-Avoidance Assist may not operate properly in open areas where no objects are detected (e.g. empty parking lot) or when the detecting sensors are blocked right after turning on the engine.
- If the vehicle is turned off and restarted while the camera is blocked or malfunctioned, the condition is maintained and may not operate properly.

---

### Detecting sensors

Refer to the "Driver Assistance System Sensors" section in this chapter for the location and the general precautions of the front view camera, front radar, front corner radar (if equipped), and rear corner radar.

### **Limitations of Forward Collision-Avoidance Assist**

Forward Collision-Avoidance Assist may not operate normally or may operate unexpectedly if:

- The detecting sensor or the surroundings are blocked, covered, or damaged by snow, water, or dirt, etc.
- The temperature near the front view camera is hot or cold.
- The camera lens is covered or blocked by windshield tint, the windshield is damaged, or a sticky material (sticker, bug, etc.) is on the glass.
- Moisture is not removed or frozen on the windshield.
- Washer fluid is sprayed continuously, or the wiper is on.
- You are driving in heavy rain or snow, or thick fog.
- The front view camera's field of view is obstructed by glare from the sun.
- Sunlight, streetlight or light from an oncoming vehicle is reflected on the wet road surface such as a puddle on the road.
- An object is placed on the dashboard.
- Your vehicle is being towed.
- The surrounding is very bright or very dark (nighttime, tunnel, etc.).
- The brightness changes suddenly, for example when entering or exiting a tunnel.
- The brightness outside is low, and the headlamps of the front vehicle are turned off or are not bright.
- A front vehicle, powered two-wheeler, pedestrian, or cyclist is partially visible.
- The vehicle in front is a bus, heavy truck, truck with an unusual shape, trailer, etc.
- The vehicle or powered two-wheeler in front has no tail lamps, tail lamps are located in an unusual location.

- In low light conditions, the tail lamps of the front vehicle are turned off or not bright.
- The rear of the front vehicle is small or the vehicle does not look normal, such as when the vehicle is tilted, overturned, or the side of the vehicle is visible, etc.
- The front vehicle's ground clearance is too low or high
- A vehicle, powered two-wheeler, pedestrian, or cyclist suddenly cuts in front.
- The bumper around the front radar has been damaged or modified, and the radar is out of position.
- The temperature around the front radar is very hot or cold.
- A material is near that reflects very well on the front radar, such as guardrail, nearby vehicle, etc.
- The bicycle in front is made of material that does not reflect on the front radar well.
- The vehicle or powered two-wheeler in front is detected late.
- The vehicle or powered two-wheeler in front is suddenly blocked by an obstacle.
- The vehicle or powered two-wheeler in front changes lane or reduces the speed.
- The vehicle or powered two-wheeler in front is bent out of shape.
- The speed of the vehicle or powered two-wheeler in front is slow or fast.
- The vehicle or powered two-wheeler in front steers in the opposite direction of your vehicle to avoid a collision.
- Your vehicle changes lane at low speed with a vehicle or powered two-wheeler in front.
- The vehicle in front is covered with snow.
- You are departing or returning to the lane.
- You are on curve or roundabout and the vehicle or powered two-wheeler in front is not detected
- You are continuously driving in a circle.
- The vehicle in front has an unusual shape.
- The vehicle in front is driving uphill or downhill.
- Only part of a pedestrian or cyclist is detected. For example, if the pedestrian is leaning over or is not walking upright.
- The pedestrian or cyclist is wearing clothing or equipment that makes it difficult to detect.



The illustration above shows the image the front view camera and front radar are capable of detecting as a vehicle, powered two-wheeler, pedestrian, and cyclist.

- The pedestrian or cyclist in front is moving very quickly.
- The pedestrian or cyclist in front is short.
- The pedestrian or cyclist in front has impaired mobility.
- The pedestrian or cyclist in front is moving at an angle to the path of your vehicle.
- There is a group of pedestrians, cyclists in front of your vehicle.

- The pedestrian or cyclist is wearing clothing that easily blends into the background, making it difficult to detect.
- The pedestrian or cyclist is difficult to distinguish from the similar shaped structure in the surroundings.
- You are driving by a pedestrian, cyclist, traffic signs, and other structure near an intersection.
- You are driving through steam, smoke, or shadow.
- You are driving through a tunnel or an iron bridge.
- You are driving in large, open areas where there are few vehicles or structures (e.g. desert, meadow, empty suburb).
- You are driving in a parking lot.
- You are driving through a tollgate, construction area, unpaved road, partial paved road, uneven road, speed bumps, etc.
- You are driving through roads with railroad tracks or other embedded metal objects.
- You are driving on an inclined road or curved road.
- You are driving through a roadside with trees or streetlights.
- You are driving on a narrow road where trees or grass are overgrown.
- You are driving in an area with strong radio waves or electrical noise interference.
- The vehicle moves unstably or vibrates excessively.
- Your vehicle height is low or high due to heavy loads, abnormal tire pressure, etc.

### **Junction Crossing, Lane-Change Oncoming, Lane-Change Side, Evasive Steering Assist function**

 If equipped

- The temperature near the front corner radar or rear corner radar is very hot or cold.
- A trailer or hitch mounted carrier is installed and it blocks the rear corner radar.
- The front corner radar or rear corner radar is covered by snow, rain, dirt, etc.
- The area near the front corner radar or rear corner radar is covered with objects, such as a bumper sticker, bumper guard, bike rack, etc.
- The bumper around the front corner radar or rear corner radar has been damaged or modified, and the radar is out of position.
- The front corner radar or rear corner radar is blocked by a vehicle, wall, or pillar.
- You are driving on an entrance/exit ramp or through a tollbooth.
- There is a fixed object near your vehicle, such as sound barriers, guardrails, central dividers, entry barriers, streetlights, signs, tunnels, walls, etc.
- The other vehicle drives very close behind your vehicle, or passes by your vehicle in close proximity.
- The speed of the other vehicle is so fast that it passes by your vehicle in a short time.
- Your vehicle passes another vehicle.
- Your vehicle has started at the same time as the vehicle next to you and has accelerated.
- The vehicle in the next lane moves two lanes away from you, or the vehicle moves two lanes away to the next lane.
- A motorcycle or bicycle is detected.

- A vehicle such as a flat trailer is detected.
- A big vehicle such as a bus or truck is detected.
- A moving obstacle such as a pedestrian, animal, shopping cart, or a baby stroller is detected.
- A vehicle with lower height, such as a sports car is detected.
- The lane is difficult to distinguish because:
  - The lane markings are damaged or covered with rain, snow, dirt, oil, etc.
  - The color of the lane marking road surface is wet.
  - There are markings on the road or near the lane that looks similar to the lane markings.
  - The lane markings are covered by the shadow of objects around the road, such as median strip, guardrails, noise barriers, and trees.
- The lane number increases or decreases, or the lane markings are crossing.
- There are more than two lane markings on the road.
- The lane markings are complicated or a structure substitutes for the lines, such as a construction area or tollbooth area.
- There are road markings, such as zigzag lanes, crosswalk markings, and road signs.
- The lane suddenly disappears, such as at the intersection.
- The lane is very wide or narrow.
- There is a curb or road edged without a lane.
- You are driving on the left or right side of the median bus lane or on the median bus lane.
- The distance to the front vehicle is extremely short or the vehicle in front is covering the lane marking.

## WARNING

### • Driving on curves

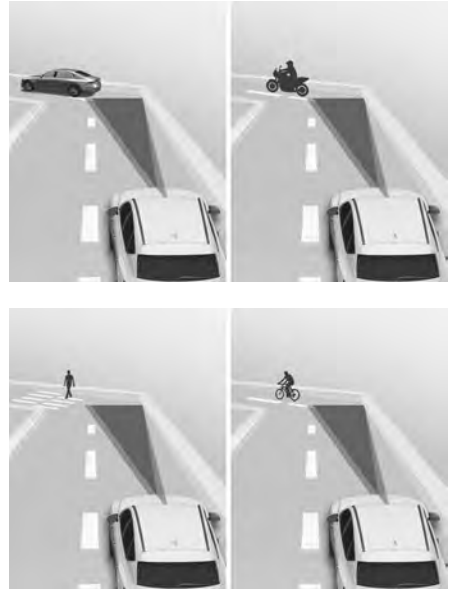

Forward Collision-Avoidance Assist may not detect other vehicles, powered two-wheelers, pedestrians, or cyclists in front of you when driving on a curve adversely affecting the performance of the sensors. A warning, brake assist, or steering assist (if equipped) may not be activated when needed.

When driving on a curve, always maintain a safe distance from others on the road. Reduce your vehicle speed or steer your vehicle as needed.





If a vehicle, powered two-wheeler, pedestrian, or cyclist is detected in the next lane or outside the lane when driving on a curve. Forward Collision-Avoidance Assist may warn you and may brake or steer (if equipped) your vehicle even when not needed.

Always check road conditions, and if necessary, take appropriate actions to drive safely.

- **Driving on hills**



Forward Collision-Avoidance Assist may not detect other vehicles, powered two-wheelers, pedestrians, or cyclists in front of you while driving uphill or downhill, adversely affecting the performance of the sensors. A warning, brake assist, or steering assist (if equipped) may not be activated when needed.

Also, vehicle speed may rapidly decrease when a vehicle, powered two-wheeler, pedestrian or cyclist ahead is suddenly detected. Always maintain a safe distance from the others on the road. Adjust your vehicle speed or steer your vehicle depending on the road conditions.

- Changing lanes



- [A] Your vehicle
- [B] Lane changing vehicle

When a vehicle moves into your lane from an adjacent lane, it cannot be detected by the sensor until it is in the sensor's detection range. Forward Collision-Avoidance Assist may not immediately detect the vehicle when the vehicle changes lanes suddenly.

Always maintain a safe distance from the vehicles ahead. Adjust your vehicle speed or steer your vehicle depending on the road conditions.



- [A] Your vehicle
- [B] Lane changing vehicle
- [C] Same lane vehicle

When a vehicle in front of you departs the lane, Forward Collision-Avoidance Assist may not immediately detect another vehicle in your lane of travel.

Always maintain a safe distance from the vehicles ahead. Adjust your vehicle speed or steer your vehicle depending on the road conditions.

### • Detecting a vehicle



Forward Collision-Avoidance Assist may not be able to detect all potential hazards, like if the vehicle in front of you has cargo that extends rearward past the end of the vehicle or if the vehicle in front of you has higher ground clearance. Always maintain a safe distance from the vehicles ahead. Adjust your vehicle speed or steer your vehicle depending on the road conditions.

---

### **WARNING**

- Always turn off Forward Collision-Avoidance Assist when towing a trailer or another vehicle.
  - Forward Collision-Avoidance Assist may operate if objects that are similar in shape or characteristics to vehicles, powered two-wheelers, pedestrians and cyclists are detected.
  - Forward Collision-Avoidance Assist does not operate on bicycles, or smaller wheeled objects, such as luggage bags, shopping carts, or strollers.
  - Forward Collision-Avoidance Assist may not operate properly if there is interference from strong electromagnetic waves.
  - Forward Collision-Avoidance Assist may not operate for 15 seconds right after the vehicle is started or when the front view camera is initialized.
- 

### *i* **Information**

For limitations in the driver's blind spot areas and precautions for the rear corner radars, refer to the "Blind-Spot Collision-Avoidance Assist (BCA)" section in this chapter.

---

### *i* **Information**

This device complies with Part 15 of the FCC rules.

Operation is subject to the following three conditions:

- This device may not cause harmful interference, and
  - This device must accept any interference received, including interference that may cause undesired operation.
  - Changes or modifications not expressly approved by the party responsible for compliance could void the user's authority to operate the device.
- 

### *i* **Information**

Radio frequency radiation exposure information:

This equipment complies with FCC radiation exposure limits set forth for an uncontrolled environment.

This equipment should be installed and operated with minimum distance of 8 in. (20 cm) between the radiator (antenna) and your body.

This transmitter must not be co-located or operating in conjunction with any other antenna or transmitter.

---



## Lane Keeping Assist (LKA)

Lane Keeping Assist helps detect lane markings (or road edges) while driving over a certain speed. Lane Keeping Assist may warn you if your vehicle leaves the lane without using the turn signal and may steer the vehicle to prevent it from departing its travel lane.

## Lane Keeping Assist Settings

### Lane Safety

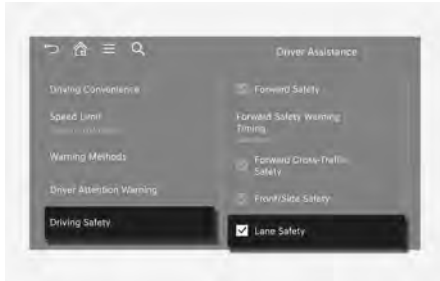

With the engine on, select **Setup > Vehicle > Driver Assistance > Driving Safety** from the Settings menu in the infotainment system to select the following:

- If **Lane Safety** is selected, Lane Keeping Assist automatically assists with steering your vehicle to help prevent your vehicle from departing its travel lane. If **Lane Safety** is deselected, Lane Keeping Assist turns off and the  indicator light turns off on the cluster.

### WARNING

- Lane Keeping Assist does not assist with steering if you drive near the middle of the lane.
- Always be aware of the surroundings. If **Lane Safety** is deselected, Lane Keeping Assist does not assist you.

## Warning methods



With the engine on, select **Setup > Vehicle > Driver Assistance > Warning Methods** from the Settings menu in the infotainment system to select the following:

- **Warning Volume:** The warning volume can be adjusted.
- **Haptic Warning:** The steering wheel vibration can be set.
- **Lane Safety Audible Warning Off:** The warning volume of Lane Safety does not sound when haptic warning is selected.
- **Driving Safety Priority:** Your vehicle lowers all other audio volumes when the Driver Assistance system warning sounds.

### Information

- If you change the warning methods, the warning methods of other Driver Assistance systems may change.
- **Lane Safety Audible Warning Off** can be set when both the **Warning Volume** and the **Haptic Warning** are on.
- If you turn off the haptic warning when the warning volume is '0', the warning volume does not turn off but sounds as '1'.
- If you set the warning volume to '0' when the haptic warning is off, the haptic warning turns on.

- When the engine is restarted, the warning methods maintains its last setting.

## Lane Keeping Assist Operation

### Turning Lane Keeping Assist On/Off



With the engine on, press and hold the Lane Driving Assist (/☉\ ) button located on the steering wheel to turn on and off. When Lane Keeping Assist is on, the /☉\ indicator is on.

When Lane Keeping Assist is off, the /☉\ indicator turns off.

### **i** Information

- When Lane Keeping Assist is ready to operate, /☉\ indicator turns gray on the instrument cluster.
- When Lane Keeping Assist is operating, /☉\ indicator turns green on the instrument cluster.

## Warning and control

Left



Right



## Lane Departure Warning

- If your vehicle detects it is departing from the projected lane ahead, the green /☉\ indicator light blinks on the cluster, the lane line blinks on the cluster depending on which direction the vehicle is veering, and an audible warning sounds.
- Lane Keeping Assist operates when your vehicle speed is about 40-124 mph (60-200 km/h).

## Lane Keeping Assist

- If your vehicle detects it is departing from the projected lane in front, the green /☉\ indicator light blinks on the cluster, and the steering wheel makes adjustments to keep vehicle inside the lane.
- Lane Keeping Assist operates when your vehicle speed is about 40-124 mph (60-200 km/h).

## Hands-off warning



If you take your hands off the steering wheel for several seconds, the "**Keep hands on steering wheel**" warning message may appear on the instrument cluster, and an audible warning may sound in successive stages.

### WARNING

Lane Keeping Assist may not operate in all situations and cannot avoid all collisions.

To prevent serious injury or death:

- Lane Keeping Assist may not steer if the steering wheel is held too tightly or the steering wheel is turned too far left or right.
- Always steer your vehicle. Lane Keeping Assist is not an autonomous driving system and does not steer your vehicle at all times.
- If the steering wheel is held very loosely or you have gloves on, the hands-off warning message may appear because the Lane Keeping Assist may not recognize that you have your hands on the steering wheel.
- The hands-off warning message may appear late or not at all depending on the road condition.
- If you attach objects to the steering wheel, the hands-off warning may not work properly.

## *i* Information

- You can steer your vehicle even when steering is assisted by Lane Keeping Assist.
- It may require more or less force to turn the steering wheel when Lane Keeping Assist is providing steering assistance.
- When lane markings (or road edges) are detected, the lane lines on the cluster changes from gray to white.
- When the lane markings (or road edges) are detected and Highway Lane Change Assist is on, the lane lines on the cluster may change to green. (if equipped)

Lane undetected



Lane detected





- The images and colors in the cluster may differ depending on the cluster type or theme selected from the cluster.

## Lane Keeping Assist Malfunction and Limitations

### Lane Keeping Assist malfunction





When Lane Keeping Assist is not working properly, the "**Check Driver Assistance system.**" warning message may appear, and the  or yellow  warning light may illuminate on the instrument cluster. Have your vehicle inspected by an authorized retailer of Genesis Branded products.

### Lane Keeping Assist disabled



If the front view camera or front radar is covered or blocked, its detecting performance is reduced, and Lane Keeping Assist may be temporarily limited or disabled.

The "**Driver Assistance system limited. Camera obscured.**" warning message may appear, and the  or  warning light may illuminate on the instrument cluster.

The function operates normally when such foreign material is removed, and the engine is restarted.

If Lane Keeping Assist does not operate normally after the sensor has been uncovered or unblocked, have your vehicle inspected by an authorized retailer of Genesis Branded products.

### WARNING

- Lane Keeping Assist may not operate properly even if there is no warning message or warning light on the instrument cluster.
- If the vehicle is turned off and restarted while the camera is blocked or malfunctioned, the condition is maintained and may not operate properly.

### Detecting sensors

Refer to the "Driver Assistance System Sensors" section in this chapter for the location and the general precautions of the front view camera.

### Limitations of Lane Keeping Assist

Lane Keeping Assist may not operate normally or may operate unexpectedly if:

- The lane is difficult to distinguish because:
  - The lane markings (or road edge) are damaged or covered with rain, snow, dirt, oil, etc.
  - The color of the lane marking (or road edge) is not distinguishable from the road.
  - There are markings (or road edges) on the road or near the lane that looks similar to the lane markings (or road edge)
  - The lane markings are covered by the shadow of objects around the road, such as median strip, guardrails, noise barriers, and trees.

- The lane number increases or decreases, or the lane markings (or road edges) are crossing.
- There are more than two lane markings (or road edges) on the road.
- The lane markings (or road edges) are complicated or a structure substitutes for the lines, such as a construction area or tollbooth area.
- There are road markings, such as zigzag lanes, crosswalk markings and road signs.
- The lane suddenly disappears, such as at the intersection.
- The lane (or road width) is very wide or narrow.
- There is a road edge without a lane.
- There is a boundary structure in the road, such as sidewalk or curb.
- The distance to the front vehicle is extremely short or the vehicle in front is covering the lane marking (or road edge).
- If your vehicle is driven at high speed, Lane Keeping Assist may not steer the vehicle.
- When other system's warning message appears or audible warning is heard, Lane Keeping Assist may not warn you.
- You may not hear the audible warning of Lane Keeping Assist if the surrounding is noisy.
- If you attach objects to the steering wheel, steering may not be assisted properly.
- Lane Keeping Assist may not operate for 15 seconds right after your vehicle is started or when the front view camera is initialized.
- Lane Keeping Assist does not operate when:
  - Either the turn signal or hazard warning flasher is turned on.
  - Your vehicle is not driven in the center of the lane after turning on Lane Keeping Assist or after changing lanes.
  - ESC (Electronic Stability Control) or VSM (Vehicle Stability Management) is controlling the brake force to the wheels.
  - Your vehicle is driven on sharp curves.
  - Driving below 35 mph (55 km/h) or above 130 mph (210 km/h).
  - Your vehicle makes sharp lane changes.
  - Your vehicle brakes suddenly.

### **i** Information

For more information on the limitations of the front view camera, refer to the "Forward Collision-Avoidance Assist (FCA)" section in this chapter.

### **⚠** WARNING

- Always monitor your vehicle speed and the distance to vehicles ahead on the road. Lane Keeping Assist is not a substitute for safe driving practices, but a supplemental function only.
- Lane Keeping Assist may be canceled or may not work properly depending on the road conditions and the surroundings.
- When you are towing a trailer or another vehicle, turn off Lane Keeping Assist.

## Blind-Spot Collision-Avoidance Assist (BCA)

Blind-Spot Collision-Avoidance Assist helps detect approaching vehicles in the driver's blind spot areas and warn you of a possible collision with a warning message and audible warning.

If there is a collision risk when exiting a parallel space, Blind-Spot Collision-Avoidance Assist may assist with braking your vehicle to help avoid a collision.

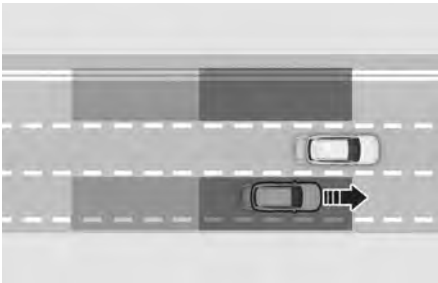

Blind-Spot Collision-Avoidance Assist helps detect and warns you that a vehicle is in the blind spot area.

### CAUTION

The detection range may differ depending on the speed of your vehicle. Vehicles in the blind spot area may not be detected by Blind-Spot Collision-Avoidance Assist when you pass other vehicles at high speeds.

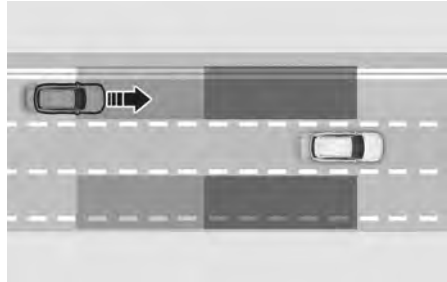

Blind-Spot Collision-Avoidance Assist helps detect and warns you that a vehicle is approaching at high speed from the blind spot area.

### CAUTION

The warning timing may differ depending on the speed of the vehicle approaching you at high speed.

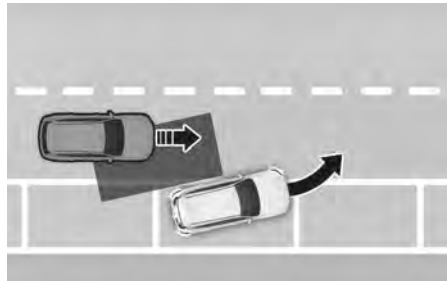

Blind-Spot Collision-Avoidance Assist may brake your vehicle if there is a detected collision risk in the blind spot area when driving forward out of a parking space.

## Blind-Spot Collision-Avoidance Assist Settings

### Blind-Spot Safety

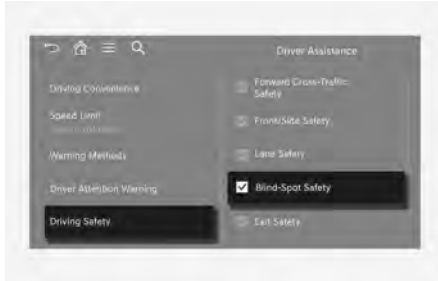

With the engine on, select **Setup** > **Vehicle** > **Driver Assistance** > **Driving Safety** from the Settings menu to select the following:

- If **Blind-Spot Safety** is selected, Blind-Spot Collision-Avoidance Assist displays a warning message and sounds an audible warning depending on the collision risk levels. Braking assist is applied for parking exit depending on the collision risk levels.



If you select **Blind-Spot Safety**, the warning lights on the side view mirror blinks for three seconds.

In addition, if the engine is turned on, when **Blind-Spot Safety** is selected, the warning lights on the side view mirror blinks for three seconds.

When the engine is restarted with Blind-Spot Collision-Avoidance Assist off, the "**Blind-Spot Safety System is Off**" message appears on the instrument cluster.

### WARNING

Always be aware of the surroundings. If **Blind-Spot Safety** is deselected, the function does not assist you.

### Information

When the engine is started, Blind-Spot Collision-Avoidance Assist maintains its last setting.

### Warning methods



With the engine on, select **Setup** > **Vehicle** > **Driver Assistance** > **Warning Methods** from the Settings menu in the infotainment system to select the following:

- **Warning Volume:** The warning volume can be adjusted.
- **Haptic Warning:** The steering wheel vibration can be set.
- **Driving Safety Priority:** Your vehicle lowers all other audio volumes when the Driver Assistance system warning sounds.

### **i** Information

- If you change the warning methods, the warning methods of other Driver Assistance systems may change.
  - If you turn off the haptic warning when the warning volume is '0', the warning volume does not turn off but sounds as '1'.
  - If you set the warning volume to '0' when the haptic warning is off, the haptic warning turns on.
  - When the engine is restarted, the warning methods maintains its last setting.
- 

## **Blind-Spot Collision-Avoidance Assist Operation**

### *Collision warning (while driving)*

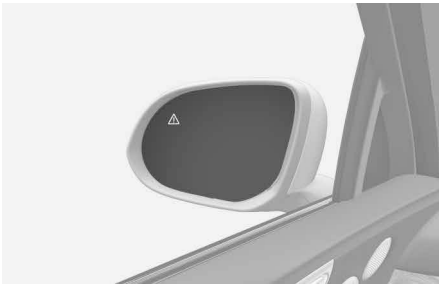

When a vehicle is detected in a blind spot, the warning light on the side view mirror and head-up display (if equipped) may illuminate.

- Vehicle detection operates when your vehicle speed is above 12 mph (20 km/h) and the speed of the vehicle in the blind spot area is above 7 mph (10 km/h).

Collision warning may operate when the turn signal is turned on in the direction of a detected vehicle.

- To warn you of a potential collision, the warning light on the side view mirror and head-up display (if equipped) may blink, an audible warning may sound, and the steering wheel may vibrate.
- Collision warning operates when your vehicle speed is above 24 mph (40 km/h) and the speed of the vehicle in the blind spot area is above 7 mph (10 km/h).
- When the turn signal is turned off or you move away from the vehicle in the blind spot, the system returns to vehicle detection state.

### **⚠ WARNING**

- The detecting range of the rear corner radar is determined by a standard road width. On narrow roads, Blind-Spot Collision-Avoidance Assist may detect other vehicles two lane over and warn you. On wide roads, Blind-Spot Collision-Avoidance Assist may not be able to detect a vehicle driving in the next lane and may not warn you.
  - When the hazard warning flasher is on, the collision warning initiated by activating the turn signal may not operate.
- 

### **i** Information

If the driver seat is on the left side, the collision warning may occur when you turn left. If the driver seat is on the right side, the collision warning may occur when you turn right. Maintain a proper distance from other vehicles when turning.

---



### Collision-avoidance assist (while parallel exiting)



To warn you of a potential collision, the warning light on side view mirror and head-up display (if equipped) may blink, a warning message may appear on the instrument cluster, an audible warning may sound, and the steering wheel may vibrate.

- Collision-Avoidance Assist operates when your vehicle speed is below 2 mph (3 km/h) and the speed of the vehicle in the blind spot area is above 3 mph (5 km/h).
- Emergency braking is assisted to help avoid collision with the vehicle in the blind spot area.

After your vehicle is stopped following an Emergency Braking event, the "**Drive carefully**" warning message appears on the instrument cluster.

Depress the brake pedal immediately and check the surroundings.

- Braking control ends about 2 seconds after your vehicle is stopped following an Emergency Braking event.

#### **WARNING**

Blind-Spot Collision-Avoidance Assist may not operate in all situations and cannot prevent all collisions. To prevent serious injury or death:

- Only change the settings after parking your vehicle at a safe location.

- Blind-Spot Collision-Avoidance Assist may not operate if the function determines you have depressed the brake pedal sufficiently in response to the potential hazard detected by the function.
- If Blind-Spot Collision-Avoidance Assist is assisting to brake your vehicle and you excessively depress the accelerator pedal or sharply steer your vehicle, it stops assisted braking.
- During Blind-Spot Collision-Avoidance Assist operation, your vehicle may stop suddenly. Always wear your seat belt, check your passengers have their seat belts fastened and secure loose objects that may become projectiles.
- Even if there is a problem with Blind-Spot Collision-Avoidance Assist, your vehicle's braking system operates normally.
- Blind-Spot Collision-Avoidance Assist may warn you or may not warn you depending on the road and driving conditions.
- Control your vehicle at all times. Always maintain a safe distance from the vehicles ahead and adjust your vehicle speed depending on the road conditions. Depress the brake pedal to reduce driving speed or to stop the vehicle.
- Never attempt to activate Blind-Spot Collision-Avoidance Assist by intentionally driving toward people, animals, objects, or other vehicles.
- When other system's warning message appears or audible warning is heard, Blind-Spot Collision-Avoidance Assist may not warn you.
- You may not hear the audible warning of Blind-Spot Collision-Avoidance Assist if the surrounding environment is too noisy.

**⚠ WARNING**

Braking is not assisted and only a warning is provided when:

- The ESC (Electronic Stability Control) warning light is on.
- ESC (Electronic Stability Control) is engaged in a different function.

## Blind-Spot Collision-Avoidance Assist Malfunction And Limitations

### *Blind-Spot Collision-Avoidance Assist malfunction*



When Blind-Spot Collision-Avoidance Assist is not working properly, the "**Check Driver Assistance system**" warning message may appear for several seconds, and the ⚠ warning light may illuminate on the instrument cluster. Have your vehicle inspected by an authorized retailer of Genesis Branded products.



When the side view mirror warning light is not working properly, the "**Check side view mirror warning light**" warning message may appear for several seconds, and the ⚠ warning light may illuminate on the instrument cluster. Have your vehicle inspected by an authorized retailer of Genesis Branded products.

### *Blind-Spot Collision-Avoidance Assist disabled*



If the rear corner radar is blocked or covered, or when the rear bumper around the rear corner radar or sensor is covered by any foreign material, such as snow, rain, or dirt, or when a trailer or hitch mounted carrier is installed, the detecting performance may reduce and temporarily limit or disable Blind-Spot Collision-Avoidance Assist.

The "**Driver Assistance system limited. Radar blocked**" warning message may appear on the instrument cluster.

The function operates normally when such foreign material, trailer, or carrier is removed, and the engine is restarted.

If Blind-Spot Collision-Avoidance Assist does not operate normally after anything covering or blocking the sensors is removed, have your vehicle inspected by an authorized retailer of Genesis Branded products.

## WARNING

- Blind-Spot Collision-Avoidance Assist may not operate properly even if there is no warning message or warning light on the instrument cluster. Blind-Spot Collision-Avoidance Assist may not properly operate.
- Blind-Spot Collision-Avoidance Assist may not operate properly in open areas where no objects are detected (e.g. empty parking lot) or when the detecting sensors are blocked right after turning on the engine.

### Detecting sensors

Refer to the "Driver Assistance System Sensors" section in this chapter for the location and the general precautions of the rear corner radar.

### *Limitations of Blind-Spot Collision-Avoidance Assist*

Blind-Spot Collision-Avoidance Assist may not operate normally or may operate unexpectedly if:

- There is inclement weather, such as heavy snow, heavy rain, etc.
- The rear corner radar or the area near the rear corner radar is covered by snow, water, or dirt.
- The rear corner radar or the area near the rear corner radar is blocked by a vehicle, wall, or pillar.
- The temperature near the rear corner radar is very hot or cold.
- You are driving on an entrance/exit ramp or through a tollbooth.
- The road pavement (or the ground near your vehicle) contains metallic components (i.e. possibly due to subway construction).

- There is a fixed object near the vehicle, such as sound barriers, guardrails, central dividers, entry barriers, streetlights, signs, tunnels, walls, etc. (including double structures)
- You are driving on a narrow road where trees or grass are overgrown.
- You are driving on a narrow road where trees or grass are overgrown.
- You are driving in large, open areas where there are few vehicles or structures (e.g. desert, meadow, empty parking lot).
- The other vehicle drives very close behind your vehicle, or passes by your vehicle in close proximity.
- The speed of the other vehicle is so fast that it passes by your vehicle in a short time.
- Your vehicle passes another vehicle.
- Your vehicle changes lane.
- Your vehicle has started at the same time as the vehicle next to you and has accelerated.
- The vehicle in the next lane moves two lanes away from you, or the vehicle moves two lanes away to the next lane.
- A trailer or hitch mounted carrier is installed and it blocks the rear corner radar.
- The area near the rear corner radar is covered with objects, such as bumper sticker, bumper guard, bike rack, etc.
- The bumper around the rear corner radar has been damaged or modified, and the radar is out of position.
- Your vehicle height is lower or higher than normal due to heavy loads, abnormal tire pressure, etc.

Blind-Spot Collision-Avoidance Assist may not operate normally or may operate unexpectedly when the following objects are detected:

- A motorcycle or bicycle.
- A vehicle such as a flat trailer.

- A big vehicle such as a bus or truck.
- A moving obstacle such as a pedestrian, animal, shopping cart, or baby stroller.
- A vehicle with lower height, such as sports car.

Blind-Spot Collision-Avoidance Assist may not assist braking when:

- Your vehicle severely vibrates while driving over a bumpy road, uneven road, or concrete patch.
- You are driving on a slippery surface due to snow, water puddle, ice, etc.
- The tire pressure is low or a tire is damaged.
- The braking system is adjusted differently from the factory default settings.
- Your vehicle makes abrupt lane changes.

### **WARNING**

- **Driving on curves**



Blind-Spot Collision-Avoidance Assist may not detect a vehicle in an adjacent lane when driving on curves and may not activate a warning or brake your vehicle.

Always check road conditions, and if necessary, take appropriate actions to drive safely.



Blind-Spot Collision-Avoidance Assist may detect a vehicle in the same lane when driving on curves and activate a warning and brake your vehicle.

Always check road conditions, and if necessary, take appropriate actions to drive safely.

- **Driving on hills**



Blind-Spot Collision-Avoidance Assist may not detect a vehicle in an adjacent lane or may incorrectly detect the ground or another object when driving on hills and activate a warning or brake your vehicle.

Always check road conditions, and if necessary, take appropriate actions to drive safely.

- **Driving where the road is merging/dividing**

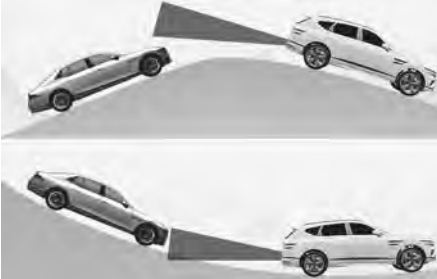

Blind-Spot Collision-Avoidance Assist may not detect a vehicle in an adjacent lane when the road merges or divides, and may not activate a warning or brake your vehicle.

Always check road conditions, and if necessary, take appropriate actions to drive safely.

- **Driving where the heights of the lanes are different**



Blind-Spot Collision-Avoidance Assist may not operate properly when driving where the heights of the lanes are different. The system may not detect a vehicle on a road with a different lane height (underpass joining section, grade separated intersections, etc.) and not activate a warning or brake your vehicle.

Always check road conditions, and if necessary, take appropriate actions to drive safely.

### **WARNING**

- Always turn off Blind-Spot Collision-Avoidance Assist when towing a trailer or using a hitch mounted carrier.
- Blind-Spot Collision-Avoidance Assist may not operate normally if there is interference from strong electromagnetic waves.
- Blind-Spot Collision-Avoidance Assist may not operate for 3 seconds right after your vehicle is started or when the rear corner radars are initialized.

### **Information**

This device complies with Part 15 of the FCC rules.

Operation is subject to the following three conditions:

- This device may not cause harmful interference, and
- This device must accept any interference received, including interference that may cause undesired operation.
- Changes or modifications not expressly approved by the party responsible for compliance could void the user's authority to operate the device.

## *i* Information

Radio frequency radiation exposure information:

This equipment complies with FCC radiation exposure limits set forth for an uncontrolled environment.

This equipment should be installed and operated with minimum distance of 8 in. (20 cm) between the radiator (antenna) and your body.

This transmitter must not be co-located or operating in conjunction with any other antenna or transmitter.

## Safe Exit Assist (SEA)

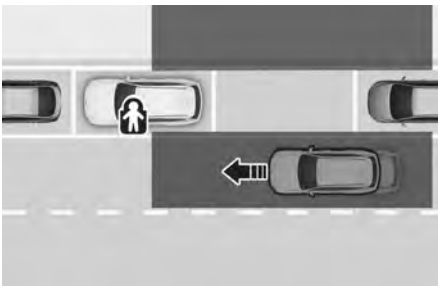

Safe Exit Assist helps detect a vehicle approach the rear corner of your vehicle, after the vehicle is stopped and a passenger opens a door.

Safe Exit Assist may warn you with an audible warning and a warning message to help avoid a collision.



In addition, if an approaching vehicle from the rear area is detected, Safe Exit Assist prevents the doors from opening in the following situation:

- When the electronic child safety lock (🔒) button is in the LOCK position and an approaching vehicle from the rear area is detected, the electronic child safety lock button does not unlock even if the button is pressed to prevent the rear doors from opening.

## ⚠ CAUTION

The warning timing may differ depending on the speed of the detected vehicle.

Do not use Safe Exit Assist instead of the electronic child safety lock button. To protect rear seat passengers, use the electronic child safety lock button.

For more information, refer to the "Electronic Child Safety Lock" section in chapter 5.

## Safe Exit Assist Settings

### Safe Exit Assist

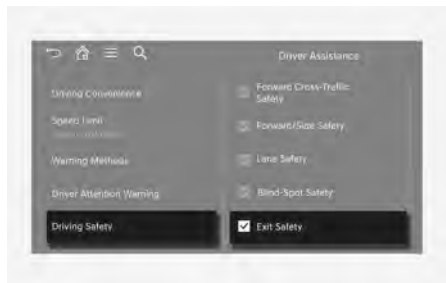

With the engine on, select **Setup > Vehicle > Driver Assistance > Driving Safety > Exit Safety** from the Settings menu in the infotainment system to turn on Safe Exit Assist and deselect to turn off the function.

## WARNING

Always be aware of the surroundings. If **Exit Safety** is deselected, the function does not assist you.

## *i* Information

When the engine is restarted, Safe Exit Assist maintains the last setting.

## Warning methods



With the engine on, select **Setup > Vehicle > Driver Assistance > Warning Methods** from the Settings menu in the infotainment system to select the following:

- **Warning Volume:** The warning volume can be adjusted. If you set the warning volume to '0', the warning volume does not turn off but sounds as '1'.
- **Driving Safety Priority:** Your vehicle lowers all other audio volumes when the Driver Assistance system warning sounds.

## *i* Information

- If you change the warning methods, the warning methods of other Driver Assistance systems may change.
- When the engine is restarted, the warning methods maintains its last setting.

## Safe Exit Assist Operation

### Collision warning when exiting your vehicle

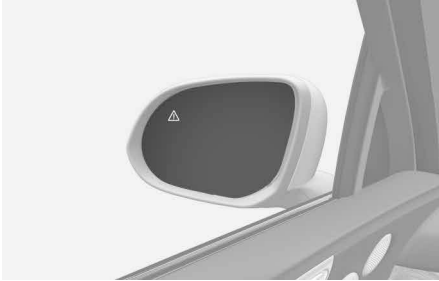

When an approaching vehicle from the rear is detected while a door is being opened, the warning light on the side view mirror may blink, the **"Collision Warning"** warning message may appear on the instrument cluster, and an audible warning may sound.

- Safe Exit Assist may warn you when your vehicle speed is below 2 mph (3 km/h), and the speed of the vehicle approaching the rear of your vehicle is above 4 mph (6 km/h).

### Safe Exit Assist linked with Electronic child safety lock



When Electric child safety lock is operating and an approaching vehicle from the rear area is detected, the rear doors cannot be unlocked even if you try to unlock the rear doors using the electronic child safety lock button. The warning light on the side view mirror may blink and the **"Check traffic in the blind spot, then try again"** warning message may appear on the instrument cluster.

- Safe Exit Assist may warn you when vehicle speed is below 2 mph (3 km/h) and the speed of the vehicle approaching the rear of your vehicle is above 4 mph (6 km/h).

### *i* Information

For more information on electric child safety lock (🔒) button, refer to the "Electronic Child Safety Lock" section in chapter 5.

### CAUTION

If you press the electronic child lock (🔒) button again within 10 seconds after the warning message appears, Safe Exit Assist judges that the driver has unlocked the doors acknowledging the rear status. The electronic child safety lock turns off (button indicator OFF) and the rear doors unlock. Always check the surroundings before turning off the electronic child safety lock button.



## *i* Information

If a rear door is opened from the outside, it opens regardless of Safe Exit Assist operation.

## WARNING

Safe Exit Assist may not operate in all situations and cannot avoid all collisions.

To prevent serious injury or death:

- Always check the surroundings before you or your passengers exit your vehicle.
- Only change the settings after parking your vehicle at a safe location.
- When other system's warning message appears or audible warning is heard, Safe Exit Assist may not warn you.
- You may not hear the audible warning of Safe Exit Assist if the surrounding environment is too noisy.
- Safe Exit Assist may stop operating, or may not operate, or operate unnecessarily depending on the road conditions and surroundings.

## *i* Information

- After the engine is turned off, Safe Exit Assist may detect approaching vehicles for up to 3 minutes, but does not function after the doors are locked.
- The images and colors in the instrument cluster may differ depending on the cluster type or theme selected from the settings menu.

## Safe Exit Assist Malfunction And Limitations

### *Safe Exit Assist malfunction*



When Safe Exit Assist is not working properly, the "**Check Driver Assistance system.**" warning message may appear for several seconds, and the  warning light may illuminate on the instrument cluster. Have your vehicle inspected by an authorized retailer of Genesis Branded products.



When the side view mirror warning light is not working properly, the "**Check side view mirror warning light.**" warning message may appear for several seconds, and the  warning light may illuminate on the instrument cluster. Have your vehicle inspected by an authorized retailer of Genesis Branded products.

### Safe Exit Assist disabled



If the rear corner radar is blocked or covered, or when the rear bumper around the rear corner radar or sensor is covered by any foreign material, such as snow, rain, or dirt, or when a trailer or hitch mounted carrier is installed, the detecting performance may decrease and temporarily limit or disable Safe Exit Assist.

The "**Driver Assistance system limited. Radar blocked.**" warning message may appear on the instrument cluster.

The function operates normally when such foreign material, trailer, or carrier is removed, and the engine is restarted.

If Safe Exit Assist does not operate normally after anything covering or blocking the sensors is removed, have your vehicle inspected by an authorized retailer of Genesis Branded products.

#### **WARNING**

- Safe Exit Assist may not operate properly even if there is no warning message or warning light on the instrument cluster.
  - Safe Exit Assist may not operate properly in open areas where no objects are detected (e.g. empty parking lot) or when the detecting sensors are blocked right after turning on the engine.
  - Always turn off Safe Exit Assist when towing a trailer or using a hitch mounted carrier.
- 

### Detecting sensors

Refer to the "Driver Assistance System Sensors" section in this chapter for the location and the general precautions of the rear corner radar.

### Limitations of Safe Exit Assist

Safe Exit Assist may not operate normally, or may operate unexpectedly if:

- Trees or grass near your vehicle are overgrown.
- The road is wet.
- The approaching vehicle is very fast or slow.

#### **Information**

For more information on the limitations on the rear corner radar, refer to the "Driver Assistance System Sensors" section in this chapter.

---

#### **WARNING**

- Safe Exit Assist may not operate properly if there is interference from strong electromagnetic waves.
  - Safe Exit Assist may not operate for 3 seconds right after your vehicle is started or when the rear corner radars are initialized.
-

## Manual Speed Limit Assist (MSLA)



- (1) Speed Limit indicator  
(2) Set speed

If you drive over the preset speed limit, Manual Speed Limit Assist operates (set speed limit blinks and chime sounds) until the vehicle speed returns within the speed limit.

## Manual Speed Limit Assist Operation

### Setting speed limit

1. Press and hold the Driving Assist (LD) button at the desired speed. The Speed Limit (LIMIT) indicator light illuminates on the instrument cluster.



2. Push the **+** switch up or **-** switch down, and release it at the desired speed.

Push the **+** switch up or **-** switch down to change the set speed.

Push and hold to increase or decrease to the nearest multiple of five (multiple of ten in km/h), and then increase or decrease by 10 km/h (5 mph).



3. Check the set speed limit on the instrument cluster.

- If you want to drive over the set speed limit, depress the accelerator pedal far enough to activate the kickdown mechanism.
- The set speed limit blinks and chime sounds until your vehicle speed decreases below the set speed.

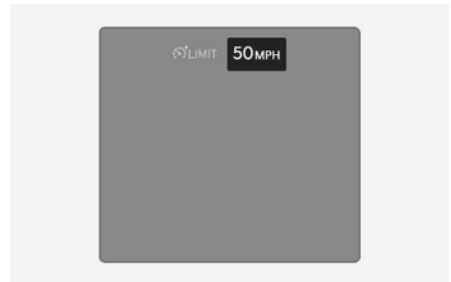

### *i* Information

When the accelerator pedal is not depressed beyond the pressure point, your vehicle speed maintains within the speed limit.

### Temporarily pausing Manual Speed Limit Assist



Press the  switch to temporarily cancel the set speed limit. The set speed limit turns off, but the Speed Limit (SPEED LIMIT) indicator light stays on.

### Resuming Manual Speed Limit Assist

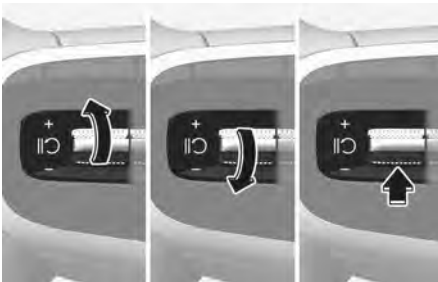

Push the **+**, **-**, or  switch.

If you push the **+** switch up or **-** switch down, the set speed is set to the current speed.

If you press the  switch, the vehicle speed resumes to the previously set speed limit.

### Turning off Manual Speed Limit Assist



Press the Driving Assist (DRIVING ASSIST) button to turn off Manual Speed Limit Assist. The Speed Limit (SPEED LIMIT) indicator off.

Always press the Driving Assist (DRIVING ASSIST) button to turn off Manual Speed Limit Assist when not in use.

### WARNING

To prevent serious injury or death:

- Set your vehicle speed to the speed limit for the road in your area.
- Keep Manual Speed Limit Assist off when not in use, to avoid unintentionally setting a speed. Check that the Speed Limit (SPEED LIMIT) indicator light is off.
- Always drive defensively and pay attention to the driving task.

## Intelligent Speed Limit Assist (ISLA)

Intelligent Speed Limit Assist uses information from the detected road sign and navigation system to inform you of the speed limit and additional information, and help maintain within the speed limit on the road.

### ⚠ CAUTION

- Intelligent Speed Limit Assist may not operate properly if used in other countries.
- Intelligent Speed Limit Assist may not operate properly if the navigation system is not updated regularly.

## Intelligent Speed Limit Assist Settings

### Speed limit

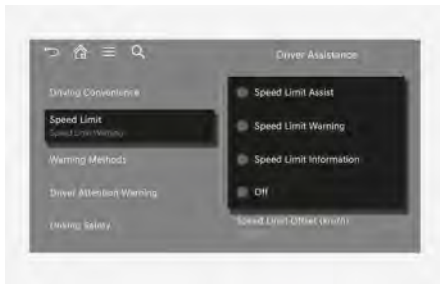

With the engine on, select **Setup > Vehicle > Driver Assistance > Speed Limit** from the Settings menu in the infotainment system to select the following:

- **Speed Limit Offset:** The Speed Limit Offset can be changed. Speed Limit Warning and Speed Limit Assist operate by applying the Speed Limit Offset setting to the detected speed limit.

- **Speed Limit Assist:** Intelligent Speed Limit Assist informs you of the speed limit and additional road signs. The function informs you to change the set speed of Manual Speed Limit Assist or Smart Cruise Control if needed.
- **Speed Limit Warning:** Intelligent Speed Limit Assist informs you of the speed limit and additional road signs. The function warns you when your vehicle has been driven faster than the speed limit.
- **Speed Limit Information:** Intelligent Speed Limit Assist informs you of the speed limit and additional road signs.
- **Off:** Intelligent Speed Limit Assist turns off.

### ⚠ WARNING

- Only change the settings after parking your vehicle at a safe location.
- Speed Limit Assist operates based on the Speed Limit Offset setting added to the speed limit. If you want to change the adjusted speed according to the speed limit, adjust the offset to 0.
- The setting of the Speed Limit Offset is not reflected in Navigation-based Smart Cruise Control.

## Intelligent Speed Limit Assist Operation

### Displaying speed limit



Speed limit information is displayed on the instrument cluster.

### **i** Information

- If speed limit information of the road cannot be recognized, '---' appears.
- Intelligent Speed Limit Assist provides additional road sign information in addition to speed limit information. Additional road sign information provided may differ depending on your country.
- Supplementary signs appear under the speed limit or overtaking restriction sign. If a supplementary sign is not recognized, it appears as blank.
- The images and colors in the instrument cluster may differ depending on the cluster type or theme selected from the instrument cluster.

### Warning overspeed



When driving at a speed higher than the displayed speed limit, the speed limit is blinking in red and the warning sounds.

### Changing set speed



If the speed limit changes when using Manual Speed Limit Assist or Smart Cruise Control, an arrow in the direction of up or down appears to inform you to change the set speed by pushing the **+** or **-** switch.

You can change the set speed according to the speed limit by using the **+** or **-** switch.

### Set speed auto change



Manual Speed Limit Assist or Smart Cruise Control assists you to adjust the vehicle speed according to the speed limit. When the set speed is same as the speed limit, the set speed automatically changes to the current speed limit if the speed limit changes. The function operates on the road which has a speed limit of 44 mph (70 km/h) or higher. When the function is active, the set speed on the instrument cluster appears in green.

### WARNING

- If necessary, reduce your driving speed as needed. Even after changing the set speed according to the speed limit for the road, your vehicle can still be driven over the speed limit.
- If the speed limit for the road is under 20 mph (30 km/h), the set speed changing function does not work.
- Intelligent Speed Limit Assist operates using the speed unit set by you from the settings menu. If the speed unit is set to a unit other than the speed unit used in your country, Intelligent Speed Limit Assist may not operate properly.



### *i* Information

- For more information on Manual Speed Limit Assist operation, refer to the "Manual Speed Limit Assist (MSLA)" section in this chapter.
- For more information on Smart Cruise Control operation, refer to the "Smart Cruise Control (SCC)" section in this chapter.

## Intelligent Speed Limit Assist Malfunction And Limitations

### *Intelligent Speed Limit Assist malfunction*





When Intelligent Speed Limit Assist is not working properly, the "**Check Driver Assistance system**" warning message may appear on the instrument cluster for several seconds, and the  and  warning lights may illuminate on the instrument cluster. Have your vehicle inspected by an authorized retailer of Genesis Branded products.

### **Intelligent Speed Limit Assist disabled**



If the front view camera is covered or blocked, its detecting performance is reduced, and Intelligent Speed Limit Assist is temporarily limited or disabled.

The "**Driver Assistance system limited. Camera blocked**" warning message may appear, and the  and  warning light may illuminate on the instrument cluster.

The function operates normally when such foreign material is removed, and the engine is restarted.

If Intelligent Speed Limit Assist does not operate normally after the sensor has been uncovered or unblocked, have your vehicle inspected by an authorized retailer of Genesis Branded products.

#### **WARNING**

- Intelligent Speed Limit Assist may not operate properly even if there is no warning message or warning light on the instrument cluster.
- If the vehicle is turned off and restarted while the camera is blocked or malfunctioned, the condition is maintained and may not operate properly.

#### **Detecting sensors**

Refer to the "Driver Assistance System Sensors" section in this chapter for the location and the general precautions of the front view camera.

### **Limitations of Intelligent Speed Limit Assist**

Intelligent Speed Limit Assist may not operate or may be limited if:

- The road sign is damaged, difficult to see due to rain, snow, fog, dirt, sand, oil, etc., or obscured by surrounding objects or shadows.
- The road signs do not conform to the standard designs in your country.
  - The text or picture on the road sign is different from the standard designs in your country.
  - The road sign is installed between the main road and exit road or between diverging roads.
  - A sign is attached to another vehicle.
- The distance between the driving lane and road sign is far.
- There are LED road signs.
- The numbers or pictures in the road sign is incorrectly recognized as the speed limit.
- Road signs on adjacent roads are incorrectly recognized as road signs you are driving on.
- Supplementary road signs or signboards are installed near the road sign.
- Multiple signs are installed close together.
- A minimum speed limit sign is incorrectly recognized as the maximum speed limit sign.
- The brightness changes suddenly, for example when entering or exiting a tunnel or passing under a bridge.
- Headlamps are not used, or the brightness of the headlamps are weak at night or in the tunnel.
- Road signs are difficult to recognize due to the reflection of sunlight, streetlights, or oncoming vehicles.
- The driver is driving on a new road that is not in the navigation system yet.



- The front view camera's field of view is obstructed by glare from the sun.
- You are driving on a road that is sharply curved or continuously curved.
- You are driving through speed bumps, or driving up and down, or left to right on steep inclines.
- Your vehicle is shaking heavily.
- You are driving your vehicle on a newly opened road.
- There is an error in the navigation map data or GPS data.
- You are not driving your vehicle based on the route guidance.
- The navigation system is being updated or restarted while driving.

### WARNING

- Intelligent Speed Limit Assist may not display the correct speed limit or may not properly control the driving speed because it is a supplemental function to inform you of the speed limit on the road.
- Set your vehicle speed to the speed limit for the road in your area.
- Intelligent Speed Limit Assist may not operate for 15 seconds right after your vehicle is started or when the front view camera is initialized.

### Information

For more information on the limitations of the front view camera, refer to the "Driver Assistance System Sensors" section in this chapter.

## Driver Attention Warning (DAW)

### *Inattentive driving warning function*

Driver Attention Warning monitors your driving pattern while driving. When the attention level is below a certain level recommends a break.

### *Leading vehicle departure alert function*

Leading Vehicle Departure Alert function informs you when a detected vehicle in front departs from a stop.

## Driver Attention Warning Settings

### *Leading vehicle departure alert*

With the engine on, select **Setup > Vehicle > Driver Assistance > Driver Attention Warning** and then enable **Leading Vehicle Departure Alert** in the infotainment system to use the function.

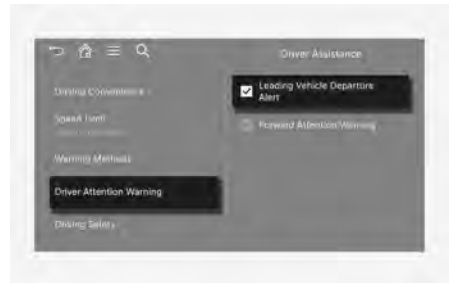

If **Leading Vehicle Departure Alert** is selected, the function informs you when a detected vehicle in front departs from a stop.

## Driver Attention Warning Operation

### Inattentive driving warning function

#### Taking a break



The "**Consider taking a break**" message may appear and the  warning light may blink on the instrument cluster and an audible warning may sound, when the attention level is below a certain level.

- Driver Attention Warning does not suggest a break if the total driving time is less than 4 minutes or 4 minutes has not passed since the last break was suggested.

#### **WARNING**

Only change the settings after parking your vehicle at a safe location.

#### **CAUTION**

- Driver Attention Warning may suggest a break depending on your driving pattern or habit, even if you do not feel fatigued.
- Driver Attention Warning is a supplemental function only and does not determine if you are paying attention to the driving task.
- If you feel fatigued or want to take a break, do so as needed at a safe location.

### Leading Vehicle Departure Alert function



When a detected vehicle in front departs from a stop, Leading Vehicle Departure Alert displays the "**Leading vehicle is driving away**" message on the instrument cluster and an audible warning sounds.

#### **WARNING**

- When other system's warning message appears or audible warning is heard, Leading Vehicle Departure Alert may not alert you.
- Always check road conditions, and if necessary, take appropriate actions to drive safely. It is your responsibility to operate your vehicle in a safe manner.

#### **CAUTION**

- Leading Vehicle Departure Alert is a supplemental function and may not alert you whenever the front vehicle departs from a stop.
- Always check your surroundings before driving even if the function alerts you that the front vehicle has departed.



#### **Information**

The images and colors in the instrument cluster may differ depending on the cluster type or theme selected from the settings menu.

## Driver Attention Warning Malfunction And Limitations

### *Driver Attention Warning malfunction*





When Driver Attention Warning is not working properly, the "**Check Driver Assistance system.**" warning message may appear for several seconds, and the  and  warning lights may illuminate on the instrument cluster. Have your vehicle inspected by an authorized retailer of Genesis Branded products.

### *Driver Attention Warning disabled*



If the front view camera is covered or blocked, its detecting performance is reduced, and Driver Attention Warning may be temporarily limited or disabled.

The "**Driver Assistance system limited. Camera blocked**" warning message may appear, and the  and  warning lights may illuminate on the instrument cluster.

The function operates normally when such foreign material is removed, and the engine is restarted.

If Driver Attention Warning does not operate normally after the sensor has been uncovered or unblocked, have your vehicle inspected by an authorized retailer of Genesis Branded products.

### **WARNING**

- Driver Attention Warning may not operate properly in open areas where no objects are detected (e.g. empty parking lot) or when the detecting sensors are blocked right after turning on the engine.
- If the vehicle is turned off and restarted while the camera is blocked or malfunctioned, the condition is maintained and may not operate properly.

### **Detecting sensors**

Refer to the "Driver Assistance System Sensors" section in this chapter for the location and the general precautions of front view camera.

### **Limitations of Driver Attention Warning**

Driver Attention Warning may not work properly if:

- Your vehicle is driven aggressively or steered sharply from side to side.
- Your vehicle intentionally changes lanes frequently.
- Another Driver Assist system such as Lane Keeping Assist, is maintaining your vehicle's position within the lane.

Leading vehicle departure alert feature

- When the vehicle cuts in

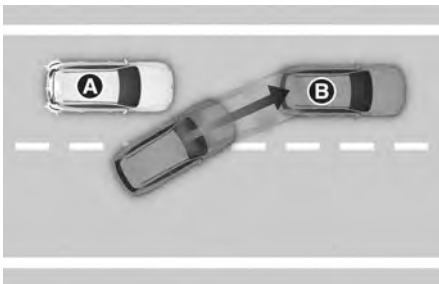
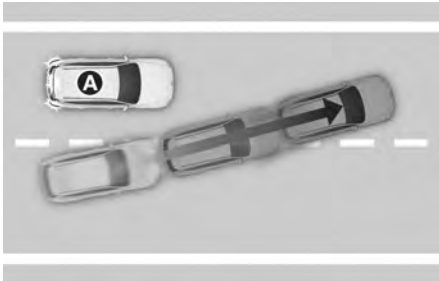

[A] Your vehicle  
[B] Front vehicle

If a vehicle cuts in front of your vehicle, Leading Departure Alert may not operate properly.

- When the vehicle ahead sharply steers

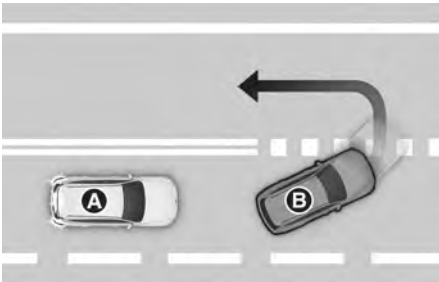

[A] Your vehicle  
[B] Front vehicle

If the vehicle in front makes a sharp turn, such as to turn left or right or make a U- turn, etc., Leading Vehicle Departure Alert may not operate properly.

- When the vehicle ahead abruptly departs

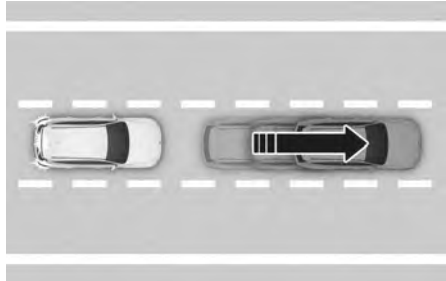

If the vehicle in front abruptly departs, Leading Vehicle Departure Alert may not operate properly.

- When a pedestrian or bicycle is between you and the vehicle ahead



If there is a pedestrian(s) or bicycle(s) in between you and the vehicle in front, Leading Vehicle Departure Alert may not operate properly.

- **When in a parking lot**

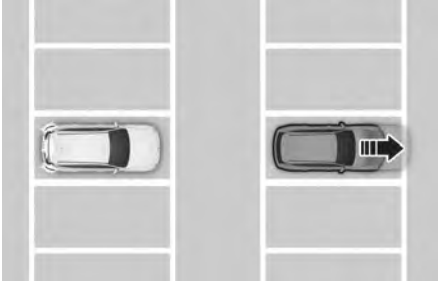

If a vehicle parked in front drives away from you, Leading Vehicle Departure Alert may alert you that the parked vehicle is driving away.

- **When driving at a tollbooth or intersection, etc.**

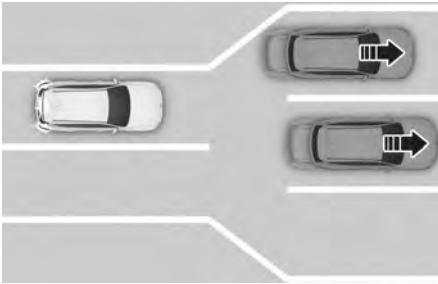

If you pass a tollbooth or intersection with lots of vehicles or you drive where lanes are merged or divided frequently, Leading Vehicle Departure Alert may not operate properly.

### **WARNING**

Driver Attention Warning may not operate for about 15 seconds right after your vehicle is started or when the front view camera is initialized.

### **Information**

For more information on the precautions of the front view camera, refer to the "Driver Assistance System Sensors" section in this chapter.

## Forward Attention Warning (FAW)

 if equipped

Forward Attention Warning uses the in-cabin camera to help prevent the driver from being distracted while driving with an audible warning and warning light.

### Forward Attention Warning Settings

#### Forward attention warning

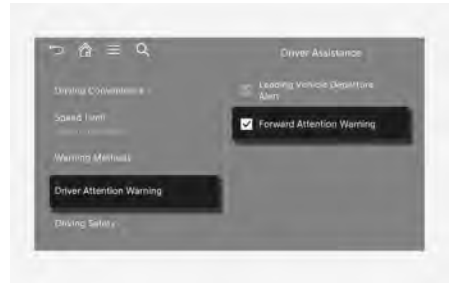

With the engine on, select **Setup > Vehicle > Driver Assistance > Driver Attention Warning** from the Settings menu in the infotainment system to select the following:

- If **Forward Attention Warning** is enabled, the function warns the driver when the driver's gaze is not focused on the road.

### **i** Information

When the engine is restarted, Forward Attention Warning maintains its last setting.

---

## **Forward Attention Warning Operation**

### **Forward Attention Warning**

Forward Attention Warning determines whether the driver is focused on the road depending on information, such as the amount of time the driver is looking elsewhere, the amount of time the eyes are closed, etc. If Forward Attention Warning judges the driver is not focused, an audible warning sounds for about 1 second, and the  warning light illuminates on the cluster until off conditions are met.

#### **The warning comes on:**

- When the driver's gaze is not focused on the road continuously for 3 seconds while driving above 12 mph (20 km/h).
- When the driver's gaze is not focused on the road for 10 seconds or more in total during a 30 seconds time span while driving above 12 mph (20 km/h).
- When the driver's eyes are closed for over 2 seconds or more while driving above 6 mph (10 km/h).

#### **The warning goes off:**

When the driver looks forward continuously for over 2 seconds.

### **! WARNING**

If any other system's warning message is displayed or audible warning is generated, Forward Attention Warning's warning message may not be displayed and an audible warning may not be generated.

---

### **! CAUTION**

- Forward Attention Warning may warn the driver even though the driver is focused on the road because of driving style and driving pattern.
  - Forward Attention Warning is a supplemental function and may not determine whether the driver is distracted while driving.
  - The driver is responsible for safe driving and must focus on the road.
- 

### **i** Information

- Forward Attention Warning does not transmit recorded videos outside of the vehicle or store the video.
  - The Warning Method for Forward Attention Warning cannot be changed.
-

## Forward Attention Warning Malfunction And Limitations

### *Forward Attention Warning malfunction*



When Forward Attention Warning is not working properly, the "**Check Forward Attention Warning system**" warning message appears on the instrument cluster for several seconds, the  warning light illuminates on the instrument cluster, and an audible warning sounds. Have your vehicle inspected by an authorized retailer of Genesis Branded products.

### *Forward Attention Warning disabled*



If there is an object right in front of the in-cabin camera or between you and the camera for a certain period of time Forward Attention Warning does not operate properly.

The "**Forward Attention Warning disabled. Camera obscured.**" warning message appears on the instrument cluster for several seconds, the  warning light illuminates on the instrument cluster, and an audible warning sounds.

If the object is removed or the camera is able to detect the your face, the function operates normally.

If Forward Attention Warning does not operate properly after the object is removed, have your vehicle inspected by an authorized retailer of Genesis Branded products.

### *Limitations of Forward Attention Warning*

Forward Attention Warning may not operate normally, or it may operate unexpectedly if:

- You wear sunglasses, special glasses, infrared cutoff glasses, refracting glasses or thick glasses.
- You have heavy eye makeup (eyeliner, mascara, color makeup, false eyelash) or eye piercing.
- Your view is blocked by hair, hat, etc.
- You are winking or wearing an eye patch on one eye.
- Your face is covered partially by a mask, muffler, etc.
- Your view is blocked by incoming light from outside of the vehicle.
- Light from outside, sunlight or infrared LED light of the camera is reflected by glasses or sunglasses.
- You have turned or lowered your head so that your face or an eye is hidden from the camera.
- You shake your head up and down, or adverse road conditions cause excessive vehicle vibrations while driving.

- You are improperly positioned in the your seat so that the your face is not detected.
- You are too tall or short.
- The camera is blocked by the your grip on the steering wheel.
- More than two people are looking at the instrument cluster simultaneously from the driver's seat.
- Squinting due to laughing or sun glare.
- A picture or mannequin that has a similar size to your face is misrecognized.
- There are other devices using infrared light in the vehicle.



[A] In-cabin camera

- Do not impact the surface of the camera or around the camera. If the in-cabin camera is damaged, Forward Attention Warning may not work properly.
- Do not place anything on the camera or in front of the camera while driving. The in-cabin camera may not operate properly.
- When cleaning the camera, wipe with a soft and clean cloth to prevent damages on the surface of the camera lens. In addition, you should not use sharp tools near the camera, or use chemicals to clean the camera.
- Always keep the camera and around the area of the in-cabin camera clean and dry.

- Do not apply foreign objects, such as a sticker, around the infrared LED located near the camera.

### *i* Information

Two red lights may appear on the camera in the following conditions when:

- The outside brightness is dim or driving at night.
- The vehicle drives inside a building, such as a basement parking lot, garage or tunnel.
- The camera case is partially broken.

### WARNING

Do not look toward the camera within 8 in. (20 cm) for longer than a minute.



## Blind-Spot View Monitor (BVM)

 if equipped



Blind-Spot View Monitor uses the wide-side view cameras to display the rear blind spot areas of your vehicle on the instrument cluster when the turn signal is turned on to help with safe lane changes.

## Blind-Spot View Monitor Settings

### Setting features

With the engine on, select **Setup > Vehicle > Driver Assistance > Driving Safety** and then enable **Blind-Spot View Monitor** from the Setting menu in the infotainment system to turn on the Blind-Spot View Monitor.

## Blind-Spot View Monitor Operation

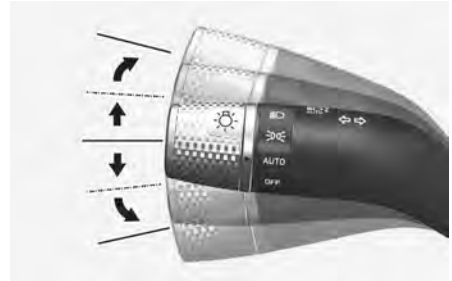

### Turns on if:

The left or right side turn signal turns on, and the corresponding side view camera image appears on the instrument cluster.

### Turns off if:

- The turn signal turns off.
- The hazard warning flasher is on. Blind-Spot View Monitor turns off, independent of the turn signal status.
- Other warnings on the instrument cluster may replace the side view camera image when changing lanes.

## Blind-Spot View Monitor Malfunction

When Blind-Spot View Monitor is not working properly, or the cluster display flickers, or the camera image does not display properly, have your vehicle inspected by an authorized retailer of Genesis Branded products.

### **WARNING**

- The image shown on the cluster may differ from the actual distance of the object. Make sure to directly check the vehicle's surroundings for safety.
- Always keep the camera lens clean. If the lens is blocked or covered, Blind-Spot View Monitor may not operate normally. Do not clean with strong chemicals containing high alkaline or volatile organic solvents (e.g. gasoline, acetone).

### *Detecting sensors*

Refer to the "Driver Assistance System Sensors" section in this chapter for the location and the general precautions of the wide-side view camera.

## Smart Cruise Control (SCC)

Smart Cruise Control helps detect a vehicle ahead and maintain the desired speed and distance between your vehicle and the vehicle ahead.

### Overtaking Acceleration Assist

While Smart Cruise Control is operating, if the function judges you are attempting to overtake a vehicle in front, Smart Cruise Control accelerates your vehicle to assist you with this maneuver.

### Based on Driving Style

 **if equipped**

Smart Cruise Control operates based on the driver's driving style, such as vehicle distance, acceleration, and reaction speed.

## Smart Cruise Control Settings

### *Smart Cruise Control*



With the engine on, select **Setup > Vehicle > Driver Assistance > Driving Convenience > Smart Cruise Control** from the Settings menu in the infotainment system to adjust **Distance**, **Acceleration**, and **Response Speed** manually.

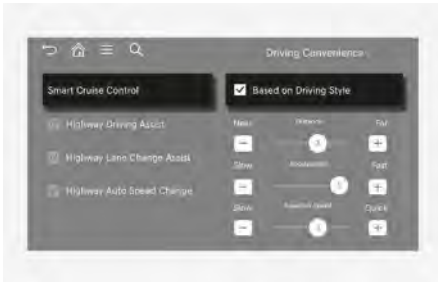

## Based on Driving Style

 if equipped



With the engine on, if **Setup > Vehicle > Driver Assistance > Driving Convenience > Smart Cruise Control > Based on Driving Style** is selected from the Settings menu, Smart Cruise Control operates based on your driving style, such as vehicle distance, acceleration, and reaction speed.

### *i* Information

- While Smart Cruise Control is operating with **Based on Driving Style** selected, if you press and hold the Vehicle Distance () button, **Based on Driving Style** deactivates. If you press and hold the Vehicle Distance () button again, **Driving Style Setting** activates.
- Based on Driving Style setting continuously learns your driving style when the vehicle is being driven.
- When **Based on Driving Style** is deactivated, the driving style such as vehicle distance, acceleration, and reaction speed maintains in the same stage.

## Warning methods



With the engine on, select **Setup > Vehicle > Driver Assistance > Warning Methods** from the Settings menu in the infotainment system to select the following:

- **Warning Volume:** The warning volume can be adjusted. If you set the warning volume to '0', the warning volume does not turn off but sounds as '1'.
- **Haptic Warning:** The steering wheel vibration can be set.
- **Driving Safety Priority:** Your vehicle lowers all other audio volumes when the Driver Assistance system warning sounds.

### *i* Information

- If you change the warning methods, the warning methods of other Driver Assistance systems may change.
- If you turn off the haptic warning when the warning volume is '0', the warning volume does not turn off but sounds as '1'.
- If you set the warning volume to '0' when the haptic warning is off, the haptic warning turns on.
- When the engine is restarted, the warning methods maintains its last setting.
- The setting menu may not be available for your vehicle depending on the vehicle features and specifications.

## Smart Cruise Control Operation

### Operating conditions

#### Basic function

Smart Cruise Control operates when the following conditions are met:

- The gear is in D (Drive)
- Your vehicle speed is within the operating speed range.
  - 5-124 mph (10-200 km/h): when there is no vehicle in front
  - 0-124 mph (0-200 km/h): when there is a vehicle in front
- ESC (Electronic Stability Control) or ABS is enabled.

Smart Cruise Control does not operate when:

- The driver's door is opened.
- Engine RPMs are in the red zone.
- EPB (Electronic Parking Brake) is applied.
- ESC (Electronic Stability Control) or ABS is controlling your vehicle.
- Forward Collision-Avoidance Assist braking control is operating.
- Remote Smart Parking Assist brake control is operating (if equipped)
- Idle Stop and Go (ISG) system is operating. (if equipped)

### Information

If stopped behind another vehicle, you have to depress the brake pedal to turn on Smart Cruise Control.

---

### Operating conditions for Acceleration Assist

Overtaking Acceleration Assist operates when the turn signal indicator is turned on to the left while Smart Cruise Control is operating, and the following conditions are met:

- Your vehicle speed is above 40 mph (60 km/h).
- A vehicle is detected in front of your vehicle.

Overtaking Acceleration Assist does not operate when:

- The hazard warning flasher is on.
- Deceleration is needed to maintain the distance from the vehicle in front.

### WARNING

- Be careful when your vehicle temporarily accelerates to overtake a vehicle in front.
  - Overtaking Acceleration Assist operates when the conditions are met, even if you are using the function in countries with different driving direction.
-

### Turning on Smart Cruise Control



- Press the Driving Assist button to turn on Smart Cruise Control. The speed is set to the current speed on the instrument cluster.
- If there is no vehicle in front of you, the set speed is maintained.
- If there is a vehicle in front of you, your vehicle speed may be adjusted to maintain the distance from the vehicle ahead.
- If the vehicle ahead accelerates and the distance between vehicles increase, your vehicle accelerates to the set speed, and then travels at a constant speed after your vehicle reaches the set distance.

#### *i* Information

- If your vehicle speed is between 0-20 mph (0-30 km/h) when you press the Driving Assist button, Smart Cruise Control speed is set to 20 mph (30 km/h).
- If you shift from a higher gear to a lower gear using the paddle shifter, the vehicle speed may not accelerate to the set speed.

### Setting vehicle distance



Each time the button is pressed, the vehicle distance changes as follows:

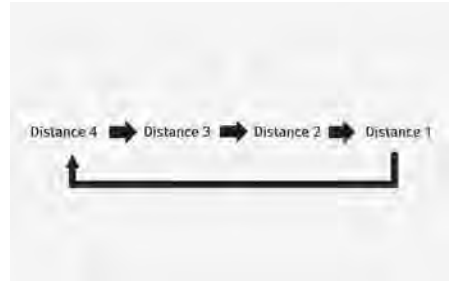

If you drive at 56 mph (90 km/h):

- Distance 4: about 172 ft. (52.5 m)
- Distance 3: about 130 ft. (40 m)
- Distance 2: about 106 ft. (32.5 m)
- Distance 1: about 82 ft. (25 m)

#### *i* Information

When the engine is restarted or Smart Cruise Control is temporarily canceled, the following distance maintains the last setting.

### Increasing set speed



- Push the + switch up and release it immediately to increase the cruising speed by 1 mph (1 km/h).
- Push and hold the + switch up to increase to the nearest multiple of 5 mph (or multiple of 10 km/h) at first, and then increase by an additional 5 mph (10 km/h) each time.
- The speed can be set to a maximum of 120 mph (200 km/h).

#### **WARNING**

Your vehicle speed may rapidly increase when you push and hold the + switch.

### Decreasing set speed



- Push the - switch down and release it immediately to decrease the cruising speed by 1 mph (1 km/h).

- Push and hold the - switch down to decrease to the nearest multiple of 5 mph (or multiple of 10 km/h) at first, and then decrease by 5 mph (10 km/h) each time.
- The speed can be set to a minimum of 20 mph (30 km/h).

### Temporarily canceling Smart Cruise Control

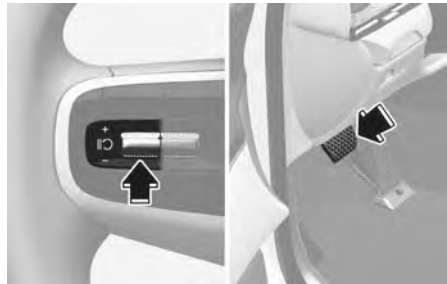

Press the ||O switch or depress the brake pedal to temporarily cancel Smart Cruise Control.

### Resuming Smart Cruise Control

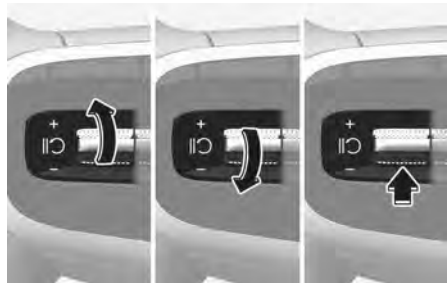

Push the +, -, or ||O switch.

If you push the + switch up or - switch down, your vehicle speed is set to the current speed on the instrument cluster.

If you press the ||O switch, your vehicle speed resumes to the previously set speed.

**⚠ WARNING**

Your vehicle speed may rapidly increase or decrease when you press the  switch.

**Turning off Smart Cruise Control**

Press the Driving Assist () button to turn off Smart Cruise Control.

**i Information**

If your vehicle is equipped with Manual Speed Limit Assist, press and hold the Driving Assist () button to turn off Smart Cruise Control and turn on Manual Speed Limit Assist.

**⚠ CAUTION**

Do not operate multiple buttons or switches simultaneously. Smart Cruise Control may not operate properly.

**Smart Cruise Control display**

The status of the Smart Cruise Control operation appears in Driving Assist view on the instrument cluster. Refer to the "View Modes" section in chapter 4.

Operating



Temporarily canceled



- When operating
  - (1) Displays whether there is a vehicle ahead and the selected distance level appears.
  - (2) Set speed appears.
  - (3) Displays whether there is a vehicle ahead and the target vehicle distance appears.
- When temporarily canceled
  - (1) Your vehicle appears in gray.
  - (2) The previous set speed appears in gray.
  - (3) Displays whether there is a vehicle ahead. If any, it appears in gray. (if equipped)

**i Information**

- The distance from the front vehicle on the instrument cluster appears according to the actual distance between your vehicle and the vehicle ahead.

- The target distance may differ depending on the vehicle speed and the set distance level. If the vehicle speed is low, even though the vehicle distance have changed, the change of the target vehicle distance may be small.
- The images and colors in the instrument cluster may differ depending on the cluster type or theme selected from the settings menu.

### Accelerating temporarily



If you depress the accelerator pedal above a certain speed while Smart Cruise Control is operating, your vehicle can speed up temporarily without changing the set speed. The set speed, distance level, and target distance blink on the instrument cluster while depressing the accelerator pedal. Your vehicle speed may decrease if the accelerator pedal is not depressed far enough.

### **WARNING**

Be careful when accelerating temporarily, because Smart Cruise Control is not controlling the speed and distance even if there is a vehicle in front of you.

Always maintain a safe distance from the vehicles ahead and adjust your vehicle speed depending on the road conditions.

### Based on Driving Style operation

 If equipped



When Based on driving style is operating, the vehicle distance level and target distance appears white based on the driving style.

### Temporarily canceling Smart Cruise Control



Smart Cruise Control is temporarily canceled automatically when:

- Your vehicle speed is over 130 mph (210 km/h).
- Your vehicle is stopped for a certain period of time.
- Your accelerator pedal is continuously depressed for a certain period of time.
- The conditions for the Smart Cruise Control to operate are not met.



If Smart Cruise Control is temporarily canceled automatically, the "**Smart Cruise Control deactivated**" or "**SCC (Smart Cruise Control) canceled**" warning message appears on the instrument cluster, and an audible warning sounds to warn you.

### *i* Information

If Smart Cruise Control is temporarily canceled while your vehicle is at a standstill with the function activated, the Electronic Parking Brake (EPB) may be applied.

### WARNING

Always maintain a safe distance from the vehicles ahead and adjust your vehicle speed to the road conditions. When Smart Cruise Control is temporarily canceled, it is not controlling the speed and distance from the vehicle ahead.

### *Smart Cruise Control conditions not met*



If the Driving Assist button, **+** switch, **-** switch or **||**  switch is operated when Smart Cruise Control operating conditions are not satisfied, the "**Smart Cruise Control conditions not met**" or "**SCC (Smart Cruise Ctrl.) conditions not met**" message appears on the instrument cluster, and an audible warning sounds.

### *In traffic situation*



In traffic, your vehicle stops if the vehicle ahead of you stops. Also, if the vehicle ahead of you starts moving, your vehicle starts moving as well. In addition, after your vehicle has stopped and a certain time have passed, the "**Use switch or pedal to accelerate**" message appears on the instrument cluster. Depress the accelerator pedal or push the **+** switch, **-** switch, or **||**  switch to start driving.

### *Warning road conditions ahead*



The "**Watch for surrounding vehicles**" warning message appears on the instrument cluster, and an audible warning sounds if the vehicle in front disappears when Smart Cruise Control is maintaining the distance from the vehicle ahead while driving below a certain speed.

**! WARNING**

Always pay attention to vehicles or objects that may suddenly appear in front of you. Always maintain a safe distance from the vehicles ahead and adjust your vehicle speed to the road conditions.

**Collision Warning**



While Smart Cruise Control is operating and the collision risk of the vehicle ahead is high, the **"Collision Warning"** warning message appears on the instrument cluster, an audible warning sounds, and the steering wheel vibrates (if equipped).

**! WARNING**

Smart Cruise Control may not warn you of a collision if:

- The distance to the vehicle ahead is close, or the speed of the vehicle ahead is faster or similar to your vehicle.
- The speed of the vehicle ahead is very slow or the vehicle is stopped.
- The accelerator pedal is depressed right after Smart Cruise Control is turned on.
- Always maintain a safe distance from the vehicles ahead and adjust your vehicle speed to the road conditions.

**! WARNING**

Smart Cruise Control is not a substitute for proper and safe driving.

To prevent serious injury or death:

- Always monitor your vehicle speed and the distance to vehicles ahead on the road. Smart Cruise Control is not a substitute for safe driving practices, but a supplemental function only.
- Always maintain a safe distance from the vehicles ahead and adjust your vehicle speed to the road conditions. Smart Cruise Control may not recognize unexpected and sudden situations or complex driving situations.
- Keep Smart Cruise Control off when not in use to avoid inadvertently setting the speed.
- Do not open the door or leave your vehicle when Smart Cruise Control is operating, even if your vehicle is stopped.
- Always check the vehicle speed and distance to the front vehicle that have been selected.
- Keep a safe distance depending on the road condition and vehicle speed. If the distance to the front vehicle is too close while driving at high speeds, it may cause a serious collision.
- When maintaining distance from the vehicle ahead, if the front vehicle is no longer detected, Smart Cruise Control may suddenly accelerate to the set speed.
- The vehicle speed may slow down or speed up while driving uphill or downhill.
- Always be aware of situations such as when a vehicle cuts in suddenly.
- When you are towing a trailer or another vehicle, turn off Smart Cruise Control.

- Turn off Smart Cruise Control when your vehicle is being towed.
- Smart Cruise Control may not operate normally if there is interference from strong electromagnetic waves.
- Smart Cruise Control may not detect obstacles in front and cause a collision.
- Vehicles frequently changing lanes may cause a delay or may cause Smart Cruise Control to react to a vehicle in an adjacent lane.
- When other system's warning message appears or audible warning is heard, Smart Cruise Control may not warn you.
- You may not hear the audible warning of Smart Cruise Control if the surrounding environment is too noisy.
- The vehicle manufacturer is not responsible for any traffic violation or collisions caused by you.
- Set your vehicle speed to the speed limit for the road in your area.
- Inter-vehicle distance, acceleration and reaction speed may change if the driver's driving style changes.
- Smart Cruise Control may not operate for 15 seconds right after your vehicle is started or when the front view camera, front radar, and front corner radar are initialized.

### *i* Information

You may hear sounds when Smart Cruise Control is braking your vehicle. This is normal and does not indicate a malfunction.

## Smart Cruise Control Malfunction And Limitations

### *Smart Cruise Control malfunction*



When Smart Cruise Control is not working properly, the "**Check Driver Assistance system.**" warning message may appear and the  warning light may illuminate on the instrument cluster. Have your vehicle inspected by an authorized retailer of Genesis Branded products.

### *Smart Cruise Control disabled*



If the front radar is covered or blocked, its detecting performance is reduced, and Smart Cruise Control is temporarily limited or disabled.

The "**Driver Assistance system limited. Radar blocked**" warning message may appear on the instrument cluster.

If Smart Cruise Control does not operate normally after the sensor has been uncovered or unblocked, have your vehicle inspected by an authorized retailer of Genesis Branded products.

### **WARNING**

- Smart Cruise Control may not operate properly even if there is no warning message or warning light on the instrument cluster.
- Smart Cruise Control may not operate properly in open areas where no objects are detected (e.g. empty parking lot) or when the detecting sensors are blocked right after turning on the engine.

### **Detecting sensors**

Refer to the "Driver Assistance System Sensors" section in this chapter for the location and the general precautions of the front view camera, front radar, and front corner radar.

### ***Limitations of Smart Cruise Control***

Smart Cruise Control may not operate normally or may operate unexpectedly if:

- The sensor or the area near the sensor is blocked, covered, or damaged.
- The temperature near the front view camera is very hot or cold.
- The camera lens is covered or blocked by windshield tint, the windshield is damaged, or a sticky material (sticker, bug, etc.) is on the glass.
- Moisture is not removed or is frozen on the windshield.
- Washer fluid is sprayed continuously, or the wiper is on.
- You are driving in heavy rain, snow, or thick fog.
- The front view camera's field of view is obstructed by glare from the sun.
- Sunlight, streetlight, or light from an oncoming vehicle is reflected on the wet road surface such as a puddle on the road.
- An object is placed on the dashboard.
- The surrounding is very bright or very dark (nighttime, tunnel, etc.).
- The brightness changes suddenly, for example when entering or exiting a tunnel.
- The brightness outside is low, and the headlamps of the front vehicle are turned off or are not bright.
- A front vehicle is partially visible.
- The vehicle in front has no tail lights or tail lights are located in an unusual location.
- The vehicle in front has no tail lamps or tail lamps are located in an unusual location.
- The rear of the front vehicle is small or the vehicle does not look normal, such as when your vehicle is tilted, overturned, or the side of your vehicle is visible.
- The front vehicle's ground clearance is so low or high.
- Your vehicle is being towed.
- A vehicle suddenly cuts in front.
- The bumper around the front radar has been damaged or modified, and the radar is out of position.
- A material is near that reflects very well on the front radar, such as guardrail, nearby vehicle, etc.
- The temperature near the front radar is very hot or cold.
- The vehicle in front is made of a material that does not reflect on the front radar well.
- The vehicle in front is detected late.
- The vehicle in front is suddenly blocked by an obstacle.
- The vehicle in front suddenly changes lanes or reduces the speed.
- The angle of the vehicle in front is out of the detection range.
- Your vehicle changes lanes at a low speed with a vehicle in front.

- The vehicle in front is covered with snow.
- You are on a curve or roundabout and the vehicle in front is not detected.
- You are continuously driving in a circle.
- Your vehicle moves unstably or vibrates excessively.
- Your vehicle height is low or high due to heavy loads, abnormal tire pressure, etc.
- You are driving through steam, smoke, or shadow.
- You are driving through a tunnel or an iron bridge.
- You are driving in large, open areas where there are few vehicles or structures (e.g. desert, meadow, empty suburb).
- You are driving in a parking lot.
- You are driving through a tollbooth, construction area, unpaved road, partial paved road, uneven road, speed bumps, etc.
- You are driving through roads with railroad tracks or other embedded metal objects.
- You are driving on an inclined road or curved road.
- You are driving on a sharply curved road.
- You are driving through a roadside with trees or streetlights.
- You are driving on a narrow road where trees or grass are overgrown.
- You are driving on a slippery surface due to snow, water puddle, ice, etc.
- You are driving in an area with strong radio waves or electrical noise interference.

#### • Driving on curves



On curves, Smart Cruise Control may not detect a vehicle in the same lane, and may accelerate to the set speed. Your vehicle speed may be reduced if a vehicle is detected in an adjacent lane and your vehicle speed may rapidly decrease when a vehicle ahead is detected suddenly.

Select an appropriate set speed for curves and apply the brake pedal or accelerator pedal depending on the road and driving conditions.

### • Driving on hills



During uphill or downhill driving, Smart Cruise Control may not detect a moving vehicle in your lane, and cause your vehicle to accelerate to the set speed. Also, your vehicle speed rapidly decreases when a vehicle ahead is detected suddenly.

Select an appropriate set speed on inclines and apply the brake pedal or accelerator pedal depending on the road and driving conditions.

### • Changing lanes



[A] Your vehicle  
[B] Lane changing vehicle

When a vehicle moves into your lane from an adjacent lane, it cannot be detected by the sensor until it is in the sensor's detection range. Smart Cruise Control may not immediately detect the vehicle when your vehicle changes lanes abruptly. Brake as needed to reduce your driving speed.

### • Situations when detecting are limited

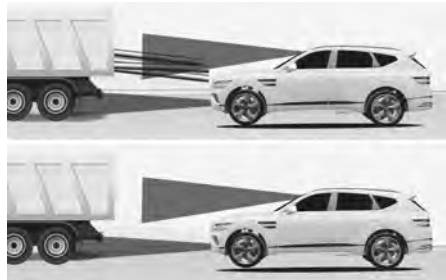
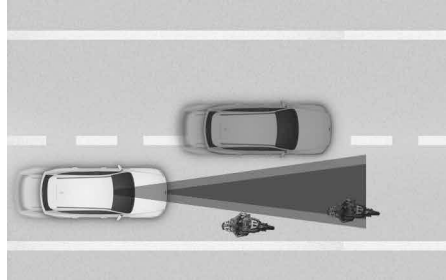

Some vehicles, pedestrians, or animals in your lane may not be detected by the sensor:

- Vehicles offset to one side
- Slow-moving vehicles or sudden decelerating vehicles
- Vehicles with higher ground clearance or vehicles carrying loads that extend past the end of the vehicle
- Vehicles that have the front tilted due to heavy loads
- Vehicles within about 2 m (6 ft.) from your vehicle
- Oncoming vehicles

- Stopped vehicles
- Vehicles with small rear profile, such as trailers
- Narrow vehicles, such as motorcycles or bicycles
- Special vehicles
- Animals and pedestrians

Brake as needed to reduce your driving speed.

- In the following cases, the vehicle in front may not be detected by the sensor:
  - Making sharp steering inputs when driving
  - Driving on narrow or sharply curved roads
- When a vehicle ahead turns at an intersection and is no longer detected, your vehicle may accelerate.

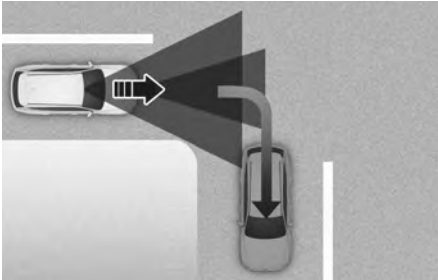

- When a vehicle in front of you merges out of the lane, Smart Cruise Control may not immediately detect a new vehicle that is now in front of your vehicle.

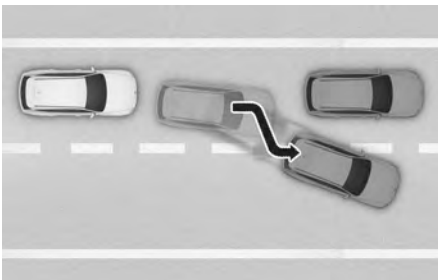

- Always look out for pedestrians when your vehicle is maintaining a distance with the vehicle ahead.

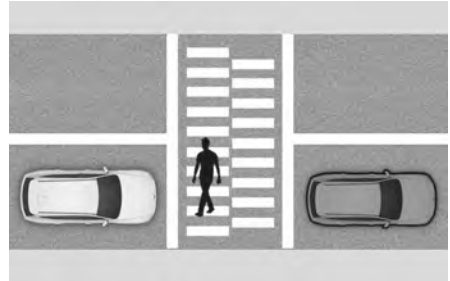

### *i* Information

This device complies with Part 15 of the FCC rules.

Operation is subject to the following three conditions:

- This device may not cause harmful interference, and
- This device must accept any interference received, including interference that may cause undesired operation.
- Changes or modifications not expressly approved by the party responsible for compliance could void the user's authority to operate the device.

### *i* Information

Radio frequency radiation exposure information:

This equipment complies with FCC radiation exposure limits set forth for an uncontrolled environment.

This equipment should be installed and operated with minimum distance of 8 in. (20 cm) between the radiator (antenna) and your body.

This transmitter must not be co-located or operating in conjunction with any other antenna or transmitter.

## Emergency Stop (ES)

If Emergency Stop judges the driver is unresponsive, the function stops your vehicle within the driving lane by centering the vehicle in the lane and assisting in braking.

### *i* Information

Emergency Stop uses the following sensors:

- Front view camera
- Front radar

Refer to the "Driver Assistance System Sensors" section in this chapter for the location.

---

## Emergency Stop Operation

### *Operating conditions*

Emergency Stop operates if all the following conditions are met:

- Smart Cruise Control is on.
- Lane Following Assist is on.
- The function judges you are unresponsive.

**The function judges you are unresponsive if:**

- You do not have your hands on the steering wheel after the hands-off warning is continuously displayed.
- Your eyes are not focused on the road after inattentive driving warning is continuously displayed.

### *i* Information

- For more information and limitations of the Smart Cruise Control, refer to the "Smart Cruise Control (SCC)" section in this chapter.
  - For more information and limitations of the Lane Following Assist, refer to the "Lane Following Assist (LFA)" section in this chapter.
- 

### *Emergency stopping*

To warn you that Emergency Stop is operating the "**Take control of the vehicle immediately. Vehicle is stopping.**" warning message appears on the instrument cluster, an audible warning sounds, and the steering wheel vibrates.

Emergency Stop provides steering and braking assist to stop the vehicle within the driving lane.

### *i* Information

When Emergency Stop is operating, the vehicle distance setting of Smart Cruise Control is changed to Distance 4. The vehicle distance setting is set to the last distance setting after Emergency Stop is deactivated.

---

### *After stopping*

After your vehicle has stopped, the following is performed:

- Doors are unlocked.
- SOS call is made. (if served)
- EPB (Electronic Parking Brake) is applied.

### *i* Information

The activation of a specific function varies depending on the time of updates on your vehicle and the time when a service is provided.

---



### ***Deactivating Emergency Stop***

When deactivating Emergency Stop the "**Drive carefully**" warning message may appear on the instrument cluster.

If the function judges you have responded, Emergency Stop is deactivated when one of the following condition is met:

- You are focused on the road and the steering wheel is controlled.
- You strongly and continuously depress the accelerator pedal.
- You strongly depress the brake pedal.
- You press the Lane Driving Assist button (⚠).
- You press the Driving Assist button (⚠).
- You press the hazard warning flasher button after your vehicle has stopped.
- The front door is opened.

### ***i* Information**

The vehicle needs to be restarted to reactivate Smart Cruise Control after the vehicle is stopped and Emergency Stop is deactivated.

### **CAUTION**

Smart Cruise Control operation is limited if the in-cabin camera is unable to detect your face.

## **Emergency Stop Malfunction and Limitations**

### ***Emergency Stop malfunction***

When Emergency Stop is not working properly, the "**Check Emergency Stopping function.**" warning message appears, and the master (⚠) warning light illuminates on the instrument cluster. If this occurs, have your vehicle inspected by an authorized retailer of Genesis Branded products.

### ***Limitations of Emergency Stop***

For more information on the limitations of Emergency Stop, refer to the "Smart Cruise Control (SCC)" and "Lane Following Assist (LFA)" sections in this chapter.

## Navigation-based Smart Cruise Control (NSCC)

 If equipped

Navigation-based Smart Cruise Control helps drive at a certain speed depending on the road conditions when driving on highways by using information from the navigation system while Smart Cruise Control is operating.

### *i* Information

- Navigation-based Smart Cruise Control is available only on controlled access highways.
  - Controlled access highway is the road with limited entrances and exits that allow uninterrupted high speed traffic flow.

Available highway (Controlled access road)	
USA	Select Interstate Highway and U.S. (Federal) and State Highways
Canada	Select Provincial and Territorial Highways

- Additional highways may be expanded by future navigation system updates.
- Navigation-based Smart Cruise Control operates on main roads of highways (or motorways), and does not operate on interchanges or junctions.

### Highway Auto Curve Slowdown

If the vehicle speed is high, the Highway Curve Zone Auto Slowdown function temporarily slows your vehicle or limits acceleration based on the available curve information in the navigation system.

## Navigation-based Smart Cruise Control Settings



With the vehicle on, select **Setup > Vehicle > Driver Assistance > Driving Convenience > Highway Auto Speed Change** from the Settings menu in the infotainment system to turn on Navigation-based Smart Cruise Control and deselect to turn off the function.

### *i* Information

When there is a problem with Navigation-based Smart Cruise Control, the function cannot be set from the settings menu.

## Navigation-based Smart Cruise Control Operation

Navigation-based Smart Cruise Control may be available when:

- Smart Cruise Control is operating.
- You are driving on main roads of highways.

### *i* Information

For more information on how to operate Smart Cruise Control, refer to the "Smart Cruise Control (SCC)" section in this chapter.

### Navigation-based Smart Cruise Control display

The following may appear on the instrument cluster:



#### Navigation-based Smart Cruise Control standby

If the operating conditions are met, the green **NAV** indicator light illuminates.

#### Navigation-based Smart Cruise Control operating

While the speed is being controlled, the green **NAV** indicator light blinks.

#### Temporarily canceled or interrupted by the driver

If Navigation-based Smart Cruise Control cannot control the vehicle, such as when Smart Cruise Control is temporarily canceled or the navigation system is searching for a route, the gray **NAV** indicator light illuminates.

When the driver depresses the accelerator pedal, the white **NAV** indicator light blinks.

### WARNING



The "**Drive carefully**" warning message appears if Navigation-based Smart Cruise Control is not able to slow down your vehicle.

### i Information

The images and colors in the instrument cluster may differ depending on the cluster type or theme selected from the settings menu.

#### Highway Auto Curve Slowdown

- Depending on the curve ahead on the highway, your vehicle decelerates, and after passing the curve, your vehicle accelerates to Smart Cruise Control's set speed.
- Vehicle deceleration time may differ depending on your vehicle speed and the degree of the curve on the road. The higher the driving speed, deceleration starts faster.

## Limitations of Navigation-Based Smart Cruise Control

Navigation-based Smart Cruise Control may not operate normally if:

- The navigation is not working properly.
- Map information is not transmitted due to an issue with the infotainment system.
- Speed limit and road information in the navigation system has not been updated.
- The map information differs from the actual road conditions because of real-time GPS data or map information error.
- The navigation system is searching for a route while driving.
- GPS signals are blocked in areas such as a tunnel.
- A road is divided into two or more roads and they join again.
- You go off the route set in the navigation system.
- The route to the destination is changed or canceled by resetting the navigation system.
- Your vehicle enters a service station or rest area.
- Android Auto or Car Play is operating.
- The navigation system cannot detect the current vehicle position (e.g. elevated roads including overpass adjacent to general roads or nearby roads exist in a parallel way).
- The navigation system is updated while driving or restarts.
- The speed limits of some sections have changed according to the road situations (e.g. construction zone).
- You are driving on a road that is under facility construction.
- You are driving in lane-restricted driving situations.

- There is inclement weather, such as heavy rain or heavy snow.
- You are driving on a road with sharp curves.
- When your vehicle continues on the controlled access road and does not follow the navigation route to exit the highway, Highway Auto Curve Slowdown may not operate until it is determined that you are driving on the highway. When Highway Auto Curve Slowdown operates, your vehicle may decelerate gradually or rapidly depending on the distance to the curve and the vehicle speed.

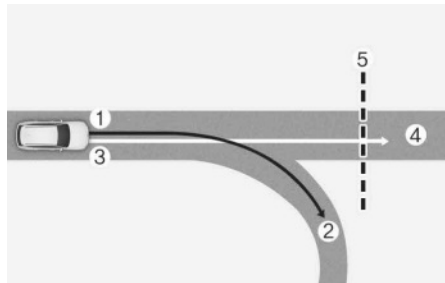

- (1) Set route
- (2) Branch line
- (3) Driving route
- (4) Main road
- (5) Curved road section

- When your vehicle does not follow the navigation route and exits the highway at an interchange or junction, Highway Auto Curve Slowdown may temporarily operate until it is determined that you have exited the highway.

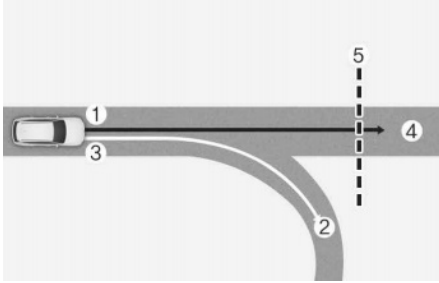

- (1) Set route
- (2) Branch line
- (3) Driving route
- (4) Main road
- (5) Curved road section

- If there is no destination set on the navigation, Highway Auto Curve Slowdown operates based on the curve information for the controlled access road in the navigation system.

When you exit the highway at an interchange or junction, Highway Auto Curve Slowdown may temporarily operate using the navigation information for the highway.

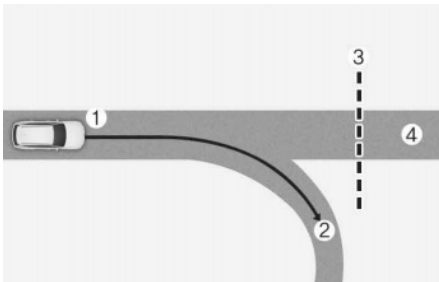

- (1) Driving route
- (2) Branch line
- (3) Curved road section
- (4) Main road

## ⚠ WARNING

Always have your eyes on the road. It is your responsibility to avoid violating traffic laws. Navigation-based Smart Cruise Control is not a substitute for safe driving practices, but a supplemental function only.

To prevent serious injury or death:

- Always check the speed limit while driving. The navigation's speed limit information may differ from the actual speed limit on the road.
- Navigation-based Smart Cruise Control is automatically canceled when you leave the highway and enter a general road, interchange, junction, or rest area.
- Navigation-based Smart Cruise Control may not operate depending on the configuration of vehicles detected ahead on the road.
- When you are towing a trailer or another vehicle, turn off Navigation-based Smart Cruise Control.
- After you pass through a tollbooth on a highway, Navigation-based Smart Cruise Control operates based on the outermost lane. If you enter one of the other lanes, Navigation-based Smart Cruise Control may not operate properly.
- Your vehicle accelerates if you depress the accelerator pedal while Navigation-based Smart Cruise Control is operating. If the accelerator pedal is not depressed far enough, your vehicle may decelerate.
- If you accelerate and release the accelerator pedal while Navigation-based Smart Cruise Control is operating, your vehicle may not decelerate sufficiently or may rapidly decelerate.

- If the curve is too sharp or if it is a slight curve, Navigation-based Smart Cruise Control may not operate.
- 

### *i* Information

- There may be a gap in time between the navigation system's guidance and when the Navigation-based Smart Cruise Control operation starts and ends.
  - The speed information on the instrument cluster may differ from the navigation system.
  - Even if you are driving at a speed lower than the Smart Cruise Control's set speed, acceleration may be limited by the curves ahead on the road.
  - If Navigation-based Smart Cruise Control is operating while leaving the highway and entering an interchange, junction, or rest area, the function may continue to operate for a while.
  - Deceleration by Navigation-based Smart Cruise Control may not feel sufficient due to the road conditions such as uneven road surfaces or narrow lanes.
- 

### *i* Information

This device complies with Part 15 of the FCC rules.

Operation is subject to the following three conditions:

- This device may not cause harmful interference, and
  - This device must accept any interference received, including interference that may cause undesired operation.
  - Changes or modifications not expressly approved by the party responsible for compliance could void the user's authority to operate the device.
- 

### *i* Information

Radio frequency radiation exposure information:

This equipment complies with FCC radiation exposure limits set forth for an uncontrolled environment.

This equipment should be installed and operated with minimum distance of 8 in. (20 cm) between the radiator (antenna) and your body.

This transmitter must not be co-located or operating in conjunction with any other antenna or transmitter.

---

## Lane Following Assist (LFA)

Lane Following Assist helps detect lane markings and/or a vehicle ahead on the road, and provide steering assist to your vehicle in the lane.

### Lane Following Assist Settings

#### Warning methods

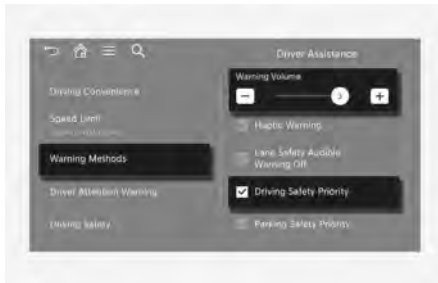

With the engine on, select **Setup > Vehicle > Driver Assistance > Warning Methods** from the Settings menu in the infotainment system to select the following:

- **Warning Volume:** The warning volume can be adjusted. If you set the warning volume to '0', the warning volume does not turn off but sounds as '1'.
- **Driving Safety Priority:** Your vehicle lowers all other audio volumes when the Driver Assistance system warning sounds.



#### *i* Information

- If you change the warning methods, the warning methods of other Driver Assistance systems may change.
- When the engine is restarted, the warning methods maintains its last setting.

## Lane Following Assist Operation

### Turning Lane Following Assist On/Off



With the engine on, press the Lane Driving Assist () button located on the steering wheel to turn on Lane Following Assist. The gray or green  indicator light illuminates on the instrument cluster.

Press the button again to turn off the function.

### Lane Following Assist



If the both lane markings and/or vehicle ahead are detected and your vehicle speed is below 124 mph (200 km/h), the green  indicator light illuminates on the instrument cluster, and Lane Following Assist helps center the vehicle in the lane by assisting the steering wheel.

## *i* Information

When the steering wheel is not assisted, the white  indicator light blinks and changes to gray.

### *Hands-off warning*



If you take your hands off the steering wheel for several seconds, the "**Keep hands on steering wheel**" warning message may appear on the instrument cluster, and an audible warning may sound in successive stages.

- First stage: Warning message
- Second stage: Warning message (red steering wheel) with a warning sound

## *i* Information

For more details on precautions of the steering wheel grip sensor, refer to the "Steering Wheel Grip Sensor" section in chapter 5.



If you do not have your hands on the steering wheel after the hands-off warning, the "**Lane Following Assist deactivated**" warning message may appear and Lane Following Assist is automatically canceled.

## WARNING

Always safely steer your vehicle and maintain the position of your vehicle in its lane.

To prevent serious injury or death:

- Always have your hands on the steering wheel while driving.
- Lane Following Assist may not steer if the steering wheel is held too tightly, or the steering wheel is turned too far left or right.
- If the steering wheel is held very loosely or you have gloves on, the hands-off warning message may appear because the Lane Following Assist may not recognize that you have your hands on the steering wheel.
- The hands-off warning message may appear late or not at all depending on the road condition.
- If you attach objects to the steering wheel, the hands-off warning may not work properly.



## *i* Information

- The status of the Lane Following Assist operation appears in Driving Assist view on the instrument cluster. Refer to the "View Modes" section in chapter 4.
- When both lane markings are detected, the lane lines on the cluster changes from gray to white.

Lane undetected



Lane detected



- The images and colors in the cluster may differ depending on the cluster type or theme selected from the settings menu.
- If lane markings are not detected, steering wheel control by Lane Following Assist can be limited depending on the vehicle in front or driving condition.
- You can steer your vehicle even when steering is assisted by Lane Following Assist.

- It may require more or less force to turn the steering wheel when Lane Following Assist is providing steering assistance.

## Lane Following Assist Malfunction And Limitations

### *Lane Following Assist malfunction*



When Lane Following Assist is not working properly, the "**Check Driver Assistance system**" warning message may appear for several seconds, and the  warning light may illuminate on the instrument cluster. Have your vehicle inspected by an authorized retailer of Genesis Branded products.

### *Detecting sensors*

Refer to the "Driver Assistance System Sensors" section in this chapter for the location and the general precautions of the front view camera.

### *Limitations of Lane Following Assist*

## *i* Information

For more information on Lane Following Assist limitations and precautions, refer to the "Lane Keeping Assist Malfunction and Limitations" section in this chapter.

## Highway Driving Assist (HDA)

### Basic function

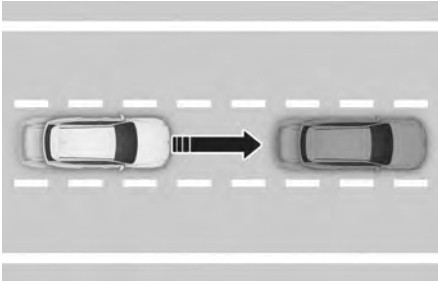

Highway Driving Assist helps maintain distance from the vehicle ahead, maintain the set speed, and center the vehicle in the lane while driving on the highway.

### Highway Lane Change Assist

 If equipped

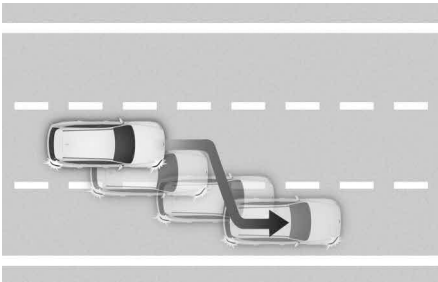

Highway Lane Change Assist function helps change lanes to the direction you operate the turn signal switch if the function judges that lane change is possible.

### *i* Information

- Highway Driving Assist is available only on controlled access highways.
  - Controlled access highway is the road with limited entrances and exits that allow uninterrupted high speed traffic flow.

#### Available highway (Controlled access road)

USA	Select Interstate Highway and U.S. (Federal) and State Highways
Canada	Select Provincial and Territorial Highways

- Additional highways may be expanded by future navigation system updates.
- Highway Driving Assist does not operate on interchanges or junctions.

## Highway Driving Assist Settings

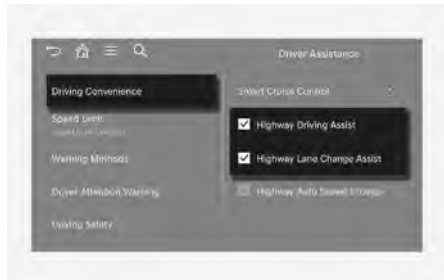

With the vehicle on, select or deselect **Setup > Vehicle > Driver Assistance > Driving Convenience** from the Settings menu to turn each function on and off.

## Highway Driving Assist

**+** if equipped

If **Highway Driving Assist** is selected, the function helps maintain distance from the vehicle ahead, maintain the set speed, and help center your vehicle in the lane while driving on the highway.

## Highway Lane Change Assist

**+** if equipped

If **Highway Lane Change Assist** is selected, the function helps you change lanes.

### *i* Information

- When **Highway Driving Assist** is deselected, the setting for **Highway Lane Change Assist** cannot be changed.
- When there is a problem with Highway Driving Assist, the function cannot be set from the Settings menu. Have your vehicle inspected by an authorized retailer of Genesis Branded products.
- When the engine is restarted, the function maintains the last setting.

### **!** WARNING

Only change the settings after parking your vehicle at a safe location.

## Warning methods

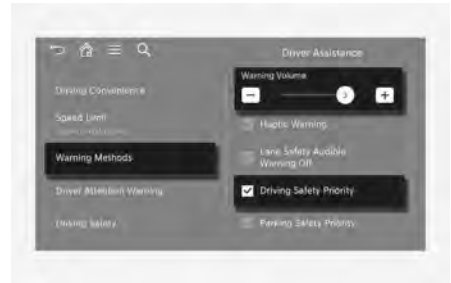

With the engine on, select **Setup > Vehicle > Driver Assistance > Warning Methods** from the Settings menu in the infotainment system to select the following:

- **Warning Volume:** The warning volume can be adjusted. If you set the warning volume to '0', the warning volume does not turn off but sounds as '1'.
- **Driving Safety Priority:** Your vehicle lowers all other audio volumes when the Driver Assistance system warning sounds.

### *i* Information

- If you change the warning volume, the warning volume of other Driver Assistance systems may change.
- When the engine is restarted, the warning methods maintains its last setting.
- The setting menu may not be available for your vehicle depending on the vehicle features and specifications.

## Highway Driving Assist Operation

### Basic function

#### Highway Driving Assist display

The status of the Highway Driving Assist operation appears in Driving Assist mode on the instrument cluster. Refer to the "View Modes" section in chapter 4.

Operating state



Standby state



1. Indicates if there is a vehicle ahead and the selected distance level appears.
  - Highway Driving Assist indicator (HDA)
    - Green HDA: Operating state
    - Gray HDA: Standby state
    - White HDA blink: Accelerator pedal depressed
    - Non-display: Off state
2. Set speed appears.
3. Lane Following Assist light appears.

4. Detected ahead and the selected vehicle distance appears.
5. Whether the lane is detected or not appears.

### *i* Information

- For more information on the display, refer to the "Smart Cruise Control (SCC)" and "Lane Following Assist (LFA)" sections in this chapter.
- The images and colors may differ depending on the cluster type or theme selected from the settings menu.

### Highway Driving Assist operation

Highway Driving Assist operates when:

- You have pressed the Driving Assist button after entering or driving on controlled access roads.
- Entering or driving on controlled access roads with both Lane Following Assist and Smart Cruise Control operating.

### Restarting after stopping

When Highway Driving Assist is operating, your vehicle stops if the vehicle ahead of you stops. Also, if the vehicle ahead of you starts moving within 30 seconds after the stop, your vehicle starts as well. If your vehicle has stopped and 30 seconds have passed, the "**Use switch or pedal to accelerate**" message appears on the instrument cluster. Depress the accelerator pedal or push the **+** switch, **-** switch, or **||** switch to accelerate.



## Hands-off warning



If you take your hands off the steering wheel for several seconds, the **"Keep hands on steering wheel"** warning message may appear on the instrument cluster, and an audible warning sounds in successive stages.

First stage: Warning message

Second stage: Warning message (red steering wheel) and audible warning

If you keep taking your hands off the steering wheel, then the Emergency Stop will activate.

For more information, refer to the "Emergency Stop (ES)" section in this chapter.

## Driving to one side within lane

 if equipped

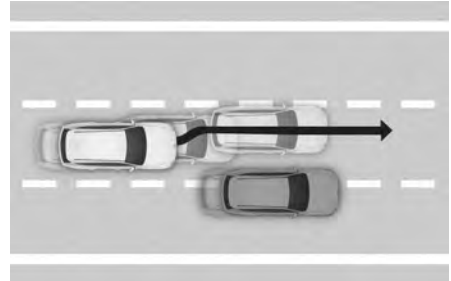





When vehicle speed is above 40 mph (60 km/h), if a detected vehicle around you is driving at a close distance, your vehicle controls the steering in the opposite direction of the vehicle. If a vehicle is detected at both sides of the lane and are driving close to you, the function does not veer to the opposite side of the lane.

### Highway Driving Assist standby

When the Smart Cruise Control is temporarily cancelled while Highway Driving Assist is operating, Highway Driving Assist goes into the standby state. At this time, Lane Following Assist operates normally.

### Information

- Driving Speed Limit helps you drive below 40 mph (60 km/h). At this time, the vehicle decelerates due to the vehicle ahead. After the vehicle has decelerated, it cannot automatically accelerate.
- Driving Speed Limit cancels when:
  - The driver grabs the steering wheel again
  - The driver turns on Lane Following Assist by pressing the Lane Driving Assist () button
  - , ,  switch, or  button is operated, or the accelerator pedal or the brake pedal is depressed

## Highway Lane Change Assist

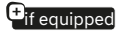
 if equipped

### Highway Lane Change Assist display

The status of the Highway Lane Change Assist operation appears in Driving Assist mode on the instrument cluster. Refer to the "View Modes" section in chapter 4.

Ready/Operating



Standby/Canceled



#### 1. Highway Lane Change Assist (↔) indicator

- Green on: Ready state
- Green blink: Operating state
- Gray on: Standby state
- White blink: Canceled state (displayed only a certain time)

#### 2. Green lane line

- The lane line is displayed same as the Highway Lane Change Assist (↔) indicator. However, if the function is in standby, it displays whether the lane line is detected.

#### 3. Green arrow and shade

- The green arrow is displayed when a certain amount of time has passed after the function has started operating, and until the lane change has completed.

#### 4. Message

- Message appears when the function does not operate even though the turn signal is used.
- Message appears when the function is canceled while operating.

### To turn on Highway Lane Change Assist

Highway Lane Change Assist function turns on when the Driving Assist button or Lane Driving Assist button is used to turn on Highway Driving Assist.

### Highway Lane Change Assist ready to operate



While Highway Lane Change Assist function is on, the function is ready to operate when all the following conditions are met:

- Highway Driving Assist is operating.
- Lane Following Assist is operating.
- A vehicle in the rear area of your vehicle is detected more than once after the engine is turned on.
- Your vehicle speed is above 18 mph (30 km/h).

- When your vehicle is between 18-37 mph (30-60 km/h), a vehicle is detected in the rear area of your vehicle's left and right side lanes, and there is no risk of collision when changing a lane.
- Hands-off warning is not displayed on the instrument cluster.
- Hazard warning flasher is off.

### *i* Information

While Lane Change Assist function is turned on (indicator on), Lane Following Assist does not cancel even if the turn signal indicator or hazard warning flasher is operating.

- Lane Change Assist function turns off automatically when driven in the following road conditions:
  - There is only one driving lane.
  - There is a road with a intersection or crosswalk ahead.
  - There is a road with no structure, such as a medium strip, guardrails, etc.
  - There is a pedestrian or cyclist on the road ahead.
- When the function is in the ready state, and vehicle speed is below 15.5 mph (25 km/h), the function changes to the standby state.
- When your vehicle is between 18-37 mph (30-60 km/h), and a vehicle is not detected in the rear area of your vehicle's left and right side lanes, the function changes to the standby state.
- If there is a collision risk, the function changes to the standby state.

### WARNING

When Highway Lane Change Assist function turns off while operating, steering assist is temporarily canceled. Always be cautious while driving.

### Highway Lane Change Assist operating

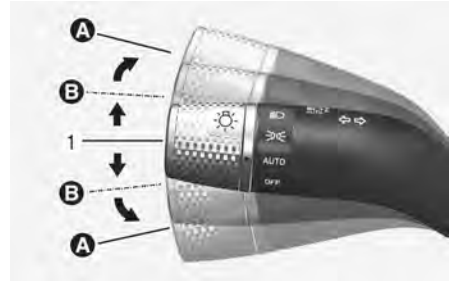

Highway Lane Change Assist function operates, when you push the turn signal lever up or down to the [A] or [B] position while the function is in the ready state (indicator is green), and all of the following conditions are met:

- You have your hand on the steering wheel.
- There is no collision risk in the direction of lane change.
- There is a single dotted lane line in the direction of lane change.
- There are no Forward Collision-Avoidance Assist and Blind Spot Collision-Avoidance Assist warnings.
- The vehicle is driven in the middle of the lane (should not be driving close to one side of the lane).
- The road you are driving on, or the road you are about to change lane is a road that the function can operate.

### *i* Information

- Highway Lane Change Assist operates when the turn signal lever is positioned at [A].

If the turn signal lever is released to the center (1) before stepping on the lane, Highway Lane Change Assist cancels. If the turn signal lever is released to the center (1) after stepping on the lane, Highway Lane Change Assist changes the lane and turns off the turn signal after the lane change is complete.

- When the turn signal lever is placed at [B] position for a certain period of time, the green arrow appears. At this time, even when the lever is released and returns to the original position (1), lane change is still assisted.

While lane change is being made by the function, the turn signal indicator blinks even when the turn signal lever is not held, and the turn signal indicator turns off when lane change is complete.

---

### Highway Lane Change Assist standby

Highway Lane Change Assist function is in the standby state when one of the ready state condition is not met, or when entering or driving on one of the following roads:

- Road within a certain distance from the tollbooth on the main road of the highway
- The road ahead ends without an interchange or junction
- Road with sharp curves
- Road with narrow lanes
- Road that is under construction

### Highway Lane Change Assist cancel

You may cancel the function by:

- Turning on the turn signal in the opposite direction of the lane change.
- Turning the steering wheel sharply.

### WARNING

- Highway Lane Change Assist automatically cancels when:
  - Highway Driving Assist is turned off.
  - Lane Following Assist or Smart Cruise Control is turned off or temporarily canceled.
  - Hands-off warning message is displayed on the instrument cluster.
  - The hazard warning flasher is turned on.

- Forward Collision-Avoidance Assist or Blind-Spot Collision Avoidance Assist warning message is displayed.
  - Possible collision is detected in the next lane, even though there are no Forward-Collision Avoidance Assist and Blind-Spot Collision Avoidance Assist warning.
  - Entering a road under construction.
  - The target lane to make a lane change disappears.
  - There is a problem with the turn signal lights.
  - Highway Lane Change Assist function turns off (The function turns off when the function is turned off from the settings menu, when the road changes to a one-way road, when there is an intersection or crosswalk ahead, when you enter a road with no structure, such as a medium strip, guardrail, etc., or when there is a pedestrian or cyclist on the driving lane.).
  - Your vehicle speed is below 35 mph (55 km/h).
  - When your vehicle is between 18-37 mph (30-60 km/h), and a vehicle is not detected in the rear area of your vehicle's left and right side lanes.
  - There is a risk of collision with a vehicle in the rear area of your vehicle.
  - While the function is operating, when the function is canceled, depending on the driving conditions, the vehicle may drive to the middle of the driving lane or steering assist may stop. Always pay attention to road and driving conditions while driving.
  - The function may not operate properly on roads with pedestrians or cyclists, such as an intersection or crosswalk. Always pay attention to road and driving conditions while driving.
-



## Highway Driving Assist Malfunction And Limitations

### Highway Driving Assist malfunction



When Highway Driving Assist is not working properly, the "**Check Driver Assistance system.**" warning message may appear and the  warning light may illuminate on the instrument cluster. Have your vehicle inspected by an authorized retailer of Genesis Branded products.

### WARNING

Always check road conditions, and if necessary, take appropriate actions to drive safely. Highway Driving Assist is a supplemental function only and it is not a self driving or autonomous driving system.

To prevent serious injury or death:

- Always have your hands on the steering wheel while driving.
- Always have your eyes on the road and pay attention. It is your responsibility to avoid violating traffic laws.
- Highway Driving Assist may not be able to recognize all traffic situations and may not detect possible collision hazards. Obstacles such as vehicles, motorcycles, bicycles, pedestrians, or unspecified objects or structures (e.g. guardrails and tollbooth) may not be detected.

- Highway Driving Assist turns off automatically under the following situations:
  - You are driving on roads that Highway Driving Assist does not operate, such as rest area, intersection, junction, etc. However, Highway Driving Assist may be maintained in some sections.
  - The navigation does not operate properly such as when the navigation system is updating or restarting.
- Highway Driving Assist may inadvertently operate or turn off depending on the road conditions (based on the navigation system information) and surroundings.
- Lane Following Assist may be temporarily disabled when the front view camera cannot detect lanes properly or the hands-off warning is on.
- The hands-off warning message may appear early or late depending on how the steering wheel is held or road conditions.
- You may not hear the audible warning of Highway Driving Assist if the surrounding environment is too noisy.
- When your vehicle is driven at high speeds through a curve, your vehicle may depart from your driving lane if you do not maintain control.
- When you are towing a trailer or another vehicle, turn off Highway Driving Assist.
- Highway Driving Assist may not operate right after the engine is started or when the sensors or navigation system is initialized.

### **Detecting sensors**

Refer to the "Driver Assistance System Sensors" section in this chapter for the location and the general precautions of the front view camera, front radar, front corner radar (if equipped), and rear corner radar.

### **Limitations of Highway Driving Assist**

Highway Driving Assist may not operate normally or may not operate if:

- The map information differs from the actual road conditions because the navigation system has not been updated, or there is a real-time GPS data or map information error.
- The infotainment system is overloaded by simultaneously performing functions such as route search, video playback, voice recognition, etc.
- GPS signals are blocked in an area such as tunnel.
- You depart from the navigation route or the route to the destination is changed or canceled.
- Your vehicle enters a service station or rest area.
- Android Auto or Car Play is operating.
- The navigation system cannot detect the current vehicle position (e.g. elevated roads including overpass adjacent to general roads or nearby roads exist in a parallel way).
- A trailer or hitch mounted carrier is connected to your vehicle.

### ***i* Information**

For more information on the limitations of the front view camera, front radar, front corner radar, and rear corner radar, refer to the "Forward Collision-Avoidance Assist (FCA)" section in this chapter.

---

### ***i* Information**

This device complies with Part 15 of the FCC rules.

Operation is subject to the following three conditions:

- This device may not cause harmful interference, and
  - This device must accept any interference received, including interference that may cause undesired operation.
  - Changes or modifications not expressly approved by the party responsible for compliance could void the user's authority to operate the device.
- 

### ***i* Information**

Radio frequency radiation exposure information:

This equipment complies with FCC radiation exposure limits set forth for an uncontrolled environment.

This equipment should be installed and operated with minimum distance of 8 in. (20 cm) between the radiator (antenna) and your body.

This transmitter must not be co-located or operating in conjunction with any other antenna or transmitter.

---

## Rear View Monitor (RVM)

 if equipped

Rear View Monitor displays the area behind your vehicle to assist you when parking.

## Rear View Monitor Settings

### Warning methods



With the engine on, select **Setup > Vehicle > Driver Assistance > Warning Methods** from the Settings menu in the infotainment system to select the following:

- **Parking Safety Priority:** The vehicle lowers all other audio volumes when a parking assist view is active.

### *i* Information

- If you change the warning methods, the warning methods of other Driver Assistance systems may change.
- When the engine is restarted, the warning methods maintains its last setting.
- The setting menu may not be available for your vehicle depending on the vehicle features and specifications.

### Camera settings

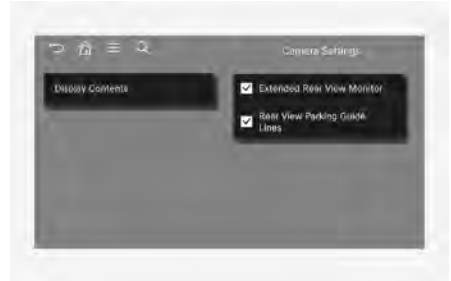

To change the settings of Rear View Monitor's display contents, press the setup icon (⚙️) on the screen while Rear View Monitor is operating, or select **Setup > Vehicle > Driver Assistance > Parking Safety > Camera Settings** from the Settings menu in the infotainment system while the engine is on.

- If **Display Contents** is selected, you can change settings for **Extended Rear View Monitor** and **Rear View Parking Guide Lines**.

### Extended rear view monitor

If **Extended Rear View Monitor** is selected, the rear view maintains on the screen when shifting from R (Reverse) to N (Neutral) or D (Drive). When your vehicle exceeds a certain speed, the rear view stops displaying.

### Rear view parking guide line

If **Rear View Parking Guide Lines** is selected, the rear view parking guide appears when the rear view and rear top view is displayed.

#### *i* Information

- The horizontal line of the rear view parking guideline is based on the absence of a driver in a vehicle. This shows the distance of about 1.6 ft. (0.5 m), 3.3 ft. (1 m), and 7.6 ft. (2.3 m) from the vehicle.
- The horizontal scale of the top view parking guideline is based on the absence of a driver in a vehicle. This shows the tailgate opening distance and the distance of about 4.9 ft. (1.5 m) from the vehicle.

## Rear View Monitor Operation

### *Parking/View button*

Press the Parking/View button (1) while the gear is in P (Park), D (Drive) or N (Neutral) to turn on the Rear View Monitor.



### *Rear view*

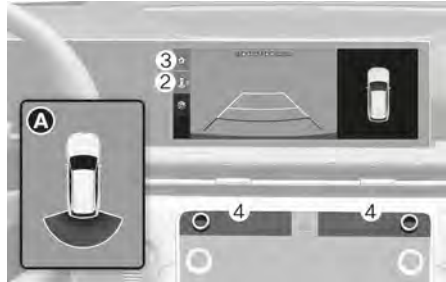

#### **Turns on if:**

- You shift the gear to R (Reverse).
- You press the Parking/View button (1) when the gear is in N (Neutral) or D (Drive), and your vehicle speed is 6 mph (10 km/h) or less.
- Select the rear top view, rear view [A] or rear wide-view from the view button (2).

#### **Turns off if:**

- You shift the gear to P (Park).
- You press the Parking/View button (1).
- You press the Home button (3).
- You press the infotainment system buttons (4).
- You shift the gear to N (Neutral) or D (Drive), and your vehicle speed is above 6 mph (10 km/h).

#### *i* Information

The rear view cannot be turned off when the gear is in R (Reverse).

### **Extended rear view function**

The rear view maintains on the screen when you shift the gear from R (Reverse) to N (Neutral) or D (Drive).

#### **Keep the rear view turned on if:**

- You shift the gear from R (Reverse) to N (Neutral) or D (Drive), and your vehicle speed is 6 mph (10 km/h) or less.

#### **Turns off if:**

- You shift the gear to P (Park).
- You press the Parking/View button (1).
- You press the Home button (3).
- You press the infotainment system buttons (4).
- Your vehicle speed is above 6 mph (10 km/h).

### **Rear top view**

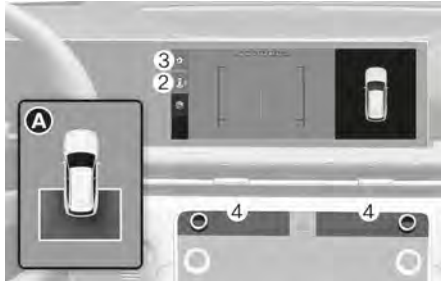

Select the rear top view mode [A] from the view buttons (2).

The top view appears on the screen and the distance from the vehicle appears in the back of your vehicle.

### **i Information**

- The rear view in all modes cannot be turned off when the gear is in R (Reverse).
- The rear view is always displayed when the gear is in R (Reverse).
- The rear parking guidelines appear when the rear view or rear top view is displayed. (The parking guidelines appear only when **Rear View Parking Guide Lines** is selected from the Settings menu in the infotainment system.).

### **Rear View Monitor Malfunction And Limitations**

#### **Rear View Monitor malfunction**

When Rear View Monitor is not working properly, or the screen flickers, or the camera image does not appear normally, have your vehicle inspected by an authorized retailer of Genesis Branded products.

#### **Detecting sensors**

Refer to the "Driver Assistance System Sensors" section in this chapter for the location and the general precautions of the wide-rear view camera.

### Limitations of Rear View Monitor

When your vehicle is stopped for a long time in winter or your vehicle is parked in an indoor parking lot, the exhaust fumes can temporarily blur the image.

#### **WARNING**

- Always turn your head to check blind spots. The rear view camera does not cover the entire area behind your vehicle.
- The rear view monitor displays the screen configured with the optics and rear camera so that the perceived distance on the screen may differ from the actual distance. When a vehicle is slightly tilted due to the weight and location of freight, the parking guideline may not be aligned with the actual distance. Check your surroundings for your safety.
- Always keep the rear view camera lens clean. If the lens is blocked or covered, the Rear View Monitor may not operate normally. Do not clean with strong chemicals containing high alkaline or volatile organic solvents (e.g. gasoline, acetone).

## Surround View Monitor (SVM)

**+** If equipped

Surround View Monitor displays images around your vehicle through the infotainment system screen when parking.

### Surround View Monitor Settings

#### Warning methods



With the engine on, select **Setup > Vehicle > Driver Assistance > Warning Methods** from the Settings menu in the infotainment system to select the following:

- **Parking Safety Priority:** The vehicle lowers all other audio volumes when a parking assist view is active.

#### **i** Information

- If you change the warning methods, the warning methods of other Driver Assistance systems may change.
- When the engine is restarted, the warning methods maintains its last setting.
- The setting menu may not be available for your vehicle depending on the vehicle features and specifications.

## Camera settings

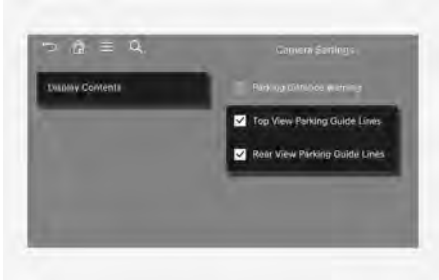

To change the settings of Surround View Monitor's display contents, press the setup icon (⚙️) on the screen while Surround View Monitor is operating, or select **Setup > Vehicle > Driver Assistance > Parking Safety > Camera Settings** from the Settings menu in the infotainment system while the engine is on.

- If **Display Contents** is selected, you can change settings for **Parking Distance Warning**, **Top View Parking Guide Lines** and **Rear View Parking Guide**.

### Parking distance warning

If **Parking Distance Warning** is selected, the parking distance warning appears on the right side of the Surround View Monitor screen.

### Top view reference lines

If **Top View Parking Guide Lines** is selected, the parking guideline appears on the right side of the Surround View Monitor screen.

#### *i* Information

The rear top view horizontal guideline shows the liftgate opening distance of about 6.6 ft. (2 m) from the vehicle.

### Rear view reference lines

If **Rear View Parking Guide** is selected, the parking guideline appears in the rear view.

#### *i* Information

The rear view horizontal guideline shows the distance of about 1.6 ft. (0.5 m), 3.3 ft. (1 m), and 7.6 ft. (2.3 m).

### Surround View Monitor Auto On

With the engine on, select **Setup > Vehicle > Driver Assistance > Parking Safety > Surround View Monitor Auto On** from the Settings menu in the infotainment system to use the function.

#### *i* Information

For more information on Surround view monitor auto On, refer to "Surround View Monitor Operation" in this chapter.

## Surround View Monitor Operation

Press the Parking/View button (1) to turn on Surround View Monitor.

Press the button again to turn off the function.



### Front view

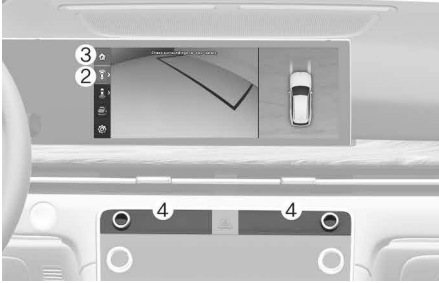

The front view appears on the screen when the gear is in N (Neutral) or D (Drive) to assist parking. The front view has top view, front view, side view, and 3D view.

View modes can be selected by pressing the view buttons (2) on the Surround View Monitor screen.

#### Turns on if:

- You shift the gear from R (Reverse) to N (Neutral) or D (Drive).
- You press the Parking/View button (1) when the gear is in P (Park), N (Neutral), or D (Drive), and your vehicle speed is 6 mph (10 km/h) or less.
- **Surround View Monitor Auto On** function is operating.

(**Surround View Monitor Auto On** must be selected from the Settings menu.)

### *i* Information

When the front view while parking is turned on, the previous view mode will be displayed.

#### Turns off if:

- You shift the gear to P (Park) or R (Reverse).
- You press the Parking/View button (1).
- You press the Home button (3).
- You press the infotainment system buttons (4).
- Your vehicle speed is above 6 mph (10 km/h).

### *i* Information

Surround View Monitor turns off when vehicle speed is above 10 km/h. The function does not turn on again if vehicle speed is below 6 mph (10 km/h).

### Rear view

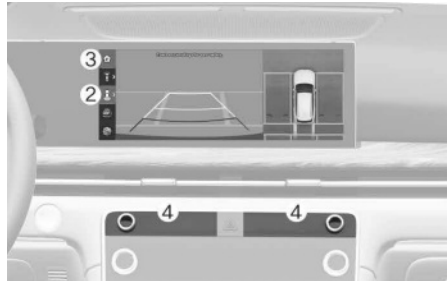

The rear view appears on the screen to assist parking. The rear view has top view, rear view, side view, and 3D view.

View modes can be selected by pressing the view buttons (2) on the Surround View Monitor screen.

#### Turns on if:

- You shift the gear to R (Reverse).
- You press the Parking/View button (1) when the gear is in P (Park), N (Neutral), or D (Drive), and your vehicle speed is below 6 mph (10 km/h).



**Turns off if:**

- You shift the gear from N (Neutral) or D (Drive) to P (Park).
- You press the Parking/View button (1) when the gear is in P (Park), N (Neutral), or D (Drive).
- You press the Home button (3) when the gear is in P (Park), N (Neutral), or D (Drive).
- You press the infotainment system buttons (4) when the gear is in P (Park), N (Neutral), or D (Drive).
- Your vehicle speed is above 6 mph (10 km/h) when the gear is in D (Drive).
- You shift the gear from R (Reverse) to P (Park).

***i* Information**

- The rear view is always displayed when the gear is in R (Reverse).
- The rear view cannot be turned off when the gear is in R (Reverse) even if the infotainment system buttons (4) are pressed.

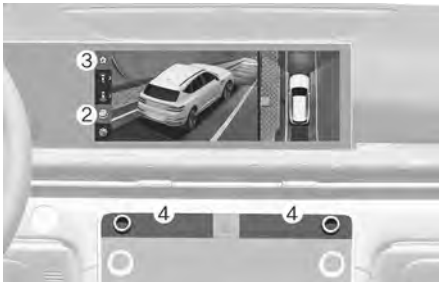
**3D view**

The 3D view shows the image around the vehicle from various angles.

Tap the screen to change vehicle angles. Press the 3D view button (2) again to return to the initial angle.

**Turns on if:**

- You press the 3D view button (2) when the gear is in P (Park), N (Neutral), or D (Drive), and your vehicle speed is below 6 mph (10 km/h).
- You press the 3D view button (2) when Surround View Monitor is turned on when the gear is in R (Reverse).

**Turns off if:**

- You shift the gear from N (Neutral) or D (Drive) to P (Park).
- You press the Parking/View button (1) when the gear is in P (Park), N (Neutral), or D (Drive).
- You press the Home button (3) when the gear is in P (Park), N (Neutral), or D (Drive).
- You press the infotainment system buttons (4) when the gear is in P (Park), N (Neutral), or D (Drive).
- Your vehicle speed is above 6 mph (10 km/h) when the gear is in D (Drive).
- You shift the gear from R (Reverse) to P (Park).

***i* Information**

3D view does not display guidelines.

## Surround View Monitor Malfunction And Limitations

### *Surround View Monitor malfunction*

When Surround View Monitor is not working properly, or the screen flickers, or the camera image does not appear normally, have your vehicle inspected by an authorized retailer of Genesis Branded products.

### *Detecting sensors*

Refer to the "Driver Assistance System Sensors" section in this chapter for the location and the general precautions of the wide-front view camera, wide-side view camera, and wide-rear view camera.

### *Limitations of Surround View Monitor*

- When your vehicle is stopped for a long time in winter or your vehicle is parked in an indoor parking lot, the exhaust fumes may temporarily blur the image.
- The screen may not display the surround view properly and an icon may appear at the top left of the screen if:
  - The liftgate is opened.
  - The driver or front passenger door is opened.
  - The side view mirror is folded.

### **WARNING**

- Always look around your vehicle to make sure there are no objects or obstacles before driving.
  - The perceived distance on the screen may differ from the actual distance.
  - Surround View Monitor is designed to be used on a flat surface. When your vehicle is used on roads with different heights such as curbs and speed bumps, the image on the screen may not look correct.
  - Always keep the camera lens clean. If the lens is blocked or covered, the Surround View Monitor may not operate normally. Do not clean with strong chemicals containing high alkaline or volatile organic solvents (gasoline, acetone etc.).
- 

### **Information**

Surround View Monitor uses the cameras installed on the vehicle to show images around the vehicle through the infotainment system. The image shown on the screen may look unnatural depending on the surroundings.

---

## Rear Cross-Traffic Collision-Avoidance Assist (RCCA)

Rear Cross-Traffic Collision-Avoidance Assist helps detect vehicles approaching from the rear left or right while your vehicle is reversing, and warns you of a possible collision with a warning message and an audible warning. Braking may also be assisted to avoid a collision.

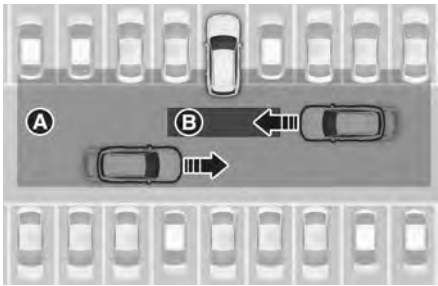

- [A] Rear Cross-Traffic Collision Warning operating range  
 [B] Rear Cross-Traffic Collision-Avoidance Assist operating range

### CAUTION

The warning timing may differ depending on the speed of the detected vehicle.

## Rear Cross-Traffic Collision-Avoidance Assist Settings

### *Rear Cross-Traffic Safety*



With the engine on, select **Setup > Vehicle > Driver Assistance > Parking Safety > Rear Cross-Traffic Safety** from the Settings menu in the infotainment system to turn on Rear Cross-Traffic Collision-Avoidance Assist and deselect to turn off the function.

### WARNING

When the engine is restarted, Rear Cross-Traffic Collision-Avoidance Assist turns on. If **Rear Cross-Traffic Safety** is deselected after the engine is restarted, Rear Cross-Traffic Collision-Avoidance Assist does not function until the next time your vehicle is started.

## Warning methods

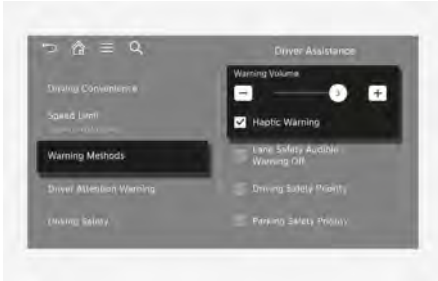

With the engine on, select **Setup > Vehicle > Driver Assistance > Warning Methods** from the Settings menu in the infotainment system to select the following:

- **Warning Volume:** The warning volume can be adjusted.
- **Haptic Warning:** The steering wheel vibration can be set.

### **i** Information

- If you change the warning methods, the warning methods of other Driver Assistance systems may change.
- If you set the warning volume to '0' when the haptic warning is off, the haptic warning turns on.
- When the engine is restarted, the warning methods maintains its last setting.
- The setting menu may not be available for your vehicle depending on the vehicle features and specifications.

## Rear Cross-Traffic Collision-Avoidance Assist Operation

### Collision warning

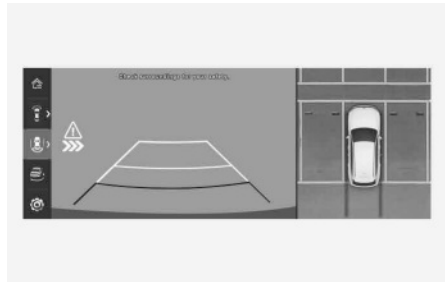

To warn you of an approaching vehicle from the rear left or right of your vehicle, the warning light on the side view mirror may blink, a warning message may appear on the instrument cluster, an audible warning may sound, and the steering wheel may vibrate.

When Rear View Monitor or Surround View Monitor is operating, a warning may appear on the infotainment system screen.

Collision warning may operate if:

- You shift the gear to R (Reverse) and your vehicle speed is below 5 mph (8 km/h).
- The approaching vehicle is detected within about 82 ft. (25 m) from the left or right of your vehicle.

- The speed of the vehicle approaching from the left or right is above 3 mph (5 km/h).

### **i** Information

- If the operating conditions are met, a warning is provided whenever a vehicle approaches from the left or right even though your vehicle speed is 0 mph (0 km/h).
- The images and colors in the cluster may differ depending on the cluster type or theme selected from the cluster.

### **Emergency braking**

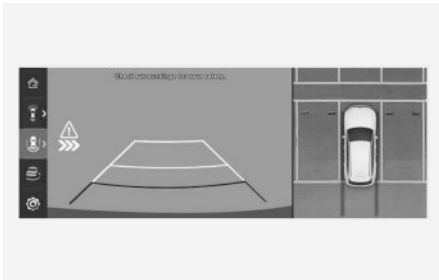

To warn you of an approaching vehicle from the rear left or right of your vehicle, the warning light on the side view mirror may blink, a warning message may appear on the instrument cluster, an audible warning may sound, and the steering wheel may vibrate.

When Rear View Monitor or Surround View Monitor is operating, a warning may appear on the infotainment system screen.

If a collision is imminent, emergency braking is assisted to help prevent collision with approaching vehicles from the left and right side or your vehicle.

Emergency braking may operate if:

- The gear is shifted to R (Reverse) and your vehicle speed is below 5 mph (8 km/h).
- The approaching vehicle is detected within about 5 ft. (1.5 m) from the left or right of your vehicle.
- The speed of the vehicle approaching from the left or right is above 3 mph (5 km/h).

### **! WARNING**

Brake control ends when:

- The approaching vehicle is out of the detection range.
- The approaching vehicle passes behind your vehicle.
- The approaching vehicle does not drive toward your vehicle.
- The approaching vehicle speed slows down.
- You depress the brake pedal sufficiently in response to the potential hazard detected by the function.

### **Stopping vehicle and ending brake control**

After your vehicle is stopped following an Emergency Braking event, the "**Drive carefully**" warning message appears on the instrument cluster.

Depress the brake pedal immediately and check the surroundings.

- Braking control ends about 2 seconds after your vehicle is stopped.
- During Emergency Braking, braking control by Rear Cross-Traffic Collision-Avoidance Assist may be automatically canceled when you depress the brake pedal with sufficient force.

### **WARNING**

Rear Cross-Traffic Collision-Avoidance Assist may not operate in all situations and cannot avoid all collisions.

To prevent serious injury or death:

- Only change the settings after parking the vehicle at a safe location.
- Always look over your shoulder for possible hazards and make sure it is safe to back up.
- When other system's warning message appears or audible warning is heard, Rear Cross-Traffic Collision-Avoidance Assist may not warn you.
- You may not hear the audible warning of Rear Cross-Traffic Collision-Avoidance Assist if the surrounding environment is too noisy.
- During Rear Cross-Traffic Collision-Avoidance Assist operation, your vehicle may stop suddenly. Always wear your seatbelt, check your occupants have their seat belts fastened and secure loose objects that may become projectiles.

- Rear Cross-Traffic Collision-Avoidance Assist may not operate if you apply the brake pedal with sufficient force in response to the potential hazard detected by the system.
- Even if there is an issue with Rear Cross-Traffic Collision-Avoidance Assist, the vehicle's braking system operates normally.
- When Rear Cross-Traffic Collision-Avoidance Assist is operating, braking assist is automatically canceled when you depress the accelerator pedal with sufficient force.
- Rear Cross-Traffic Collision-Avoidance Assist may warn you late or may not warn you depending on the road and driving conditions.
- Control your vehicle at all times. It is your responsibility to operate your vehicle in a safe manner. Do not solely rely on the Rear Cross-Traffic Collision-Avoidance Assist to avoid a collision. Rather, maintain a safe braking distance, and if needed, reduce your vehicle speed or depress the brake pedal to reduce the driving speed or to stop your vehicle.
- Never attempt to activate Rear Cross-Traffic Collision-Avoidance Assist by intentionally driving toward people, animals, objects, or other vehicles.

---

### **WARNING**

Braking is not assisted and only a warning is provided when:

- The ESC (Electronic Stability Control) warning light is on.
  - ESC (Electronic Stability Control) is controlling the brake force to the wheels.
-

## *i* Information

After shifting the gear to R (Reverse), Rear Cross-Traffic Collision-Avoidance Assist operates once for left or right vehicle's approach.

## Rear Cross-Traffic Collision-Avoidance Assist Malfunction And Limitations

### *Rear Cross-Traffic Collision-Avoidance Assist malfunction*



When Rear Cross-Traffic Collision-Avoidance Assist is not working properly, the "**Check Driver Assistance system**" warning message may appear for several seconds, and the  warning light may illuminate on the instrument cluster. Have your vehicle inspected by an authorized retailer of Genesis Branded products.



When the side view mirror warning light is not working properly, the "**Check side view mirror warning light**" warning message may appear for several seconds, and the  warning light may illuminate on the instrument cluster. If recommend that your vehicle be inspected by an authorized retailer of Genesis Branded products.

### *Rear Cross-Traffic Collision-Avoidance Assist disabled*



If the rear corner radar is blocked or covered, or when the rear bumper around the rear corner radar or sensor is covered by any foreign material, such as snow, rain, or dirt, or when a trailer or hitch mounted carrier is installed, the detecting performance may reduce and temporarily limit or disable Rear Cross-Traffic Collision-Avoidance Assist.

The "**Driver assistance system limited. Radar blocked.**" warning message may appear on the instrument cluster.

The function operates normally when such foreign material, trailer, or carrier is removed, and the engine is restarted.

If Rear Cross-Traffic Collision-Avoidance Assist does not operate normally after anything covering or blocking the sensors is removed, have your vehicle inspected by an authorized retailer of Genesis Branded products.

**! WARNING**

- Rear Cross-Traffic Collision-Avoidance Assist may not operate properly even if there is no warning message or warning light on the instrument cluster.
- Rear Cross-Traffic Collision-Avoidance Assist may not operate properly in open areas where no objects are detected (e.g. empty parking lot) or when the detecting sensors are blocked right after turning on the engine.
- Always turn off Rear Cross-Traffic Collision-Avoidance Assist when towing a trailer or using a hitch mounted carrier.

**Detecting sensors**

Refer to the "Driver Assistance System Sensors" section in this chapter for the location and the general precautions of the rear corner radar.

**Limitations of Rear Cross-Traffic Collision-Avoidance Assist**

Rear Cross-Traffic Collision-Avoidance Assist may not operate normally, or may operate unexpectedly if:

- Departing from where trees or grass are overgrown.
- Departing from where roads are wet.
- Speed of the approaching vehicle is fast or slow.

Braking may not be assisted if:

- Your vehicle severely vibrates while driving over a bumpy road, uneven road, or concrete patch.
- You are driving on a slippery surface due to snow, water puddle, ice, etc.
- The tire pressure is low or a tire is damaged.
- The braking system is adjusted differently from the factory default settings.

- Remote Smart Parking Assist is operating (if equipped).

**i Information**

For more information on the limitations of the rear corner radar, refer to the "Driver Assistance System Sensors" section in this chapter.

**! WARNING**

- **Driving near a vehicle or structure**

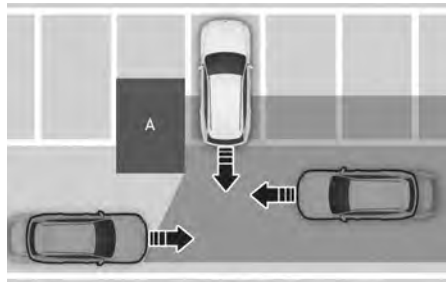

[A] Structure

Rear Cross-Traffic Collision-Avoidance Assist may be limited when driving near another vehicle or a structure, and it may not detect the vehicle approaching from the left or right. The system may not activate a warning or brake your vehicle.

Always check your surroundings while backing up.



- **When your vehicle is in a complex parking environment**

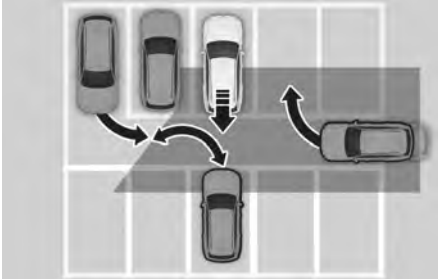

Rear Cross-Traffic Collision-Avoidance Assist may detect vehicles that are parking or pulling out near your vehicle (e.g. leaving beside your vehicle, parking or pulling out behind your vehicle, approaching your vehicle making a turn). If this occurs, the function may activate a warning and brake your vehicle even when not needed.

Always check your surroundings while backing up.

- **When your vehicle is parked diagonally**



Rear Cross-Traffic Collision-Avoidance Assist may be limited when backing up diagonally, and may not detect any vehicle approaching from the left or right. If this occurs, the function may not activate a warning or brake your vehicle.

Always check your surroundings while backing up.

- **When your vehicle is on or near a slope**

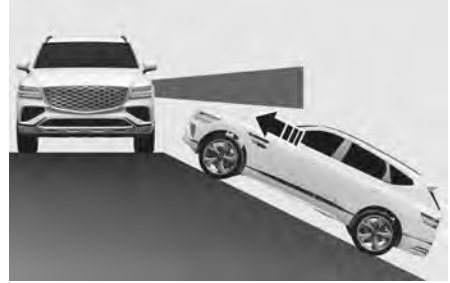

Rear Cross-Traffic Collision-Avoidance Assist may be limited when your vehicle is on an uphill or downhill slope, and may not detect any vehicle approaching from the left or right. If this occurs, the function may activate a warning and brake your vehicle even when not needed.

Always check your surroundings while backing up.

- **Pulling into the parking space where there is a structure**

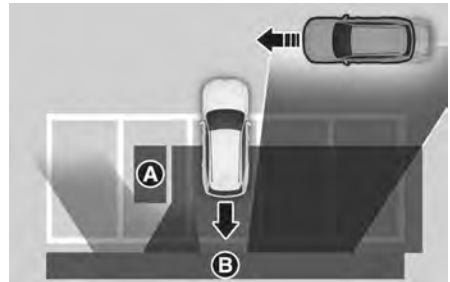

[A] Structure  
[B] Wall

Rear Cross-Traffic Collision-Avoidance Assist may detect vehicles passing by in front of you when parking in reverse into a parking space with a wall or structure in the rear or side area. If this occurs, the function may activate a warning or brake your vehicle.

Always check your surroundings while backing up.

- **When your vehicle is parked rearward**



Rear Cross-Traffic Collision-Avoidance Assist may detect vehicles passing by behind you when parking in reverse into a parking space. If this occurs, the function may activate a warning and brake your vehicle even when not needed.

Always check your surroundings while backing up.

**! WARNING**

- Rear Cross-Traffic Collision-Avoidance Assist may not operate normally if there is interference from strong electromagnetic waves.
- Rear Cross-Traffic Collision-Avoidance Assist may not operate for 3 seconds right after your vehicle is started or when the rear corner radars are initialized.

**i Information**

This device complies with Part 15 of the FCC rules.

Operation is subject to the following three conditions:

- This device may not cause harmful interference, and
- This device must accept any interference received, including interference that may cause undesired operation.
- Changes or modifications not expressly approved by the party responsible for compliance could void the user's authority to operate the device.

**i Information**

Radio frequency radiation exposure information:

This equipment complies with FCC radiation exposure limits set forth for an uncontrolled environment.

This equipment should be installed and operated with minimum distance of 8 in. (20 cm) between the radiator (antenna) and your body.

This transmitter must not be co-located or operating in conjunction with any other antenna or transmitter.

## Parking Distance Warning (PDW)

Parking Distance Warning uses the front ultrasonic sensors, side ultrasonic sensor (if equipped), and rear ultrasonic sensors to detect and warn you if an obstacle is within a certain distance when your vehicle is moving forward or in reverse at low speeds.

## Parking Distance Warning Settings

### Warning methods

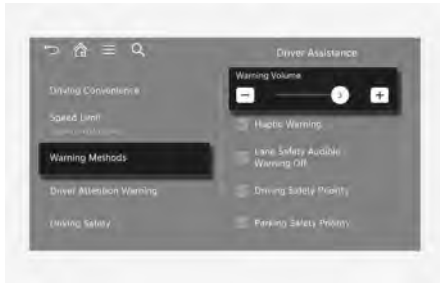

With the engine on, select **Setup > Vehicle > Driver Assistance > Warning Methods** from the Settings menu in the infotainment system to select the following:

- **Warning Volume:** The warning volume can be adjusted. If you set the warning volume to '0', the warning volume does not turn off but sounds as '1'.

### *i* Information

- If you change the warning methods, the warning methods of other Driver Assistance systems may change.
- When the engine is restarted, the warning methods maintains its last setting.
- The setting menu may not be available for your vehicle depending on the vehicle features and specifications.

### *Parking Distance Warning Auto On*

With the engine on, select **Setup > Vehicle > Driver Assistance > Parking Safety > Parking Distance Warning Auto On** from the Settings menu in the infotainment system to use Parking Distance Warning Auto On.

### *i* Information

When **Parking Distance Warning Auto On** is selected, the Parking Safety (P<sup>W</sup>) button indicator stays on.

## Parking Distance Warning Operation

### Parking Safety button



Press the Parking Safety (PWS) button to turn on Parking Distance Warning. Press the button again to turn off the function.

- When Parking Distance Warning is off (button indicator light off), if you shift the gear to R (Reverse), Parking Distance Warning automatically turns on.

### Forward Parking Distance Warning

Forward Parking Distance Warning may operate if:

- You shift the gear from R (Reverse) to D (Drive).
- The gear is in D (Drive) and the Parking Safety button indicator light is on.
- An obstacle is detected while driving in D (Drive).

**(Parking Distance Warning Auto On must be selected from the Settings menu.)**

### *i* Information

- Forward Parking Distance Warning operates only when the vehicle's forward speed is below 6 mph (10 km/h).
- If your vehicle speed is greater than 18 mph (30 km/h), Forward Parking Distance Warning turns off (button indicator light off). Although you slow down to less than 6 mph (10 km/h) again, Forward Parking Distance Warning does not turn on again.

- When the gear is shifted to R (Reverse), the warning only detects an object with a height below 24 in. (60 cm) and does not detect an object located on the inner front side.

Distance from object	Warning indicator		Warning sound
	Cluster	Infotainment	
24-48 in. (60-120 cm)			Buzzer beeps intermittently (front inside)
12-24 in. (30-60 cm)			Buzzer beeps more frequently
within 12 in. (30 cm)			Buzzer beeps continuously

- The corresponding indicator illuminates whenever each ultrasonic sensor detects a person or object in its sensing range and an audible warning sounds.
- When more than two objects are detected at the same time, an audible warning sounds for the object closest to your vehicle.
- When the distance with an object is more than 24 in. (60 cm), the front side warning will not display on the cluster.
- The shape of the indicator in the illustration may differ from the actual vehicle.

**Side Parking Distance Warning**

if equipped

Side Parking Distance Warning may operate if:

- You shift the gear to R (Reverse).
- You shift the gear from R (Reverse) to D (Drive).
- The gear is in D (Drive) and the Parking Safety (P) button indicator light is on.
- An obstacle is detected while driving in D (Drive).

**(Parking Distance Warning Auto On (or Auto PDW (Parking Distance Warning)) must be selected from the Settings menu.)**

**i Information**

- Side Parking Distance Warning operates when the vehicle's forward speed is below 6 mph (10 km/h).
- Side Parking Distance Warning operates only when Forward or Reverse Parking Distance Warning is on.

Distance from object	Warning indicator		Warning sound
	Cluster	Infotainment	
24-48 in. (60-120 cm)			-
12-24 in. (30-60 cm)			-
within 12 in. (30 cm)			Buzzer beeps continuously

- The corresponding indicator illuminates whenever each ultrasonic sensor detects a person or object in its sensing range.

- If an object located within 12 in. (30 cm) from the side of the vehicle's path is detected, an audible warning sounds.
- If an object outside the side of the vehicle's path is detected, the warning indicator is appears.
- The shape of the indicator in the illustration may differ from the actual vehicle.

**Reverse Parking Distance Warning**

Reverse Parking Distance Warning may operate if:

- You shift the gear to R (Reverse).

Distance from object	Warning indicator		Warning sound
	Cluster	Infotainment	
24-48 in. (60-120 cm)			Buzzer beeps intermittently
12-24 in. (30-60 cm)			Buzzer beeps more frequently
within 12 in. (30 cm)			Buzzer beeps continuously

- The corresponding indicator illuminates whenever each ultrasonic sensor detects a person or object in its sensing range and an audible warning sounds.
- When more than two objects are detected at the same time, the an audible warning sounds for the object closest to your vehicle.
- The shape of the indicator in the illustration may differ from the actual vehicle.

## Parking Distance Warning Malfunction And Limitations

### *Parking Distance Warning malfunction*

After starting the engine, a beep sounds when the gear is shifted to R (Reverse) to indicate Parking Distance Warning is operating normally.

If one or more of the following occurs, check whether the ultrasonic sensor is damaged or blocked.

- The audible warning does not sound.
- The buzzer sounds intermittently.
- The **"Check Driver Assistance system."** warning message appears on the instrument cluster.
- If it still does not work properly, have your vehicle inspected by an authorized retailer of Genesis Branded products.

### *Parking Distance Warning disabled*



If the ultrasonic sensor is blocked or covered by any foreign material, such as snow, rain, or dirt, the detecting performance may reduce and temporarily limit or disable Parking Distance Warning.

The **"Driver Assistance system limited. Ultrasonic sensor blocked."** warning message may appear on the instrument cluster.

The function operates normally when such foreign material, trailer, or carrier is removed, and the engine is restarted.

If the Parking Distance Warning does not operate normally after anything covering or blocking the sensors is removed, have your vehicle inspected by an authorized retailer of Genesis Branded products.

### *i* Information



When the Parking Distance Warning is operating, if the function is not working normally or the ultrasonic sensor is blocked, the  warning light may illuminate in the direction of the corresponding sensor.

### **Detecting sensors**

Refer to the "Driver Assistance System Sensors" section in this chapter for the location and the general precautions of the front, front side, rear and rear side ultrasonic sensors.

### **Limitations of Parking Distance Warning**

- Parking Distance Warning may not operate normally when:
  - Any sensor is covered or blocked with snow, water, or dirt. Parking Distance Warning operates normally again when unblocked or uncovered.
  - The weather is very hot or cold.
  - The sensor or sensor assembly is disassembled.
  - The surface of the sensor has been damaged or scratched with a sharp object.
  - The sensors or its surrounding area is directly sprayed with high pressure washer.
  - Objects generating excessive noise, such as vehicle horns, loud motorcycle engines, or truck air brakes, are near your vehicle.
- Parking Distance Warning may malfunction when:
  - Heavy rain or water spray is present.
  - Water flows on the surface of the sensor.
  - The sensor is covered with snow or ice.
  - An ultrasonic sensor with similar frequency is near your vehicle.
  - Driving on uneven road, gravel roads, or bushes.
  - Your vehicle's bumper height or ultrasonic sensor installation has been modified.
  - Equipment, license plate, or accessories are attached near the ultrasonic sensors.
- The following objects may not be detected:
  - Slim objects such as ropes, chains, or small poles.
  - Narrow objects such as corners of a square column.
  - Objects that tend to absorb sensor frequency, such as clothes, spongy material, or snow.
  - Objects less than 40 in. (100 cm) high and less than 6 in. (14 cm) wide.
  - Pedestrians, animals, or objects that are very close to the ultrasonic sensors.
  - An object in the side area between the front side ultrasonic sensor and the rear side ultrasonic sensor.

### **WARNING**

- The operation of Parking Distance Warning can be affected by several factors (including environmental conditions). Parking Distance Warning is a supplemental function only.
- Your new vehicle warranty does not cover any accidents or damage to the vehicle due to the malfunction of Parking Distance Warning.
- Always turn your head and look for potential hazards around your vehicle when parking.
- To prevent serious injury or death, pay close attention when driving near objects, pedestrians, and especially children. Some objects may not be detected by ultrasonic sensors, due to the object's distance, size, or material.

## Forward/Side/Reverse Parking Collision-Avoidance Assist (PCA)

 if equipped

Forward/Side/Reverse Parking Collision-Avoidance Assist helps detect pedestrians or objects when driving at low speed. The function may warn you or assist you with braking to help reduce the possibility of a collision.

## Parking Collision-Avoidance Assist Settings

### Warning methods



With the engine on, select **Setup > Vehicle > Driver Assistance > Warning Methods** from the Settings menu in the infotainment system to select the following:

- **Warning Volume:** The warning volume can be adjusted. If you set the warning volume to '0', the warning volume does not turn off but sounds as '1'.
- **Haptic Warning:** The steering wheel vibration can be set.

### *i* Information

- If you change the warning methods, the warning methods of other Driver Assistance systems may change.
- If you set the warning volume to '0' when the haptic warning is off, the haptic warning turns on.
- When the engine is restarted, the warning methods maintains its last setting.
- The setting menu may not be available for your vehicle depending on the vehicle features and specifications.

### *Parking Safety*

With the engine on, select **Setup > Vehicle > Driver Assistance > Parking Safety** from the Settings menu in the infotainment system to select the following:

- If **Forward/Side Safety** is selected, Parking Collision-Avoidance Assist warns you and assists braking when a collision with a pedestrian or object is imminent from the front or side.
- If **Rear Safety** or **Backward Safety** is selected, Parking Collision-Avoidance Assist warns you and assists braking when a collision with a pedestrian or object is imminent from behind.

### *i* Information

**Forward/Side Safety** can be selected only when **Rear Safety** is selected. When the engine is restarted and **Rear Safety** is selected, and **Forward/Side Safety** maintains the last setting.



## Parking Collision-Avoidance Assist Operation

### Turning Parking Collision Avoidance Assist On/Off

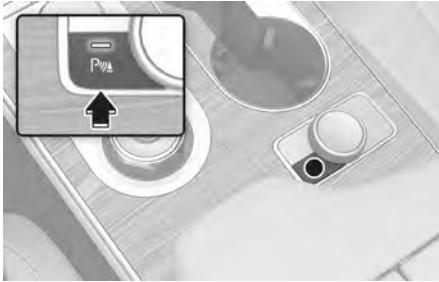

Press and hold the Parking Safety (PWA) button more than 2 seconds, to turn the Parking Collision-Avoidance Assist on or off.

### Operating conditions

If Parking Collision-Avoidance Assist detects a collision risk with a pedestrian or object, Parking Collision-Avoidance Assist warns you with an audible warning and warning message on the cluster. When Surround View Monitor is operating, a warning may appear on the infotainment system screen.

If Parking Collision-Avoidance Assist detects an imminent collision with a pedestrian or object behind your vehicle, Parking Collision-Avoidance Assist may assist braking.

If **Rear Safety** (or **Backward Safety**) is selected from the settings menu, Parking Collision-Avoidance Assist is in ready status when all of the following conditions are met:

### Rear safety

- The liftgate and door are closed.
- The EPB (Electronic Parking Brake) is released.
- The gear is shifted to R (Reverse).
- Vehicle speed is below 6 mph (10 km/h) (for detecting pedestrians).
- Vehicle speed is below 2 mph (4 km/h) (for detecting objects).
- Parking Collision-Avoidance Assist components such as the rear view camera and the rear ultrasonic sensors are in normal conditions.

### Front/Side safety

- The liftgate and door are closed.
- The Electronic Parking Brake (EPB) is released.
- The gear is shifted to R (Reverse) or D (Drive).
- Vehicle speed is below 2 mph (4 km/h) (for detecting pedestrians and objects).
- Parking Collision-Avoidance Assist components such as the wide view cameras and the ultrasonic sensors are in normal conditions.

When Parking Collision-Avoidance Assist activates, a line appears near the vehicle image in the instrument cluster.

- **Rear Safety:** Appears behind the vehicle image.
- **Front/Side Safety:** Appears in front or side of the vehicle image.



## *i* Information

Parking Collision-Avoidance Assist operates only once after shifting the gear to R (Reverse) or D (Drive). To reactivate Parking Collision-Avoidance Assist, shift the gear from another gear to R (Reverse) or D (Drive).

### **Off conditions**

#### **Rear safety**

If Parking Collision-Avoidance Assist detects an imminent collision with a pedestrian or object behind your vehicle, Parking Collision-Avoidance Assist may assist braking. Immediately depress the brake pedal and check vehicle surroundings because the brake assist ends within 5 minutes.

Braking control ends when:

- You shift the gear to P (Park) or D (Drive).
- You depress the brake pedal with sufficient force.

## *i* Information

When Parking Collision-Avoidance Assist is activated while reversing, braking control is released after 5 minutes and the EPB (Electronic Parking Brake) is applied.

#### **Front/Side safety**

If Parking Collision-Avoidance Assist detects an imminent collision with a pedestrian or object behind your vehicle, Parking Collision-Avoidance Assist may assist braking. Immediately depress the brake pedal and check vehicle surroundings because the brake assist ends within 2 seconds when in D (Drive) or 5 minutes when in R (Reverse).

Braking control ends when:

- You shift the gear to P (Park), D (Drive), or R (Reverse).
- You depress the brake pedal with sufficient force.

## **Parking Collision-Avoidance Assist Malfunction And Limitations**

### ***Parking Collision- Avoidance Assist malfunction***



When Parking Collision-Avoidance Assist or other related functions does not work properly, the "**Check Driver Assistance system.**" warning message may appear on the instrument cluster, and Parking Collision-Avoidance Assist turns off automatically. Have your vehicle inspected by an authorized retailer of Genesis Branded products.

## Parking Collision-Avoidance Assist disabled



The "**Driver Assistance system limited. Camera obscured.**" or "**Driver Assistance system limited. Ultrasonic sensor blocked.**" warning message may appear on the instrument cluster if:

- The wide view camera(s) or ultrasonic sensor(s) is covered or blocked with foreign material, such as snow or rain, etc.
- There is inclement weather, such as heavy snow, heavy rain, etc.

Parking Collision-Avoidance Assist may turn off or may not operate properly. Check the wide view camera(s) and ultrasonic sensor(s) are clean.

## *i* Information



When the Parking Collision-Avoidance Assist Warning is operating, if the function is not working normally or the ultrasonic sensor is blocked, the  warning light may illuminate in the direction of the corresponding sensor.

### *Detecting sensors*

Refer to the "Driver Assistance System Sensors" section in this chapter for the location and the general precautions of the wide-front view, wide-rear view, wide-side view camera, front, front side, rear and rear side ultrasonic sensors.

### *Limitations of Parking Collision-Avoidance Assist*

Parking Collision-Avoidance Assist may not assist braking or warn you even if there are pedestrians or objects if:

- Problems with vehicle
  - Any non-factory equipment or accessory is installed on your vehicle.
  - Your vehicle has been damaged due to an accident or other causes.
  - Bumper height or ultrasonic sensor installation locations have been modified.
  - Wide view camera(s) or ultrasonic sensor(s) is damaged.
  - Wide view camera(s) or the ultrasonic sensor(s) is covered or blocked with snow, water, or dirt, etc.

- Wide view camera(s) is obscured by a light source or by inclement weather, such as heavy rain, thick fog, snow, etc.
- Problems with the surroundings
  - The surrounding is very bright or dark.
  - The weather is very hot or cold.
  - The wind is either greater than 12 mph (20 km/h) or blowing perpendicular to the rear bumper.
  - Objects generating excessive noise, such as vehicle horns, loud motorcycle vehicles or truck air brakes, are near your vehicle.
  - An ultrasonic sensor with similar frequency is near your vehicle.
  - The road is slippery or inclined.
- Problems with pedestrian or object
  - The pedestrian is in a state that is difficult to detect.
  - There is an elevation difference between your vehicle and the pedestrian.
  - The pedestrian blends into the background when seen from the front view camera.
  - The pedestrian is near the front or rear edge of the vehicle.
  - The pedestrian is not standing upright.
  - The pedestrian is very short or tall.
  - The pedestrian is wearing clothing that does not reflect ultrasonic waves well.
  - Size, thickness, height, or shape of the object does not reflect ultrasonic waves well (e.g., pole, bush, curbs, carts, edge of a wall, etc.).
  - The pedestrian or object is moving.
  - The pedestrian or object is very close to your vehicle.
  - There is a wall behind the pedestrian or object.
- The object is not located at the front or rear center of your vehicle.
- The object is not parallel to the front or rear bumper.
- The sensors cannot detect pedestrians or objects.
- Problems with driving condition
  - You drive the vehicle immediately after shifting to R (Reverse) or D (Drive).
  - You accelerate your vehicle or drive in circles.
  - You drive your vehicle immediately after starting the engine.

### **WARNING**

Parking Collision-Avoidance Assist may not operate in all situations and cannot avoid all collisions.

To prevent serious injury or death:

- Always pay attention to road and traffic conditions while driving. Brake as needed to avoid collisions. Do not solely rely on Parking Collision-Avoidance Assist.
  - Always look around your vehicle to make sure there are no pedestrians or objects before driving.
  - The performance of Parking Collision-Avoidance Assist may differ under certain conditions. If your vehicle speed is greater than 4 km/h (2 mph), Parking Collision-Avoidance Assist provides collision avoidance assist only when pedestrians are detected.
  - Some objects may not be detected by the ultrasonic sensors due to the object's distance, size, or material.
-

## ⚠ CAUTION

- Noise may be heard when sudden braking occurs to avoid a collision.
- When other system's warning message appears or audible warning is heard, Parking Collision-Avoidance Assist may not warn you.
- You may not hear the audible warning of Parking Collision-Avoidance Assist if the surrounding environment is too noisy.
- Parking Collision-Avoidance Assist may not work properly if the bumper has been damaged, replaced, or repaired.
- Parking Collision-Avoidance Assist may not operate normally if there is interference from strong electromagnetic waves.
- Always turn off Parking Collision-Avoidance Assist when towing a trailer or using a hitch mounted carrier.
- The brake control may not operate properly depending on the status of ESC (Electronic Stability Control).

There is only a warning when:

- The ESC (Electronic Stability Control) warning light is on.
- ESC (Electronic Stability Control) is controlling the brake force to the wheels.
- Check the brake fluid and brake pad condition periodically. Depending on the condition, brake operation performance may reduce.

## *i* Information

Parking Collision-Avoidance Assist can detect a pedestrian or an object when:



- A pedestrian is standing near the vehicle.
- A large obstacle, such as a vehicle, is parked in the near your vehicle.

## Remote Smart Parking Assist 2 (RSPA 2)

 if equipped

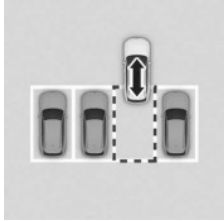
Remote Smart Parking Assist uses vehicle sensors to help you park and exit parking spaces remotely from outside the vehicle by controlling the steering wheel, vehicle speed, and gearshifts.

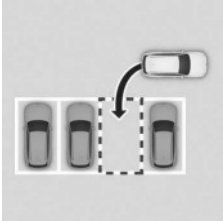
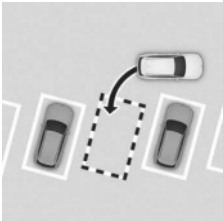
Function	Description
Remote Operation	<p>Remotely moving forward or backward</p> 

Function	Description
Smart Parking or Remote Parking	<p>Perpendicular reverse parking</p> 
	<p>Diagonal reverse parking</p> 
	<p>Parallel reverse parking</p> 
Smart Exit	<p>Parallel forward exit</p> 

- Remote Parking and Remote Operation function may be operated from outside the vehicle using the smart key.
- Smart Parking and Smart Exit function may be operated from inside the vehicle.
- Smart Parking and Remote Parking function helps you with perpendicular reverse parking, diagonal reverse parking, and parallel reverse parking.
- Smart Exit function helps you with parallel forward exit.
- When Remote Smart Parking Assist operates, Parking Distance Warning and Surround View Monitor also operates. For more information, refer to the "Parking Distance Warning (PDW)" and "Surround View Monitor (SVM)" sections in this chapter.
- Remote Smart Parking Assist helps parking by detecting the parking lines with the wide view camera.

## Remote Smart Parking Assist Settings

### Warning methods



With the engine on, select **Setup > Vehicle > Driver Assistance > Warning Methods** from the Settings menu in the infotainment system to select the following:



- **Warning Volume:** The warning volume can be adjusted. If you set the warning volume to '0', the warning volume does not turn off but sounds as '1'.





### *i* Information

- If you change the warning methods, the warning methods of other Driver Assistance systems may change.
- When the engine is restarted, the warning methods maintains its last setting.
- The setting menu may not be available for your vehicle depending on the vehicle features and specifications.

## Remote Smart Parking Assist Operation

### Remote Smart Parking Assist button

Parking/View button	Smart key
	

Location	Name	Symbol	Description
Inside vehicle	Parking/View button		<ul style="list-style-type: none"> <li>Press and hold the Parking/View button to turn on Remote Smart Parking Assist. Also, Forward/Reverse Parking Distance warning automatically turns on. However, functions may differ depending on the situations. Refer to each function's description for more details in the following pages.</li> <li>Press and hold the Parking/View button while Smart Parking or Smart Exit function is on to operate the function.</li> </ul>
Smart key	Remote Start button		<ul style="list-style-type: none"> <li>Press the Remote Start button after the door is locked with the vehicle off to start the vehicle remotely.</li> <li>Press the Remote Start button while Remote Parking or Remote Operation function is operating to end function operation.</li> </ul>
	Forward button		<ul style="list-style-type: none"> <li>When using Remote Parking function, regardless of which direction the button is pressed, parking is supported while the button is pressed.</li> </ul>
	Backward button		<ul style="list-style-type: none"> <li>When using the Remote Operation function, the vehicle moves in the direction of the button while the button is pressed.</li> </ul>



## Remote Operation

### Operating order

#### 1. Getting ready to remotely move forward and backward

There are two ways to operate the Remote Operation function.

Method (1) Using the function with engine off.

1. Within a certain range from the vehicle press the door lock (🔒) button on the smart key and lock all doors.



2. Press and hold the Remote Start (🔑) button within 4 seconds until the engine starts.

For more information on remotely starting the engine, refer to the "Remote Start" section in chapter 6.

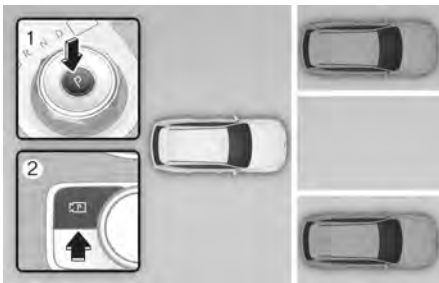

Method (2) Using the function with engine on.

1. Park the vehicle in front of the space where you want to use the Remote Operation function, and shift the gear to P (Park).

2. Press and hold the Parking/View (🅅) button to turn on Smart Parking Assist.
  - The "**Under Remote Control**" message appears on the infotainment system screen.
3. Get out of the vehicle with the smart key and close all doors and liftgate.

### *i* Information

- **Agree** must be selected on the infotainment system and the infotainment system has to operate properly to use the Remote Operation function.
- Method (2) can be used after the vehicle has been driven above 5 km/h (3 mph).
- If the function is turned on again after perpendicular parking is completed by Remote Smart Parking Assist, Remote Operation function can be used with Method (2).
- Check that all smart keys are outside the vehicle when using Remote Operation function. If a smart key is inside the vehicle, the Remote Operation function does not work.

## 2. Remotely moving forward and backward



[A] Forward  
[B] Backward

- Press and hold the Forward (A) or Backward (B) button on the smart key.
  - Remote Smart Parking Assist automatically controls the steering wheel, vehicle speed, and gearshift. Your vehicle moves in the direction of the button pressed.
  - If you do not hold down the Forward (A) or Backward (B) button, your vehicle stops and function control pauses. The function starts operating again when the button is pressed and held again.
- When your vehicle reaches the target location, release the smart key Forward (A) or Backward (B) button.
- Get in your vehicle with the smart key or press the Remote Start (R) button on the smart key from outside the vehicle.
  - A message appears informing you that remotely moving your vehicle forward or backward is complete on the infotainment system screen. The gear is shifted to P (Park) and the EPB is applied.
  - The engine remains on if you are in the vehicle. The engine turns off if you press the Remote Start (R) button.

## i Information

- Check that all smart keys are outside your vehicle before using the Remote Operation function.
- Remote Operation function operates only when the smart key is within 13 ft. (4 m) from your vehicle. If there is no vehicle movement even when the Forward or Backward button is pressed on the smart key, check the distance from the vehicle and press the button again.
- The detection range of the smart key may differ depending on radio waves in the area such as transmission towers or broadcast stations.
- When remotely moving forward using Method (1), it is intended to be a departure scenario, and your vehicle moves 13 ft. (4 m) to check for pedestrians, animals, or objects around your vehicle. Your vehicle makes small steering changes when driving forward.
- When remotely moving forward using Method (2), it is recognized as a parking situation, and immediately controls the steering wheel depending on the condition ahead to assist with entering the parking space and aligning your vehicle. The function performance may be reduced depending on the pedestrians, animals, and objects near your vehicle or other factors.
- When moving remotely backward, both Method (1) and (2) align the steering wheel and then only move your vehicle in a straight path.

## WARNING

- When using Remote Operation function, make sure all passengers have exited your vehicle and are standing in a safe location away from your vehicle.
- If your vehicle's battery is discharged or Remote Smart Parking Assist malfunctions when parked in a narrow parking space, the Remote Operation function does not operate. Always park your vehicle in a space wide enough for you to get in or out of your vehicle.
- Depending on the parking space or the movement of other vehicle after you have parked, you may not be able to exit from the space using the Remote Operation function.
- Before leaving your vehicle, close the windows and sunroof. Make sure the engine is off before locking the doors.



### Remote Operation function operation status

Operation status	Smart key LED	Hazard warning light
Under control	Green LED continuously blinks	-
Pause	Red LED continuously blinks	Blinks
Off	Red LED illuminates for 4 seconds and then turns off	Blinks 3 times and turns off
Complete	Green LED illuminates for 4 seconds and then turns off	Blinks 1 time and turns off



## *i* Information

If the smart key is not within the operating range from the vehicle (about 13 ft. (4 m)), the smart key LED does not illuminate or blink. Use the smart key within the operating range.

### How to turn off Remote Operation function while operating

- Press the Parking/View () button while the infotainment system guides you using method 2.
- Shift the gear except to P (Park) while the infotainment system guides you using method 2.
- Press the Parking Safety () button or select **Cancel** on the infotainment system.
- Press the Remote Start () button on the smart key while the vehicle is being controlled by Remote Operation function. Remote Operation function and the engine turn off.
- Get on your vehicle with the smart key. Remote Operation function turns off and the engine remains on.

### The function pauses in the following conditions when:

- There is a pedestrian, animal, or object detected in the direction your vehicle is moving.
- The door or liftgate is open.
- The Forward () or Backward () button is not continuously pressed.
- Multiple buttons are pressed simultaneously on a smart key.
- The smart key is not operated within 4 m (13 ft.) from your vehicle.
- A button on another smart key is pressed in addition to the operating smart key.

- Parking Collision-Avoidance Assist or Rear Cross-Traffic Collision-Avoidance Assist operates when your vehicle is backing while remotely controlled.
- Your vehicle moves about 22 ft. (7 m) while the smart key button is pressed with Remote Operation function (maximum travel distance per button press).

### The function cancels in the following conditions when:

- The steering wheel is turned.
- The gear is shifted while your vehicle is moving.
- EPB (Electronic Parking Brake) is operating while the vehicle is moving.
- The engine hood is opened.
- The brake pedal or accelerator pedal is depressed when all the doors are closed.
- The smart key is outside your vehicle when the brake pedal is depressed while the driver's door is open.
- Rapid acceleration occurs.
- Vehicle skid occurs.
- An obstacle prevents the wheel from moving.
- About 3 minutes and 50 seconds have passed since Remote Operation function was initiated.
- The slope of the road exceeds the operational range.
- The function is paused for more than 1 minute.
- The total travel distance of your vehicle has exceeded about 45 ft. (14 m) after Remote Operation function is operated.
- The steering wheel, gearshift, braking, and drive controls are not working properly.
- There is a problem with the smart key or the smart key battery is low.

- ABS, TCS or ESC system operates due to slippery road conditions.
- Theft Alarm System sounds.
- When Remote Operation function is canceled, your vehicle automatically stops, shifts the gear to P (Park), and applies EPB (Electronic Parking Brake).

## Smart Parking, Remote Parking

### Operating order

Parking function operates in the following order:

1. Getting ready for parking
2. Searching for parking space
3. Select parking type and operating mode
4. Smart Parking
5. Remote Parking
  - Parking function includes Smart Parking and Remote Parking.

### 1. Getting ready for parking



- With the engine on, depress the brake pedal and shift the gear to D (Drive) or N (Neutral).
- Press and hold the Parking/View (P) button to turn on Remote Smart Parking Assist.

### *i* Information

- **Agree** must be selected on the infotainment system screen and the infotainment system has to operate properly to use Parking function.
- If you drive above 3 mph (5 km/h) with the engine on, you may use the Parking function with the gear shifted to N (Neutral).

## 2. Searching for parking space



- Slowly drive forward maintaining the distance of about 40 in. (100 cm) from the parked vehicles.
  - When searching for a parking space is complete, a message appears informing you that searching for a parking space is complete.
  - Select Parking Type appears on the infotainment system screen and the selected parking space appears on Top View screen of Surround View Monitor.

### *i* Information

- Remote Smart Parking Assist searches for parking lines or parking spaces that are next to parked vehicles, or parking spaces with parked vehicles in front or rear.
- While searching for a parking space, when the vehicle speed is above 12 mph (20 km/h), a message appears on the infotainment system screen informing you to slow down. When vehicle speed is above 18 mph (30 km/h), Parking function turns off.
- Searching for a parking space is completed when there is enough space to move the vehicle in addition to the parking space.
- Even if you are informed that searching for a parking space is complete, Remote Smart Parking Assist may search for a parking space again depending on surroundings.

### *i* Information

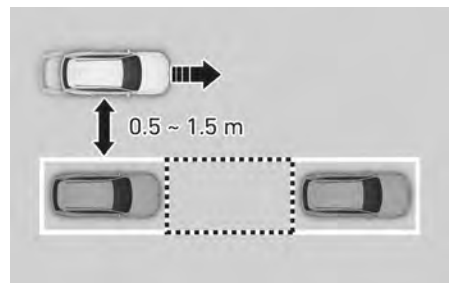

- If the distance is below 20 in. (50 cm) or over 59 in. (150 cm), Remote Smart Parking Assist may not search for a parking space.
- If you do not maintain a certain distance from the parked vehicle, the performance to search for a parking space may reduce.

- Due to abnormal performance of the ultrasonic sensor or the influence of the surroundings, Parking function may not be able to search for a parking space even if there is a parking space, or may search for a space that is not suitable for parking.
- If the parking space is on an incline or if your vehicle is not straight when searching for a parking space, the parking type displayed may be different from the actual parking type which should be selected. If this occurs, do not select the parking type, and search for another parking space.

### 3. Select parking type and operating mode



(1) Parking type - Perpendicular reverse (Left/Right), Parallel reverse (Left/Right), Diagonal reverse (Left/Right)

With the vehicle stopped by depressing the brake pedal, select parking type.

#### **i** Information

- If you continue to drive without stopping after the parking type selection screen appears, Remote Smart Parking Assist returns to the previous stage and searches for a parking space.

- If the Parking function is canceled unintentionally by pressing the Parking/View (P) button before the parking type is selected, you can return to the parking type selection stage by pressing and holding the button again while the vehicle is stopped.

#### **!** CAUTION

Before selecting the Parking type, you should check whether the parking space is suitable.

If the searched parking space is narrow or unsuitable for parking, do not select the Parking type and move the vehicle to search for another parking space.



(2) Operating mode - Remote Parking, Smart Parking

After selecting a parking type, the infotainment system screen guides you with Remote Parking function and Smart Parking function. Follow the instructions to operate Remote Smart Parking Assist.

## *i* Information

- Operating instructions is displayed on the screen for each desired function you select.
- Do not take your foot off the brake pedal during the Parking function guide. When the vehicle moves, Remote Smart Parking Assist turns off.
- If Remote Smart Parking Assist cannot activate Remote Parking function, only the Smart Parking guide is displayed on the infotainment system screen.

### 4. Smart Parking



- Press the Parking/View () button when the vehicle is stopped by depressing the brake pedal. When the brake pedal is released, Remote Smart Parking Assist automatically controls the steering wheel, vehicle speed, and gearshift.

- While Smart Parking function is operating, if you do not hold down the Parking/View button, the vehicle stops and function control pauses. The function starts operating again when the Parking/View button is pressed and held again.
- When the vehicle reaches the target parking position, a message appears informing you that parking your vehicle is complete on the infotainment system screen.

## *i* Information

- Smart Parking function does not operate if the door is open or the seat belt is not fastened.
- The parking location indicator is displayed on the Surround View Monitor screen and is displayed until the vehicle enters the parking space for the first time by the Smart Parking function.
- Vehicle speed can be adjusted by depressing the brake pedal while Smart Parking function is operating. The vehicle does not accelerate even when the accelerator pedal is depressed.
- Depending on parking environments, if the vehicle is stopped by a stopper, parking may be completed.
- If you need to change the vehicle's position or location, manually complete parking your vehicle.

## 5. Remote Parking



- Shift the gear to P (Park), get out of your vehicle with the smart key and close all doors.
- Press and hold the Forward (⏪) or Backward (⏩) button on the smart key.
  - Remote Smart Parking Assist automatically controls the steering wheel, vehicle speed, and gearshift. Your vehicle moves in the direction of the button pressed.
  - If you do not hold down the Forward (⏪) or Backward (⏩) button, your vehicle stops and function control pauses. The function starts operating again when the button is pressed and held again.
- When your vehicle reaches the target location, release the smart key Forward (⏪) or Backward (⏩) button.
  - A message appears informing you that parking your vehicle is complete on the infotainment system screen. The gear is shifted to P (Park) and the EPB is applied.

## *i* Information

- Check that all smart keys are outside your vehicle before using the Remote Parking function.
- Remote Parking function only operates when the smart key is within 13 ft. (4 m) from your vehicle. If there is no vehicle movement even when the Remote Forward or Backward button is pressed on the smart key, check the distance to the vehicle and press the button again.
- The detection range of the smart key may differ depending on radio waves in the area such as transmission towers or broadcast stations.
- The parking location indicator is displayed on the Surround View Monitor screen and is displayed until the vehicle enters the parking space for the first time by the Remote Parking function.
- Depending on parking environments, if the vehicle is stopped by a stopper, parking may be completed.
- If you need to change the vehicle's position or location, manually complete parking your vehicle.

## WARNING

- When using Remote Parking function, make sure all passengers have exited your vehicle and are standing in a safe location away from your vehicle.
- Before leaving your vehicle, close the windows and sunroof. Make sure the engine is off before locking the doors.



### **Parking function operation status**

- Smart Parking function

Operation status	Turn signal
Under control	The turn signal of the parking direction blinks until the first reverse is complete.

- Remote Parking function

Operation status	Smart key LED	Turn signal	Hazard warning light
Under control	Green LED continuously blinks	The turn signal of the parking direction blinks until the first reverse is complete.	-
Pause	Red LED continuously blinks	-	Blinks
Off	Red LED illuminates for 4 seconds and then turns off	-	Blinks 3 times and turns off
Complete	Green LED illuminates for 4 seconds and then turns off	-	Blinks 1 time and turns off

### ***i* Information**

If the smart key is not within the operating range from the vehicle (about 13 ft. (4 m)), the smart key LED does not illuminate or blink. Use the smart key within the operating range.

**How to turn off Parking function while operating**

- Press the Parking/View (P) button in the following stage:
  - Searching for parking space
  - Select parking type
- Shift the gear to R (Reverse) in the following stage:
  - Searching for parking space
  - Select parking type
  - Select operating mode
- Press the Parking Safety (P) button or select **Cancel** on the infotainment system screen to turn off Parking function.
- While Smart Parking function is operating:
  - If the vehicle is stopped by depressing the brake pedal, and the gear is shifted, Parking function turns off. At this time, EPB (Electronic Parking Brake) is not applied.
- While Remote Parking function is operating:
  - Press the Remote Start (R) button on the smart key. Parking function turns off.
  - Get on the vehicle with the smart key. Parking function turns off. At this time, the vehicle remains on.

**The function pauses in the following conditions when:**

- Smart Parking
  - There is a pedestrian, animal, or object in the direction your vehicle is moving.
  - The door or liftgate is open.
  - The driver's seat belt is not fastened.
  - Parking Collision-Avoidance Assist or Rear-Cross Traffic Collision-Avoidance Assist operates when your vehicle is backing while remotely controlled.

- The Parking/View (P) button is not continuously pressed.
- The vehicle is stopped by depressing the brake pedal.
- Remote Parking
  - There is a pedestrian, animal, or object in the direction your vehicle is moving.
  - The door or liftgate is open.
  - The Forward (F) or Backward (B) button is not continuously pressed.
  - Multiple buttons are pressed simultaneously on a smart key.
  - The smart key is not operated within 13 ft. (4 m) from your vehicle.
  - A button on another smart key is pressed in addition to the operating smart key.
  - Parking Collision-Avoidance Assist or Rear-Cross Traffic Collision-Avoidance Assist operates when your vehicle is backing while remotely controlled.

When Parking function is paused, the vehicle will automatically stop. If the condition that made the function to pause disappears, the function may operate again.

**The function cancels in the following conditions when:**

- Smart Parking
  - The steering wheel is turned.
  - The gear is shifted while your vehicle is moving.
  - EPB (Electronic Parking Brake) is operating while your vehicle is moving.
  - The hood is open.
  - The driver's door is open with the seat belt unfastened.
  - Rapid acceleration occurs.
  - Vehicle skid occurs.

- An obstacle prevents the wheel from moving.
- There are pedestrians, animals, or objects at the front and rear of the vehicle at the same time.
- About 3 minutes and 50 seconds have passed since Smart Parking function was initiated.
- The slope of the road exceeds the operational range.
- The function is paused for more than 1 minute.
- The steering wheel, gearshift, braking, and drive controls are not working properly.
- ABS, TCS, or ESC system operates due to slippery road conditions.

When Smart Parking function is canceled, your vehicle automatically stops, shifts the gear to P (Park), and applies EPB (Electronic Parking Brake).

- Remote Parking
  - The steering wheel is turned.
  - The gear is shifted.
  - EPB (Electronic Parking Brake) is operating while your vehicle is moving.
  - The hood is open.
  - The brake pedal or accelerator pedal is depressed when all the doors are closed.
  - The smart key is outside the vehicle when the brake pedal is depressed while the driver's door is open.
  - Rapid acceleration occurs.
  - Vehicle skid occurs.
  - An obstacle prevents the wheel from moving.
  - There are pedestrians, animals, or objects at the front and rear of the vehicle at the same time.
  - About 3 minutes and 50 seconds have passed since Remote Parking function was initiated.

- The slope of the road exceeds the operational range.
- The function is paused for more than 1 minute.
- The steering wheel, gearshift, braking, and drive controls are not working properly.
- There is a problem with the smart key or the smart key battery is low.
- ABS, TCS, or ESC system operates due to slippery road conditions.
- Theft Alarm System sounds.

When Remote Parking function is canceled, your vehicle automatically stops, shifts the gear to P (Park), and applies EPB (Electronic Parking Brake).

## **Smart Exit**

### **Operating order**

Smart Exit function operates in the following order:

1. Getting ready for exit
2. Checking space
3. Select exit direction
4. Smart Exit

### **1. Getting ready for exit**

1. With the engine on, depress the brake pedal and shift the gear to P (Park) or N (Neutral).
2. Press and hold the Parking/View (P) button to turn on Remote Smart Parking Assist.



## **i** Information

- **Agree** must be selected on the infotainment system screen and the infotainment system has to operate properly to use Smart Exit function.
- Drive below 3 mph (5 km/h) with the engine on and shift the gear to N (Neutral), Smart Exit function can be used.
- If the function is turned on again after parallel parking is completed by Remote Smart Parking Assist, Smart Exit function can be used.

- Even if check for space is completed, objects in the blind spot area cannot be detected by the sensors. The driver must directly check the blind spot area and continue using the function.

## **i** Information

Due to abnormal performance of the ultrasonic sensor or the influence of the surroundings, Smart Exit function may not search for an exit space even if there is an exit space, or may search for a space that is not suitable for exiting.

### 2. Checking space



1. When the vehicle is stopped by depressing the brake pedal, the vehicle sensors detect the distance from nearby objects and check for space to exit.
  - When checking for space is complete, a message appears informing you that searching for a parking space is complete.

## **!** WARNING

- While checking for space, if there is a collision risk with pedestrian, animal, or object in the direction of vehicle exit, for your safety, Smart Exit function can be turned off.

### 3. Select exit direction



1. With the vehicle stopped by depressing the brake pedal, the infotainment system screen displays the possible directions for parallel exit.
2. Touch the infotainment system screen or use the central controller to select the desired exit direction.

## **!** CAUTION

- Before selecting the Exit Direction, the driver should check whether the space for exit is suitable.
- If the searched exit space by Remote Smart Parking Assist is narrow or unsuitable (surrounding vehicles are parked vertically, etc.), do not use the Smart Exit function.

#### 4. Smart Exit



1. Press the Parking/View (**P**) button when the vehicle is stopped by depressing the brake pedal. When the brake pedal is released, Remote Smart Parking Assist automatically controls the steering wheel, vehicle speed, and gearshift.

- While Smart Exit function is operating, if you do not hold down the Parking/View button, the vehicle stops and function control pauses. The function starts operating again when the Parking/View button is pressed and held again.
- When the vehicle reaches the target exit location, a message appears informing you that parking your vehicle is complete on the infotainment system screen.

#### *i* Information

- Smart Exit function does not operate if the door is open or the seat belt is not fastened.
- Vehicle speed can be adjusted by depressing the brake pedal while Smart Exit function is operating. The vehicle does not accelerate even when the accelerator pedal is depressed.
- If exit is completed while depressing the brake pedal, Smart Exit function is completed with the gear in D (Drive).

- If exit is completed while depressing the accelerator pedal, you must take your foot off the accelerator pedal once for the accelerator pedal to operate.
- If there is no vehicle operation such as depressing the brake pedal or accelerator pedal within 4 seconds after exit is complete, the vehicle automatically shifts to P (Park) and applies EPB (Electronic Parking Brake).
- After Exit function is complete, always check the surroundings before driving.

#### Smart Exit operation status

Operation status	Turn signal
Under control	The turn signal of the exit direction blinks until the exit is complete or Smart Exit is cancelled.

#### How to turn off Smart function while operating

- Press the Parking/View (**P**) button in the following stage:
  - Checking space
  - Select exit direction
- Shift the gear to R (Reverse) in the following stage:
  - Checking space
  - Select exit direction
- Press the Parking Safety (**P**) button or select **Cancel** on the infotainment system screen to turn off Exit function.
- While Smart Exit function is operating, if the vehicle is stopped by depressing the brake pedal, and the gear is shifted, Exiting function turns off. At this time, EPB (Electronic Parking Brake) is not applied.

### The function pauses in the following conditions when:

- There is a pedestrian, animal, or object in the direction your vehicle is moving.
- The door or liftgate is open.
- The driver's seat belt is not fastened.
- Parking Collision-Avoidance Assist or Rear-Cross Traffic Collision-Avoidance Assist operates when your vehicle is backing while remotely controlled.
- The Parking/View (P) button is not continuously pressed.
- The vehicle is stopped by depressing the brake pedal.

When Exit function is paused, the vehicle will stop. If the condition that made the function to pause disappears, the function may operate again.

### The function cancels in the following conditions when:

- Smart Exit
  - The steering wheel is turned.
  - The gear is shifted while the vehicle is moving.
  - EPB (Electronic Parking Brake) is operating while your vehicle is moving.
  - The hood is open.
  - The driver's door is open with the seat belt unfastened.
  - Rapid acceleration occurs.
  - Vehicle skid occurs.
  - An obstacle prevents the wheel from moving.
  - There are pedestrians, animals or objects at the front and rear of the vehicle at the same time.
  - About 3 minutes and 50 seconds have passed since Smart Exit function was initiated.
  - The slope of the road exceeds the operational range.

- The function was paused for more than 1 minute.
- The steering wheel, gearshift, braking, and drive controls are not working properly.
- ABS, TCS, or ESC system operates due to slippery road conditions.

When Smart Exit function is canceled, your vehicle automatically stops, shifts the gear to P (Park), and applies EPB (Electronic Parking Brake).

## Remote Smart Parking Assist Malfunction And Limitations

### Remote Smart Parking Assist malfunction

#### Remote Smart Parking Assist check



When Remote Smart Parking Assist is not working properly, the Check Parking Assist warning message may appear on the infotainment system screen. If the message appears, stop using Remote Smart Parking Assist, and have your vehicle inspected by an authorized retailer of Genesis Branded products.

## Remote Smart Parking Assist canceled



When Remote Parking Assist is operating, the function can be canceled, and the Parking Assist Canceled warning message may appear on the infotainment system screen. Other messages may appear depending on the given situation. Follow the instructions provided while parking your vehicle with Remote Parking Assist. Always look around and pay attention when using Remote Smart Parking Assist.

## Remote Smart Parking Assist conditions not met

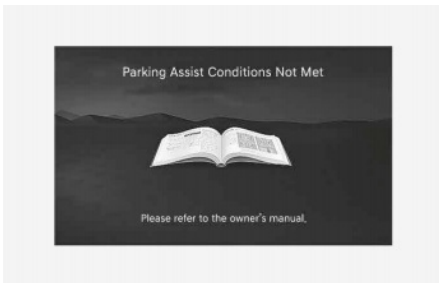

The "**Parking Assist Conditions Not Met**" message may appear on the infotainment system screen if:

- Parking/View (P) button has been pressed and held while ready to operate. After a while, press and hold the Parking/View (P) button again to see if Remote Smart Parking Assist operates.
- The smart key's battery is low. Check the battery and replace it if needed.

## Detecting sensors

Refer to the "**Driver Assistance System Sensors**" section in this chapter for the location and the general precautions of the wide-front/side/rear view cameras and front/side/rear ultrasonic sensors.

### WARNING

Do not manually adjust the side view mirror or use the Remote Smart Parking Assist after a hard impact on the side view mirror.

## Limitations of Remote Smart Parking Assist

In the following circumstances, the use of Remote Smart Parking Assist may be limited, there may be a risk of collision, or Remote Smart Parking Assist may turn off. You may have to park your vehicle or to drive away from the parked location without using this function.

- An object is attached to the steering wheel.
- Your vehicle has snow chains, spare tire, or different size wheels installed.
- The braking system such as the brake disc or caliper is adjusted differently from the factory default settings.
- The powertrain or drivetrain system such as the engine or transmission is adjusted differently from the factory default settings.
- Tire pressure is lower or higher than the standard tire pressure.
- Your vehicle is loaded with cargo longer or wider than your vehicle or a trailer or hitch mounted carrier is connected to your vehicle.
- There is an issue with the wheel alignment.
- Your vehicle is leaning severely to one side.
- Your vehicle is equipped with a trailer hitch.

- The license plate is installed in a location different from the intended location.
  - There is a person, animal, or object above or below the ultrasonic sensor when Remote Smart Parking Assist is activated.
  - The parking space is narrow, curved or angled.
  - There is an obstacle such as person, animal, or object (trash can, bicycle, motorcycle, shopping cart, narrow pillar, etc.) detected near the parking space.
  - There is a circular pillar or narrow pillar, or a pillar surrounded by objects such as fire extinguisher detected near the parking space.
  - The road surface is bumpy (curbstone, speed bump, etc.) or slippery.
  - The parking space is near a vehicle with higher ground clearance or a larger vehicle such as truck.
  - The parking space is inclined.
  - There is a heavy wind.
  - Remote Smart Parking Assist is operating on uneven roads, gravel roads, bushes, etc.
  - The weather is very hot or cold.
  - The ultrasonic sensor is covered or blocked with snow, water, or dirt.
  - A wireless transmission device operates near the ultrasonic sensors.
  - An ultrasonic sensor with a similar frequency is near your vehicle.
  - A sensor has been damaged or scratched by a sharp object.
  - When the ultrasonic sensor cannot detect the following objects:
    - Slim objects such as ropes, chains, or small poles.
    - Narrow objects such as corners of a square column.
    - Objects less than 40 in. (100 cm) in height and narrower than 6 in. (14 cm) in diameter.
    - Objects that tend to absorb sensor frequency such as clothes, spongy material, or snow.
    - Pedestrians, animals, or objects that are very close to the ultrasonic sensors.
- The cameras may not properly recognize or may not recognize the parking line and objects when:
    - There are small objects (curb, etc.), sharp objects, or thin objects (rope, etc.) around.
    - People, animals or objects are too close or too far from the vehicle.
    - Objects are on a higher position, such as pickup trucks.
    - The camera is covered or blocked by dirt or moisture.
    - The camera is exposed to bright light.
    - The surrounding is too dark.
    - Light is reflected from the surface.
- Remote Smart Parking Assist may not operate normally under the following circumstances:
- Parking on inclines

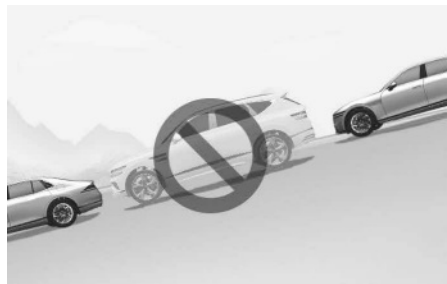

Park or exit your vehicle manually on inclines.



- Parking in snow



Snow may interfere with sensor operation, or Remote Smart Parking Assist may cancel if the road is slippery where you are parking.

- Parking on uneven road



Remote Smart Parking Assist may cancel when the vehicle slips, or the vehicle cannot move due to road conditions such as pebbles or fragmented stones.

- Parking behind a truck

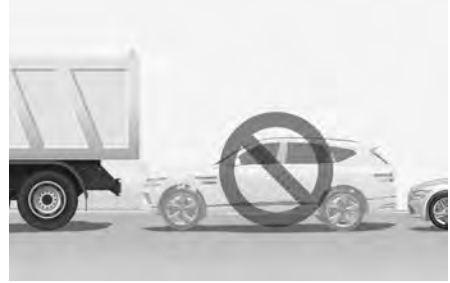

Do not use Remote Smart Parking Assist around vehicles with higher ground clearance, such as a bus, truck, etc. It may lead to an accident.

- Parking near a pillar

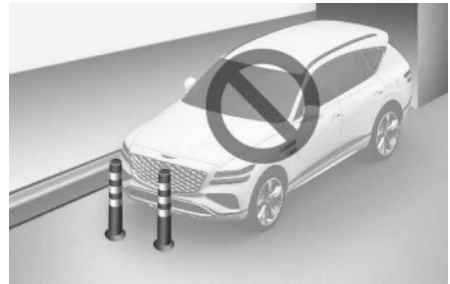

Remote Smart Parking Assist performance may be reduced or collided with an obstacle may occur when there is a narrow object, circular pillar, square pillar, or a pillar surrounded by objects such as a fire extinguisher, etc., near the parking space. Park or exit your vehicle manually.

- Parking next to a misaligned vehicle



If Remote Smart Parking Assist is used, when parking next to a misaligned vehicle, your vehicle may cross the parking marking on the opposite side of the parked vehicle.

- Parking in angled spaces



Remote Operation may not operate properly in a diagonal parking space.

- Leaving a parking space near a wall or parking in a narrow space



- Remote Smart Parking Assist may not operate normally when leaving a parking space that is narrow and near a wall. Always check for pedestrians, animals, objects while leaving.
  - Remote Smart Parking Assist does not search for parking spaces at areas with narrow parking spaces that are narrower than the minimum space required for parking.
- Parking in abnormal spaces

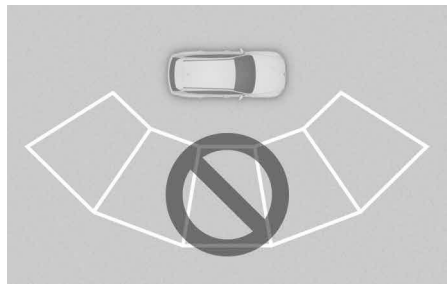

Remote Smart Parking Assist does not work normally when the parking lines are not parallel. Do not park even though the parking space is recognized by the sensor.

- Parking on inclined parking space

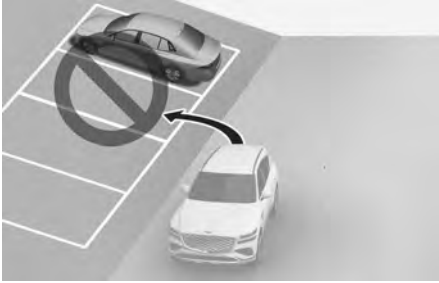

Remote Smart Parking Assist does not work normally on a inclined or curved road surface. Do not park even though the parking space is recognized by the sensor.

### **WARNING**

You are responsible for parking and exiting safely when using Remote Smart Parking Assist. Make sure there are no pedestrians, animals, or objects around the vehicle when using Remote Smart Parking Assist.

To prevent serious injury or death:

- When using Remote Smart Parking Assist, stay out of the path of your vehicle.
- A collision may occur if a pedestrian, animal, or object are in the blind spot area of the sensors or are very close to the sensors.
- A collision may occur if a pedestrian, animal, or object suddenly enters the path of your vehicle while Remote Smart Parking Assist is operating.
- Do not use Remote Smart Parking Assist under the influence of alcohol.
- Do not let children or other people use the smart key.
- Do not use Remote Smart Parking Assist continuously for a long time. It may adversely affect Remote Smart Parking Assist performance.

- Remote Smart Parking Assist may not operate normally if your vehicle needs wheel alignment adjustment such as when your vehicle tilts to one side. Have your vehicle inspected by an authorized retailer of Genesis Branded Products.
- Remote Smart Parking Assist may suddenly brake to help avoid a collision.
- Only use Remote Smart Parking Assist in parking spaces large enough for your vehicle.

### *i* **Information**

- If the 3rd stage warning (continuous beep) of Forward/Backward Parking Distance Warning sounds while Remote Smart Parking Assist is operating, it means the obstacle detected is close to your vehicle and Remote Smart Parking Assist temporarily stops operating.
- The vehicle may move with the stop lights on when the brakes are applied by Remote Smart Parking Assist.
- The Remote Smart Parking Assist's performance may temporarily reduce or may turn off when the engine is turned on after being parked in cold weather for a long time.

## Declaration of Conformity

### Front Radar

The radio frequency components (Front Radar) complies:

- For USA



- For Canada

Model: LRR-25  
IC: 27992-LRR25

This device complies with Industry Canada licence-exempt RSS standard(s). Operation is subject to the following two conditions: this device may not cause interference, and

(2) this device must accept any interference, including interference that may cause Undesired operation of the device.

Le présent appareil est conforme aux CNR d'Industrie Canada applicables aux appareils radio exempts de licence. L'exploitation est autorisée

aux deux conditions suivantes:

(1) l'appareil ne doit pas produire de brouillage,

et

(2) l'utilisateur de l'appareil doit accepter tout brouillage radioélectrique subi, même si le brouillage est susceptible d'en compromettre le fonctionnement.

## Front Corner Radar (if equipped)/Rear Corner Radar (if equipped)

The radio frequency components (Front corner radar/Rear corner radar) complies:

- For USA



- For Canada

Model: 2H5TR  
IC: 3659A-2H5TR

This device complies with Industry Canada licence-exempt RSS standard(s). Operation is subject to the following two conditions: (1) this device may not cause interference, and

(2) this device must accept any interference, including interference that may cause undesired operation of the device.

Le présent appareil est conforme aux CNR d'Industrie Canada applicables aux appareils

radio exempts de licence. L'exploitation est autorisée

aux deux conditions suivantes:

(1) l'appareil ne doit pas produire de brouillage, et

(2) l'utilisateur de l'appareil doit accepter tout

brouillage radioélectrique subi, même si le brouillage est susceptible d'en compromettre le fonctionnement.



# 8. Emergency Situations

Hazard Warning Flasher .....	8-2
In Case of an Emergency While Driving .....	8-2
If the Engine Stalls While Driving .....	8-2
If the Engine Stalls At a Crossroad or Crossing .....	8-2
If You Have a Flat Tire While Driving .....	8-3
If the Engine Does Not Start .....	8-3
Jump Starting .....	8-4
If the Engine Overheats .....	8-7
Tire Pressure Monitoring System (TPMS) .....	8-8
Check Tire Pressure .....	8-8
Tire Pressure Monitoring System .....	8-9
Low Tire Pressure Position And Tire Pressure Telltale .....	8-10
TPMS (Tire Pressure Monitoring System) Malfunction Indicator .....	8-11
Changing a Tire With TPMS .....	8-11
If You Have a Flat Tire (With Spare Tire) .....	8-12
Jack And Tools .....	8-12
Changing Tires .....	8-13
Jack Label .....	8-18
If You Have a Flat Tire (With Tire Mobility Kit) .....	8-19
Introduction .....	8-19
Notes On the Safe Use of the Tire Mobility Kit .....	8-20
Components of the Tire Mobility Kit .....	8-21
Using the Tire Mobility Kit .....	8-22
How to Adjust Tire Pressure .....	8-25
Towing .....	8-26
Towing Service .....	8-26
Removable Towing Hook .....	8-27
Emergency Towing .....	8-27

## Hazard Warning Flasher



The hazard warning flasher warns other drivers to exercise extreme caution when approaching, overtaking, or passing your vehicle.

It should be used whenever making emergency repairs or when stopped near the edge of a roadway.

To turn on or off the hazard warning flasher, press the hazard warning flasher button with the Engine Start/Stop button in any position. The hazard warning flasher button is located in the center fascia panel. All turn signal lights will flash simultaneously.

- The hazard warning flasher operates regardless of whether your vehicle is running or not.
- The turn signals do not work when the hazard flasher is on.

## In Case of an Emergency While Driving

### If the Engine Stalls While Driving

- Reduce the vehicle speed gradually, keeping a straight line. Move cautiously off the road to a safe place.
- Turn on your hazard warning flasher.
- Try to start the engine again. If your vehicle does not start, contact an authorized retailer of Genesis Branded products or seek other qualified assistance.

### If the Engine Stalls At a Crossroad or Crossing

If the engine stalls at a crossroad or intersection, if safe to do so, shift the gear to N (Neutral) and then push the vehicle to a safe location.



## If You Have a Flat Tire While Driving

If a tire goes flat while you are driving:

- Take your foot off the accelerator pedal and let the vehicle slow down while driving straight ahead. Do not apply the brakes immediately or attempt to pull off the road because this may cause loss of vehicle control resulting in a collision. When the vehicle has slowed to such a speed that it is safe to do so, brake carefully and pull off the road. Drive off the road as far as possible and park on a firm, level ground. If you are on a divided highway, do not park in the median area between the two traffic lanes.
- When the vehicle is stopped, press the hazard warning flasher button, shift the gear to P (Park), apply the parking brake, and press the Engine Start/Stop button to the OFF position.
- Have all passengers get out of the vehicle. Make sure they all get out on the side of the vehicle that is away from traffic.
- When replacing a flat tire, follow the instructions provided later in this chapter.

## If the Engine Does Not Start

- Be sure to shift the gear to N (Neutral) or P (Park). The engine starts only when the gear is in N (Neutral) or P (Park).
- Turn on the interior light. If the light dims or goes out when you operate the starter, the battery is drained.

Refer to the instructions in "Jump Starting" provided in this chapter.

- Check the fuel level and add fuel if necessary.

If the vehicle still does not start, contact an authorized retailer of Genesis Branded products for assistance.

### **NOTICE**

Starting the vehicle by pushing or pulling may cause the catalytic converter to overload and damage the emission control system.

---

## Jump Starting

Jump starting can be dangerous if done incorrectly. Follow the jump starting procedure in this section to avoid serious injury or damage to your vehicle. If in doubt about how to properly jump start your vehicle, have a service technician or towing service do it for you.

### **WARNING**

To prevent serious injury or death to you or bystanders, always follow these precautions when working near or handling the battery:

Always read and follow instructions carefully when handling a battery.



Wear eye protection designed to protect the eyes from acid splashes.



Keep all flames, sparks, or smoking materials away from the battery.



Hydrogen gas is always present in battery cells. It is highly combustible, and may explode if ignited.



Keep batteries out of reach of children.



Batteries contain sulfuric acid which that is highly corrosive. Do not allow acid to contact your eyes, skin, or clothing.

If acid gets into your eyes, flush your eyes with clean water for at least 15 minutes and get immediate medical attention. If acid gets on your skin, thoroughly wash the area. If you feel pain or a burning sensation, get medical attention immediately.



- When lifting a plastic-cased battery, excessive pressure on the case may cause battery acid to leak. Lift with a battery carrier or with your hands on opposite corners.
- Do not attempt to jump start your vehicle if your battery is frozen.
- Never attempt to recharge the battery when the vehicle's battery cables are connected to the battery.
- The electrical ignition system works with high voltage.

Never touch these components with the engine running or when the Engine Start/Stop button is in the ON position.

- Do not allow the positive (+) and negative (-) jumper cables to touch. It may cause sparks.

## Jump starting procedure

### *i* Information

Your vehicle has a battery in the cargo area, but when you jump start your vehicle, use the jumper terminal in the engine compartment.

1. Position the vehicles close enough that the jumper cables can reach. Do not allow the vehicles to touch.
2. Avoid fans or any moving parts in the engine compartment at all times, even when the vehicles are turned off.
3. Turn off all electrical devices such as radios, lights, air conditioning, etc. Put the vehicles in P (Park) and apply the parking brake. Turn both vehicles OFF.
4. Open the engine hood.

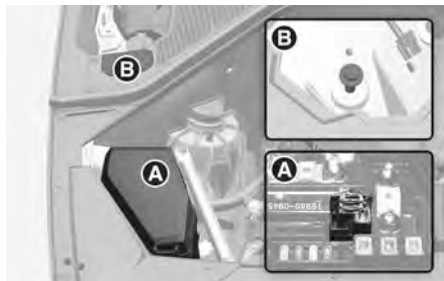

[A] Positive (+) terminal  
[B] Negative (-) terminal

5. Open the service cover.
6. Remove the engine compartment fuse box cover.

### **⚠ CAUTION**

Before jump starting, make sure to correctly identify the positive (+) and negative (-) terminals to avoid reverse polarity connections.

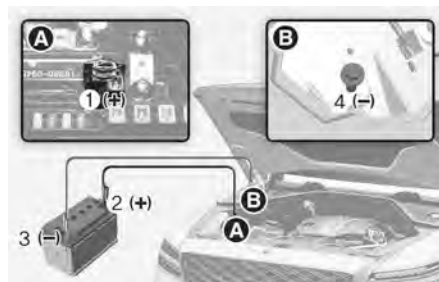

7. Connect the jumper cables in the exact sequence shown in the illustration. First connect one jumper cable to the positive (+) jumper terminal of your vehicle (1).
8. Connect the other end of the jumper cable to the red, positive (+) battery/jumper terminal of the assisting vehicle (2).
9. Connect the second jumper cable to the black, negative (-) battery/jumper terminal of the assisting vehicle (3).
10. Connect the other end of the second jumper cable to the chassis ground of your vehicle (4).

Do not allow the jumper cables to contact anything except the correct battery or jumper terminals or the correct ground. Do not lean over the battery when making connections.

### **⚠ WARNING**

Do not connect the jumper cable to the negative (-) jumper terminal of the discharged battery. A spark could cause the battery to explode and lead to a personal injury or vehicle damage.

11. Start the engine of the assisting vehicle and let it run at approximately about 2,000 RPM for a few minutes. Then start your vehicle.

12. Keep your vehicle operating for at least 30 minutes at idle or driving to assure make sure your battery receives enough charge to be able to start on its own after the vehicle is shut off. A completely discharged battery may require as long as 60 minutes runtime to fully recharge it. If the vehicle is run for less, the vehicle may not restart.

If your vehicle does not start after a few attempts, it probably requires service. Have your vehicle inspected by an authorized retailer of Genesis Branded products.

Disconnect the jumper cables in the exact reverse order you connected them:

1. Disconnect the jumper cable from the chassis ground of your vehicle (4).
2. Disconnect the other end of the jumper cable from the black, negative (-) battery/jumper terminal of the assisting vehicle (3).
3. Disconnect the second jumper cable from the red, positive (+) battery/jumper terminal of the assisting vehicle (2).
4. Disconnect the other end of the jumper cable from the red, positive (+) jumper terminal of your vehicle (1).

### **WARNING**

While jump starting your vehicle, avoid the positive (+) and negative (-) cables to come in contact. A spark could cause personal injury.

---

### **NOTICE**

To prevent damage to your vehicle:

- Only use a 12 V power supply (battery or jumper system) to jump start your vehicle.
  - Do not attempt to jump start your vehicle by push-starting.
- 

### *i* **Information**



An inappropriately disposed battery may be harmful to the environment and human health. Always dispose used batteries in accordance with local law(s) or regulations.

---

### **WARNING**

48 V lithium battery (if equipped)  
Do not jump start another vehicle. The 48 V lithium ion type battery installed in your vehicle will be damaged.

---

## If the Engine Overheats

If your temperature gauge indicates overheating, you experience a loss of power, hear loud pinging or knocking, or the engine may be overheating. If this happens, you must:

1. Pull off the road and stop as soon as it is safe to do so.
2. Shift the gear to P (Park) and apply the parking brake. If the air conditioning is ON, turn it OFF.
3. If engine coolant is running out under the vehicle or steam is coming out from the hood, stop the engine. Do not open the hood until the coolant has stopped running or the steaming has stopped. If there is no visible loss of engine coolant and no steam, leave the engine running and check to make sure the engine cooling fan is operating. If the fan is not running, turn off the engine.
4. Check for coolant leaking from the radiator, hoses or under the vehicle. (If air conditioning has been used, it is normal for cold water to be draining from it when you stop.)
5. If engine coolant is leaking out, stop the engine immediately and call the nearest authorized retailer of Genesis Branded products for assistance.

### WARNING



While the engine is running, keep hands, clothing, and tools away from the moving parts such as cooling fan and drive belt to prevent serious injury.

### WARNING



Never remove the engine coolant cap and/or liquid-cooled intercooler coolant cap or the drain plug while the engine and radiator are hot.

Hot coolant and steam may blow out under pressure, causing serious injury. Turn off the engine and wait until the engine cools down. Use extreme care when removing the coolant cap. Wrap a thick towel around it, and turn it counterclockwise slowly to the first stop. Step back while the pressure is released from the cooling system. When you are sure all the pressure has been released, press down on the cap, using a thick towel, and continue turning counterclockwise to remove it.

6. If you cannot find the cause of the overheating, wait until the engine temperature has returned to normal. Then, if coolant has been lost, carefully add coolant to the reservoir to bring the fluid level in the reservoir up to the halfway mark.
7. Proceed with caution, keeping alert for further signs of overheating. If overheating happens again, contact an authorized retailer of Genesis Branded products for assistance.

**CAUTION**

- Serious loss of coolant indicates a leak in the cooling system. Have the system inspected by an authorized retailer of Genesis Branded products.
- When the engine overheats from low engine coolant, suddenly adding engine coolant may cause cracks in the engine. To prevent damage, add engine coolant slowly in small quantities. It may require several refilling cycles to properly fill the engine cooling system. If necessary, contact an authorized retailer of Genesis Branded products should be consulted to perform this task.

## Tire Pressure Monitoring System (TPMS)



(1) Low Tire Pressure Telltale/TPMS Malfunction Indicator

- (2) Low Tire Pressure Position Telltale and Tire Pressure Telltale (Shown on the Cluster display)

## Check Tire Pressure



- You can check the tire pressure in the Normal view on the cluster. Refer to the "View Modes" section in chapter 4.
- Tire pressure is displayed after a few minutes of driving.
- If tire pressure is not displayed when the vehicle is stopped, "Drive to display" message appears.
- The displayed tire pressure values may differ from those measured with a tire pressure gauge.
- You can change the tire pressure unit from the Settings menu in the infotainment system. Select:
  - **Setup > General > Units > Tire Air Pressure > psi/kPa/bar**

### *i* Information

The infotainment system may change after software updates. For more information, refer to the manual provided in the infotainment system and the quick reference guide.

## Tire Pressure Monitoring System

### WARNING

Over-inflation or under-inflation can reduce tire life, adversely affect vehicle handling, and lead to sudden tire failure that may cause loss of vehicle control resulting in an accident.

Each tire, including the spare (if provided), should be checked monthly when cold and inflated to the inflation pressure recommended by the vehicle manufacturer on the vehicle placard or tire inflation pressure label. (If your vehicle has tires of a different size than the size indicated on the vehicle placard or tire inflation pressure label, you should determine the proper tire inflation pressure for those tires.)

As an added safety feature, your vehicle has been equipped with a tire pressure monitoring system (TPMS) that illuminates a low tire pressure telltale when one or more of your tires is significantly under-inflated. Accordingly, when the low tire pressure telltale illuminates, you should stop and check your tires as soon as possible, and inflate them to the proper pressure. Driving on a significantly under-inflated tire causes the tire to overheat and can lead to tire failure.

Under-inflation also reduces fuel efficiency and tire tread life, and may affect the vehicle's handling and stopping ability.

Please note that the TPMS is not a substitute for proper tire maintenance, and it is the driver's responsibility to maintain correct tire pressure, even if under-inflation has not reached the level to trigger illumination of the TPMS low tire pressure telltale.

Your vehicle has also been equipped with a TPMS malfunction indicator to indicate when the system is not operating properly. The TPMS malfunction indicator is combined with the low tire pressure telltale. When the system detects a malfunction, the telltale will flash for approximately one minute and then remain continuously illuminated. This sequence will continue upon subsequent vehicle start-ups as long as the malfunction exists.

When the malfunction indicator is illuminated, the system may not be able to detect or signal low tire pressure as intended. TPMS malfunctions may occur for a variety of reasons, including the installation of replacement or alternate tires or wheels on the vehicle that prevent the TPMS from functioning properly.

Always check the TPMS malfunction telltale after replacing one or more tires or wheels on your vehicle to ensure that the replacement or alternate tires and wheels allow the TPMS to continue to function properly.

### NOTICE

If any of the below happens, have the system inspected by an authorized retailer of Genesis Branded products.

1. The Low Tire Pressure Telltale / TPMS Malfunction Indicator does not illuminate for 3 seconds when the Engine Start/Stop button is pressed to the ON position or when the engine is running.
2. The TPMS Malfunction Indicator remains illuminated after blinking for approximately 1 minute.
3. The Low Tire Pressure Position Telltale remains illuminated.

## Low Tire Pressure Position And Tire Pressure Telltale

Low tire pressure warning light



Low tire pressure position telltale



When the tire pressure monitoring system warning indicators are illuminated and a warning message displayed on the cluster display, one or more of your tires is significantly under-inflated. The Low Tire Pressure Position Telltale will indicate which tire is significantly underinflated by illuminating the corresponding parking light.

If either telltale illuminates, immediately reduce your speed, avoid hard cornering and anticipate increased stopping distances. You should stop and check your tires as soon as possible. Inflate the tires to the proper pressure as indicated on the vehicle's placard or tire inflation pressure label located on the driver's side center pillar outer panel.

If you cannot reach a service station or if the tire cannot hold the newly added air, replace the low pressure tire with the spare tire.

The Low Tire Pressure Telltale will remain on and the TPMS Malfunction Indicator may blink for one minute and then remain illuminated (when the vehicle is driven approximately 10 minutes at speed above 15.5 mph (25 km/h)) until you have the low pressure tire repaired and replaced on the vehicle.

### **WARNING**

In winter or cold weather, the Low Tire Pressure Telltale may be illuminated if the tire pressure was adjusted to the recommended tire inflation pressure in warm weather. It does not mean your TPMS is malfunctioning because the decreased temperature leads to a proportional lowering of tire pressure.

When you drive your vehicle from a warm area to a cold area or from a cold area to a warm area, or the outside temperature is greatly higher or lower, you should check the tire inflation pressure and adjust the tires to the recommended tire inflation pressure.

### **WARNING**

Low pressure damage

Significantly low tire pressure makes the vehicle unstable and can contribute to loss of vehicle control and increased braking distances.

Continued driving on low pressure tires can cause the tires to overheat and fail.



## TPMS (Tire Pressure Monitoring System) Malfunction Indicator



The TPMS Malfunction Indicator will illuminate after it blinks for approximately one minute when there is a problem with the Tire Pressure Monitoring System.

Have the system checked by an authorized retailer of Genesis Branded products as soon as possible.

### NOTICE

If there is a malfunction with the TPMS, the Low Tire Pressure Position Telltale will not be displayed even though the vehicle has an under-inflated tire.

### NOTICE

The TPMS Malfunction Indicator may illuminate after blinking for one minute if the vehicle is near electric power supply cables or radio transmitters such as police stations, government and public offices, broadcasting stations, military installations, airports, transmitting towers, etc.

Additionally, the TPMS Malfunction Indicator may illuminate if snow chains are used or electronic devices such as computers, chargers, remote starters, navigation, etc. This may interfere with normal operation of the TPMS.

## Changing a Tire With TPMS

If you have a flat tire, the Low Tire Pressure and Position telltales will come on. Have the flat tire repaired by an authorized retailer of Genesis Branded products as soon as possible or replace the flat tire with the spare tire.

### NOTICE

Do not use a puncture-repair kit not approved by Genesis Branded Vehicle. Tire sealant not approved by an authorized retailer of Genesis Branded products may damage the tire pressure sensor.

The spare tire (if equipped) does not come with a tire pressure monitoring sensor.

When the low pressure tire or the flat tire is replaced with the spare tire, the Low Tire Pressure Telltale will remain on. Also, the TPMS Malfunction Indicator will illuminate after blinking for one minute if the vehicle is driven at speed above 15.5 mph (25 km/h) for approximately 10 minutes.

Once the original wheel equipped with a tire pressure monitoring sensor is reinflated to the recommended pressure and reinstalled on the vehicle, the Low Tire Pressure Telltale and TPMS Malfunction Indicator will go off within a few minutes of driving.

If the indicators do not extinguish after a few minutes, consult an authorized retailer of Genesis Branded products.

Each wheel is equipped with a tire pressure sensor mounted inside the tire behind the valve stem (except for the spare tire). You must use TPMS specific wheels. Always have your tires serviced by an authorized retailer of Genesis Branded products.

You may not be able to identify a tire with low pressure by simply looking at it.

Always use a good quality tire pressure gauge to measure. Please note that a tire that is hot (from being driven) will have a higher pressure measurement than a tire that is cold.

A cold tire means the vehicle has been sitting for 3 hours and driven for less than 1 mile (1.6 km) in that 3 hour period.

Allow the tire to cool before measuring the inflation pressure. Always be sure the tire is cold before inflating to the recommended pressure.

### WARNING

- The TPMS cannot alert you to severe and sudden tire damage caused by external factors such as nails or road debris.
- If you feel any vehicle instability, immediately take your foot off the accelerator, apply the brakes gradually with light force, and slowly move to a safe position off the road.

### WARNING

Tampering with, modifying, or disabling the Tire Pressure Monitoring System (TPMS) components may interfere with the system's ability to warn the driver of low tire pressure conditions and/or TPMS malfunctions and may void the warranty.

### WARNING

This device complies with Part 15 of the FCC rules.

This device may not cause harmful interference.

This device must accept any interference received, including interference that may cause undesired operation.

Changes or modifications not expressly approved by the party responsible for compliance could void the user's authority to operate the equipment.

## If You Have a Flat Tire (With Spare Tire)

 If equipped

### WARNING

Follow the instructions in this section when replacing a tire to reduce the risk of serious injury or death. Changing a tire can be dangerous.

## Jack And Tools

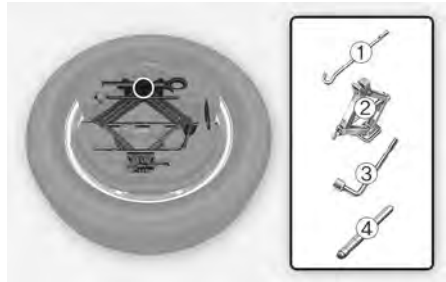

- (1) Jack handle
- (2) Jack
- (3) Wheel lug wrench
- (4) Centering pin

The jack, jack handle, and wheel lug wrench are stored in the cargo area under the luggage box cover.

The jack is provided for emergency tire changing only.

Turn the winged hold down bolt counterclockwise to remove the spare tire.

Store the spare tire in the same compartment by turning the winged hold down bolt clockwise.



To prevent the spare tire and tools from "rattling", store them in their proper locations.

If it is hard to loosen the tire hold-down wing bolt by hand, you can loosen it easily using the wheel lug wrench (1). Turn the tire hold-down wing bolt counterclockwise with the wheel lug wrench.



## Changing Tires

### WARNING

A vehicle can slip or roll off of a jack causing serious injury or death to you or those nearby. Take the following safety precautions:

- NEVER place any portion of your body under the vehicle that is supported by a jack.
- NEVER attempt to change a tire in the lane of traffic. ALWAYS move the vehicle completely off the road on a level, firm ground away from traffic before trying to change a tire. If you cannot find a level, firm place off the road, call a towing service for assistance.
- ONLY use the jack provided with the vehicle.
- ALWAYS place the jack on the designated jacking positions on the vehicle and NEVER on the bumpers or any other part of the vehicle for jacking support.
- Do not start or run the engine while the vehicle is on the jack.
- Do not allow anyone to remain in the vehicle while it is on the jack.
- Keep children away from the road and the vehicle.

Follow these steps to change your vehicle's tire:

1. Park on a level, firm surface.
2. Shift the gear to P (Park), apply the parking brake, and press the Engine Start/Stop button to the OFF position.
3. Press the hazard warning flasher button.
4. Remove the wheel lug wrench, jack, jack handle, and spare tire from the vehicle.

5. Block both the front and rear of the tire diagonally opposite of the tire you are changing.

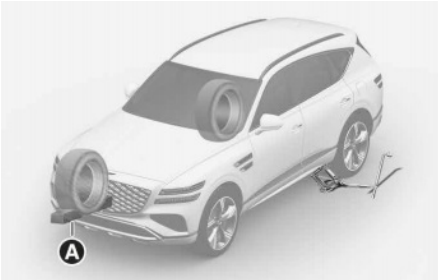

[A] Block

6. Loosen the wheel bolts counterclockwise one turn each in the order shown below, but do not remove any wheel bolts until the tire has been raised off of the ground.



7. Place the jack at the designated jacking position under the frame closest to the tire you are changing. The jacking positions are plates welded to the frame with two notches. Never jack at any other position or part of the vehicle to prevent the vehicle slipping off of the jack or damaging the vehicle.

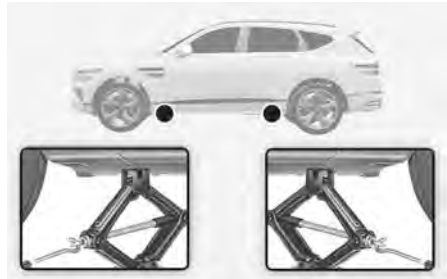

8. Insert the jack handle into the jack and turn it clockwise, raising the vehicle until the tire clears the ground. Make sure the vehicle is stable on the jack.



9. Loosen a wheel bolt with the wheel lug wrench and remove it with your fingers.

10. Insert the centering pin (1) into the hole where the wheel bolt is removed. Remove the rest of the wheel bolts from the wheel.



11. Remove the wheel from the studs and lay it flat on the ground out of the way. Remove any dirt or debris from the studs, mounting surfaces, and spare tire.
12. Install the spare tire over the centering pin (1) and then push in the spare tire.



13. Tighten the wheel bolts with your fingers onto the studs with the smaller end of the wheel bolts closest to the wheel.
14. Pull out the centering pin (1) and tighten the last wheel bolt.
15. Lower the vehicle to the ground by turning the jack handle counterclockwise.

16. Use the wheel lug wrench to tighten the wheel bolts in the order shown. Double-check each wheel bolts until they are tight. After changing tires, have an authorized retailer of Genesis Branded products tighten the wheel bolts to their proper torque as soon as possible. Tighten the wheel bolts to 101-116 lbf-ft (14-16 kgf-m).



**Check the tire pressure after installing the compact spare tire. The compact spare tire should be inflated to 420 kPa (60 psi).**

If you have a tire gauge, check the spare tire pressure (refer to the "Tires and Wheels" section in chapter 2 for tire pressure instructions.). If the spare tire pressure is lower or higher than the recommended, drive slowly to the nearest service station and adjust it to the recommended pressure. Always reinstall the valve cap after checking or adjusting the tire pressure. If the cap is not replaced, air may leak from the tire. If you lose a valve cap, buy another and install it as soon as possible. After changing tires, secure the flat tire and return the jack and tools to their proper storage locations.

**NOTICE**

Check the tire pressure as soon as possible after installing a spare tire. Adjust it to the recommended pressure.

### **WARNING**

Your vehicle has metric threads on the studs and wheel bolts. During tire changing, make sure that the wheel bolts that were removed are reinstalled. If you have to replace your wheel bolts, make sure they have metric threads to avoid damaging the studs and make sure the wheel is properly secured to the hub. Contact an authorized retailer of Genesis Branded products for assistance.

---

If any of the equipment such as jack, wheel bolts, studs, or other equipment is damaged or in poor condition, do not attempt to change the tire and call for assistance.

### *Use of compact spare tires*

 **If equipped**

Compact spare tires are designed for emergency use only. Drive carefully on the compact spare tire and always follow the safety precautions.

### **WARNING**

To prevent compact spare tire failure and loss of control, possibly resulting in a collision:

- Use the compact spare tire only in an emergency.
  - NEVER operate your vehicle over 50 mph (80 km/h).
  - Do not exceed the vehicle's maximum load rating or the load carrying capacity shown on the sidewall of the compact spare tire.
  - Do not use the compact spare tire continuously. Repair or replace the original tire as soon as possible to avoid failure of the compact spare tire.
- 

When driving with the compact spare tire mounted to your vehicle:

- Do not take this vehicle through an automatic car wash after the compact spare tire has been installed.
- Do not use the compact spare tire on any other vehicle because this tire has been designed especially for your vehicle.
- The compact spare tire's tread life is shorter than a regular tire. Inspect your compact spare tire regularly and replace worn compact spare tires with the same size and design, mounted on the same wheel.
- Do not use more than one compact spare tire at a time.
- Do not tow a trailer while the compact spare tire is installed.

### **Information**

When the original tire and wheel are repaired and reinstalled on the vehicle, the wheel bolt torque must be set correctly. The correct wheel bolt tightening torque is 14-16 kgf·m (101-116 lbf·ft).

---

**NOTICE**

To prevent damaging the compact spare tire and your vehicle:

- Drive slowly enough for the road conditions to avoid all hazards, such as a potholes or debris.
  - Avoid driving over obstacles. The compact spare tire diameter is smaller than the diameter of a conventional tire and reduces the ground clearance about 1 in. (25 mm).
  - Do not use tire chains on the compact spare tire. Because of the smaller size, a tire chain will not fit properly.
  - Do not use the compact spare tire on any other wheels, nor should standard tires, snow tires, wheel covers or trim rings be used with the compact spare wheel.
  - Do not suddenly accelerate or decelerate 0-25 mph (0-40 km/h) in any driving mode. Transfer case oil may leak.
-

## Jack Label

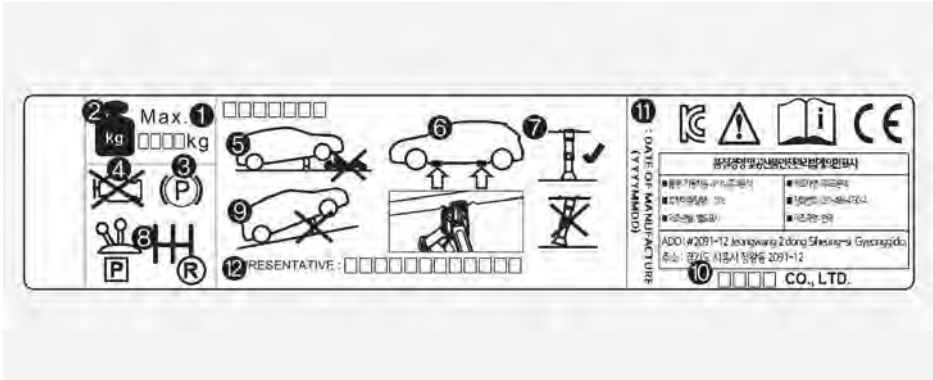

The actual jack label in the vehicle may differ from the illustration.

For more detailed specifications, refer to the label attached to the jack.

- (1) Model Name
- (2) Maximum allowable load
- (3) Always apply the parking brake before using a jack.
- (4) Always turn off the engine before using a jack.
- (5) Never put any portion of your body under the vehicle supported by a jack.
- (6) Only use the designated jacking locations on the frame.
- (7) When supporting the vehicle, have the base plate of the jack flat on the ground under the lifting point.
- (8) Shift to the Reverse gear with the manual transmission or shift to P (Park) position with the automatic transmission.
- (9) Do not jack the vehicle on an incline. Only jack the vehicle on a firm level ground.
- (10) Jack manufacturer
- (11) Production date
- (12) Representative company and address



## If You Have a Flat Tire (With Tire Mobility Kit)

**+** if equipped



For safe operation, carefully read and follow the instructions in this manual before use.

- (1) Compressor
- (2) Sealant bottle

The Tire Mobility Kit is a temporary fix to the tire, have tire inspected by an authorized retailer of Genesis Branded products or the equivalent approved for your vehicle as soon as possible.

### **⚠ CAUTION**

When two or more tires are flat, do not use the tire mobility kit because the sealant provided with the Tire Mobility Kit must be used for only one flat tire.

### **⚠ WARNING**

Do not use the Tire Mobility Kit to repair punctures in the tire walls. This can result in an accident due to tire failure.

### **⚠ WARNING**

Have your tire repaired as soon as possible. The tire may lose air pressure at any time after inflating with the Tire Mobility Kit.

## Introduction

With the Tire Mobility Kit you can stay mobile even after experiencing a tire puncture.

The compressor and sealing compound system effectively and comfortably seals most punctures in a passenger vehicle tire caused by nails or similar objects and reinflates the tire.

After you ensure that the tire is properly sealed you can drive cautiously on the tire (distance up to 120 miles (200 km)) at a max. speed of 50 mph (80 km/h) in order to reach a service station or tire dealer for the tire replacement.

It is possible that some tires, especially with larger punctures or damage to the sidewall, cannot be sealed completely.

Air pressure loss in the tire may adversely affect tire performance.

For this reason, you should avoid abrupt steering or other driving maneuvers, especially if the vehicle is heavily loaded or if a trailer is being used.

The Tire Mobility Kit is not designed or intended as a permanent tire repair method and is to be used for one tire only.

This instruction shows you step by step how to temporarily seal the puncture simply and reliably.

Read the section "Notes on the safe use of the Tire Mobility Kit".

### **⚠ WARNING**

Do not use the TMK if a tire is severely damaged by driving run flat or with insufficient air pressure.

Only punctured areas located within the tread region of the tire can be sealed using the TMK.

### Notes On the Safe Use of the Tire Mobility Kit

- Park your vehicle at the side of the road so that you can work with the Tire Mobility Kit away from moving traffic.
- To be sure your vehicle will not move, even when you are on a fairly level ground, always apply your parking brake.
- Only use the Tire Mobility Kit for sealing/inflation passenger vehicle tires. Only punctured areas located within the tread region of the tire can be sealed using the tire mobility kit.
- Do not use on motorcycles, bicycles or any other type of tires.
- When the tire and wheel are damaged, do not use Tire Mobility Kit for your safety.
- Use of the Tire Mobility Kit may not be effective for tire damage larger than about 0.16 inch (4 mm).  
If the tire cannot be made roadworthy with the Tire Mobility Kit, contact an authorized retailer of Genesis Branded products.
- Do not use the Tire Mobility Kit if a tire is severely damaged by driving run flat or with insufficient air pressure.
- Do not remove any foreign objects such as nails or screws that have penetrated the tire.
- Provided the vehicle is outdoors, leave the engine running. Otherwise operating the compressor may eventually drain the vehicle battery.
- Never leave the Tire Mobility Kit unattended while it is being used.
- Do not leave the compressor running for more than 10 minutes at a time or it may overheat.
- Do not use the Tire Mobility Kit if the ambient temperature is below -22 °F (-30 °C).

- In case of skin contact with the sealant, wash the area thoroughly with plenty of water. If the irritation persists, seek medical attention.
- In case of eye contact with the sealant, flush your eyes for at least 15 minutes. If the irritation persists, seek medical attention.
- In case of swallowing the sealant, rinse the mouth and drink plenty of water. Never give anything to an unconscious person and seek medical attention immediately.
- Long time exposure to the sealant may cause damage to bodily tissue such as kidney, etc.

## Components of the Tire Mobility Kit

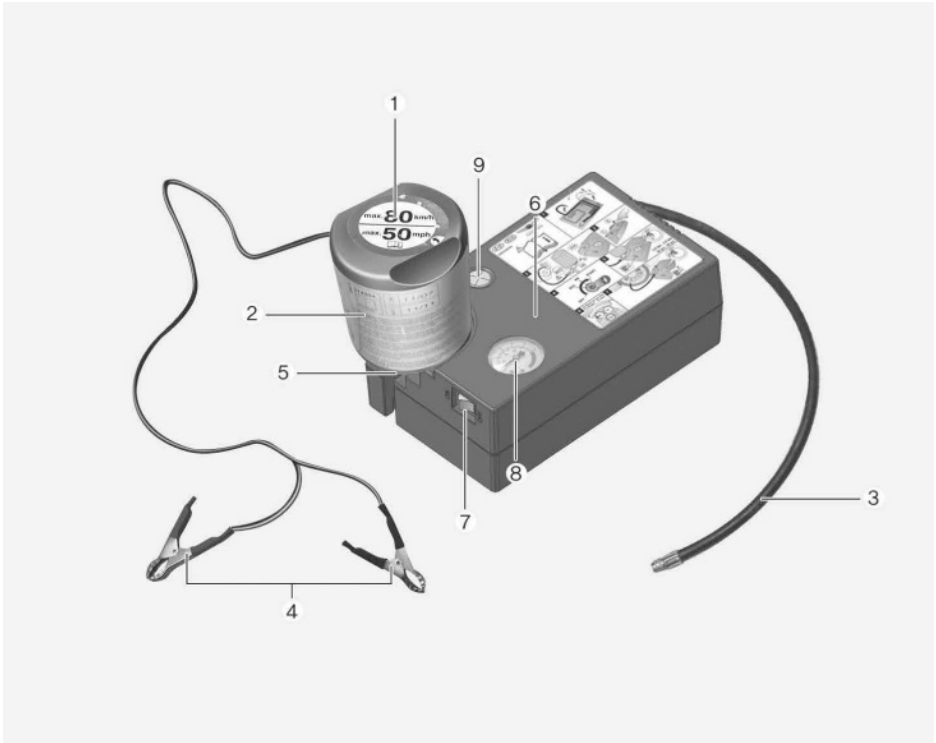

- (1) Speed restriction label
- (2) Sealant bottle and label with speed restriction
- (3) Filling hose from sealant bottle to wheel
- (4) Connectors and cable for battery direct connection
- (5) Holder for the sealant bottle
- (6) Compressor
- (7) ON/OFF switch
- (8) Pressure gauge for displaying the tire inflation pressure
- (9) Button for reducing tire inflation pressure

Connectors, cable and connection hose are stored in the compressor housing.

Strictly follow the specified sequence, otherwise the sealant may escape under high pressure.

**⚠ WARNING**

Do not use the tire sealant after the sealant has expired. (The expiration date is on the sealant container.) This can increase the risk of tire failure.

**⚠ WARNING**

- Keep out of reach of children.
- Avoid contact with eyes.
- Do not swallow.

### Using the Tire Mobility Kit

**⚠ WARNING**



Detach the speed restriction label (1) from the sealant bottle (2), and place it in a highly visible place inside the vehicle such as on the steering wheel to remind the driver not to drive too fast.

**⚠ CAUTION**

If only the tire pressure needs to be adjusted, refer to "How to Adjust Tire Pressure" in this chapter.

Before using the Tire Mobility Kit, be fully aware of the explanation on the sealant.

1. Shake the sealant bottle (2).
2. Connect the filling hose (3) to the sealant bottle (2) in the direction of [A] and connect the sealant bottle to the compressor holder (5) in the direction of [B].

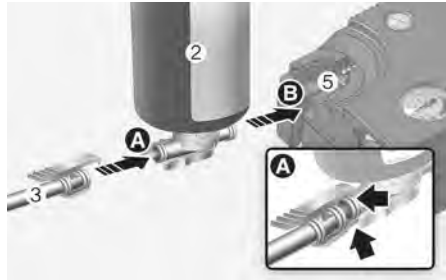

3. Ensure that the compressor is switched OFF.
4. Unscrew the valve cap from the valve of the defective wheel and screw the filling hose (3) of the sealant bottle onto the valve.



**NOTICE**

Securely install the sealant filling hose to the valve. If not, sealant may flow backward, possibly clogging the filling hose.

5. Open the engine hood.

6. Remove the engine compartment fuse box cover and open the service cover.

Connect cables (4) to the jumper terminals in numerical order.

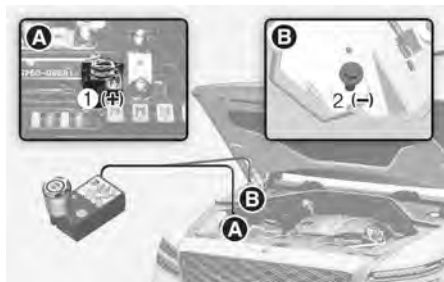

- (1) RED cable: (+) jumper terminal  
 (2) BLACK cable: (-) jumper terminal

### **⚠ CAUTION**

- TMK cable connection can be dangerous if done incorrectly. Therefore, to avoid harm to yourself or damage to the TMK or battery, follow the TMK cable connection procedures.
- When disconnecting the TMK cables, disconnect the BLACK (-) cable first from the jumper terminal and then disconnect the RED (+) cable.
- Be careful for battery sparks when connecting or disconnecting the battery cables.

7. With the engine running, switch on the compressor and let it run for about 5-7 minutes to fill the sealant up to proper inflation pressure. (Refer to the "Tires and Wheels" section in chapter 2). The inflation pressure of the tire after filling is unimportant and will be checked/corrected later.

Be careful not to overinflate the tire and stay away from the tire when filling it.

### **⚠ CAUTION**

Do not attempt to drive your vehicle if the tire pressure is below 29 psi (200 kpa). This could result in an accident due to sudden tire failure.

8. Switch off the compressor.
9. Detach the hoses from the sealant bottle connector and from the tire valve.

Return the Tire Mobility Kit to its storage location in the vehicle.

### **⚠ WARNING**

Do not leave your engine running in a poorly ventilated area for extended periods of time. Carbon monoxide poisoning and suffocation can occur.

10. Immediately drive about 4-6 miles (7-10 km or about 10 minutes) to evenly distribute the sealant in the tire.

Do not exceed a speed of 50 mph (80 km/h). If possible, do not fall below a speed of 12 mph (20 km/h).

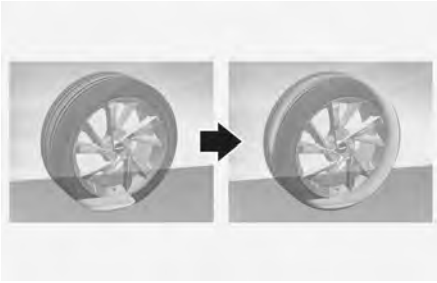

While driving, if you experience any unusual vibration, ride disturbance or noise, reduce your speed and drive with caution until you can safely pull off of the side of the road.

Call for road side service or towing.

11. After driving about 4-6 miles (7-10 km or about 10 minutes), stop at a safe location.
12. Connect the filling hose (3) directly into the tire valve.



13. Remove the engine compartment fuse box cover and open the service cover.  
Connect cables (4) to the jumper terminals in numerical order.

14. Adjust the tire inflation pressure to the recommended tire inflation.

With the engine running, proceed as follows:

**To increase the inflation pressure:**

Switch on the compressor. To check the current inflation pressure setting, briefly switch off the compressor.

**To reduce the inflation pressure:**

Press the button (9) on the compressor.

### NOTICE

Do not let the compressor run for more than 10 minutes, otherwise the device will overheat and may be damaged.

---

### *i* Information

The pressure gauge may show higher than actual reading when the compressor is running. To get an accurate tire pressure, the compressor needs to be turned off.

---

### CAUTION

If the inflation pressure is not maintained, drive the vehicle a second time, refer to step 10. Then repeat steps 11 to 14.

Use of the TMK may be ineffectual for tire damage larger than about 0.16 in (4 mm).

Contact an authorized retailer of Genesis Branded products if the tire cannot be made roadworthy with the Tire Mobility Kit.

---

**⚠ WARNING**

The tire inflation pressure must be inflated to the proper pressure (Refer to the "Tires and Wheels" section in chapter 2). If it is not, do not continue driving.

Call for road side service or towing.

**⚠ CAUTION**

Tire pressure sensor

The sealant on the tire pressure sensor and wheel should be removed when you replace the tire with a new one and inspect the tire pressure sensors. Have this done at an authorized retailer of Genesis Branded products.

***i* Information**

When reinstalling the repaired or replaced tire and wheel on the vehicle, tighten the wheel bolt to 101-116 lbf-ft (14-16 kgf-m).

**How to Adjust Tire Pressure**

1. After driving about 4-6 miles (7-10 km or about 10 minutes), stop at a safe location.
2. Connect the filling hose (3) directly into the tire valve.



3. Remove the engine compartment fuse box cover and open the service cover.

Connect cables (4) to the jumper terminals in numerical order.

4. Adjust the tire inflation pressure to the recommended tire inflation.

With the engine running, proceed as follows:

**To increase the inflation pressure:**

Switch on the compressor. To check the current inflation pressure setting, briefly switch off the compressor.

**To reduce the inflation pressure:**

Press the button (9) on the compressor.

**NOTICE**

Do not let the compressor run for more than 10 minutes, otherwise the device will overheat and may be damaged.

***i* Information**

The pressure gauge may show higher than actual reading when the compressor is running. To get an accurate tire pressure, the compressor needs to be turned off.

**⚠ CAUTION**

Do not use the sealant when the tire pressure only needs to be adjusted.

**⚠ WARNING**

The tire inflation pressure must be inflated to the proper pressure (Refer to the "Tires and Wheels" section in chapter 2). If it is not inflated to the proper pressure, do not continue driving.

Call for road side service or towing.

## Towing

### Towing Service

Flatbed Towing



Wheel lift Towing

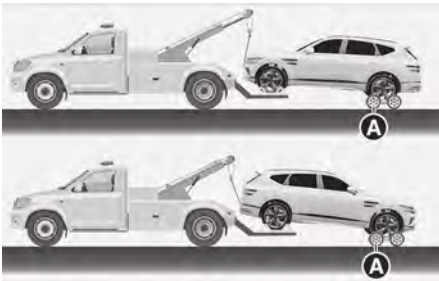

[A] Dollies

If towing is necessary, contact an authorized retailer of Genesis Branded products or a commercial tow-truck service.

AWD vehicles must be towed with a wheel lift and dollies or flatbed with all the wheels off the ground.

### NOTICE

To prevent damage when towing:

- Do not lift using the trailer hitch or body and chassis parts.
- Do not tow vehicles with sling-type equipment. Only use wheel lift or flatbed equipment.



When towing your vehicle without wheel dollies:

1. Release the EPB before turning off the engine.
2. Press the Engine Start/Stop button to the OFF position.
3. Change the gear to N (Neutral) by pressing the P release button while pressing the brake pedal. For more information, refer to the "Automatic Transmission" section in chapter 6.
4. Press the Engine Start/Stop button to the ACC position.

### NOTICE

Always shift the gear to N (Neutral) to prevent damage to the transmission before towing.



## Removable Towing Hook

1. Open the liftgate, and remove the towing hook from the tool case.

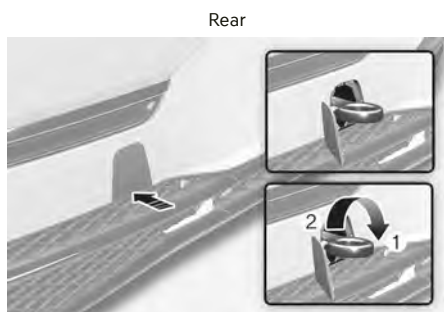
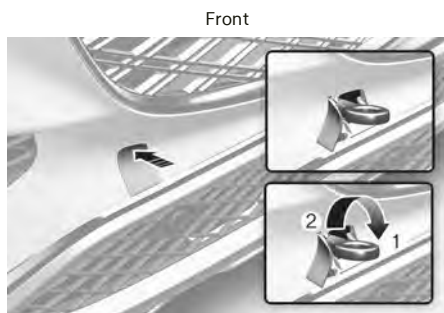

- (1) Install
- (2) Remove
2. Remove the hole cover by pressing the cover on the bumper.
3. Install the towing hook by turning it clockwise into the hole until it is fully secured.
4. Remove the towing hook and install the cover after use.

## Emergency Towing

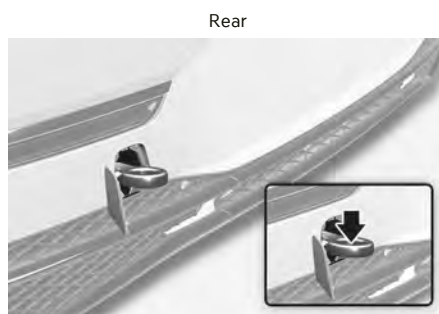
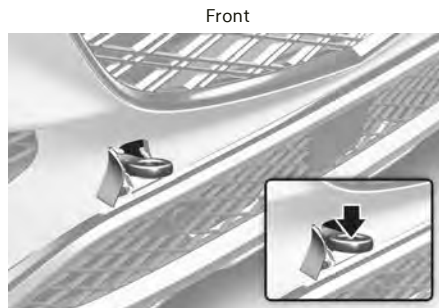

If emergency towing is necessary, contact authorized retailer of Genesis Branded products or a commercial tow-truck service.

If a tow-truck service is not available in an emergency, your vehicle can be temporarily towed using a cable or chain secured to the removable towing hook at the front (or rear) of the vehicle.

Perform emergency towing using cables or chains on hard-surfaced roads for a short distance and at low speeds. The wheels, axles, powertrain, steering, and brakes must all be in good working condition.

### **WARNING**

Use extreme caution when towing the vehicle with a cable or chain. A driver must be in the vehicle to steer it and operate the brakes. Passengers other than the driver must not be in the vehicle.

Always follow these emergency towing precautions:

- Press the Engine Start/Stop button to the ACC position so the steering wheel is not locked.
  - Shift the gear to N (Neutral).
  - Release the parking brake.
  - Depress the brake pedal with more force than normal because you have reduced braking performance.
  - More steering effort is required because the power steering system is disabled.
  - Use a vehicle heavier than your own to tow your vehicle.
  - The drivers of both vehicles must communicate with each other frequently.
  - Before emergency towing, check the removable hook is not broken or damaged.
  - Fasten the towing cable or chain securely to the hook.
  - Do not jerk the cables, chains, or removable hook. Apply steady and even force.
- Before towing, check the automatic transmission for fluid leaks under your vehicle. If the automatic transmission fluid is leaking, flatbed equipment or a towing dolly must be used.

### NOTICE

Accelerate or decelerate the vehicle in a slow and gradual manner while maintaining tension on the tow rope or chain to start or drive the vehicle. Otherwise, tow hooks and the vehicle may be damaged.

---

### NOTICE

To avoid damage to your vehicle and vehicle components when towing:

- Always pull straight ahead when using the towing hooks. Do not pull from the side or at a vertical angle.
  - Do not use the towing hooks to pull the vehicle out of mud, sand, or other conditions from which the vehicle cannot be driven out under its own power.
  - Limit the vehicle speed to 10 mph (15 km/h) and drive less than 1 mile (1.5 km) when towing to avoid serious damage to the automatic transmission.
- 

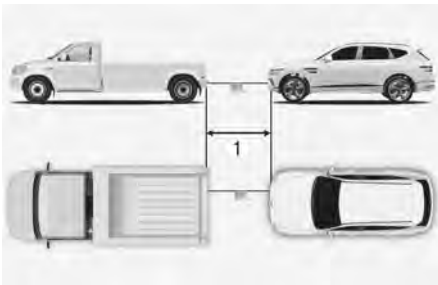

(1) 16 ft. (5 m)

- Use a towing cable or chain less than 16 ft. (5 m) long. Attach a white or red cloth (about 12 in. (30 cm) wide) in the middle of the cable or chain for easy visibility.
- Drive carefully so the towing cable or chain remains tight during towing.

# 9. Maintenance

Engine Compartment .....	9-4
Maintenance Services .....	9-6
Owner's Responsibility .....	9-6
Owner Maintenance Precautions .....	9-6
Owner Maintenance .....	9-7
Owner Maintenance Schedule .....	9-7
Scheduled Maintenance Services .....	9-8
Normal Maintenance Schedule .....	9-10
Normal Maintenance Schedule (Cont.) .....	9-12
Maintenance Under Severe Usage Conditions .....	9-14
Explanation of Scheduled Maintenance Items .....	9-16
Engine Oil And Filter .....	9-16
Drive Belts .....	9-16
Fuel Lines, Fuel Hoses And Connections .....	9-16
Fuel Filter (For Gasoline Engine) .....	9-16
Vapor Hose And Fuel Filler Cap .....	9-16
Air Cleaner Filter .....	9-16
Spark Plugs (For Gasoline Engine) .....	9-16
Cooling System .....	9-16
Engine Coolant/Liquid-Cooled Intercooler Coolant .....	9-16
Automatic Transmission Fluid .....	9-17
Brake Hoses And Lines .....	9-17
Brake Fluid .....	9-17
Brake Discs, Pads, Calipers, And Rotors .....	9-17
Exhaust Pipe And Muffler .....	9-17
Drive Shafts And Boots .....	9-17
Propeller Shaft And Related .....	9-17
Suspension Mounting Bolts .....	9-17
Steering Gear Box, Linkage & Boots/Lower Arm Ball Joint .....	9-17
Air Conditioning Refrigerant .....	9-18
Engine Oil .....	9-18
Checking the Engine Oil Level .....	9-18
Checking the Engine Oil And Filter .....	9-19
Engine Coolant/Liquid-Cooled Intercooler Coolant .....	9-20
Checking the Coolant Level .....	9-20
Changing Coolant .....	9-22

Brake Fluid.....	9-23
Checking the Brake Fluid Level.....	9-23
Washer Fluid.....	9-24
Checking the Washer Fluid Level.....	9-24
Air Cleaner.....	9-24
Filter Replacement.....	9-24
Cabin Air Filter.....	9-26
Filter Inspection.....	9-26
Filter Replacement.....	9-26
Wiper Blades.....	9-27
Blade Inspection.....	9-27
Blade Replacement.....	9-27
Battery.....	9-29
For Best Battery Service.....	9-30
Battery Replacement.....	9-31
Battery Capacity Label.....	9-32
Battery Recharging.....	9-32
Reset Items.....	9-33
Tires and Wheels.....	9-34
Tire Care.....	9-34
Recommended Cold Tire Inflation Pressures.....	9-34
Check Tire Inflation Pressure.....	9-35
Tire Rotation.....	9-36
Wheel Alignment and Tire Balance.....	9-36
Tire Replacement.....	9-37
Wheel Replacement.....	9-38
Tire Traction.....	9-38
Tire Maintenance.....	9-38
Tire Sidewall Labeling.....	9-38
Tire Terminology and Definitions.....	9-41
Low Aspect Ratio Tires.....	9-44
All Season Tires.....	9-44
Summer Tires.....	9-45
Snow Tires.....	9-45
Radial-Ply Tires.....	9-45
Fuses.....	9-46

# 9. Maintenance

Instrument Panel Fuse Replacement .....	9-47
Engine Compartment Panel Fuse Replacement .....	9-48
Fuse/Relay Panel Description .....	9-49
LED Lights .....	9-66
Headlight, Parking Light, Turn Signal Light, Daytime Running Light (DRL) Replacement .....	9-67
Side Repeater Light Replacement .....	9-68
Puddle Light Replacement .....	9-68
Rear Combination Light Replacement .....	9-68
Reverse Light Replacement .....	9-69
High Mounted Stop Light Replacement .....	9-69
License Plate Light Replacement .....	9-70
Interior Light Replacement .....	9-70
Appearance Care .....	9-72
Exterior Care .....	9-72
Interior Care .....	9-76
Emission Control System .....	9-79
1. Crankcase Emission Control System .....	9-79
2. Evaporative Emission Control System Including Onboard Refueling Vapor Recovery (ORVR) .....	9-79
3. Exhaust Emission Control System .....	9-80
Gasoline Particulate Filter (GPF) .....	9-81
California Perchlorate Notice .....	9-82

## Engine Compartment

2.5 T-GDI

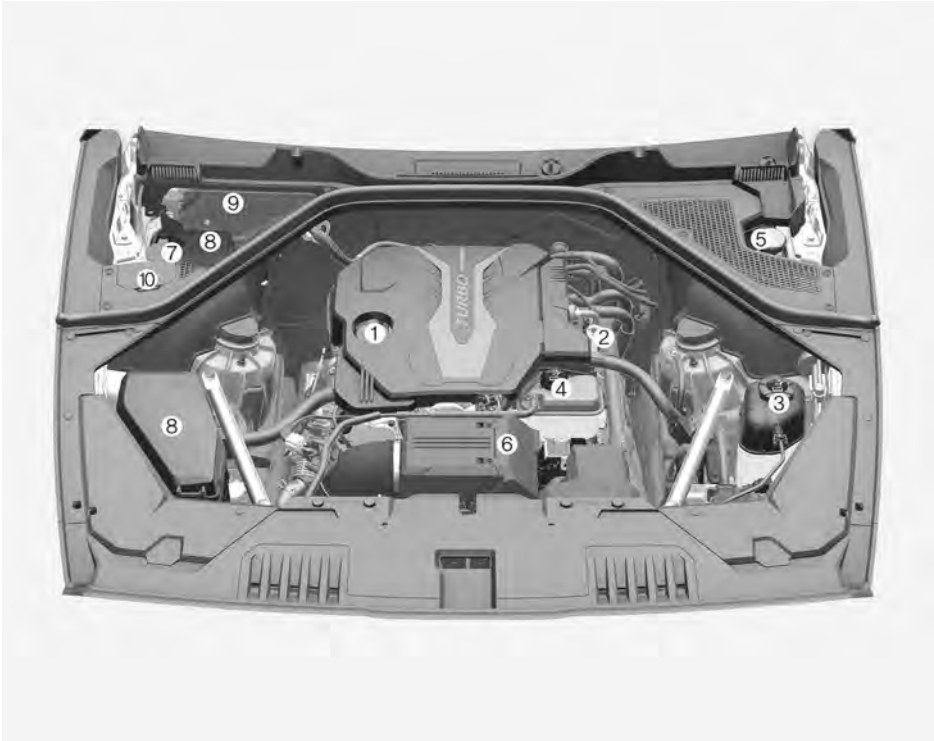

The actual engine compartment in the vehicle may differ from the illustration.

- (1) Engine oil filler cap
- (2) Engine oil dipstick
- (3) Engine coolant reservoir
- (4) Liquid-cooled intercooler coolant reservoir
- (5) Brake fluid reservoir
- (6) Air cleaner
- (7) Windshield washer fluid reservoir
- (8) Fuse box
- (9) Cabin air filter
- (10) Jumper terminal

## 3.5 T-GDI/3.5 T-GDI (48 V) MHEV



The actual engine compartment in the vehicle may differ from the illustration.

- (1) Engine oil filler cap (under the engine cover)
- (2) Engine oil dipstick
- (3) Engine coolant reservoir
- (4) Liquid-cooled intercooler coolant reservoir
- (5) Brake fluid reservoir
- (6) Air cleaner
- (7) Windshield washer fluid reservoir
- (8) Fuse box
- (9) Cabin air filter
- (10) Jumper terminal

## Maintenance Services

Exercise the utmost care to prevent damage to your vehicle and injury to yourself whenever performing any maintenance or inspection procedures.

Have your vehicle maintained and repaired by an authorized retailer of Genesis Branded products. An authorized retailer of Genesis Branded products meets Genesis Branded Vehicle's high service quality standards and receives technical support from Genesis Branded Vehicle to provide you with a high level of service satisfaction.

## Owner's Responsibility

Maintenance service and record retention are the owner's responsibility.

Retain documents that show proper maintenance has been performed on your vehicle in accordance with the scheduled maintenance service charts on the following pages. You need this information to establish your compliance with the servicing and maintenance requirements of your vehicle warranties.

Detailed warranty information is provided in your Owner's Handbook & Warranty Information booklet.

Repairs and adjustments required as a result of improper maintenance or a lack of required maintenance are not covered.

## Owner Maintenance Precautions

Inadequate, incomplete, or insufficient servicing may result in operational problems with your vehicle that could cause vehicle damage or a collision that results in serious injury or death.

Your vehicle must not be modified in any way. Such modifications may adversely affect the performance, safety, or durability of your vehicle and may, in addition, violate conditions of the limited warranties covering the vehicle.

### **NOTICE**

Improper owner maintenance during the warranty period may affect warranty coverage. For more information, read the separate Owner's Handbook & Warranty Information Booklet provided with the vehicle.

---



## Owner Maintenance

### WARNING

Performing maintenance on the vehicle can be dangerous. If you lack sufficient knowledge, experience, or proper tools and equipment to do the work, have it done by an authorized retailer of Genesis Branded products. Before performing maintenance:

- Park your vehicle on level ground. Shift the vehicle to P (Park), apply the parking brake, and press the Engine Start/Stop button to the OFF position.
- Block the tires (front and back) to prevent the vehicle from moving.  
Remove loose clothing or jewelry that can become entangled in moving parts.
- If you must run the engine during maintenance, do it in an outdoor area or in an area with plenty of ventilation.
- Keep flames, sparks, or smoking materials away from the battery and fuel-related parts.

### WARNING

Touching metal parts



Do not touch metal parts (including strut bars) while the engine is operating or hot. Doing so could result in serious personal injury. Turn off the engine and wait until the metal parts cool down before working on the vehicle.

The following lists are vehicle checks and inspections that should be performed by the owner or an authorized retailer of Genesis Branded products at the frequencies indicated to help ensure safe and dependable operation of your vehicle.

Any adverse conditions should be brought to the attention of your authorized retailer of Genesis Branded products as soon as possible.

These Owner Maintenance vehicle checks are generally not covered by warranties and you may be charged for labor, parts, and lubricants used.

## Owner Maintenance Schedule

### *When you stop for fuel:*

- Check the windshield washer fluid level.
- Check for low or under-inflated tires.

### *While operating your vehicle:*

- Note any changes in the sound of the exhaust or any smell of exhaust fumes in the vehicle.
- Check for vibrations in the steering wheel. Notice if there is any increased steering effort or looseness in the steering wheel, or change in its straight-ahead position.
- Notice if your vehicle constantly turns slightly or "pulls" to one side when traveling on smooth, level road.
- When stopping, listen and check for unusual sounds, pulling to one side, increased brake pedal travel, or "hard-to-push" brake pedal.
- If any slipping or changes in the operation of your transmission occurs, check the transmission fluid level.
- Check the automatic transmission P (Park) function.
- Check the parking brake.

- Check for fluid leaks under your vehicle (water dripping from the air conditioning system during or after use is normal).

### ***At least monthly:***

- Check the coolant level in the engine coolant reservoir.
- Check the operation of all exterior lights, including the headlamps, stoplights, turn signals, and hazard warning flashers.
- Check the inflation pressures of all tires including the spare for tires that are worn, show uneven wear, or are damaged.
- Check for loose wheel lug nuts.

### **WARNING**

Be careful when checking your coolant level when the engine is hot. This may result in coolant being blown out of the opening and cause serious burns and other injuries.

---

### ***At least twice a year:***

- Check the radiator, heater, and air conditioning hoses for leaks or damage.
- Check the windshield washer spray and wiper operation. Clean the wiper blades with a clean cloth dampened with washer fluid.
- Check the headlight alignment.
- Check the muffler, exhaust pipes, shields, and clamps.
- Check the seat belts for wear and function.

### ***At least once a year:***

- Clean the body and door drain holes.
- Lubricate the door hinges and hood hinges.
- Lubricate the door, hood locks, and latches.
- Lubricate door rubber weather strips.
- Check the air conditioning system.
- Inspect and lubricate the automatic transmission linkage and controls.
- Clean the battery and terminals.
- Check the brake fluid level.

## Scheduled Maintenance Services

If any of the following conditions apply, follow the Maintenance Under Severe Usage Conditions.

- Repeated driving short distance of less than 8 km (5 miles) in normal temperature or less than 16 km (10 miles) in freezing temperature
- Extensive engine idling or low speed driving for long distances
- Driving on rough, dusty, muddy, unpaved, graveled, or salt-spread roads
- Driving in areas using salt or other corrosive materials or in very cold weather
- Driving in heavy dust conditions
- Driving in heavy traffic area
- Driving on uphill, downhill, or mountain roads repeatedly
- Towing a trailer or using a camper, or driving with loads on the roof
- Driving as a patrol car, taxi, or other commercial use of vehicle towing
- Frequently driving at high speeds or rapid acceleration/deceleration
- Frequently driving in stop-and-go conditions

- Using engine oil that is not recommended (mineral type, semi-synthetic, lower grade spec, etc.)

If your vehicle is operated under the above conditions, you should inspect, replace or refill more frequently than the following Normal Maintenance Schedule. After the periods or distance shown in the chart, continue to follow the prescribed maintenance intervals.

### *i* Information

After driving more than 10 years or 100,000 mi., use severe maintenance schedule.

### *i* Information

- As it is normal for engine oil to be consumed during driving, the engine oil level should be checked on regular basis.
- The engine oil change interval under normal operating conditions is based on the use of engine oil that meets the recommended engine specification for your vehicle. If any other type of engine oil is used, replace the engine oil according to the maintenance schedule under severe operating conditions.
- The vehicle may be equipped with the Oil Life Management System that predicts engine oil life based on the driver's driving history and alerts the driver to change engine oil.
  - If the deterioration of the engine oil increases depending on the driver's driving severity, the remaining oil life alert appears on the instrument cluster before the normal engine oil replacement interval. Have the engine oil and filter changed by an authorized retailer of Genesis Branded products.

- Oil Life Management System works when the recommended engine oil is used. So, if recommended engine oil is not used, replace the engine oil according to the maintenance schedule under severe usage conditions.

Also, check the amount of engine oil regularly as this system assumes that the engine oil is being filled normally.

- Always reset the remaining engine oil life whenever the engine oil is changed. Otherwise, the indication of remaining Oil life in the Oil Life Management System may not be accurate.

To reset the Oil Change Reminder, select "**RESET**" from the infotainment system screen. Then, select "**Yes**" when the message "**Has the engine oil been changed? Press [Yes] to reset the oil life.**" appears on the screen.

- If there is no alert until the maximum maintenance interval, have the vehicle checked by an authorized retailer of Genesis Branded product.

## Normal Maintenance Schedule

I: Inspect and if necessary, adjust, correct, clean or replace.

R: Replace or change.

Maintenance intervals	Number of months or driving distance, whichever comes first														
	Months	12	24	36	48	60	72	84	96	108	120	132	144	156	
	Miles×1,000	8	16	24	32	40	48	56	64	72	80	88	96	104	
	Km×1,000	13	26	39	52	65	78	91	104	117	130	143	156	169	
Maintenance item															
Engine oil and engine oil filter *1, *4, *6	R	R	R	R	R	R	R	R	R	R	R	R	R	R	
Fuel additives *2	Add every 8,000 miles (13,000 km) or 12 months														
Air cleaner filter	Inspect every 8,000 miles (13,000 km) or 12 months, replace every 24,000 miles (39,000 km) or 36 months														
Spark plugs							R							R	
Rotate tires (includes tread wear inspection and tire pressure check)	Rotate tires every 8,000 miles (13,000 km) or 12 months														
Cabin air filter (for evaporator and blower unit)		R		R		R		R		R		R			
Drive belts *3	At first, inspect at 48,000 miles (78,000 km) or 72 months, after that, inspect every 8,000 miles (13,000 km) or 12 months														
MHEV (Mild Hybrid) belt *5 (for 3.5 T-GDI, if equipped)	Inspect every 10,000 km (6,000 miles) or 12 months Replace every 100,000 km (60,000 miles) or 48 months														

\*1 Requires <API SN PLUS (or above) Full synthetic> grade engine oil. If a lower grade engine oil (mineral oil including Semi-synthetic) is used, then the engine oil and engine oil filter must be replaced as indicated severe maintenance condition.

\*2 If TOP TIER Detergent Gasoline is not available, one bottle of additive is recommended. Additives are available from your authorized retailer of Genesis Branded products along with information on how to use them. Do not mix other additives.

\*3 The drive belt should be replaced when cracks occur or tension is reduced.

\*4 Never add any additives to the engine oil. Engine oil additives can change the properties of engine oil and may cause serious engine failure.

\*5 Inspect drive belt tensioner, idler and alternator pulley and if necessary correct or replace.

\*6 3.5 T-GDI/2.5 T-GDI

---

***i* Information**

- 3.5 T-GDI

Requires <API SN PLUS (or above) Full synthetic> grade engine oil. If a lower grade engine oil (mineral oil including semi-synthetic) is used, replace the engine oil and engine oil filter as indicated in maintenance under severe usage conditions.

- 2.5 T-GDI

Requires <API SN PLUS (or above) Full synthetic> grade engine oil. If a lower grade engine oil (mineral oil including semi-synthetic) is used, replace the engine oil and engine oil filter as indicated in maintenance under severe usage conditions.

---

### Normal Maintenance Schedule (Cont.)

I: Inspect and if necessary, adjust, correct, clean or replace.

R: Replace or change.

Maintenance intervals	Number of months or driving distance, whichever comes first														
	Months	12	24	36	48	60	72	84	96	108	120	132	144	156	
	Miles×1,000	8	16	24	32	40	48	56	64	72	80	88	96	104	
	Km×1,000	13	26	39	52	65	78	91	104	117	130	143	156	169	
Maintenance item															
Engine coolant		At first, replace at 120,000 miles (200,000 km) or 120 months. After that, replace every 24,000 miles (40,000 km) or 24 months													
Battery condition		I	I	I	I	I	I	I	I	I	I	I	I	I	
Brake lines, hoses, and connections		I	I	I	I	I	I	I	I	I	I	I	I	I	
Front brake disc/pads, calipers		I	I	I	I	I	I	I	I	I	I	I	I	I	
Rear brake disc/pads		I	I	I	I	I	I	I	I	I	I	I	I	I	
Steering gear rack, linkage and boots / lower arm ball joint, upper arm ball joint		I	I	I	I	I	I	I	I	I	I	I	I	I	
Driveshaft and boots		I	I	I	I	I	I	I	I	I	I	I	I	I	
Suspension mounting bolts		I	I	I	I	I	I	I	I	I	I	I	I	I	
Air conditioner refrigerant		I	I	I	I	I	I	I	I	I	I	I	I	I	
Air conditioner compressor		I	I	I	I	I	I	I	I	I	I	I	I	I	
Propeller shaft		I	I	I	I	I	I	I	I	I	I	I	I	I	
Exhaust pipe and muffler		I	I	I	I	I	I	I	I	I	I	I	I	I	

I: Inspect and if necessary, adjust, correct, clean or replace.

R: Replace or change.

Maintenance intervals	Number of months or driving distance, whichever comes first														
	Months	12	24	36	48	60	72	84	96	108	120	132	144	156	
	Miles×1,000	8	16	24	32	40	48	56	64	72	80	88	96	104	
	Km×1,000	13	26	39	52	65	78	91	104	117	130	143	156	169	
Maintenance item															
Automatic transmission fluid *1		No check, No service required													
Front differential oil (AWD) /Rear differential oil *2					I				I				I		
Transfer case oil (AWD)		No check, No service required													
Vapor hose, fuel filler cap and fuel tank		Inspect every 16,000 miles (26,000 km) or 24 months													
Fuel tank air filter															
Fuel lines, hoses and connections															
Parking brake			I		I		I		I		I		I		
Brake fluid		Inspect every 8,000 miles (13,000 km) or 12 months, Replace every 48,000 miles (78,000 km) or 48 months													
Electronic Limited Slip Differential (e-LSD) oil		No check, No service required													

\*1 Use only the specified automatic transmission fluid. (Refer to “Recommended Lubricants and Capacities” section in chapter 2 or the label in the engine compartment.)

\*2 Front and rear differential oil should be changed anytime the front or rear differential has been submerged in water.

## *i* Information

The fuel filter is considered to be maintenance free but periodic inspection is recommended for this maintenance schedule depends on fuel quality. If there are some important safety matters like fuel flow restriction, surging, loss of power, hard starting problem, etc., replace the fuel filter immediately regardless of maintenance schedule and consult an authorized retailer of Genesis Branded Products for details.

## Maintenance Under Severe Usage Conditions

The following items must be serviced more frequently on the vehicles mainly used under severe driving conditions. Refer to the chart below for the appropriate maintenance intervals.

R: Replace

I: Inspect and if necessary, adjust, correct, clean, or replace

Maintenance item	Maintenance operation	Maintenance intervals	Driving condition
Engine oil and engine oil filter <sup>1</sup>	R	Replace every 5,000 miles (8,000 km) or 6 months	D, H, I, L
Air cleaner filter	R	Inspect more frequently depending on the condition	C, E
Spark plugs	R	Replace more frequently depending on the condition	A, B, F, G, H, I, K
Cabin air filter	R	Replace more frequently depending on the condition	C, E, G
Disc brakes and pads, calipers and rotors	I	Inspect more frequently depending on the condition	C, D, E, G, H
Steering gear rack, linkage and boots	I	Inspect more frequently depending on the condition	C, D, E, F, G
Driveshaft and boots	I	Inspect more frequently depending on the condition	C, D, E, F, G, H, I, J
Suspension ball joints	I	Inspect more frequently depending on the condition	C, D, E, F, G
Propeller shaft	I	Inspect more frequently depending on the condition	C, D, E, F, G, H, I, J
Automatic transmission fluid	R	Replace every 60,000 miles (100,000 km)	A, C, D, E, F, G, H, I, K
Front differential oil (AWD) / Rear differential oil	R	Replace every 72,000 miles (120,000 km)	C, D, E, G, H, I, J
Transfer case oil (AWD)	-	No Check, No service required	-
Parking brake	I	Inspect more frequently depending on the condition	C, D, G, H



Maintenance item	Maintenance operation	Maintenance intervals	Driving condition
Electronic Limited Slip Differential (e-LSD) oil	-	No Check, No service required	-
MHEV (Mild Hybrid) belt (if equipped)	I	Inspect every 5,000 km (3,000 miles) or 6 months	B, C, D, E, I, K
	R	Replace every 50,000 km (30,000 miles) or 24 months	

\*1 Requires <API SN PLUS (or above) Full synthetic> grade engine oil. If a lower grade engine oil (mineral oil including Semi-synthetic) is used, then the engine oil and engine oil filter must be replaced as indicated severe maintenance condition.

### ***Severe driving conditions***

- A. Repeatedly driving short distance of less than 5 miles (8 km) in normal temperature or less than 10 miles (16 km) in freezing temperature
- B. Extensive engine idling or low speed driving for long distances
- C. Driving on rough, dusty, muddy, unpaved, graveled or salt-spread roads
- D. Driving in areas using salt or other corrosive materials or in very cold weather
- E. Driving in heavy dust conditions
- F. Driving in heavy traffic area
- G. Driving on uphill, downhill, or mountain roads
- H. Using for towing or camping and driving with loads on the roof
- I. Driving as a patrol car, taxi, other commercial use of vehicle towing
- J. Frequently driving under high speed or rapid acceleration/deceleration
- K. Frequently driving in stop-and-go conditions
- L. Engine oil usage which is not recommended (Mineral type, Semi-synthetic, Lower grade spec, etc.)

## Explanation of Scheduled Maintenance Items

### Engine Oil And Filter

The engine oil and filter should be changed at the intervals specified in the maintenance schedule. If the vehicle is being driven in severe conditions, more frequent oil and filter changes are required.

### Drive Belts

Inspect all drive belts for evidence of cuts, cracks, excessive wear, or oil saturation. Replace them if necessary.

Check the drive belts periodically for proper tension and adjusted as necessary.

#### *i* Information

Always turn off the engine before inspecting the drive belts.

---

### Fuel Lines, Fuel Hoses And Connections

Check the fuel lines, fuel hoses, and connections for leakage and damage. Have an authorized retailer of Genesis Branded products replace any damaged or leaking parts immediately.

### Fuel Filter (For Gasoline Engine)

The fuel filter is considered to be maintenance free but periodic inspection is recommended depending on the fuel quality. If there is fuel flow restriction, surging, loss of power, or hard starting, contact an authorized retailer of Genesis Branded products for details.

### Vapor Hose And Fuel Filler Cap

The vapor hose and fuel filler cap should be inspected at intervals specified in the maintenance schedule. Make sure a new vapor hose or fuel filler cap is correctly replaced.

### Air Cleaner Filter

Have the air cleaner filter replaced by an authorized retailer of Genesis Branded products.

### Spark Plugs (For Gasoline Engine)

Be sure to install new spark plugs with the correct heat range.

When installing new spark plugs, make sure the ignition coils are clean and free of any oil or debris. Clean and wipe off the bottom portion of the ignition coil to prevent any contamination with the spark plug during installation.

#### WARNING

Do not remove spark plugs from the vehicle when the engine is hot. You may damage the engine and may also risk burn injury.

---

### Cooling System

Check the cooling system components, such as radiator, coolant reservoir, hoses, and connections for leakage and damage. Replace any damaged parts.

### Engine Coolant/Liquid-Cooled Intercooler Coolant

The coolant should be changed at the intervals specified in the maintenance schedule.

## Automatic Transmission Fluid

The automatic transmission fluid level does not need to be checked under normal usage conditions.

If driven in severe operating conditions, have the automatic transmission fluid changed by an authorized retailer of Genesis Branded products according to the maintenance schedule under severe conditions.

### *i* Information

The color of a new automatic transmission fluid is red. As the vehicle is driven, the automatic transmission fluid begins to look darker.

This is normal and the automatic transmission fluid does not need to be replaced based on the color change.

### NOTICE

Only use the automatic transmission fluid specified in the "Recommended Lubricants and Capacities" section in chapter 2 to prevent transmission damage.

## Brake Hoses And Lines

Visually check for proper installation, chafing, cracks, deterioration, and any leakage. Replace any deteriorated or damaged parts immediately.

## Brake Fluid

Check the brake fluid level in the brake fluid reservoir. The level should be between the MIN and the MAX marks on the side of the reservoir. Use only hydraulic brake fluid conforming to DOT 4 specification.

## Brake Discs, Pads, Calipers, And Rotors

Check the pads, the disc, and the rotor for any excessive wear-out. Inspect calipers for any fluid leakage.

For more information on checking the pads or lining wear limit, refer to <http://service.hyundai-motor.com>.

## Exhaust Pipe And Muffler

Visually inspect the exhaust pipes, muffler and hangers for cracks, deterioration, or damage. Start the engine and listen carefully for any exhaust gas leakage. Tighten connections or replace parts as necessary.

## Drive Shafts And Boots

Check the drive shafts, boots and clamps for cracks, deterioration, or damage. Replace any damaged parts and, if necessary, repack the grease.

## Propeller Shaft And Related

Check the propeller shaft, boots, clamps, rubber couplings, and center-bearing rubber for cracks, deterioration, or damage. Replace any damaged parts and if necessary, repack the grease.

## Suspension Mounting Bolts

Check the suspension connections for looseness or damage. Retighten to the specified torque.

## Steering Gear Box, Linkage & Boots/Lower Arm Ball Joint

With the vehicle stopped and the engine off, check for excessive free-play in the steering wheel. Check the linkage for bends or damage. Check the dust boots and ball joints for deterioration, cracks, or damage. Replace any damaged parts.

## Air Conditioning Refrigerant

Check the air conditioning lines and connections for leakage and damage.

## Engine Oil

### Checking the Engine Oil Level

Engine oil is used for lubricating, cooling, and operating various hydraulic components in the engine. Engine oil consumption while driving is normal, and it is necessary to check and refill the engine oil regularly. Also, check and refill the oil level within the recommended maintenance schedule to prevent deterioration of oil performance.

Check the engine oil following the below procedure.

1. Follow all of the oil manufacturer's precautions.
2. Make sure the vehicle is on the level ground in P (Park) with the parking brake set and the wheels blocked.
3. Turn on the engine and warm the engine up until the coolant temperature reaches a constant normal temperature.
4. Turn off the engine, remove the oil filler cap and pull the dipstick out. Wait for 15 minutes for the oil to return to the oil pan.
5. Wipe the dipstick clean and re-insert it fully.
6. Pull the dipstick out again and check the level. The level should be between F (Full) and L (Low).

2.5 T-GDI

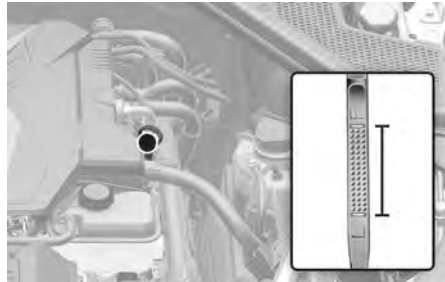

3.5 T-GDI

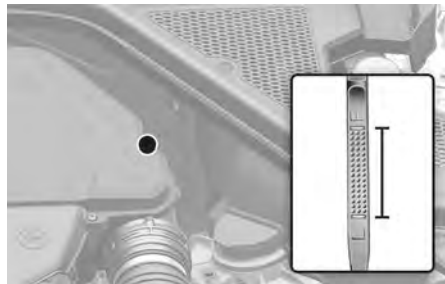

7. If the oil level is below L, add enough oil to bring the level to F.

2.5 T-GDI



3.5 T-GDI



### *i* Information

Use only the engine oil specified in the "Recommended Lubricants and Capacities" section in chapter 2.

### NOTICE

To prevent damage to your engine:

- Do not spill engine oil when adding or changing engine oil. Wipe off spilled oil immediately.
- The engine oil consumption may increase while you break in the new vehicle, and it should stabilize after driving 4,000 miles (6,000 km).
- The engine oil consumption may be affected by driving habits, climate conditions, traffic conditions, oil quality, etc. Therefore, inspect the engine oil level regularly and refill if necessary.

## Checking the Engine Oil And Filter



- The lubrication, rust prevention, cooling, and cleaning effect of the engine oil will gradually degrade during its use. Have the engine oil and filter changed by an authorized retailer of Genesis Branded products according to the Engine Oil Life Management System Instructions or the Maintenance Schedule at the beginning of this chapter.
- If the maintenance schedule to replace engine oil is exceeded, the engine oil performance may deteriorate, and the engine condition may be affected. Therefore, replace the engine oil according to the maintenance schedule.
- To keep the engine in optimal condition, use the recommended engine oil and filter. If the recommended engine oil and filter are not used, replace them according to the maintenance schedule under severe usage conditions.
- The purpose of the maintenance schedule for engine oil replacement is to prevent oil deterioration and it is irrelevant to oil consumption. Check and refill engine oil regularly.

### *i* Information

When the oil pressure is low due to insufficient engine oil, the Engine Oil Pressure (🛢️) warning light will illuminate. In addition, the enhanced engine protection system, which limits the engine's power is activated and the Malfunction (🔧) Indicator Lamp will illuminate when the vehicle is driven in this state continuously. When oil pressure is restored, the Engine Oil Pressure warning light will turn off and the engine power will no longer be limited. However, when the oil pressure is restored, the warning light and the enhanced engine protection system turns off after the engine is restarted.

### ⚠️ CAUTION

Allow the engine to cool before replacing the oil.

### ⚠️ WARNING

#### **CALIFORNIA PROPOSITION 65 WARNING**

Engine oil contains chemicals known to the State of California to cause cancer, birth defects and reproductive harm.

Used engine oil may cause irritation or cancer of the skin if left in contact with the skin for prolonged periods of time.

Always protect your skin by washing your hands thoroughly with soap and warm water as soon as possible after handling used oil.

### **NOTICE**

Never add any additives to the engine oil. Engine oil additives can change the properties of engine oil and may cause serious engine failure.

## Engine Coolant/Liquid-Cooled Intercooler Coolant

The high pressure cooling system has a reservoir filled with year-round antifreeze coolant.

Check the antifreeze protection and coolant level at least once a year, before the winter season or before traveling to a colder climate.

### Checking the Coolant Level

Engine coolant

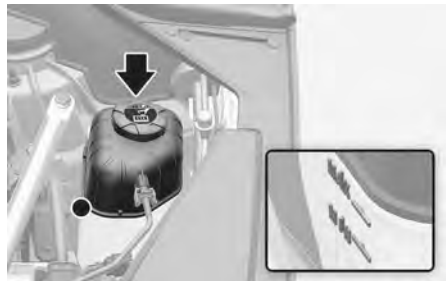

Liquid-cooled intercooler coolant



Check the condition and connections of all cooling system hoses and heater hoses. Replace any swollen or deteriorated hoses.

The coolant level should be filled between the **MAX** (Maximum) and the **MIN** (Minimum) marks on the side of the coolant reservoir when the engine is cool.

If the coolant level is low, add enough distilled (deionized) water mixed with antifreeze to bring the level to the **MAX** (Maximum) mark. If frequent additions are required, contact an authorized retailer of Genesis Branded products for a cooling system inspection.

### WARNING



Never remove the engine coolant cap and/or liquid-cooled intercooler coolant cap or the drain plug while the engine coolant cap and liquid-cooled intercooler coolant cap are hot. Hot coolant and steam may blow out under pressure, causing serious injury.

Turn the vehicle off and wait until the engine cools down. Use extreme care when removing the engine coolant cap and/or liquid-cooled intercooler coolant cap. Wrap a thick towel around it, and turn it counterclockwise slowly to the first stop. Step back while the pressure is released from the cooling system. When you are sure all the pressure has been released, press down on the cap, using a thick towel, and continue turning counterclockwise to remove it.

### *i* Information

The coolant level is influenced by the engine temperature. Before checking or refilling the coolant, turn off the engine and allow the engine to cool.

### WARNING



The electric motor for the cooling fan may continue to operate or start up when the engine is not running and can cause serious injury. Keep hands, clothing and tools away from the rotating fan blades of the cooling fan.

Always turn off the vehicle unless the vehicle has to be inspected with the engine on. The cooling fan may operate automatically if the negative (-) battery terminal is not disconnected.

### WARNING

Make sure the coolant cap is properly closed after refilling coolant. Otherwise, the engine may be overheated while driving.

1. Check if the coolant cap label is straight in front.

Engine compartment front view



2. Make sure that the tiny protrusions inside the coolant cap is securely interlocked.



### **Recommended coolant**

- When adding coolant, use only deionized water, distilled water, or soft water for your vehicle and never mix hard water in the coolant filled at the factory.
- An incorrect coolant mixture may result in severe malfunction or engine damage.
- The engine in your vehicle has aluminum engine parts and must be protected by a phosphate-based ethylene glycol coolant to prevent corrosion and freezing.
- Do not use alcohol or methanol coolant or mix them with the specified coolant.
- Do not use a solution that contains more than 60 % antifreeze or less than 35 % antifreeze, which could reduce the effectiveness of the solution.

For mixing percentage, refer to the following table:

Ambient temperature	Mixture percentage (volume)	
	Antifreeze	Water
5 °F (-15 °C)	35	65
-13 °F (-25 °C)	40	60
-31 °F (-35 °C)	50	50
-49 °F (-45 °C)	60	40

### ***i* Information**

If in doubt about the mix ratio, a 50 % water and 50 % antifreeze mix is the easiest to mix together because it is the same quantity for each. It is suitable to use for most temperature ranges of -31 °F (-35 °C) and higher.

---

### **Changing Coolant**

Have the coolant changed by an authorized retailer of Genesis Branded products according to the Maintenance Schedule at the beginning of this chapter.

### **NOTICE**

To prevent damage to engine parts, put a thick towel around the engine coolant cap and/or liquid-cooled intercooler coolant cap before refilling the coolant to prevent the coolant from overflowing into engine parts, such as the alternator.

---



## Brake Fluid

### Checking the Brake Fluid Level

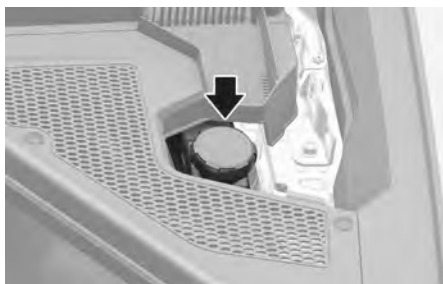

Check the fluid level in the reservoir periodically. The fluid level must be between the **MAX** (Maximum) and **MIN** (Minimum) marks on the side of the reservoir.

Before removing the reservoir cap and adding brake fluid, clean the area around the reservoir cap thoroughly to prevent brake fluid contamination.

If the level is low, add the specified brake fluid to the **MAX** level. If the fluid level is excessively low or frequent additions are required, have the brake system inspected by an authorized retailer of Genesis Branded products.

#### **WARNING**

If the brake system requires frequent additions of fluid this could indicate a leak in the brake system. Have the vehicle inspected by an authorized retailer of Genesis Branded products.

#### **WARNING**

If brake fluid gets in your eyes, flush your eyes with clean water for at least 15 minutes and get immediate medical attention.

#### **NOTICE**

- Do not allow brake fluid to contact the vehicle's body paint, because paint damage may occur.
- Never use brake fluid that has been exposed to open air for an extended time and dispose of it properly.
- Do not use a wrong type of brake fluid. A few drops of mineral based oil such as engine oil in your brake system may damage the brake system parts.

#### **Information**

Use only the brake fluid specified in the "Recommended Lubricants and Capacities" section in chapter 2.

## Washer Fluid

### Checking the Washer Fluid Level

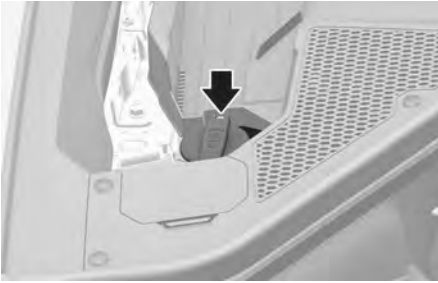

Check the fluid level in the washer fluid reservoir and add fluid if necessary. Plain water can be used if washer fluid is not available. However, use washer fluid with antifreeze in cold climates to prevent freezing.

#### **WARNING**

To prevent serious injury or death:

- Do not use engine coolant or antifreeze in the washer fluid reservoir. Engine coolant can severely limit your visibility when sprayed on the windshield and may cause loss of vehicle control resulting in a collision.
- Do not allow sparks or flame to contact the washer fluid or the washer fluid reservoir. Washer fluid may contain alcohol and can be flammable.
- Do not drink washer fluid and avoid contact with skin.
- Keep washer fluid away from children and animals.

## Air Cleaner

### Filter Replacement

#### *2.5 T-GDI*

The air cleaner filter can be cleaned for inspection using compressed air. Do not attempt to wash or rinse it, because water can damage the filter. If soiled, replace the air cleaner filter.

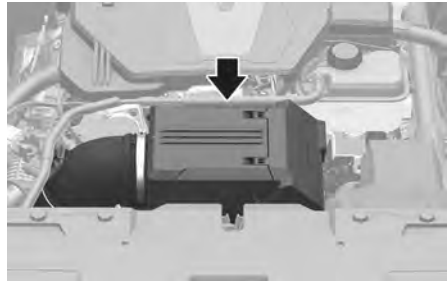

1. Pull up the air cleaner cover.

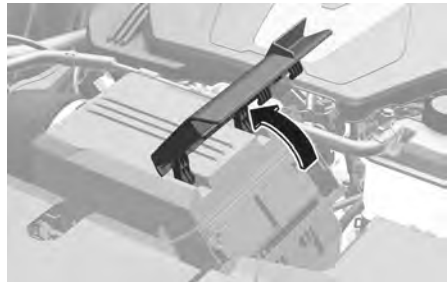

2. Pull down the lever to the UNLOCK position.

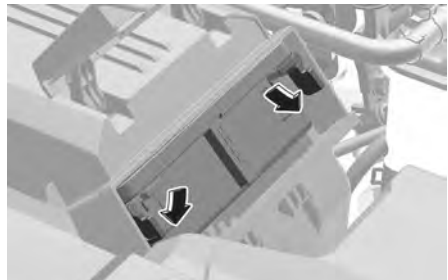

### 3. Replace the air cleaner filter.



### 4. Reassemble the air cleaner filter cover in the reverse order.

- Check that the cover is firmly installed.

#### **NOTICE**

- Do not drive with the air cleaner filter removed. This may result in excessive engine wear.
- When removing the air cleaner filter, be careful that dust or dirt does not enter the air intake. It may cause damage.
- Use Genesis genuine parts for replacement from an authorized retailer of Genesis Branded products. Use of non-genuine parts may damage the air flow sensor.

### 3.5 T-GDI

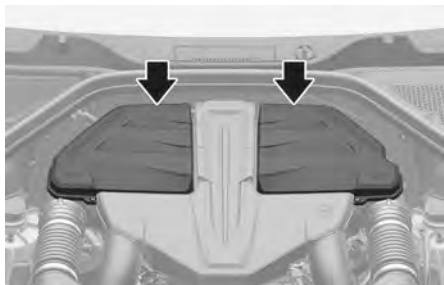

Do not attempt to wash or rinse it, because water can damage the filter. If soiled, the air cleaner filter must be replaced. Visit an authorized retailer of Genesis Branded products to replace air cleaner filter. Replace the air cleaner filter according to the Maintenance Schedule.

#### **i Information**

If the vehicle is operated in extremely dusty or sandy areas, replace the air cleaner filter more often than the usual recommended intervals (Refer to the "Maintenance Under Severe Usage Conditions" section in this chapter).

## Cabin Air Filter

### Filter Inspection

The cabin air filter must be replaced according to the Maintenance Schedule. If the vehicle operates in severely air-polluted cities or on dusty rough roads for a long time, have it inspected more frequently and replaced immediately. Replace the cabin air filter by following the procedure below and be careful to avoid damaging other components.

### Filter Replacement

1. Open the glove box and remove the support rod (1).



2. Remove the stoppers on both sides to allow the glove box to hang open.



3. Press and hold the lock on the left side of the cover.

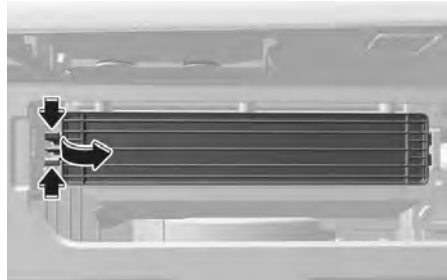

4. Pull out the cover.
5. Replace the cabin air filter.
6. Reassemble in the reverse order of disassembly.

### Engine compartment

1. Open the engine hood.
2. Use a + screwdriver to remove the screws mounted on the air filter cover.

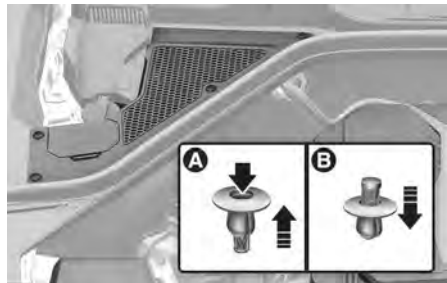

- [A] Screw removal  
[B] Screw mounting

- Press and hold the lock on the left side of the cover.



- Pull out the cover.
- Replace the cabin air filter.
- Reassemble in the reverse order of disassembly.

### NOTICE

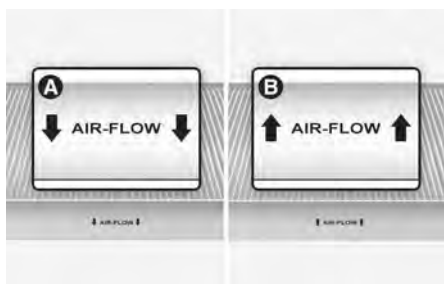

- [A] Glove box  
[B] Engine compartment

Install a new cabin air filter with the arrow symbol in the correct direction to improve effectiveness.

- Glove box: Install with the arrow symbol facing downward (↓).
- Engine Compartment: Install with the arrow symbol facing up (↑).

## Wiper Blades

### Blade Inspection

Contamination of either the windshield or the wiper blades with foreign substances may reduce the effectiveness of the windshield wipers.

Common sources of contamination are insects, tree sap, and hot wax treatments used by some commercial car washes. If the blades are not wiping properly, clean both the window and the blades with glass cleaner or mild detergent, and rinse thoroughly with clean water.

### NOTICE

To prevent damage to the wiper blades, arms, or other components, do not:

- Use gasoline, kerosene, paint thinner, or other solvents on or near them.
- Attempt to move the wipers manually.

### Blade Replacement

When the wipers no longer clean adequately, the blades may be worn or cracked. Replace the wipers with new ones.

### NOTICE

To prevent damage:

- Never use non-specified wiper blades.
- Lift the wiper arms when in the top wiping position.
- Always return the wiper arms to the windshield before driving.

### Front windshield wiper blade

This vehicle has a “hidden” wiper design that cannot be lifted when in their bottom resting position.

1. Within 20 seconds of turning off the engine, push and hold the wiper lever down to the MIST (1x) position for about 2 seconds until the wipers move to the top wipe position.

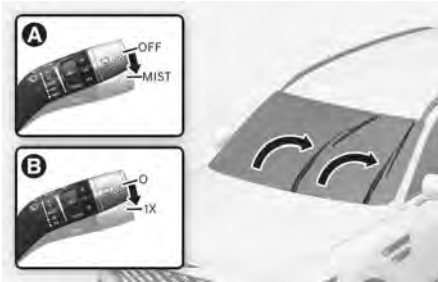

2. Lift the wipers off the windshield.
3. Lift up the wiper blade clip (1).



4. Then pull down the wiper blade (2).



5. Remove the wiper blade from the wiper arm.

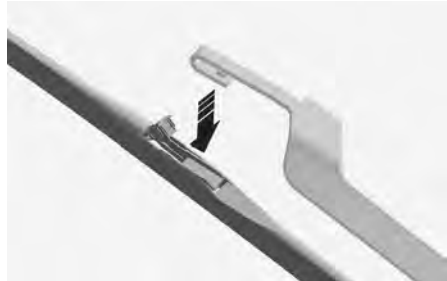

6. Install the new wiper blade assembly in the reverse order of removal.
7. Gently put down the wiper back onto the windshield.
8. Turn the wipers to any ON position to return the wiper arms to the bottom resting position.

### Rear window wiper blade replacement

**+** if equipped

1. Raise the wiper arm.
2. Rotate the wiper blade assembly (1) and then pull out the wiper blade assembly (2).

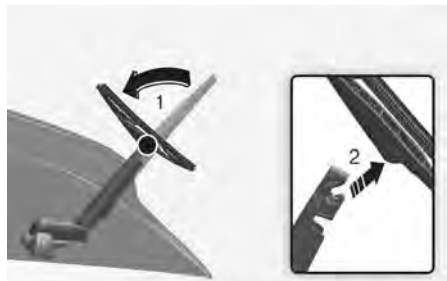

3. Install the new blade assembly by inserting the center part into the slot in the wiper arm until it clicks into place (3).

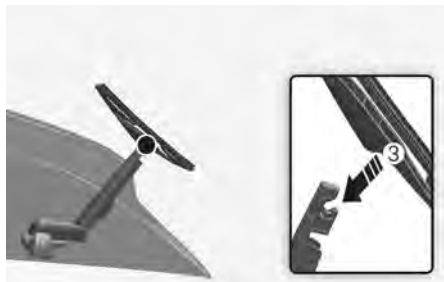

4. Rotate back the blade assembly so that it aligns with the wiper arm.
5. Gently put down the wiper back onto the rear windshield, and turn the vehicle ignition ON and operate the wipers to check the blade is installed correctly.

### NOTICE

- Avoid the wipers from touching the windshield when the wiper blade is disassembled to prevent windshield damage.
- The rear wiper may not operate for about 10 seconds if the wiper is operated without washer fluid or the blades are frozen to prevent damage to the motor.

### *i* Information

To prevent damage to the wiper arms or other components, have the wiper blades replaced by an authorized retailer of Genesis Branded products.

## Battery

### ⚠ WARNING

To prevent serious injury or death to you or bystanders when working near or handling the battery:

Always read and follow instructions carefully when handling a battery.



Wear eye protection designed to protect the eyes from acid splashes.



Keep all flames, sparks, or smoking materials away from the battery.



Hydrogen gas is always present in battery cells. It is highly combustible, and may explode if ignited.



Keep batteries out of reach of children.



Batteries contain sulfuric acid that is highly corrosive. Do not allow acid to contact your eyes, skin or clothing.

If acid gets into your eyes, flush your eyes with clean water for at least 15 minutes and get immediate medical attention. If acid gets on your skin, thoroughly wash the area. If you feel pain or a burning sensation, get medical attention immediately.



- Lift a battery with a battery carrier or with your hands on opposite corners. When lifting a plastic-cased battery, excessive pressure on the case may cause battery acid to leak.
  - Do not attempt to jump start your vehicle if your battery is frozen.
  - Never attempt to recharge the battery when the vehicle's battery cables are connected to the battery.
  - The electrical ignition system works with high voltage. Never touch these components with the engine running or when the Engine Start/Stop button is in the ON position.
- 

### **WARNING**

#### **CALIFORNIA PROPOSITION 65 WARNING**

Battery posts, terminals, and related accessories contain lead and lead compounds, chemicals known to the State of California to cause cancer, birth defects and reproductive harm. Batteries also contain other chemicals known to the State of California to cause cancer. Wash hands after handling.

---

### **NOTICE**

To prevent battery damage:

- Always fully charge the battery and store indoors when you do not plan to use the vehicle for a long time if the outside temperature is low enough to cause the battery to freeze.
  - Always fully charge the battery to prevent battery case damage in low temperature areas.
  - Prevent liquid from wetting the battery terminals.
  - Do not tilt the battery.
  - Never connect unauthorized devices to the battery.
- 

## For Best Battery Service

### *12 V battery*



- Keep the battery securely mounted.
- Keep the battery top clean and dry.
- Keep the terminals and connections clean, tight, and coated with petroleum jelly or terminal grease.
- Rinse any spilled electrolyte from the battery immediately with a solution of water and baking soda.
- If the vehicle is not going to be used for an extended period of time, disconnect the battery cables.



**i Information**

Open the battery cover to check the batteries.

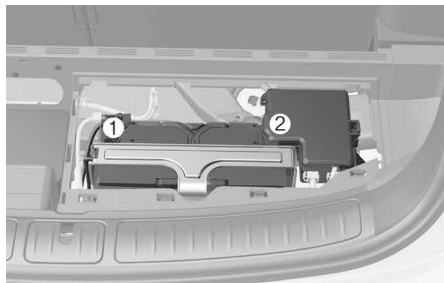
**Battery Replacement****12 V battery**

When replacing the battery, disconnect the negative (-) cable (1) and remove the positive (+) battery fuse box (2).

**i Information**

To check the batteries, open the cover. The clips must be removed first to open the cover.

**48 V battery**

**+** if equipped

Mild hybrid vehicles have a 48 V battery installed under the cargo area. Have the 48 V battery replaced by an authorized retailer of Genesis Branded products.

**⚠ WARNING**

Inspections or repairs related to the 48 V battery must be performed by an authorized retailer of Genesis Branded products.

**12 V lithium auxiliary battery**

When there is a problem with the 12 V lithium auxiliary battery, such as the temperature or charge amount being too high, the warning message "**Check the battery**" may appear on the cluster display.

If you have signed up for Genesis Connected Services, a text message is sent to your mobile phone. If the warning message appears on the cluster display or a text message is sent to your mobile phone, have your vehicle inspected by an authorized retailer of Genesis Branded products.

**i Information**

The 12 V lithium auxiliary battery is installed to provide power for electrical functions such as OTA software update, air conditioning auto-drying, etc. when the vehicle is parked.

## Battery Capacity Label

Type A



Type B



The actual battery label in the vehicle may differ from the illustration.

- (1) The Genesis Branded Vehicle model name of battery
- (2) The nominal voltage
- (3) The nominal capacity (in Ampere hours)
- (4) The nominal reserve capacity (in min.)
- (5) The cold-test current in amperes by SAE / EN

## Battery Recharging

### By battery charger

Your vehicle has a maintenance-free, calcium-based battery.

- If the battery becomes discharged over a short time (because, for example, the headlamps or interior lights are left on while the vehicle is not used), recharge it by slow charging (trickle) for 10 hours.
- If the battery gradually discharges because of high electrical load while the vehicle is being used, recharge it at 20-30 A for two hours.

### **⚠ WARNING**

To prevent the risk of serious injury or death from explosions or acid burns:

- Before performing maintenance or recharging the battery, turn off all accessories and stop the engine.
- Keep all flames, sparks, or smoking materials away from the battery.
- Always work outdoors or in an area with plenty of ventilation.
- Wear eye protection when checking the battery during charging. Do not contact the battery. This may result in serious injury.
- Remove the battery from the vehicle and place it in a well ventilated area.
- Watch the battery during charging, and stop or reduce the charging rate if the battery cells begin boiling violently.
- Remove the negative battery cable first and install it last when the battery is disconnected. Disconnect the battery charger in the following order:
  1. Turn off the battery charger main switch.
  2. Unhook the negative clamp from the negative battery terminal.
  3. Unhook the positive clamp from the positive battery terminal.

**NOTICE**

AGM battery (if equipped)

Absorbent Glass Mat (AGM) batteries are maintenance-free and should be serviced by an authorized retailer of Genesis Branded products. Only charge using fully automatic battery chargers that are specifically for AGM batteries.

**⚠ CAUTION**

Do not open or remove the cap on top of the battery. This may cause leaks of internal electrolyte that could result in serious injury.

***By jump starting***

After a jump start from a good battery, drive the vehicle for 30 minutes or operate at idle for at least 60 minutes before it is shut off. The vehicle may not restart if you shut it off before the battery had a chance to adequately recharge. Refer to the "Jump Starting" section in chapter 8 for more information on jump starting procedures.

***i* Information**

An inappropriately disposed battery may be harmful to the environment and human health. Always dispose used batteries in accordance with local law(s) or regulations.

**Reset Items**

The following items may need to be reset after the battery has been discharged or disconnected:

- Current trip/Since refueling/Since last reset (items in Normal view) (refer to chapter 4)
- Integrated Memory System (refer to chapter 5)
- Power Windows (refer to chapter 5)
- Panoramic Sunroof (refer to chapter 5)
- Power Liftgate (refer to chapter 5)
- Automatic Climate Control System (refer to chapter 5)
- Rear Side Window Sunshades (refer to chapter 5)
- Clock (refer to the Infotainment system manual)
- Infotainment System (refer to the Infotainment system manual)

## Tires and Wheels

### **WARNING**

Tire failure may cause loss of vehicle control and result in a collision. To reduce risk of serious injury or death:

- Inspect your tires monthly for proper inflation as well as wear and damage.
- The recommended cold tire pressure for your vehicle can be found in this manual and on the tire label located on the driver's side center pillar. Always use a tire pressure gauge to measure tire pressure. Tires with too much or too little pressure wear unevenly causing poor handling.
- Check the pressure of the spare every time you check the pressure of the other tires on your vehicle.
- Replace tires that are worn, show uneven wear, or are damaged. Worn tires may cause loss of braking effectiveness, steering control, or traction.
- Always replace tires with the same size, type, construction, and tread pattern as each tire that was originally supplied with this vehicle. Using tires and wheels other than the recommended sizes may cause unusual handling characteristics, poor vehicle control, or negatively affect your vehicle's Anti-Lock Brake System (ABS).

## Tire Care

For proper maintenance, safety, and maximum fuel economy, always maintain the recommended tire inflation pressures and stay within the load limits and weight distribution recommended for your vehicle.



All specifications (sizes and pressures) can be found on a label attached to the driver's side center pillar.

## Recommended Cold Tire Inflation Pressures

Check all tire pressures (including the spare) when the tires are cold. "Cold tires" mean the vehicle has not been driven for at least three hours or driven less than one mile (1.6 km).

Warm tires normally exceed the recommended cold tire pressures by 4 to 6 psi (28 to 41 kPa). Do not release air from warm tires to adjust the pressure. The tires are under-inflated. For the recommended inflation pressure, refer to the "Tires and Wheels" section in chapter 2.

**⚠ WARNING**

- Recommended pressures must be maintained for the best ride, vehicle handling, and minimum tire wear.
  - Over-inflation or under-inflation can reduce tire life, adversely affect vehicle handling, and lead to sudden tire failure that may result in loss of vehicle control resulting in a collision.
  - Severe under-inflation may lead to severe heat build-up, causing blowouts, tread separation, and other tire failures that result in the loss of vehicle control resulting in a collision. This risk is much higher on hot days and when driving for long periods at high speeds.
  - Under-inflation may cause excessive wear, poor handling, and reduced fuel economy. Wheel deformation is also possible. Keep your tire pressures at the proper levels. If a tire frequently needs refilling, have it inspected by an authorized retailer of Genesis Branded products.
  - Over-inflation produces a harsh ride, excessive wear at the center of the tire tread, and a greater possibility of damage from road hazards.
- 

**Check Tire Inflation Pressure**

Check your tires, including the spare tire (if equipped), at least once a month or more.

***How to check***

Use a good quality tire pressure gauge to check the tire pressure. You cannot tell if your tires are properly inflated simply by looking at them. Radial tires may look properly inflated when they are under-inflated.

Remove the valve cap from the tire valve stem. Press the tire gauge firmly onto the valve to get a pressure measurement. If the cold tire inflation pressure matches the recommended pressure on the tire and loading information label, no further adjustment is necessary. If the pressure is low, add air until it reaches the recommended pressure. Make sure to put the valve caps back on the valve stems. Without the valve cap, dirt or moisture could get into the valve core and cause air leakage. If a valve cap is missing, install a new one as soon as possible.

If you overfill the tire, release air by pushing on the metal stem in the center of the tire valve. Recheck the tire pressure with the tire gauge. Be sure to put the valve caps back on the valve stems. Without the valve cap, dirt or moisture may get into the valve core and cause air leakage. If a valve cap is missing, install a new one as soon as possible.

## Tire Rotation

To equalize tread wear, Genesis Branded Vehicle recommends that the tires be rotated according to the maintenance schedule or sooner if irregular wear develops.

During rotation, check the tires for correct balance.

When rotating tires, check for uneven wear and damage. Abnormal wear is usually caused by incorrect tire pressure, improper wheel alignment, out-of-balance wheels, severe braking, or severe cornering. Look for bumps or bulges in the tread or side of the tire. Replace the tire if you find any of these conditions. Replace the tire if fabric or cord is visible. After rotation, be sure to bring the front and rear tire pressures to specification and check wheel bolt torque (proper torque is 101-116 lbf-ft [14-16 kgf·m]).

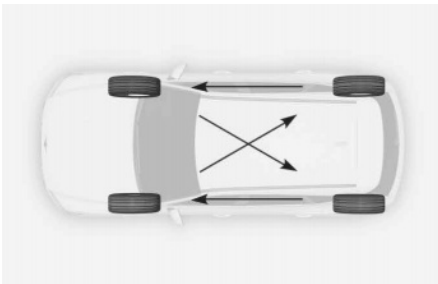

Disc brake pads should be inspected for wear whenever tires are rotated.

### *i* Information

When installing an unsymmetrical tire, install the side marked “outside” facing out.

---

### WARNING

- Do not use the compact spare tire for tire rotation.
  - Do not mix bias ply and radial ply tires under any circumstances. This may cause unusual handling characteristics that may cause loss of vehicle control and result in a collision.
- 

## Wheel Alignment and Tire Balance

The wheels on your vehicle were aligned and balanced carefully at the factory and you may not need to have your wheels aligned again. If you notice unusual tire wear or your vehicle pulling to one side, the alignment may need to be adjusted.

If you notice your vehicle vibrating when driving on a smooth road, your wheels may need to be rebalanced.

### NOTICE

Only use approved wheel weights or your vehicle’s aluminum wheels may be damaged.

---

## Tire Replacement



### [A]Tread wear Indicator

If the tire is worn evenly, a tread wear indicator appears as a solid band across the tread. This shows there is less than 1/16 in. (1.6 mm) of tread left on the tire. Replace the tire when this happens.

Do not wait for the band to appear across the entire tread before replacing the tire.

### WARNING

To reduce the risk of serious injury or death:

- Replace tires that are worn, show uneven wear, or are damaged. Worn tires may cause loss of braking effectiveness, steering control, and traction.
- Always replace tires with the same size as each tire that was originally supplied with this vehicle. Using tires and wheels other than the recommended sizes may cause unusual handling characteristics, poor vehicle control, or negatively affect your vehicle's Anti-Lock Brake System (ABS).

- When replacing tires (or wheels), it is recommended to replace the two front or two rear tires (or wheels) as a pair. Replacing just one tire may seriously affect your vehicle's handling.
- Tires degrade over time, even when they are not being used. Regardless of the remaining tread, Genesis Branded Vehicle recommends that tires be replaced after six (6) years.
- Driving in hot climates or excessive loading may accelerate the tire aging process.

### *Compact spare tire replacement*

 if equipped

A compact spare tire has a shorter tread life than a regular size tire. Replace it when you can see the tread wear indicator bars on the tire. The replacement compact spare tire should be the same size and design tire as the one provided with your new vehicle and should be mounted on the same compact spare tire wheel. The compact spare tire is not designed to be mounted on a regular size wheel, and the compact spare tire wheel is not designed for mounting a regular size tire.

### WARNING

The original size tire should be repaired or replaced as soon as possible to avoid failure of the spare and loss of vehicle control resulting in a collision. The compact spare tire is for emergency use only. Do not operate your vehicle over 50 mph (80 km/h) when using the compact spare tire.

## Wheel Replacement

When replacing the metal wheels for any reason, make sure the new wheels are equivalent to the original factory units in diameter, rim width, and offset.

## Tire Traction

Tire traction can be reduced if you drive on worn tires or the tires that are improperly inflated, or on slippery road surfaces. Replace the tires when tread wear indicators appear. To reduce the possibility of losing control, slow down whenever there is rain, snow, or ice on the road.

## Tire Maintenance

In addition to proper inflation, correct wheel alignment helps decrease tire wear. If you find a tire is worn unevenly, have your dealer check the wheel alignment.

When you have new tires installed, make sure they are balanced. This may increase ride comfort and tire life. Additionally, a tire must always be rebalanced if it is removed from the wheel.

## Tire Sidewall Labeling

This information identifies and describes the fundamental characteristics of the tire and also provides the tire identification number (TIN) for safety standard certification. The TIN can be used to identify the tire in case of a recall.

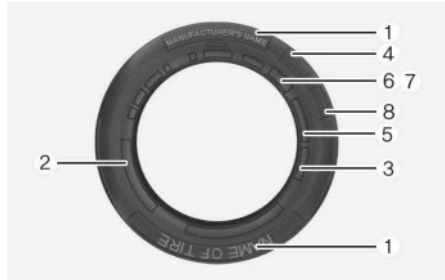

### **1. Manufacturer or brand name**

Manufacturer or brand name is shown.

### **2. Tire size designation**

A tire's sidewall is marked with a tire size designation. You need this information when selecting replacement tires for your vehicle. The following explains what the letters and numbers in the tire size designation mean.

Example tire size designation:

(These numbers are provided as an example only. Your tire size designator may vary depending on your vehicle.)

### **265/55R19 109Y**

265 - Tire width in millimeters.

55 - Aspect ratio. The tire's section height as a percentage of its width.

R - Tire construction code (Radial).

19 - Rim diameter in inches.



109 - Load Index, a numerical code associated with the maximum load the tire can carry.

Y - Speed Rating Symbol. See the speed rating chart in this section for additional information.

### Wheel size designation

Wheels are also marked with important information that you need if you ever have to replace one.

Example wheel size designation:

#### 8.5J X 19

8.5 - Rim width in inches.

J - Rim contour designation.

19 - Rim diameter in inches.

### Tire speed ratings

The chart below lists many different speed ratings currently being used for passenger vehicle tires. The speed rating is part of the tire size designation on the sidewall of the tire. This symbol corresponds to that tire's designed maximum safe operating speed.

Speed rating symbol	Maximum speed
S	112 mph (180 km/h)
T	118 mph (190 km/h)
H	130 mph (210 km/h)
V	149 mph (240 km/h)
W	168 mph (270 km/h)
Y	186 mph (300 km/h)

### 3. Checking tire life (TIN: Tire Identification Number)

Any tires that are over six years old, based on the manufacturing date, (including the spare tire) should be replaced by new ones. You can find the manufacturing date on the tire sidewall (possibly on the inside of the wheel), displaying the DOT Code. The DOT Code is a series of numbers on a tire consisting of numbers and English letters. The manufacturing date is designated by the last four digits (characters) of the DOT code.

#### DOT: XXXX XXXX 0000

The front part of the DOT shows a plant code number, tire size, and tread pattern and the last four numbers indicate week and year manufactured.

For example:

DOT XXXX XXXX 1524 represents that the tire was produced in the 15th week of 2024.

### 4. Genesis exclusive tire

Genesis Branded Vehicle recommends that tires designed specifically for Genesis vehicles be used. You may find the marking "GOE" (Genesis Original Equipment) embossed on the tire sidewall.

### **5. Tire ply composition and material**

The number of layers or plies of rubber-coated fabric in the tire. Tire manufacturers also must indicate the materials in the tire, which include steel, nylon, polyester, and others. The letter "R" means radial ply construction; the letter "D" means diagonal or bias ply construction. The letter "B" means belted-bias ply construction.

### **6. Maximum permissible inflation pressure**

This number is the greatest amount of air pressure that should be put in the tire. Do not exceed the maximum permissible inflation pressure. Refer to the Tire and Loading Information label for recommended inflation pressure.

### **7. Maximum load rating**

This number indicates the maximum load in kilograms and pounds that can be carried by the tire. When replacing the tires on the vehicle, always use a tire that has the same load rating as the factory installed tire.

### **8. Uniform tire quality grading**

Quality grades can be found where applicable on the tire sidewall between tread shoulder and maximum section width.

For example:

TREADWEAR 200

TRACTION AA

TEMPERATURE A

### **Tread wear**

The tread wear grade is a comparative rating based on the wear rate of the tire when tested under controlled conditions on a specified government test course. For example, a tire graded 150 would wear one-and-a-half times (1½) as well on the government course as a tire graded 100.

The relative performance of tires depends upon the actual conditions of their use, however, and may depart significantly from the norm due to variations in driving habits, service practices, and differences in road characteristics and climate.

These grades are molded on the sidewalls of passenger vehicle tires. The tires available as standard or optional equipment on your vehicle may vary depending on the grade.

### **Traction - AA, A, B & C**

The traction grades, from highest to lowest, are AA, A, B, and C. Those grades represent the tire's ability to stop on wet pavement as measured under controlled conditions on specified government test surfaces of asphalt and concrete. A tire marked C may have poor traction performance.

### **WARNING**

The traction grade assigned to this tire is based on straight ahead braking traction tests, and does not include acceleration, cornering, hydroplaning, or peak traction characteristics.

---

### Temperature - A, B & C

The temperature grades are A (the highest), B, and C representing the tire's resistance to the generation of heat and its ability to dissipate heat when tested under controlled conditions on a specified indoor laboratory test wheel.

Sustained high temperature may cause the material of the tire to degenerate and reduce tire life, and excessive temperature may lead to sudden tire failure. Grades B and A represent higher levels of performance on the laboratory test wheel than the minimum required by law.

#### **WARNING**

The temperature grade for this tire is established for a tire that is properly inflated and not overloaded.

Excessive speed, under-inflation, over-inflation, or excessive loading, either separately or in combination, may cause heat build-up and possible sudden tire failure.

## Tire Terminology and Definitions

### *Air pressure*

The amount of air inside the tire pressing outward on the tire. Air pressure is expressed in pounds per square inch (psi) or kilopascal (kPa).

### *Accessory weight*

This means the combined weight of optional accessories. Some examples of optional accessories are automatic transmission, power seats, and air conditioning.

### *Aspect ratio*

The relationship of a tire's height to its width.

### *Belt*

A rubber coated layer of cords that is located between the plies and the tread. Cords may be made from steel or other reinforcing materials.

### *Bead*

The tire bead contains steel wires wrapped by steel cords that hold the tire onto the rim.

### *Bias ply tire*

A pneumatic tire in which the plies are laid at alternate angles less than 90 degrees to the centerline of the tread.

### *Cold tire pressure*

The amount of air pressure in a tire, measured in pounds per square inch (psi) or kilopascals (kPa) before a tire has built up heat from driving.

### *Curb weight*

This means the weight of a motor vehicle with standard and optional equipment including the maximum capacity of fuel, oil and coolant, but without passengers and cargo.

***DOT markings***

A code molded into the sidewall of a tire signifying that the tire is in compliance with the U.S. Department of Transportation motor vehicle safety standards. The DOT code includes the Tire Identification Number (TIN), an alphanumeric designator which can also identify the tire manufacturer, production plant, brand and date of production.

***GVWR***

Gross Vehicle Weight Rating

***GAWR FRT***

Gross Axle Weight Rating for the Front Axle.

***GAWR RR***

Gross Axle Weight Rating for the Rear axle.

***Intended outboard sidewall***

The side of an asymmetrical tire, that must always face outward when mounted on a vehicle.

***Kilopascal (kPa)***

The metric unit for air pressure.

***Light Truck (LT) tire***

A tire designated by its manufacturer as primarily intended for use on lightweight trucks or multipurpose passenger vehicles.

***Load ratings***

The maximum load that a tire is rated to carry for a given inflation pressure.

***Load index***

An assigned number ranging from 1 to 279 that corresponds to the load carrying capacity of a tire.

***Maximum inflation pressure***

The maximum air pressure to which a cold tire may be inflated. The maximum air pressure is molded onto the sidewall.

***Maximum load rating***

The load rating for a tire at the maximum permissible inflation pressure for that tire.

***Maximum loaded vehicle weight***

The sum of curb weight; accessory weight; vehicle capacity weight; and production options weight.

***Normal occupant weight***

The number of occupants a vehicle is designed to seat multiplied by 150 lbs. (68 kg).

***Occupant distribution***

Designated seating positions.

***Outward facing sidewall***

An asymmetrical tire has a particular side that faces outward when mounted on a vehicle. The outward facing sidewall bears white lettering or bears manufacturer, brand, and/or model name molding that is higher or deeper than the same moldings on the inner facing sidewall.

***Passenger (P-Metric) tire***

A tire used on passenger cars and some light duty trucks and multipurpose vehicles.

***Ply***

A layer of rubber-coated parallel cords.

***Pneumatic tire***

A mechanical device made of rubber, chemicals, fabric and steel or other materials, that, when mounted on an automotive wheel provides the traction and contains the gas or fluid that sustains the load.

***Pneumatic options weight***

The combined weight of installed regular production options weighing over 5 lbs. (2.3 kg) in excess of the standard items which they replace, not previously considered in curb weight or accessory weight, including heavy duty breaks, ride levelers, roof rack, heavy duty battery, and special trim.

***Recommended inflation pressure***

Vehicle manufacturer's recommended tire inflation pressure as shown on the tire placard.

***Radial ply tire***

A pneumatic tire in which the ply cords that extend to the beads are laid at 90 degrees to the centerline of the tread.

***Rim***

A metal support for a tire and upon which the tire beads are seated.

***Sidewall***

The portion of a tire between the tread and the bead.

***Speed rating***

An alphanumeric code assigned to a tire indicating the maximum speed at which a tire can operate.

***Traction***

The friction between the tire and the road surface. The amount of grip provided.

***Tread***

The portion of a tire that comes into contact with the road.

***Treadwear indicators***

Narrow bands, sometimes called "wear bars", that show across the tread of a tire when only 1/16 inches of tread remains.

***UTQGS***

Uniform Tire Quality Grading Standards is a tire information system that provides consumers with ratings for a tire's traction, temperature and treadwear. Ratings are determined by tire manufacturers using government testing procedures. The ratings are molded into the sidewall of the tire.

***Vehicle capacity weight***

The number of designated seating positions multiplied by 150 lbs. (68 kg) plus the rated cargo and luggage load.

### **Vehicle maximum load on the tire**

Load on an individual tire due to curb and accessory weight plus maximum occupant and cargo weight.

### **Vehicle normal load on the tire**

Load on an individual tire that is determined by distributing to each axle its share of the curb weight, accessory weight, and normal occupant weight and dividing by 2.

### **Vehicle placard**

A label permanently attached to a vehicle showing the original equipment tire size and recommended inflation pressure.

## **Low Aspect Ratio Tires**

 if equipped

The aspect ratio is lower than 50 on low aspect ratio tires.

Because low aspect ratio tires are optimized for handling and braking, their sidewall is a little stiffer than a standard tire. Also, low aspect ratio tires tend to be wider and consequently have increased contact with the road surface. In some instances, low aspect ratio tires may generate more road noise compared with standard tires.

## **CAUTION**

Low aspect wheels and tires are easily damaged. To reduce the risk of damage:

- When driving on rough roads, passing over a pothole, speed bump, manhole, or curb stone, drive the vehicle slowly not to damage the tires and wheels. Damage is not covered by your vehicle warranty.
- Inspect the tire condition and pressure every 1,800 miles (3,000 km).
- It is difficult to visually inspect for tire damage with your eyes. If any damage is found, contact an authorized retailer of Genesis Branded products.

---

## **All Season Tires**

 if equipped

Genesis Branded Vehicle specifies all season tires on some models to provide good performance for use all year round, including snowy and icy road conditions. All season tires are identified by ALL SEASON and/or M+S (Mud and Snow) on the tire sidewall. Snow tires have better snow traction than all season tires and may be more appropriate in some areas.

## Summer Tires

 if equipped

Genesis Branded Vehicle specifies summer tires on some models to provide superior performance on dry roads. Summer tire performance is substantially reduced in snow and ice. Summer tires do not have the tire traction rating M+S (Mud and Snow) on the tire side wall. If you plan to operate your vehicle in snowy or icy conditions, Genesis Branded Vehicle recommends the use of snow tires or all season tires on all four wheels.

## Snow Tires

If you equip your car with snow tires, they should be the same size and have the same load capacity as the original tires. Snow tires should be installed on all four wheels; otherwise, poor handling may result. Snow tires should carry 4 psi (28 kPa) more air pressure than the pressure recommended for the standard tires on the tire label on the driver's side of the center pillar, or up to the maximum pressure shown on the tire sidewall, whichever is less. Do not drive faster than 75 mph (120 km/h) when your vehicle is equipped with snow tires.

## Radial-Ply Tires

Radial-ply tires provide improved tread life, road hazard resistance and smoother high speed ride. The radial-ply tires used on this vehicle are of belted construction, and are selected to complement the ride and handling characteristics of your vehicle. Radial-ply tires have the same load carrying capacity, as bias-ply or bias belted tires of the same size, and use the same recommended inflation pressure. Mixing of radial-ply tires with bias-ply or bias belted tires is not recommended. Any combinations of radial-ply and bias-ply or bias belted tires when used on the same vehicle will seriously deteriorate vehicle handling. The best rule to follow is: Identical pairs of radial-ply tires should always be used as a set for the front tires and a set for the rear tires.

Longer wearing tires can be more susceptible to irregular tread wear. It is very important to follow the tire rotation interval in this chapter to achieve the tread life potential of these tires. Cuts and punctures in radial-ply tires are repairable only in the tread area, because of sidewall flexing. Consult your tire dealer for radial-ply tire repairs.

### WARNING

Do not mix bias ply and radial ply tires under any circumstances. This may cause unusual handling characteristics that may cause loss of vehicle control resulting in an accident.

## Fuses

Blade type



Cartridge type

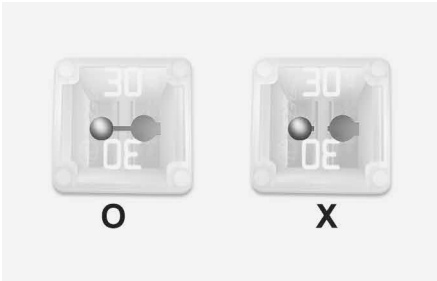

Multi type

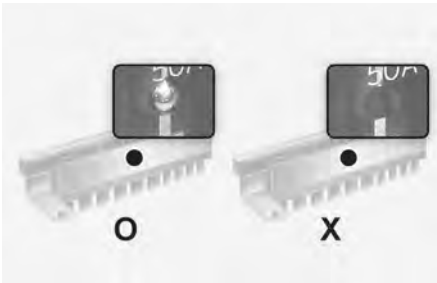

Midi type

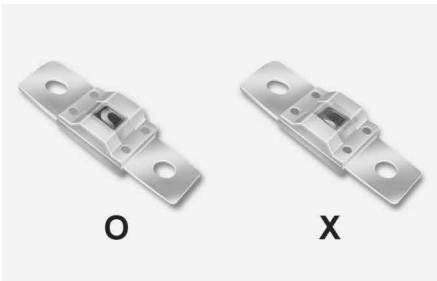

A vehicle's electrical system is protected from electrical overload damage by fuses.

This vehicle has 5 fuse panels, one located in the driver's side panel bolster and the others in the engine compartment and cargo area.

If any of your vehicle's lights, accessories, or controls do not work, check the appropriate circuit fuse. If a fuse has blown, the element inside the fuse is melted or broken.

If the electrical system does not work, first check the driver's side fuse panel. Before replacing a blown fuse, turn off the engine and all switches, and then disconnect the negative battery cable. Always replace a blown fuse with one of the same rating.

If the replacement fuse blows, this indicates an electrical problem. Avoid using the system involved and contact an authorized retailer of Genesis Branded products.

### **WARNING**

Never replace a fuse with anything but another fuse of the same rating.

- A higher capacity fuse may cause damage and possibly cause a fire.
- Do not install a wire or aluminum foil instead of the proper fuse - even as a temporary repair. It may cause extensive wiring damage and possibly a fire.

### **NOTICE**

Do not use a screwdriver or any other metal object to remove fuses because it may cause a short circuit and damage the system.



## Instrument Panel Fuse Replacement

Driver's side



Cargo area



1. Turn off the vehicle.
2. Turn off all other switches.
3. Open the fuse panel cover.
4. Refer to the label on the inside of the fuse panel cover to locate the suspected fuse location.
5. Pull the suspected fuse straight out. Use the removal tool (1) provided in the engine compartment fuse panel cover.



6. Check the removed fuse and replace it if it is blown. Spare fuses are provided in the instrument panel fuse panels (or in the engine compartment fuse panel).
7. Push in a new fuse of the same rating, and make sure it fits tightly in the clips. If it is not tight, contact an authorized retailer of Genesis Branded products.

In an emergency, if you do not have a spare fuse, use a fuse of the same rating from a circuit you may not need for operating the vehicle.

If the headlamps or other electrical components do not work and the fuses are undamaged, check the fuse panel in the engine compartment.

## Engine Compartment Panel Fuse Replacement

### Blade fuse/Cartridge fuse

Blade type fuse



Cartridge type fuse



1. Turn off the vehicle.
2. Turn off all other switches.
3. Remove the fuse panel cover by pressing the tap and pulling up.
4. Refer to the label on the inside of the fuse panel cover to locate the suspected fuse location.
5. Pull the suspected fuse straight out. Use the removal tool provided in the engine compartment fuse panel cover.
6. Check the removed fuse and replace it if it is blown. To remove or insert the fuse, use the removal tool in the engine compartment fuse panel.
7. Push in a new fuse of the same rating, and make sure it fits tightly in the clips. If it is not tight, contact an authorized retailer of Genesis Branded products.

### NOTICE

Always securely install the fuse panel cover. Water may contact the fuse and cause an electrical failure.

### Multi fuse / Midi fuse

Multi type



Midi type



If the multi fuse or midi fuse is blown, contact an authorized retailer of Genesis Branded products.

## Fuse/Relay Panel Description

### *Instrument panel fuse panel*



Inside the fuse panel cover, you can find the panel label describing fuse names and ratings.

### ***i* Information**

Not all fuse panel descriptions in this manual may be applicable to your vehicle. When you inspect the fuse panel on your vehicle, refer to the fuse panel label.

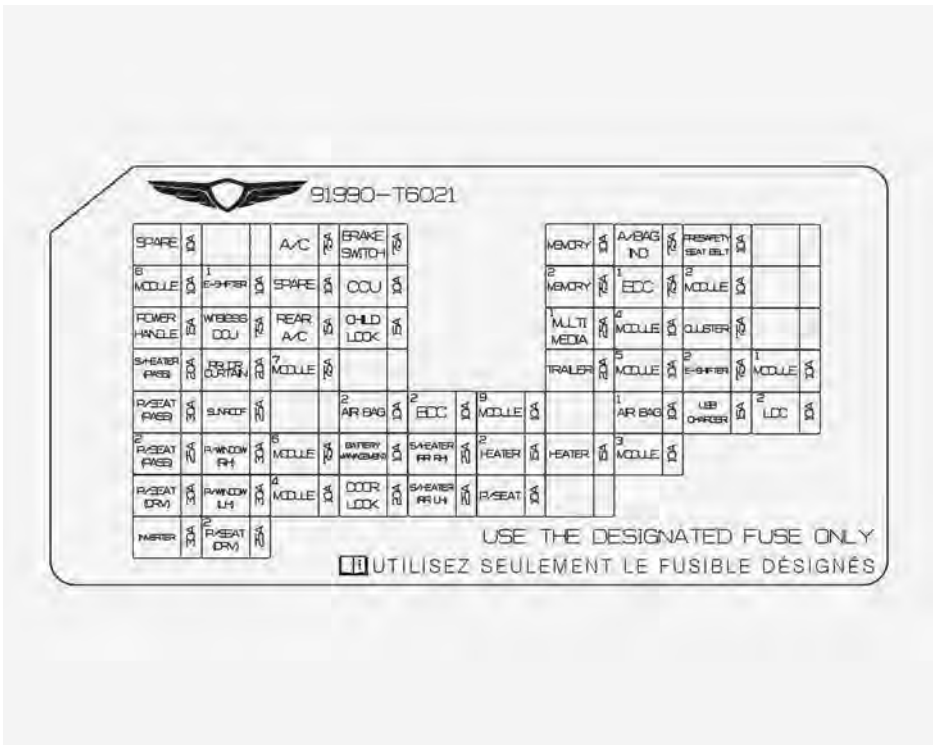

**Instrument panel fuse panel**

Fuse Name	Fuse Rating	Circuit Protected
A/C	7.5 A	Front A/C Controller, Front/Rear A/C Control Panel, Front A/C Control Module, In-car temperature Sensor, In-car PM Sensor, E/R Sub Junction Block (LHD: RLY3, RLY4, RLY5, RLY8 / RHD: RLY2, RLY3, RLY9, RLY10)
BRAKE SWITCH	7.5 A	BDC, Stop Lamp Switch
MEMORY	10 A	BDC, Head-Up Display, Security Indicator, Front Monitor, ADAS Unit (Parking), Rear Door Curtain Module, Rear A/C Control Panel, Driver/Passenger Outside Mirror
A/BAG IND	7.5 A	Overhead Console (Lamp & Sunroof Switch)
PRESAFETY SEAT BELT	10 A	Pre-Active Seat Belt Unit

Fuse Name	Fuse Rating	Circuit Protected
MODULE8	10 A	Garnish Mood Lamp (Center/LH/RH), Mood Lamp Unit (Master), Multifunction Switch, Console Mood Lamp LH/RH, Cup Holder Mood Lamp, Driver Lumbar Support Unit, Data Link Connector, Electro Chromic Mirror, Driver Power Seat Module, Driver Power Seat Switch, Power Liftgate Module
E-SHIFTER1	10 A	Electronic ATM Shift Lever Dial
CCU	10 A	CCU
MEMORY2	7.5 A	Steering Tilt & Telescopic Unit, Built-In CAM Unit, Front A/C Control Module, Front A/C Controller, Front A/C Control Panel, Front Console Keyboard, Smart Phone Wireless Charger
BDC1	7.5 A	BDC, BMS Control Module
MODULE2	10 A	Stop Lamp Switch, CCU, CDCU
POWER HANDLE	15 A	Steering Tilt & Telescopic Unit
wireless DCU	7.5 A	DCU
REAR A/C	15 A	Rear Blower Motor, Rear A/C Control Panel
CHILD LOCK	15 A	PDC (Child Lock/Unlock Relay)
MULTI MEDIA1	25 A	Low DC-DC Converter, CCIC Head Unit
MODULE4	10 A	Overhead Console (Lamp & Sunroof Switch), CCIC Head Unit, ICC Unit, Low DC-DC Converter, Built-In CAM Unit, DCU, Front A/C Controller, CCIC Keyboard, Front Console Switch, Smart Phone Wireless Charger, Electro Chromic Mirror, Front A/C Control Module, Data Link Connector, AMP, Front Armrest Heater Unit, Front A/C Control Panel, Rear A/C Control Panel, Rear Seat Entertainment Unit, 2ND Seat LH/RH Module, 2ND Air Ventilation Seat LH/RH, 2ND Seat Heater LH/RH Control Module, Side Step Control Module, Driver/Passenger Power Seat Module
CLUSTER	7.5 A	Head-Up Display, Front Monitor
SEAT HEATER (PASS)	20 A	Passenger Power Seat Module
RR DR CURTAIN	20 A	Rear Door Curtain Module

Fuse Name	Fuse Rating	Circuit Protected
MODULE7	7.5 A	AC Inverter Outlet, Multifunction Switch, Headlamp LH/RH, AC Inverter, 12 V Lithium Auxiliary Battery, Rear Junction Block (Rear Wiper Relay)
TRAILER	20 A	Trailer Connector
MODULE5	10 A	Driver Door Module, Multifunction Switch
E-SHIFTER2	7.5 A	Electronic ATM Shift Lever Dial
MODULE1	10 A	Rear USB Charger Connector, Storage Lamp, CCIC Head Unit, Emergency Call (E-Call) Switch, Front Console Keyboard, Electronic ATM Shift Lever Dial, ADAS Unit (Parking), DCU, Rear Seat Entertainment Unit, Low DC-DC Converter, CCU, Built-In CAM Unit, BDC, Front Monitor, AMP
POWER SEAT (PASS)	30 A	Passenger Power Seat Module
SUNROOF	25 A	Sunroof Control Unit (Master)
AIR BAG2	10 A	SRS Control Module
BDC2	10 A	Front/Rear UWB Unit LH/RH, BDC, Bluetooth Unit #1/#2. Rear Door Outside Handle LH/RH, Driver/Passenger Door Outside Handle
MODULE9	10 A	Rain Sensor, ICC Unit
AIR BAG1	10 A	SRS Control Module
USB CHARGER	15 A	Front Console Power Outlet
LDC2	10 A	Smart Phone Wireless Charger, Front Console Keyboard, Front A/C Controller, Front A/C Control Panel, Front Monitor, Front Corner Radar, Head-Up Display, ADAS Unit (Parking), Rear A/C Control Panel, Rear Corner Radar LH/RH, Rear Smart Phone Wireless Charger, CDCU
POWER SEAT (PASS)2	25 A	Passenger Power Seat Module
POWER WINDOW (RH)	30 A	Driver/Passenger Power Window Module, Rear Power Window Module RH
MODULE6	7.5 A	BDC
BMS	10 A	BMS Control Module
SEAT HEATER (RR RH)	25 A	2ND Seat RH Module, 2ND Seat Heater RH Control Module, 2ND Air Ventilation Seat RH Control Module

Fuse Name	Fuse Rating	Circuit Protected
HEATER2	15 A	Rear Armrest Heater Unit (for 6 seater)
HEATER	15 A	Front Armrest Heater Unit
MODULE3	10 A	Rear Corner Radar LH/RH, ECS Unit, ADAS Unit (Parking), E-LSD Control Module, Rear Cup Holder, Rear Smart Phone Wireless Charger, Rear Armrest Heater Unit (for 6 seater), ADAS Unit (Driving), Crash Pad Switch, Front View Camera, Steering Tilt & Telescopic Unit
POWER SEAT (DRV)1	30 A	Driver Power Seat Module
POWER WINDOW (LH)	30 A	Driver/Passenger Power Window Module, Rear Power Window Module LH
MODULE4	10 A	Rear Console Mood Lamp, Passenger Power Seat Switch, 3RD Seat Module, Rear Door Mood Lamp Unit LH/RH, Passenger Power Seat Module, 2ND Seat LH/RH Module, 2ND Air Ventilation Seat LH/RH, Driver Door Module, 2ND Seat Heater LH/RH Control Module, Driver/Passenger Door Mood Lamp Unit
DOOR LOCK	20 A	Door Lock Relay, Door Unlock Relay
SEAT HEATER (RR LH)	25 A	2ND Seat LH Module, 2ND Seat Heater LH Control Module, 2ND Air Ventilation Seat LH Control Module
POWER SEAT	10 A	Driver/Passenger Lumbar Support Unit
INVERTER	30 A	AC Inverter
POWER SEAT (DRV)2	25 A	Driver Power Seat Module





**Engine compartment fuse panel (Engine room junction block)**

Type	Fuse Name	Fuse Rating	Circuit Protected
MIDIFUSE	ALT	225 A	[Without Mild HEV] Alternator
	MDPS	125 A	MDPS Unit
	e-S/C	150 A	[With Mild HEV] Electric Super Charging Unit
MULTIFUSE	AWD	30 A	AWD ECU
	E-CVVT	40 A	[2.5 T-GDI] E/R Junction Block (RLY.1)
	OIL PUMP	50 A	[With ISG] Electronic Oil Pump
	BATT 2	60 A	PDC (IPS12/IPS13)
	BATT 1	60 A	PDC (IPS4/IPS5/IPS6/IPS7)
	COOLING FAN	100 A	Cooling Fan Motor
FUSE	HORN	15 A	PCB Block (Horn Relay)
	A/C1	15 A	Engine Room Junction Block (RLY.5)
	TCU1	20 A	TCM
	ECU1	15 A	ECM
	FUEL PUMP	20 A	Engine Room Junction Block (RLY.2)
	MODULE1	10 A	E/R Sub Junction Block (RLY.6), [G4KR] Electronic Engine mount Solenoid LH/RH
	ACC2	15 A	Engine Room Sub Junction Block (LHD: RLY.9 / RHD: RLY.5)
	HEAD LAMP LH	40 A	Headlamp LH
	POWER OUTLET1	40 A	Engine Room Sub Junction Block (LHD: RLY.1 / RHD: RLY.8)
	START	30 A	Engine Room Junction Block (RLY.3)
	HEAD LAMP RH	40 A	Headlamp RH
	E-CVVT2	20 A	[2.5 T-GDI] ECM
	E-CVVT3	20 A	[2.5 T-GDI] ECM

Engine compartment fuse panel (PCB junction block)

Fuse Name	Fuse Rating	Circuit Protected
IG1	30 A	IG1 Relay
ECU3	30 A	Main Relay
IG2	30 A	IG2 Relay
ACC	30 A	ACC Relay
ECU2	10 A	ECM
MODULE2	10 A	AWD ECU, Front Radar, Front Corner Radar [2.5 T-GDI] Electronic Engine Control Mount Unit
MDPS 2	10 A	MDPS Unit
SENSOR3	10 A	[2.5 T-GDI] Oxygen Sensor (Up/Down) [G6DS/G6DS-48V] Oxygen Sensor #1/#2
SENSOR1	10 A	[2.5 T-GDI] E/R Junction Block (RLY.2), Injector #1/#2/#3/#4 [3.5 T-GDI/3.5 T-GDI (48 V) MHEV] E/R Junction Block (RLY.2), Injector #1/#2/#3/#4/#5/#6 (MPI)
SENSOR4	15 A	[2.5 T-GDI/3.5 T-GDI] Cooling Fan Motor [3.5 T-GDI (48 V) MHEV] Cooling Fan Motor, Mild Hybrid Starter & Generator Motor (Signal), Electric Super Charging Unit (Signal)
WASHER	15 A	Washer Relay, Engine Room Junction Block (RLY.6)
EWP	20 A	Electric Water Pump
SENSOR5	10 A	Electronic Oil Pump
IEB4	10 A	IEB Unit
TCU2	15 A	TCM, P/N Relay
SENSOR2	10 A	[2.5 T-GDI] E/R Junction Block (RLY.5), Oil Control Valve (Exhaust), Variable Oil Pump Valve, Oil Level Sensor, Canister Close Valve, Purge Control Solenoid Valve, RCV Control Solenoid Valve [3.5 T-GDI/3.5 T-GDI (48 V) MHEV] E/R Junction Block (RLY.5), RCV Control Solenoid Valve #1/#2, Purge Control Solenoid Valve, Variable Oil Pump Valve, Oxygen Sensor #3/#4, Oil Control Valve #1/#3 (Intake), Oil Control Valve #2/#4 (Intake/Exhaust), Canister Close Valve

Fuse Name	Fuse Rating	Circuit Protected
IGN COIL	15 A	[2.5 T-GDI] Ignition Coil #1/#2/#3/#4 [3.5 T-GDI/3.5 T-GDI (48 V) MHEV] Ignition Coil #1/#2/#3/#4/#5/#6
ECU4	20 A	ECM

**Engine compartment fuse panel (Engine room sub junction block)**

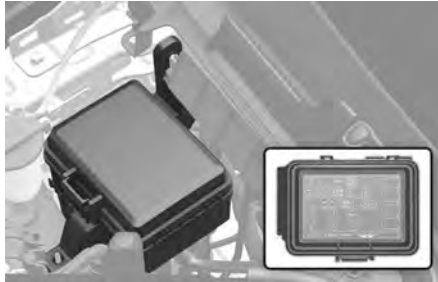

Inside the fuse panel cover, you can find the panel label describing fuse names and ratings.

***i* Information**

Not all fuse panel descriptions in this manual may be applicable to your vehicle. When you inspect the fuse panel on your vehicle, refer to the fuse panel label.

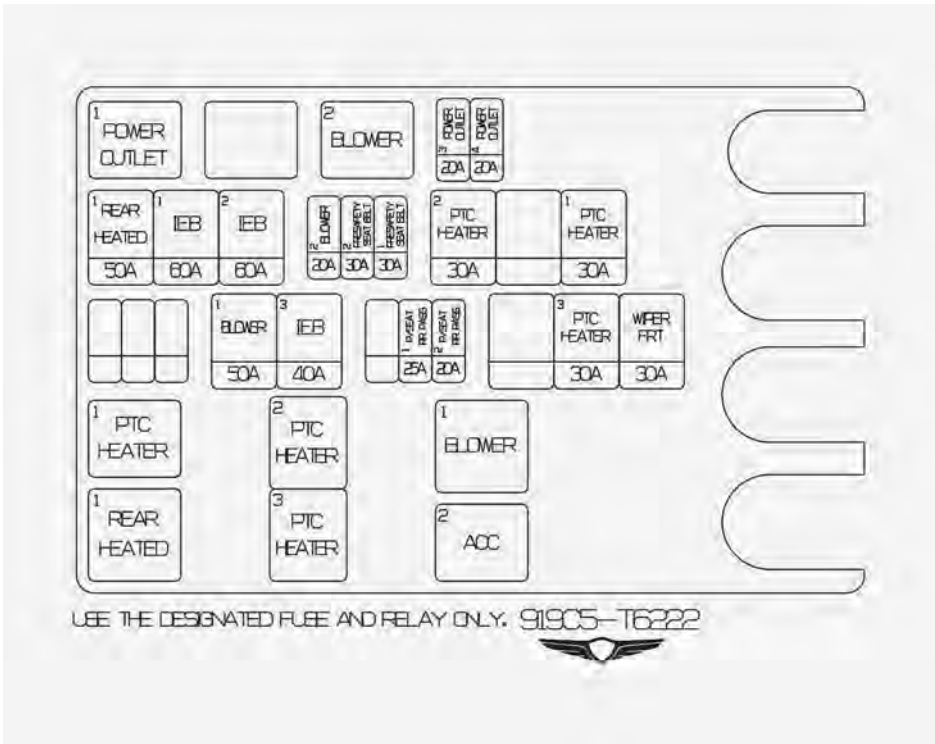

**Engine compartment fuse panel (Engine room sub junction block)**

Fuse Name	Fuse Rating	Circuit Protected
POWER OUTLET3	20 A	Engine Room Sub Junction Block (RLY.1), Luggage Power Outlet
POWER OUTLET4	20 A	Engine Room Sub Junction Block (RLY.1), Rear Console Power Outlet
RR HTD	50 A	Engine Room Sub Junction Block (RLY.7)
IEB1	60 A	IEB Unit
IEB2	60 A	IEB Unit
BLOWER2	20 A	E/R Sub Junction Block (RLY.3)
PRESAFETYSEAT BELT2	30 A	Pre-Active Seat Belt Unit
PRESAFETYSEAT BELT1	30 A	Pre-Active Seat Belt Unit
PTC HEATER2	30 A	Engine Room Sub Junction Block (RLY.5)
PTC HEATER1	30 A	Engine Room Sub Junction Block (RLY.4)
BLOWER1	50 A	Engine Room Sub Junction Block (RLY.6)
IEB3	40 A	IEB Unit
B/A HORN	15 A	Engine Room Sub Junction Block (RLY.2)
POWERSEAT (RR PASS)1	25 A	2ND Seat RH Module
POWERSEAT (RR PASS)2	20 A	2ND Seat RH Module, 2ND Seat RH Reclining Folding Actuator
PTC HEATER3	30 A	Engine Room Sub Junction Block (RLY.8)
WIPER FRT	30 A	Wiper Motor

**Cargo area (Rear sub junction block)**

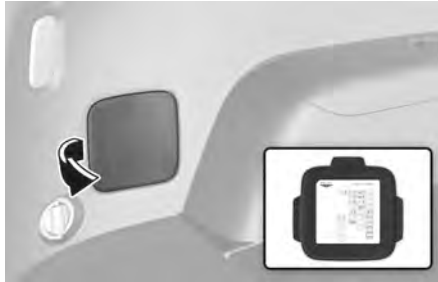

Inside the fuse panel cover, you can find the panel label describing fuse names and ratings.

***i* Information**

Not all fuse panel descriptions in this manual may be applicable to your vehicle. When you inspect the fuse panel on your vehicle, refer to the fuse panel label.

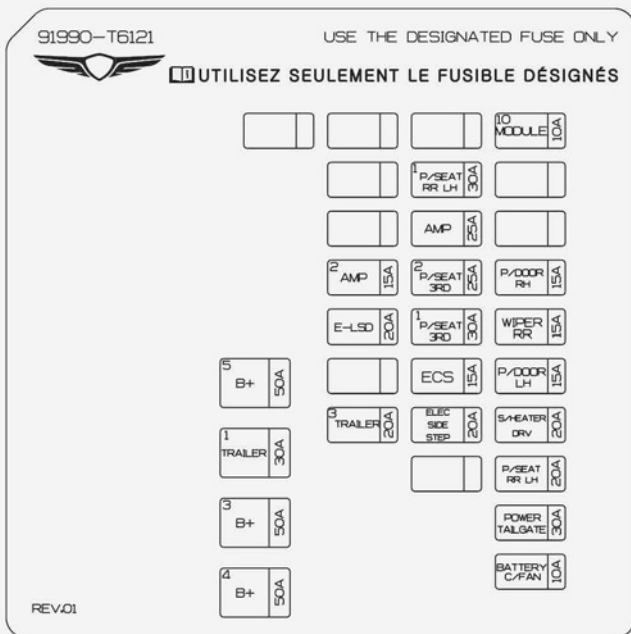

**Cargo area (Rear sub junction block)**

Fuse Name	Fuse Rating	Circuit Protected
B+5	50 A	PDC (Fuse - F29/F36/F38/F46/F48/F49/F53/F56)
TRAILER1	30 A	Trailer Connector
B+3	50 A	PDC (Fuse - F9/F10/F17/F18F25/F26/F33/F34/F43/F44/F51/F52/F58/F59)
B+4	50 A	PDC (Fuse - Long Term Load Latch Relay/F4/F12/F20/F37/F47/F54/F55/IPS13 (1CH))
POWER SEAT (RR LH1)	30 A	2ND SEAT LH MODULE
AMP	25 A	Low DC-DC Converter, AMP
AMP2	15 A	Rear Seat Entertainment Unit
POWER SEAT (3RD 2)	25 A	3RD Seat Module
P/DOOR RH	15 A	Driver/Passenger Door Latch, Rear Door Latch RH
E-LSD	20 A	E-LSD Control Module
POWER SEAT (3RD 1)	30 A	3RD Seat LH/RH Reclining Folding Actuator
WIPER RR	15 A	Rear Wiper Relay, Rear Wiper
ECS	15 A	ECS Unit
P/DOOR LH	15 A	Driver/Passenger Door Latch, Rear Door Latch LH
TRAILER3	20 A	Trailer Connector
ELEC SIDE STEP	20 A	Side Step Control Module
SEAT HEATER DRV	20 A	Driver Power Seat Module
POWER SEAT (RR LH2)	20 A	2ND Seat LH Module, 2ND Seat LH Reclining Folding Actuator
POWER TAILGATE	30 A	Power Liftgate Module
BATTERY C/FAN	10 A	BMS Cooling Fan
MODULE10	10 A	Spare for Rear Seat Entertainment System, Low DC-DC Converter

***Cargo area (Battery junction block)***



Inside the fuse panel cover, you can find the panel label describing fuse names and ratings.

***i* Information**

Not all fuse panel descriptions in this manual may be applicable to your vehicle. When you inspect the fuse panel on your vehicle, refer to the fuse panel label.

---



Type A

주의 (CAUTION)

점프 시동 상세 방법은 차량 수리수용서를 참조하십시오.  
 For the details about jump start, refer to the owner's manual.  
 Para más información acerca del arranque con otras de cuenta, consulte el manual del propietario.  
 См. руководство пользователя для дополнительной информации о запуске двигателя от внешнего источника.  
 发动机短接起动的详细方法请参考车辆配备的车主手册相关内容。

بواسطة كابل مشترك مع بطاريه خارجيه ارجع لادليل المستخدم للمعلومات عن طريقة التشغيل



9	B+	15A		
				

발동기 AMS	10A
배터리 ALK BATT	50A

6	B+
	
100A	100A

7	B+
	
100A	100A

8	B+
	
100A	100A

사용된 부품을 사용하지 마십시오.  
 USE THE DESIGNATED FUSE ONLY.  
 USE SOLO LOS FUSELES ESPECIFICADOS.  
 Используйте только предназначенные предохранители.  
 请使用指定的保险丝。

استخدم الفيوز ذو القياس المناسب [ ]  
 91955-16302

Type B



Cargo area (Battery junction block)

Fuse Name	Fuse Rating	Circuit Protected
B+9	125 A	LHD: Engine Room Sub Junction Block (B+) / RHD: Joint Block Engine Room Junction Block (Fuse - F11/F12/F13/F14/F15/F16/F17/F18/F19), PCB Block (Fuse - F1/F2/F3/F4)
B+6	100 A	Rear Junction Block (Fuse - F6/F11/F12/F15/F18/F21, S/B LPJ Fuse - F3)
B+7	100 A	Rear Junction Block (Fuse - F13/F16/F19/F22/F24/F25/F26, S/B LPJ Fuse - F4)
B+8	100 A	Rear Junction Block (Fuse - F11/F14/F20, S/B LPJ Fuse - F1/F2)
AMS	10 A	Battery Sensor

---

Fuse Name	Fuse Rating	Circuit Protected
AUX BATT	50 A	12 V Lithium Auxiliary Battery

---

## LED Lights

Contact an authorized retailer of Genesis Branded products to replace most vehicle LED lights. It is difficult to replace vehicle LED lights because other parts of the vehicle must be removed before you can get to the light. This is especially true for removing the headlight assembly to get to the light(s).

Removing/installing the headlight assembly can result in damage to the vehicle.

### WARNING

- Prior to replacing a LED light, depress the brake pedal, shift to P (Park), apply the parking brake, press the Engine Start/Stop button to the OFF position, and take the key with you when leaving the vehicle to avoid sudden movement of the vehicle and to prevent possible electric shock.
- Be aware the bulbs may be hot and may burn your fingers.

### NOTICE

- Be sure to replace the burned-out bulb with one of the same wattage to prevent damage to the fuse or electrical wiring system.
- To prevent damage, do not clean the headlight lens with chemical solvents or strong detergents.

### *i* Information

Headlight desiccant (if equipped)

This vehicle is equipped with desiccant to reduce fogging inside the headlight due to moisture. The desiccant is consumable and its performance may change based on the used period or environment. If fogging inside the headlight due to moisture continues for a long time, contact an authorized retailer of Genesis Branded products.

---

### *i* Information

The headlight and tail light lenses could appear to have condensation inside if the vehicle is washed after driving or if the vehicle is driven in wet weather. This condition is caused by a higher temperature inside the light and a cooler outside temperature. Moisture that condenses in the light is removed after driving with the light on. If the moisture is not removed, contact an authorized retailer of Genesis Branded products.

---

### *i* Information

- A normally functioning light may flicker momentarily to stabilize the vehicle's electrical control system. If the light goes out, or continues to flicker, contact an authorized retailer of Genesis Branded products.
  - The parking light may not turn on when the parking light switch is turned on, but the parking light and headlight switch may turn on when the headlight switch is turned on. This may be caused by network failure or vehicle electrical control system malfunction. If this occurs, contact an authorized retailer of Genesis Branded products.
-

## *i* Information

Adjust the headlight aim after an accident or the headlight is replaced.

### Headlight, Parking Light, Turn Signal Light (DRL) Replacement

Type A

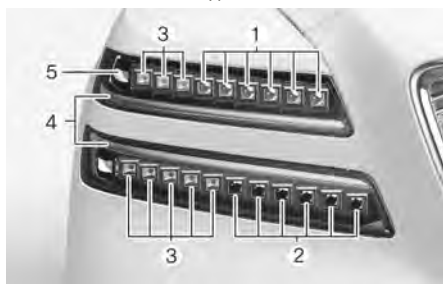

- (1) Headlight (Low)
- (2) Headlight (High)/Headlight (Low beam assist)
- (3) Headlight (Low beam assist)
- (4) Daytime running light/Parking light/Turn signal light
- (5) Side marker

Type B

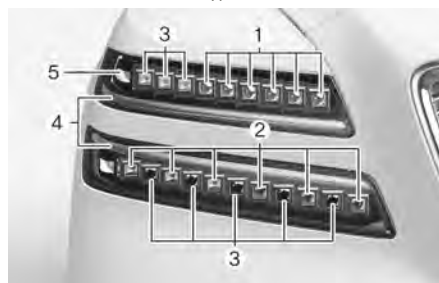

- (1) Headlight (Low beam assist)
- (2) Headlight (High)/Headlight (Low beam assist)
- (3) Headlight (Low beam assist)
- (4) Daytime running light/Parking light/Turn signal light
- (5) Side marker

If the LED light does not operate, contact an authorized retailer of Genesis Branded products.

The LED lights cannot be replaced as a single unit. A skilled technician should check or repair the LED light, for it may damage related parts of the vehicle.

## Side Repeater Light Replacement



If the LED light (1) does not operate, contact an authorized retailer of Genesis Branded products.

The LED lights cannot be replaced as a single unit. A skilled technician should check or repair the LED light, for it may damage related parts of the vehicle.

## Puddle Light Replacement

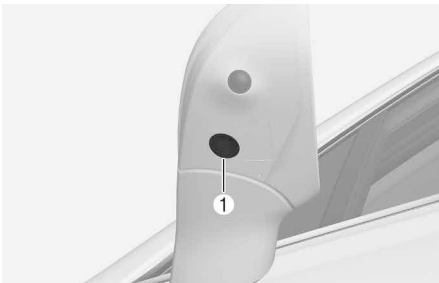

If the LED light (1) does not operate, contact an authorized retailer of Genesis Branded products.

The LED lights cannot be replaced as a single unit because it is an integrated unit. A skilled technician should check or repair the LED light, for it may damage related parts of the vehicle.

## Rear Combination Light Replacement

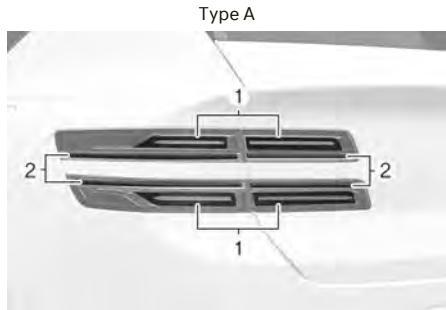

- (1) Tail light/Side marker light
- (2) Turn signal light/Stop light

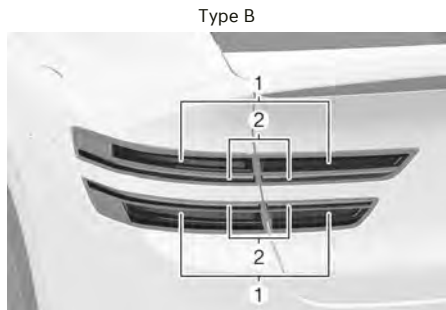

- (1) Tail light
- (2) Turn signal light/Stop light

If the LED light does not operate, contact an authorized retailer of Genesis Branded products.

The LED lights cannot be replaced as a single unit because it is an integrated unit. A skilled technician should check or repair the LED light, for it may damage related parts of the vehicle.

## Reverse Light Replacement

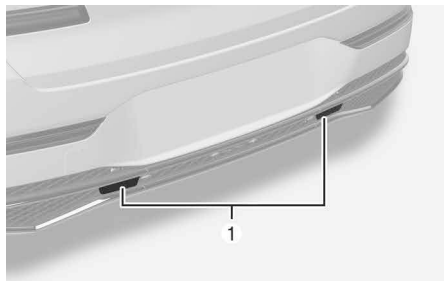

If the LED light (1) does not operate, contact an authorized retailer of Genesis Branded products.

The LED lights cannot be replaced as a single unit because it is an integrated unit. A skilled technician should check or repair the LED light, for it may damage related parts of the vehicle.

## High Mounted Stop Light Replacement

Type A

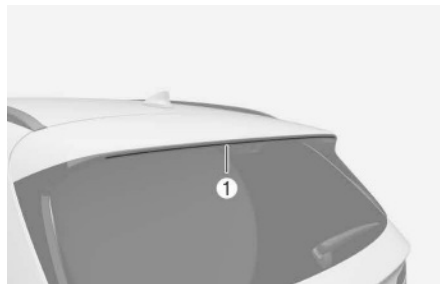

Type B

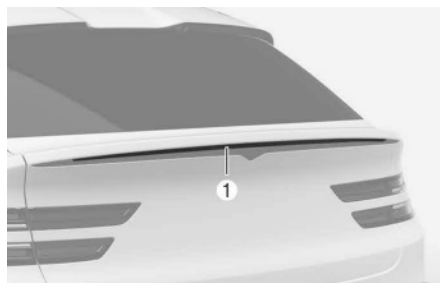

If the LED light (1) does not operate, contact an authorized retailer of Genesis Branded products.

The LED lights cannot be replaced as a single unit because it is an integrated unit. A skilled technician should check or repair the LED light, for it may damage related parts of the vehicle.

## License Plate Light Replacement

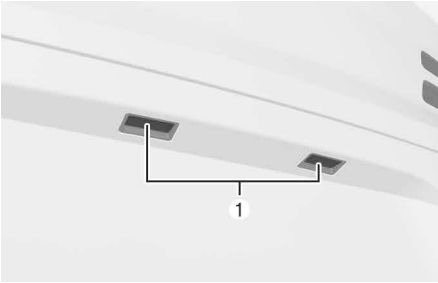

If the LED light (1) does not operate, contact an authorized retailer of Genesis Branded products.

The LED lights cannot be replaced as a single unit because it is an integrated unit. A skilled technician should check or repair the LED light, for it may damage related parts of the vehicle.

## Interior Light Replacement

First row lamp



Second row lamp (without sunroof) / Third row lamp (Type A)

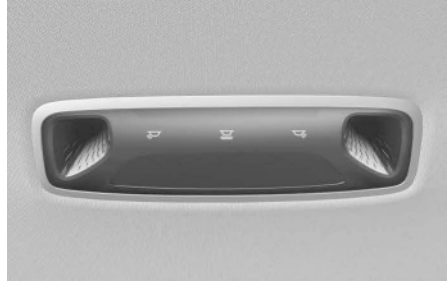

Personal lamp (with sunroof)





Third row lamp (Type B)

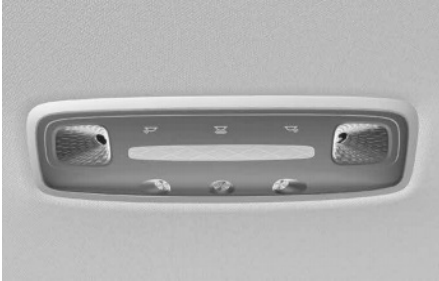

Mood lamp



Vanity mirror lamp



Cargo area lamp



Glove box lamp

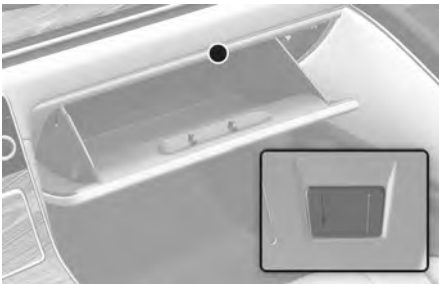

If the LED light does not operate, contact an authorized retailer of Genesis Branded products.

The LED lights cannot be replaced as a single unit because it is an integrated unit. A skilled technician should check or repair the LED light, for it may damage related parts of the vehicle.

Inner door handle lamp (1) / Foot lamp (2) / Door courtesy lamp (3)

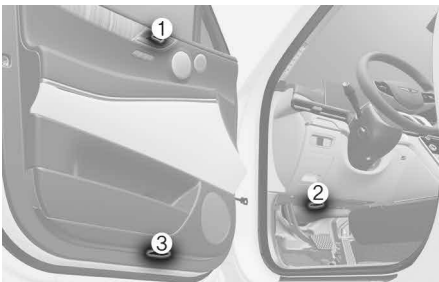

## Appearance Care

### Exterior Care

#### **NOTICE**

If you park your vehicle near a stainless steel sign or glass facade building, the vehicle's exterior plastic parts such as a bumper, spoiler, garnish, lamp or side view mirror might be damaged due to sunlight reflected from the sign or building. To prevent damage of the exterior plastic parts, you should avoid parking in areas where light may be reflected or use a car cover. (The exterior plastic parts applied to your vehicle may vary.)

---

#### **Exterior general caution**

It is very important to follow the label directions when using any chemical cleaner or polish. Read all warning and caution statements that appear on the label.

#### **Finish maintenance**

##### **Washing**

To help protect your vehicle's finish from rust and deterioration, wash it thoroughly and frequently at least once a month with lukewarm or cold water.

If you use your vehicle for off-road driving, you should wash it after each off-road trip. Pay special attention to the removal of any accumulation of salt, dirt, mud, and other foreign materials. Make sure the drain holes in the lower edges of the doors and rocker panels are kept clear and clean.

Insects, tar, tree sap, bird droppings, industrial pollution, and similar deposits may damage your vehicle's finish if not removed immediately.

Even prompt washing with plain water may not completely remove all these deposits. Use a mild soap, safe for use on painted surfaces.

After washing, rinse the vehicle thoroughly with lukewarm or cold water. Do not allow soap to dry on the finish.

#### **NOTICE**

High pressure water may damage front and rear cameras, sensors, vehicle trim, and boots (rubber or plastic covers) or connectors.

---

#### **⚠ WARNING**

After washing the vehicle, dry the brakes by applying them lightly while maintaining a slow forward speed.

---

#### **NOTICE**

- Do not use strong soap, chemical detergents, or hot water, and do not wash the vehicle in direct sunlight or when the body of the vehicle is warm.
  - To prevent damage to the plastic parts, do not clean with chemical solvents or strong detergents.
-

**NOTICE**

- Water washing in the engine compartment including high pressure water washing may cause the failure of electrical circuits located in the engine compartment.
- Never allow water or other liquids to come in contact with electrical/electronic components inside the vehicle to prevent damage.

***i* Information**

Matte paint finish vehicle (if equipped)

To prevent damage the matte finish:

- Do not go through an automatic car wash with rotating brushes.
- Avoid using a steam cleaner. High temperature steam may leave stains that are difficult to remove.
- Use a soft cloth (e.g. microfiber towel or sponge) when washing your vehicle and dry with a microfiber towel. When you hand wash your vehicle, do not use a cleaner that finishes with wax. If the vehicle surface is too dirty (sand, dirt, dust, contaminant, etc.), clean the surface with water before washing the vehicle.

**Waxing**

A good coat of wax helps protect your paint from contaminants.

Wax the vehicle when water no longer beads on the paint.

Always wash and dry the vehicle before waxing. Use a good quality liquid or paste wax, and follow the manufacturer's instructions. Wax all metal trim to protect it and to maintain its luster.

Removing oil, tar, and similar materials with a spot remover usually strips the wax from the finish. Be sure to re-wax these areas even if the rest of the vehicle does not yet need waxing.

**NOTICE**

- Do not wipe dust or dirt off the body with a dry cloth to prevent scratching the finish.
- Do not use steel wool, abrasive cleaners, or strong detergents containing highly alkaline or caustic agents on chrome-plated or anodized aluminum parts to prevent discoloration or paint deterioration.

**NOTICE**

Matte paint finish vehicle (if equipped)

Do not use any polish protector such as detergent, abrasive, or polish. If wax is applied, remove the wax immediately using a silicone remover. If any tar or tar contaminant is on the surface, use a tar remover to clean. Be careful not to apply too much pressure on the painted area.

### ***Finish damage repair***

Deep scratches or stone chips on the painted surface must be repaired promptly. Exposed metal quickly rusts and may develop into a major repair expense.

#### ***i* Information**

If your vehicle is damaged and requires any metal repair or replacement, make sure the body shop applies anti-corrosion materials to the parts repaired or replaced.

---

#### **NOTICE**

Matte paint finish vehicle (if equipped)

It is impossible to only repaint the damaged area. The whole part must be repainted as necessary. If the vehicle is damaged and painting is required, contact an authorized retailer of Genesis Branded Products.

---

### ***Bright-metal maintenance***

- To remove road tar and insects, use a tar remover, not a scraper or other sharp object.
- To protect the surfaces of bright-metal parts from corrosion, apply a coating of wax or chrome preservative, and rub to a high luster.
- During winter weather or in coastal areas, cover the bright metal parts with a heavier coating of wax or preservative. If necessary, coat the parts with non-corrosive petroleum jelly or other protective compound.

### ***Underbody maintenance***

Corrosive materials used for ice and snow removal and dust control may collect on the underbody. If these materials are not removed, accelerated rusting may occur on underbody parts such as fuel lines, frame, floor pan, and exhaust system, even though they have been treated with rust protection.

Thoroughly flush the vehicle underbody and wheel openings with lukewarm or cold water once a month, after off-road driving and at the end of each winter. Pay special attention to these areas because it is difficult to see all the mud and dirt. It will do more harm than good to wet down the road grime without removing it. The lower edges of doors, rocker panels, and frame members have drain holes that must not be allowed to clog with dirt. Trapped water in these areas may cause rusting.

#### **WARNING**

After washing the vehicle, test the brakes while driving slowly to see if they have been affected by water. If braking performance is impaired, dry the brakes by applying them lightly while maintaining a slow forward speed.

---

### ***Aluminum wheel maintenance***

The aluminum wheels are coated with a clear protective finish.

- Do not use abrasive cleaner, polishing compound, solvent, or wire brushes on aluminum wheels.
- Use only a mild soap or neutral detergent, and rinse thoroughly with water. Also, clean the wheels after driving on salted roads.
- Do not wash the wheels with high-speed car wash brushes.
- Do not use any cleaners containing acid or alkaline detergents.

## **Corrosion protection**

### **Protecting your vehicle from corrosion**

By using the most advanced design and construction practices to combat corrosion, Genesis Branded Vehicle produces vehicles of the highest quality. However, this is only part of the job. To achieve the long-term corrosion resistance your vehicle can deliver, the owner's cooperation and assistance are also required.

### **Common causes of corrosion**

The most common causes of corrosion on your vehicle are:

- Road salt, dirt, and moisture that is allowed to accumulate underneath the vehicle.
- Removal of paint or protective coatings by stones, gravel, abrasion, minor scrapes, and dents that leave unprotected metal exposed to corrosion.

### **High-corrosion areas**

If you live in an area where your vehicle is regularly exposed to corrosive materials, corrosion protection is particularly important. Some of the common causes of accelerated corrosion are road salts, dust control chemicals, ocean air, and industrial pollution.

### **Moisture breeds corrosion**

Moisture creates the conditions in which corrosion is most likely to occur. For example, corrosion is accelerated by high humidity, particularly when temperatures are just above freezing. In such conditions, the corrosive material is kept in contact with the vehicle surfaces by moisture that is slow to evaporate.

Mud is particularly corrosive because it is slow to dry and holds moisture in contact with the vehicle. Although the mud appears to be dry, it can still retain moisture and promote corrosion.

High temperatures may also accelerate corrosion of parts that are not properly ventilated so the moisture can be dispersed. For all these reasons, it is particularly important to keep your vehicle clean and free of mud or accumulations of other materials. This applies not only to the visible surfaces but particularly to the underside of the vehicle.

### **To help prevent corrosion**

#### **Keep your vehicle clean**

The best way to prevent corrosion is to keep your vehicle clean and free of corrosive materials. Attention to the underside of the vehicle is particularly important.

- If you live in a high-corrosion area where road salts are used, near the ocean, areas with industrial pollution, acid rain, and the like, take extra care to prevent corrosion. In winter, hose off the underside of your vehicle at least once a month and be sure to clean the underside thoroughly when winter is over.

- When cleaning underneath the vehicle, pay particular attention to the components under the fenders and other areas that are hidden from view. Do a thorough job; just dampening the accumulated mud rather than washing it away may accelerate corrosion rather than prevent it. Water under high pressure and steam are particularly effective in removing accumulated mud and corrosive materials.
- When cleaning lower door panels, rocker panels, and frame members, make sure that drain holes are kept open so that moisture can escape and not be trapped inside to accelerate corrosion.

### Keep your garage dry

Do not park your vehicle in a damp, poorly ventilated garage. This creates a favorable environment for corrosion. This is particularly true if you wash your vehicle in the garage or drive it into the garage when it is still wet or covered with snow, ice, or mud. Even a heated garage may contribute to corrosion unless it is well ventilated so moisture is dispersed.

### Keep paint and trim in good condition

Scratches or chips in the finish must be covered with "touch-up" paint as soon as possible to reduce the possibility of corrosion. If bare metal is showing through, the attention of a qualified body and paint shop is recommended.

Bird droppings are highly corrosive and may damage painted surfaces in just a few hours. Always remove bird droppings as soon as possible.

## Interior Care

### *Interior general precautions*

Prevent caustic solutions such as perfume and cosmetic oil, from contacting the interior parts because they may cause damage or discoloration. If they do contact the interior parts, wipe them off immediately. See the instructions for the proper way to clean vehicle interior surfaces.

### **NOTICE**

- Never allow water or other liquids to come in contact with electrical/electronic components inside the vehicle as this may damage them.
- When cleaning leather products (steering wheel, seats etc.), use neutral detergents or low alcohol content solutions. If you use high alcohol content solutions or acid/alkaline detergents, the color of the leather may fade or the surface may get stripped off.

---

### *Cleaning the upholstery and interior trim*

#### Vehicle interior surfaces

 If equipped

Remove dust and loose dirt from interior surfaces with a whisk broom or a vacuum cleaner. If necessary, clean interior surfaces with a mixture of warm water and mild non-detergent cleaner (test all cleaners on a concealed area before use).

## Fabric

**+** if equipped

Remove dust and loose dirt from fabric with a whisk broom or vacuum cleaner. Clean with a mild soap solution recommended for upholstery or carpets. Remove fresh spots immediately with a fabric spot cleaner. If you do not pay attention to fresh spots immediately, the fabric may be stained and its color may be affected. Also, its fire-resistant properties may be reduced if the material is not properly maintained.

### NOTICE

Using anything but recommended cleaners and procedures may affect the fabric's appearance and fire-resistant properties.

## Leather

**+** if equipped

- Features of seat leather
  - Leather is made from the outer skin of an animal, which goes through a special process to be available for use. Because it is a natural product, each part differs in thickness or density.
 

Wrinkles may appear as a natural result of stretching and shrinking depending on the temperature and humidity.
  - The seat is made of stretchable fabric to improve comfort.
  - The parts contacting the body are curved and the side supporting area is high that provides driving comfort and stability.
  - Wrinkles may appear naturally from usage. It is not a fault of the products.

### NOTICE

- Wrinkles or abrasions that appear naturally from usage are not covered by warranty.
  - Belts with metallic accessories, zippers, or keys inside the back pocket may damage the seat fabric.
  - Be sure not to wet the seat. It may change the nature of natural leather.
  - Jeans or clothes that could bleach may contaminate the surface of the seat covering fabric.
- 
- Caring for the leather seats
    - Vacuum the seat periodically to remove dust and sand on the seat. It prevents abrasion or damage of the leather and maintain its quality.
    - Wipe the natural leather seat cover often with dry or soft cloth.
    - Use of proper leather protector may prevent abrasion of the cover and helps maintain the color. Be sure to read the instructions and consult a specialist when using leather coating or protective agent.
    - Light colored (beige, cream beige) leather may be easily contaminated and the stains may be noticeable.
    - Avoid wiping with a wet cloth. It may cause the surface to crack.
  - Cleaning the leather seats
    - Remove all spills instantly.
    - For cosmetic products (sunscreen, foundation, etc.)
 

Apply cleansing cream on a cloth and wipe the contaminated spot. Wipe off the cream with a damp cloth and then wipe with a dry cloth.
    - For beverages (coffee, soft drink, etc.)
 

Apply a small amount of neutral detergent and wipe until it does not smear.

- For oil  
Remove oil instantly with an absorbable cloth and wipe with stain remover used only for natural leather.
- For chewing gum  
Harden the gum with ice and remove it gradually.
- Handling prime napa leather (if equipped)  
Try to avoid excessive sunlight and heat exposure. Excessive sunlight and heat exposure naturally fades and dries out napa leather, causing wrinkles and discoloration. If the napa leather is wet with liquid, immediately clean it with lint-free cloth to minimize damage. Do not scratch the napa leather surface with a sharp object. If your napa leather seat is bright colored, it may be contaminated or stained from dyed materials such as jeans.

### ***Interior wooden trim***

- Use a wooden furniture protector (e.g. wax, coating compound) to clean the interior wooden trim.
- Sharp objects (e.g. driver, knife), adhesive materials, or tapes may damage the interior wooden trim.
- Any strong impacts may damage the interior wooden trim.
- If the coating finish over the interior wooden trim is removed, moisture may damage or change wood traits.
- If the interior wooden trim is damaged, you may get a splinter from the wood surface. Have the damaged interior wooden trim replaced by an authorized Retailer of Genesis Branded Products.

### ***Cleaning the seat belt webbing***

Clean the belt webbing with any mild soap solution recommended for cleaning upholstery or carpet. Follow the instructions provided with the soap.

#### **WARNING**

Do not bleach or re-dye the webbing because this may weaken the seat belt.

---

### ***Cleaning the interior window glass***

If the interior glass surfaces need to be cleaned, use a glass cleaner. Follow the directions on the glass cleaner container.

#### **NOTICE**

Do not scrape or scratch the inside of the rear window. This may result in damage to the rear window defroster grid.

---



## Emission Control System

The emission control system of your vehicle is covered by a written limited warranty. Please see the warranty information contained in the Owner's Handbook & Warranty Information Booklet in your vehicle.

Your vehicle is equipped with an emission control system to meet all applicable emission regulations. There are three emission control systems, as follows:

1. Crankcase emission control system
2. Evaporative emission control system
3. Exhaust emission control system

In order to ensure the proper function of the emission control systems, have your vehicle inspected and maintained by an authorized retailer of Genesis Branded products in accordance with the maintenance schedule in this manual.

### **NOTICE**

For the Inspection and Maintenance Test (with Electronic Stability Control (ESC) system)

- To prevent the vehicle from misfiring during dynamometer testing, turn the Electronic Stability Control (ESC) system off by pressing the ESC button (ESC OFF light illuminated).
- After dynamometer testing is completed, turn the ESC system back on by pressing the ESC button again.

## 1. Crankcase Emission Control System

The positive crankcase ventilation system is used to prevent air pollution caused by blow-by gases being emitted from the crankcase. This system supplies fresh filtered air to the crankcase through the air intake hose. Inside the crankcase, the fresh air mixes with blow-by gases, which then pass through the PCV valve into the induction system.

## 2. Evaporative Emission Control System Including Onboard Refueling Vapor Recovery (ORVR)

The Evaporative Emission Control System is designed to prevent fuel vapors from escaping into the atmosphere. The ORVR system is designed to allow the vapors from the fuel tank to be loaded into a canister while refueling at the gas station, preventing the escape of fuel vapors into the atmosphere.

### **Canister**

Fuel vapors generated inside the fuel tank are absorbed and stored in the onboard canister. When the engine is running, the fuel vapors absorbed in the canister are drawn into the surge tank through the purge control solenoid valve.

### **Purge Control Solenoid Valve (PCSV)**

The purge control solenoid valve is controlled by the Engine Control Module (ECM). When the engine coolant temperature is low during idling, the PCSV closes so that evaporated fuel is not taken into the engine. After the engine warms-up during ordinary driving, the PCSV opens to introduce evaporated fuel to the engine.

### 3. Exhaust Emission Control System

The Exhaust Emission Control System controls exhaust emissions while maintaining good vehicle performance.

When the engine starts or fails to start, excessive attempts to restart the engine may cause damage to the emission system.

#### ***Engine exhaust (carbon monoxide) precautions***

- Carbon monoxide is present with other exhaust fumes. If you smell exhaust fumes in your vehicle, drive with all the windows fully open. Have your vehicle inspected and repaired immediately.
- Do not operate the engine in confined or closed areas (such as garages) any more than what is necessary to move the vehicle in or out of the area.
- When the vehicle is stopped in an open area for more than a short time with the engine running, adjust the ventilation system (as needed) to draw outside air into the vehicle.
- Never sit in a parked or stopped vehicle for an extended time with the engine running.
- When the engine stalls or fails to start, excessive attempts to restart the engine may cause damage to the emission control system.

#### **WARNING**

Engine exhaust gases contain carbon monoxide (CO). Though colorless and odorless, it is dangerous and could be lethal if inhaled. Follow the instructions on this page to avoid CO poisoning.

---

#### *i* **Information**

#### **CALIFORNIA PROPOSITION 65 WARNING**

Engine exhaust and a wide variety of automobile components and parts, including components found in the interior furnishings in a vehicle, contain or emit chemicals known to the State of California to cause cancer and birth defects and reproductive harm. In addition, certain fluids contained in vehicles and certain products of component wear contain or emit chemicals known to the State of California to cause cancer and birth defects or other reproductive harm.

---

### Operating precautions for catalytic converters

 if equipped

#### WARNING

The exhaust system and catalytic system are very hot while the engine is running or immediately after the engine is turned off. To avoid serious injury or death:

- Do not park, idle, or drive the vehicle over or near flammable objects, such as grass, vegetation, paper, leaves, etc. A hot exhaust system can may ignite flammable items under your vehicle.
- Keep away from the exhaust system and catalytic converter or you may get burned.

Also, do not remove the heat sink around the exhaust system, do not seal the bottom of the vehicle, and do not coat the vehicle for corrosion control. It may present a fire risk under certain conditions.

Your vehicle is equipped with a catalytic converter emission control device.

#### NOTICE

To prevent damage to the catalytic converter and to your vehicle, take the following precautions:

- Use only UNLEADED FUEL for gasoline engines.
- Do not operate the vehicle when there are signs of engine malfunction, such as misfire or a noticeable loss of performance.
- Do not misuse or abuse the engine. Examples of misuse are coasting with the engine off and descending steep grades in gear with the engine off.
- Do not operate the engine at high idle speed for an extended period of time (5 minutes or more).

- Do not modify or tamper with any part of the engine or emission control system. Have all inspections and adjustments made by an authorized retailer of Genesis Branded products.

- Avoid driving with an extremely low fuel level.

Running out of fuel may cause the engine to misfire, damaging the catalytic converter. Failure to follow these precautions may void your vehicle warranty.

### Gasoline Particulate Filter (GPF)

 if equipped

Gasoline Particulate Filter (GPF) system removes soot in the exhaust gas and automatically burns (or oxidizes) the accumulated soot while driving at normal/high driving speeds.

If the vehicle is continually driven short distances or at low speeds for a long time, the accumulated soot may not be automatically removed because of low exhaust gas temperature and the GPF lamp () illuminates.

The Gasoline Particulate Filter (GPF) lamp stops illuminating, when the driving speed exceeds 50 mph (80 km/h) with the engine RPM of 1,500-4,000 and the gear in the 3rd position or above for about 30 minutes.

When the GPF lamp starts to blink or the warning message, "Check exhaust system" pops up even though the vehicle was driven as mentioned above, contact an authorized retailer of Genesis Branded products.

If the GPF lamp blinks for an extended period of time, the GPF system may be damaged and the fuel economy may be lowered.

 **CAUTION**

Only use regulated gasoline fuels, in vehicles equipped with the GPF system.

Other gasoline fuels that contain unspecified additives may damage the GPF system and cause emission problems.

---

## California Perchlorate Notice

Perchlorate Material-special handling may apply, See:  
<https://dtsc.ca.gov/perchlorate>.

Notice to California Vehicle Dismantlers: Perchlorate containing materials, such as air bag inflators, seatbelt pretensioners and keyless remote entry batteries, must be disposed of according to Title 22 California Code of Regulations Section 67384.10 (a).

# Index

**A**

**Accessing Your Vehicle** ..... 5-6  
 Immobilizer System ..... 5-11  
 Smart Key ..... 5-6  
**Active Air Flap (AAF)** ..... 6-50  
 System Malfunction ..... 6-50  
**Active Sound Design** ..... 6-51  
**Advanced Rear Occupant Alert (ROA)** ..... 5-33  
 Declaration of Conformity ..... 5-34  
 Rear Occupant Alert Precautions ..... 5-34  
 System Operation ..... 5-33  
 System Setting ..... 5-33  
**Air Cleaner** ..... 9-24  
 Filter Replacement ..... 9-24  
**Air Conditioner Compressor Label** ..... 2-22  
**Air Conditioning System** ..... 2-15  
**All Wheel Drive (AWD)** ..... 6-34  
 All Wheel Drive (AWD) Operation ..... 6-35  
 Emergency Precautions ..... 6-37  
**Appearance Care** ..... 9-72  
 Exterior Care ..... 9-72  
 Interior Care ..... 9-76  
**Automatic Climate Control System** ..... 5-93  
 Automatic Heating and Air Conditioning ..... 5-97  
 Manual Heating and Air Conditioning ..... 5-97  
 System Maintenance ..... 5-109  
 System Operation ..... 5-107  
**Automatic Transmission** ..... 6-11  
 Automatic Transmission Operation ..... 6-11  
 Cluster Display Messages ..... 6-15  
 Good Driving Practices ..... 6-17  
 Paddle Shifter (Manual Shift Mode) ..... 6-16

**B**

**Battery** ..... 9-29  
 Battery Capacity Label ..... 9-32  
 Battery Recharging ..... 9-32  
 Battery Replacement ..... 9-31  
 For Best Battery Service ..... 9-30  
 Reset Items ..... 9-33  
**Before Driving** ..... 6-5  
 Before Entering the Vehicle ..... 6-5  
 Before Starting ..... 6-5  
**Before Using Driver Assistance System** ..... 7-4  
 Driver Assistance System Sensors ..... 7-5  
**Blind-Spot Collision-Avoidance Assist (BCA)** ..... 7-34  
 Blind-Spot Collision-Avoidance Assist Malfunction And Limitations ..... 7-38  
 Blind-Spot Collision-Avoidance Assist Operation ..... 7-36  
 Blind-Spot Collision-Avoidance Assist Settings ..... 7-35

<b>Blind-Spot View Monitor (BVM)</b> .....	7-61
Blind-Spot View Monitor Malfunction .....	7-62
Blind-Spot View Monitor Operation .....	7-61
Blind-Spot View Monitor Settings .....	7-61
<b>Brake Fluid</b> .....	9-23
Checking the Brake Fluid Level .....	9-23
<b>Braking System</b> .....	6-18
Anti-Lock Brake System (ABS) .....	6-24
Auto Hold .....	6-22
Brake Assistant System (BAS) .....	6-30
Crosswind Stability Control (CSC) .....	6-29
Disc Brakes Wear Indicator .....	6-18
Downhill Brake Control (DBC) .....	6-31
Electronic Parking Brake (EPB) .....	6-19
Electronic Stability Control (ESC) .....	6-25
Emergency Stop Signal (ESS) .....	6-29
Good Braking Practices .....	6-33
High Performance Brake .....	6-19
Hill-Start Assist Control (HAC) .....	6-28
Multi-Collision Brake (MCB) .....	6-30
Power-Assist Brakes .....	6-18
Vehicle Stability Management (VSM) .....	6-27
<b>Bulb Wattage</b> .....	2-13

## C

<b>Cabin Air Filter</b> .....	9-26
Filter Inspection .....	9-26
Filter Replacement .....	9-26
<b>California Perchlorate Notice</b> .....	9-82
<b>Center Console Overview</b> .....	2-7
<b>Child Restraint System (CRS)</b> .....	3-41
Children Always in the Rear .....	3-41
Installing a Child Restraint System .....	3-44
<b>Child restraint system (CRS)</b>	
Selecting a Child Restraint System .....	3-42
<b>Climate Control Additional Features</b> .....	5-114
Air Conditioning Auto-Drying .....	5-114
Auto Defogging System .....	5-114
Auto Dehumidify .....	5-115
Automatic Controls Linked to Climate Control Settings (for Driver's Seat) .....	5-116
Recirculating Air When Entering a Tunnel .....	5-116
Recirculating Air When Washer Fluid is Used .....	5-115
Sunroof Inside Air Recirculation .....	5-116
<b>Cluster Display</b> .....	4-25
Cluster Display Control .....	4-25
View Modes .....	4-26
<b>Coasting</b> .....	6-46
Coasting Operating Conditions .....	6-46
Coasting Release Conditions .....	6-46
Coasting Setting .....	6-46

**Consumer Information** ..... 2-23  
**Convenience Features** ..... 5-1

**D**

**Declaration of Conformity** ..... 7-144  
 Front Corner Radar (if equipped)/Rear Corner Radar (if equipped) ..... 7-145  
 Front Radar ..... 7-144  
**Dimensions** ..... 2-12  
**Door Locks** ..... 5-27  
 Automatic Door Lock and Unlock Features ..... 5-30  
 Electronic Child Safety Lock ..... 5-31  
 Operating Door Locks From Inside the Vehicle ..... 5-28  
 Operating Door Locks From Outside the Vehicle ..... 5-27  
**Drive Mode Integrated Control System (AWD)** ..... 6-47  
 Drive Mode ..... 6-47  
**Driver Assistance System** ..... 7-1  
**Driver Attention Warning (DAW)** ..... 7-53  
 Driver Attention Warning Malfunction And Limitations ..... 7-55  
 Driver Attention Warning Operation ..... 7-54  
 Driver Attention Warning Settings ..... 7-53  
**Driving Your Vehicle** ..... 6-1

**E**

**Electronic Control Suspension** ..... 6-40  
 System Malfunction ..... 6-40  
**Electronic Limited Slip Differential** ..... 6-39  
 Drive Mode Selection ..... 6-39  
 Warning Messages ..... 6-39  
**Electronically Controlled Suspension With Road Preview** ..... 6-40  
 Limitations of the System ..... 6-41  
 System Malfunction ..... 6-41  
**Emergency Situations** ..... 8-1  
**Emergency Stop (ES)** ..... 7-76  
 Emergency Stop Malfunction and Limitations ..... 7-77  
 Emergency Stop Operation ..... 7-76  
**Emission Control System** ..... 9-79  
 1. Crankcase Emission Control System ..... 9-79  
 2. Evaporative Emission Control System Including Onboard Refueling Vapor Recovery (ORVR) ..... 9-79  
 3. Exhaust Emission Control System ..... 9-80  
 Gasoline Particulate Filter (GPF) ..... 9-81  
**Engine** ..... 2-12  
**Engine Compartment** ..... 2-10, 9-4  
**Engine Coolant/Liquid-Cooled Intercooler Coolant** ..... 9-20  
 Changing Coolant ..... 9-22  
 Checking the Coolant Level ..... 9-20  
**Engine Number** ..... 2-22  
**Engine Oil** ..... 9-18  
 Checking the Engine Oil And Filter ..... 9-19



Checking the Engine Oil Level .....	9-18
<b>Engine Start/Stop Button</b> .....	6-6
Emergency Starting .....	6-9
Engine Start/Stop Button Positions .....	6-7
Starting the Engine .....	6-8
Turning Off the Engine .....	6-9
<b>Explanation of Scheduled Maintenance Items</b> .....	9-16
Air Cleaner Filter .....	9-16
Air Conditioning Refrigerant .....	9-18
Automatic Transmission Fluid .....	9-17
Brake Discs, Pads, Calipers, And Rotors .....	9-17
Brake Fluid .....	9-17
Brake Hoses And Lines .....	9-17
Cooling System .....	9-16
Drive Belts .....	9-16
Drive Shafts And Boots .....	9-17
Engine Coolant/Liquid-Cooled Intercooler Coolant .....	9-16
Engine Oil And Filter .....	9-16
Exhaust Pipe And Muffler .....	9-17
Fuel Filter (For Gasoline Engine) .....	9-16
Fuel Lines, Fuel Hoses And Connections .....	9-16
Propeller Shaft And Related .....	9-17
Spark Plugs (For Gasoline Engine) .....	9-16
Suspension Mounting Bolts .....	9-17
teering Gear Box, Linkage & Boots/Lower Arm Ball Joint .....	9-17
Vapor Hose And Fuel Filler Cap .....	9-16
<b>Exterior Features</b> .....	5-131
Roof Side Rails .....	5-131
<b>Exterior Lights</b> .....	5-80
Battery Saver Function .....	5-83
Headlight Delay Function .....	5-83
Headlight Moisture Removal Function .....	5-83
High Beam Operation .....	5-82
Lighting Control .....	5-80
Turn Signals and Lane Change Signals .....	5-82
<b>Exterior Overview (Front View)</b> .....	2-2
<b>Exterior Overview (Rear View)</b> .....	2-4

## F

<b>Fingerprint Authentication System</b> .....	5-24
Fingerprint Authentication System Operation .....	5-25
Fingerprint Authentication System Settings .....	5-24
Limitations of the System .....	5-26
When Purchasing a Used Vehicle .....	5-26
<b>Foreword</b> .....	1-1
<b>Forward Attention Warning (FAW)</b> .....	7-57
Forward Attention Warning Malfunction And Limitations .....	7-59
Forward Attention Warning Operation .....	7-58
Forward Attention Warning Settings .....	7-57
<b>Forward Collision-Avoidance Assist (FCA)</b> .....	7-7

Forward Collision-Avoidance Assist Malfunction And Limitations .....	7-21
Forward Collision-Avoidance Assist Operation .....	7-12
Forward Collision-Avoidance Assist Settings .....	7-10
<b>Forward/Side/Reverse Parking Collision-Avoidance Assist (PCA)</b> .....	7-116
Parking Collision-Avoidance Assist Malfunction And Limitations .....	7-118
Parking Collision-Avoidance Assist Operation .....	7-117
Parking Collision-Avoidance Assist Settings .....	7-116
<b>Fuel Filler Door</b> .....	5-74
Closing the Fuel Filler Door .....	5-75
Opening the Fuel Filler Door .....	5-74
<b>Fuel requirements</b> .....	1-8
<b>Fuses</b> .....	9-46
Engine Compartment Panel Fuse Replacement .....	9-48
Fuse/Relay Panel Description .....	9-49
Instrument Panel Fuse Replacement .....	9-47

## G

<b>Genesis customer care</b> .....	1-2
<b>Genesis Digital Key</b> .....	5-12
Digital Key (Card Key) .....	5-18
Digital Key (Smartphone) .....	5-12
Limitations of the System .....	5-23
Used Vehicle/Digital Key Maintenance .....	5-23
<b>Guide to Genesis Parts</b> .....	1-3

## H

<b>Hazard Warning Flasher</b> .....	8-2
<b>Head-Up Display (HUD)</b> .....	5-76
Head-Up Display Information .....	5-77
Head-Up Display Settings .....	5-76
Precautions While Using the Head-Up Display .....	5-77
<b>High Beam Assist (HBA)</b> .....	5-84
High Beam Assist Malfunction and Limitations .....	5-85
High Beam Assist Operation .....	5-84
High Beam Assist Setting .....	5-84
<b>Highway Driving Assist (HDA)</b> .....	7-86
Highway Driving Assist Malfunction And Limitations .....	7-93
Highway Driving Assist Operation .....	7-88
Highway Driving Assist Settings .....	7-86
Highway Lane Change Assist .....	7-90
<b>Hood</b> .....	5-65
Closing the Hood .....	5-65
Opening the Hood .....	5-65
<b>How to Use This Manual</b> .....	1-6

## I

<b>Idle Stop and Go (ISG)</b> .....	6-42
Calibrating the Battery Sensor .....	6-45
Conditions that Restart the Engine .....	6-44

ISG Malfunction .....	6-45
ISG System Off .....	6-44
ISG System Operation .....	6-42
<b>If the Engine Does Not Start</b> .....	8-3
<b>If the Engine Overheats</b> .....	8-7
<b>If You Have a Flat Tire (With Spare Tire)</b> .....	8-12
Changing Tires .....	8-13
Jack And Tools .....	8-12
Jack Label .....	8-18
<b>If You Have a Flat Tire (With Tire Mobility Kit)</b> .....	8-19
Components of the Tire Mobility Kit .....	8-21
How to Adjust Tire Pressure .....	8-25
Introduction .....	8-19
Notes On the Safe Use of the Tire Mobility Kit .....	8-20
Using the Tire Mobility Kit .....	8-22
<b>Important Safety Precautions</b> .....	3-2
Airbag Hazards .....	3-2
Always Wear Your Seat Belt .....	3-2
Control Your Speed .....	3-3
Driver Distraction .....	3-2
Keep Your Vehicle in Safe Condition .....	3-3
Never Drink or Take Drugs and Drive .....	3-2
Restrain All Children .....	3-2
<b>In Case of an Emergency While Driving</b> .....	8-2
If the Engine Stalls At a Crossroad or Crossing .....	8-2
If the Engine Stalls While Driving .....	8-2
If You Have a Flat Tire While Driving .....	8-3
<b>Infotainment System</b> .....	5-132
Antenna .....	5-133
BANG & OLUFSEN Sound System .....	5-135
Bluetooth® Wireless Technology .....	5-134
Infotainment System .....	5-134
Steering Wheel Remote Controls .....	5-133
USB Port .....	5-132
Voice Recognition .....	5-134
<b>Instrument Cluster</b> .....	4-1, 4-2
Cluster Display Messages .....	4-20
Gauges and Meters .....	4-3
Instrument Cluster Control .....	4-3
Transmission Shift Indicator .....	4-7
Warning and Indicator Lights .....	4-7
<b>Integrated Memory System</b> .....	5-35
Recalling Memory Positions .....	5-36
Resetting the System .....	5-36
Seat Easy Access .....	5-37
Storing Memory Positions .....	5-36
<b>Intelligent Speed Limit Assist (ISLA)</b> .....	7-49
Intelligent Speed Limit Assist Malfunction And Limitations .....	7-51
Intelligent Speed Limit Assist Operation .....	7-50
Intelligent Speed Limit Assist Settings .....	7-49

<b>Interior Features</b> .....	5-119
AC Inverter .....	5-123
Armrest Warmer .....	5-120
Ashtray .....	5-120
Cargo Net Holder .....	5-129
Cargo Security Screen .....	5-129
Cargo Shelf .....	5-130
Clock .....	5-126
Coat Hook .....	5-126
Cup Holder .....	5-119
Floor Mat Anchor(s) .....	5-127
Power Outlet .....	5-121
Rear Mirror .....	5-121
Rear Side Window Sunshades .....	5-127
Sunvisor .....	5-121
USB Charger .....	5-122
Wireless Smartphone Charging System .....	5-124
<b>Interior Lights</b> .....	5-87
Cargo Area Lamp .....	5-89
Door Handle Lamp/Foot Lamp/Door Courtesy Lamp .....	5-89
Front Lamps .....	5-87
Glove Box Lamp .....	5-88
Interior Light AUTO Cut .....	5-87
Interior Lights Always On .....	5-89
Mood Lamp .....	5-89
Puddle Light .....	5-90
Rear Mirror Lamp .....	5-88
Rear Room Lamp .....	5-88
Vanity Mirror Lamp .....	5-88
<b>Interior Overview</b> .....	2-6
<b>Introduction</b> .....	1-2

**J**

<b>Jump Starting</b> .....	8-4
----------------------------	-----

**L**

<b>Lane Following Assist (LFA)</b> .....	7-83
Lane Following Assist Malfunction And Limitations .....	7-85
Lane Following Assist Operation .....	7-83
Lane Following Assist Settings .....	7-83
<b>Lane Keeping Assist (LKA)</b> .....	7-29
Lane Keeping Assist Malfunction and Limitations .....	7-32
Lane Keeping Assist Operation .....	7-30
Lane Keeping Assist Settings .....	7-29
<b>LED Lights</b> .....	9-66
Headlight, Parking Light, Turn Signal Light, Daytime Running Light (DRL) Replacement ..	9-67
High Mounted Stop Light Replacement .....	9-69
Interior Light Replacement .....	9-70
License Plate Light Replacement .....	9-70

Puddle Light Replacement .....	9-68
Rear Combination Light Replacement .....	9-68
Reverse Light Replacement .....	9-69
Side Repeater Light Replacement .....	9-68

## M

<b>Maintenance</b> .....	9-1
<b>Maintenance Services</b> .....	9-6
Owner Maintenance Precautions .....	9-6
Owner's Responsibility .....	9-6
<b>Manual Speed Limit Assist (MSLA)</b> .....	7-47
Manual Speed Limit Assist Operation .....	7-47
<b>Mirrors</b> .....	5-42
Inside Side View Mirror .....	5-42
Reverse Parking Aid .....	5-57
Side View Mirrors .....	5-55

## N

<b>Navigation-based Smart Cruise Control (NSCC)</b> .....	7-78
Limitations of Navigation-Based Smart Cruise Control .....	7-80
Navigation-based Smart Cruise Control Operation .....	7-78
Navigation-based Smart Cruise Control Settings .....	7-78

## O

<b>Open Source Software Notice</b> .....	2-24
<b>OTA Software Update</b> .....	5-78
Approving Software Update .....	5-78
Downloading Software .....	5-78
Preparing Software Update .....	5-78
Updating Software .....	5-79
<b>Owner Maintenance</b> .....	9-7
Owner Maintenance Schedule .....	9-7

## P

<b>Panoramic Sunroof</b> .....	5-61
Power Sunshade .....	5-61
Resetting the Sunroof .....	5-64
Slide Open/Close .....	5-62
Sunroof Open Warning .....	5-64
Tilt Open/Close .....	5-62
<b>Parking Distance Warning (PDW)</b> .....	7-111
Parking Distance Warning Malfunction And Limitations .....	7-114
Parking Distance Warning Operation .....	7-112
Parking Distance Warning Settings .....	7-111
<b>Power Liftgate</b> .....	5-66
Emergency Liftgate Safety Release .....	5-71
Operating the Power Liftgate .....	5-68
Power Liftgate Operating Conditions .....	5-66
Resetting the Power Liftgate .....	5-71

Setting the Power Liftgate ..... 5-70

**R**

**Rear Cross-Traffic Collision-Avoidance Assist (RCCA)** ..... 7-103  
 Rear Cross-Traffic Collision-Avoidance Assist Malfunction And Limitations ..... 7-107  
 Rear Cross-Traffic Collision-Avoidance Assist Operation ..... 7-104  
 Rear Cross-Traffic Collision-Avoidance Assist Settings ..... 7-103  
**Rear View Monitor (RVM)** ..... 7-95  
 Rear View Monitor Malfunction And Limitations ..... 7-97  
 Rear View Monitor Operation ..... 7-96  
 Rear View Monitor Settings ..... 7-95  
**Recommended Lubricants and Capacities** ..... 2-17  
**Recommended lubricants and capacities**  
 Recommended SAE viscosity number ..... 2-19  
**Reference Weight and Distance When Towing a Trailer** ..... 2-16  
**Remote Smart Parking Assist 2 (RSPA 2)** ..... 7-121  
 Remote Smart Parking Assist Malfunction And Limitations ..... 7-138  
 Remote Smart Parking Assist Operation ..... 7-124  
 Remote Smart Parking Assist Settings ..... 7-123  
**Remote Start** ..... 6-9  
**Reporting Safety Defects** ..... 2-23  
**Road Active Noise Control** ..... 6-50  
 System Malfunction ..... 6-50

**S**

**Safe Exit Assist (SEA)** ..... 7-42  
 Safe Exit Assist Malfunction And Limitations ..... 7-45  
 Safe Exit Assist Operation ..... 7-44  
 Safe Exit Assist Settings ..... 7-42  
**Safety messages** ..... 1-7  
**Safety System** ..... 3-1  
**Scheduled Maintenance Services** ..... 9-8  
 Maintenance Under Severe Usage Conditions ..... 9-14  
 Normal Maintenance Schedule ..... 9-10  
 Normal Maintenance Schedule (Cont.) ..... 9-12  
**Seat Belts** ..... 3-31  
 Additional Seat Belt Safety Precautions ..... 3-39  
 Care of Seat Belts ..... 3-41  
 Pre-Active Seat Belt (PSB) ..... 3-38  
 Seat Belt Restraint System ..... 3-34  
 Seat Belt Safety Precautions ..... 3-31  
 Seat Belt Warning Light ..... 3-32  
**Seats** ..... 3-4  
 Air Ventilation Seats ..... 3-29  
 Front Seats ..... 3-9  
 Head restraint ..... 3-22  
 Rear Seats ..... 3-13  
 Safety Precautions ..... 3-8  
 Seat Warmers ..... 3-26

<b>Semi Active Engine Mount</b> .....	6-51
<b>Smart Cruise Control (SCC)</b> .....	7-62
Smart Cruise Control Malfunction And Limitations .....	7-71
Smart Cruise Control Operation .....	7-64
Smart Cruise Control Settings .....	7-62
<b>Smart Liftgate</b> .....	5-72
Deactivating Smart Liftgate .....	5-73
Detecting Area .....	5-73
Using Smart Liftgate .....	5-72
<b>Smart Posture Care System</b> .....	5-38
<b>Special Driving Conditions</b> .....	6-51
Driving at Night .....	6-52
Driving in Flooded Areas .....	6-53
Driving in the Rain .....	6-53
Hazardous Driving Conditions .....	6-51
Highway Driving .....	6-53
Reducing the Risk of a Rollover .....	6-54
Rocking the Vehicle .....	6-52
Smooth Cornering .....	6-52
<b>Steering Wheel</b> .....	5-38
Haptic Warning / Steering Wheel Vibration Warning .....	5-42
Heated Steering Wheel .....	5-40
Horn .....	5-40
Motor Driven Power Steering (MDPS) .....	5-38
Steering Wheel Grip Sensor .....	5-41
Tilt / Telescopic Steering .....	5-39
<b>Steering Wheel Control Overview</b> .....	2-9
<b>Storage Compartment</b> .....	5-117
Cargo Tray .....	5-119
Center Console Storage .....	5-117
Glove Box .....	5-118
Rear Console Storage .....	5-118
Storage Box .....	5-119
Sunglass Holder .....	5-118
<b>Supplemental Restraint System - Airbags</b> .....	3-50
Additional Safety Precautions .....	3-70
Airbag Warning Labels .....	3-70
Do Not Install a Child Restraint System on the Front Passenger Seat .....	3-64
How Does the Airbags System Operate? .....	3-55
Occupant Classification System (OCS) .....	3-59
SRS Care .....	3-69
What to Expect After an Airbag Inflates .....	3-58
Where are the Airbags? .....	3-51
Why Didn't My Airbag Go Off in a Collision? .....	3-65
<b>Surround View Monitor (SVM)</b> .....	7-98
Surround View Monitor Malfunction And Limitations .....	7-102
Surround View Monitor Operation .....	7-99
Surround View Monitor Settings .....	7-98

**T**

**Theft Alarm System** ..... 5-32

**Tire Pressure Monitoring System (TPMS)** ..... 8-8

    Changing a Tire With TPMS ..... 8-11

    Check Tire Pressure ..... 8-8

    Low Tire Pressure Position And Tire Pressure Telltale ..... 8-10

    Tire Pressure Monitoring System ..... 8-9

    TPMS (Tire Pressure Monitoring System) Malfunction Indicator ..... 8-11

**Tire Specification and Pressure Label** ..... 2-21

**Tires and Wheels** ..... 2-14, 9-34

    All Season Tires ..... 9-44

    Check Tire Inflation Pressure ..... 9-35

    Low Aspect Ratio Tires ..... 9-44

    Radial-Ply Tires ..... 9-45

    Recommended Cold Tire Inflation Pressures ..... 9-34

    Snow Tires ..... 9-45

    Summer Tires ..... 9-45

    Tire Care ..... 9-34

    Tire Maintenance ..... 9-38

    Tire Replacement ..... 9-37

    Tire Rotation ..... 9-36

    Tire Sidewall Labeling ..... 9-38

    Tire Terminology and Definitions ..... 9-41

    Tire Traction ..... 9-38

    Wheel Alignment and Tire Balance ..... 9-36

    Wheel Replacement ..... 9-38

**Towing** ..... 8-26

    Emergency Towing ..... 8-27

    Removable Towing Hook ..... 8-27

    Towing Service ..... 8-26

**Trailer Towing** ..... 6-60

    Driving With a Trailer ..... 6-64

    If You Decide to Pull a Trailer ..... 6-60

    Maintenance When Towing a Trailer ..... 6-66

    Trailer Towing Equipment ..... 6-63

**V**

**Vehicle Auto-Shut Off** ..... 6-10

    Deactivating Conditions ..... 6-10

    Operating Conditions ..... 6-10

    System Operation ..... 6-10

**Vehicle break-in process** ..... 1-10

**Vehicle Certification Label** ..... 2-21

**Vehicle Data Collection And Event Data Recorders** ..... 1-11

**Vehicle Identification Number (VIN)** ..... 2-21

**Vehicle Information, Consumer Information and Reporting Safety Defects** ..... 2-1

**Vehicle Load Limit** ..... 6-66

    The Loading Information Label ..... 6-67

**Vehicle modifications** ..... 1-10



<b>Vehicle Settings (Infotainment System)</b> .....	4-30
Setting Your Vehicle .....	4-30
<b>Vehicle Weight and Luggage Volume</b> .....	2-16

## W

<b>Washer Fluid</b> .....	9-24
Checking the Washer Fluid Level .....	9-24
<b>Welcome System</b> .....	5-86
Interior Light .....	5-87
Puddle Light and Door Handle Light .....	5-86
<b>Windows</b> .....	5-58
Power Windows .....	5-59
<b>Windshield Defrosting and Defogging</b> .....	5-112
Rear Window Defroster .....	5-113
To Defog Inside Windshield .....	5-112
To Defrost Outside Windshield .....	5-113
<b>Winter Driving</b> .....	6-54
Snow or Icy Conditions .....	6-54
Winter Precautions .....	6-58
<b>Wiper Blades</b> .....	9-27
Blade Inspection .....	9-27
Blade Replacement .....	9-27
<b>Wipers and Washers</b> .....	5-90
Front Windshield Washers .....	5-91
Front Windshield Wipers .....	5-90
Rear Window Wiper and Washer .....	5-92