



2024

ES 300h

OWNER'S MANUAL QUICK GUIDE

Contents

The Quick Guide is not intended as a substitute for your *OWNER'S MANUAL*. We strongly encourage you to review the *OWNER'S MANUAL* and supplementary manuals so you will have a better understanding of your vehicle's capabilities and limitations.

Pictorial Index	3
For safe use	
Floor Mat Installation.....	11
Hybrid System	
Hybrid System.....	12
Entering and Exiting	
Keys.....	15
Smart Access System with Push-button Start.....	17
When Driving	
Front Seats.....	19
Power (Ignition) Switch.....	20
EV Drive Mode.....	23
Hybrid Transmission.....	24
Turn Signal Lever.....	27
Parking Brake.....	28
Brake Hold.....	30
Multi-information Display.....	31
Head-up Display.....	34
Headlights.....	37
AHB (Automatic High Beam).....	38
Windshield Wipers and Washer.....	40

Driving Comfort

Energy Monitor/Consumption Screen	42
Basic Operation of Multimedia System	45
Navigation *	46
Connecting a Smartphone or Communication Device *	50
Basic Operation of Audio System *	55
Lexus Climate Concierge	60
Automatic Air Conditioning System *	61

Interior features

Starting Voice Control *	64
Connecting to the USB Port	68
Garage Door Opener	69

Lexus Enform

Safety Connect	74
Remote Connect	76
Service Connect	77

Opening and Closing

Door Locks	78
Fuel Tank Cap	79

What to do if...

List of Warning/Indicator Lights	81
If the electronic key does not operate properly	85
If the hybrid system will not start	87

*: These features may be operated by Starting Voice Control (See P.64)

Depending on specifications, the vehicle shown in the illustration may differ from your vehicle in terms of equipment.

Pictorial Index

Instrument panel

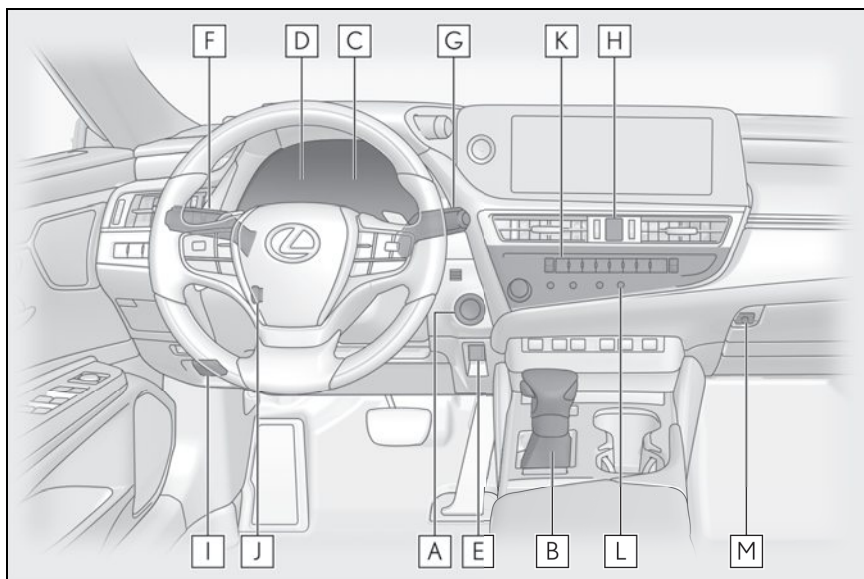

A	Power switch	P.20
	Starting the hybrid system/changing the mode	P.20, 21
	Emergency stop of the hybrid system	P.22
	When the hybrid system will not start.....	P.86
	Warning messages ^{*1}	
B	Shift lever	P.24
	Changing the shift position.....	P.24
	Precautions against towing ^{*1}	
	When the shift lever does not move ^{*1}	
C	Meters ^{*1}	
	Reading the meters/adjusting the instrument panel lights ^{*1}	
	Warning lights/indicator lights.....	P.81
	When the warning lights come on ^{*1}	
D	Multi-information display	P.31
	Display.....	P.31
	Energy monitor.....	P.42
	When the warning messages are displayed ^{*1}	

E	Parking brake switch	P.28
	Applying/releasing.....	P.28
	Precautions against winter season ^{*1}	
	Warning buzzer/message ^{*1}	
F	Turn signal lever	P.27
	Headlight switch	P.37
	Headlights/parking lights/tail lights/daytime running lights.....	P.37
	AHB (Automatic High Beam).....	P.38
G	Windshield wiper and washer switch	P.40
	Usage.....	P.40
	Adding washer fluid ^{*1}	
	Warning messages ^{*1}	
H	Emergency flasher switch ^{*1}	
I	Hood lock release lever ^{*1}	
J	Tilt and telescopic steering control switch ^{*1,2} /tilt and telescopic steering lock release lever ^{*1,2}	
	Adjustment ^{*1}	
	Driving position memory ^{*1,2}	
K	Air conditioning system	P.61
	Usage.....	P.62
	Rear window defogger.....	P.61
L	Audio system	P.55
M	Trunk opener main switch ^{*1}	

*1: Refer to "OWNER'S MANUAL".

*2: If equipped

■ Switches

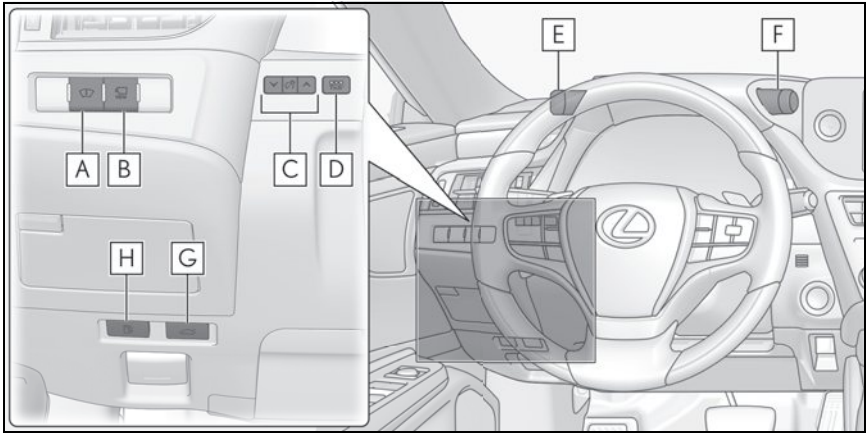

- A** Head-up display switch ^{*1} P.34
- B** Camera switch ^{*1,2}
- C** Instrument panel light control switches ^{*3}
- D** “ODO TRIP” switch ^{*3}
- E** VSC OFF switch ^{*3}
- F** Driving Mode Select switch ^{*3}
- G** Trunk opener switch ^{*3}
- H** Fuel filler door opener switch P.79

^{*1}: If equipped

^{*2}: Refer to “MULTIMEDIA OWNER’S MANUAL”.

^{*3}: Refer to “OWNER’S MANUAL”.

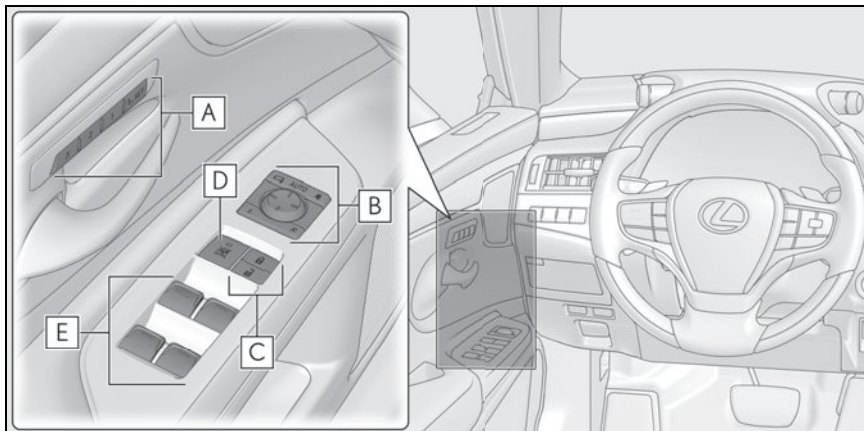

- A** Driving position memory switches *1,2
- B** Outside rear view mirror switches *2
- C** Door lock switches P.78
- D** Window lock switch *2
- E** Power window switches *2

*1: If equipped

*2: Refer to "OWNER'S MANUAL".

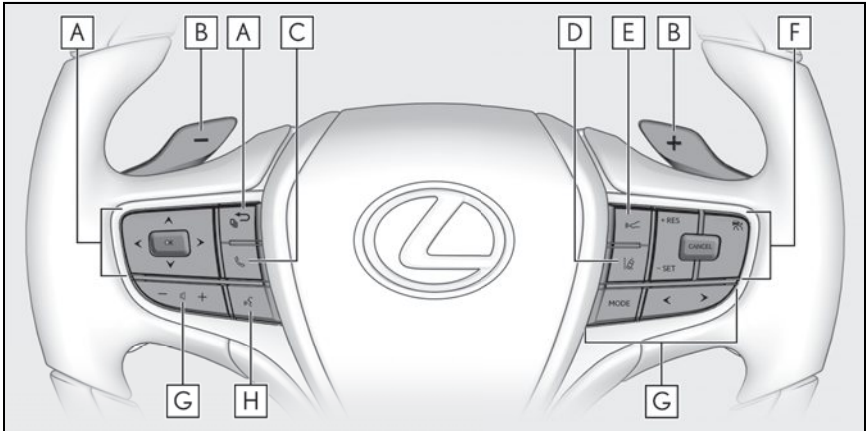

- A** Meter control switches P.33
- B** Paddle shift switches P.25, 26
- C** TEL switch P.52
- D** LTA (Lane Tracing Assist) switch *
- E** Vehicle-to-vehicle distance switch *
- F** Cruise control switches *
 Dynamic radar cruise control with full-speed range *
- G** Audio remote control switches P.52, 57, 59
- H** Talk switch P.52

*: Refer to "OWNER'S MANUAL".

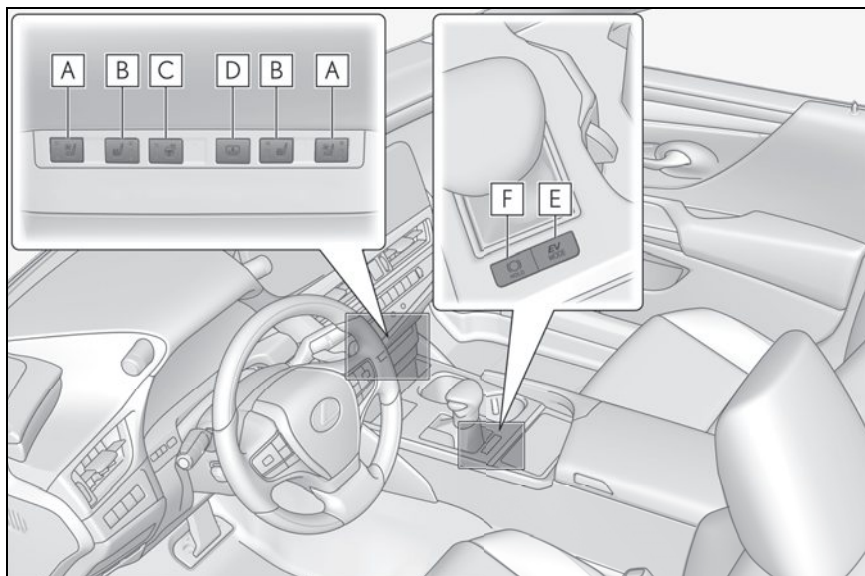

A Seat ventilator switches *1,2

B Seat heater switches *1,2

C Heated steering wheel switch *1,2

D Rear sunshade switch *1,2

E EV drive mode switch P.23

F Brake hold switch P.30

*1: If equipped

*2: Refer to "OWNER'S MANUAL".

■ Interior

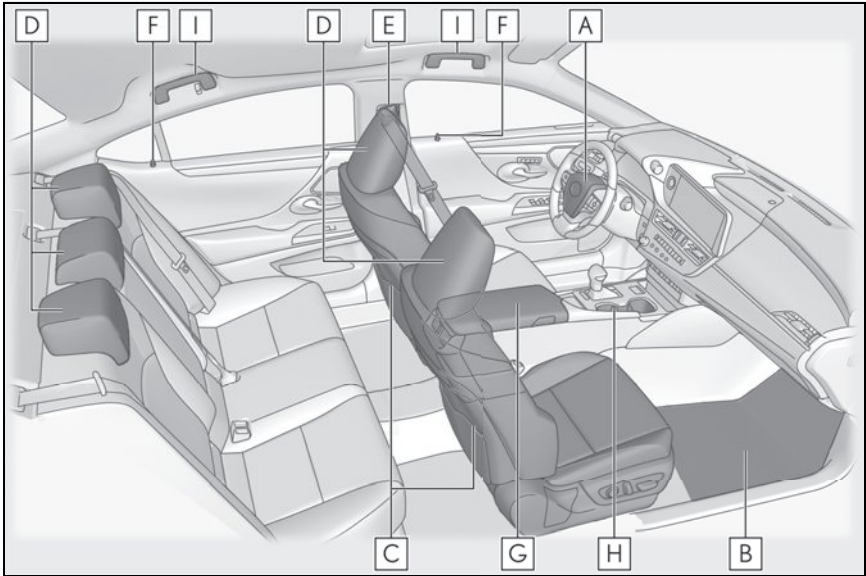

- A** SRS airbags*
- B** Floor mats P.11
- C** Front seats P.19
- D** Head restraints*
- E** Seat belts*
- F** Inside lock buttons P.78
- G** Console box*
- H** Cup holder*
- I** Assist grips*

*: Refer to "OWNER'S MANUAL".

■ Ceiling

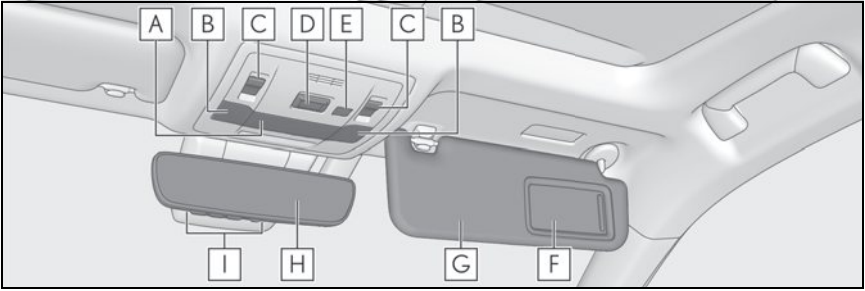

- A** Interior lights *
- B** Personal lights *
- C** Moon roof switches *
- D** "SOS" button P.74
- E** Door-linked personal light switch *
- F** Vanity mirrors *
- G** Sun visors *
- H** Inside rear view mirror*
- I** Garage door opener buttons P.69

*: Refer to "OWNER'S MANUAL".

Floor Mat Installation

Use only floor mats designed specifically for vehicles of the same model and model year as your vehicle. Fix them securely in place onto the carpet.

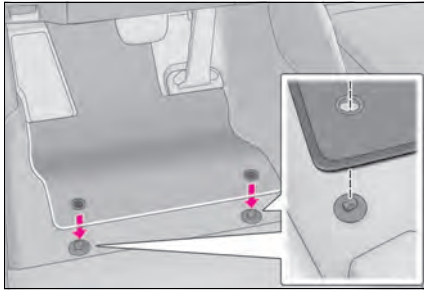

- 1 Insert the retaining hooks (clips) into the floor mat eyelets.

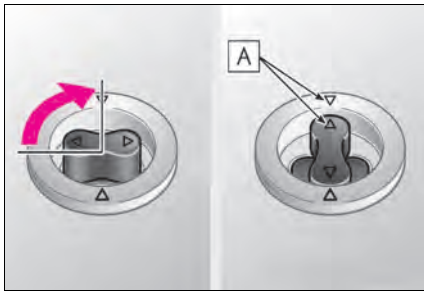

- 2 Turn the upper knob of each retaining hook (clip) to secure the floor mats in place.

Always align the \triangle marks **A**.

The shape of the retaining hooks (clips) may differ from that shown in the illustration.

Hybrid System

Your vehicle is a Hybrid Electric Vehicle. It has characteristics different from conventional vehicles. Be sure you are closely familiar with the characteristics of your vehicle, and operate it with care.

The hybrid system combines the use of a gasoline engine and an electric motor (traction motor) according to driving conditions, improving fuel efficiency and reducing exhaust emissions.

For details, refer to the "OWNER'S MANUAL".

Hybrid System Indicator

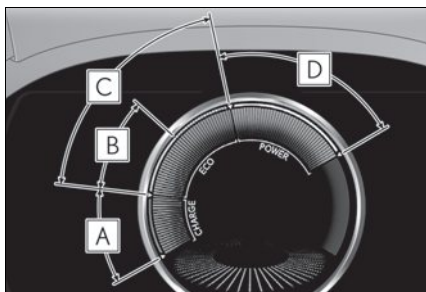

A Charge area

Shows regeneration* status. Regenerated energy will be used to charge the hybrid battery (traction battery).

*: When used in this manual, regeneration refers to the conversion of energy created by the movement of the vehicle into electrical energy.

B Hybrid Eco area

Shows that gasoline engine power is not being used very often.

The gasoline engine will automatically stop and restart under various conditions.

C Eco area

Shows that the vehicle is being driven in an Eco-friendly manner.

By keeping the bar display within Eco area, more Eco-friendly driving can be achieved.

D Power area

Shows that an Eco-friendly driving range is being exceeded (during full power driving etc.)

Hybrid battery (traction battery) charge

If the shift lever is in N, the hybrid battery (traction battery) will not be charged even when the engine is running. Therefore, if the vehicle is left with the shift lever in N for a certain period of time, the hybrid battery (traction battery) will discharge, and this may result in the vehicle not being able to start.

Regenerative braking

In the following situations, kinetic energy is converted to electric energy and deceleration force can be obtained in conjunction with the recharging of the hybrid battery (traction battery).

- The accelerator pedal is released while driving with the shift lever in D or S.
- The brake pedal is depressed while driving with the shift lever in D or S.

Sounds and vibrations specific to a Hybrid Electric Vehicle

There may be no engine sound or vibration even though the vehicle is able to move with the "READY" indicator is illuminated. For safety, apply the parking brake and make sure to shift the shift lever to P when parked.

The following sounds or vibrations may occur when the hybrid system is operating and are not a malfunction:

- Motor sounds may be heard from the engine compartment.
- Sounds may be heard from the hybrid battery (traction battery) under the rear seats when the hybrid system starts or stops.
- Relay operating sounds such as a snap or soft clank will be emitted from the hybrid battery (traction battery), under the rear seats, when the hybrid system is started or stopped.
- Sounds from the hybrid system may be heard when the trunk lid is open.
- Sounds may be heard from the transmission when the gasoline engine starts or stops, when driving at low speeds, or during idling.
- Engine sounds may be heard when accelerating sharply.
- Sounds may be heard due to regenerative braking when the brake pedal is depressed or as the accelerator pedal is released.
- Vibration may be felt when the gasoline engine starts or stops.
- Cooling fan sounds may be heard from the air intake vent under the rear seat.

Running out of fuel

When the vehicle has run out of fuel and the hybrid system cannot be started, refuel the vehicle with at least enough gasoline to make the low fuel level warning light go off. If there is only a small amount of fuel, the hybrid system may not be able to start. (The standard amount of fuel is about 2.4 gal. [9.0 L, 2.0 Imp.gal.], when the vehicle is on a level surface. This value may vary when the vehicle is on a slope. Add extra fuel when the vehicle is inclined.)

Hybrid warning message

A message is automatically displayed when a malfunction occurs in the hybrid system or an improper operation is attempted.

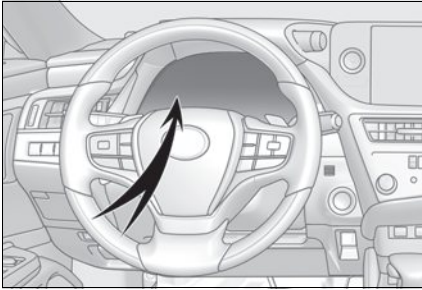

If a warning message is shown on the multi-information display, read the message and follow the instructions.

Keys

Electronic key



- Smart access system with push-button start (→P.17)
- Wireless remote control

Mechanical key

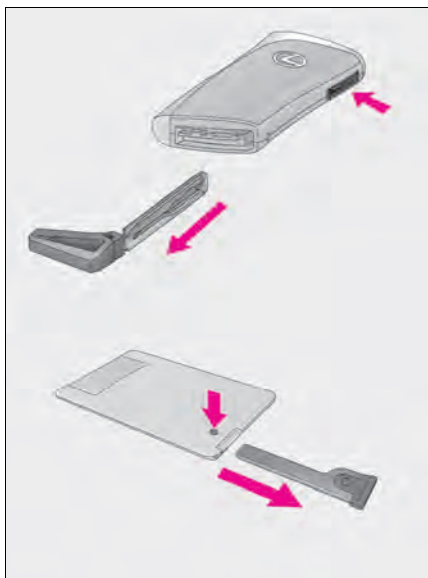

To take out the mechanical key, push the release button and take the key out.

The mechanical key can only be inserted in one direction, as the key only has grooves on one side. If the key cannot be inserted in a lock cylinder, turn it over and re-attempt to insert it.

After using the mechanical key, store it in the electronic key. Carry the mechanical key together with the electronic key. If the electronic key battery is depleted or the entry function does not operate properly, you will need the mechanical key.

Wireless remote control

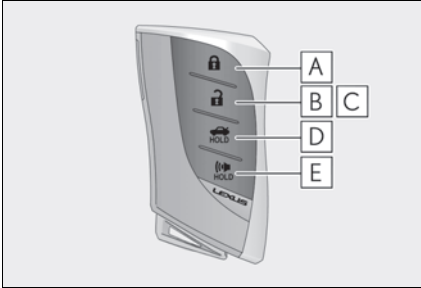

- A** Locks the doors
- B** Unlocks the doors
- C** Opens the windows and moon roof (press and hold)*
- D** Opens the trunk
- E** Sounds the alarm

*: This setting must be customized at your Lexus dealer.

Smart Access System with Push-button Start

The following operations can be performed simply by carrying the electronic key (including the card key) on your person, for example in your pocket. The driver should always carry the electronic key.

For details on starting the hybrid system, see page 20.

Unlocking and locking the doors from the outside

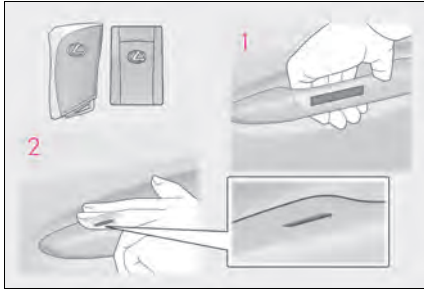

- 1** Grip the driver's door handle to unlock the door. Holding the driver's door handle for approximately 2 seconds unlocks all the doors. Grip the passenger's door handle to unlock all the doors.*

Make sure to touch the sensor on the back of the handle.

The doors cannot be unlocked for 3 seconds after the doors are locked.

*: The door unlock settings can be changed.

- 2** Touch the lock sensor (the indentation on the upper part of the door handle) to lock all the doors.

Check that the door is securely locked.

Opening the trunk

■ Using the outside button

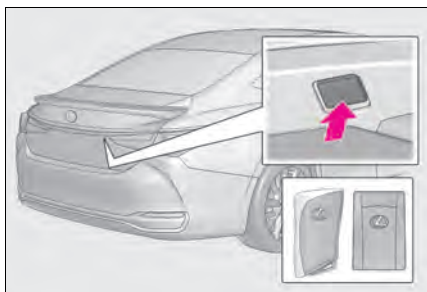

While carrying the electronic key, press the button.

When all the doors are unlocked using one of the following methods, the trunk can be opened without the electronic key:

- Entry function
- Wireless remote control
- Door lock switches
- Automatic door unlocking system
- Mechanical key

■ Using the Hands Free Power Trunk Lid (vehicles with power trunk lid)

- 1 While carrying an electronic key, stand within the smart access system with push-button start operation range, approximately 11.8 to 19.7 in. (30 to 50 cm) from the rear bumper.

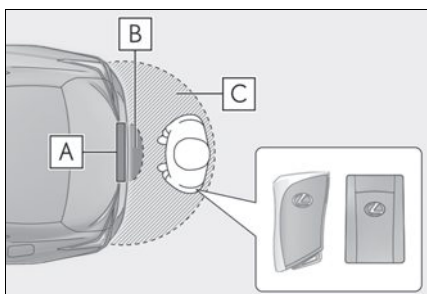

- A** Kick sensor
- B** Hands Free Power Trunk Lid operation detection area
- C** Smart access system with push-button start operation detection area

- 2 Perform a kick operation by moving your foot to within approximately 3.9 in. (10 cm) of the rear bumper, and then pulling your foot back after the buzzer sounds.

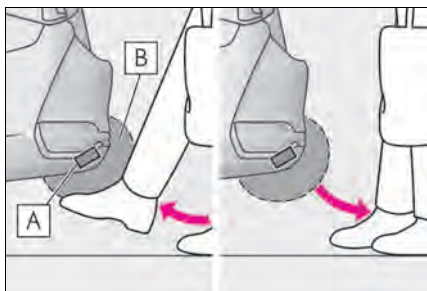

- A** Kick sensor
- B** Hands Free Power Trunk Lid operation detection area

- 3 When the kick sensor detects that your foot is pulled back, a buzzer will sound and the trunk will automatically fully open/close.

For details on what to do when the electronic key does not operate properly, see page 85.

Front Seats

Adjustment procedure

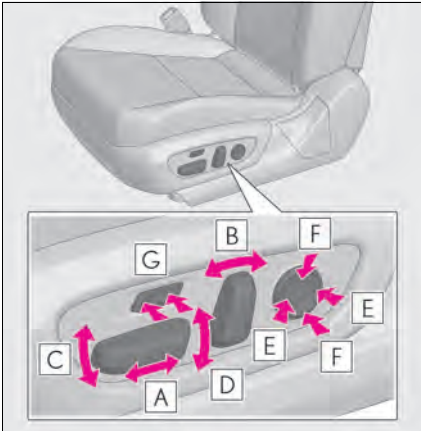

- A** Seat position adjustment
- B** Seatback angle adjustment
- C** Seat cushion (front) angle adjustment
- D** Vertical height adjustment
- E** Lumbar support adjustment
- F** Pelvic support adjustment (if equipped for driver's side)
- G** Seat cushion length adjustment (if equipped)

Power (Ignition) Switch

Performing the following operations when carrying the electronic key on your person starts the hybrid system or changes power switch modes.

Starting the hybrid system

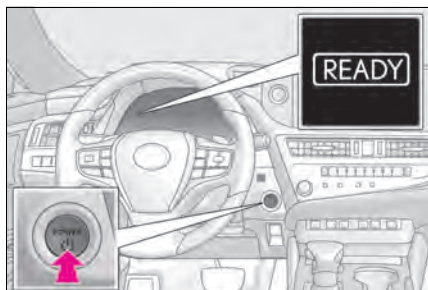

- 1 Press the parking brake switch to check that the parking brake is set. (→P.28)

Parking brake indicator will come on.

- 2 Check that the shift lever is in P.
- 3 Firmly depress the brake pedal.



and a message will be displayed on the multi-information display. If it is not displayed, the hybrid system cannot be started.

- 4 Press the power switch shortly and firmly.

When operating the power switch, one short, firm press is enough. It is not necessary to press and hold the switch.

If the "READY" indicator turns on, the hybrid system will operate normally. Continue depressing the brake pedal until the "READY" indicator is illuminated.

The hybrid system can be started from any power switch mode.

- 5 Check that the "READY" indicator is illuminated.

The vehicle will not move when the "READY" indicator is off.

Stopping the hybrid system

- 1 Stop the vehicle completely.
- 2 Set the parking brake (→P.28), and shift the shift lever to P (→P.24).
- 3 Press the power switch.
- 4 Release the brake pedal and check that “ACCESSORY” or “IGNITION ON” is not shown on the meter.

Changing power switch modes

Modes can be changed by pressing the power switch with the brake pedal released. (The mode changes each time the switch is pressed.)

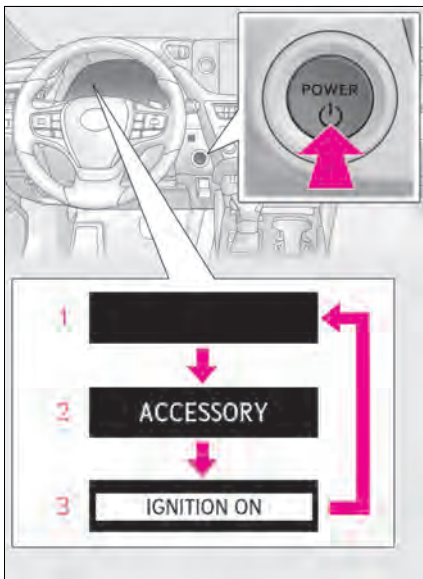

- 1 Off*
The emergency flashers can be used.
- 2 ACCESSORY mode
Some electrical components such as the audio system can be used.
“ACCESSORY” will be displayed on the meter.
- 3 ON mode
All electrical components can be used.
“IGNITION ON” will be displayed on the meter.

*: If the shift lever is in a position other than P when turning off the hybrid system, the power switch will be turned to ACCESSORY mode, not to off.

If your vehicle has to be stopped in an emergency

Only in an emergency, such as if it becomes impossible to stop the vehicle in the normal way, stop the vehicle using the following procedure:

- 1** Steadily step on the brake pedal with both feet and firmly depress it.
Do not pump the brake pedal repeatedly as this will increase the effort required to slow the vehicle.
- 2** Shift the shift lever to N.
- ▶ If the shift lever is shifted to N**
- 3** After slowing down, stop the vehicle in a safe place by the road.
- 4** Stop the hybrid system.
- ▶ If the shift lever cannot be shifted to N**
- 3** Keep depressing the brake pedal with both feet to reduce vehicle speed as much as possible.

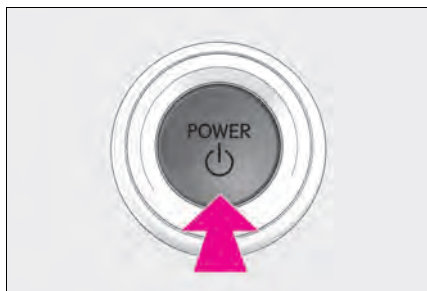

- 4** To stop the hybrid system, press and hold the power switch for 2 consecutive seconds or more, or press it briefly 3 times or more in succession.

- 5** Stop the vehicle in a safe place by the road.

EV Drive Mode

In EV drive mode, electric power is supplied by the hybrid battery (traction battery), and only the electric motor (traction motor) is used to drive the vehicle.

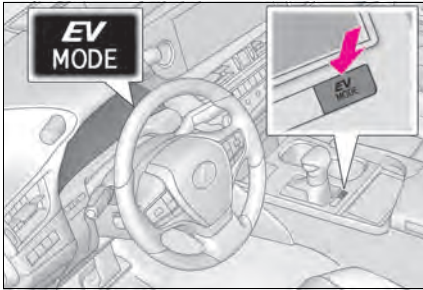

Turns EV drive mode on/off

When EV drive mode is turned on, the EV drive mode indicator will come on. Pressing the switch when in EV drive mode will return the vehicle to normal driving (using the gasoline engine and electric motor [traction motor]).

Hybrid Transmission

Shifting the shift lever

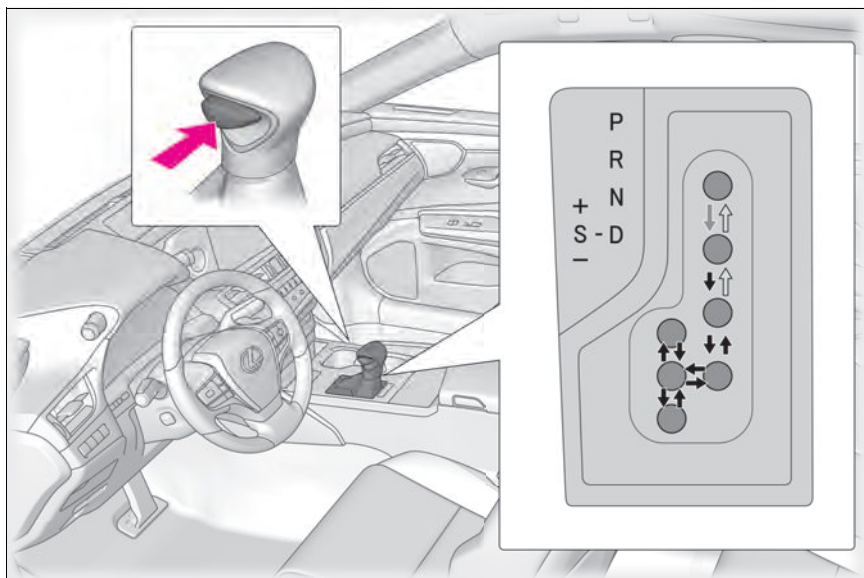

← While the power switch is in ON mode and the brake pedal depressed*, shift the shift lever while pushing the shift release button on the shift knob.

← Shift the shift lever while pushing the shift release button on the shift knob.

← Shift the shift lever normally.

When shifting the shift lever between P and D, make sure that the vehicle is completely stopped and the brake pedal is depressed.

*: For the vehicle be able to be shifted from P, the brake pedal must be depressed before the shift release button is pushed. If the shift release button is pushed first, the shift lock will not be released.

Shift position purpose and functions

Shift position	Objective or function
P	Parking the vehicle/starting the hybrid system
R	Reversing
N	Neutral
D	Normal driving ^{*1}
S	S mode driving ^{*2} (→P.26)

^{*1}: To improve fuel efficiency and reduce noise, set the shift lever in D for normal driving. You can choose shift range suitable for your driving situation by operating the paddle shift switches.

^{*2}: By selecting shift ranges using S mode, you can control accelerating force and engine braking forces.

Selecting shift ranges in D position

To drive using temporary shift range selection, operate the “-” paddle shift switch. The shift range can then be selected by operating the “-” and “+” paddle shift switches.

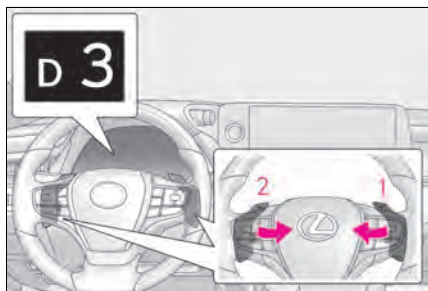

1 Upshifting

2 Downshifting

The selected shift range, from D1 to D6, will be displayed on the meter.

Selecting shift ranges in S mode

To enter S mode, shift the shift lever to S. Shift ranges can be selected by operating the shift lever or paddle shift switches, allowing you to drive in the shift range of your choosing.

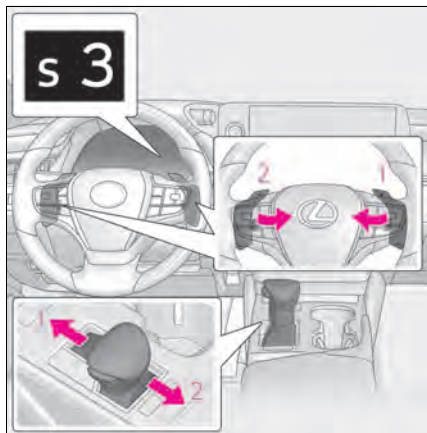

1 Upshifting

2 Downshifting

The selected shift range, from S1 to S6, will be displayed in the meter.

The initial shift range in S mode is set automatically to S5 or S4 according to vehicle's speed.

■ Shift ranges and their functions

- You can choose from 6 levels of accelerating force and engine braking force.
- A lower shift range will provide greater accelerating force and engine braking force than a higher shift range, and the engine revolutions will also increase.
- If you accelerate while in ranges S1 to S4, the shift range may automatically increase in accordance with the vehicle's speed.

Turn Signal Lever



- 1** Right turn
- 2** Lane change to the right (move the lever partway and release it)
The right hand signals will flash 3 times.
- 3** Lane change to the left (move the lever partway and release it)
The left hand signals will flash 3 times.
- 4** Left turn

Parking Brake

The parking brake can be set or released automatically or manually.

Using the manual mode

The parking brake can be set and released manually.

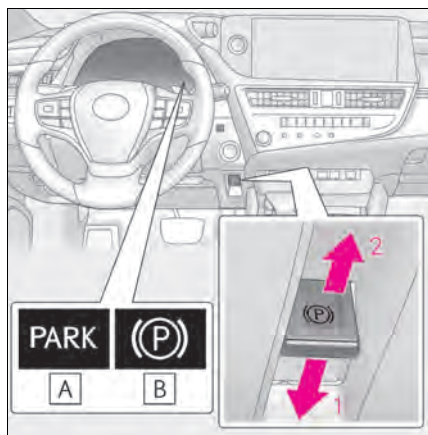

A U.S.A.

B Canada

1 Press the switch to set the parking brake

The parking brake indicator light will turn on.

Press and hold the parking brake switch if an emergency occurs and it is necessary to operate the parking brake while driving.

2 Pull the switch to release the parking brake

- Operate the parking brake switch while depressing the brake pedal.
- Using the parking brake automatic release function, the parking brake can be released by depressing the accelerator pedal. When using this function, slowly depress the accelerator pedal.

Make sure that the parking brake indicator light turn off.

Turning the automatic mode on

In automatic mode, the parking brake can be set or released automatically according to shift lever operation. Also, even in automatic mode, the parking brake can be set or released manually.

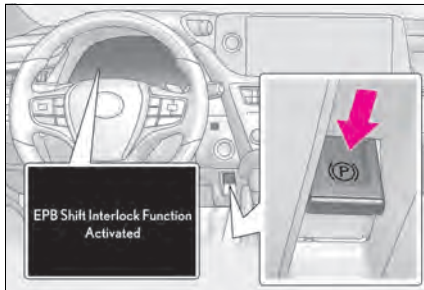

While the vehicle is stopped, press and hold the parking brake switch until a message is shown on the multi-information display

When the automatic mode is turned on, the parking brake operates as follows.

- When the shift lever is shifted from P, the parking brake will be released, and the parking brake indicator light will turn off.
- When the shift lever is shifted to P, the parking brake will be set, and the parking brake indicator light will turn on.

Operate the shift lever with the vehicle stopped and the brake pedal depressed.

Turning the automatic mode off

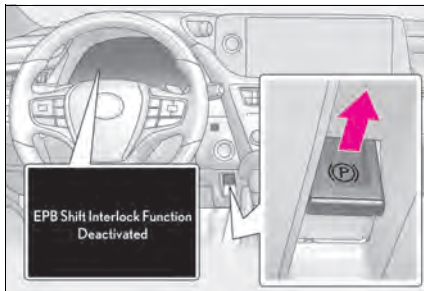

While the vehicle is stopped, pull and hold the parking brake switch until a message is shown on the multi-information display

Brake Hold

The brake hold system keeps the brake applied when the shift lever is in D, S or N with the system on and the brake pedal has been depressed to stop the vehicle. The system releases the brake when the accelerator pedal is depressed with the shift lever in D or S to allow smooth start off.

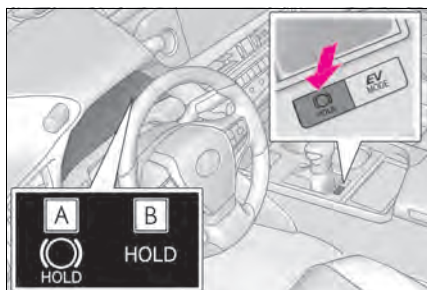

Turns the brake hold system on

The brake hold standby indicator (green)

A comes on. While the system is holding the brake, the brake hold operated indicator (yellow) **B** comes on.

Multi-information Display

The multi-information display presents the driver with a variety of vehicle data.

Display and menu icons

■ Display (except F SPORT models)



By selecting menu icons on the multi-information display, a variety of driving-related information can be displayed. The multi-information display can also be used to change display settings and other vehicle settings.

Warning or suggestion/advice pop-up displays are also displayed in certain situations.

■ Display (F SPORT models)

▶ Main meter in center position

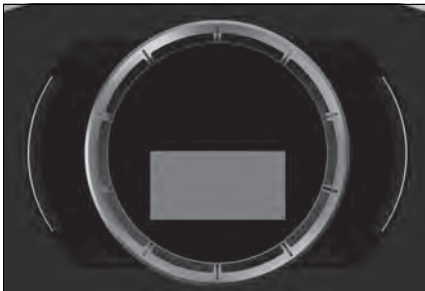

The multi-information display presents the driver with a variety of driving-related information.

Warning or suggestion/advice pop-up displays are also displayed in certain situations.

▶ Main meter moved to the right



By selecting menu icons on the multi-information display, a variety of driving-related information can be displayed.

The multi-information display can also be used to change display settings and other vehicle settings.

Warning or suggestion/advice pop-up displays are also displayed in certain situations.

■ Menu icons

The menu icons will be displayed by pressing  or  of the meter control switches.



Driving information display

Select to display various drive data.



Navigation system-linked display (if equipped)

Select to display the following navigation system-linked information.

- Route guidance to destination
- Compass display (heading-up display)



Audio system-linked display

Select to enable selection of an audio source or track on the meter using the meter control switches.



Driving support system information display

Select to display the operational status of the following systems:

- LTA (Lane Tracing Assist)
- Dynamic radar cruise control with full-speed range
- RSA (Road Sign Assist) (if equipped)



Warning message display

Select to display warning messages and measures to be taken if a malfunction is detected.





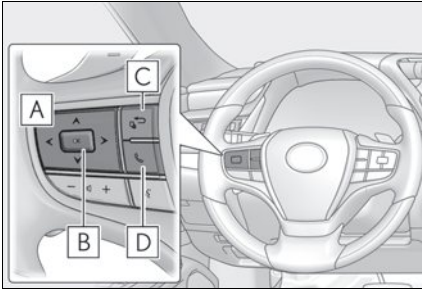

Settings display

Select to change the meter display settings

Changing the meter display



- A**  /  : Select menu icons
-  /  : Change displayed content, scroll up/down the screen and move the cursor up/down
- B** Press: Enter/Set
Press and hold: Reset
- C** Move the main meter* and return to the previous screen

- D** Call sending/receiving and history display
Linked with the hands-free system, sending or receiving call is displayed. For details regarding the hands-free system, refer to the "MULTIMEDIA OWNER'S MANUAL".

*:F SPORT models

Head-up Display (if equipped)

The head-up display projects a variety of driving-related information and the operating state of the driving support systems on the windshield.

System components

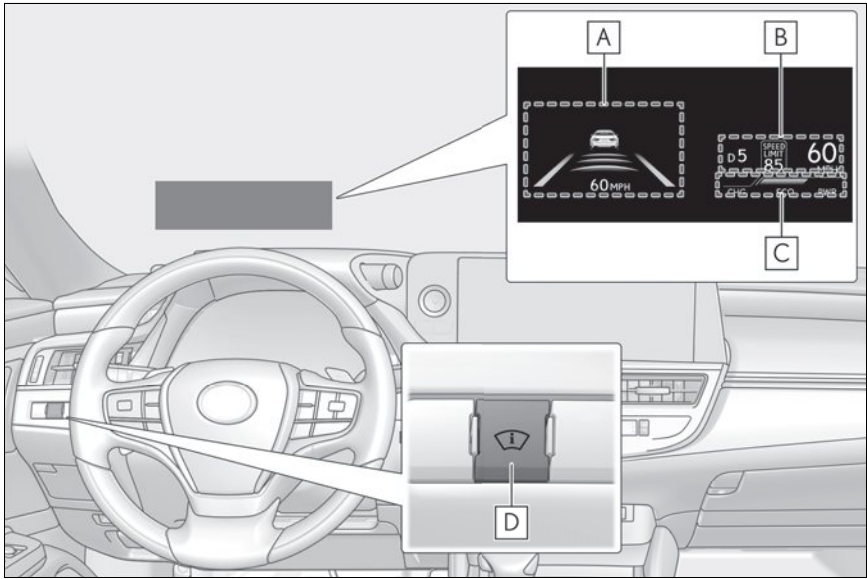

Illustrations used in this text are intended as examples, and may differ from the image that is actually displayed by the head-up display.

- A** Driving support system display area
Navigation system-linked display area (if equipped)
- B** Driving information display area
- C** Hybrid System Indicator/tachometer display area
- D** Head-up display switch

Using the head-up display

■ Enabling/Disabling the head-up display

Press the head-up display switch.

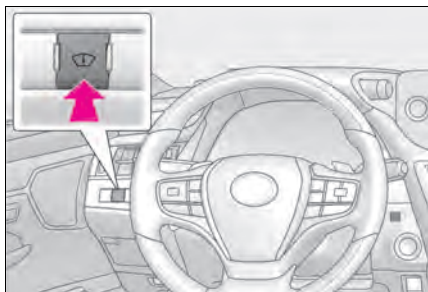

■ Changing settings of the head-up display

The following settings can be changed on  of the multi-information display. For details, refer to the "OWNER'S MANUAL".

- Brightness and vertical position of the head-up display
Select to adjust the brightness or vertical position of the head-up display.
- Hybrid System Indicator/tachometer
Select to display the Hybrid System Indicator, tachometer or no content.
- Display content
Select to enable/disable the following items:
 - Route guidance to destination/street name
 - Driving support system display *
 - Compass (heading-up display)
 - Audio system operation status*: Make sure to enable this display when using the driving support systems
- Display angle
Select to adjust the angle of the head-up display.

Hybrid System Indicator/tachometer display area

Hybrid System Indicator

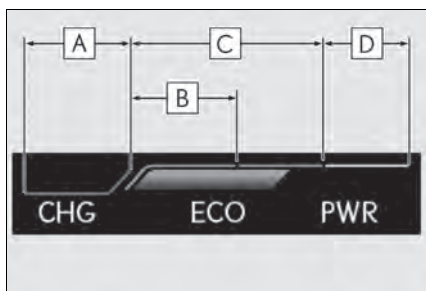

- A** Charge area
- B** Hybrid Eco area
- C** Eco area
- D** Power area

Displayed content is the same as that displayed on the meter (Hybrid System Indicator). For details, refer to P.12.

Tachometer

Displays the engine speed in revolutions per minute.

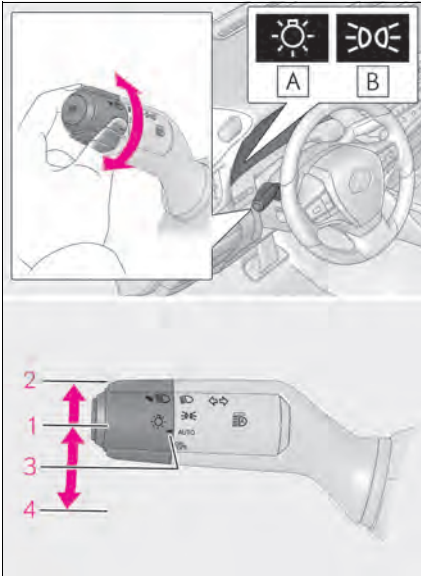

The head-up display may seem dark or hard to see when viewed through sunglasses, especially polarized sunglasses. Adjust the brightness of the head-up display or remove your sunglasses.

Headlights



A U.S.A.

B Canada

- 1**  The side marker, parking lights/daytime running lights, tail, license plate and instrument panel lights turn on.
- 2**  The headlights and all the lights listed above (except daytime running lights) turn on.
- 3** **AUTO** The headlights parking lights/daytime running lights and all the lights listed above turn on and off automatically.
- 4**  (U.S.A.) Off

Turning on the high beam headlights

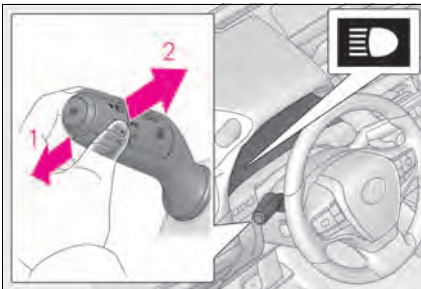

- 1** With the headlights on, push the lever away from you to turn on the high beams.
Pull the lever toward you to the center position to turn the high beams off.
- 2** Pull the lever toward you and release it to flash the high beams once.
You can flash the high beams with the headlights on or off.

AHB (Automatic High Beam)

The Automatic High Beam uses an in-vehicle front camera to assess the brightness of streetlights, the lights of vehicle ahead, etc., and automatically turns the high beam on or off as necessary.

Activating the Automatic High Beam system

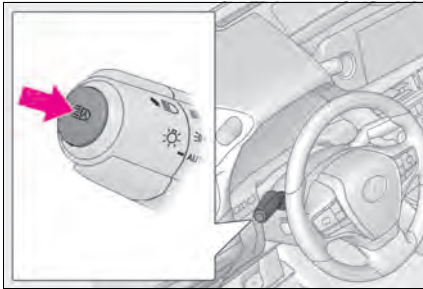

- 1 Press the Automatic High Beam switch.

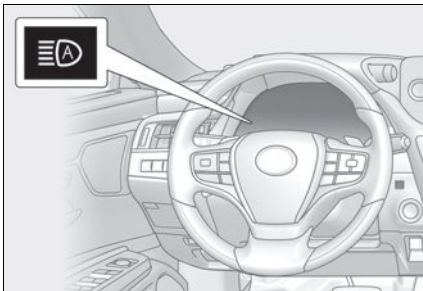

- 2 Turn the headlight switch to the  or AUTO position.

The Automatic High Beam indicator will come on when the system is operating.

Turning the high beam on/off manually

■ Switching to high beam

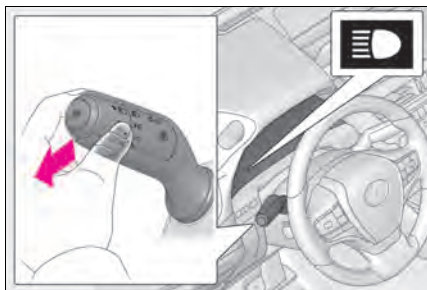

Push the lever away from you.

The Automatic High Beam indicator will turn off and the high beam indicator will turn on.

Pull the lever to its original position to activate the Automatic High Beam system again.

■ Switching to low beam

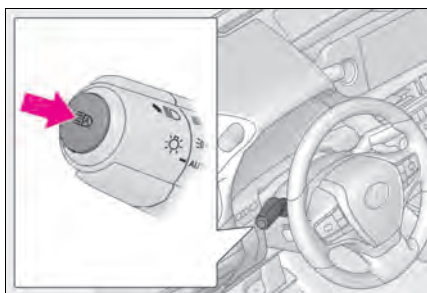

Press the Automatic High Beam switch.

The Automatic High Beam indicator will turn off.

Press the switch to activate the Automatic High Beam system again.

■ Temporarily switching to the low beams

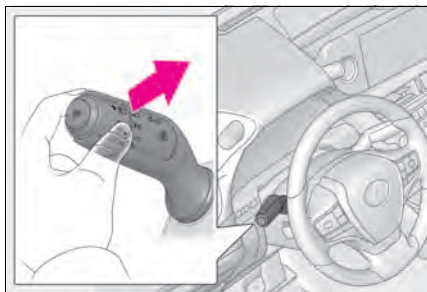





Pull the lever toward you and then return it to its original position.

The high beams are on while the lever is pulled toward you. However after the lever is returned to its original position, the low beams remain on for a certain amount of time. Afterwards, the Automatic High Beam will be activated again.

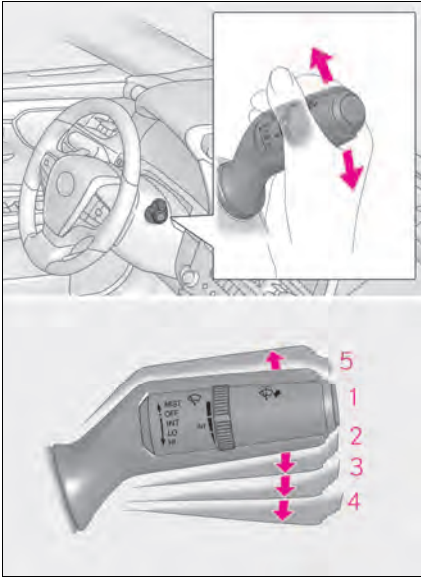
Windshield Wipers and Washer

► Intermittent windshield wipers with interval adjuster



- 1 OFF** *¹ or **○** *² Off
- 2 INT** *¹ or  *² Intermittent operation
The intermittent windshield wiper operates more frequently as vehicle speed becomes higher.
- 3 LO** *¹ or  *² Low speed operation
- 4 HI** *¹ or  *² High speed operation
- 5 MIST** *¹ or  *² Temporary operation

*¹: For the U.S.A.

*²: For Canada

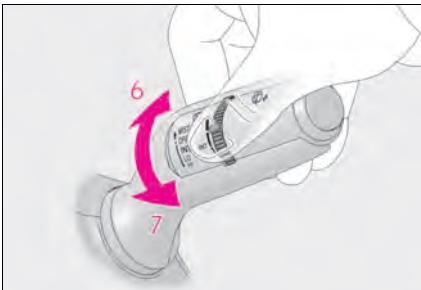

Wiper intervals can be adjusted when intermittent operation is selected.

- 6** Increases the intermittent windshield wiper frequency
- 7** Decreases the intermittent windshield wiper frequency



- 8**  Washer/wiper dual operation

Pulling the lever operates the wipers and washer.

The wipers will automatically operate a couple of times after the washer squirts.

(After operating several times, the wipers operate once more time after a short delay to prevent dripping. However, the dripping prevention does not operate while the vehicle is moving.)

► Rain-sensing windshield wipers

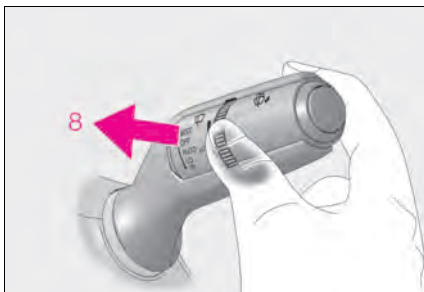
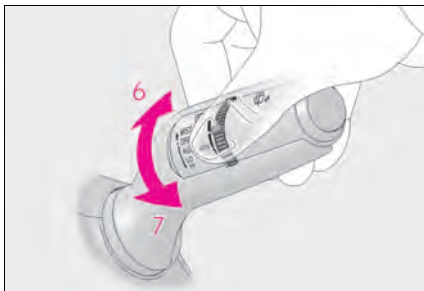
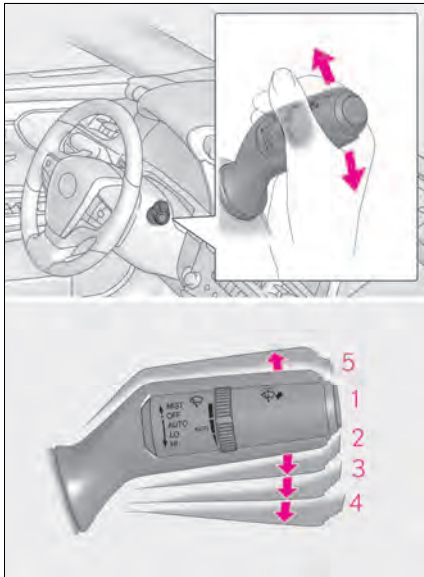

- 1 OFF *1 or ○ *2 Off
 - 2 AUTO Rain-sensing operation
 - 3 LO *1 or ▼ *2 Low speed operation
 - 4 HI *1 or ▼ *2 High speed operation
 - 5 MIST *1 or ▲ *2 Temporary operation
- *1: For the U.S.A.
*2: For Canada

When AUTO is selected, the sensor sensitivity can be adjusted by turning the switch ring.

- 6 Increases the sensitivity
- 7 Decreases the sensitivity

- 8  Washer/wiper dual operation
Pulling the lever operates the wipers and washer.
The wipers will automatically operate a couple of times after the washer squirts.
(After operating several times, the wipers operate once more time after a short delay to prevent dripping. However, the dripping prevention does not operate while the vehicle is moving.)

Energy Monitor/Consumption Screen





You can view the status of your hybrid system and fuel consumption information on the multi-information display and Center Display.

For details, refer to the "OWNER'S MANUAL".

Energy monitor

■ Display procedure

▶ Multi-information display

Press  or  of the meter control switches and select , and then press  or  to select the energy monitor display.

▶ Center Display

1 Select  on the main menu.

2 Select "Energy flow".

■ Reading the display

The arrows will appear in accordance with the energy flow. When there is no energy flow, arrows will not be displayed.

The color of the arrows will change as follows

Blue: When the hybrid battery (traction battery) is regenerated or charged.

Yellow^{*1}/Orange^{*2}: When the hybrid battery (traction battery) is in use.

Red: When the gasoline engine is in use.

*1: Multi-information display

*2: Center Display

► Multi-information display

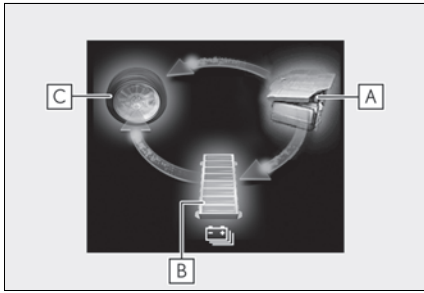

The image shows all the arrows as an example. The actual display will vary depending on conditions.

- A** Gasoline engine
- B** Hybrid battery (traction battery)
- C** Tire

► Center Display

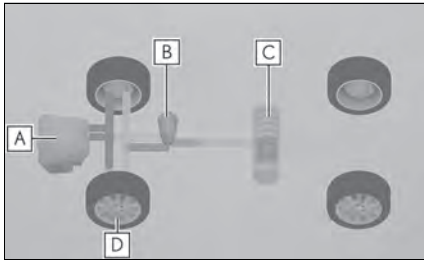

The image shows all the arrows as an example. The actual display will vary depending on conditions.

- A** Gasoline engine
- B** Electric motor (traction motor)
- C** Hybrid battery (traction battery)
- D** Tires

Current screen

Display procedure

- 1 Select  on the main menu.
- 2 Select "Trip information".
- 3 Select "Current".

Display

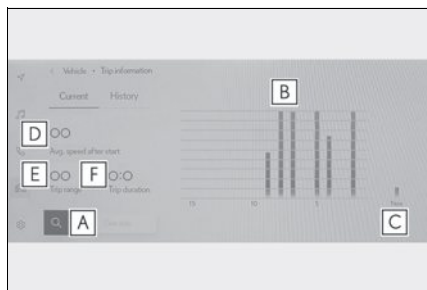

- A** Resetting the history data
- B** Fuel consumption in the past 15 minutes
- C** Current fuel consumption
- D** Average vehicle speed since the hybrid system was started.
- E** Trip range
- F** Elapsed time since the hybrid system was started.

History screen

Display procedure

- 1 Select  on the main menu.
- 2 Select "Trip information".
- 3 Select "History".

Display

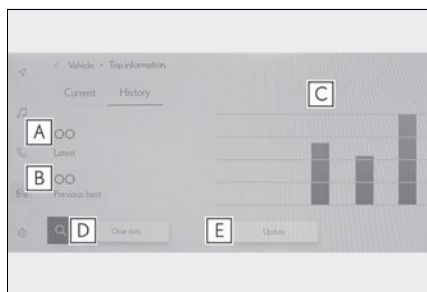

- A** Latest fuel consumption
- B** Best recorded fuel consumption
- C** Previous fuel consumption record
- D** Resetting the history data
- E** Updating the latest fuel consumption data

Basic Operation of Multimedia System

Map scrolling operation

The map can be moved and a touched point can be set as the center of the map screen.

■ Flick/drag operation



The map screen can be moved by touching, dragging or flicking it.

Touch [Recenter] to return to the center of the map to the current position.

■ Touch and hold operation

If a desired point on the map screen is touched and held, the full route map screen to the selected point will be displayed.



1 Touch and hold the desired point.

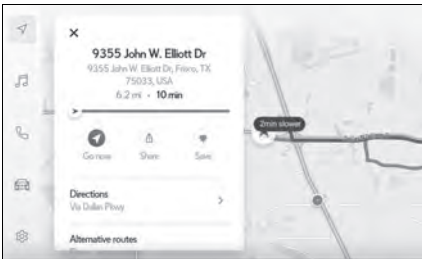

2 Full route map screen will be displayed for the selected point.

Navigation (if equipped)

The navigation system indicates your present position and assists in locating a desired destination.

Destination search screen

■ Searching for a destination using the keyboard

A destination can be searched for by entering keywords.

1 Touch [] or [] on the map screen.

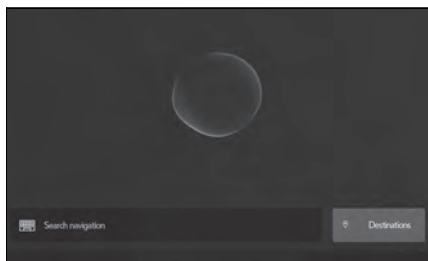

2 Touch [].

3 Select [Navigation].



4 Enter characters using the keyboard.

5 Touch [Go].

6 Touch the desired item from the list.

■ Searching for a destination by category

A destination can be searched for from a list of categories.

1 Touch [📍] or [🔍] on the map screen.

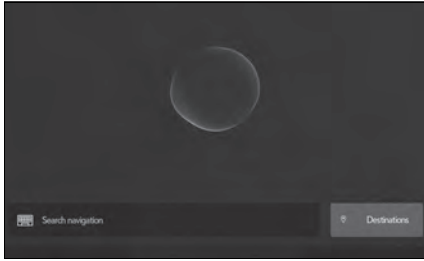

2 Touch [Destinations].

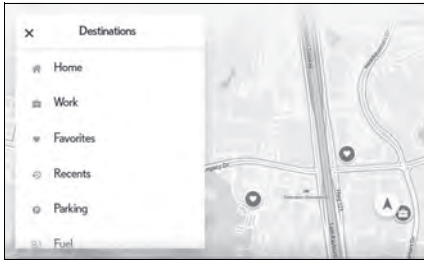

3 Touch the desired search method.

[Home]: Touch to set the registered home as the destination. A point must be registered as home before using this function.*

[Work]: Touch to set the registered workplace as the destination. A point must be registered as a workplace before using this function.*

[Favorites]: Touch to set a registered favorite as the destination. A point must be registered as a favorite before using this function.

[Recents]: Touch to set a destination from the destination history as the destination.

[Sent to car]: Sent to car enables customer to send a destination or POI to the vehicle from Lexus app.

[Parking]: Touch to search for a nearby parking lot to set as a destination.

[Fuel]: Touch to search for a fuel station to set as a destination.

[Food]: Touch to search for a restaurant to set as a destination.

[Hospitals]: Touch to search for a hospital to set as a destination.

When setting a business as a destination, if your estimated time of arrival is outside of business hours or near closing time, a notification asking to confirm the destination will be displayed.

*: Home and Work must be added via Lexus app.

4 Touch the desired destination from the list.

► **Editing the favorites list**

The favorites list can be edited.

1 Touch [📍] or [🔍] on the map screen.

2 Touch [Destinations].

3 Touch [Favorites].

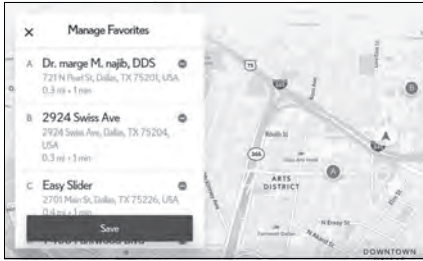

4 Touch [✎].

Touch [⊖] to delete a favorite.

The favorites list editing screen will be displayed.

5 Touch [Save].

► **Editing the destination history**

The destination history can be edited.

1 Touch [📍] or [🔍] on the map screen.

2 Touch [Destinations].

3 Touch [Recents].

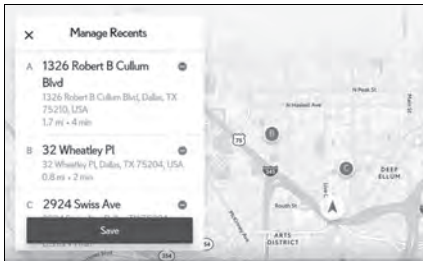

4 Touch [✎].

The destination history editing screen will be displayed.

Touch [⊖] to delete a destination history item.

5 Touch [Save].

■ Searching for a destination using voice controls

1 Touch [] or [] on the map screen.

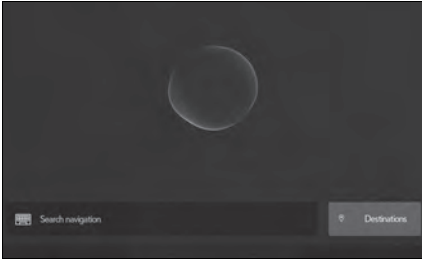

2 Say the keyword you wish to use for the search.

3 Touch or use voice command for desired result from list.

Connecting a Smartphone or Communication Device

Registering a Bluetooth® device from the multimedia system

A cellular phone or portable device must be registered in order to use hands-free calling or Bluetooth® audio. Once registration is complete, Bluetooth® will automatically be connected each time the multimedia system is started.

When Apple CarPlay or Android Auto is connected via USB, the device will be automatically registered.

If no Bluetooth® device is connected, the registration screen can also be displayed by pressing and holding the [] switch on the steering.

- 1 Touch [] from the main menu.
- 2 Touch [Bluetooth & Devices].
- If no device is registered, proceed to Procedure 4.
- 3 Touch [Add another device].
- While a device is connected to the multimedia system, the confirmation screen for disconnecting the device may be displayed. Disconnect the device to perform registration.

- 4 Touch [Search for devices].

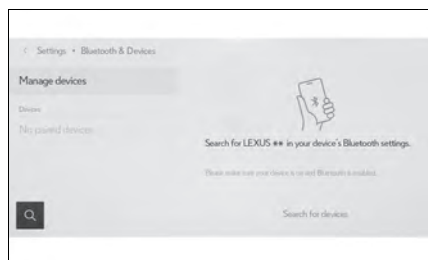

- 5 Touch the device to register from the main area.
- The Bluetooth® address may be displayed instead of the device name.
- Certain models of Bluetooth® devices may not be displayed in the device list, unless a certain screen is displayed on the Bluetooth® device. Refer to the Bluetooth® device's instruction manual for details.

- 6 Check that the displayed PIN code matches the PIN code displayed on the Bluetooth® device, and then touch [OK].
- Some Bluetooth® devices may need to be operated to complete registration.
 - You may be prompted to install the Lexus Application on your phone. Please follow the displayed instruction.
 - Primary device settings may be displayed. Perform the operation according to the screen guidance.
 - The Apple CarPlay or Android Auto settings may be displayed. The Apple CarPlay or Android Auto screen will be displayed if the use of either is enabled.
 - A message indicating that connection is complete is displayed, and the name of the registered Bluetooth® device is displayed in the sub menu.
 - If an operation failed screen is displayed, follow the operation instructions on the screen.

■ Registering from a Bluetooth® device

If the Bluetooth® device cannot be found by searching with the multimedia system, register by searching for the multimedia system from the Bluetooth® device.

- 1 Touch [⚙️] from the main menu.
 - 2 Touch [Bluetooth & Devices].
- If no device is registered, proceed to Procedure 4.
- 3 Touch [Add another device].
- While a device is connected to the multimedia system, the confirmation screen for disconnecting the device may be displayed. Disconnect the device to perform registration.



- 4 Register the multimedia system from the Bluetooth® device to be used.
- Perform the operation according to the operating procedure of the Bluetooth® device.
 - Be sure to display this Bluetooth® connection screen before performing registration on the Bluetooth® device.

5 Check that the displayed PIN code matches the PIN code displayed on the Bluetooth® device, and then touch [OK].

- Some Bluetooth® devices may need to be operated to complete registration.
- You may be prompted to install the Lexus Application on your phone. Please follow the displayed instruction.
- Primary device settings may be displayed. Perform the operation according to the screen guidance.
- The Apple CarPlay or Android Auto settings may be displayed. The Apple CarPlay or Android Auto screen will be displayed if the use of either is enabled.
- A message indicating that connection is complete is displayed, and the name of the registered Bluetooth® device is displayed in the sub menu.
- If an operation failed screen is displayed, follow the operation instructions on the screen.

■ Operating with the steering switches

Some hands-free call functions can be operated from the steering switches, such as receiving or making calls. The steering switch functions change depending on the status of the multimedia system.

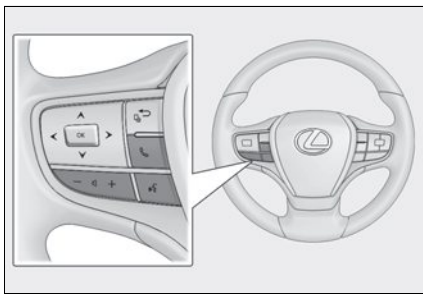

● Operate the switches as necessary.
[+] switch

Increases the ringtone volume or receiver volume.

Press and hold to adjust continuously.

[-] switch

Decreases the ringtone volume or receiver volume.

Press and hold to adjust continuously.

[] switch

Calls can be made using voice command.

To end Intelligent Assistant, press and hold the talk switch.

[] switch

- While a call cannot be made, displays call history screen or phone menu.
- Makes a call.
- While making a call or during a call, ends the call.
- While receiving a call or during call waiting, answers the call.

Making calls from call history

Calls can be made to phone numbers that have been recorded in the call history as outgoing or incoming calls.

- 1 Touch [] from the main menu.
- 2 Touch [Recents].

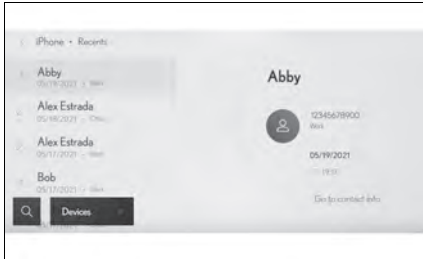

- 3 Select the contact.
 - For phone numbers that are not registered in the contact, the phone number will be displayed as it is.
- 4 Touch the desired phone number.

Making calls from the favorites list

Make a call from your favorites list.

- 1 Touch [] from the main menu.
- 2 Touch [Favorites].

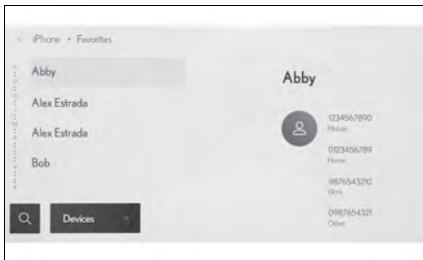

- 3 Select the person you want to call from your favorites list.
- 4 Touch the desired phone number.

Making calls from contacts

Make a call from the contacts registered on the multimedia system.

- 1 Touch [] from the main menu.
- 2 Touch [Contacts].
- 3 Select a contact.

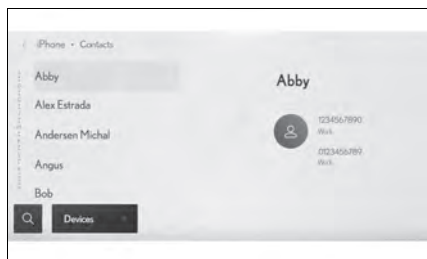



- 4 Touch the desired phone number.

Answering calls

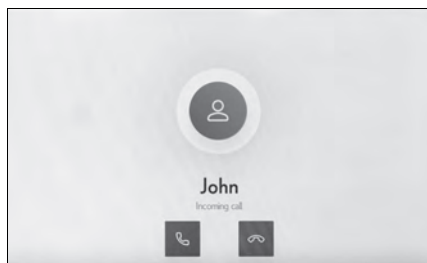
When there is an incoming call, the incoming call sounds and the incoming call screen or incoming call notification is displayed.



- 1 Answer the call by doing one of the following.
 - Touch [].
 - Press the [] switch on the steering.

Making calls from the message function

Hands-free calls can be made using the message function.

- 1 Touch the blue number to make a call.
- Consecutive numbers may be recognized as phone numbers. In addition, some phone numbers, such as phone numbers from other countries, may not be recognized.

Basic Operation of Audio System

Changing the audio source

Source can be changed to radio, USB, etc.

- 1 Touch [] from the main menu.
- 2 Touch [Sources].

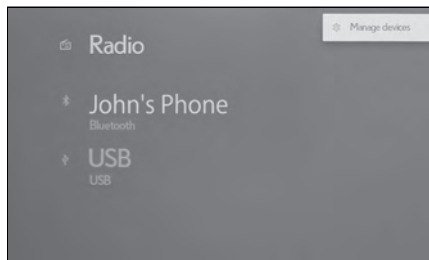

- 3 Touch the source you wish to select.

Listening to the radio

Switch to your preferred frequency or service and listen to the radio.

- 1 Touch [] from the main menu.
- 2 Touch [Sources].
- 3 Touch [Radio].
- 4 Select the station selection method or service as necessary.

[Favorites]: Select a broadcasting station from those registered as favorites.

[Tune]: Select the broadcasting station by entering a frequency with the numeric keypad.

[FM Radio]: Switches to FM mode. The FM station list, the 3 most recently listened stations, and the receivable FM broadcasting stations are displayed.

[AM Radio]: Switches to AM mode. The AM station list, the 3 most recently listened stations, and the receivable AM broadcasting stations are displayed.

[SiriusXM]: Switches to SiriusXM Radio mode. Displays [For You] and contents/Super Categories/[All channels]/[Listening History]. (This function is not made available in some countries or areas)

- 5 Select the broadcasting station from the station list or genre.

- 6 Operate the radio that is being received as necessary.
- Operating AM/FM from the screen



[Ch]: Touch [-] or [+] to search for the receivable broadcasting stations. Touch and hold to jump to the next frequency with available radio signal. When released, the broadcasting station closest to that position with the best reception sensitivity is selected automatically.

[Scan]: SEEK UP and output the audio of the detected station for 10 sec. This is repeated.

[ 1 2]: Displayed when Multicast CH is supported in FM mode. Touch to display the SPS channel list. The mode can be changed to the displayed SPS channel list.

[]: Registers the currently received broadcasting station in favorites. When registered, touch to cancel.

Preset buttons of sub menu: Receives the selected broadcasting station.

- Operating SiriusXM Radio from the screen
(This function is not made available in some countries or areas)

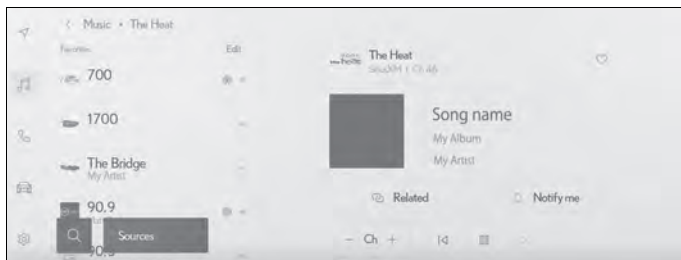

[Ch]: Touch [-] or [+] to search for the receivable channels. Touch and hold to switch channels. When released, the current channel is received.

[<|]/[>|]: Fast rewind or fast forward the radio cache. Touch and hold to jump to the start or end of the buffer.

[||]: Pause the radio cache.

[>]: Play the radio cache.

[Related]: Displays content related to the received channel.

[Notify me]: Select an artist or song, or both an artist and song, to receive a notification when the corresponding broadcast starts. (When receiving a regular channel) Select a sports team to receive a notification when the corresponding broadcast starts. (When receiving a sport channel)

[♥]: Registers the currently received channel in favorites. When registered, touch to cancel.

Preset buttons of sub menu: Receive the registered channels.

- Operating with the steering switches

[<]/[>] switches

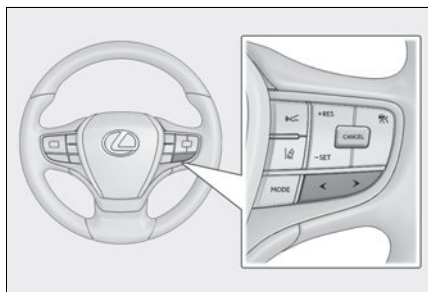

- AM/FM

Switch the frequencies or broadcasting stations registered in the preset buttons in order.

Press and hold to switch frequencies. When released, the broadcasting station closest to that position with the best reception sensitivity is selected automatically.

- SiriusXM Radio

Switch the channels registered in the preset buttons in order.

Press and hold to switch channels. When released, the channel closest to that position with the best reception sensitivity is selected automatically.

Playing iPod/iPhone

Play back music files on an iPod or iPhone connected to the USB port. When an iPod or iPhone is connected, a button with the device's name is displayed on the source selection screen. This may not be displayed for some devices.

Connect an iPod or iPhone.

- 1 Touch [] from the main menu.
 - 2 Touch [Sources].
 - 3 Touch the device name or [USB].
 - 4 Operate the iPod or iPhone that is playing as necessary.
- Perform operations from the screen

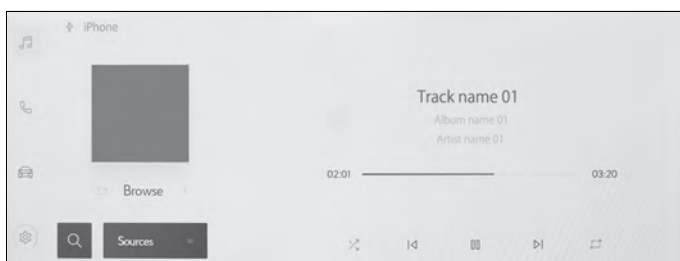

[]: Performs shuffle playback. Each touch switches the shuffle setting.*

[]: Plays the currently playing track from the beginning. When at the start of the track, the previous track will play from the beginning.

Touch and hold to fast rewind. Release to start playback from that position.

[]: Pauses playback.

[]: Plays.

[]: Switches the tracks. Touch and hold to fast forward. Release to start playback from that position.

[↺↻]: Performs repeat playback. Each touch switches the repeat setting.*

[Browse]: Displays the playback mode in the sub menu. Tracks can be selected from a list sorted by artist, album, song, playlist, genre, Podcast, composer, audiobook, or radio.

[Shuffle play] is displayed when playing a track selected from the list. Touch this to return to the playback screen and perform shuffle playback.

*: The order in which shuffle or repeat settings switch depends on the connected device.

● Operating with the steering switches

[<]/[>] switches

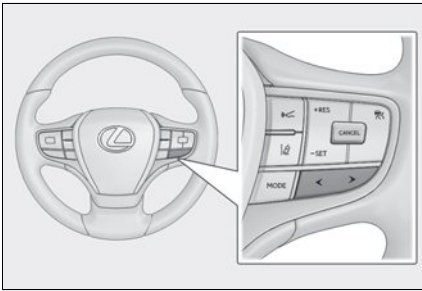

Switches the tracks.

Press and hold to fast forward or fast rewind. Release to start playback from that position.

Lexus Climate Concierge

The seat heaters (if equipped), seat ventilators (if equipped) and heated steering wheel (if equipped) are each automatically controlled according to the set temperature of the air conditioning system, the outside and cabin temperature, etc. Lexus Climate Concierge allows a comfortable condition to be maintained without adjusting each system.

Displaying the Lexus Climate Concierge

Lexus Climate Concierge can be operated using the air conditioning control screen on the Center Display (→P.62).

Turning on Lexus Climate Concierge

- 1 Select  in the main menu on the Center Display.
- 2 Select "Climate".
- 3 Select "Front".
- 4 Select "Climate concierge".

The indicator on the air conditioning control screen illuminates, and the automatic air conditioning system, seat heaters and ventilators, and heated steering wheel operate in automatic mode.

If any of the system is operated manually, the indicator turns off. However, all other functions continue to operate in automatic mode.

Automatic Air Conditioning System

The air conditioning system can be operated using the air conditioning control panel and air conditioning control screen on the Center Display (→P.62).

Air conditioning controls

Control panel



- A** Left-hand side temperature control switch
- B** Automatic mode switch
- C** Off switch
- D** Fan speed decrease switch
- E** Fan speed increase switch
- F** Airflow mode control switch
- G** Windshield defogger switch
- H** Rear window and outside rear view mirror defoggers switch
- I** Outside/recirculated air mode switch
- J** Right-hand side temperature control switch

Adjusting the temperature

Operate the temperature control switch upwards to increase the temperature and downwards to decrease the temperature.

If the "A/C" indicator is turned off, the system will blow ambient temperature air or heated air.

Setting the fan speed

Operate the fan speed increase switch to increase the fan speed and the fan speed decrease switch to decrease the fan speed.

Press the off switch to turn the fan off.

■ Changing the air flow mode

→P.62

Air conditioning control screen

■ Air conditioning control screen

- 1 Select  in the main menu on the Center Display.
- 2 Select “Climate”.
- 3 Select “Front”.

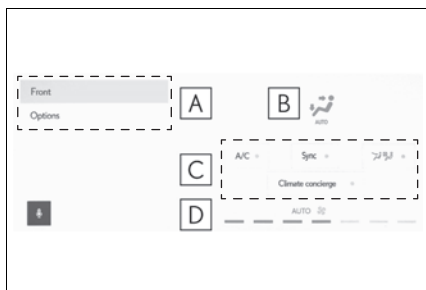

A Sub menu

Selecting the sub menu item to switch the screen display.

“Front”: Display the air conditioning control screen

“Options”: Display the option screen

B Select the air flow mode

Each time the switch is selected, the airflow mode is changed.

 : Air flows to the upper body

 : Air flows to the upper body and feet

 : Air flows to the feet

 : Air flows to the feet and the windshield defogger operates

C Turn the function on/off

Each of the following functions can be switched on and off.

When the function is on, the indicator illuminates on the control screen.

“A/C”: Set cooling and dehumidification function

“Sync”: Adjust the temperature for driver seat and front passenger seat simultaneously (“Sync” mode)

 : Select front seat concentrated air flow mode (S-FLOW)

“Climate concierge”: Set Lexus Climate Concierge (→P.60)

D Fan speed level display

The current fan speed level is displayed.

■ Option screen

- 1 Select "Options" on the air conditioning control screen (→P.62).

The functions can be switched  (on) and  (off).

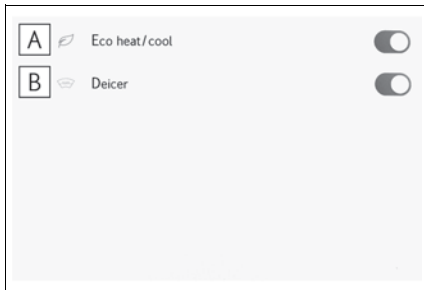

- A** Set eco air conditioning mode
Air conditioning and heater output is limited to prioritize fuel economy.
- B** Prevent ice from building up on the windshield and wiper blades (Windshield wiper de-icer) (if equipped)

Using automatic mode

- 1 Press the automatic mode switch.
- 2 Press the outside/recirculated air mode switch to switch to automatic air intake mode.
The air conditioning system automatically switches between outside air and recirculated air modes.
- 3 Adjust the temperature setting.
- 4 To stop the operation, press the off switch.

Starting Voice Control

Voice control can be started by any of the following operations:

■ Press the talk switch

- 1 Press the [] switch (talk switch) on the steering.

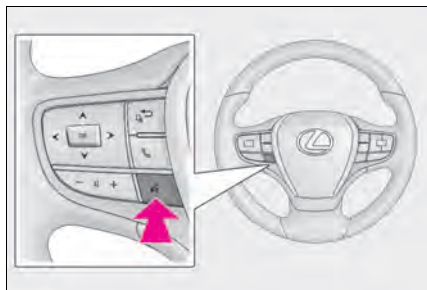

■ Say the wake word

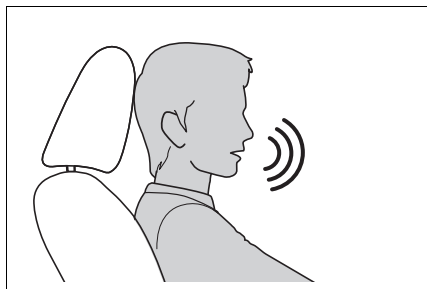

■ Touch the microphone button



- 1 Say "Hey Lexus".
 - The wake word can be turned on or off.
 - The wake word can be used and then immediately issue a voice command.
Example: "Hey Lexus" "Take me to an Italian restaurant."

- 1 Touch [] or [] on the screen.

Function list

The following tables list frequently used commands for each function category.

- The functions available may vary according to the system installed.
- Items with subscription will require Intelligent Assistant functionality.

■ Common

Action	Example voice command	Subscription
Shows list of general commands	"Help"	No
Stops the current conversation and re-starts at the beginning	"Start over"	No
Cancels the voice control system	"Cancel"	No

■ Navigation

Intelligent Assistant system enables navigation voice search. This allows you with variety of features such as searching a point of interest (POI), navigate to an address as well as discovering new POIs.

Function	Example voice command	Subscription
Destination search	"Take me to <location category/business name>" "Take me to <an Italian restaurant>" "Take me to <address>" "Take me to <6565 Headquarters drive Plano TX>" "Take me home" "Take me to work"	Yes
Map control	"Map zoom in" "Map zoom out"	Yes
Route information	"Cancel trip"	Yes
Telematics	"Call destination assist"	No

■ Multimedia control

Allows you to engage in a dialog with the Intelligent Assistant to complete various multimedia tasks via voice input.

Function	Example voice command	Subscription
Radio	"Tune to 99.5 FM" "Tune to Rock on FM" "Tune to channel 2 on SiriusXM"	No
Media	"Mute audio" "Next" "Previous"	No
Media Streaming	"Play <artist/album/song/genre/playlist>" "Play <Frank Sinatra>"	Yes

■ Hands-free phone operation

Allows you to engage in a dialog with the Intelligent Assistant to complete various tasks via voice input, such as making a phone call to a contact, or calling Destination Assist.

Function	Example voice command	Subscription
Phone call	"Call <John Smith>" "Dial <555 212 1212>" "Call back" "Redial"	No
Message	"Send message to <John Smith>" "Read message"	No

■ Screen display switching

Allows you to easily change to various function screen by voice.

Function	Example voice command	Subscription
Navigation	"Show map"	Yes
Phone	"Show recent calls"	No
Multimedia	"Show the FM station list"	No
Settings	"Show display settings"	No

■ Vehicle device control

Allows you to easily change a vehicle setting or activate a function by voice.

Function	Example voice command	Subscription
Climate	"Turn on the air conditioner" "Set the temperature to <70> degrees" "Turn the fan speed up"	No

■ Notifications

Offers notifications based on user preferences, vehicle geolocation and learned behavior. Each service can be set to On/Off from the Lexus app.

Function	Detail	Subscription
POI suggestion (Navigation)	Parking suggestions near destination	Yes
Low fuel reminder (Navigation)	Automatically notifies user of low fuel level. If applicable, provides POI list nearby (ahead) or along route and allows user to select and navigate by touch.	Yes

Connecting to the USB Port

Connect a device such as smartphone or portable player.

- 1 Slide the lid.



- 2 Connect a device.



When connecting a USB flash drive, connect it directly to the USB port.

Garage Door Opener

The garage door opener can be programmed using the HomeLink[®] to operate garage doors, gates, entry doors, door locks, home lighting systems, security systems, and other devices.

System components

The HomeLink[®] wireless control system in your vehicle has 3 buttons which can be programmed to operate 3 different devices. Refer to the programming methods on the following pages to determine the method which is appropriate for the device.

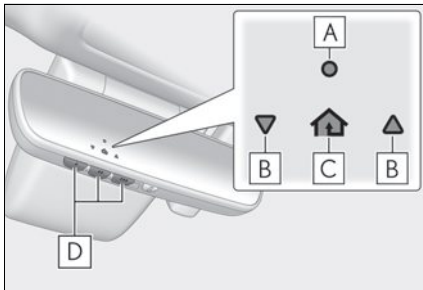

- A** HomeLink[®] indicator light
- B** Garage door operation indicators
- C** HomeLink[®] icon

Illuminates while HomeLink[®] is operating.

- D** Buttons

■ Before programming HomeLink[®]

- During programming, it is possible that garage doors, gates, or other devices may operate. For this reason, make sure that people and objects are clear of the garage door or other devices to prevent injury or other potential harm.
- It is recommended that a new battery be placed in the remote control transmitter for more accurate programming.
- Garage door opener motors manufactured after 1995 may be equipped with rolling code protection. If this is the case, you may need a stepladder or other sturdy, safe device to reach the “Learn” or “Smart” button on the garage door opener motor.

■ HomeLink® programming procedure

The programming procedures can also be found at the following URL.

Website: www.homelink.com/lexus



The word “QR Code” is registered trademark of DENSO WAVE INCORPORATED in Japan and other countries.

For support, contact customer support at the following.

Help Line: 1-800-355-3515

■ Programming HomeLink®

Steps **1** through **3** must be performed within 60 seconds, otherwise the indicator light will stop flashing and programming will not be able to be completed.

- 1** Press and release the HomeLink® button you want to program and check that the HomeLink® indicator light flashes (orange).

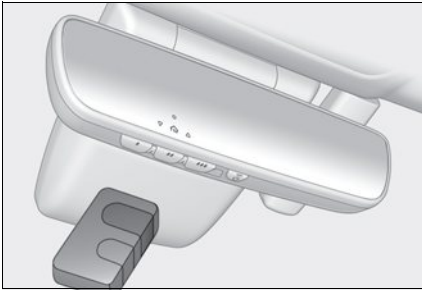

- 2** Point the remote control transmitter for the device at the rear view mirror, 1 to 3 in. (25 to 75 mm) from the HomeLink® buttons.

Keep the HomeLink® indicator light in view while programming.

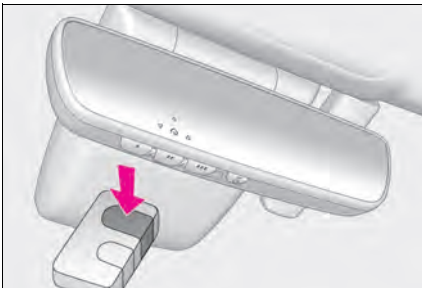

- 3** Program a device.

► **Programming a device other than an entry gate (for U.S.A. owners)**

Press and hold the remote control transmitter button until the HomeLink[®] indicator light changes from slowly flashing orange to rapidly flashing green (rolling code) or continuously lit green (fixed code), then release the button.

► **Programming an entry gate (for U.S.A. owners)/Programming a device in the Canadian market**

Press and release the remote control transmitter button at 2 second intervals, repeatedly, until the HomeLink[®] indicator light changes from slowly flashing (orange) to rapidly flashing (green) (rolling code) or continuously lit (green) (fixed code).

- 4 Test the HomeLink[®] operation by pressing the newly programmed button and observing the indicator light:
 - Indicator light illuminates: Programming of a fixed code device has completed. The garage door or other device should operate when a HomeLink[®] button is pressed and released.
 - Indicator light flashes rapidly: The garage door opener motor or other device is equipped with a rolling code. To complete programming, firmly press and hold the HomeLink[®] button for 2 seconds then release it.
 - If the garage door or other device does not operate, proceed to “Programming a rolling code system”.
- 5 Repeat the steps above to program another device for any of the remaining HomeLink[®] buttons.

■ Programming a rolling code system

2 or more people may be necessary to complete rolling code programming.

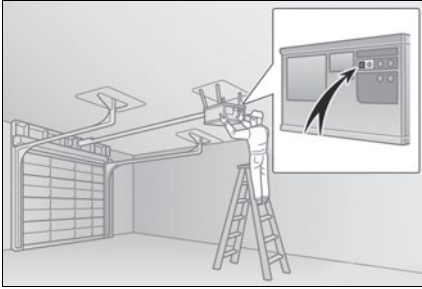

- 1** Locate the “Learn” or “Smart” button on the garage door opener motor in the garage.

This button can usually be found where the hanging antenna wire is attached to the unit. The name and color of the button may vary by manufacturer. Refer to the owner’s manual supplied with the garage door opener motor for details.

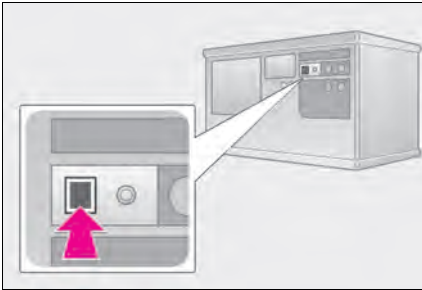

- 2** Press and release the “Learn” or “Smart” button. Perform **3** within 30 seconds after performing **2**.



- 3** Press and hold the desired HomeLink[®] button (inside the vehicle) for 2 seconds and release it. Repeat this sequence (press/hold/release) up to 3 times to complete programming. If the garage door opener motor operates when the HomeLink[®] button is pressed, the garage door opener motor recognizes the HomeLink[®] signal.

■ Enabling 2-way communication with a garage door (only available for compatible devices)

When enabled, 2-way communication allows you to check the status of the opening and closing of a garage door through indicators in your vehicle.

2-way communication is only available if the garage door opener motor used is a compatible device. (To check device compatibility, refer to www.homelink.com.)

- 1 Within 5 seconds after programming the garage door opener has been completed, if the garage door opener motor is trained to HomeLink[®], both garage door operation indicators will flash rapidly (green) and the light on the garage door opener motor will blink twice, indicating that 2-way communication is enabled.

If the indicators do not flash, perform **2** and **3** within the first 10 presses of the HomeLink[®] button after programming has been completed.

- 2 Press a programmed HomeLink[®] button to operate a garage door.
- 3 Within 1 minute of pressing the HomeLink[®] button, after the garage door operation has stopped, press the “Learn” or “Smart” button on the garage door opener motor. Within 5 seconds of the establishment of 2-way communication with the garage door opener, both garage door operation indicators in the vehicle will flash rapidly (green) and the light on the garage door opener motor will blink twice, indicating that 2-way communication is enabled.

■ Reprogramming a single HomeLink[®] button

When the following procedure is performed, buttons which already have devices registered to them can be overwritten:

- 1 With one hand, press and hold the desired HomeLink[®] button.
- 2 When the HomeLink[®] indicator starts flashing (orange), continue to hold the HomeLink[®] button and perform “Programming HomeLink[®]” **1** (it takes 20 seconds for the HomeLink[®] indicator to start flashing).

Operating HomeLink[®]

Press the appropriate HomeLink[®] button. The HomeLink[®] indicator light should turn on.

Safety Connect

Safety Connect is a subscription-based telematics service that uses Global Positioning System (GPS) data and embedded cellular technology to provide safety and security features to subscribers. Safety Connect is supported by Lexus' designated response center, which operates 24 hours per day, 7 days per week.

Safety Connect service is available by subscription on select, telematics hardware-equipped vehicles.

System components

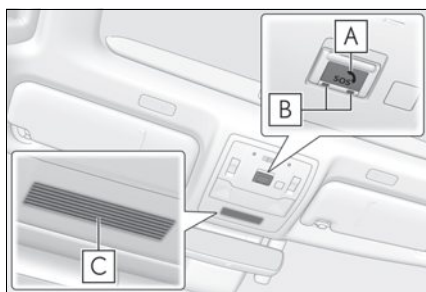

- A** "SOS" button
- B** LED light indicators
- C** Microphone

Services

Subscribers have the following Safety Connect services available:

- **Automatic Collision Notification**

In case of either airbag deployment or severe rear-end collision, the system is designed to automatically call the response center. The responding agent receives the vehicle's location and attempts to speak with the vehicle occupants to assess the level of emergency. If the occupants are unable to communicate, the agent automatically treats the call as an emergency, contacts the nearest emergency services provider to describe the situation, and requests that assistance be sent to the location.

- **Stolen Vehicle Location**

If your vehicle is stolen, Safety Connect can work with local authorities to assist them in locating and recovering the vehicle. After filing a police report, call the Safety Connect response center at 1-800-25-LEXUS (1-800-255-3987) in the United States, 1-877-539-8777 in Puerto Rico or 1-800-265-3987 in Canada, and follow the prompts for Safety Connect to initiate this service.

In addition to assisting law enforcement with recovery of a stolen vehicle, Safety-Connect-equipped vehicle location data may, under certain circumstances, be shared with third parties to locate your vehicle. Further information is available at Lexus.com.

- **Emergency Assistance Button (“SOS”)**

In the event of an emergency on the road, push the “SOS” button to reach the Safety Connect response center. The answering agent will determine your vehicle’s location, assess the emergency, and dispatch the necessary assistance required.

If you accidentally press the “SOS” button, tell the response-center agent that you are not experiencing an emergency.

- **Enhanced Roadside Assistance**

Enhanced Roadside Assistance adds GPS data to the already included warranty-based Lexus roadside service.

Subscribers can press the “SOS” button to reach a Safety Connect response-center agent, who can help with a wide range of needs, such as: towing, flat tire, fuel delivery, etc. For a description of the Roadside Assistance services and their limitations, please see the Safety Connect Terms and Conditions, which are available at Lexus.com.

Subscription

After you have signed the Telematics Subscription Service Agreement and are enrolled, you can begin receiving services.

A variety of subscription terms is available for purchase. Contact your Lexus dealer, call the following or push the “SOS” button in your vehicle for further subscription details.

- **The United States**

1-800-25-LEXUS (1-800-255-3987)

- **Canada**

1-800-26-LEXUS (1-800-265-3987)

- **Puerto Rico**

1-877-539-8777

Remote Connect (if equipped)

The functionality of Remote Connect and Service Connect are made possible by the use of a DCM and a smartphone.

For details about these services, refer to <https://www.lexus.com>.

Remote Connect subscription

Remote Connect is a smartphone application that lets you view and remotely control certain aspects of your vehicle.

Service Connect (if equipped)

Service Connect uses DCM to collect and transmit vehicle data that allows Lexus to provide:

- Vehicle Health Report (VHR) (Safety Recalls, Service Campaigns, Current Vehicle Alerts, Required Maintenance, and Vehicle Condition Status)
- Maintenance Notifications
- Vehicle Alert Notifications

Door Locks

The vehicle can be locked and unlocked using the entry function, wireless remote control or door lock switches.

For details about the entry function or wireless remote control, refer to P.16, 17.

Unlocking and locking the doors from the inside

■ Door lock switches (to lock/unlock)

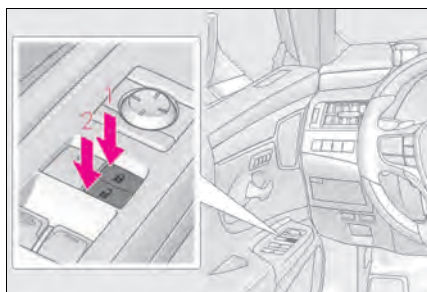

- 1 Locks all the doors
- 2 Unlocks all the doors

■ Inside lock buttons (to lock)

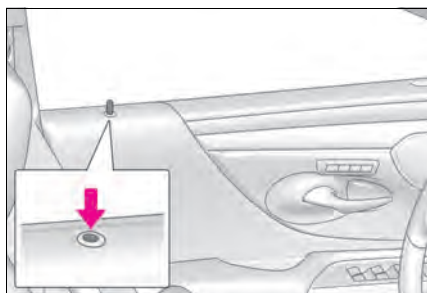

Push down the inside lock button to lock the door.

■ Inside door handles (to unlock)

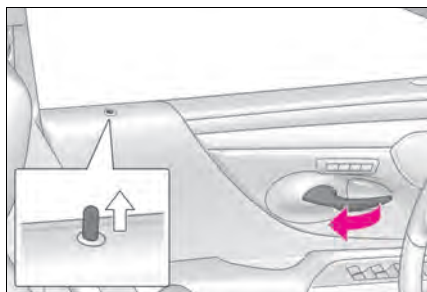

► For the front doors

Pull the handle to unlock and open the door.

When the door is unlocked, the inside lock button will pop up.

► For the rear doors

Pull the handle to unlock the door. Pull the handle a second time to open the door.

When the door is unlocked, the inside lock button will pop up.

Fuel Tank Cap

The fuel tank of your vehicle has a special structure, which requires a reduction in fuel tank pressure before refueling. After the opener switch has been pressed, it will take several seconds until the vehicle is ready for refueling.

Before refueling the vehicle

- Close all the doors and windows, and turn the power switch off.
- Confirm the type of fuel.

Opening the fuel tank cap

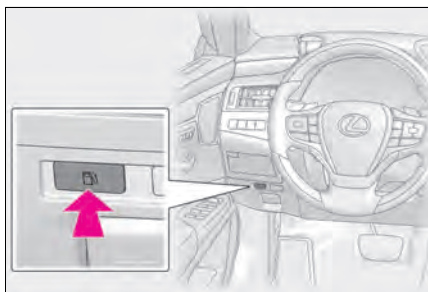

- 1 Press the opener switch.

The fuel filler door will open within about 10 seconds of the switch being pressed.

Before refueling is possible, a message will be shown on the multi-information display in the instrument cluster to indicate the progress of the fuel filler door opener.

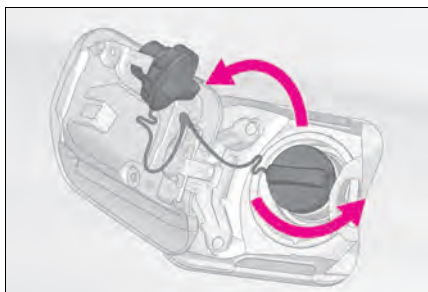

- 2 Turn the fuel tank cap slowly and remove it, then hang it on the back of the fuel filler door.

Closing the fuel tank cap

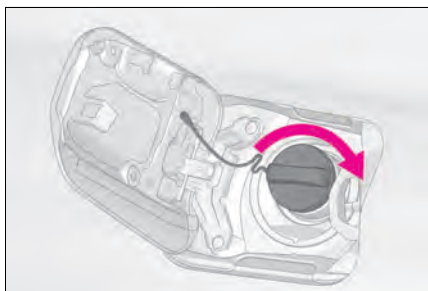

After refueling, turn the fuel tank cap until you hear a click. Once the cap is released, it will turn slightly in the opposite direction.

What to do if...

List of Warning/Indicator Lights

Immediately stop the vehicle in a safe place and contact your Lexus dealer. Continuing to drive the vehicle may be dangerous.

BRAKE

(U.S.A.)

Brake system warning light



(Canada)

(Red)

Immediately stop the vehicle in a safe place and contact your Lexus dealer.



Charging system warning light



(U.S.A.)

Malfunction
indicator lamp



Low engine oil pressure warning light



(Canada)

Have the vehicle inspected by your Lexus dealer immediately.



SRS warning light

HOLD

Brake hold operated indicator

(Flashes)

ABS

(U.S.A.)

ABS warning light

PARK

(U.S.A.)

Parking brake
indicator

(Flashes)



(Canada)



(Canada)

(Flashes)



Electric power steering
system warning light

(Red or
yellow)



Brake system warning light

(Yellow)



PCS warning light

(Flashes or
illuminates)



RCTA OFF indicator

(Flashes)



Slip indicator



RCD OFF indicator (if
equipped)

(Flashes or
illuminates)



Intuitive parking assist OFF
indicator (if equipped)

(Flashes)



PKSB OFF indicator (if
equipped)

(Flashes)

For further information, refer to the "OWNER'S MANUAL".

What to do if...

Follow the correction procedures.



Inappropriate pedal operation warning light



Rear passengers' seat belt reminder lights



Tire pressure warning light

(Blinking and then continuously on)



Master warning light



LTA indicator

(Orange)



Low fuel level warning light



Tire pressure warning light*

(Illuminates without blinking)



Driver's and front passenger's seat belt reminder light

Stop and check.



High coolant temperature warning light































Hybrid system overheat warning light

For further information, refer to the "OWNER'S MANUAL".

What to do if...

See the "OWNER'S MANUAL"

	Turn signal indicator		Intuitive parking assist OFF indicator (if equipped)
	Headlight indicator (U.S.A.)		RCTA OFF indicator
	Tail light indicator (Canada)		RCD OFF indicator (if equipped)
	Headlight high beam indicator		PKSB OFF indicator (if equipped)
	Automatic High Beam indicator		Brake hold standby indicator
	Cruise control indicator		Brake hold operated indicator
	Dynamic radar cruise control indicator		Smart access system with push-button start indicator
	Cruise control "SET" indicator		"READY" indicator
	LTA indicator (White or green)		Low outside temperature indicator
	LTA indicator (Flashes in orange)		AGC indicator
	Slip indicator (Flashes)		EV drive mode indicator
	VSC OFF indicator		EV indicator
	PCS warning light		(U.S.A.) Parking brake indicator
	BSM outside rear view mirror indicators		(Canada)
	BSM indicator		

For further information, refer to the "OWNER'S MANUAL".

What to do if...

See the "OWNER'S MANUAL"



"PASSENGER AIR BAG" indicator lights



Traction battery status indicator (if equipped)

● Drive mode indicators

▶ Except F SPORT models



Eco drive mode indicator



Sport mode indicator

▶ F SPORT models



Custom mode indicator (if equipped)



Eco drive mode indicator



Sport mode indicator (if equipped)



Sport S mode indicator (if equipped)



Sport S+ mode indicator (if equipped)

For further information, refer to the "OWNER'S MANUAL".

*: It also comes on due to natural causes such as natural air leaks and tire inflation pressure changes caused by temperature. Adjust the tire inflation pressure to the specified level. The light will turn off after a few minutes. In case the light does not turn off even if the tire inflation pressure is adjusted, have the system checked by your Lexus dealer.

What to do if...

If the electronic key does not operate properly

Locking and unlocking the door

■ Unlocking the door

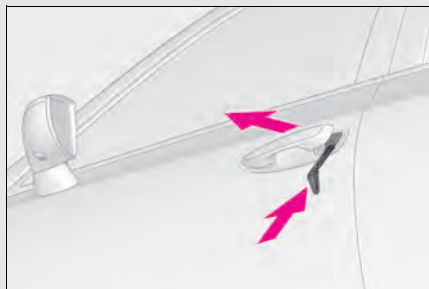

- 1 Pull the driver's door handle and insert the mechanical key.

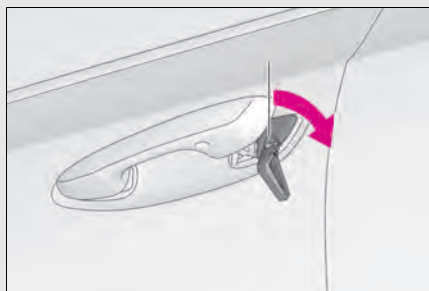

- 2 Unlock the door.

- 3 Remove the key, return the handle, and then pull the handle again.

■ Locking the door

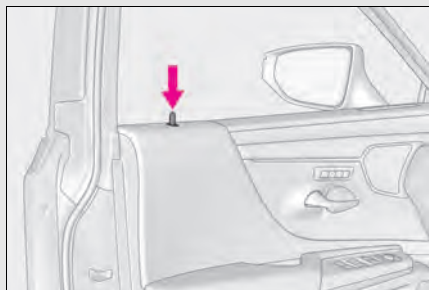

- 1 With the door open, push down the inside lock button.

- 2 Close the door.

What to do if...

Opening the trunk

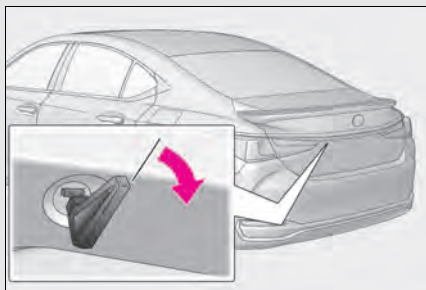

Turn the mechanical key clockwise to open.

Starting the hybrid system

- 1 Ensure that the shift lever is in P and depress the brake pedal.

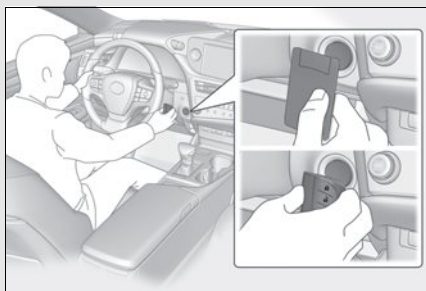

- 2 Touch the Lexus emblem side of the electronic key to the power switch.

When the electronic key is detected, a buzzer sounds and the power switch will turn to ON mode.

When the smart access system with pushbutton start is deactivated in customization setting, the power switch will turn to ACCESSORY mode.

- 3 Firmly depress the brake pedal and check that  is shown on the multi-information display.
- 4 Press the power switch shortly and firmly.

In the event that the hybrid system still cannot be started, contact your Lexus dealer.

If the electronic key battery becomes depleted, a warning message will be shown on the multi-information display. Replace the battery with a new one. For instructions on replacing the battery, refer to the "OWNER'S MANUAL".

If you need further assistance, contact your Lexus dealer.

What to do if...

If the hybrid system will not start

Make sure that the correct operating procedures have been followed.

Brake pedal

Make sure that the brake pedal is firmly depressed when attempting to start the hybrid system. (→P.20)

If the hybrid system still does not start, see the “OWNER’S MANUAL” for more information or contact your Lexus dealer.

Memo

A large white rectangular area with horizontal ruling lines, intended for writing a memo. The lines are evenly spaced and extend across the width of the page.

Memo

A large rectangular area with horizontal ruling lines, intended for writing a memo. The lines are evenly spaced and extend across the width of the page.



Your Lexus dealer

Your Lexus dealer will provide quality maintenance and any other assistance you may require.

If there is not a Lexus dealer near you, please call the following number:

■ U.S. OWNERS

- In the U.S. mainland or Canada:

Lexus Roadside Assistance

1-800-25-LEXUS or 1-800-255-3987 (Toll-Free)

- In Hawaii:

Servco Automotive Roadside Assistance/Customer Services

1-800-25-LEXUS or 1-800-255-3987 (Toll-Free)

■ CANADIAN OWNERS

- In Canada or the U.S. mainland:

Lexus Roadside Assistance/Customer Service

1-800-26-LEXUS or 1-800-265-3987 (Toll-Free)

Please access our **websites** for further information.

- The U.S. mainland: **www.lexus.com**

- Hawaii: **www.servcolexus.com**

- Canada: **www.lexus.ca**

©2023 TOYOTA MOTOR CORPORATION

All rights reserved. This material may not be reproduced or copied, in whole or in part, without the written permission of Toyota Motor Corporation.



Owner's Manual Quick Guide:
Publication No. OM06289U
Part No. 01999-06289
Printed in the U.S.A. 01-2307-00